

**Features**

- Size Design 8.3×8.3×6mm
- High Current Handling Capability 20,000A @ 8/20μs
- Low Capacitance and Insertion Loss
- Fast Response and Long Service Life
- Reliable to Protect Electrostatic Surge
- Moisture sensitivity level: Level 1

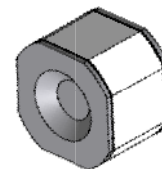

**Exterior**

SMD

**Application information**

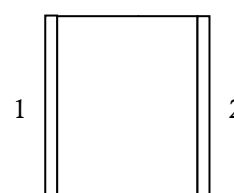
- DC Power

**Package (Top View)**

**Agency Approvals**

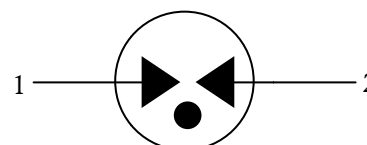
Icon	Description
<b>RoHS</b>	Compliance with 2011/65/EU
<b>HF</b>	Compliance with IEC61249-2-21:2003
	Mean lead free
	Compliance with UL1449, Certificated E337906

**Schematic Symbol**

**Electrical Parameter**

DC Breakdown Voltage <sup>1) 2)</sup>	100V/s	280-420	V
Impulse Spark-over Voltage	At 1kV/μs	for 99 % of measured values	≤ 650
	At 1kV/μs	Typical values of distribution	≤ 600
Impulse Discharge Current <sup>3)</sup>	8/20μs ±5times	20,000	A
Arc Voltage	At 1A	~15	V
Insulation Resistance	DC=100V	≥1	GΩ
Capacitance at 1 MHz	V <sub>DC</sub> =0.5V	≤1.5	pF
Weight		~1.75	g
Operating and storage Temperature		-40-90	°C
Marking		Without	

1) At delivery AQL 0.65 level II GB/T 2828.1-2003

2) In ionized mode

3) Terms and current waveforms in accordance with ITU-T Rec. K. 12; IEC 61643-21

**Part Numbering System**

BM 351 M  
(1) (2) (3)

- (1) Bencent SMD Gas Discharge Tube with 8.3×8.3×6 (L×W×H) (mm) dimension  
 (2) DC Breakdown Voltage, e.g., 351=35×10<sup>1</sup>=350V  
 (3) Tolerance is DC Breakdown Voltage, M=±20%, N=±30%

**Product Characteristics**

Lead Material	Copper
Body Material	Ceramics
Terminal Finish	100% Matte-Tin Plated

**Environmental Reliability Characteristics**

Testing items	Technical standards
High Temperature Storage Test	Temperature: 85°C Time: 2H
Low Temperature Storage Test	Temperature: -40°C Time: 2H
Vibration	Frequency: 10-500Hz Amplitude: 0.15mm Time: 45mins
Resistance of soldering heat	Temperature: 260±5°C Time of dip soldering: 10s, 1time

Note: Up-screen program can be specified by customer's request via contacting Bencent service

**Solderability test**

Solderability	Solder Pot Temperature:	245°C ± 5°C
	Solder Dwell Time:	4-6 seconds

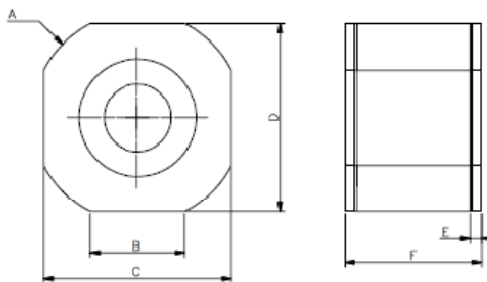
**Product Dimensions**

REF	mm	inch
A	Φ9.3±0.1	Φ0.366±0.004
B	4.2±0.1	0.165±0.004
C	8.3±0.2	0.327±0.008
D	8.3±0.2	0.327±0.008
E	0.5±0.05	0.02±0.002
F	6±0.2	0.236±0.008

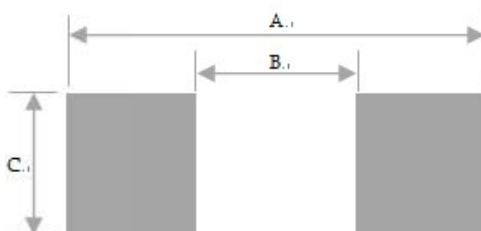
**Recommended soldering pad**

REF	mm	inch
A	7.95	0.313
B	4.5	0.177
C	8	0.315

## reflow profile

Reflow Condition		Pb-Free assembly
Pre Heat	Temperature Min	150°C
	Temperature Max	200°C
	Time (min to max)	60 – 180 secs
Average ramp up rate (Liquids) T <sub>amp</sub> (T <sub>L</sub> ) to peak		3°C/second max
T <sub>S</sub> (max) to T <sub>L</sub> - Ramp-up Rate		3°C/second max
Reflow	- Temperature (T <sub>L</sub> ) (Liquids)	217°C
	- Temperature (T <sub>L</sub> )	60 – 150 seconds
Peak Temperature (T <sub>p</sub> )		260+0/-5 °C
Time within 5°C of actual peak Temperature (t <sub>p</sub> )		20 – 40 seconds
Ramp-down Rate		6°C/second max
Time 25°C to peak Temperature (T <sub>p</sub> )		8 minutes Max.
Do not exceed		260°C

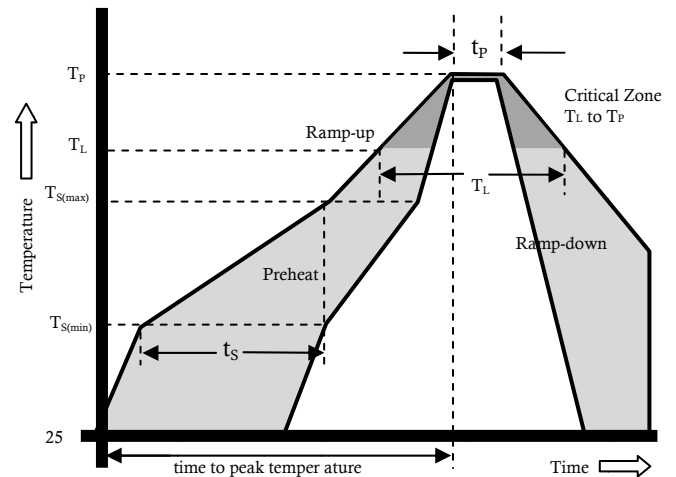

## Package Reel Information

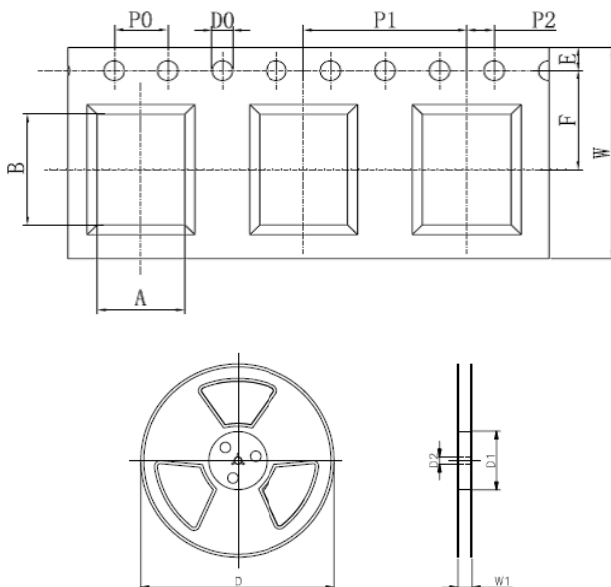

REF	mm	inch
P0	4.0±0.1	0.157±0.004
D0	Φ1.5 <sup>+0.1</sup> <sub>-0</sub>	Φ0.059 <sup>+0.004</sup> <sub>-0</sub>
P1	12±0.1	0.472±0.004
P2	2.0±0.1	0.079±0.004
A	6.5±0.2	0.256±0.008
B	8.4±0.2	0.331±0.008
F	7.5±0.1	0.295±0.004
E	1.75±0.1	0.069±0.004
W	16±0.3	0.63±0.012
D	Φ330±2	Φ12.99±0.079
D1	Φ100±2	Φ3.94±0.079
D2	Φ13±0.15	0.512±0.006
W1	21±2	0.827±0.079

OUTLINE	REEL (PCS)	INSIDE CARTON (PCS)	PER CARTON (PCS)	CARTON SIZE(mm)		
				L	W	H
TAPING	500	1000	8000	360	360	380