

用于射频功率放大器的 LM3241 6MHz 750mA 微型可调节降压直流/直流转换器

1 特性

- 6MHz (典型值) PWM 开关频率
- 由单节锂离子电池供电运行 (2.7V 至 5.5V)
- 可调节输出电压 (0.6V 至 3.4V)
- 750mA 最大负载能力
- 高效 (95%, 这个值是 500mA 时, 3.9V_{输入}, 3.3V_{输出} 上的典型值)
- 自动 Eco-mode™ 和 PWM 模式切换
- 6 凸点芯片级球状引脚栅格阵列 (DSBGA) 封装
- 电流过载保护
- 热过载保护
- 软启动功能
- C_{IN} 和 C_{OUT} 均指外壳尺寸为 0402 (1005) 和额定电压为 6.3V 的陶瓷电容器
- 小型片式电感, 外壳尺寸为 0805 (2012)

2 应用

- 电池供电型 3G 和 4G 功率放大器
- 手持无线电设备
- RF PC 卡
- 电池供电类 RF 器件

3 说明

LM3241 是一款直流/直流转换器, 此转换器经过优化可由单节锂离子电池为射频功率放大器 (PA) 供电。该器件还可用于许多其他应用。该器件可将 2.7V 至 5.5V 输入电压降低至 0.6V 至 3.4V 可调节输出电压。此输出电压通过 VCON 模拟输入进行设定, 便于控制射频功率放大器的功率级和效率。

LM3241 提供 3 个运行模式。在 PWM 模式下, 该器件以 6MHz (典型值) 固定频率运行, 因此可在驱动中等到重负载时最大限度地抑制射频干扰。在轻负载条件下, 器件自动进入 Eco-mode 模式并以较低的开关频率运行。在 Eco-mode 模式下, 静态电流降低, 延长了电池使用寿命。该器件在关断模式下处于关闭状态, 电池流耗降至 0.1μA (典型值)。

LM3241 采用 6 焊锡凸点无引线芯片级球栅阵列 (DSBGA) 封装。高开关频率 (6MHz) 便于使用小型表面贴装式组件。仅需 3 个小型的外部表面贴装式组件, 其中包括 1 个电感器和 2 个陶瓷电容器。

器件信息⁽¹⁾

器件型号	封装	封装尺寸 (标称值)
LM3241	DSBGA (6)	1.50mm × 1.30mm

(1) 如需了解所有可用封装, 请参阅数据表末尾的可订购产品附录。

典型应用

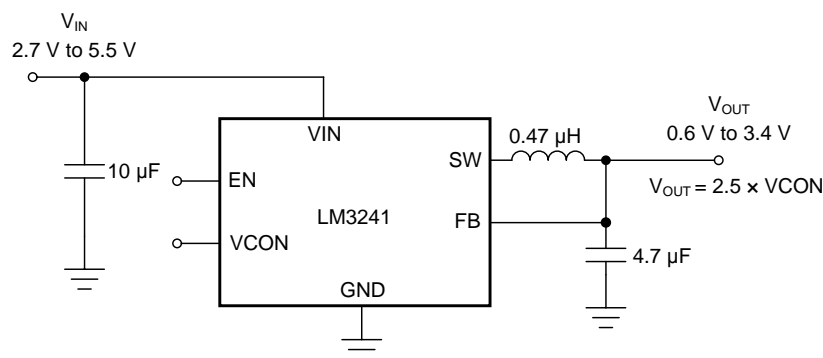

Copyright © 2017, Texas Instruments Incorporated



目录

1	特性	1	7.4	Device Functional Modes.....	15
2	应用	1	8	Application and Implementation	16
3	说明	1	8.1	Application Information.....	16
4	修订历史记录	2	8.2	Typical Application	16
5	Pin Configuration and Functions	3	9	Power Supply Recommendations	19
6	Specifications	4	10	Layout	19
6.1	Absolute Maximum Ratings	4	10.1	Layout Guidelines	19
6.2	ESD Ratings.....	4	10.2	Layout Example	21
6.3	Recommended Operating Conditions.....	4	11	器件和文档支持	22
6.4	Thermal Information	4	11.1	文档支持	22
6.5	Electrical Characteristics.....	5	11.2	接收文档更新通知	22
6.6	System Characteristics	6	11.3	社区资源	22
6.7	Typical Characteristics	7	11.4	商标	22
7	Detailed Description	12	11.5	静电放电警告	22
7.1	Overview	12	11.6	Glossary	22
7.2	Functional Block Diagram	13	12	机械、封装和可订购信息	22
7.3	Feature Description.....	13			

4 修订历史记录

注：之前版本的页码可能与当前版本有所不同。

Changes from Revision B (April 2013) to Revision C	Page
• 已添加 器件信息表, ESD 额定值表, 特性 说明部分, 器件功能模式部分, 应用和实施部分, 电源相关建议部分, 布局部分, 器件和文档支持部分以及机械、封装和可订购信息部分	1
• Deleted the maximum lead temperature parameter from the <i>Absolute Maximum Ratings</i> table.....	4
• Changed the minimum T_J and T_A from -30°C to -40°C in the <i>Recommended Operating Conditions</i> table	4
• Added the <i>Thermal Information</i> table	4
• Added maximum values for VOUT step rise and fall times under -40°C to 85°C T_A range in the <i>System Characteristics</i> table	6
• Added maximum value for turnon time under -40°C to 85°C T_A range in the <i>System Characteristics</i> table	6

5 Pin Configuration and Functions

**YZR Package With 0.5 mm Pitch
6-Pin DSBGA
Top View**

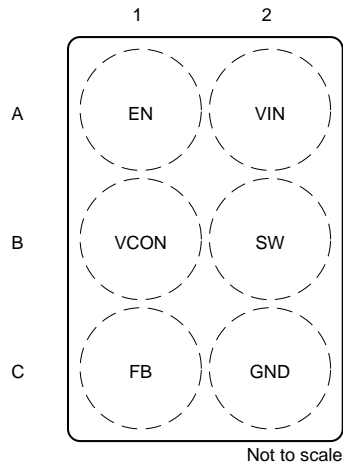

Pin Functions

PIN		TYPE	DESCRIPTION
NO.	NAME		
A1	EN	I	Enable Input. Set this digital input high for normal operation. For shutdown, set low. Do not leave EN pin floating.
A2	VIN	PWR	Power supply input. Connect to the input filter capacitor (see Figure 29).
B1	VCON	I	Voltage Control Analog input. VCON controls VOUT in PWM mode. Do not leave VCON pin floating. $V_{OUT} = 2.5 \times VCON$.
B2	SW	PWR	Switching Node connection to the internal PFET switch and NFET synchronous rectifier. Connect to an inductor with a saturation current rating that exceeds the maximum Switch Peak Current Limit specification of the LM3241.
C1	FB	I	Feedback Analog Input. Connect to the output at the output inductor.
C2	GND	—	Ground

6 Specifications

6.1 Absolute Maximum Ratings

 See ⁽¹⁾ and ⁽²⁾.

		MIN	MAX	UNIT
Pin voltage	VIN to GND	-0.2	6	V
	EN, FB, VCON, SW	(GND - 0.2)	(VIN + 0.2) ⁽³⁾	
Continuous power dissipation ⁽⁴⁾		Internally limited		
Junction temperature, T _{J-MAX}			150	°C
Storage temperature, T _{stg}		-65	150	°C

- (1) Stresses beyond those listed under *Absolute Maximum Ratings* may cause permanent damage to the device. These are stress ratings only, which do not imply functional operation of the device at these or any other conditions beyond those indicated under *Recommended Operating Conditions*. Exposure to absolute-maximum-rated conditions for extended periods may affect device reliability.
- (2) All voltages are with respect to the potential at the GND pins.
- (3) All pins are limited to the 6-V maximum stated for the VIN supply.
- (4) Internal thermal shutdown circuitry protects the device from permanent damage. Thermal shutdown engages at T_J = 150°C (typ.) and disengages at T_J = 125°C (typical).

6.2 ESD Ratings

		VALUE	UNIT
V _(ESD) Electrostatic discharge	Human-body model (HBM), per ANSI/ESDA/JEDEC JS-001 ⁽¹⁾⁽²⁾	2000	V
	Charged-device model (CDM), per JEDEC specification JESD22-C101 ⁽³⁾	1250	

- (1) JEDEC document JEP155 states that 500-V HBM allows safe manufacturing with a standard ESD control process.
- (2) The human body model is a 100-pF capacitor discharged through a 1.5-kΩ resistor into each pin. (MIL-STD-883 3015.7).
- (3) JEDEC document JEP157 states that 250-V CDM allows safe manufacturing with a standard ESD control process.

6.3 Recommended Operating Conditions

 See ⁽¹⁾.

		MIN	NOM	MAX	UNIT
	Input voltage	2.7		5.5	V
	Recommended load current	0		750	mA
T _J	Junction temperature	-40		125	°C
T _A	Ambient temperature ⁽²⁾	-40		85	°C

- (1) All voltages are with respect to the potential at the GND pins.
- (2) In applications where high power dissipation and/or poor package thermal resistance is present, the maximum ambient temperature may have to be de-rated. Maximum ambient temperature (T_{A-MAX}) is dependent on the maximum operating junction temperature (T_{J-MAX-OP} = 125°C), the maximum power dissipation of the device in the application (P_{D-MAX}), and the junction-to ambient thermal resistance of the part/package in the application (R_{θJA}), as given by the following equation: T_{A-MAX} = T_{J-MAX-OP} - (R_{θJA} × P_{D-MAX}).

6.4 Thermal Information

THERMAL METRIC ⁽¹⁾		LM3241	UNIT
		YZR (DSBGA)	
		6 PINS	
R _{θJA}	Junction-to-ambient thermal resistance	117	°C/W
R _{θJC(top)}	Junction-to-case (top) thermal resistance	1	°C/W
R _{θJB}	Junction-to-board thermal resistance	32.5	°C/W
ψ _{JT}	Junction-to-top characterization parameter	0.2	°C/W
ψ _{JB}	Junction-to-board characterization parameter	32.6	°C/W
R _{θJC(bot)}	Junction-to-case (bottom) thermal resistance	—	°C/W

- (1) For more information about traditional and new thermal metrics, see the [Semiconductor and IC Package Thermal Metrics application report](#).

6.5 Electrical Characteristics

All voltages are with respect to the potential at the GND pins. Minimum (MIN) and maximum (MAX) limits are specified by design, test, or statistical analysis. For performance over the input voltage range and closed-loop results, see the curves in the [Typical Characteristics](#) section.

PARAMETER		TEST CONDITIONS	MIN	TYP	MAX	UNIT
V _{FB,MIN}	Feedback voltage at minimum setting	PWM mode, VCON = 0.24 V		0.6		V
		PWM mode, open loop conditions at V _{IN} = 3.6 V, VCON = 0.24 V	0.58		0.62	
V _{FB,MAX}	Feedback voltage at maximum setting	PWM mode, VCON = 1.36 V, V _{IN} = 3.9 V		3.4		V
		PWM mode, open loop conditions at V _{IN} = 3.6 V, VCON = 1.36 V, V _{IN} = 3.9 V	3.332		3.468	
I _{SHDN}	Shutdown supply current	EN = SW = VCON = 0 V ⁽¹⁾		0.1		μA
		open loop conditions at V _{IN} = 3.6 V, EN = SW = VCON = 0 V ⁽¹⁾			2	
I _{Q_PWM}	PWM mode quiescent current	PWM mode, No switching ⁽²⁾ , VCON = 0 V, FB = 1 V		620		μA
		PWM mode, open loop conditions at V _{IN} = 3.6 V, No switching ⁽²⁾ , VCON = 0 V, FB = 1 V			750	
I _{Q_ECO}	Eco-mode quiescent current	Eco-mode, No switching ⁽²⁾ , VCON = 0.8 V, FB = 2.05 V		45		μA
		Eco-mode, open loop conditions at V _{IN} = 3.6 V, No switching ⁽²⁾ , VCON = 0.8 V, FB = 2.05 V			60	
R _{DS(on) (P)}	Pin-pin resistance for PFET	V _{IN} = V _{GS} = 3.6 V, I _{SW} = 200 mA		160		mΩ
		Open loop conditions at V _{IN} = 3.6 V, V _{IN} = V _{GS} = 3.6 V, I _{SW} = 200 mA			250	
R _{DS(on) (N)}	Pin-pin resistance for NFET	V _{IN} = V _{GS} = 3.6 V, I _{SW} = -200 mA		110		mΩ
		Open loop conditions at V _{IN} = 3.6 V, V _{IN} = V _{GS} = 3.6 V, I _{SW} = -200 mA			200	
I _{LIM}	PFET switch peak current limit ⁽³⁾			1450		mA
		Open loop conditions at V _{IN} = 3.6 V	1300		1600	
F _{OSC}	Internal oscillator frequency			6		MHz
		Open loop conditions at V _{IN} = 3.6 V	5.7		6.3	
V _{IH}	EN Logic high input threshold	Open loop conditions at V _{IN} = 3.6 V	1.2			V
V _{IL}	EN Logic low input threshold	Open loop conditions at V _{IN} = 3.6 V			0.4	V
Gain	VCON to V _{OUT} gain	0.24 V ≤ VCON ≤ 1.36 V		2.5		V/V
I _{CON}	VCON pin leakage current	Open-loop mode, VCON = 1 V			±1	μA

(1) Shutdown current includes leakage current of PFET.

(2) I_Q specified here is when the part is not switching under test mode conditions. For operating quiescent current at no load, see the curves in the [Typical Characteristics](#) section.

(3) Current limit is built-in, fixed, and not adjustable.

6.6 System Characteristics

The following spec table entries are specified by design providing the component values in [Figure 29](#) are used. These parameters are not verified by production testing. Minimum (MIN) and maximum (MAX) values apply over the full operating ambient temperature range ($-40^{\circ}\text{C} \leq T_A \leq 85^{\circ}\text{C}$) and over the V_{IN} range of 2.7 V to 5.5 V unless otherwise specified. $L = 0.47 \mu\text{H}$, $\text{DCR} = 50 \text{ m}\Omega$, $C_{\text{IN}} = 10 \mu\text{F}$, 6.3 V, 0603 (1608), $C_{\text{OUT}} = 4.7 \mu\text{F}$, 6.3 V, 0603 (1608).

PARAMETER		TEST CONDITIONS	MIN	TYP	MAX	UNIT
$T_{\text{CON TR}}$	V_{OUT} step rise time from 0.6 V to 3.4 V (to reach 3.26 V)	$V_{\text{IN}} = 3.6 \text{ V}$, $V_{\text{CON}} = 0.24 \text{ V}$ to 1.36 V, $V_{\text{CON}} T_{\text{R}} = 1 \mu\text{s}$, $R_{\text{LOAD}} = 10 \Omega$, $-30^{\circ}\text{C} \leq T_A \leq 85^{\circ}\text{C}$			25	μs
		$V_{\text{IN}} = 3.6 \text{ V}$, $V_{\text{CON}} = 0.24 \text{ V}$ to 1.36 V, $V_{\text{CON}} T_{\text{R}} = 1 \mu\text{s}$, $R_{\text{LOAD}} = 10 \Omega$			30	
	V_{OUT} step fall time from 3.4 V to 0.6 V (to reach 0.74 V)	$V_{\text{IN}} = 3.6 \text{ V}$, $V_{\text{CON}} = 1.36 \text{ V}$ to 0.24 V, $V_{\text{CON}} T_{\text{F}} = 1 \mu\text{s}$, $R_{\text{LOAD}} = 10 \Omega$, $-30^{\circ}\text{C} \leq T_A \leq 85^{\circ}\text{C}$			25	
		$V_{\text{IN}} = 3.6 \text{ V}$, $V_{\text{CON}} = 1.36 \text{ V}$ to 0.24 V, $V_{\text{CON}} T_{\text{F}} = 1 \mu\text{s}$, $R_{\text{LOAD}} = 10 \Omega$			30	
D	Maximum Duty cycle		100%			
I_{OUT}	Maximum output current capability	$2.7 \text{ V} \leq V_{\text{IN}} \leq 5.5 \text{ V}$, $0.24 \text{ V} \leq V_{\text{CON}} \leq 1.36 \text{ V}$	750			mA
C_{CON}	VCON input capacitance	$V_{\text{CON}} = 1 \text{ V}$, Test frequency = 100 KHz		5	10	pF
Linearity	Linearity in control range 0.24 V to 1.36 V	Monotronic in nature ⁽¹⁾	-3%		3%	mV
			-50		+50	
T_{ON}	Turnon time (time for output to reach 95% final value after Enable low-to-high transition)	EN = Low-to-High, $V_{\text{IN}} = 4.2 \text{ V}$, $V_{\text{OUT}} = 3.4 \text{ V}$, $I_{\text{OUT}} < 1 \text{ mA}$, $C_{\text{OUT}} = 4.7 \mu\text{F}$, $-30^{\circ}\text{C} \leq T_A \leq 85^{\circ}\text{C}$			50	μs
		EN = Low-to-High, $V_{\text{IN}} = 4.2 \text{ V}$, $V_{\text{OUT}} = 3.4 \text{ V}$, $I_{\text{OUT}} < 1 \text{ mA}$, $C_{\text{OUT}} = 4.7 \mu\text{F}$			55	
η	Efficiency	$V_{\text{IN}} = 3.6 \text{ V}$, $V_{\text{OUT}} = 0.8 \text{ V}$, $I_{\text{OUT}} = 10 \text{ mA}$, Eco-mode		75%		
		$V_{\text{IN}} = 3.6 \text{ V}$, $V_{\text{OUT}} = 1.8 \text{ V}$, $I_{\text{OUT}} = 200 \text{ mA}$, PWM mode		90%		
		$V_{\text{IN}} = 3.9 \text{ V}$, $V_{\text{OUT}} = 3.3 \text{ V}$, $I_{\text{OUT}} = 500 \text{ mA}$, PWM mode		95%		
LINE_{TR}	Line transient response	$V_{\text{IN}} = 3.6 \text{ V}$ to 4.2 V, $T_{\text{R}} = T_{\text{F}} = 10 \mu\text{s}$, $I_{\text{OUT}} = 100 \text{ mA}$, $V_{\text{OUT}} = 0.8 \text{ V}$		50		mVpk
LOAD_{TR}	Load transient response	$V_{\text{IN}} = 3.1 \text{ V}/3.6 \text{ V}/4.5 \text{ V}$, $V_{\text{OUT}} = 0.8 \text{ V}$, $I_{\text{OUT}} = 50 \text{ mA}$ to 150 mA, $T_{\text{R}} = T_{\text{F}} = 0.1 \mu\text{s}$		50		

(1) Linearity limits are $\pm 3\%$ or $\pm 50 \text{ mV}$ whichever is larger.

6.7 Typical Characteristics

$V_{IN} = EN = 3.6\text{ V}$ and $T_A = 25^\circ\text{C}$, unless otherwise noted.

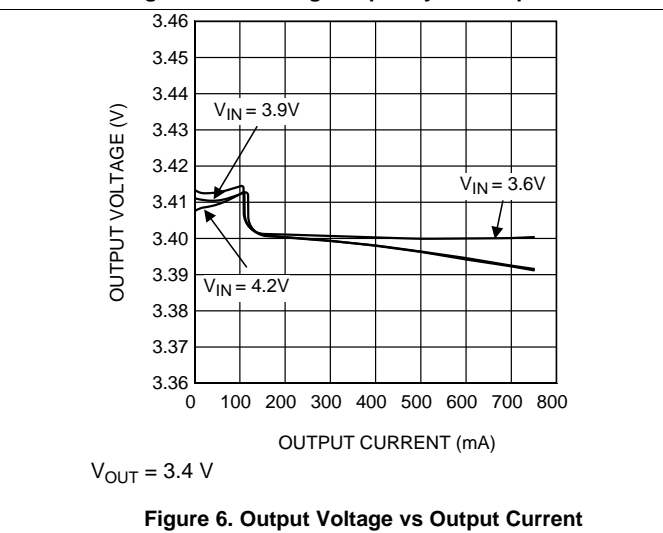
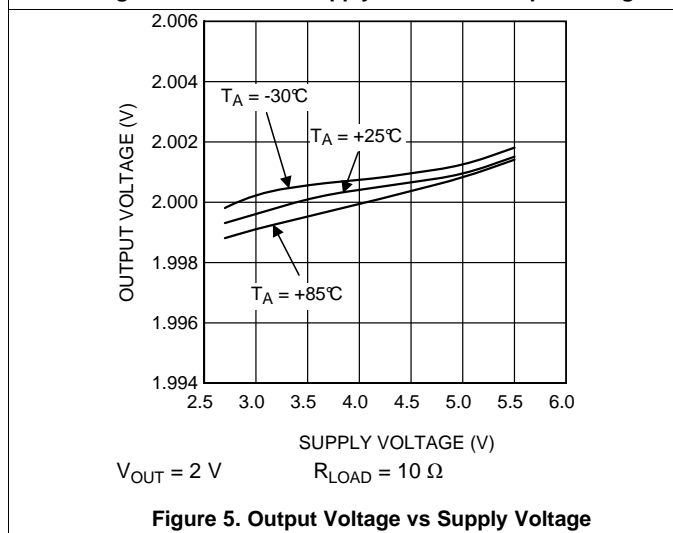
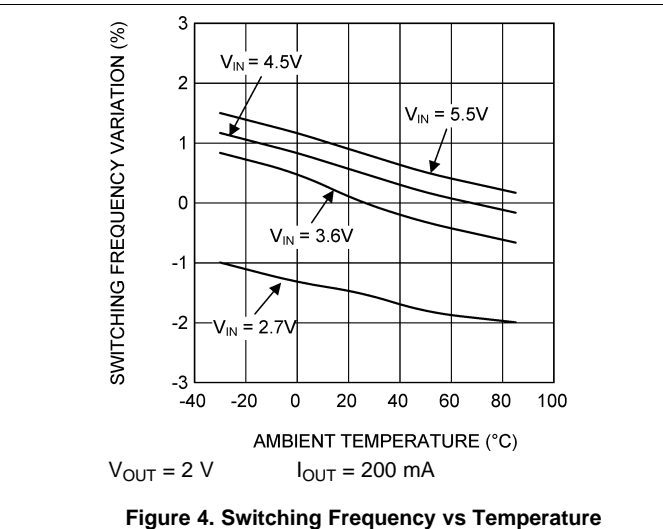
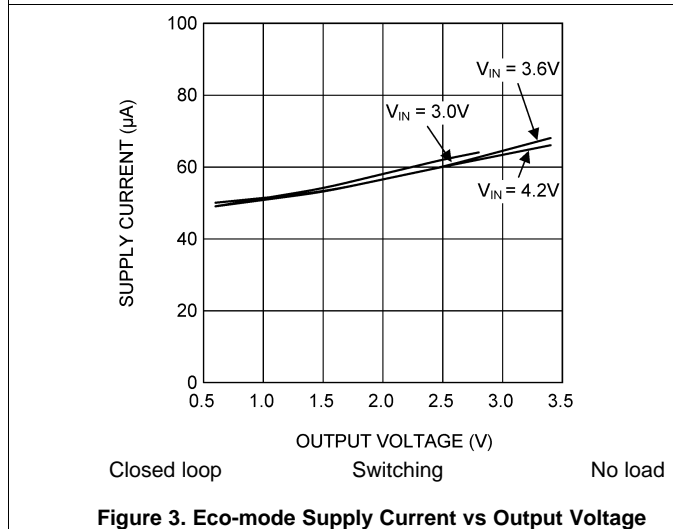
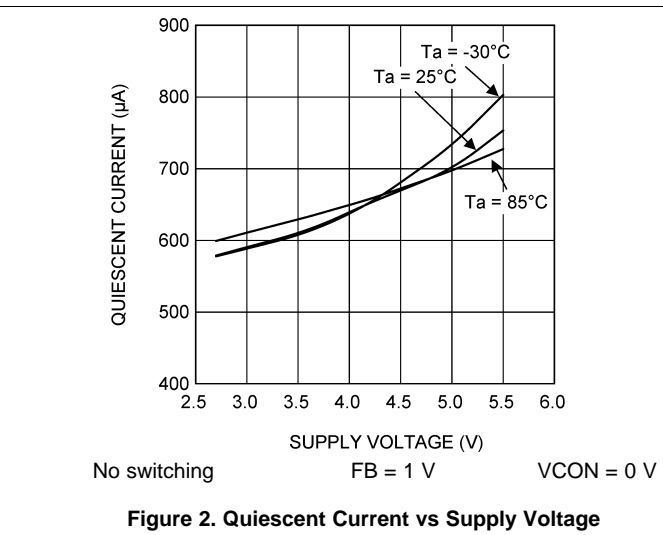
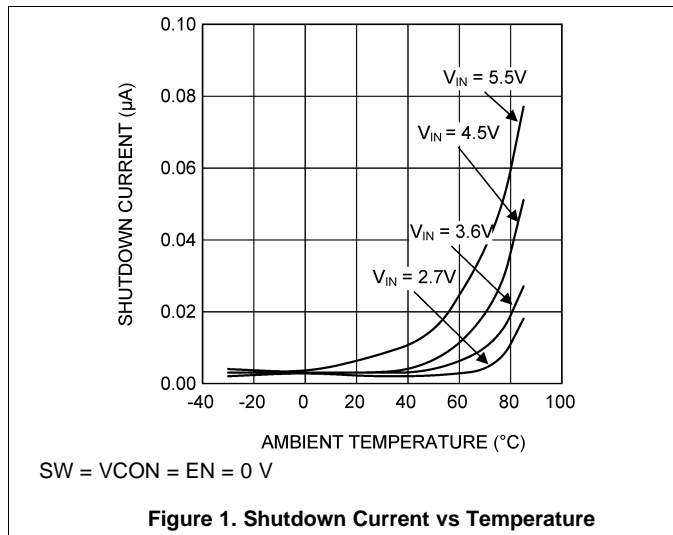

Typical Characteristics (continued)

$V_{IN} = EN = 3.6\text{ V}$ and $T_A = 25^\circ\text{C}$, unless otherwise noted.

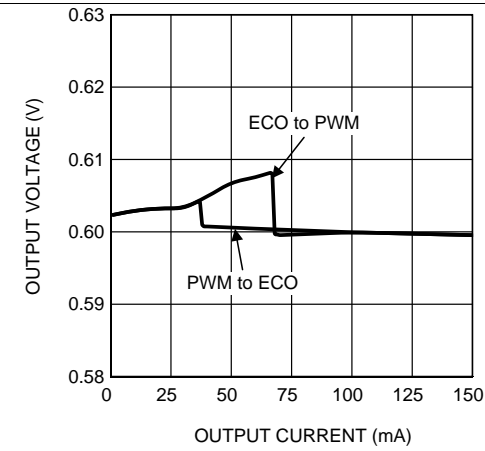

$V_{OUT} = 0.6\text{ V}$

Figure 7. Output Voltage vs Output Current

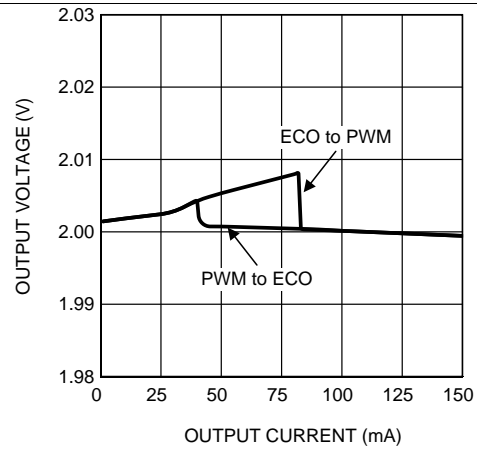

$V_{OUT} = 2\text{ V}$

Figure 8. Output Voltage vs Output Current

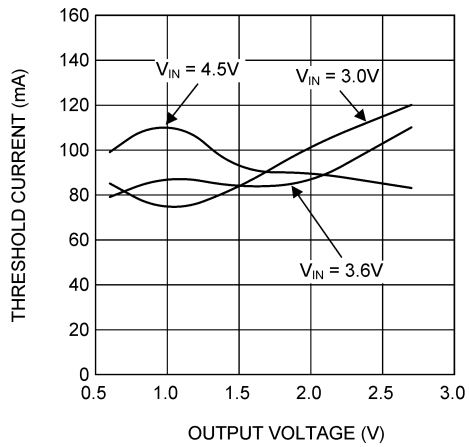

Figure 9. ECO-PWM Mode Threshold Current vs Output voltage

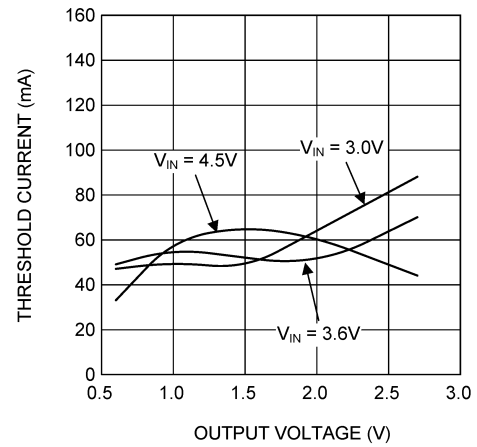
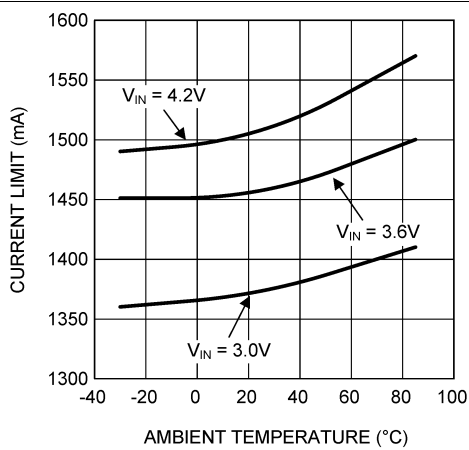
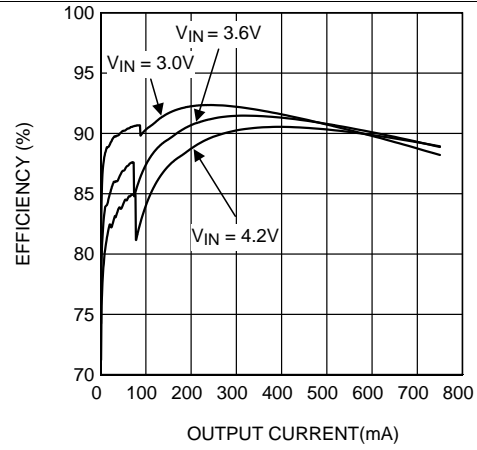

Figure 10. PWM-Eco-Mode Threshold Current vs Output voltage



$V_{OUT} = 2\text{ V}$

Figure 11. Closed-loop Current Limit vs Temperature



$V_{OUT} = 2\text{ V}$

Figure 12. Efficiency vs Output Current

Typical Characteristics (continued)

$V_{IN} = EN = 3.6\text{ V}$ and $T_A = 25^\circ\text{C}$, unless otherwise noted.

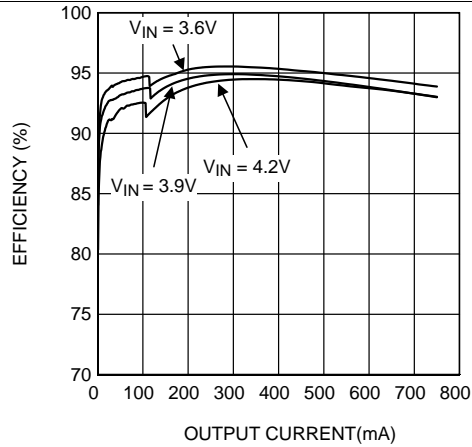

$V_{OUT} = 3.3\text{ V}$

Figure 13. Efficiency vs Output Current

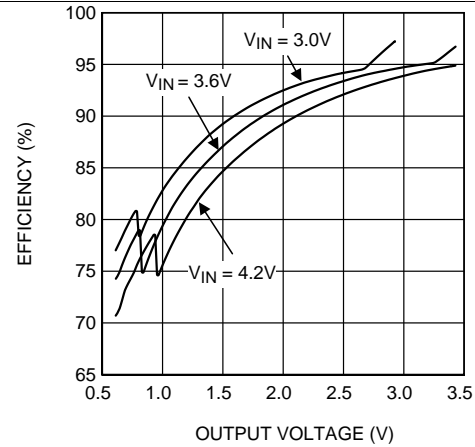

$R_{LOAD} = 10\ \Omega$

Figure 14. Efficiency vs Output Voltage

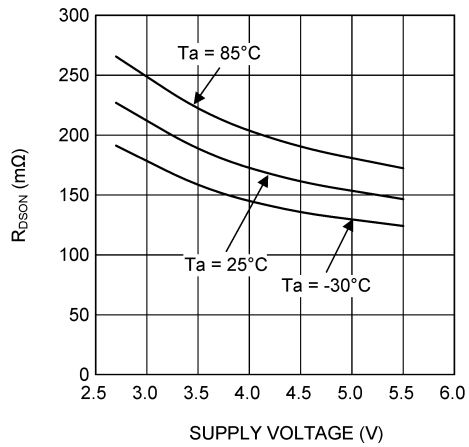

Figure 15. PFET $R_{DS(on)}$ vs Supply Voltage

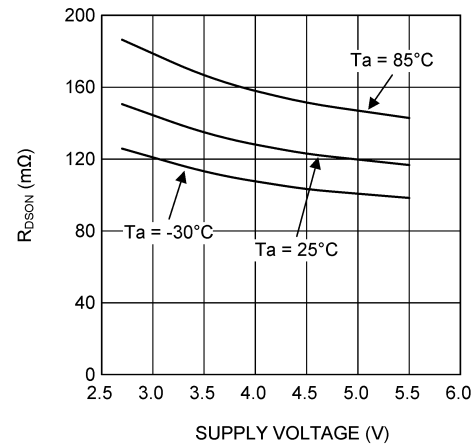
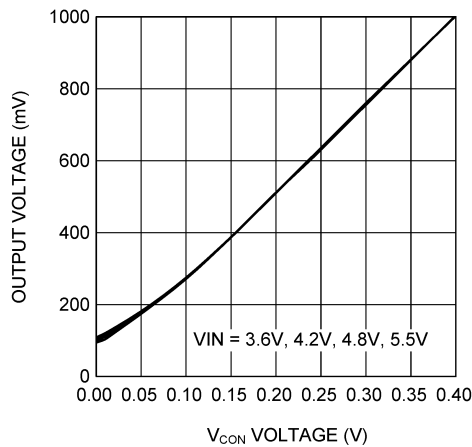
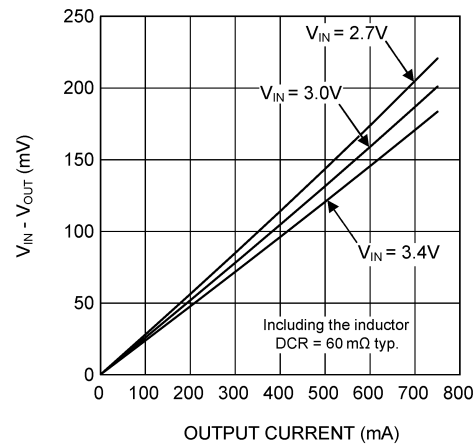

Figure 16. NFET $R_{DS(on)}$ vs Supply Voltage



$R_{LOAD} = 10\ \Omega$

Figure 17. Low V_{CON} Voltage vs Output Voltage



100% Duty Cycle

Figure 18. $V_{IN} - V_{OUT}$ vs Output Current

Typical Characteristics (continued)

$V_{IN} = EN = 3.6\text{ V}$ and $T_A = 25^\circ\text{C}$, unless otherwise noted.

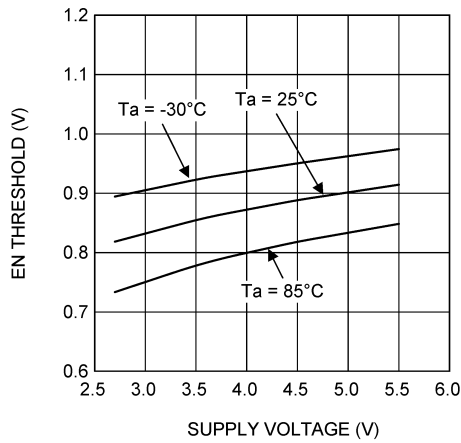

Figure 19. EN High Threshold vs Supply Voltage

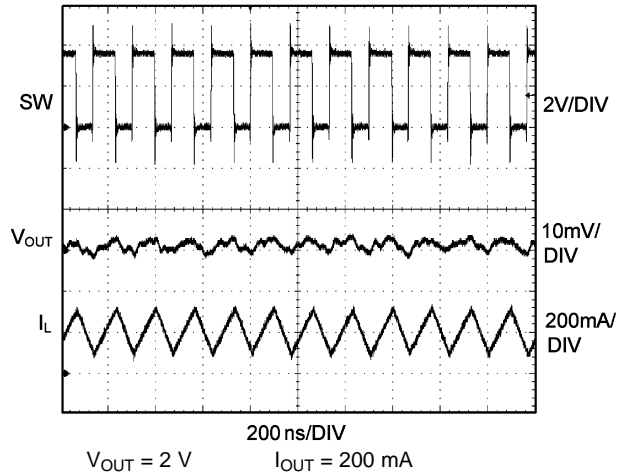

Figure 20. Output Voltage Ripple in PWM Mode

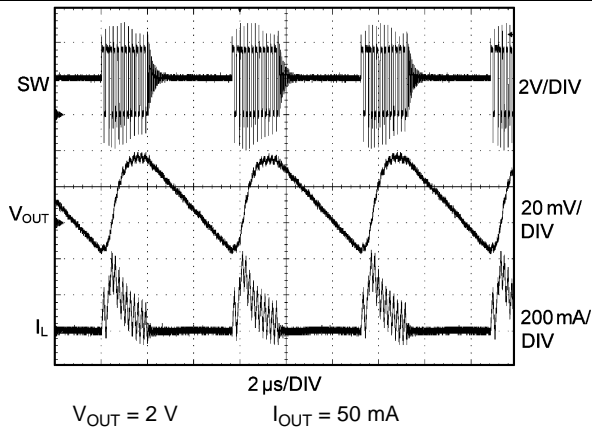

Figure 21. Output Voltage Ripple in Eco-Mode

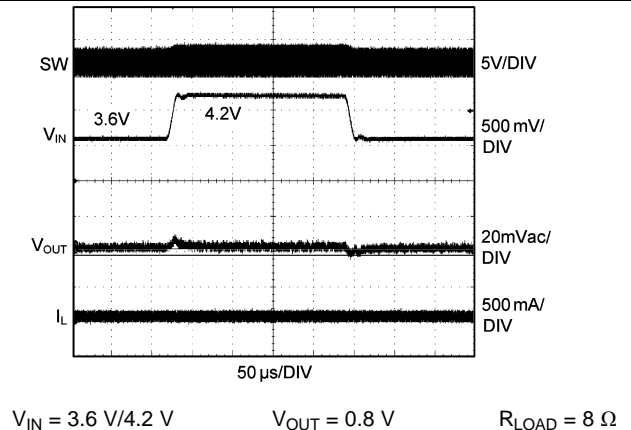

Figure 22. Line Transient Response

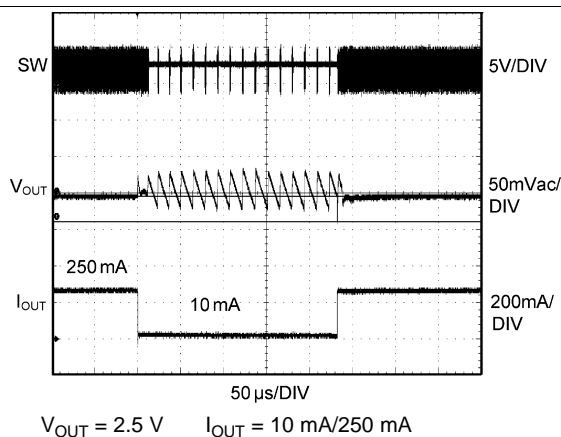

Figure 23. Load Transient Response

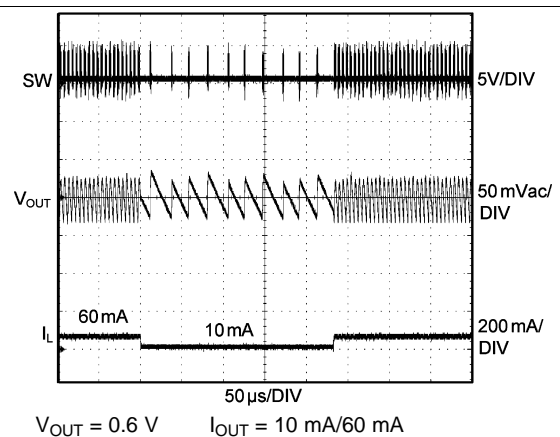
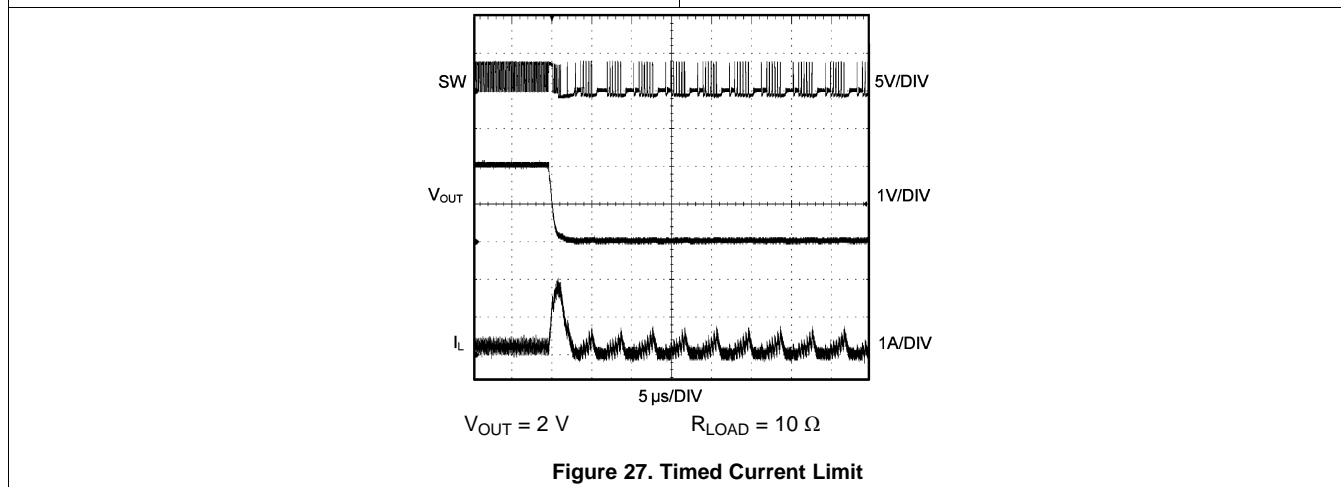
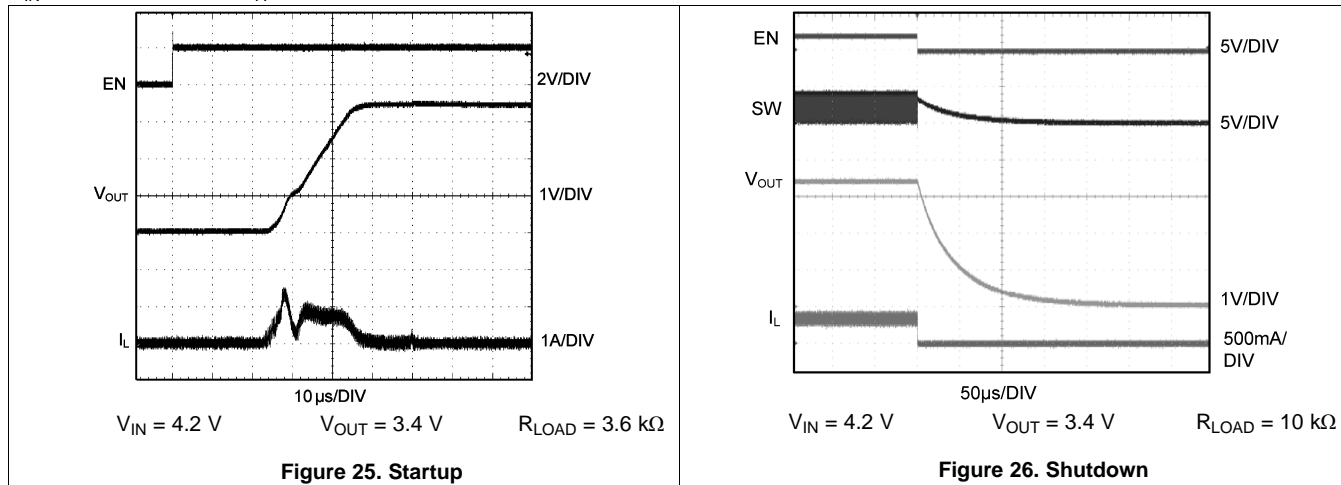

Figure 24. Load Transient Response

Typical Characteristics (continued)

$V_{IN} = EN = 3.6\text{ V}$ and $T_A = 25^\circ\text{C}$, unless otherwise noted.



7 Detailed Description

7.1 Overview

The LM3241 is a simple, step-down DC-DC converter optimized for powering RF power amplifiers (PAs) in mobile phones, portable communicators, and similar battery-powered RF devices. The device is designed to allow the RF PA to operate at maximum efficiency over a wide range of power levels from a single Li-Ion battery cell. The design is based on a voltage-mode buck architecture, with synchronous rectification for high efficiency. The device is designed for a maximum load capability of 750 mA in PWM mode. Maximum load range may vary from this depending on input voltage, output voltage, and the inductor chosen.

Three modes of operation are available depending on the current required: pulse width modulation (PWM), Eco-mode (economy mode), and shutdown. The LM3241 operates in PWM mode at higher load-current conditions. Lighter loads cause the device to automatically switch into Eco-mode. Shutdown mode turns off the device and reduces battery consumption to 0.1 μ A (typical).

Precision of the DC PWM-mode output voltage is $\pm 2\%$ for 3.4 V_{OUT}. Efficiency is around 95% (typical) for a 500-mA load with a 3.3-V output and 3.9-V input. The output voltage is dynamically programmable from 0.6 V to 3.4 V by adjusting the voltage on the control pin (VCON) without the need for external feedback resistors. This feature ensures longer battery life by being able to change the PA supply voltage dynamically depending on its transmitting power.

Additional features include current overload protection and thermal overload shutdown.

The LM3241 is constructed using a chip-scale, 6-bump DSBGA package. This package offers the smallest possible size for space-critical applications, such as cell phones, where board area is an important design consideration. Use of a high switching frequency (6 MHz, typical) reduces the size of external components. As shown in [Figure 29](#), only three external power components are required for implementation. Use of a DSBGA package requires special design considerations for implementation (for more information see the [DSBGA Package Assembly and Use](#) section.) The fine-bump pitch of the package requires careful board design and precision assembly equipment. Use of this package is best suited for opaque-case applications, where its edges are not subject to high-intensity ambient red or infrared light. Also, the system controller should set EN low during power-up and other low supply voltage conditions (see the [Shutdown Mode](#) section).

7.2 Functional Block Diagram

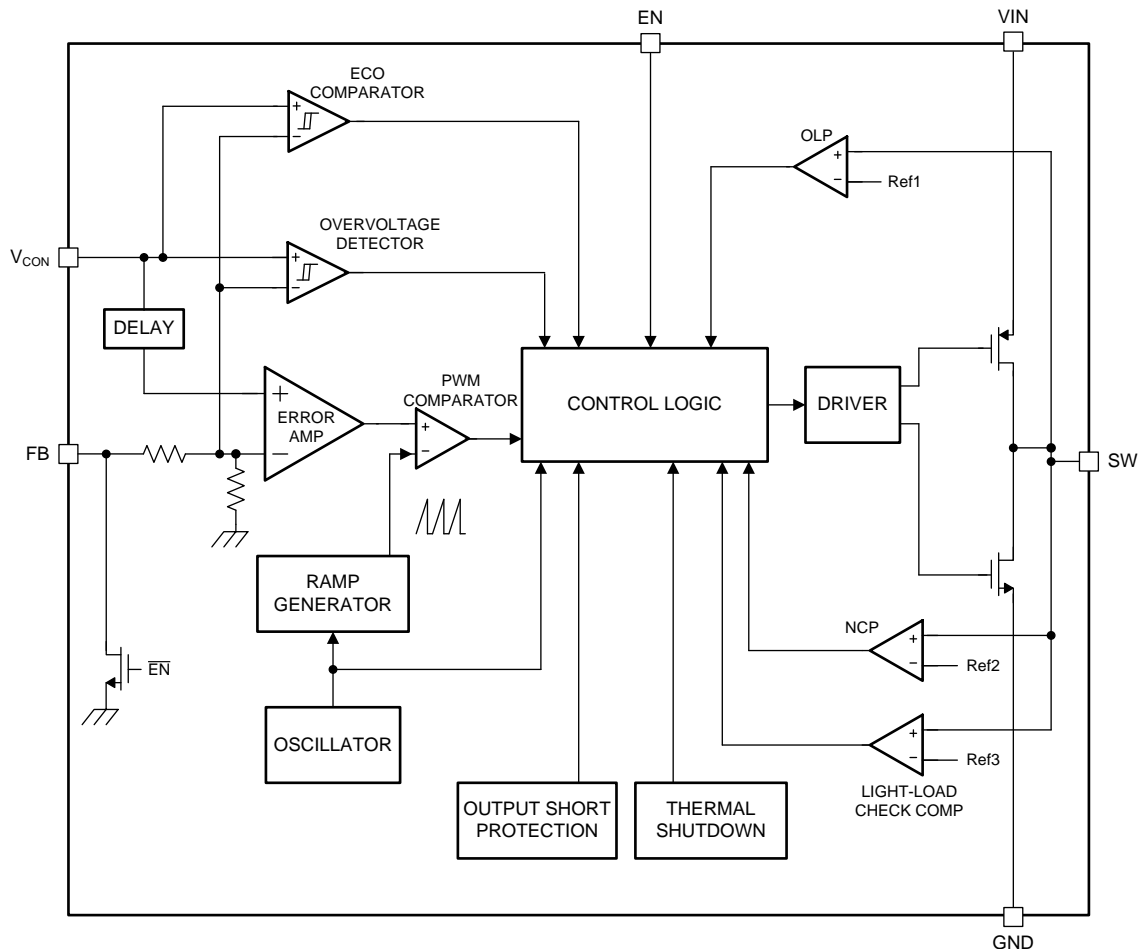

Copyright © 2017, Texas Instruments Incorporated

7.3 Feature Description

7.3.1 Circuit Operation

Referring to [Figure 29](#) and the [Functional Block Diagram](#), the LM3241 operates as follows. During the first part of each switching cycle, the control block in the LM3241 turns on the internal, top-side PFET switch. This allows current to flow from the input through the inductor to the output filter capacitor and load. The inductor limits the current to a ramp with a slope of around $(V_{IN} - V_{OUT}) / L$, by storing energy in a magnetic field. During the second part of each cycle, the controller turns the PFET switch off, blocking current flow from the input, and then turns the bottom-side NFET synchronous rectifier on. In response, the magnetic field of the inductor collapses, generating a voltage that forces current from ground through the synchronous rectifier to the output filter capacitor and load. As the stored energy is transferred back into the circuit and depleted, the inductor current ramps down with a slope around V_{OUT} / L . The output filter capacitor stores charge when the inductor current is high, and releases it when low, smoothing the voltage across the load.

The output voltage is regulated by modulating the PFET switch-on time to control the average current sent to the load. The effect is identical to sending a duty-cycle modulated rectangular wave formed by the switch and synchronous rectifier at SW to a low-pass filter formed by the inductor and output filter capacitor. The output voltage is equal to the average voltage at the SW pin.

Feature Description (continued)

7.3.2 Internal Synchronization Rectification

While in PWM mode, the LM3241 uses an internal NFET as a synchronous rectifier to reduce rectifier forward voltage drop and associated power loss. Synchronous rectification provides a significant improvement in efficiency whenever the output voltage is relatively low compared to the voltage drop across an ordinary rectifier diode.

With medium and heavy loads, the NFET synchronous rectifier is turned on during the inductor current-down slope in the second part of each cycle. The synchronous rectifier is turned off prior to the next cycle. The NFET is designed to conduct through its intrinsic body diode during transient intervals before it turns on, eliminating the need for an external diode.

7.3.3 Current Limiting

The current limit feature allows the LM3241 to protect itself and external components during overload conditions. In PWM mode, the cycle-by-cycle current limit is 1450 mA (typical). If an excessive load pulls the output voltage down to less than 0.3 V (typical), the NFET synchronous rectifier is disabled, and the current limit is reduced to 530 mA (typical). Moreover, when the output voltage becomes less than 0.15 V (typical), the switching frequency decreases to 3 MHz, thereby preventing excess current and thermal stress.

7.3.4 Dynamically Adjustable Output Voltage

The LM3241 features dynamically adjustable output voltage to eliminate the need for external feedback resistors. The output voltage can be set from 0.6 V to 3.4 V by changing the voltage on the analog VCON pin. This feature is useful in PA applications where peak power is needed only when the handset is far away from the base station or when data is being transmitted. In other instances the transmitting power can be reduced. Therefore the supply voltage to the PA can be reduced, promoting longer battery life. For more information, see the [Setting the Output Voltage](#) in the [Application and Implementation](#) section. The LM3241 moves into Pulse Skipping mode when the duty cycle is over approximately 92% or less than approximately 15%, and the output voltage ripple increases slightly.

7.3.5 Thermal Overload Protection

The LM3241 has a thermal overload protection function that operates to protect itself from short-term misuse and overload conditions. When the junction temperature exceeds around 150°C, the device inhibits operation. Both the PFET and the NFET are turned off. When the temperature drops below 125°C, normal operation resumes. Prolonged operation in thermal overload conditions may damage the device and is considered bad practice.

7.3.6 Soft Start

The LM3241 has a soft-start circuit that limits in-rush current during startup. During startup the switch current limit is increased in steps. Soft start is activated if EN goes from low to high after V_{IN} reaches 2.7 V.

7.4 Device Functional Modes

7.4.1 PWM Mode Operation

While in PWM mode operation, the converter operates as a voltage-mode controller with input voltage feed forward. This operation allows the converter to achieve excellent load and line regulation. The DC gain of the power stage is proportional to the input voltage. To eliminate this dependence, feed forward inversely proportional to the input voltage is introduced. While in PWM mode, the output voltage is regulated by switching at a constant frequency and then modulating the energy per cycle to control power to the load. At the beginning of each clock cycle the PFET switch is turned on and the inductor current ramps up until the comparator trips and the control logic turns off the switch. The current-limit comparator can also turn off the switch in case the current limit of the PFET is exceeded. Then the NFET switch is turned on and the inductor current ramps down. The next cycle is initiated by the clock turning off the NFET and turning on the PFET.

7.4.2 Eco-mode™ Operation

At very light loads (50 mA to 100 mA), the LM3241 enters Eco-mode operation with reduced switching frequency and supply current to maintain high efficiency. During Eco-mode operation, the LM3241 positions the output voltage slightly higher (+7 mV typical) than the normal output voltage during PWM mode operation, allowing additional headroom for voltage drop during a load transient from light to heavy load.

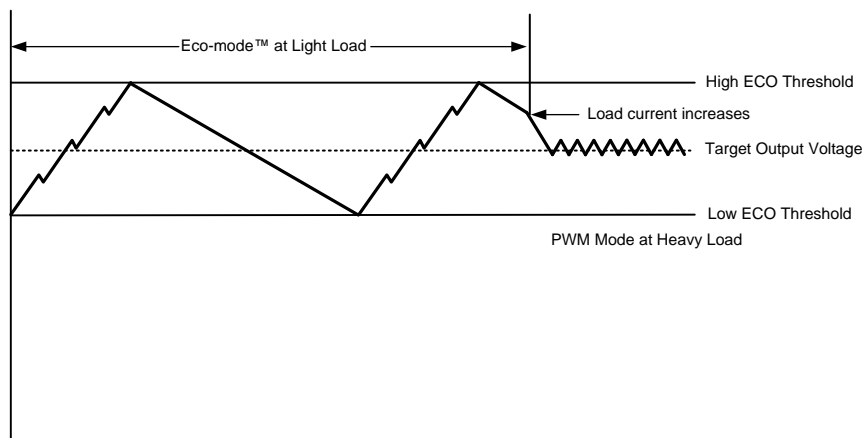

Figure 28. Operation in Eco-mode and Transfer to PWM Mode

7.4.3 Shutdown Mode

Setting the EN digital pin low (<0.4 V) places the LM3241 in shutdown mode (0.1 μ A typical). During shutdown, the PFET switch, the NFET synchronous rectifier, reference voltage source, control and bias circuitry of the LM3241 are turned off. Setting the EN pin high (>1.2 V) enables normal operation. The EN pin should be set low to turn off the LM3241 during power-up and undervoltage conditions when the power supply is less than the 2.7-V minimum operating voltage. The LM3241 has an undervoltage-lockout (UVLO) comparator to turn off the power device in the case the input voltage or battery voltage is too low. The typical UVLO threshold is around 2.0 V for lock and 2.1 V for release.

8 Application and Implementation

NOTE

Information in the following applications sections is not part of the TI component specification, and TI does not warrant its accuracy or completeness. TI's customers are responsible for determining suitability of components for their purposes. Customers should validate and test their design implementation to confirm system functionality.

8.1 Application Information

The LM3241 is a synchronous step-down converter in which output voltage is adjusted by a controlled voltage. The following section discusses the design of the external components to complete the power supply design for several input and output voltage options by using typical applications as a reference.

8.2 Typical Application

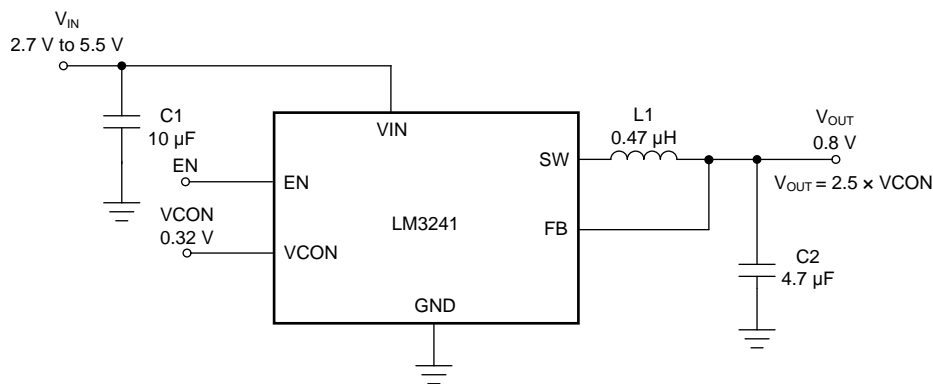

Copyright © 2017, Texas Instruments Incorporated

Figure 29. LM3241 Typical Application Schematic

8.2.1 Design Requirements

For this design example, use the parameters listed in [Table 1](#).

Table 1. Design Parameters

DESIGN PARAMETER	EXAMPLE VALUE
Input voltage	2.7 V to 5.5 V
Output voltage	0.8 V
Maximum current	750 mA

8.2.2 Detailed Design Procedure

[Table 2](#) lists the component descriptions for [Figure 29](#).

Table 2. List of Components

REFERENCE	DESCRIPTION	MANUFACTURER
C1	10 µF, Ceramic capacitor, 6.3 V, X5R, size 0603, GRM188R60J106ME47D	Murata
C2	4.7 µF, Ceramic capacitor, 6.3 V, X5R, size 0603, GRM188R71H472KA01D	Murata
L1	0.47 µH, Fixed Inductor, 1.6 A, size 0806, LQM2MPNR47NG0L	Murata

8.2.2.1 Setting the Output Voltage

The LM3241 features a pin-controlled adjustable output voltage to eliminate the need for external feedback resistors. The output voltage can be programmed for an output voltage from 0.6 V to 3.4 V by setting the voltage on the VCON pin, as shown in [Equation 1](#).

$$V_{OUT} = 2.5 \times VCON \quad (1)$$

When the VCON voltage is between 0.24 V and 1.36 V, the output voltage follows proportionally by 2.5 times of VCON.

If the VCON voltage is less than 0.24 V ($V_{OUT} = 0.6$ V), the output voltage may be regulated (for details see [Figure 17](#)). [Figure 17](#) exhibits the characteristics of a typical part, and the performance cannot be ensured as a part-to-part variation could occur for output voltages less than 0.6 V. For V_{OUT} lower than 0.6 V, the converter could suffer from larger output ripple voltage and higher current limit operation.

8.2.2.2 Inductor Selection

Two main considerations must be considered when choosing an inductor: the inductor should not saturate, and the inductor current ripple should be small enough to achieve the desired output voltage ripple. Different manufacturers follow different saturation current rating specifications, so attention must be given to details. Saturation current ratings are typically specified at 25°C so ratings over the ambient temperature of application should be requested from manufacturer.

The minimum value of inductance to ensure good performance is 0.3 μ H at bias current (I_{LIM} , typical) over the ambient temperature range. Shielded inductors radiate less noise and should be preferred. Two methods are available to choose the inductor saturation current rating.

8.2.2.2.1 Method 1

The saturation current should be greater than the sum of the maximum load current and the worst case average to peak inductor current. Use [Equation 2](#) to find the saturation current (I_{SAT}).

$$I_{SAT} > I_{OUT_MAX} + I_{RIPPLE}$$

where

- I_{OUT_MAX} is the maximum load current (750 mA).
- I_{RIPPLE} is the average-to-peak inductor current. Use [Equation 3](#) to calculate the I_{RIPPLE} value. (2)

$$I_{RIPPLE} = \left(\frac{V_{IN} - V_{OUT}}{2 \times L} \right) \times \left(\frac{V_{OUT}}{V_{IN}} \right) \times \left(\frac{1}{f} \right)$$

where

- V_{IN} is the maximum input voltage in application.
- V_{OUT} is the output voltage
- L is the minimum inductor value including worst-case tolerances (30% drop can be considered for Method 1)
- f is the minimum switching frequency (5.7 MHz) (3)

8.2.2.2.2 Method 2

A more conservative and recommended approach is to choose an inductor that can support the maximum current limit of 1600 mA.

The resistance of the inductor should be less than approximately 0.1 Ω for good efficiency. [Table 3](#) lists recommended inductors and suppliers.

Table 3. Recommended Inductors

Model	Size (W x L x H) (mm)	Vendor
MIPSZ2012D0R5	2.0 x 1.2 x 1.0	FDK
LQM21PNR54MG0	2.0 x 1.25 x 0.9	Murata
LQM2MPNR47NG0	2.0 x 1.6 x 0.9	Murata

8.2.2.3 Capacitor Selection

The LM3241 is designed for use with ceramic capacitors for its input and output filters. Use a 10- μF ceramic capacitor for the input and a 4.7- μF ceramic capacitor for the output. The capacitors should maintain at least 50% capacitance at DC bias and temperature conditions. Ceramic capacitors type such as X5R, X7R, and B are recommended for both filters. These types provide an optimal balance between small size, cost, reliability, and performance for cell phones and similar applications. Table 4 lists some recommended part numbers and suppliers. DC bias characteristics of the capacitors must be considered when selecting the voltage rating and case size of the capacitor. For C_{IN} , use of an 0805 (2012) size may also be considered if room is available on the system board.

Table 4. Recommended Capacitors

Capacitance, Voltage Rating, Case Size	Model	Vendor
4.7 μF , 6.3 V, 0603	C1608X5R0J475M	TDK
4.7 μF , 6.3 V, 0402	C1005X5R0J475M	TDK
4.7 μF , 6.3 V, 0402	CL05A475MQ5NRNC	Samsung
10 μF , 6.3 V, 0603	C1608X5R0J106M	TDK
10 μF , 6.3 V, 0402	CL05A106MQ5NUNC	Samsung

The input filter capacitor supplies AC current drawn by the PFET switch of the LM3241 in the first part of each cycle and reduces the voltage ripple imposed on the input power source. The output filter capacitor absorbs the AC inductor current, helps maintain a steady output voltage during transient load changes, and reduces output voltage ripple. These capacitors must be selected with sufficient capacitance and sufficiently low equivalent series resistance (ESR) to perform these functions. The ESR of the filter capacitors is generally a major factor in voltage ripple.

8.2.3 Application Curves

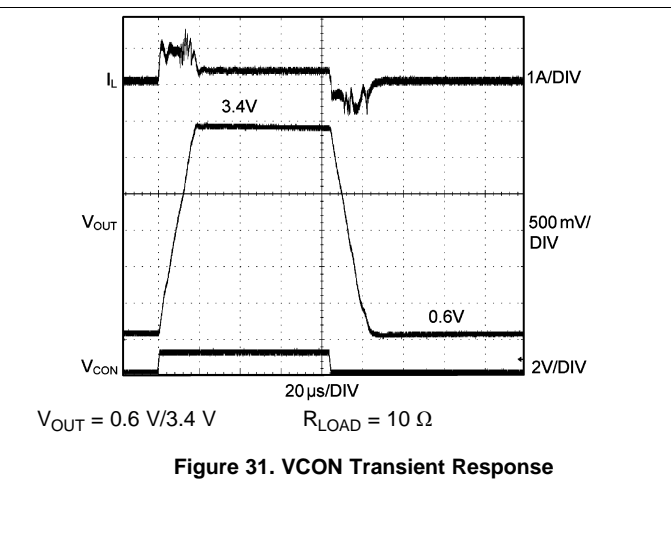
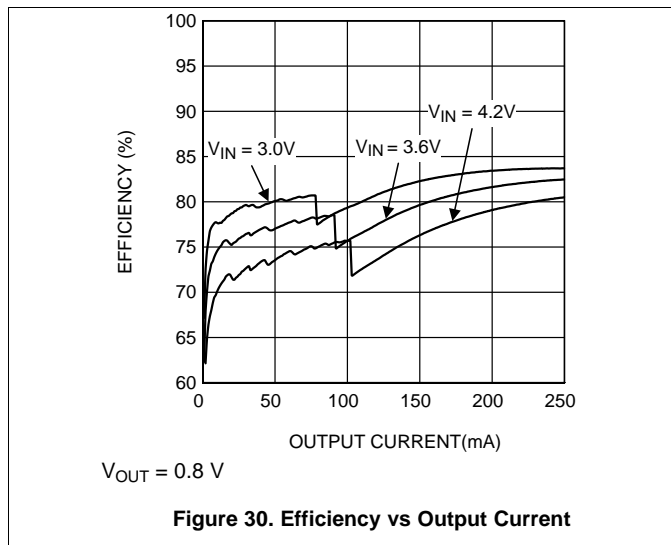

9 Power Supply Recommendations

The device is designed to operate from an input voltage supply range from 2.7 V to 5.5 V. Ensure that the input power supply has a sufficient current rating for the application.

10 Layout

10.1 Layout Guidelines

10.1.1 DSBGA Package Assembly and Use

Use of the DSBGA package requires specialized board layout, precision mounting and careful reflow techniques, as detailed in the [AN-1112 DSBGA Wafer Level Chip Scale Package application report](#). For best results in assembly, alignment ordinals on the PC board should be used to facilitate placement of the device. The pad style used with DSBGA package must be the non-solder mask defined (NSMD) type. This pad type means that the solder-mask opening is larger than the pad size which prevents a lip that otherwise forms if the solder-mask and pad overlap when holding the device off the surface of the board causing interference with mounting. For specific instructions on how to do this, refer to the [AN-1112 DSBGA Wafer Level Chip Scale Package application report](#).

The 6-bump package used for LM3241 has 300 micron solder balls and requires 10.82 mil pads for mounting on the circuit board. The trace to each pad should enter the pad with a 90° angle to prevent debris from being caught in deep corners. Initially, the trace to each pad should be 7 mil wide, for a section approximately 7 mil long, as a thermal relief. Then each trace should neck up or down to its optimal width. The important criterion is symmetry which ensures the solder bumps on the LM3241 reflow evenly and that the device solders level to the board. In particular, special attention must be paid to the pads for bumps A2 and C2. Because the VIN and GND pins are typically connected to large copper planes, inadequate thermal relief can result in late or inadequate reflow of these bumps.

The DSBGA package is optimized for the smallest possible size in applications with red or infrared opaque cases. Because the DSBGA package lacks the plastic encapsulation characteristic of larger devices, it is vulnerable to light. Backside metallization and/or epoxy coating, along with front-side shading by the printed circuit board, reduce this sensitivity. However, the package has exposed die edges. In particular, DSBGA devices are sensitive to light in the red and infrared range shining on the exposed die edges of the package.

TI recommends connecting a 10-nF capacitor between the VCON pin and ground for non-standard ESD events or environments and manufacturing processes. This capacitor prevents unexpected output voltage drift.

10.1.2 Board Layout Considerations

Printed-circuit board (PCB) layout is an important part of DC-DC converter design. Poor board layout can disrupt the performance of a DC-DC converter and surrounding circuitry by contributing to EMI, ground bounce, and resistive voltage loss in the traces. These factors can send erroneous signals to the DC-DC converter device, resulting in poor regulation or instability. Poor layout can also result in reflow problems leading to poor solder joints between the DSBGA package and board pads—poor solder joints can result in erratic or degraded performance. Good layout for the LM3241 can be implemented by following a few simple design rules, as shown in [Figure 33](#).

1. Place the LM3241 on 10.82 mil pads. As a thermal relief, connect each pad with a 7mil wide, approximately 7mil long trace, and then incrementally increase each trace to its optimal width. The V_{IN} and GND traces are especially recommended to be as wide as possible. The important criterion is symmetry to ensure the solder bumps reflow evenly (refer to the [AN-1112 DSBGA Wafer Level Chip Scale Package application report](#)).
2. Place the LM3241, inductor, and filter capacitors close together and make the traces short. The traces between these components carry relatively high switching current and act as antennae. Following this rule reduces radiated noise. **Special care must be given to place the input filter capacitor very close to the VIN and GND pads.**
3. Arrange the components so that the switching current loops curl in the same direction. During the first half of each cycle, current flows from the input filter capacitor, through the LM3241 and inductor to the output filter capacitor and back through ground, forming a current loop. In the second half of each cycle, current is pulled up from ground, through the LM3241 by the inductor, to the output filter capacitor and then back through ground, forming a second current loop. Routing these loops so the current curls in the same direction prevents magnetic field reversal between the two half-cycles and reduces radiated noise.

Layout Guidelines (continued)

4. Connect the ground pads of the LM3241 and filter capacitors together using generous component-side copper fill as a pseudo-ground plane. Then connect this to the ground-plane (if one is used) with several vias. This connection reduces ground-plane noise by preventing the switching currents from circulating through the ground plane. It also reduces ground bounce at the LM3241 by giving it a low impedance ground connection.
5. Use side traces between the power components and for power connections to the DC-DC converter circuit which reduces voltage errors caused by resistive losses across the traces.
6. Route noise sensitive traces such as the voltage feedback path away from noisy traces between the power components. The output voltage feedback point should be taken approximately 1.5 nH away from the output capacitor. **The voltage feedback trace must remain close to the LM3241 circuit and should be routed directly from FB to VOUT at the inductor and should be routed opposite to noise components.** This trace placement allows fast feedback and reduces EMI radiated onto the voltage feedback trace of the DC-DC converter (see [Figure 32](#)).

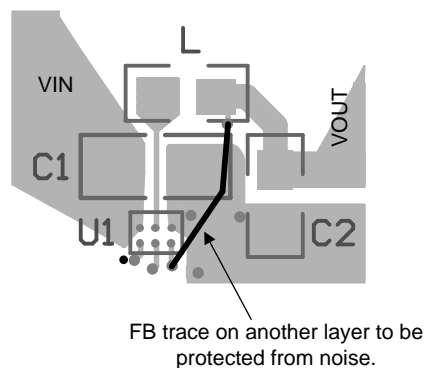

Figure 32. Feedback Trace

7. Place noise-sensitive circuitry, such as radio IF blocks, away from the DC-DC converter, CMOS digital blocks, and other noisy circuitry. Interference with noise-sensitive circuitry in the system can be reduce through distance.

In mobile phones, for example, a common practice is to place the DC-DC converter on one corner of the board, arrange the CMOS digital circuitry around it (because this also generates noise), and then place sensitive preamplifiers and IF stages on the diagonally opposing corner. Often, the sensitive circuitry is shielded with a metal pan and power to it is post-regulated to reduce conducted noise, using low-dropout linear regulators.

10.2 Layout Example

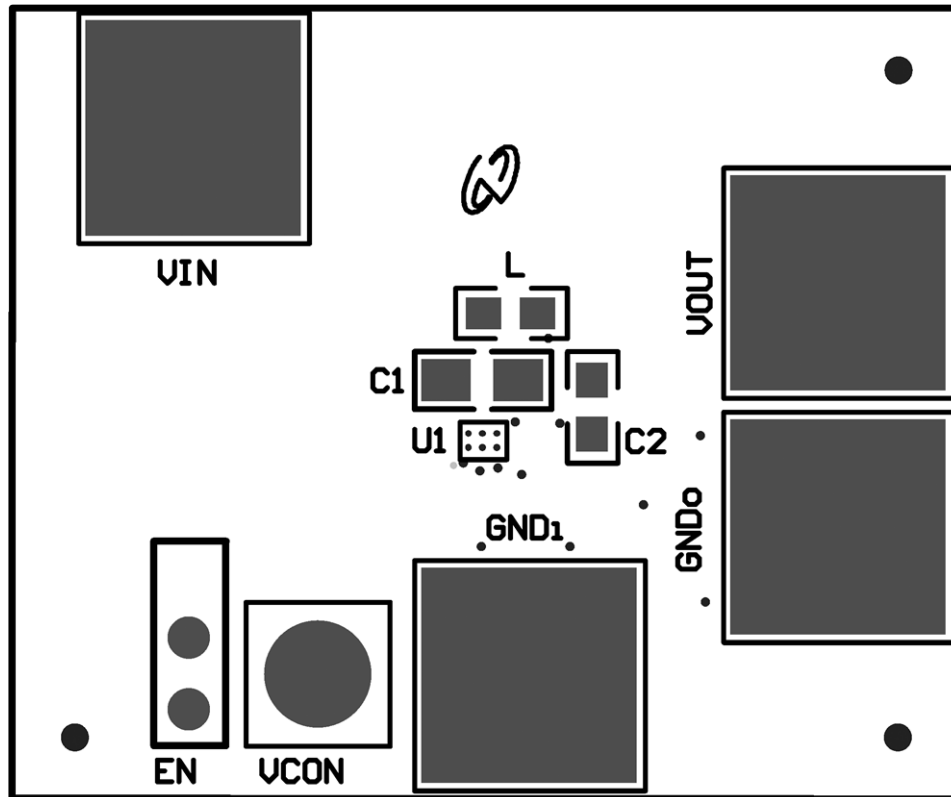

Figure 33. LM3241 Board Layout

11 器件和文档支持

11.1 文档支持

11.1.1 相关文档

请参阅如下相关文档:

德州仪器 (TI), [AN-1112 《DSBGA 晶圆级芯片级封装》应用报告](#)

11.2 接收文档更新通知

要接收文档更新通知, 请导航至 [TI.com](#) 上的器件产品文件夹。单击右上角的 [通知我](#) 进行注册, 即可每周接收产品信息更改摘要。有关更改的详细信息, 请查看任何已修订文档中包含的修订历史记录。

11.3 社区资源

下列链接提供到 TI 社区资源的连接。链接的内容由各个分销商“按照原样”提供。这些内容并不构成 TI 技术规范, 并且不一定反映 TI 的观点; 请参阅 TI 的 [《使用条款》](#)。

TI E2E™ 在线社区 [TI 的工程师对工程师 \(E2E\) 社区](#)。此社区的创建目的在于促进工程师之间的协作。在 [e2e.ti.com](#) 中, 您可以咨询问题、分享知识、拓展思路并与同行工程师一道帮助解决问题。

设计支持 [TI 参考设计支持](#) 可帮助您快速查找有帮助的 E2E 论坛、设计支持工具以及技术支持的联系信息。

11.4 商标

Eco-mode, E2E are trademarks of Texas Instruments.
All other trademarks are the property of their respective owners.

11.5 静电放电警告



ESD 可能会损坏该集成电路。德州仪器 (TI) 建议通过适当的预防措施处理所有集成电路。如果不遵守正确的处理措施和安装程序, 可能会损坏集成电路。

ESD 的损坏小至导致微小的性能降级, 大至整个器件故障。精密的集成电路可能更容易受到损坏, 这是因为非常细微的参数更改都可能会导致器件与其发布的规格不相符。

11.6 Glossary

[SLYZ022](#) — *TI Glossary*.

This glossary lists and explains terms, acronyms, and definitions.

12 机械、封装和可订购信息

以下页面包含机械、封装和可订购信息。这些信息是指定器件的最新可用数据。数据如有变更, 恕不另行通知和修订此文档。如欲获取此数据表的浏览器版本, 请参阅左侧的导航。

PACKAGING INFORMATION

Orderable Device	Status (1)	Package Type	Package Drawing	Pins	Package Qty	Eco Plan (2)	Lead finish/ Ball material (6)	MSL Peak Temp (3)	Op Temp (°C)	Device Marking (4/5)	Samples
LM3241TLE/NOPB	ACTIVE	DSBGA	YZR	6	250	RoHS & Green	SNAGCU	Level-1-260C-UNLIM	-40 to 85	H	Samples
LM3241TLX/NOPB	ACTIVE	DSBGA	YZR	6	3000	RoHS & Green	SNAGCU	Level-1-260C-UNLIM	-40 to 85	H	Samples

(1) The marketing status values are defined as follows:

ACTIVE: Product device recommended for new designs.

LIFEBUY: TI has announced that the device will be discontinued, and a lifetime-buy period is in effect.

NRND: Not recommended for new designs. Device is in production to support existing customers, but TI does not recommend using this part in a new design.

PREVIEW: Device has been announced but is not in production. Samples may or may not be available.

OBSOLETE: TI has discontinued the production of the device.

(2) **RoHS:** TI defines "RoHS" to mean semiconductor products that are compliant with the current EU RoHS requirements for all 10 RoHS substances, including the requirement that RoHS substance do not exceed 0.1% by weight in homogeneous materials. Where designed to be soldered at high temperatures, "RoHS" products are suitable for use in specified lead-free processes. TI may reference these types of products as "Pb-Free".

RoHS Exempt: TI defines "RoHS Exempt" to mean products that contain lead but are compliant with EU RoHS pursuant to a specific EU RoHS exemption.

Green: TI defines "Green" to mean the content of Chlorine (Cl) and Bromine (Br) based flame retardants meet JS709B low halogen requirements of <=1000ppm threshold. Antimony trioxide based flame retardants must also meet the <=1000ppm threshold requirement.

(3) MSL, Peak Temp. - The Moisture Sensitivity Level rating according to the JEDEC industry standard classifications, and peak solder temperature.

(4) There may be additional marking, which relates to the logo, the lot trace code information, or the environmental category on the device.

(5) Multiple Device Markings will be inside parentheses. Only one Device Marking contained in parentheses and separated by a "~" will appear on a device. If a line is indented then it is a continuation of the previous line and the two combined represent the entire Device Marking for that device.

(6) Lead finish/Ball material - Orderable Devices may have multiple material finish options. Finish options are separated by a vertical ruled line. Lead finish/Ball material values may wrap to two lines if the finish value exceeds the maximum column width.

Important Information and Disclaimer:The information provided on this page represents TI's knowledge and belief as of the date that it is provided. TI bases its knowledge and belief on information provided by third parties, and makes no representation or warranty as to the accuracy of such information. Efforts are underway to better integrate information from third parties. TI has taken and continues to take reasonable steps to provide representative and accurate information but may not have conducted destructive testing or chemical analysis on incoming materials and chemicals. TI and TI suppliers consider certain information to be proprietary, and thus CAS numbers and other limited information may not be available for release.

In no event shall TI's liability arising out of such information exceed the total purchase price of the TI part(s) at issue in this document sold by TI to Customer on an annual basis.

TAPE AND REEL INFORMATION

QUADRANT ASSIGNMENTS FOR PIN 1 ORIENTATION IN TAPE

*All dimensions are nominal

Device	Package Type	Package Drawing	Pins	SPQ	Reel Diameter (mm)	Reel Width W1 (mm)	A0 (mm)	B0 (mm)	K0 (mm)	P1 (mm)	W (mm)	Pin1 Quadrant
LM3241TLE/NOPB	DSBGA	YZR	6	250	178.0	8.4	1.24	1.7	0.76	4.0	8.0	Q1
LM3241TLX/NOPB	DSBGA	YZR	6	3000	178.0	8.4	1.24	1.7	0.76	4.0	8.0	Q1

TAPE AND REEL BOX DIMENSIONS

*All dimensions are nominal

Device	Package Type	Package Drawing	Pins	SPQ	Length (mm)	Width (mm)	Height (mm)
LM3241TLE/NOPB	DSBGA	YZR	6	250	208.0	191.0	35.0
LM3241TLX/NOPB	DSBGA	YZR	6	3000	208.0	191.0	35.0

YZR0006

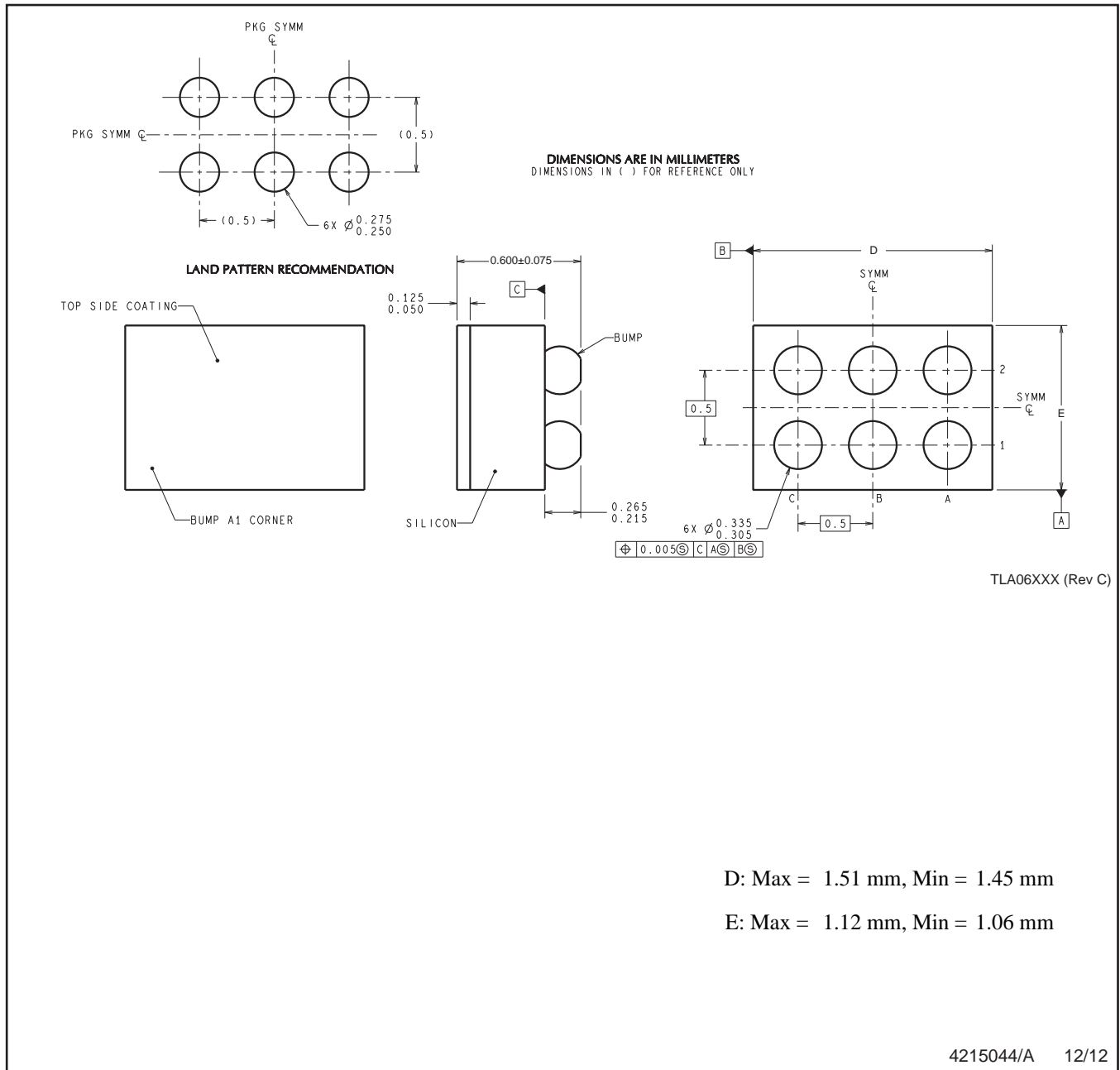

NOTES: A. All linear dimensions are in millimeters. Dimensioning and tolerancing per ASME Y14.5M-1994.
B. This drawing is subject to change without notice.

重要声明和免责声明

TI“按原样”提供技术和可靠性数据（包括数据表）、设计资源（包括参考设计）、应用或其他设计建议、网络工具、安全信息和其他资源，不保证没有瑕疵且不做任何明示或暗示的担保，包括但不限于对适销性、某特定用途方面的适用性或不侵犯任何第三方知识产权的暗示担保。

这些资源可供使用 TI 产品进行设计的熟练开发人员使用。您将自行承担以下全部责任：(1) 针对您的应用选择合适的 TI 产品，(2) 设计、验证并测试您的应用，(3) 确保您的应用满足相应标准以及任何其他功能安全、信息安全、监管或其他要求。

这些资源如有变更，恕不另行通知。TI 授权您仅可将这些资源用于研发本资源所述的 TI 产品的应用。严禁对这些资源进行其他复制或展示。您无权使用任何其他 TI 知识产权或任何第三方知识产权。您应全额赔偿因在这些资源的使用中对 TI 及其代表造成的任何索赔、损害、成本、损失和债务，TI 对此概不负责。

TI 提供的产品受 [TI 的销售条款](#) 或 [ti.com](#) 上其他适用条款/TI 产品随附的其他适用条款的约束。TI 提供这些资源并不会扩展或以其他方式更改 TI 针对 TI 产品发布的适用的担保或担保免责声明。

TI 反对并拒绝您可能提出的任何其他或不同的条款。

邮寄地址：Texas Instruments, Post Office Box 655303, Dallas, Texas 75265

Copyright © 2022，德州仪器 (TI) 公司