

具有接收信号强度指示器 (RSSI) 的 11.3Gbps 限幅互阻抗放大器

查询样片: [ONET8551T](#)

特性

- **9GHz** 带宽
- **10k Ω** 差分小信号互阻
- **-20dBm** 灵敏度
- **0.9 μ A_{RMS}** 输入引入噪声
- **2.5mA_{p-p}** 输入过载电流
- 接收信号强度指示 (**RSSI**)
- **92mW** 典型功率耗散
- 支持片上 **50 Ω** 背向端接的电流模式逻辑 (**CML**) 数据输出
- 片上电源滤波电容器
- **+3.3V** 单电源
- 芯片尺寸: **870 μ m x 1036 μ m**

应用范围

- **10G** 以太网
- **8G** 和 **10G** 光纤通道
- **10G** 以太无源光网络 (**EPON**)
- 同步光网络 (**SONET**) **OC-192**
- **6G** 和 **10G** 通用公共无线接口 (**CPRI**) 和开放基站架构协议 (**OBSAI**)
- 光电二极管 (**PIN**) 和雪崩光电二极管 (**APD**) 预放大器接收器

说明

ONET8551T 是一款高速、高增益、限幅互阻抗放大器，此放大器用在数据传输速率高达 11.3 Gbps 的光接收器中。它特有低输入引入噪声，9GHz 带宽，10k Ω 小信号互阻，和一个接收信号强度指示器 (RSSI)。

ONET8551T 器件以芯片形式提供，其中包括一个片上 VCC 旁路电容器，并且针对晶体管型外壳结构 (TO can) 封装进行了优化。

ONET8551T 器件需要一个 +3.3V 单电源。功效设计的功率耗散通常少于 95mW。该器件可在 -40°C 至 100°C 外壳 (IC 在背面) 环境下工作。



Please be aware that an important notice concerning availability, standard warranty, and use in critical applications of Texas Instruments semiconductor products and disclaimers thereto appears at the end of this data sheet.



This integrated circuit can be damaged by ESD. Texas Instruments recommends that all integrated circuits be handled with appropriate precautions. Failure to observe proper handling and installation procedures can cause damage.

ESD damage can range from subtle performance degradation to complete device failure. Precision integrated circuits may be more susceptible to damage because very small parametric changes could cause the device not to meet its published specifications.

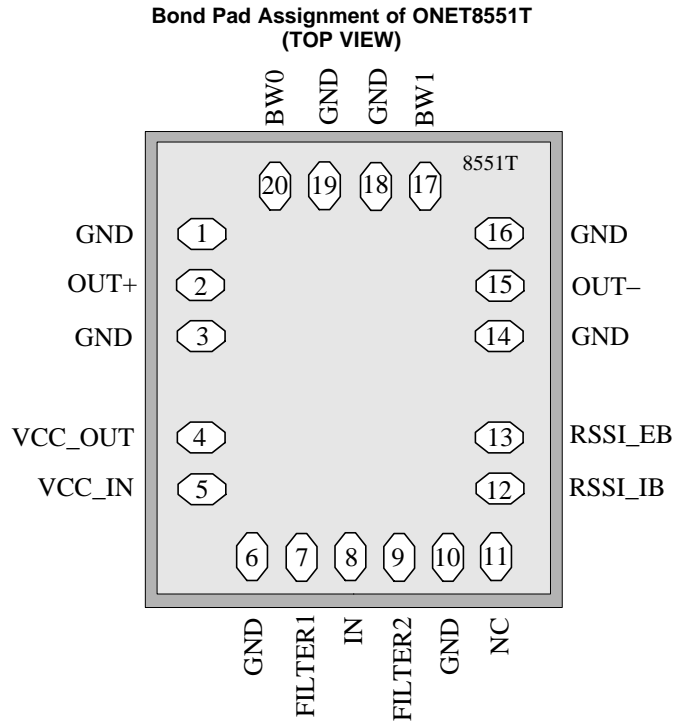

Figure 1. The ONET8551T is available in die form. Bond pad locations are shown in this top view.

Table 1. BOND PAD DESCRIPTION

Pad	Symbol	Type	Description
1, 3, 6, 10, 14, 16, 18, 19	GND	Supply	Circuit ground. All GND pads are connected on die. Bonding all pads is optional. However, for optimum performance, a good ground connection is mandatory.
2	OUT+	Analog output	Non-inverted CML data output; on-chip 50-Ω back-terminated to V _{CC}
4	VCC_OUT	Supply	2.8-V to 3.63-V supply voltage for AGC amplifier
5	VCC_IN	Supply	2.8-V to 3.63-V supply voltage for input TIA stage
7, 9	FILTER	Analog	Bias voltage for photodiode cathode
8	IN	Analog input	Data input to TIA (photodiode anode)
11	NC	No connect	Do not connect
12	RSSI_IB	Analog output	Analog output current is proportional to the input data amplitude. It indicates the strength of the received signal (RSSI), if the photodiode is biased from the TIA. Connected to an external resistor to ground (GND). For proper operation, ensure that the voltage at the RSSI pad does not exceed V _{CC} – 0.65 V. Leave this pad open if the RSSI feature is not used.
13	RSSI_EB	Analog output	Optional use when operated with external PD bias (e.g. APD). Analog output current proportional to the input data amplitude. Indicates the strength of the received signal (RSSI). Connected to an external resistor to ground (GND). For proper operation, ensure that the voltage at the RSSI pad does not exceed V _{CC} – 0.65 V. Leave this pad open if the RSSI feature is not used.
15	OUT–	Analog output	Inverted CML data output; on-chip 50-Ω back-terminated to V _{CC} .
17	BW1	Digital input	Bandwidth adjustment. Ground the pad to increase the bandwidth. Internally pulled-up to V _{CC} .
20	BW0	Digital input	Bandwidth adjustment. Ground the pad to increase the bandwidth. Internally pulled-up to V _{CC} .
Back-side of die	GND	Supply	Conductive epoxy must be used to attach the die to ground.

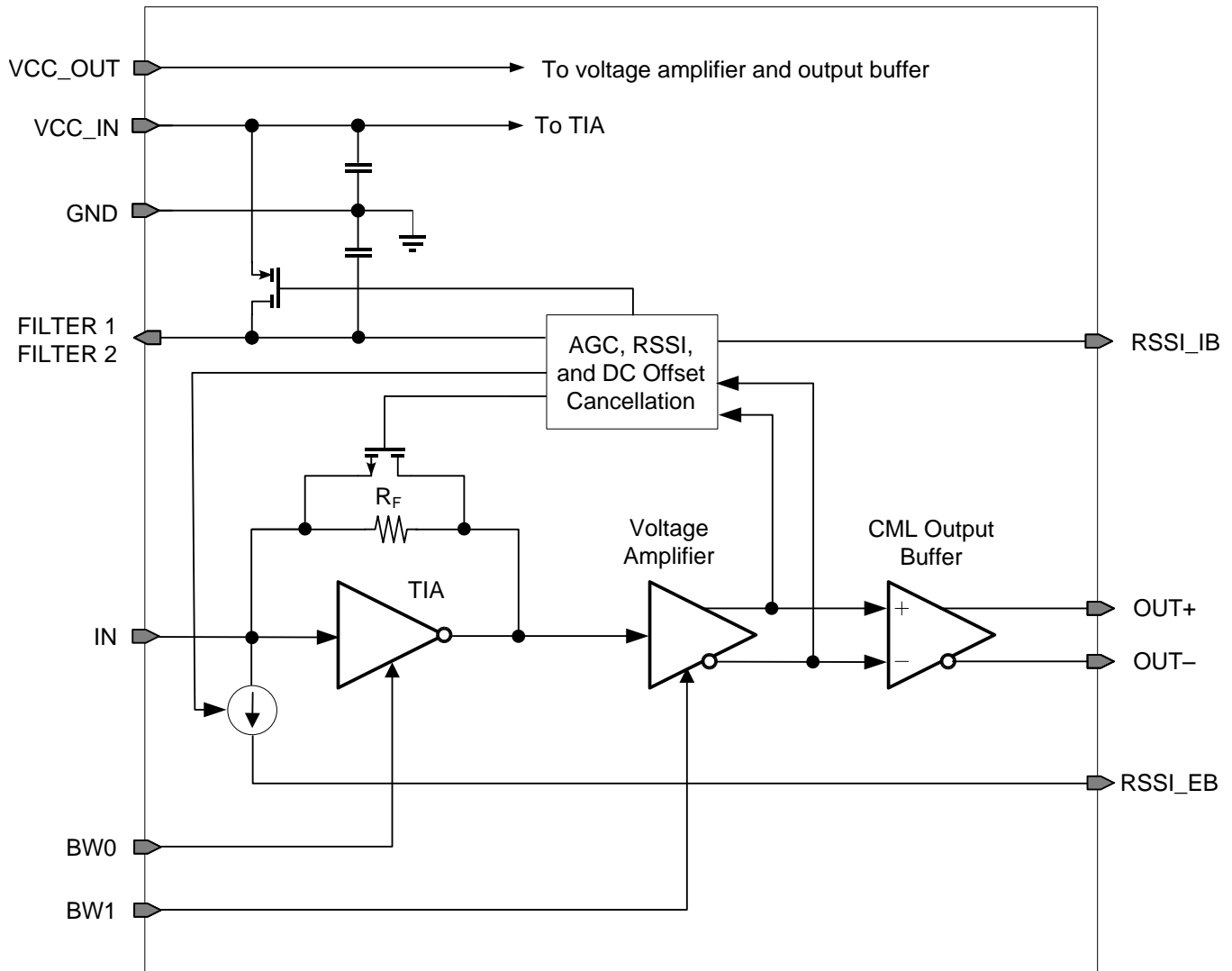

Figure 2. Simplified Block Diagram of the ONET8551T Device

Figure 2 shows a simplified block diagram of the ONET8551T device.

The ONET8551T device consists of the signal path, supply filters, a control block for DC input bias, automatic gain control (AGC), and received signal strength indication (RSSI). The RSSI provides the bias for the TIA stage and the control for the AGC.

The signal path consists of a transimpedance amplifier stage, a voltage amplifier, and a CML output buffer. The on-chip filter circuit provides a filtered VCC for the PIN photodiode and for the transimpedance amplifier.

The DC input bias circuit and automatic gain control use internal low pass filters to cancel the DC current on the input and to adjust the transimpedance amplifier gain. Furthermore, circuitry is provided to monitor the received signal strength.

ABSOLUTE MAXIMUM RATINGS

Over operating free-air temperature range (unless otherwise noted)⁽¹⁾

		VALUE		UNIT
		MIN	MAX	
V_{CC_IN} , V_{CC_OUT}	Supply voltage ⁽²⁾	-0.3	4.0	V
V_{BW0} , V_{BW1} , $V_{FILTER1}$, $V_{FILTER2}$, V_{OUT+} , V_{OUT-} , V_{RSSI_IB} , V_{RSSI_EB}	Voltage at BW0, BW1, FILTER1, FILTER2, OUT+, OUT-, RSSI_IB, and RSSI_EB ⁽²⁾	-0.3	4.0	
I_{IN}	Current into IN	-0.7	4.0	mA
I_{FILTER}	Current into FILTER1 and FILTER2	-8	8	
I_{OUT+} , I_{OUT-}	Continuous current at outputs	-8	8	
ESD	ESD rating at all pins except input IN	2		kV (HBM)
	ESD rating at input IN	0.5		
T_J	Maximum junction temperature		125	°C

- (1) Stresses beyond those listed under “absolute maximum ratings” may cause permanent damage to the device. These are stress ratings only and functional operation of the device at these or any other conditions beyond those indicated under “recommended operating conditions” is not implied. Exposure to absolute–maximum–rated conditions for extended periods may affect device reliability.
- (2) All voltage values are with respect to network ground terminal.

RECOMMENDED OPERATING CONDITIONS

Over operating free-air temperature range (unless otherwise noted)

		MIN	NOM	MAX	UNIT
V_{CC}	Supply voltage	2.80	3.3	3.63	V
T_A	Operating back-side die temperature	-40		100 ⁽¹⁾	°C
L_{FILTER} , L_{IN}	Wire-bond inductance at pins FILTER _i and IN		0.3	0.5	nH
C_{PD}	Photodiode capacitance		0.2		pF

- (1) 105°C max junction temperature.

DC ELECTRICAL CHARACTERISTICS

Over recommended operating conditions with BW0 = GND and BW1 = Open (unless otherwise noted). Typical values are at $V_{CC} = +3.3\text{ V}$ and $T_A = 25^\circ\text{C}$.

PARAMETER		TEST CONDITIONS	MIN	TYP	MAX	UNIT
V_{CC}	Supply voltage		2.80	3.3	3.63	V
I_{VCC}	Supply current	Input current $I_{IN} < 1000\ \mu\text{A}_{P-P}$		28	40 ⁽¹⁾	mA
I_{VCC}	Supply current	Input current $I_{IN} < 2500\ \mu\text{A}_{P-P}$			45 ⁽¹⁾	mA
V_{IN}	Input bias voltage		0.75	0.85	0.98	V
R_{OUT}	Output resistance	Single-ended to V_{CC}	40	50	60	Ω
V_{FILTER}	Photodiode bias voltage ⁽²⁾		2.55	3.2		V
A_{RSSI_IB}	RSSI gain internal bias	Resistive load to GND ⁽³⁾	0.49	0.51	0.54	A/A
	RSSI internal bias output offset current (no light)		0	0.9	2.5	μA
A_{RSSI_EB}	RSSI gain external bias	Resistive load to GND ⁽³⁾	0.46		0.63	A/A
	RSSI external bias output offset current (no light)			25		μA

(1) Including RSSI current

(2) Regulated voltage typically 100 mV lower than V_{CC} .

(3) The RSSI output is a current output, which requires a resistive load to ground (GND). The voltage gain can be adjusted for the intended application by choosing the external resistor. However, for proper operation, ensure that the voltage at RSSI does not exceed $V_{CC} - 0.65\text{ V}$.

AC ELECTRICAL CHARACTERISTICS

Over recommended operating conditions with BW0 = GND and BW1 = Open (unless otherwise noted). Typical values are at $V_{CC} = +3.3\text{ V}$ and $T_A = 25^\circ\text{C}$.

PARAMETER		TEST CONDITIONS	MIN	TYP	MAX	UNIT
Z_{21}	Small signal transimpedance	Differential output; Input current $i_{IN} = 20\ \mu\text{A}_{P-P}$	7500	10000		Ω
$f_{HSS, 3dB}$	Small signal bandwidth	$i_{IN} = 20\ \mu\text{A}_{P-P}$ ⁽¹⁾	7	9		GHz
$f_{L, 3dB}$	Low frequency –3-dB bandwidth	$16\ \mu\text{A}_{P-P} < i_{IN} < 2000\ \mu\text{A}_{P-P}$		30	150	kHz
$i_{N, IN}$	Input referred RMS noise	10-GHz bandwidth ⁽²⁾		0.9	1.4	μA
S_{US}	Unstressed sensitivity electrical	10.3125 Gbps, PRBS31 pattern, 1310 nm, extinction ratio > 9 dB, BER 10^{-12}		-20		dBm
DJ	Deterministic jitter	$25\ \mu\text{A}_{P-P} < i_{IN} < 500\ \mu\text{A}_{P-P}$ (10.3125 Gbps, K28.5 pattern)		6	15	ps _{P-P}
		$500\ \mu\text{A}_{P-P} < i_{IN} < 2500\ \mu\text{A}_{P-P}$ (10.3125 Gbps, K28.5 pattern)		10	24	
$V_{OUT, D, MAX}$	Maximum differential output voltage	Input current $i_{IN} = 500\ \mu\text{A}_{P-P}$	180	300	420	mV _{P-P}
PSNR	Power supply noise rejection	$F < 10\text{ MHz}$ ⁽³⁾ , supply filtering according to SFF8431		-15		dB

(1) The small signal bandwidth is specified over process corners, temperature, and supply voltage variation. The assumed photodiode capacitance is 0.2 pF and the bond-wire inductance is 0.3 nH. The small signal bandwidth strongly depends on environmental parasitics. Careful attention to layout parasitics and external components is necessary to achieve optimal performance.

(2) Input referred RMS noise is (RMS output noise) divided by (gain at 100 MHz).

(3) PSNR is the differential output amplitude divided by the voltage ripple on supply. No input current at IN.

DETAILED DESCRIPTION

SIGNAL PATH

The first stage of the signal path is a transimpedance amplifier, which converts the photodiode current into a voltage. If the input signal current exceeds a certain value, the transimpedance gain is reduced by a nonlinear AGC circuit to limit the signal amplitude.

The second stage is a limiting voltage amplifier that provides additional limiting gain and converts the single-ended input voltage into a differential data signal. The output stage provides CML outputs with an on-chip 50- Ω back-termination to V_{CC} .

FILTER CIRCUITRY

The FILTER pins provide a regulated and filtered VCC for a PIN photodiode bias. The supply voltages for the transimpedance amplifier are filtered by on-chip capacitors, thus an external supply filter capacitor is not necessary. The input stage has a separate VCC supply (V_{CC_IN}), which is not connected on chip to the supply of the limiting and CML stages (V_{CC_OUT}).

AGC AND RSSI

The voltage drop across the regulated FILTER FET is monitored by the bias and RSSI control circuit block in the case where a PIN diode is biased using the FILTER pins.

If the DC input current exceeds a certain level, then it is partially cancelled by a controlled current source. This process keeps the transimpedance amplifier stage within sufficient operating limits for optimum performance.

The automatic gain control circuitry adjusts the voltage gain of the AGC amplifier to ensure limiting behavior of the complete amplifier.

Finally this circuit block senses the current through the FILTER FET and generates a mirrored current that is proportional to the input signal strength. The mirrored current is available at the RSSI_IB output and can be sunk to GND using an external resistor. For proper operation, ensure that the voltage at the RSSI_IB pad does not exceed $V_{CC} - 0.65$ V.

If an APD or PIN photodiode is used with an external bias, then the RSSI_EB pin can be used. However, for greater accuracy under external photodiode biasing conditions, TI recommends deriving the RSSI from the external bias circuitry.

APPLICATION INFORMATION

Figure 3 shows the ONET8551T device used in a typical fiber optic receiver with the internal photodiode bias. The ONET8551T device converts the electrical current generated by the PIN photodiode into a differential output voltage. The FILTER output provides a low-pass filtered DC bias voltage for the PIN. The photodiode must be connected to the FILTER pad for the bias to function correctly, because the bias circuit senses and uses the voltage drop across the FET.

The RSSI output is used to mirror the photodiode output current and can be connected via a resistor to GND. The voltage gain can be adjusted for the intended application by choosing the external resistor. However, for proper operation of the ONET8551T, ensure that the voltage at RSSI never exceeds $V_{CC} - 0.65$ V. Leave the RSSI output open, if the RSSI output is not used while operating with internal PD bias.

The OUT+ and OUT- pins are internally terminated by 50- Ω pullup resistors to VCC. The outputs must be AC coupled, for example by using 0.1- μ F capacitors, to the succeeding device.

For PIN diode applications, TI recommends grounding the BW0 pin. However, for higher bandwidth, the BW1 pin, or both the BW0 and BW1 pins, can be grounded. To reduce the bandwidth, the BW0 and BW1 pins can be left open.

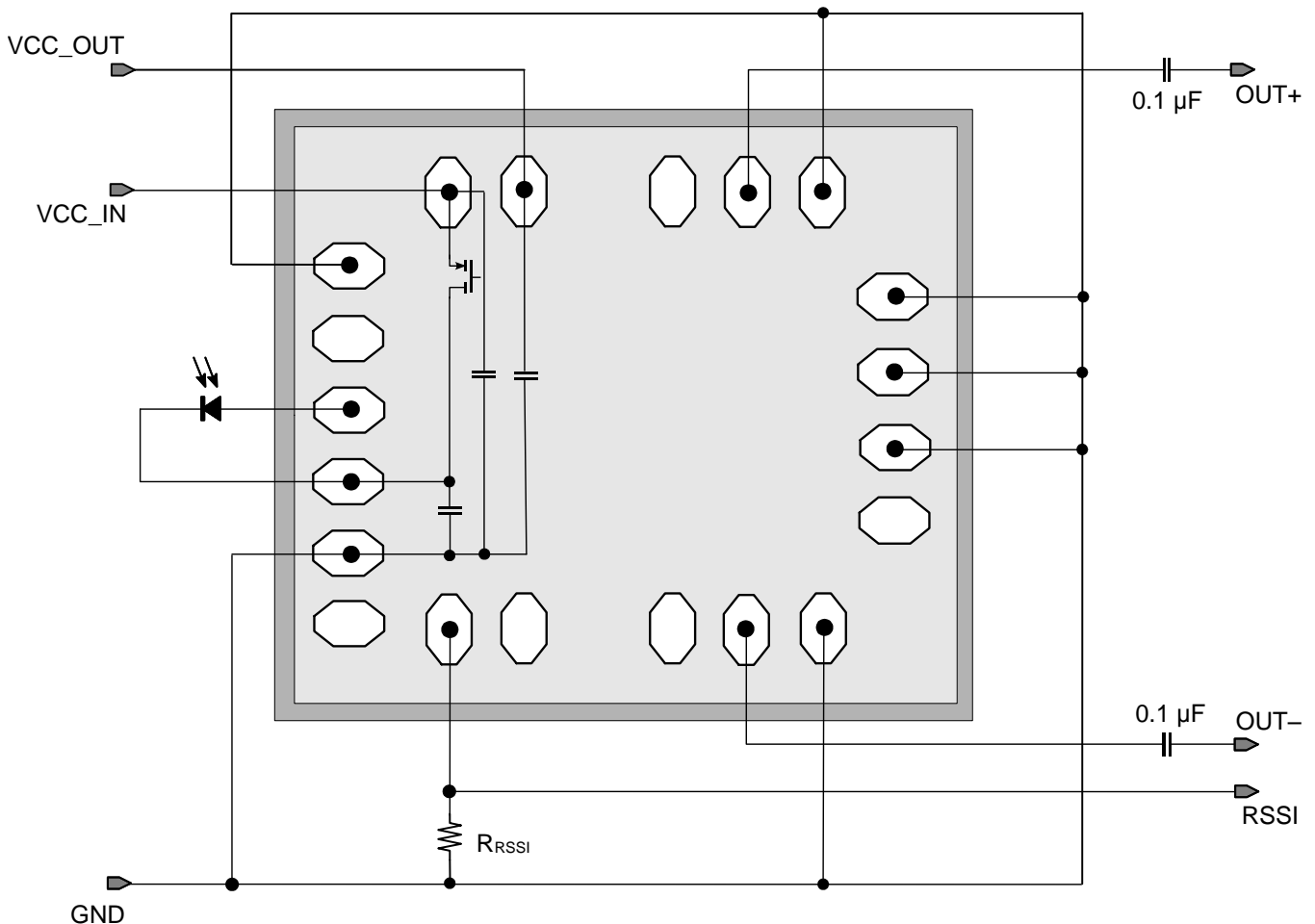

Figure 3. Basic Application Circuit for PIN Receivers

Figure 4 shows the ONET8551T device used in a typical fiber-optic receiver using an external photodiode bias for an avalanche photodiode. To increase the bandwidth using APDs, ground the BW0 and BW1 pins. This configuration can also be used for a PIN diode. However, it may be beneficial to reduce the bandwidth, and therefore the noise, by grounding only the BW0 pin. The external bias RSSI signal is based on the DC offset value and is not as accurate as the internal bias RSSI, which is based on the photodiode current.

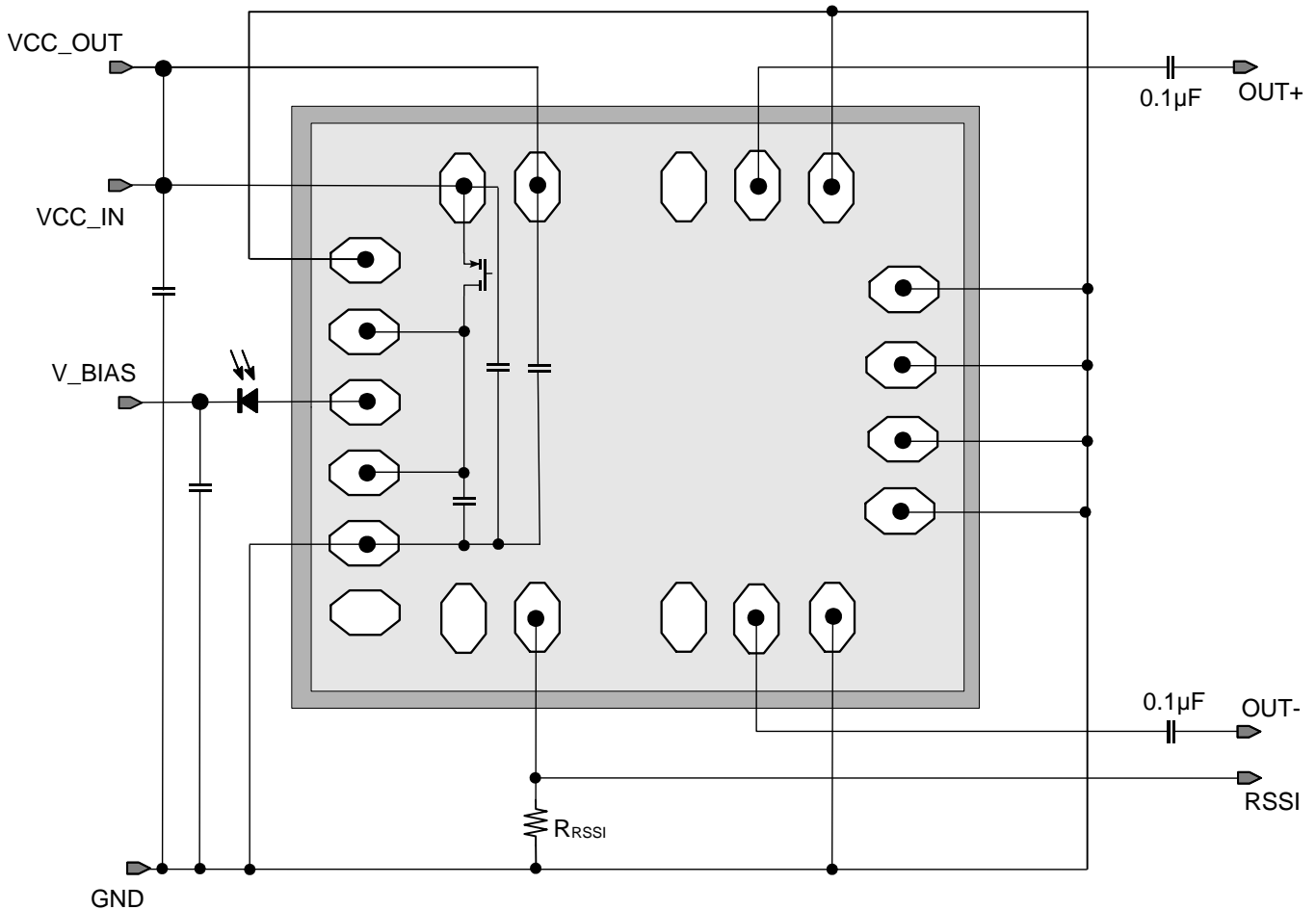

Figure 4. Basic Application Circuit for APD Receivers

DEVICE INFORMATION

ASSEMBLY RECOMMENDATIONS

Careful attention to assembly parasitics and external components is necessary to achieve optimal performance. Recommendations that optimize performance include:

- Minimize the total capacitance on the IN pad by using a low capacitance photodiode and paying attention to stray capacitances. Place the photodiode close to the ONET8551T die in order to minimize the bond wire length, and thus the parasitic inductance.
- Use identical termination and symmetrical transmission lines at the AC coupled differential output pins, OUT+ and OUT-.
- Use short bond wire connections for the supply terminals VCC_IN, VCC_OUT, and GND. Supply voltage filtering is provided on chip, but filtering may be improved by using an additional external capacitor.
- The die has back-side metal. Conductive epoxy must be used to attach the die to ground.

CHIP DIMENSIONS AND PAD LOCATIONS

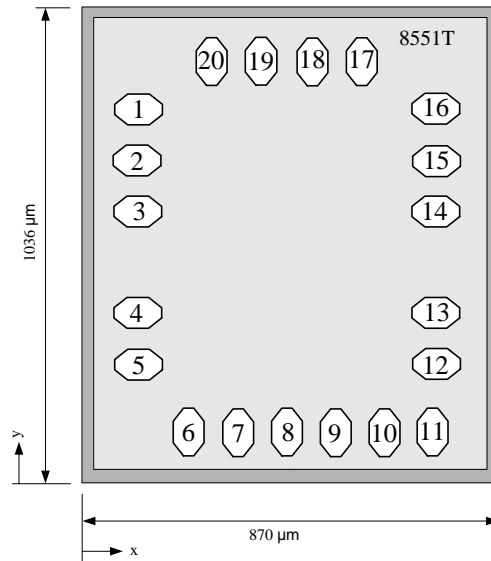

Figure 5. Die Thickness: $203 \pm 13 \mu\text{m}$, Pad Dimensions: $105 \mu\text{m} \times 65 \mu\text{m}$, and Die Size: $870 \pm 40 \mu\text{m} \times 1036 \pm 40 \mu\text{m}$

PAD	COORDINATES (Referenced to Pad 1)		SYMBOL	TYPE	DESCRIPTION
	x (μm)	y (μm)			
1	0	0	GND	Supply	Circuit ground
2	0	-115	OUT+	Analog output	Non-inverted data output
3	0	-230	GND	Supply	Circuit ground
4	0	-460	VCC_OUT	Supply	3.3-V supply voltage
5	0	-575	VCC_IN	Supply	3.3-V supply voltage
6	116	-728	GND	Supply	Circuit ground
7	226	-728	FILTER1	Analog output	Bias voltage for photodiode
8	336	-728	IN	Analog input	Data input to TIA
9	446	-728	FILTER2	Analog output	Bias voltage for photodiode
10	556	-728	GND	Supply	Circuit ground
11	666	-728	NC	No connect	Do not connect
12	671	-575	RSSI_IB	Analog output	RSSI output signal for internally biased receivers
13	671	-460	RSSI_EB	Analog output	RSSI output signal for externally biased receivers
14	671	-230	GND	Supply	Circuit ground
15	671	-115	OUT-	Analog output	Inverted data output
16	671	0	GND	Supply	Circuit ground
17	508	109	BW1	Digital input	Bandwidth adjustment
18	393	109	GND	Supply	Circuit ground
19	278	109	GND	Supply	Circuit ground
20	163	109	BW0	Digital input	Bandwidth adjustment

TO46 LAYOUT EXAMPLE

Figure 6 shows an example of a layout using a ground-signal-ground (GSG) type PIN photodiode in a 5-pin TO46 can. Figure 7 shows an example of a PIN photodiode with two contacts on the top-side.

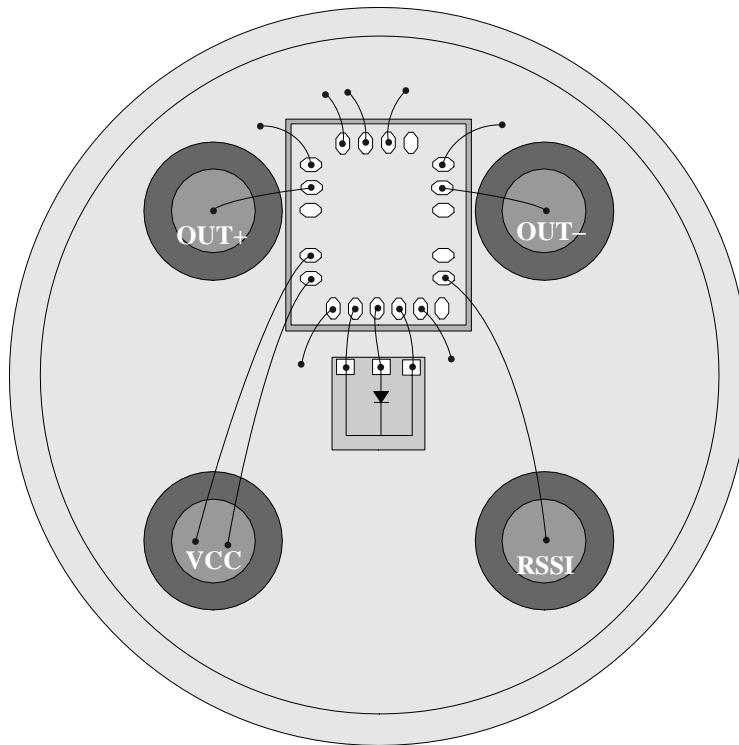

Figure 6. TO46 5-Pin Layout Using the ONET8551T With a GSG PIN Diode

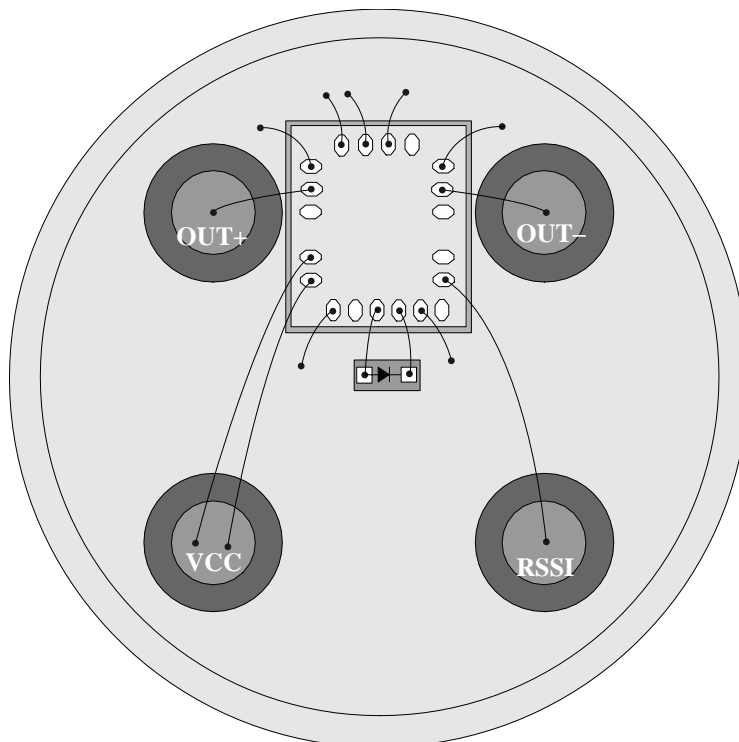

Figure 7. TO46 5-Pin Layout Using the ONET8551T With a Two-Contact PIN Diode

Figure 8 shows an example of a layout using an external bias voltage for the photodiode in a 5-pin TO46 can. Figure 9 shows an example with a back-side cathode contact photodiode using the internal bias voltage.

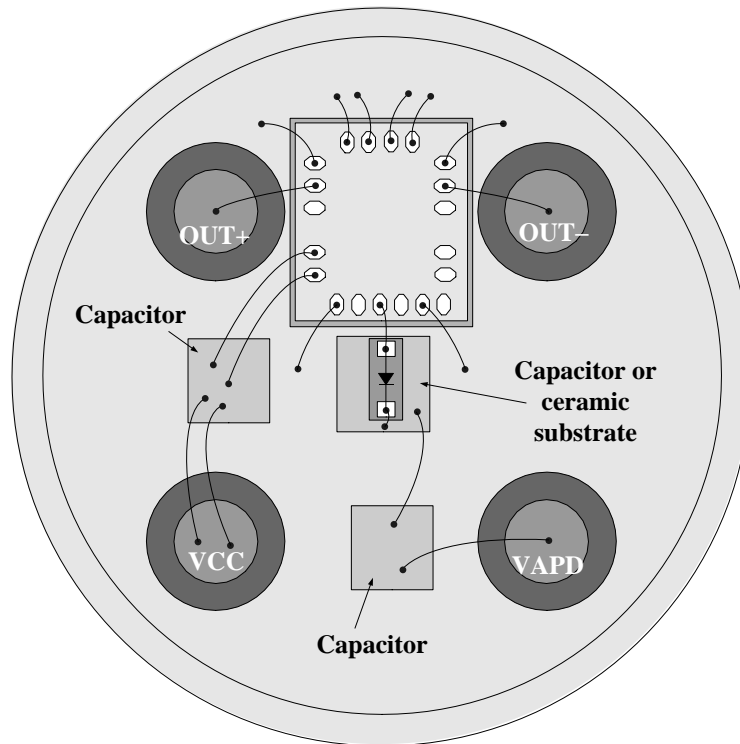

Figure 8. TO46 5-Pin Layout Using the ONET8551T With an Avalanche Photodiode

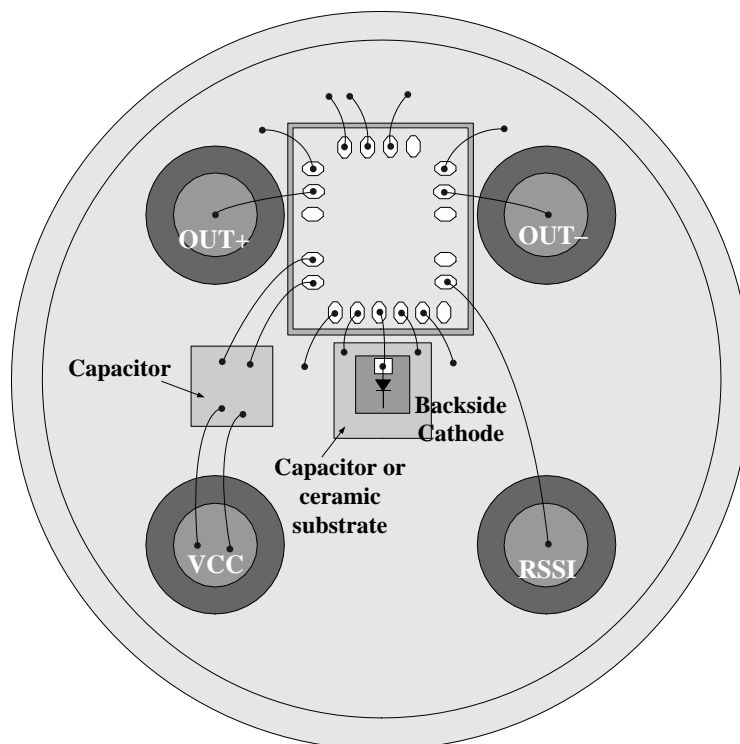
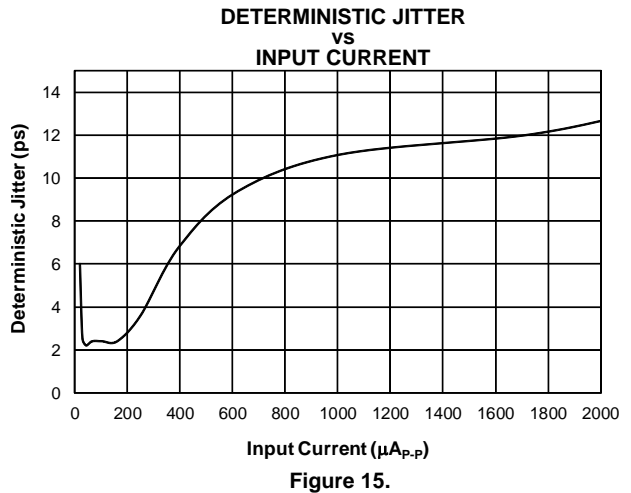
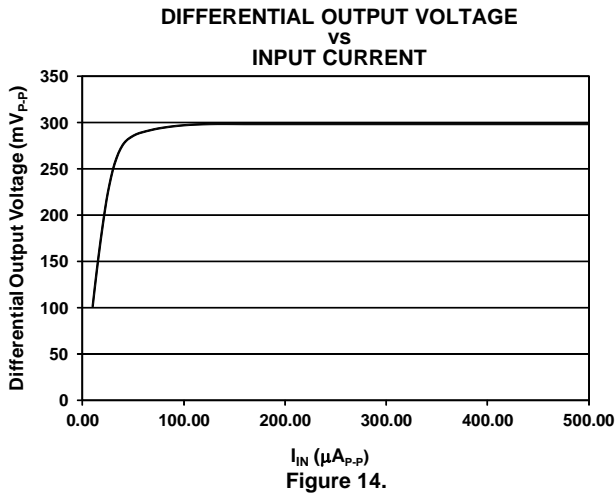
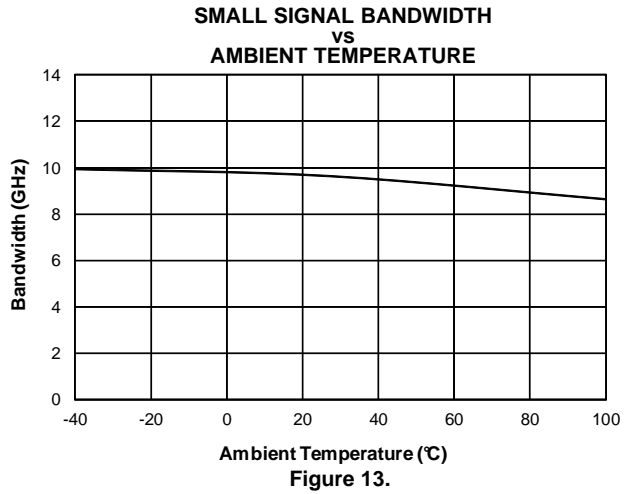
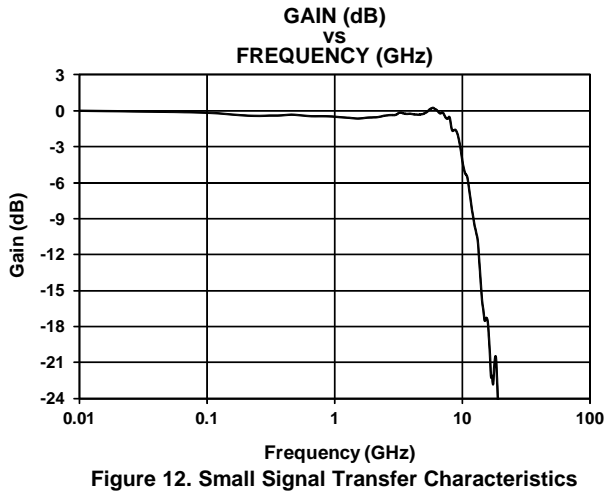
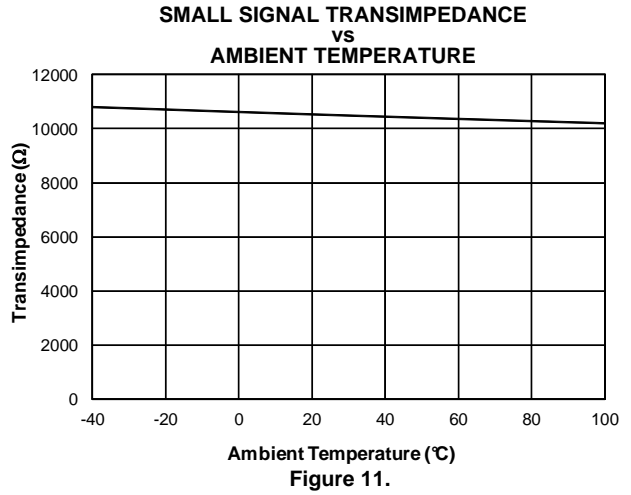
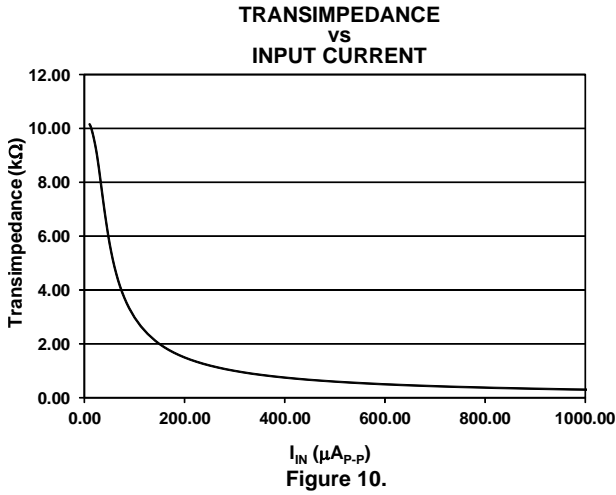

Figure 9. TO46 5-Pin Layout Using the Internal Bias Voltage for a Back-Side Cathode Contact Photodiode

TYPICAL OPERATION CHARACTERISTICS

Typical operating condition is at $V_{CC} = +3.3\text{ V}$ and $T_A = +25^\circ\text{C}$ (unless otherwise noted).



TYPICAL OPERATION CHARACTERISTICS (continued)

Typical operating condition is at $V_{CC} = +3.3\text{ V}$ and $T_A = +25^\circ\text{C}$ (unless otherwise noted).

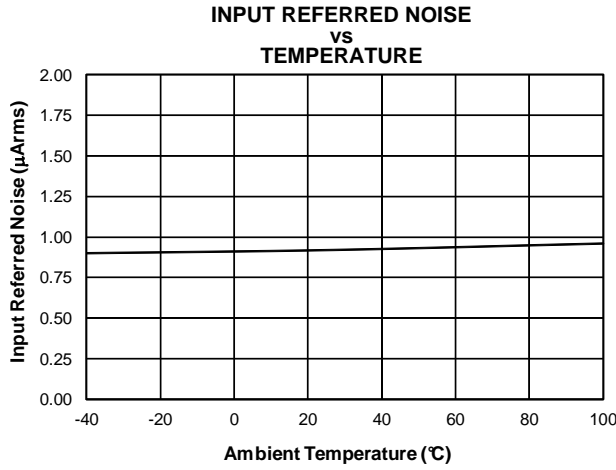

Figure 16.

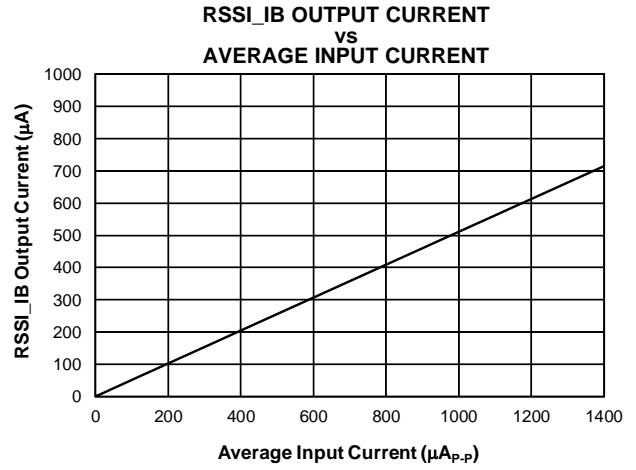
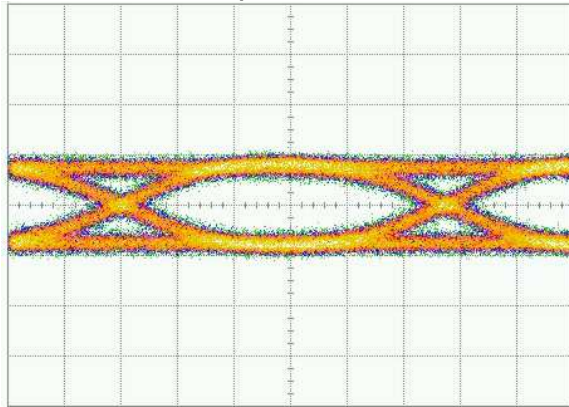

Figure 17.

**OUTPUT EYE-DIAGRAM AT 10.3 GBPS
AND 20 µA_{p-p} INPUT CURRENT**



100 mV/Div 16.8 ps/Div

Figure 18.

**OUTPUT EYE-DIAGRAM AT 10.3 GBPS
AND 100 µA_{p-p} INPUT CURRENT**

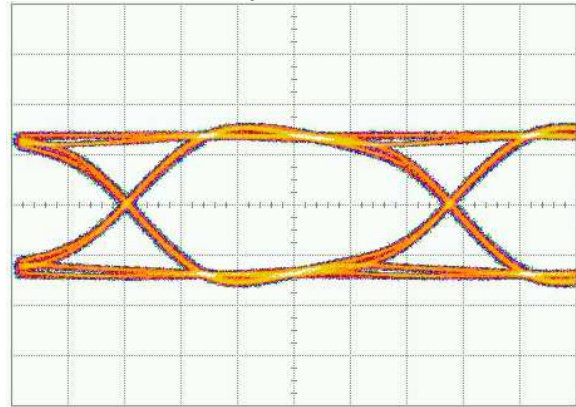

100 mV/Div 16.8 ps/Div

Figure 19.

**OUTPUT EYE-DIAGRAM AT 10.3 GBPS
AND 500 µA_{p-p} INPUT CURRENT**

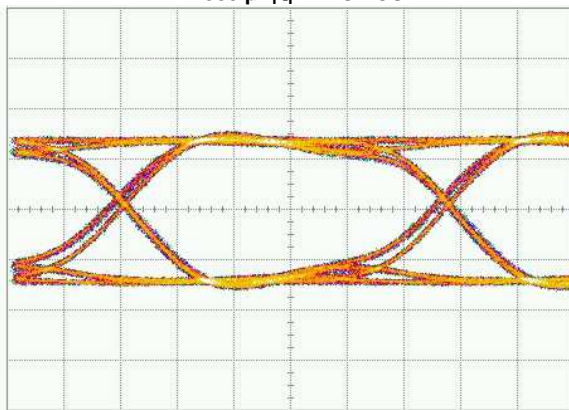

100 mV/Div 16.8 ps/Div

Figure 20.

**OUTPUT EYE-DIAGRAM AT 10.3 GBPS
AND 2 mA_{p-p} INPUT CURRENT**

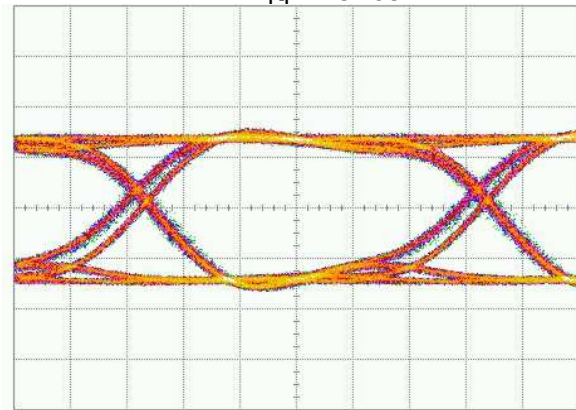

100 mV/Div 16.8 ps/Div

Figure 21.

PACKAGING INFORMATION

Orderable Device	Status (1)	Package Type	Package Drawing	Pins	Package Qty	Eco Plan (2)	Lead/Ball Finish (6)	MSL Peak Temp (3)	Op Temp (°C)	Device Marking (4/5)	Samples
ONET8551TY	ACTIVE	DIESALE	Y	0	1800	TBD	Call TI	Call TI	-40 to 100		Samples
ONET8551TYS4	ACTIVE	WAFERSALE	YS	0	1	TBD	Call TI	Call TI	-40 to 100		Samples
ONET8551TYS9	ACTIVE	WAFERSALE	YS	0	1	TBD	Call TI	Call TI	-40 to 100		Samples

(1) The marketing status values are defined as follows:

ACTIVE: Product device recommended for new designs.

LIFEBUY: TI has announced that the device will be discontinued, and a lifetime-buy period is in effect.

NRND: Not recommended for new designs. Device is in production to support existing customers, but TI does not recommend using this part in a new design.

PREVIEW: Device has been announced but is not in production. Samples may or may not be available.

OBsolete: TI has discontinued the production of the device.

(2) **RoHS:** TI defines "RoHS" to mean semiconductor products that are compliant with the current EU RoHS requirements for all 10 RoHS substances, including the requirement that RoHS substance do not exceed 0.1% by weight in homogeneous materials. Where designed to be soldered at high temperatures, "RoHS" products are suitable for use in specified lead-free processes. TI may reference these types of products as "Pb-Free".

RoHS Exempt: TI defines "RoHS Exempt" to mean products that contain lead but are compliant with EU RoHS pursuant to a specific EU RoHS exemption.

Green: TI defines "Green" to mean the content of Chlorine (Cl) and Bromine (Br) based flame retardants meet JS709B low halogen requirements of <=1000ppm threshold. Antimony trioxide based flame retardants must also meet the <=1000ppm threshold requirement.

(3) MSL, Peak Temp. - The Moisture Sensitivity Level rating according to the JEDEC industry standard classifications, and peak solder temperature.

(4) There may be additional marking, which relates to the logo, the lot trace code information, or the environmental category on the device.

(5) Multiple Device Markings will be inside parentheses. Only one Device Marking contained in parentheses and separated by a "-" will appear on a device. If a line is indented then it is a continuation of the previous line and the two combined represent the entire Device Marking for that device.

(6) Lead/Ball Finish - Orderable Devices may have multiple material finish options. Finish options are separated by a vertical ruled line. Lead/Ball Finish values may wrap to two lines if the finish value exceeds the maximum column width.

Important Information and Disclaimer: The information provided on this page represents TI's knowledge and belief as of the date that it is provided. TI bases its knowledge and belief on information provided by third parties, and makes no representation or warranty as to the accuracy of such information. Efforts are underway to better integrate information from third parties. TI has taken and continues to take reasonable steps to provide representative and accurate information but may not have conducted destructive testing or chemical analysis on incoming materials and chemicals. TI and TI suppliers consider certain information to be proprietary, and thus CAS numbers and other limited information may not be available for release.

In no event shall TI's liability arising out of such information exceed the total purchase price of the TI part(s) at issue in this document sold by TI to Customer on an annual basis.

重要声明和免责声明

TI 均以“原样”提供技术性及其可靠性数据（包括数据表）、设计资源（包括参考设计）、应用或其他设计建议、网络工具、安全信息和其他资源，不保证其中不含任何瑕疵，且不做任何明示或暗示的担保，包括但不限于对适销性、适合某特定用途或不侵犯任何第三方知识产权的暗示担保。

所述资源可供专业开发人员应用TI 产品进行设计使用。您将对以下行为独自承担全部责任：(1) 针对您的应用选择合适的TI 产品；(2) 设计、验证并测试您的应用；(3) 确保您的应用满足相应标准以及任何其他安全、安保或其他要求。所述资源如有变更，恕不另行通知。TI 对您使用所述资源的授权仅限于开发资源所涉及TI 产品的相关应用。除此之外不得复制或展示所述资源，也不提供其它TI 或任何第三方的知识产权授权许可。如因使用所述资源而产生任何索赔、赔偿、成本、损失及债务等，TI 对此概不负责，并且您须赔偿由此对TI 及其代表造成的损害。

TI 所提供产品均受TI 的销售条款 (<http://www.ti.com.cn/zh-cn/legal/termsofsale.html>) 以及ti.com.cn上或随附TI产品提供的其他可适用条款的约束。TI提供所述资源并不扩展或以其他方式更改TI 针对TI 产品所发布的可适用的担保范围或担保免责声明。

邮寄地址：上海市浦东新区世纪大道 1568 号中建大厦 32 楼，邮政编码：200122
Copyright © 2019 德州仪器半导体技术（上海）有限公司