

## LF412-N-MIL 低偏移、低漂移双路 JFET 输入运算放大器

### 1 特性

- 内部修整偏移电压: 1mV (最大值)
- 输入偏移电压漂移: 7 $\mu$ V/°C (典型值)
- 低输入偏置电流: 50pA
- 低输入噪声电流: 0.01pA/ $\sqrt{\text{Hz}}$
- 宽增益带宽: 3MHz (最小值)
- 高转换率: 10V/ $\mu$ s (最小值)
- 低电源电流: 1.8mA/放大器
- 高输入阻抗: 10<sup>12</sup> $\Omega$
- 低总谐波失真:  $\leq 0.02\%$
- 低 1/f 噪声转角点: 50Hz
- 0.01% 精度的快速趋稳时间: 2 $\mu$ s

### 2 应用

- 高速集成器
- 高速 D/A 转换器
- 采样和保持电路

### 3 说明

这些器件是低成本、高速度的 JFET 输入运算放大器，具有极低的输入偏移电压和输入偏移电压漂移。它们需要低电源电流，但能够保持较大的增益带宽乘积和快速的转换速率。此外，匹配良好的高电压 JFET 输入器件可提供极低的输入偏置和偏移电流。LF412-N-MIL 双引脚与 LM1558 兼容，使设计人员能够立即升级现有设计的整体性能。

这些放大器可用于多种应用，如高速积分器、快速 D/A 转换器、采样和保持电路，以及许多其他需要低输入偏移电压和漂移、低输入偏置电流、高输入阻抗、高转换速率和宽带宽。

#### 器件信息<sup>(1)</sup>

器件型号	封装	封装尺寸 (标称值)
LF412-N-MIL	PDIP (8)	9.59mm x 6.35mm
	TO (8)	直径 9.14mm

(1) 如需了解所有可用封装，请参阅数据表末尾的可订购产品附录。

#### 反向放大器

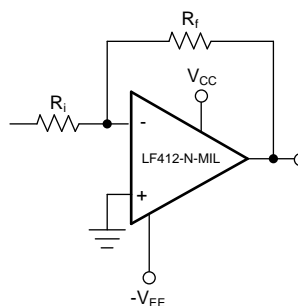

Copyright © 2017, Texas Instruments Incorporated



## 目录

<b>1</b>	特性 .....	1	7.3	Feature Description .....	12
<b>2</b>	应用 .....	1	7.4	Device Functional Modes .....	13
<b>3</b>	说明 .....	1	<b>8</b>	<b>Application and Implementation .....</b>	<b>14</b>
<b>4</b>	修订历史记录 .....	2	8.1	Application Information .....	14
<b>5</b>	<b>Pin Configuration and Functions .....</b>	<b>3</b>	8.2	Typical Application .....	14
<b>6</b>	<b>Specifications .....</b>	<b>4</b>	<b>9</b>	<b>Power Supply Recommendations .....</b>	<b>16</b>
6.1	Absolute Maximum Ratings .....	4	<b>10</b>	<b>Layout .....</b>	<b>16</b>
6.2	ESD Ratings .....	4	10.1	Layout Guidelines .....	16
6.3	Recommended Operating Conditions .....	4	10.2	Layout Example .....	16
6.4	Thermal Information .....	4	<b>11</b>	<b>器件和文档支持 .....</b>	<b>17</b>
6.5	DC Electrical Characteristics .....	5	11.1	接收文档更新通知 .....	17
6.6	AC Electrical Characteristics .....	6	11.2	社区资源 .....	17
6.7	Typical Characteristics .....	7	11.3	商标 .....	17
<b>7</b>	<b>Detailed Description .....</b>	<b>12</b>	11.4	静电放电警告 .....	17
7.1	Overview .....	12	11.5	Glossary .....	17
7.2	Functional Block Diagram .....	12	<b>12</b>	<b>机械、封装和可订购信息 .....</b>	<b>18</b>

## 4 修订历史记录

注：之前版本的页码可能与当前版本有所不同。

日期	修订版本	注意
2017 年 6 月	*	初始发行版。

## 5 Pin Configuration and Functions

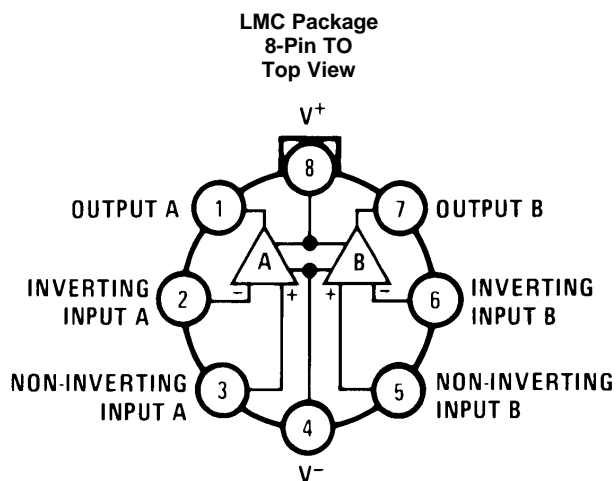

Note. Pin 4 connected to case.

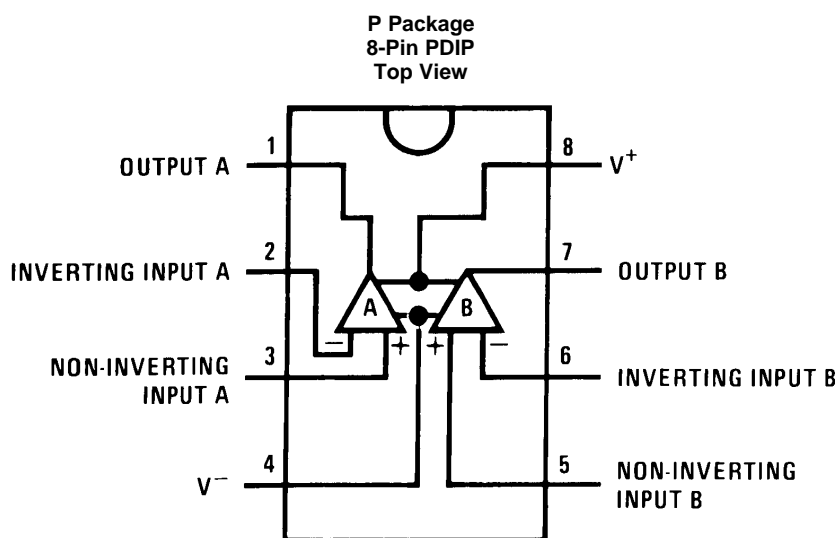

### Pin Functions

PIN		I/O	DESCRIPTION
NAME	NO.		
Inverting input A	2	I	Amplifier A inverting input
Inverting input B	6	I	Amplifier B inverting input
Noninverting input A	3	I	Amplifier A noninverting input
Noninverting input B	5	I	Amplifier B noninverting input
Output A	1	O	Amplifier A output
Output B	7	O	Amplifier B output
V+	8	P	Positive supply
V-	4	P	Negative supply

## 6 Specifications

### 6.1 Absolute Maximum Ratings

over operating free-air temperature range (unless otherwise noted)<sup>(1)</sup>

	MIN	MAX	UNIT
Supply voltage	-18	18	V
Differential input voltage	-30	30	V
Input voltage range			
Output short circuit duration	Continuous		
Power dissipation	670		mW
T <sub>J</sub> maximum	115		°C
Operating temperature range	See <a href="#">Thermal Information</a>		
Storage temperature, T <sub>stg</sub>	-65	150	°C

- (1) Stresses beyond those listed under *Absolute Maximum Ratings* may cause permanent damage to the device. These are stress ratings only, which do not imply functional operation of the device at these or any other conditions beyond those indicated under *Recommended Operating Conditions*. Exposure to absolute-maximum-rated conditions for extended periods may affect device reliability.

### 6.2 ESD Ratings

		VALUE	UNIT
V <sub>(ESD)</sub> Electrostatic discharge	Human-body model (HBM), per ANSI/ESDA/JEDEC JS-001 <sup>(1)</sup>	±1700	V
	Charged-device model (CDM), per JEDEC specification JESD22-C101 <sup>(2)</sup>	±1700	

- (1) JEDEC document JEP155 states that 500-V HBM allows safe manufacturing with a standard ESD control process. Manufacturing with less than 500-V HBM is possible with the necessary precautions. Pins listed as ±1700 V may actually have higher performance.
- (2) JEDEC document JEP157 states that 250-V CDM allows safe manufacturing with a standard ESD control process. Manufacturing with less than 250-V CDM is possible with the necessary precautions. Pins listed as ±1700 V may actually have higher performance.

### 6.3 Recommended Operating Conditions

over operating free-air temperature range (unless otherwise noted)

	MIN	NOM	MAX	UNIT
Supply voltage			±15	V

### 6.4 Thermal Information

THERMAL METRIC <sup>(1)</sup>	LF412-N-MIL		UNIT
	LMC (TO)	P (PDIP)	
	8 PINS	8 PINS	
R <sub>θJA</sub> Junction-to-ambient thermal resistance (typical)	152	115	°C/W

- (1) For more information about traditional and new thermal metrics, see the [Semiconductor and IC Package Thermal Metrics](#) application report.

## 6.5 DC Electrical Characteristics

over operating free-air temperature range (unless otherwise noted)

PARAMETER	TEST CONDITIONS	LF412-N-MIL <sup>(1)</sup>			UNIT
		MIN	TYP	MAX	
V <sub>OS</sub>	Input offset voltage R <sub>S</sub> = 10 kΩ, T <sub>A</sub> = 25°C		1	3	mV
ΔV <sub>OS</sub> /ΔT	Average TC of input offset voltage R <sub>S</sub> = 10 kΩ		7		μV/°C
I <sub>OS</sub>	Input offset current V <sub>S</sub> = ±15 V <sup>(2)</sup>	T <sub>J</sub> = 25°C	25	100	pA
		T <sub>J</sub> = 70°C		2	nA
		T <sub>J</sub> = 125°C		25	nA
I <sub>B</sub>	Input bias current V <sub>S</sub> = ±15 V <sup>(2)</sup>	T <sub>J</sub> = 25°C	50	200	pA
		T <sub>J</sub> = 70°C		4	nA
		T <sub>J</sub> = 125°C		50	nA
R <sub>IN</sub>	Input resistance T <sub>J</sub> = 25°C		10 <sup>12</sup>		Ω
A <sub>VOL</sub>	Large signal voltage gain R <sub>L</sub> = 2 k, T <sub>A</sub> = 25°C, V <sub>S</sub> = ±15 V, V <sub>O</sub> = ±10 V	25	200		V/mV
	Over temperature	15	200		
V <sub>O</sub>	Output voltage swing V <sub>S</sub> = ±15 V, R <sub>L</sub> = 10 k	±12	±13.5		V
V <sub>CM</sub>	Input common-mode voltage range	±11	14.5		V
			-11.5		V
CMRR	Common-mode rejection ratio R <sub>S</sub> ≤ 10 k	70	100		dB
PSRR	Supply voltage rejection ratio	<sup>(3)</sup> 70	100		dB
I <sub>S</sub>	Supply current V <sub>O</sub> = 0 V, R <sub>L</sub> = ∞		3.6	6.5	mA

- (1) Unless otherwise specified, the specifications apply over the full temperature range and for V<sub>S</sub> = ±15 V for the LF412-N-MIL. V<sub>OS</sub>, I<sub>B</sub>, and I<sub>OS</sub> are measured at V<sub>CM</sub> = 0.
- (2) The input bias currents are junction leakage currents which approximately double for every 10°C increase in the junction temperature, T<sub>J</sub>. Due to limited production test time, the input bias currents measured are correlated to junction temperature. In normal operation the junction temperature rises above the ambient temperature as a result of internal power dissipation, P<sub>D</sub>. T<sub>J</sub> = T<sub>A</sub> + θ<sub>JA</sub> P<sub>D</sub> where θ<sub>JA</sub> is the thermal resistance from junction to ambient. Use of a heat sink is recommended if input bias current is to be kept to a minimum.
- (3) Supply voltage rejection ratio is measured for both supply magnitudes increasing or decreasing simultaneously in accordance with common practice. V<sub>S</sub> = ±6 V to ±15 V.

## 6.6 AC Electrical Characteristics

over operating free-air temperature range (unless otherwise noted)

PARAMETER	TEST CONDITIONS	LF412-N-MIL <sup>(1)</sup>			UNIT
		MIN	TYP	MAX	
Amplifier to amplifier coupling	$T_A = 25^\circ\text{C}$ $f = 1\text{ Hz} - 20\text{ kHz}$ (Input referred)		-120		dB
SR	Slew rate				$\text{V}/\mu\text{s}$
	$V_S = \pm 15\text{ V}$ $T_A = 25^\circ\text{C}$	8	15		
GBW	Gain-bandwidth product				MHz
	$V_S = \pm 15\text{ V}$ $T_A = 25^\circ\text{C}$	2.7	4		
THD	Total harmonic dist				
	$A_V = 10$ $R_L = 10\text{ k}$ $V_O = 20\text{ Vp-p}$ $\text{BW} = 20\text{ Hz} - 20\text{ kHz}$		$\leq 0.02\%$		
$e_n$	Equivalent input noise voltage				$\text{nV} / \sqrt{\text{Hz}}$
	$T_A = 25^\circ\text{C}$ $R_S = 100\ \Omega$ $f = 1\text{ kHz}$		25		
$i_n$	Equivalent input noise current				$\text{pA} / \sqrt{\text{Hz}}$
	$T_A = 25^\circ\text{C}, f = 1\text{ kHz}$		0.01		

(1) Unless otherwise specified, the specifications apply over the full temperature range and for  $V_S = \pm 15\text{ V}$  for the LF412-N-MIL.  $V_{OS}$ ,  $I_B$ , and  $I_{OS}$  are measured at  $V_{CM} = 0$ .

### 6.7 Typical Characteristics



图 1. Input Bias Current



图 2. Input Bias Current

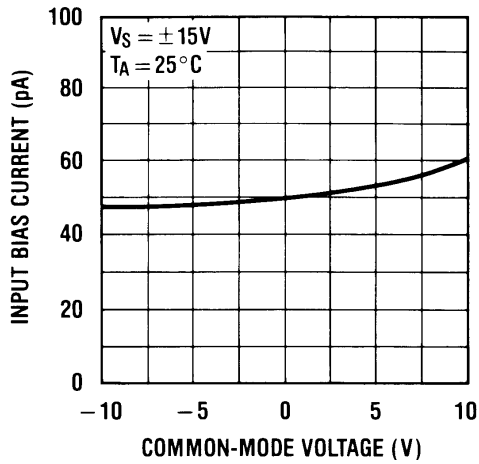

图 3. Supply Current

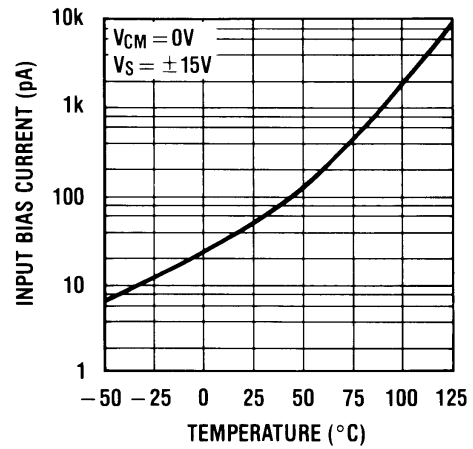

图 4. Positive Common-Mode Input Voltage Limit

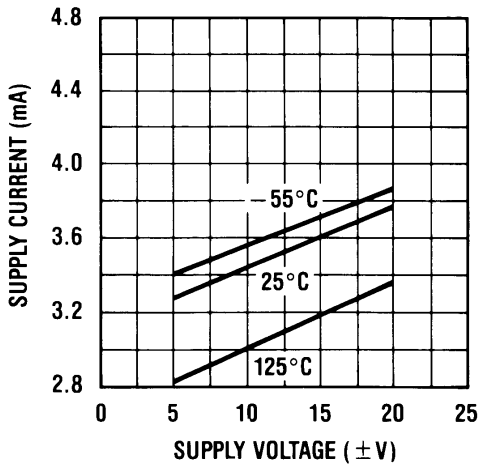

图 5. Negative Common-Mode Input Voltage Limit

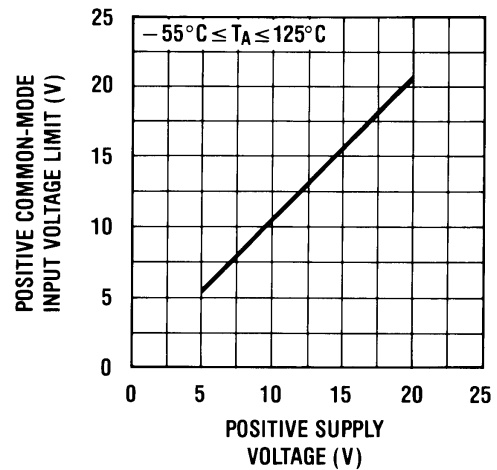

图 6. Positive Current Limit

Typical Characteristics (接下页)

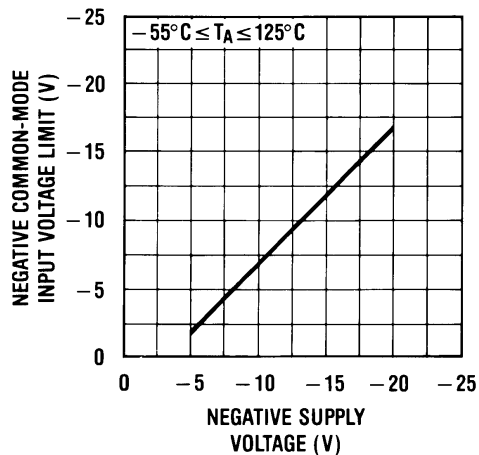

图 7. Negative Current Limit

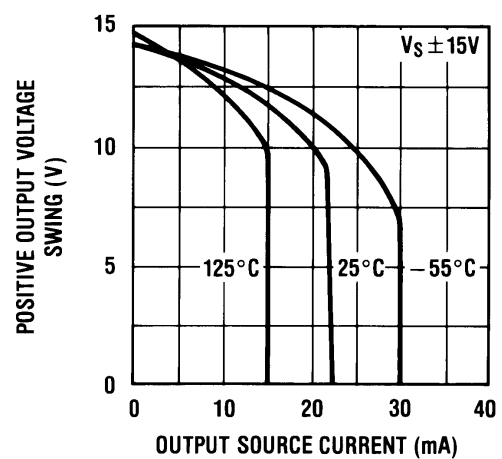

图 8. Output Voltage Swing

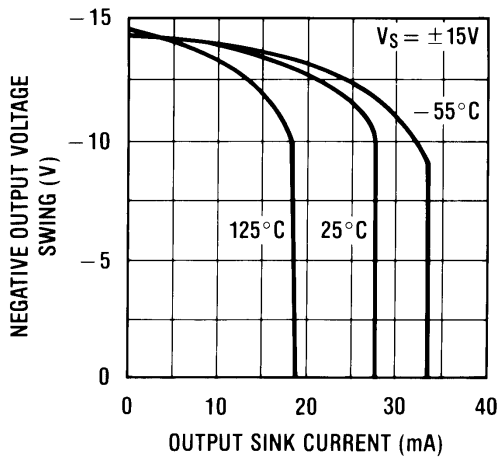

图 9. Output Voltage Swing

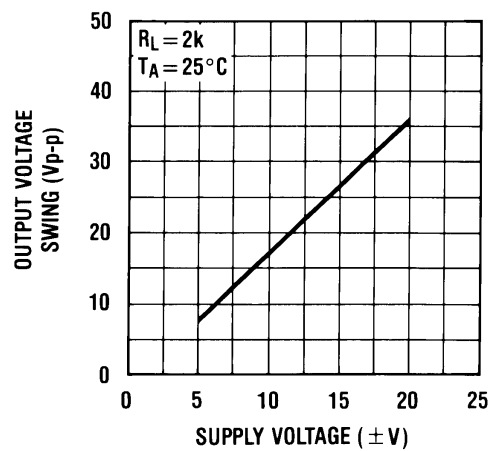

图 10. Gain Bandwidth

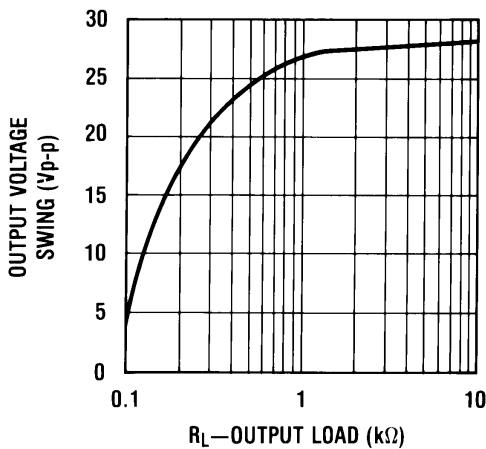

图 11. Bode Plot

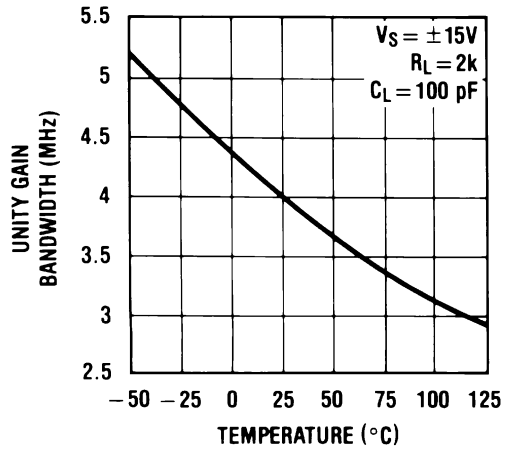

图 12. Slew Rate

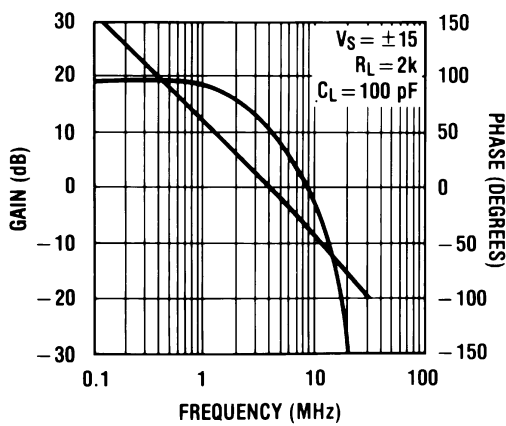

Typical Characteristics (接下页)

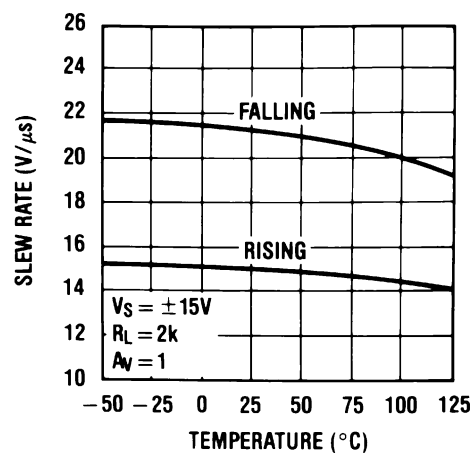

图 13. Distortion vs Frequency



图 14. Undistorted Output Voltage Swing

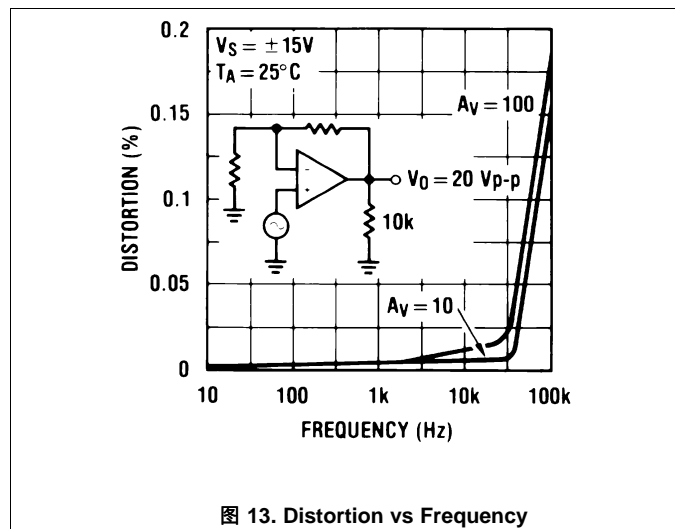

图 15. Open Loop Frequency Response

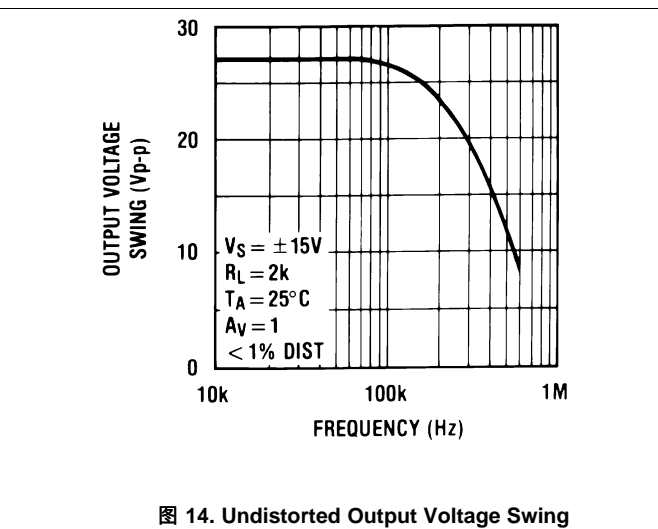

图 16. Common-Mode Rejection Ratio

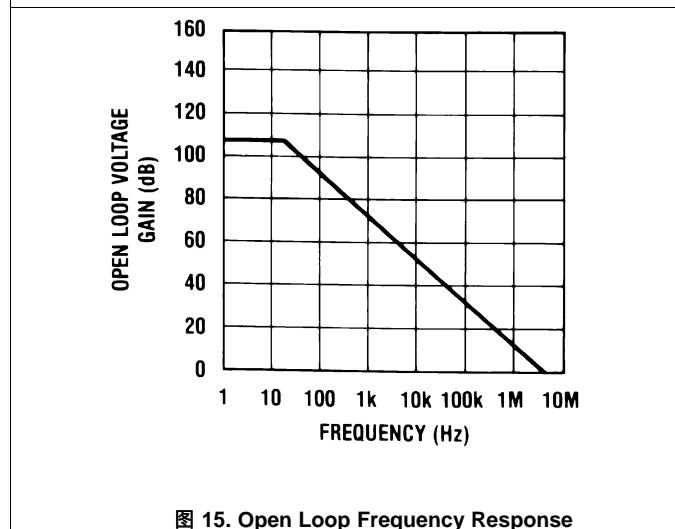

图 17. Power Supply Rejection Ratio

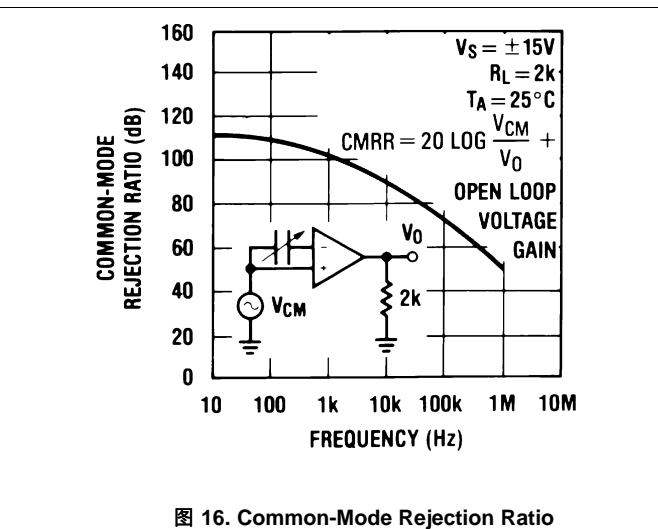

图 18. Equivalent Input Noise Voltage

Typical Characteristics (接下页)

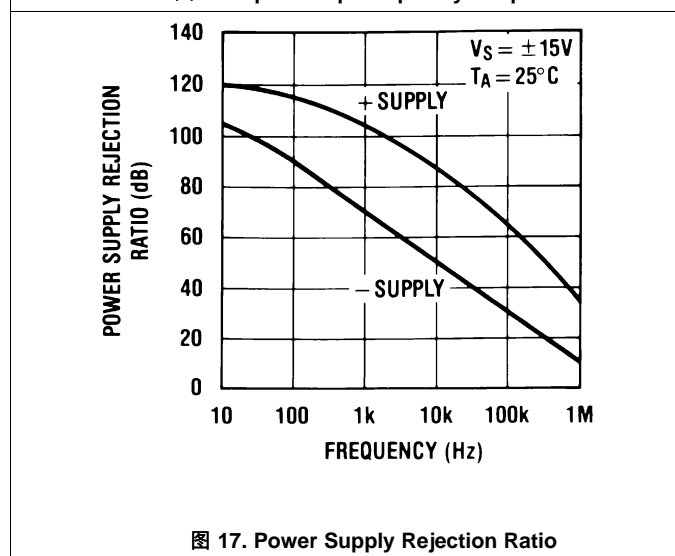

图 19. Open Loop Voltage Gain

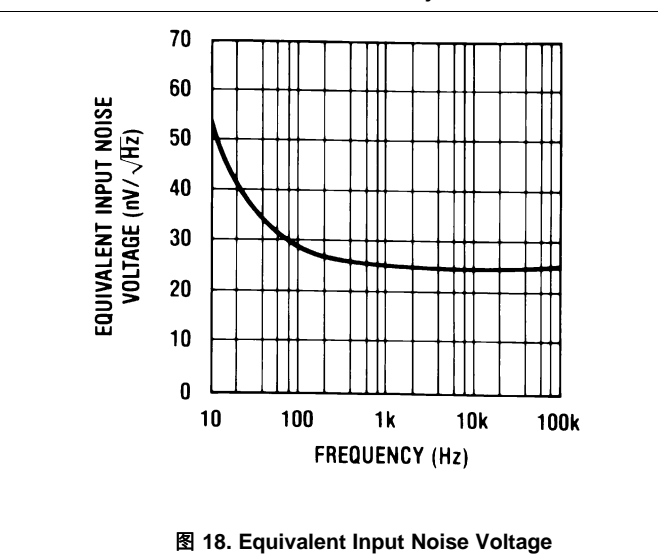

图 20. Output Impedance

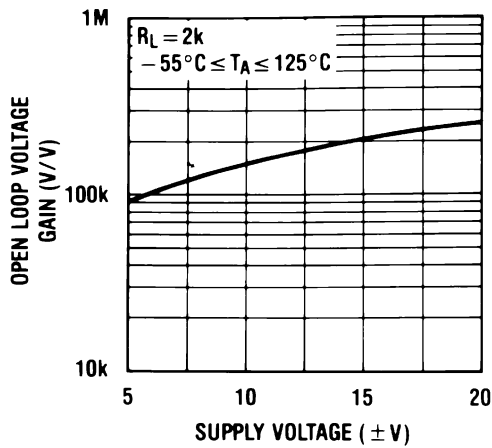

图 21. Inverter Settling Time

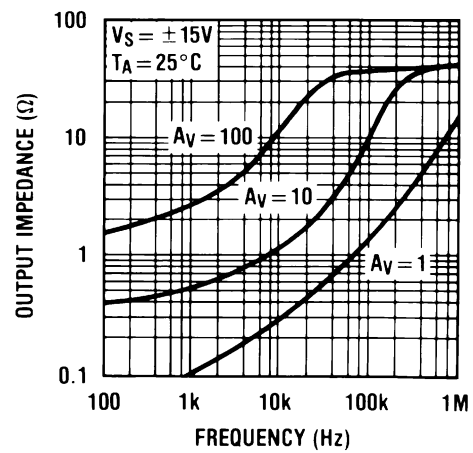

图 22. Small Signal Inverting

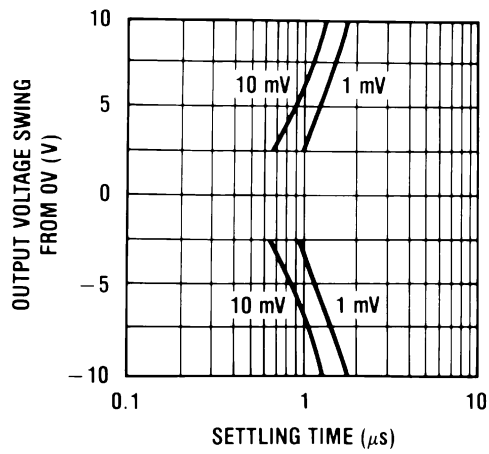

图 23. Small Signal Non-Inverting

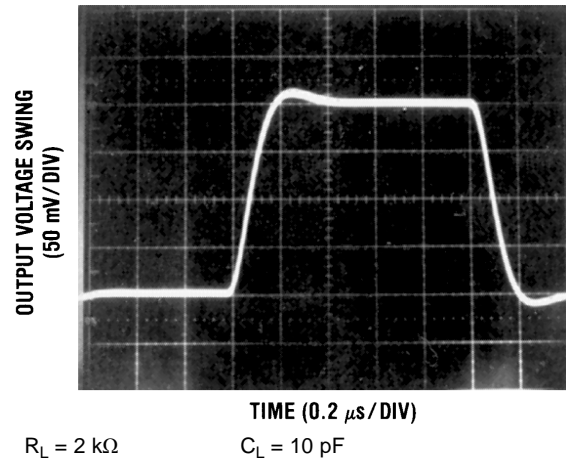

图 24. Large Signal Inverting

**Typical Characteristics (接下页)**

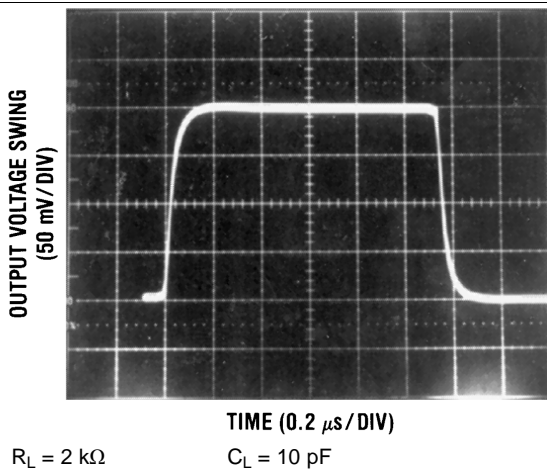

## 7 Detailed Description

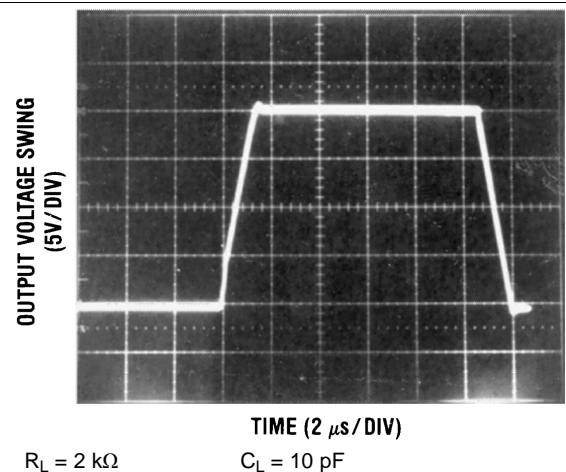
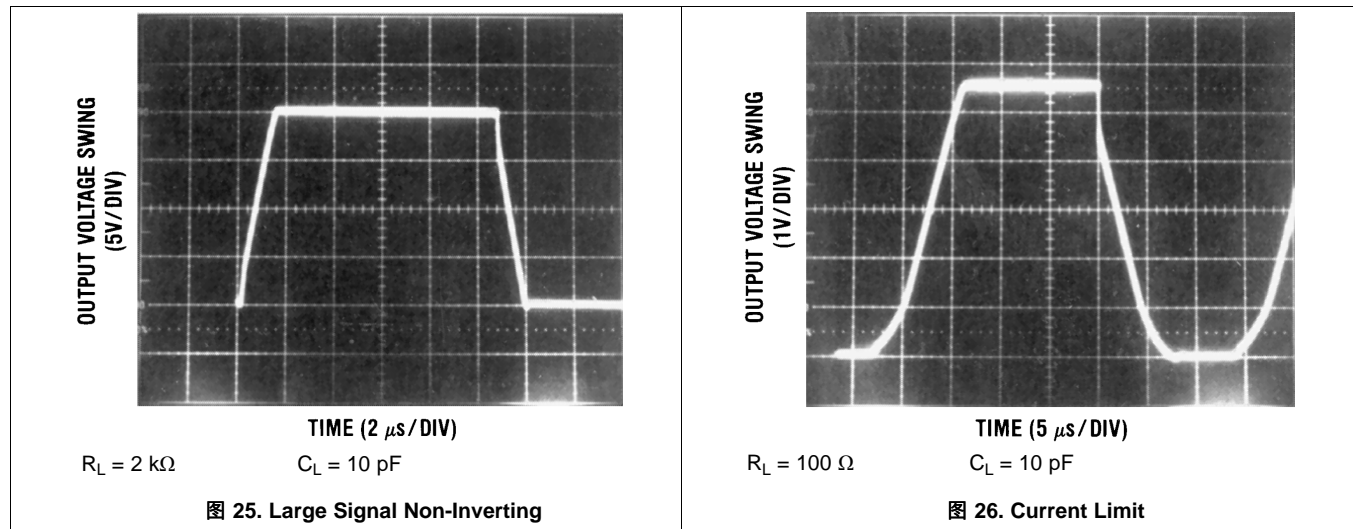
### 7.1 Overview

The LF412-N-MIL devices are low cost, high speed, JFET input operational amplifiers with very low input offset voltage and input offset voltage drift. They require low supply current yet maintain a large gain bandwidth product and fast slew rate. In addition, well matched high voltage JFET input devices provide very low input bias and offset currents. The LF412-N-MIL dual is pin compatible with the LM1558, allowing designers to immediately upgrade the overall performance of existing designs.

These amplifiers may be used in applications such as high speed integrators, fast D/A converters, sample and hold circuits and many other circuits requiring low input offset voltage and drift, low input bias current, high input impedance, high slew rate and wide bandwidth.

### 7.2 Functional Block Diagram

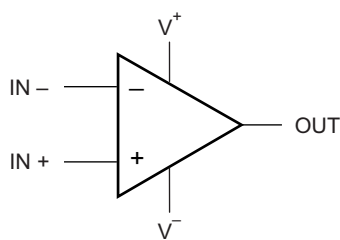

Copyright © 2016,  
Texas Instruments Incorporated

**图 27. Each Amplifier**

### 7.3 Feature Description

The amplifier's differential inputs consist of a non-inverting input (+IN) and an inverting input (-IN). The amplifier amplifies only the difference in voltage between the two inputs, which is called the differential input voltage. The output voltage of the op-amp  $V_{OUT}$  is given by the equation  $V_{OUT} = A_{OL}(IN+ - IN-)$ .

## 7.4 Device Functional Modes

### 7.4.1 Input and Output Stage



图 28. 1/2 Dual LF412-N-MIL

## 8 Application and Implementation

### 注

Information in the following applications sections is not part of the TI component specification, and TI does not warrant its accuracy or completeness. TI's customers are responsible for determining suitability of components for their purposes. Customers should validate and test their design implementation to confirm system functionality.

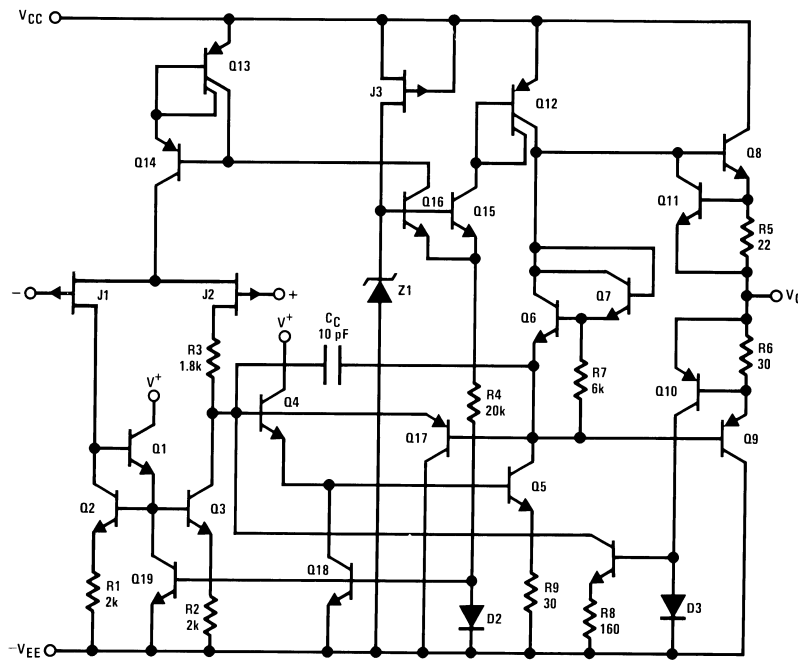
### 8.1 Application Information

The LF412-N-MIL series of JFET input dual op amps are internally trimmed (BI-FET II™) providing very low input offset voltages and input offset voltage drift. These JFETs have large reverse breakdown voltages from gate to source and drain eliminating the need for clamps across the inputs. Therefore, large differential input voltages can easily be accommodated without a large increase in input current. The maximum differential input voltage is independent of the supply voltages. However, neither of the input voltages should be allowed to exceed the negative supply as this will cause large currents to flow which can result in a destroyed unit.

### 8.2 Typical Application

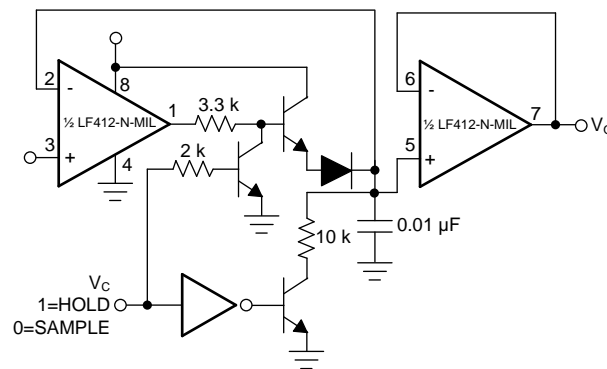

Copyright © 2017, Texas Instruments Incorporated

**图 29. Single-Supply Sample and Hold**

#### 8.2.1 Design Requirements

Single-supply.

#### 8.2.2 Detailed Design Procedure

Exceeding the negative common-mode limit on either input will cause a reversal of the phase to the output and force the amplifier output to the corresponding high or low state.

Exceeding the negative common-mode limit on both inputs will force the amplifier output to a high state. In neither case does a latch occur since raising the input back within the common-mode range again puts the input stage and thus the amplifier in a normal operating mode.

Exceeding the positive common-mode limit on a single input will not change the phase of the output, however, if both inputs exceed the limit, the output of the amplifier may be forced to a high state.

The amplifiers will operate with a common-mode input voltage equal to the positive supply; however, the gain bandwidth and slew rate may be decreased in this condition. When the negative common-mode voltage swings to within 3V of the negative supply, an increase in input offset voltage may occur.

Each amplifier is individually biased by a zener reference which allows normal circuit operation on  $\pm 6$  V power supplies. Supply voltages less than these may result in lower gain bandwidth and slew rate.

## Typical Application (接下页)

The amplifiers will drive a 2 k $\Omega$  load resistance to  $\pm 10$  V over the full temperature range. If the amplifier is forced to drive heavier load currents, however, an increase in input offset voltage may occur on the negative voltage swing and finally reach an active current limit on both positive and negative swings.

Precautions should be taken to ensure that the power supply for the integrated circuit never becomes reversed in polarity or that the unit is not inadvertently installed backwards in a socket as an unlimited current surge through the resulting forward diode within the IC could cause fusing of the internal conductors and result in a destroyed unit.

As with most amplifiers, care should be taken with lead dress, component placement and supply decoupling in order to ensure stability. For example, resistors from the output to an input should be placed with the body close to the input to minimize “pick-up” and maximize the frequency of the feedback pole by minimizing the capacitance from the input to ground.

A feedback pole is created when the feedback around any amplifier is resistive. The parallel resistance and capacitance from the input of the device (usually the inverting input) to AC ground set the frequency of the pole. In many instances the frequency of this pole is much greater than the expected 3 dB frequency of the closed loop gain and consequently there is negligible effect on stability margin. However, if the feedback pole is less than approximately 6 times the expected 3 dB frequency a lead capacitor should be placed from the output to the input of the op amp. The value of the added capacitor should be such that the RC time constant of this capacitor and the resistance it parallels is greater than or equal to the original feedback pole time constant.

### 8.2.3 Application Curves

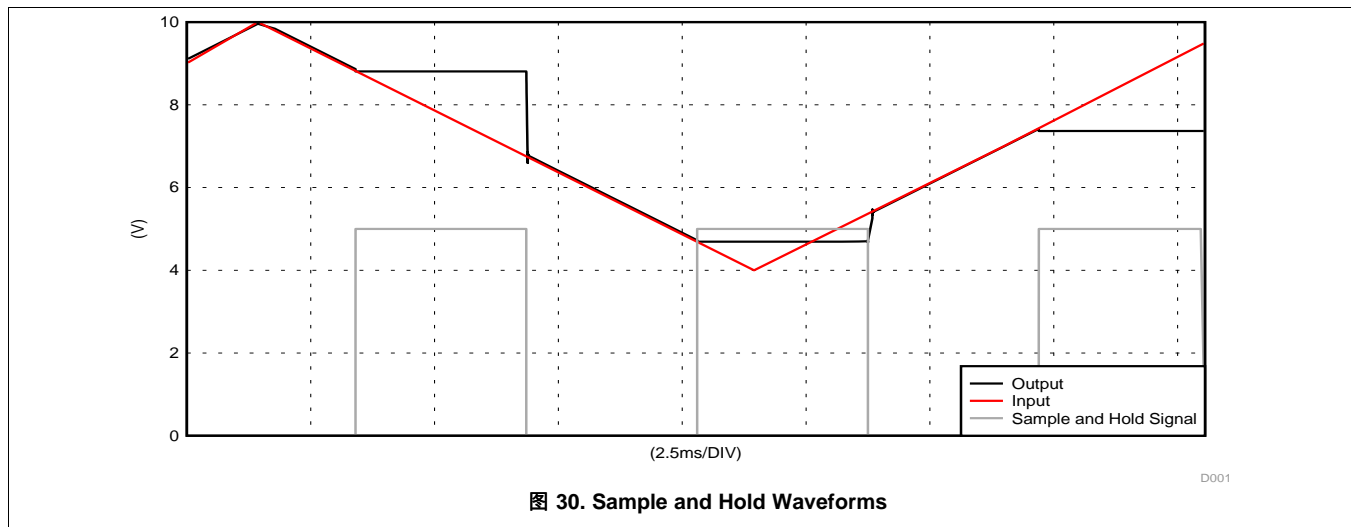

## 9 Power Supply Recommendations

For proper operation, the power supplies must be properly decoupled. For decoupling the supply lines it is suggested that 0.1  $\mu\text{F}$  capacitors be placed as close as possible to the op amp power supply pins. The minimum power supply voltage is  $\pm 5\text{ V}$ .

## 10 Layout

### 10.1 Layout Guidelines

As with most amplifiers, care should be taken with lead dress, component placement and supply decoupling in order to ensure stability. For example, resistors from the output to an input should be placed with the body close to the input to minimize “pick-up” and maximize the frequency of the feedback pole by minimizing the capacitance from the input to ground.

### 10.2 Layout Example



图 31. LF412-N-MIL Layout



## 11 器件和文档支持

### 11.1 接收文档更新通知

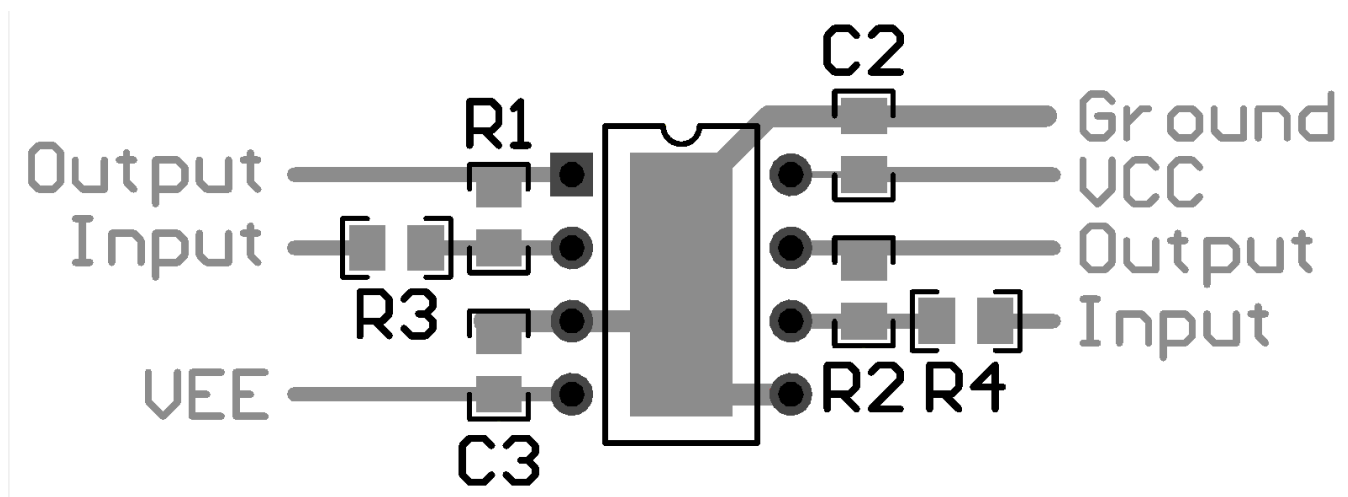
要接收文档更新通知，请导航至德州仪器 TI.com.cn 上的器件产品文件夹。请单击右上角的 *通知我* 进行注册，即可收到任意产品信息更改每周摘要。有关更改的详细信息，请查看任意已修订文档中包含的修订历史记录。

### 11.2 社区资源

下列链接提供到 TI 社区资源的连接。链接的内容由各个分销商“按照原样”提供。这些内容并不构成 TI 技术规范，并且不一定反映 TI 的观点；请参阅 TI 的《使用条款》。

**TI E2E™ 在线社区** *TI 的工程师对工程师 (E2E) 社区*。此社区的创建目的在于促进工程师之间的协作。在 e2e.ti.com 中，您可以咨询问题、分享知识、拓展思路并与同行工程师一道帮助解决问题。

**设计支持** *TI 参考设计支持* 可帮助您快速查找有帮助的 E2E 论坛、设计支持工具以及技术支持的联系信息。

### 11.3 商标

BI-FET II, E2E are trademarks of Texas Instruments.  
All other trademarks are the property of their respective owners.

### 11.4 静电放电警告



ESD 可能会损坏该集成电路。德州仪器 (TI) 建议通过适当的预防措施处理所有集成电路。如果不遵守正确的处理措施和安装程序，可能会损坏集成电路。

ESD 的损坏小至导致微小的性能降级，大至整个器件故障。精密的集成电路可能更容易受到损坏，这是因为非常细微的参数更改都可能会导致器件与其发布的规格不相符。

### 11.5 Glossary

**SLYZ022** — *TI Glossary*.

This glossary lists and explains terms, acronyms, and definitions.

## 12 机械、封装和可订购信息

以下页面包括机械、封装和可订购信息。这些信息是指定器件的最新可用数据。这些数据发生变化时，我们可能不会另行通知或修订此文档。如欲获取此产品说明书的浏览器版本，请参阅左侧的导航栏。

**PACKAGING INFORMATION**

Orderable Device	Status (1)	Package Type	Package Drawing	Pins	Package Qty	Eco Plan (2)	Lead finish/ Ball material (6)	MSL Peak Temp (3)	Op Temp (°C)	Device Marking (4/5)	Samples
LF412MH	ACTIVE	TO-99	LMC	8	500	Non-RoHS & Non-Green	Call TI	Call TI	-55 to 125	( LF412MH, LF412MH )	<a href="#">Samples</a>
LF412MH/NOPB	ACTIVE	TO-99	LMC	8	500	RoHS & Green	Call TI	Level-1-NA-UNLIM	-55 to 125	( LF412MH, LF412MH )	<a href="#">Samples</a>

(1) The marketing status values are defined as follows:

**ACTIVE:** Product device recommended for new designs.

**LIFEBUY:** TI has announced that the device will be discontinued, and a lifetime-buy period is in effect.

**NRND:** Not recommended for new designs. Device is in production to support existing customers, but TI does not recommend using this part in a new design.

**PREVIEW:** Device has been announced but is not in production. Samples may or may not be available.

**OBSOLETE:** TI has discontinued the production of the device.

(2) **RoHS:** TI defines "RoHS" to mean semiconductor products that are compliant with the current EU RoHS requirements for all 10 RoHS substances, including the requirement that RoHS substance do not exceed 0.1% by weight in homogeneous materials. Where designed to be soldered at high temperatures, "RoHS" products are suitable for use in specified lead-free processes. TI may reference these types of products as "Pb-Free".

**RoHS Exempt:** TI defines "RoHS Exempt" to mean products that contain lead but are compliant with EU RoHS pursuant to a specific EU RoHS exemption.

**Green:** TI defines "Green" to mean the content of Chlorine (Cl) and Bromine (Br) based flame retardants meet JS709B low halogen requirements of <=1000ppm threshold. Antimony trioxide based flame retardants must also meet the <=1000ppm threshold requirement.

(3) MSL, Peak Temp. - The Moisture Sensitivity Level rating according to the JEDEC industry standard classifications, and peak solder temperature.

(4) There may be additional marking, which relates to the logo, the lot trace code information, or the environmental category on the device.

(5) Multiple Device Markings will be inside parentheses. Only one Device Marking contained in parentheses and separated by a "~" will appear on a device. If a line is indented then it is a continuation of the previous line and the two combined represent the entire Device Marking for that device.

(6) Lead finish/Ball material - Orderable Devices may have multiple material finish options. Finish options are separated by a vertical ruled line. Lead finish/Ball material values may wrap to two lines if the finish value exceeds the maximum column width.

**Important Information and Disclaimer:**The information provided on this page represents TI's knowledge and belief as of the date that it is provided. TI bases its knowledge and belief on information provided by third parties, and makes no representation or warranty as to the accuracy of such information. Efforts are underway to better integrate information from third parties. TI has taken and continues to take reasonable steps to provide representative and accurate information but may not have conducted destructive testing or chemical analysis on incoming materials and chemicals. TI and TI suppliers consider certain information to be proprietary, and thus CAS numbers and other limited information may not be available for release.

In no event shall TI's liability arising out of such information exceed the total purchase price of the TI part(s) at issue in this document sold by TI to Customer on an annual basis.



LMC (O-MBCY-W8)

METAL CYLINDRICAL PACKAGE

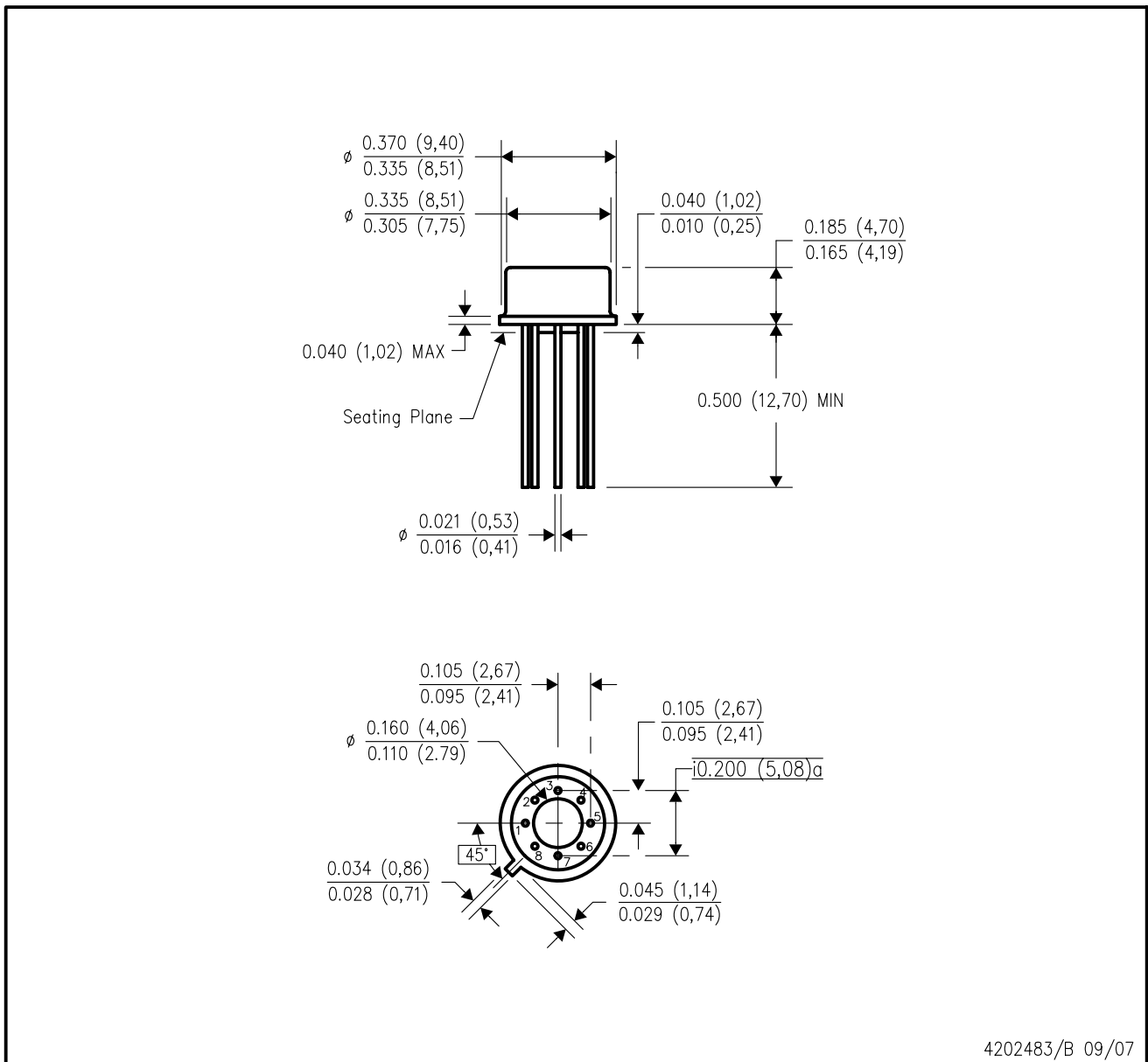

- NOTES:
- A. All linear dimensions are in inches (millimeters).
  - B. This drawing is subject to change without notice.
  - C. Leads in true position within  $0.010$  (0,25) R @ MMC at seating plane.
  - D. Pin numbers shown for reference only. Numbers may not be marked on package.
  - E. Falls within JEDEC MO-002/TO-99.

## 重要声明和免责声明

TI 均以“原样”提供技术性及其可靠性数据（包括数据表）、设计资源（包括参考设计）、应用或其他设计建议、网络工具、安全信息和其他资源，不保证其中不含任何瑕疵，且不做任何明示或暗示的担保，包括但不限于对适销性、适合某特定用途或不侵犯任何第三方知识产权的暗示担保。

所述资源可供专业开发人员应用TI 产品进行设计使用。您将对以下行为独自承担全部责任：(1) 针对您的应用选择合适的TI 产品；(2) 设计、验证并测试您的应用；(3) 确保您的应用满足相应标准以及任何其他安全、安保或其他要求。所述资源如有变更，恕不另行通知。TI 对您使用所述资源的授权仅限于开发资源所涉及TI 产品的相关应用。除此之外不得复制或展示所述资源，也不提供其它TI 或任何第三方的知识产权授权许可。如因使用所述资源而产生任何索赔、赔偿、成本、损失及债务等，TI 对此概不负责，并且您须赔偿由此对TI 及其代表造成的损害。

TI 所提供产品均受TI 的销售条款 (<http://www.ti.com.cn/zh-cn/legal/termsofsale.html>) 以及 [ti.com.cn](http://www.ti.com.cn) 上或随附TI 产品提供的其他可适用条款的约束。TI 提供所述资源并不扩展或以其他方式更改TI 针对TI 产品所发布的可适用的担保范围或担保免责声明。

邮寄地址：上海市浦东新区世纪大道 1568 号中建大厦 32 楼，邮政编码：200122

Copyright © 2020 德州仪器半导体技术（上海）有限公司