

TPS2471x 2.5V 至 18V 高效率功率限制热插拔控制器

1 特性

- 工作电压范围为 2.5V 至 18V
- 精确的启动电流限制
- 可编程场效应管 (FET) 安全运行区域 (SOA) 保护
- 25mV 精确电流感测阈值
- 电源正常输出
- 用于短路保护的快速断路器
- 可编程故障定时器
- 可编程欠压 (UV) 阈值
- LTC4211 的插接升级版本 — 布局无变化
- PG、FLT 高电平有效和低电平有效版本
- 微型小外形尺寸 (MSOP)-10 封装

2 应用

- 服务器 背板
- 存储区域网络 (SAN)
- 医疗系统
- 插件模块
- 基站

3 说明

TPS24710/11/12/13 是一款简单易用的 2.5V 至 18V、热插拔控制器，可安全驱动外部 N 沟道金属氧化物半导体场效应晶体管 (MOSFET)。可编程电流限制和故障时间保护功能可避免电源和负载启动时的电流过大。启动后，允许在通过编程设定的超时周期结束前流经超过用户选定限值的电流，但负载与电源直接断开的极端过载情况除外。25mV 较低电流感测阈值具有高精度，允许使用小型高效感测电阻，从而降低功率损耗并缩小封装尺寸。

可编程功率限制功能确保外部 MOSFET 始终在其安全工作区 (SOA) 内工作。这支持使用小型 MOSFET，同时提升了系统可靠性。提供了电源正常和故障输出，用于状态监控和下行负载控制。

器件信息(1)

器件型号	封装	封装尺寸 (标称值)
TPS24710	SSOP (10)	3.00mm x 3.00mm
TPS24711		
TPS24712		
TPS24713		

(1) 要了解所有可用封装，请参见数据表末尾的可订购产品附录。

典型应用 (12V/10A)

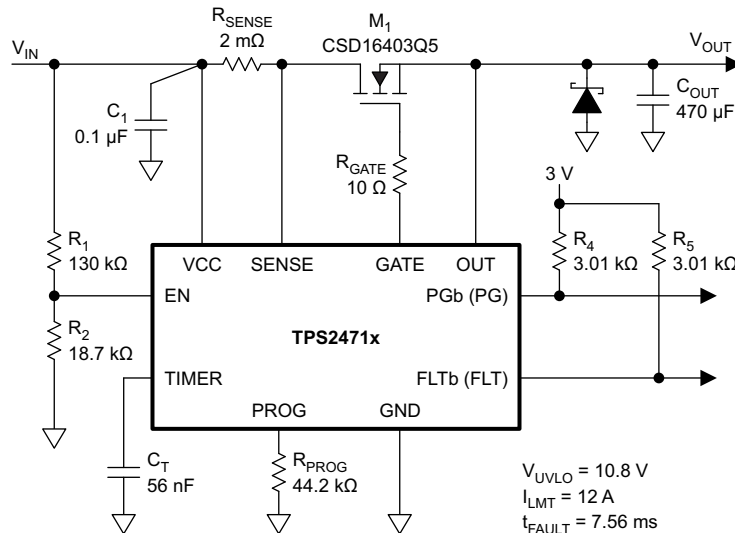

目录

1 特性	1	8.3 Feature Description	14
2 应用	1	8.4 Device Functional Modes	17
3 说明	1	9 Application and Implementation	24
4 修订历史记录	2	9.1 Application Information	24
5 Device Comparison Table	4	9.2 Typical Application	24
6 Pin Configuration and Functions	4	10 Power Supply Recommendations	30
7 Specifications	5	11 Layout	31
7.1 Absolute Maximum Ratings	5	11.1 Layout Guidelines	31
7.2 ESD Ratings	5	11.2 Layout Example	31
7.3 Recommended Operating Conditions	5	12 器件和文档支持	32
7.4 Thermal Information	5	12.1 文档支持	32
7.5 Electrical Characteristics	6	12.2 相关链接	32
7.6 Timing Requirements	7	12.3 社区资源	32
7.7 Typical Characteristics	9	12.4 商标	32
8 Detailed Description	13	12.5 静电放电警告	32
8.1 Overview	13	12.6 Glossary	32
8.2 Functional Block Diagram	13	13 机械、封装和可订购信息	32

4 修订历史记录

注：之前版本的页码可能与当前版本有所不同。

Changes from Revision F (February 2015) to Revision G	Page
• Changed the values of the Power limit threshold in <i>Electrical Characteristics</i> for $V_{OUT} = 7\text{ V}$ and $V_{OUT} = 2\text{ V}$ From: 10, 12.5, 15 mV To: 10.1, 11.6, 13.1 mV	7
• Changed the title of Figure 8 From: MOSFET Gate Current vs Voltage Across R_{SENSE} During Inrush Power Limiting To: Gate Current vs Voltage Across R_{SENSE}	9
• Added Figure 9	9
• Changed $V_{(VCC-SENSE)}$ To: $V_{(SENSE-VCC)}$ in Figure 10 and Figure 11	9
• Added Equation 1	15
• Added text to the <i>PROG</i> section: "To compute the Power limit based on an existing R_{PROG} ..."	15
• Changed Equation 2	15
• Changed text in STEP 3. Choose Power-Limit Value, P_{LIM}, and R_{PROG} From: "a 53.6-k Ω , 1% resistor is selected for R_{PROG} " To: a 44.2-k Ω , 1% resistor is selected for R_{PROG}	27
• Changed Equation 9	27
• Added the <i>Using Soft Start with TPS2471x</i> section	30

Changes from Revision E (November 2013) to Revision F	Page
• 已添加 <i>ESD</i> 额定值表，特性描述部分，器件功能模式，应用和实施部分，电源相关建议部分，布局部分，器件和文档支持部分以及机械、封装和可订购信息部分	1
• Changed the Input voltage range, PROG - MAX value in the <i>Absolute Maximum Ratings</i> table From: 0.3 To: 3.6	5
• Deleted External capacitance - GATE from the <i>Recommended Operating Conditions</i>	5
• Deleted text from the last paragraph in the <i>GATE</i> section "If used, any capacitor connecting GATE and GND should not exceed 1 μF and it should be connected in series with a resistor of no less than 1 k Ω ."	15
• Deleted section: <i>Alternative Design Example: GATE Capacitor (dV/dt) Control in Inrush Mode</i>	29
• Deleted text from the <i>High-Gate-Capacitance Applications</i> section "When gate capacitor dV/dt control is used, ... then a Zener diode is not necessary."	29

Changes from Revision D (November 2013) to Revision E	Page
• Reverted Equation 2 in rev E back to rev C	15
• Reverted Equation 9 in rev E back to rev C	27

Changes from Revision C (May 2011) to Revision D	Page
• Added Note 1 to the Supply Current Conditions statement	6
• Added Note 1 to Fast-turnoff delay	7
• Changed the Functional Block Diagram From: $V_{CC} = 6\text{ V}$ to $V_{CC} = 5.9\text{ V}$ at the Gate Comparator	13
• Changed text in the GATE section From: "Timer Activation Voltage (6 V for $V_{VCC} = 12\text{ V}$)." To: "Timer Activation Voltage (5.9 V for $V_{VCC} = 12\text{ V}$)."	14
• Changed the first paragraph of the Inrush Operation section	18
• Added text and new Equation 10	27
• Changed text prior to Equation 12 From: "6 V (for $V_{VCC} = 12\text{ V}$)" To: "5.9 V (for $V_{VCC} = 12\text{ V}$)"	28
• Changed the text following Equation 12	28
• Changed text following <i>Alternative Design Example: GATE Capacitor (dV/dt) Control in Inrush Mode</i> From: "Set P_{LIM} to a value greater than $V_{VCC} \times I_{CHG}$ " To: "Choose $I_{CHG} < P_{LIM} / V_{VCC}$ "	29
• Changed Equation 15 From: $-C_{ISS}$ To: $-C_{RS}$ (this equation deleted by Revision F)	29

Changes from Revision B (April 2011) to Revision C	Page
• Changed in PGb: from: 140V/340mV, to:170mV / 240mV	15
• Changed in Equation 8: $r_{DS(on)}$ to R_{SENSE}	27

Changes from Revision A (March 2011) to Revision B	Page
• Corrected voltage values shown in Figure 26	13

5 Device Comparison Table

	TPS2471 0	TPS2471 1	TPS24712	TPS24713
Latch Off	X		X	
Retry		X		X
PG	L	L	H	H
FLT	L	L	H	H

6 Pin Configuration and Functions

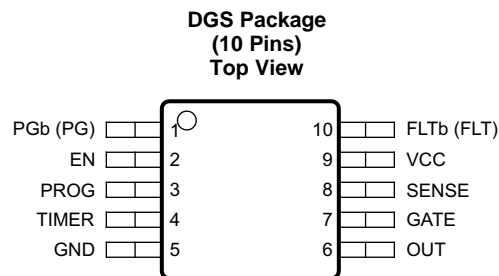

Pin Functions

NAME	PINS		I/O	DESCRIPTION
	TPS24710/11	TPS24712/13		
EN	2	2	I	Active-high enable input. Logic input. Connects to resistor divider.
FLT	–	10	O	Active-high, open-drain output indicates overload fault timer has turned MOSFET off.
FLTb	10	–		Active-low, open-drain output indicates overload fault timer has turned MOSFET off.
GATE	7	7	O	Gate driver output for external MOSFET
GND	5	5	–	Ground
OUT	6	6	I	Output voltage sensor for monitoring MOSFET power.
PG	–	1	O	Active-high, open-drain power good indicator. Status is determined by the voltage across the MOSFET.
PGb	1	–		Active-low, open-drain power good indicator. Status is determined by the voltage across the MOSFET.
PROG	3	3	I	Power-limiting programming pin. A resistor from this pin to GND sets the maximum power dissipation for the FET.
SENSE	8	8	I	Current sensing input for resistor shunt from VCC to SENSE.
TIMER	4	4	I/O	A capacitor connected from this pin to GND provides a fault timing function.
VCC	9	9	I	Input-voltage sense and power supply

7 Specifications

7.1 Absolute Maximum Ratings

over operating free-air temperature range, all voltages referred to GND (unless otherwise noted) ⁽¹⁾

		MIN	MAX	UNIT
Input voltage range	EN, FLT ⁽²⁾⁽³⁾ , FLTb ⁽²⁾⁽⁴⁾ , GATE, OUT, PG ⁽²⁾⁽³⁾ , PGb ⁽²⁾⁽⁴⁾ , SENSE, VCC	-0.3	30	V
	PROG ⁽²⁾	-0.3	3.6	
	SENSE to VCC	-0.3	0.3	
	TIMER	-0.3	5	
Sink current	FLT, PG, FLTb, PGb		5	mA
Source current	PROG	Internally limited		
Temperature	Maximum junction, T _J	Internally limited		°C

(1) Stresses beyond those listed under *Absolute Maximum Ratings* may cause permanent damage to the device. These are stress ratings only, which do not imply functional operation of the device at these or any other conditions beyond those indicated under *Recommended Operating Conditions*. Exposure to absolute-maximum-rated conditions for extended periods may affect device reliability.

(2) Do not apply voltages directly to these pins.

(3) for TPS24712/13

(4) for TPS24710/11

7.2 ESD Ratings

		VALUE	UNIT	
V _(ESD) Electrostatic discharge	Human-body model (HBM), per ANSI/ESDA/JEDEC JS-001 ⁽¹⁾	All pins except PG and PGb	±2000	V
		PG, PGb	±500	V
	Charged-device model (CDM), per JEDEC specification JESD22-C101 ⁽²⁾		±500	V

(1) JEDEC document JEP155 states that 500-V HBM allows safe manufacturing with a standard ESD control process.

(2) JEDEC document JEP157 states that 250-V CDM allows safe manufacturing with a standard ESD control process.

7.3 Recommended Operating Conditions

over operating free-air temperature range (unless otherwise noted)

		MIN	NOM	MAX	UNIT
Input voltage range	SENSE, VCC	2.5		18	V
	EN, FLT, FLTb, PG, PGb, OUT	0		18	
Sink current	FLT, FLTb, PG, PGb	0		2	mA
Resistance	PROG	4.99		500	kΩ
External capacitance	TIMER	1			nF
Operating junction temperature range, T _J		-40		125	°C

7.4 Thermal Information

THERMAL METRIC ⁽¹⁾		TPS2471/x	UNIT
		MSOP (10) PINS	
R _{θJA}	Junction-to-ambient thermal resistance	166.5	°C/W
R _{θJC(top)}	Junction-to-case (top) thermal resistance	41.8	
R _{θJB}	Junction-to-board thermal resistance	86.1	
Ψ _{JT}	Junction-to-top characterization parameter	1.5	
Ψ _{JB}	Junction-to-board characterization parameter	84.7	
R _{θJC(bot)}	Junction-to-case (bottom) thermal resistance	n/a	

(1) For more information about traditional and new thermal metrics, see the *IC Package Thermal Metrics* application report, [SPRA953](#).

7.5 Electrical Characteristics

–40°C ≤ T_J ≤ 125°C, V_{CC} = 12 V, V_{EN} = 3 V, and R_{PROG} = 50 kΩ to GND.

All voltages referenced to GND, unless otherwise noted.

PARAMETER	CONDITIONS	MIN	NOM	MAX	UNIT
VCC					
UVLO threshold, rising		2.2	2.32	2.45	V
UVLO threshold, falling		2.1	2.22	2.35	V
UVLO hysteresis ⁽¹⁾		0.1			V
Supply current	Enabled — I _{OUT} + I _{VCC} + I _{SENSE}	1		1.4	mA
	Disabled ⁽¹⁾ — EN = 0 V, I _{OUT} + I _{VCC} + I _{SENSE}	0.45			mA
EN					
Threshold voltage, falling		1.2	1.3	1.4	V
Hysteresis ⁽¹⁾		50			mV
Input leakage current	0 V ≤ V _{EN} ≤ 30 V	–1	0	1	μA
FLT, FLTb					
Output low voltage	Sinking 2 mA	0.11		0.25	V
Input leakage current	V _{FLT} = 0 V, 30 V	–1	0	1	μA
	V _{FLTb} = 0 V, 30 V				
PG, PGb					
Threshold	V _(SENSE – OUT) rising, PG going low	140	240	340	mV
	V _(SENSE – OUT) rising, PGb going high				
Hysteresis ⁽¹⁾	Measured V _(SENSE – OUT) falling, PG going high	70			mV
	Measured V _(SENSE – OUT) falling, PGb going low				
Output low voltage	Sinking 2 mA	0.11		0.25	V
Input leakage current	V _{PG} = 0 V, 30 V	–1	0	1	μA
	V _{PGb} = 0 V, 30 V				
PROG					
Bias voltage	Sourcing 10 μA	0.65	0.678	0.7	V
Input leakage current	V _{PROG} = 1.5 V	–0.2	0	0.2	μA
TIMER					
Sourcing current	V _{TIMER} = 0 V	8	10	12	μA
Sinking current	V _{TIMER} = 2 V	8	10	12	μA
	V _{EN} = 0 V, V _{TIMER} = 2 V	2	4.5	7	mA
Upper threshold voltage		1.30	1.35	1.40	V
Lower threshold voltage		0.33	0.35	0.37	V
Timer activation voltage	Raise GATE until I _{TIMER} sinking, measure V _(GATE – VCC) , V _{CC} = 12 V	5	5.9	7	V
Bleed-down resistance	V _{ENSD} = 0 V, V _{TIMER} = 2 V	70	104	130	kΩ
OUT					
Input bias current	V _{OUT} = 12 V	16		30	μA
GATE					
Output voltage	V _{OUT} = 12 V	23.5	25.8	28	V
Clamp voltage	Inject 10 μA into GATE, measure V _(GATE – VCC)	12	13.9	15.5	V
Sourcing current	V _{GATE} = 12 V	20	30	40	μA
Sinking current	Fast turnoff, V _{GATE} = 14 V	0.5	1	1.4	A
	Sustained, V _{GATE} = 4 V to 23 V	6	11	20	mA
	In inrush current limit, V _{GATE} = 4 V to 23 V	20	30	40	μA
Pulldown resistance	Thermal shutdown	14	20	26	kΩ

(1) Parameters are for reference only, and do not constitute part of TI's published specifications for purposes of TI's product warranty.

Electrical Characteristics (continued)

$-40^{\circ}\text{C} \leq T_J \leq 125^{\circ}\text{C}$, $V_{CC} = 12\text{ V}$, $V_{EN} = 3\text{ V}$, and $R_{PROG} = 50\text{ k}\Omega$ to GND.

All voltages referenced to GND, unless otherwise noted.

PARAMETER	CONDITIONS	MIN	NOM	MAX	UNIT
SENSE					
Input bias current	$V_{SENSE} = 12\text{ V}$, sinking current		30	40	μA
Current limit threshold	$V_{OUT} = 12\text{ V}$	22.5	25	27.5	mV
Power limit threshold	$V_{OUT} = 7\text{ V}$, $R_{PROG} = 50\text{ k}\Omega$	10.1	11.6	13.1	mV
	$V_{OUT} = 2\text{ V}$, $R_{PROG} = 25\text{ k}\Omega$	10.1	11.6	13.1	
Fast-trip threshold		52	60	68	mV
OTSD					
Threshold, rising		130	140		$^{\circ}\text{C}$
Hysteresis ⁽¹⁾			10		$^{\circ}\text{C}$

7.6 Timing Requirements

		MIN	NOM	MAX	UNIT
EN					
Turnoff time	$\text{EN} \downarrow$ to $V_{GATE} < 1\text{ V}$, $C_{GATE} = 33\text{ nF}$	20	60	150	μs
Deglitch time	$\text{EN} \uparrow$	8	14	18	μs
Disable delay	$\text{EN} \downarrow$ to $\text{GATE} \downarrow$, $C_{GATE} = 0$, $t_{pff50-90}$, See Figure 1	0.1	0.4	1	μs
PG, PGb					
Delay (deglitch) time	Rising or falling edge	2	3.4	6	ms
GATE					
Fast-turnoff duration		8	13.5	18	μs
Turn on delay	V_{CC} rising to GATE sourcing, $t_{prf50-50}$, See Figure 2		100	250	μs
SENSE					
Fast-turnoff duration		8	13.5	18	μs
Fast-turnoff delay ⁽¹⁾	$V_{(VCC - SENSE)} = 80\text{ mV}$, $C_{GATE} = 0\text{ pF}$, $t_{pff50-50}$, See Figure 3		200		ns

(1) Parameters are for reference only, and do not constitute part of TI's published specifications for purposes of TI's product warranty.

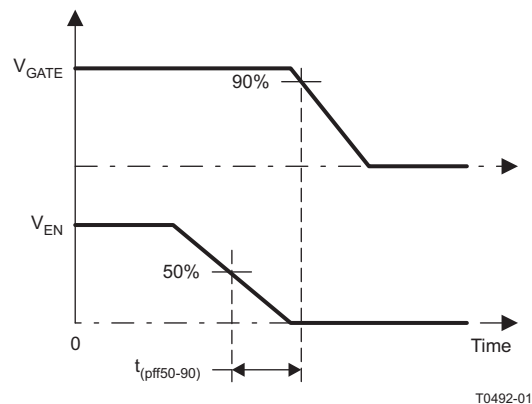

Figure 1. $t_{pff50-90}$ Timing Definition

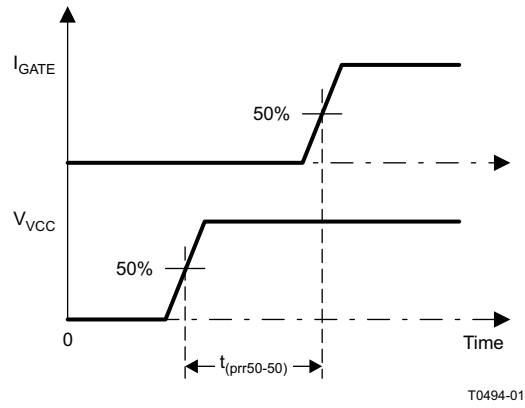

Figure 2. $t_{prf50-50}$ Timing Definition

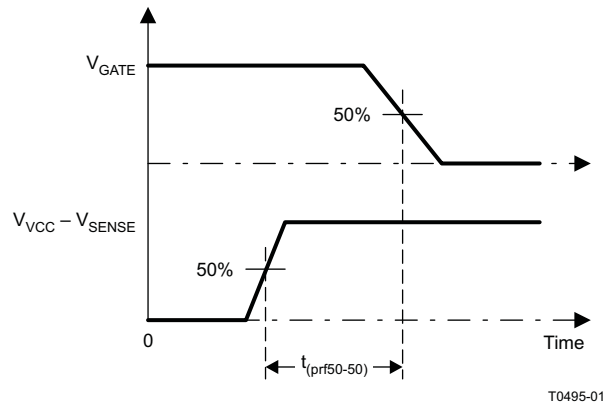
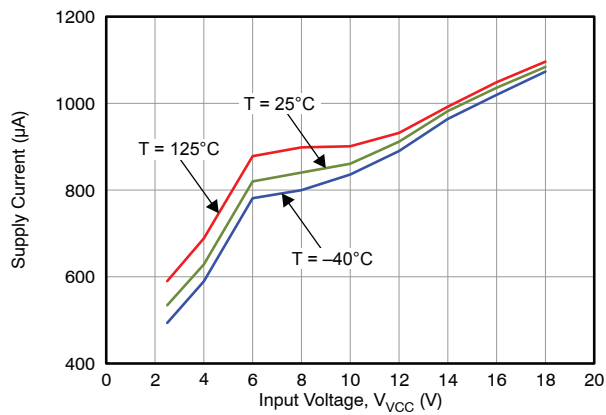

Figure 3. $t_{prf50-50}$ Timing Definition

7.7 Typical Characteristics



EN = High

Figure 4. Supply Current vs Input Voltage at Normal Operation

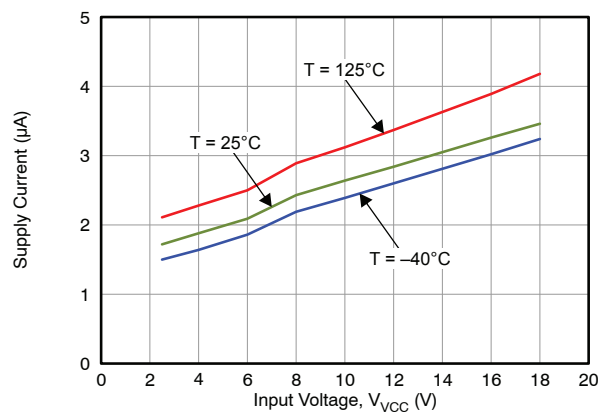

EN = 0 V

Figure 5. Supply Current vs Input Voltage at Shutdown

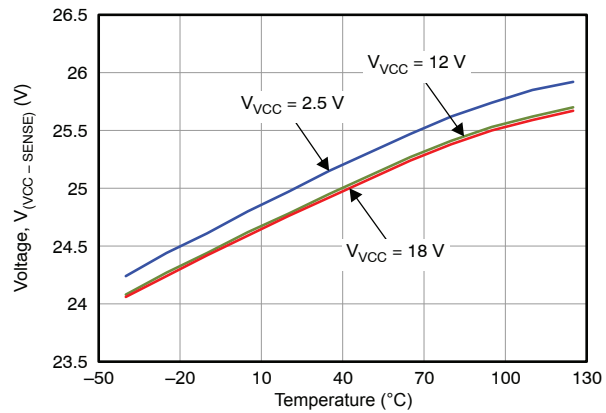

Figure 6. Voltage Across R_{SENSE} in Inrush Current Limiting vs Temperature

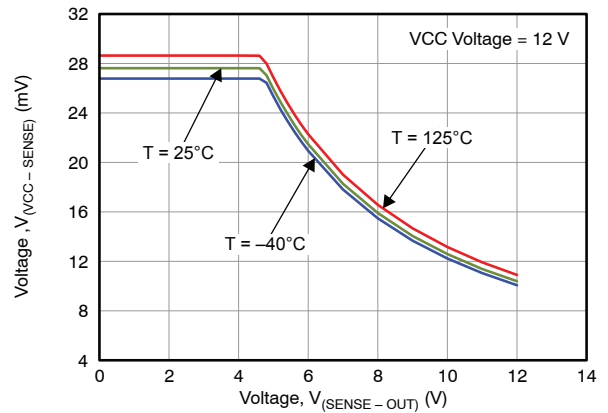

Figure 7. Voltage Across R_{SENSE} in Inrush Power Limiting vs V_{DS} of Pass MOSFET

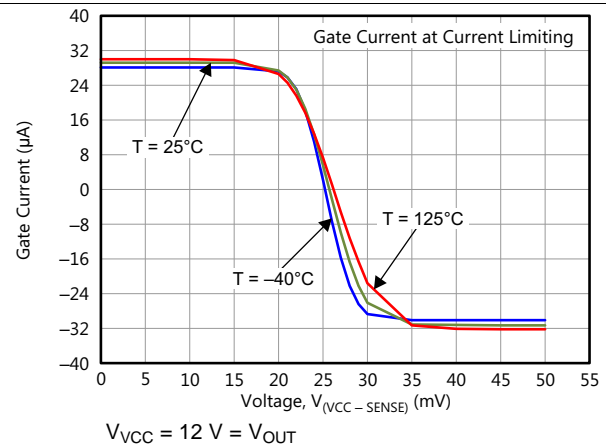

Figure 8. Gate Current vs Voltage Across $R_{(SENSE)}$

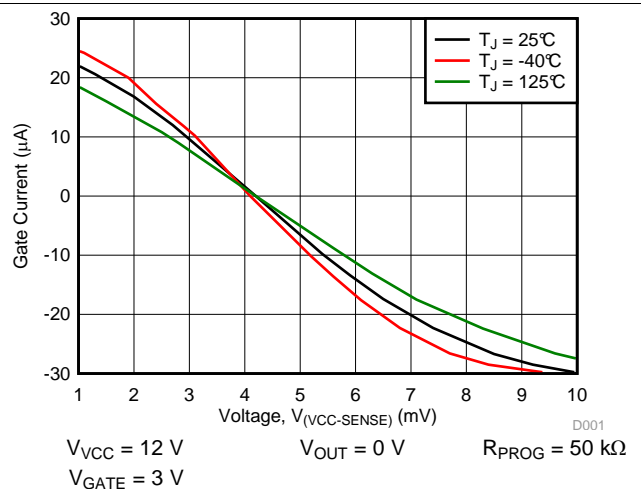
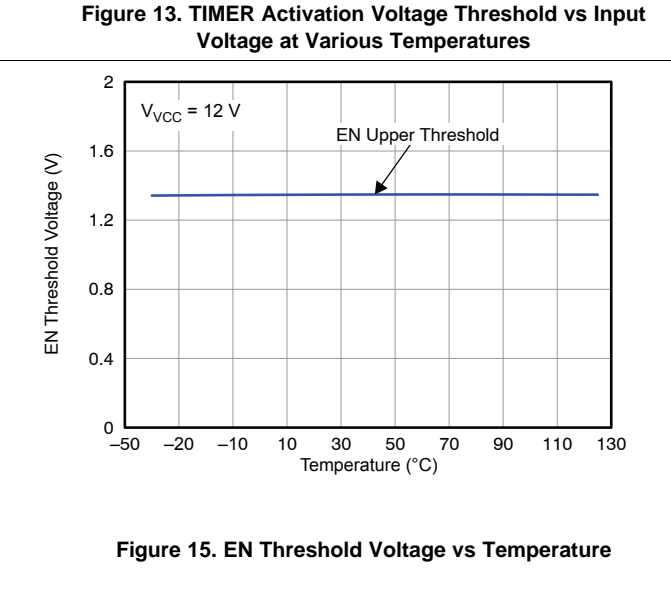
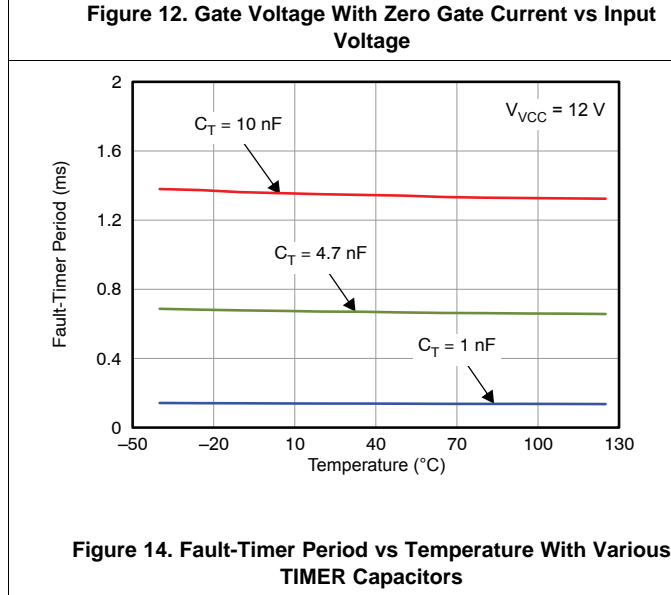
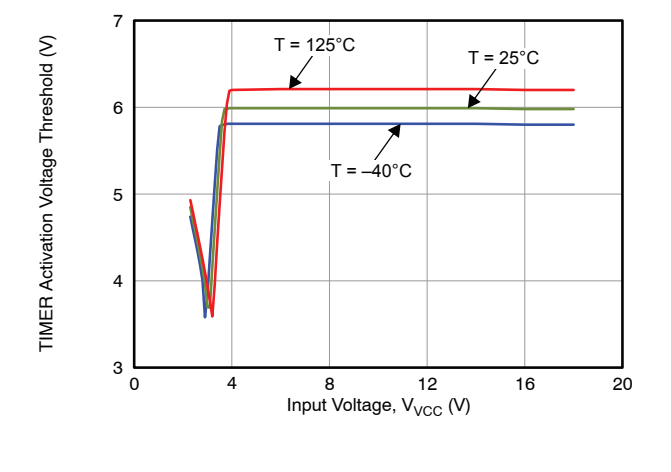
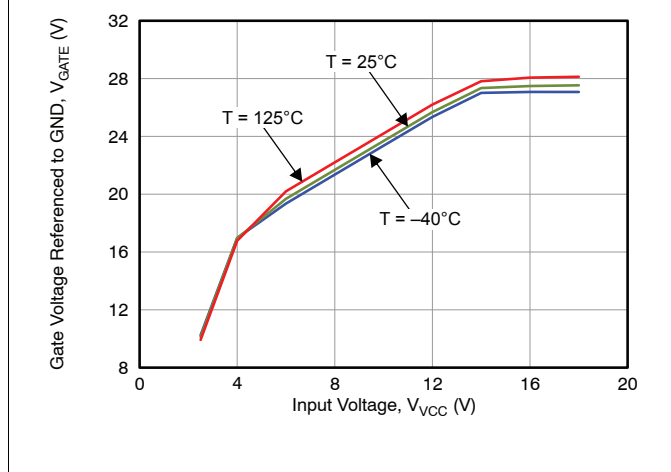
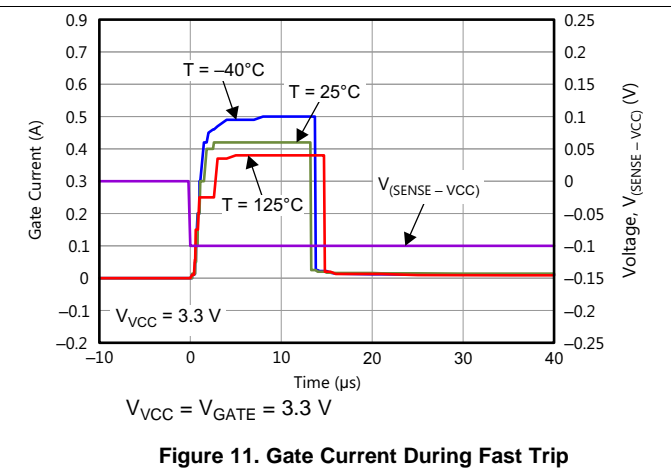
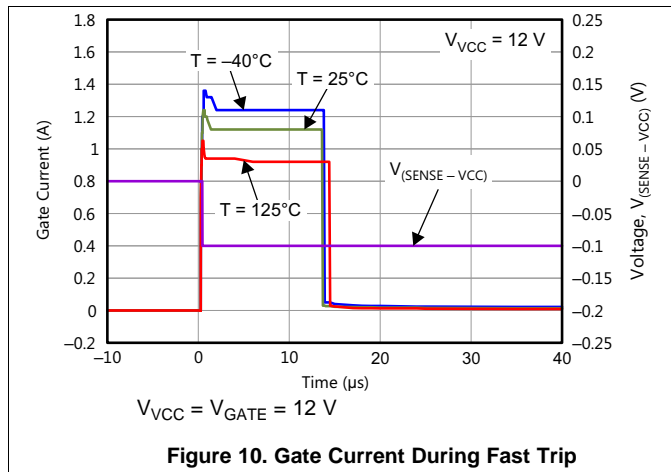

Figure 9. Gate Current vs V_{VCC_SENSE}

Typical Characteristics (continued)



Typical Characteristics (continued)

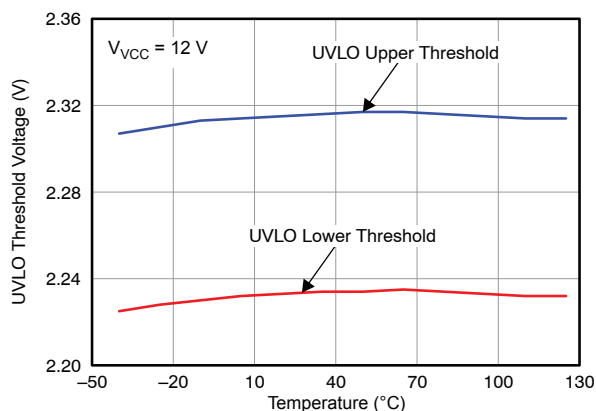

Figure 16. UVLO Threshold Voltage vs Temperature

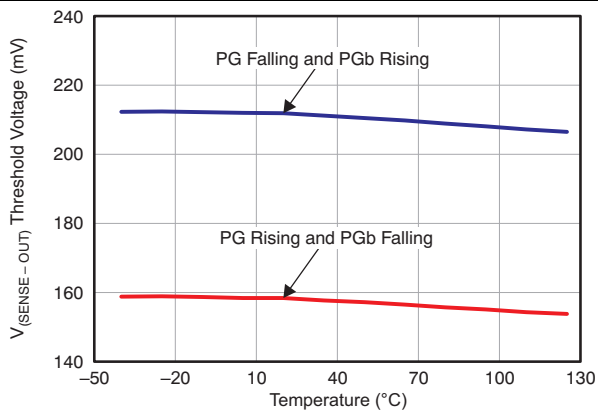

Figure 17. Threshold Voltage of V_{DS} vs Temperature, PGb and PG Rising and Falling

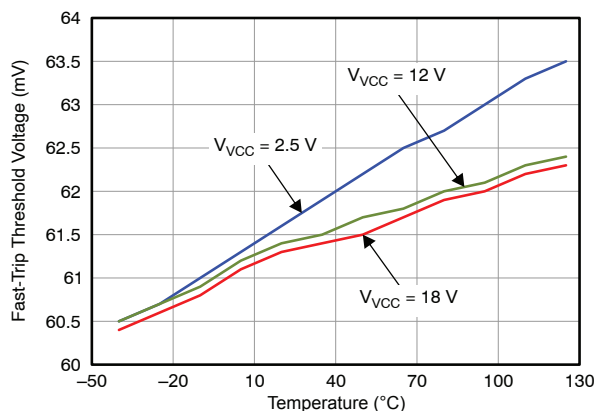

Figure 18. Fast-Trip Threshold Voltage vs Temperature

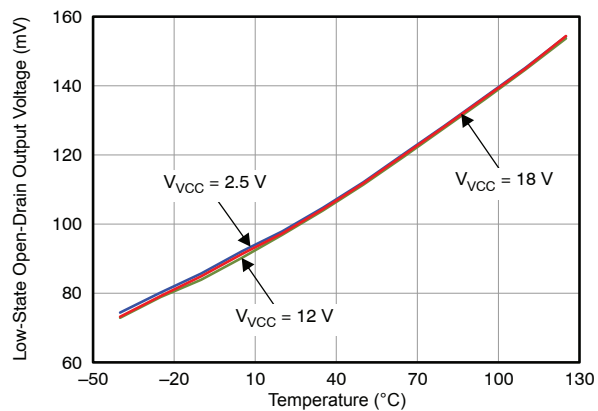

Figure 19. PG and PGb Open-Drain Output Voltage in Low State

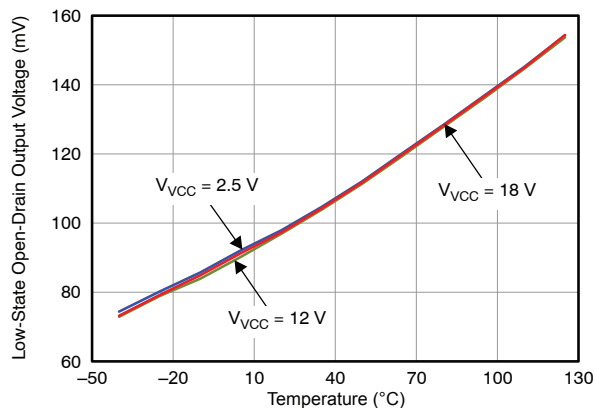

Figure 20. FLT and FLTb Open-Drain Output Voltage in Low State

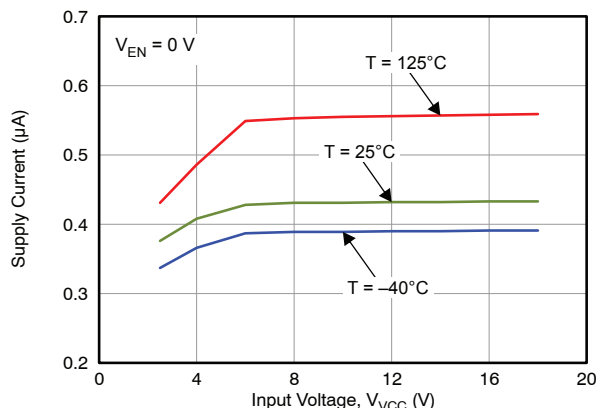

Figure 21. Supply Current vs Input Voltage at Various Temperatures When EN Pulled Low

Typical Characteristics (continued)

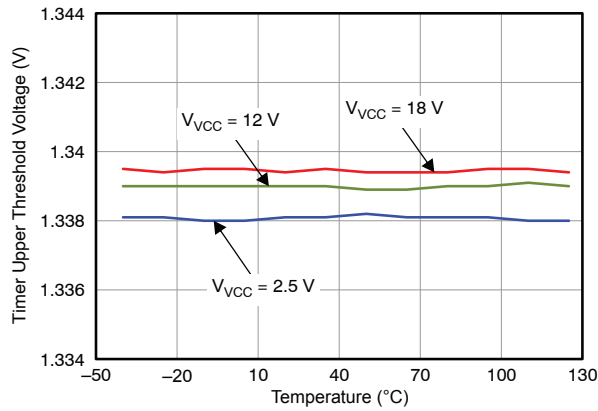

Figure 22. Timer Upper Threshold Voltage vs Temperature at Various Input Voltages

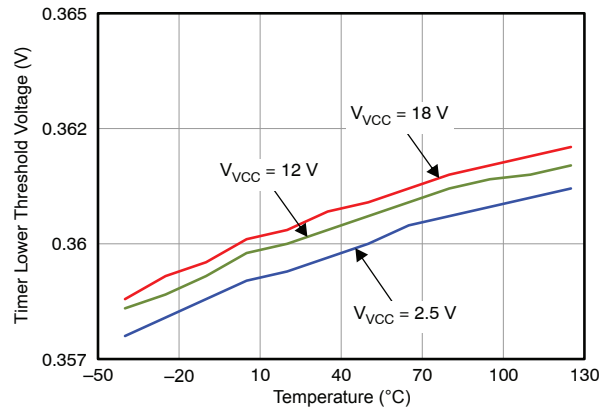

Figure 23. Timer Lower Threshold Voltage vs Temperature at Various Input Voltages

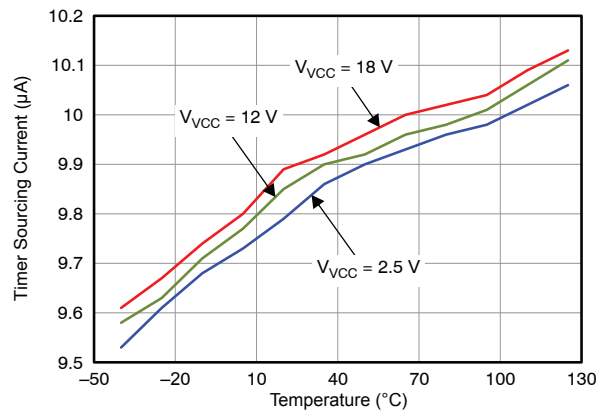

Figure 24. Timer Sourcing Current vs Temperature at Various Input Voltages

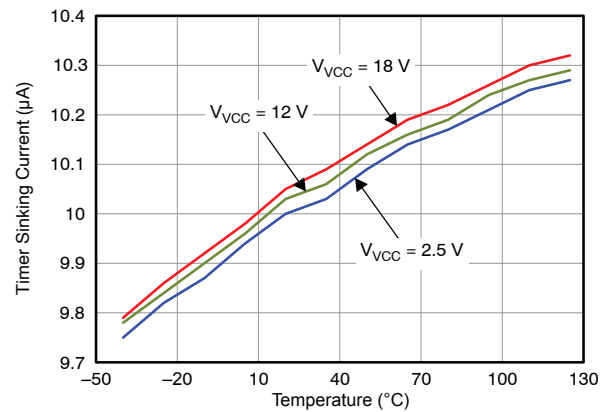

Figure 25. Timer Sinking Current vs Temperature at Various Input Voltages

8 Detailed Description

8.1 Overview

The following description relies on the [典型应用 \(12V/10A\)](#), as well as the functional block diagram in [Figure 26](#).

8.2 Functional Block Diagram

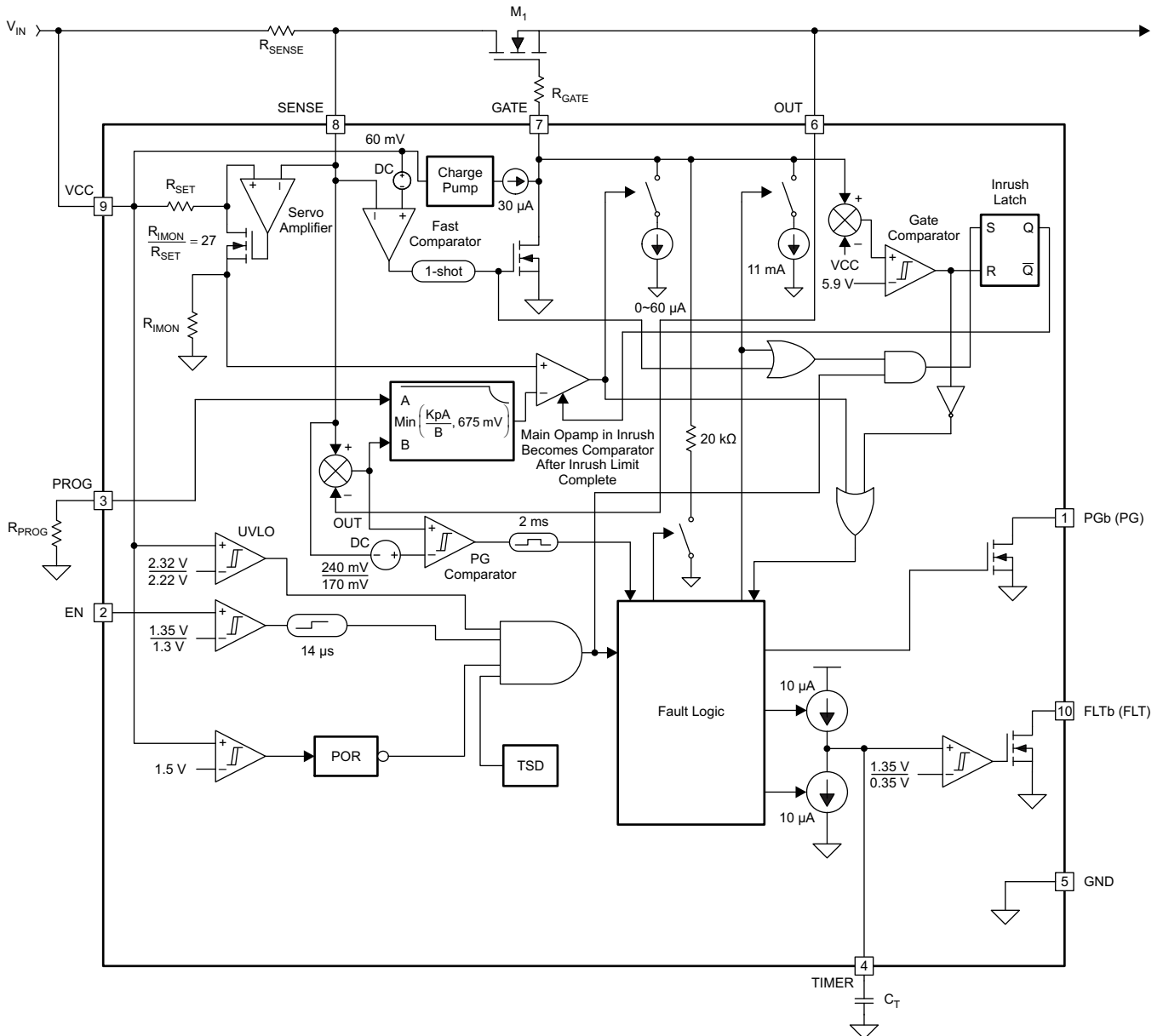

NOTE: Pins 1 and 10 are PG and FLT, respectively, for TPS24712/13

Figure 26. Block Diagram of the TPS24710/11

B0438-02

8.3 Feature Description

8.3.1 DETAILED PIN DESCRIPTIONS

8.3.1.1 EN

Applying a voltage of 1.35 V or more to this pin enables the gate driver. The addition of an external resistor divider allows the EN pin to serve as an undervoltage monitor. Cycling EN low and then back high resets the TPS24710/11/12/13 that has latched off due to a fault condition. This pin should not be left floating.

8.3.1.2 FLT

FLT is assigned for TPS24712/13. This active-high open-drain output assumes high-impedance when TPS24712/13 has remained in current limit long enough for the fault timer to expire. The behavior of the FLT pin depends on the version of the IC. The TPS24712 operates in latch mode and the TPS24713 operates in retry mode. In latch mode, a fault timeout disables the external MOSFET and holds FLT in open drain condition. The latched mode of operation is reset by cycling EN or VCC. In retry mode, a fault timeout first disables the external MOSFET, next waits sixteen cycles of TIMER charging and discharging, and finally attempts a restart. This process repeats as long as the fault persists. In retry mode, the FLT pin goes open-drain whenever the external MOSFET is disabled by the fault timer. In a sustained fault, the FLT waveform becomes a train of pulses. The FLT pin does not assert if the external MOSFET is disabled by EN, overtemperature shutdown, or UVLO. This pin can be left floating when not used.

8.3.1.3 FLTb

FLTb is assigned for TPS24710/11. This active-low open-drain output pulls low when TPS24710/11/12/13 has remained in current limit long enough for the fault timer to expire. The behavior of the FLTb pin depends on the version of the IC. The TPS24710 operates in latch mode and the TPS24711 operates in retry mode. In latch mode, a fault timeout disables the external MOSFET and holds FLTb low. The latched mode of operation is reset by cycling EN or VCC. In retry mode, a fault timeout first disables the external MOSFET, next waits sixteen cycles of TIMER charging and discharging, and finally attempts a restart. This process repeats as long as the fault persists. In retry mode, the FLTb pin is pulled low whenever the external MOSFET is disabled by the fault timer. In a sustained fault, the FLTb waveform becomes a train of pulses. The FLTb pin does not assert if the external MOSFET is disabled by EN, overtemperature shutdown, or UVLO. This pin can be left floating when not used.

8.3.1.4 GATE

This pin provides gate drive to the external MOSFET. A charge pump sources 30 μ A to enhance the external MOSFET. A 13.9-V clamp between GATE and VCC limits the gate-to-source voltage, because V_{VCC} is very close to V_{OUT} in normal operation. During start-up, a transconductance amplifier regulates the gate voltage of M_1 to provide inrush current limiting. The TIMER pin charges timer capacitor C_T during the inrush. Inrush current limiting continues until the $V_{(GATE - VCC)}$ exceeds the Timer Activation Voltage (5.9 V for $V_{VCC} = 12$ V). Then the TPS24710/11/12/13 enters into circuit-breaker mode. The Timer Activation Voltage is defined as a threshold voltage. When $V_{(GATE - VCC)}$ exceeds this threshold voltage, the inrush operation is finished and the TIMER stops sourcing current and begins sinking current. In the circuit-breaker mode, the current flowing in R_{SENSE} is compared with the current-limit threshold derived from the MOSFET power-limit scheme (see PROG). If the current flowing in R_{SENSE} exceeds the current limit threshold, then MOSFET M_1 is turned off. The GATE pin is disabled by the following three conditions:

1. GATE is pulled down by an 11-mA current source when
 - The fault timer expires during an overload current fault ($V_{SENSE} > 25$ mV)
 - V_{EN} is below its falling threshold
 - V_{VCC} drops below the UVLO threshold
2. GATE is pulled down by a 1 A current source for 13.5 μ s when a hard output short circuit occurs and $V_{(VCC - SENSE)}$ is greater than 60 mV, i.e., the fast-trip shutdown threshold. After fast-trip shutdown is complete, an 11-mA sustaining current ensures that the external MOSFET remains off.
3. GATE is discharged by a 20 k Ω resistor to GND if the chip die temperature exceeds the OTSD rising threshold.

Feature Description (continued)

GATE remains low in latch mode (TPS24710/12) and attempts a restart periodically in retry mode (TPS24711/13).

No external resistor should be directly connected from GATE to GND or from GATE to OUT.

8.3.1.5 GND

This pin is connected to system ground.

8.3.1.6 OUT

This pin allows the controller to measure the drain-to-source voltage across the external MOSFET M_1 . The power-good indicator (PG/PGb) relies on this information, as does the power limiting engine. The OUT pin should be protected from negative voltage transients by a clamping diode or sufficient capacitors. A Schottky diode of 3 A / 40 V in a SMC package is recommended as a clamping diode for high-power applications. The OUT pin should be bypassed to GND with a low-impedance ceramic capacitor in the range of 10 nF to 1 μ F.

8.3.1.7 PG

PG is assigned for TPS24712/13. This active-high, open-drain output is intended to interface to downstream dc/dc converters or monitoring circuits. PG assumes high-impedance after the drain-to-source voltage of the FET has fallen below 170 mV and a 3.4-ms deglitch delay has elapsed. It pulls low when V_{DS} exceeds 240 mV. PG assumes low-impedance status after a 3.4-ms deglitch delay once V_{DS} of M_1 rises up, resulting from GATE being pulled to GND at any of the following conditions:

- An overload current fault occurs ($V_{SENSE} > 25$ mV).
- A hard output short circuit occurs, leading to $V_{(VCC - SENSE)}$ greater than 60 mV, i.e., the fast-trip shutdown threshold has been exceeded.
- V_{EN} is below its falling threshold.
- V_{VCC} drops below the UVLO threshold.
- Die temperature exceeds the OTSD threshold.

This pin can be left floating when not used.

8.3.1.8 PGb

PGb is assigned for TPS24710/11. This active-low, open-drain output is intended to interface to downstream dc/dc converters or monitoring circuits. PGb pulls low after the drain-to-source voltage of the FET has fallen below 170 mV and a 3.4-ms deglitch delay has elapsed. It goes open-drain when V_{DS} exceeds 240 mV. PGb assumes high-impedance status after a 3.4-ms deglitch delay once V_{DS} of M_1 rises up, resulting from GATE being pulled to GND at any of the following conditions:

- An overload current fault occurs ($V_{SENSE} > 25$ mV).
- A hard output short circuit occurs, leading to $V_{(VCC - SENSE)}$ greater than 60 mV, i.e., the fast-trip shutdown threshold has been exceeded.
- V_{EN} is below its falling threshold.
- V_{VCC} drops below the UVLO threshold.
- Die temperature exceeds the OTSD threshold.

This pin can be left floating when not used.

8.3.1.9 PROG

A resistor from this pin to GND sets the maximum power permitted in the external MOSFET M_1 during inrush. Do not apply a voltage to this pin. If the constant power limit is not desired, use a PROG resistor of 4.99 k Ω . To set the maximum power, use [Equation 1](#).

$$R_{PROG} = \frac{3125}{P_{LIM} \times R_{SENSE} + 0.9 \text{ mV} \times V_{VCC}} \quad (1)$$

To compute the Power limit based on an existing R_{PROG} use [Equation 2](#).

Feature Description (continued)

$$P_{LIM} = \frac{3125}{R_{PROG} \times R_{SNS}} - \frac{0.9 \text{ mV} \times V_{(VCC-OUT)}}{R_{SNS}} \quad (2)$$

where P_{LIM} is the allowed power limit of MOSFET M_1 . R_{SENSE} is the load-current-monitoring resistor connected between the VCC pin and the SENSE pin. R_{PROG} is the resistor connected from the PROG pin to GND. Both R_{PROG} and R_{SENSE} are in ohms and P_{LIM} is in watts. P_{LIM} is determined by the maximum allowed thermal stress of MOSFET M_1 , given by Equation 3,

$$P_{LIM} < \frac{T_{J(MAX)} - T_{C(MAX)}}{R_{\theta JC(MAX)}} \quad (3)$$

where $T_{J(MAX)}$ is the maximum desired transient junction temperature and $T_{C(MAX)}$ is the maximum case temperature prior to a start or restart. $R_{\theta JC(MAX)}$ is the junction-to-case thermal impedance of the pass MOSFET M_1 in units of °C/W. Both $T_{J(MAX)}$ and $T_{C(MAX)}$ are in °C.

8.3.1.10 SENSE

This pin connects to the negative terminal of R_{SENSE} . It provides a means of sensing the voltage across this resistor, as well as a way to monitor the drain-to-source voltage across the external FET. The current limit I_{LIM} is set by Equation 4.

$$I_{LIM} = \frac{25 \text{ mV}}{R_{SENSE}} \quad (4)$$

A fast trip shutdown occurs when $V_{(VCC - V_{SENSE})}$ exceeds 60 mV.

8.3.1.11 TIMER

A capacitor C_T connected from the TIMER pin to GND determines the overload fault timing. TIMER sources 10 μA when an overload is present, and discharges C_T at 10 μA otherwise. M_1 is turned off when V_{TIMER} reaches 1.35 V. In an application implementing auto-retry after a fault, this capacitor also determines the period before the external MOSFET is re-enabled. A minimum timing capacitance of 1 nF is recommended to ensure proper operation of the fault timer. The value of C_T can be calculated from the desired fault time t_{FLT} , using Equation 5.

$$C_T = \frac{10 \mu\text{A}}{1.35 \text{ V}} \times t_{FLT} \quad (5)$$

The latch mode (TPS24710/12) or the retry mode (TPS24711/13) occurs if the load current exceeds the current limit threshold or the fast-trip shutdown threshold. While in latch mode, the TIMER pin continues to charge and discharge the attached capacitor periodically. In retry mode, the external MOSFET is disabled for sixteen cycles of TIMER charging and discharging. The TIMER pin is pulled to GND by a 2-mA current source at the end of the 16th cycle of charging and discharging. The external MOSFET is then re-enabled. The TIMER pin capacitor, C_T , can also be discharged to GND during latch mode or retry mode by a 2-mA current source whenever any of the following occurs:

- V_{EN} is below its falling threshold.
- V_{VCC} drops below the UVLO threshold.

8.3.1.12 VCC

This pin performs three functions. First, it provides biasing power to the integrated circuit. Second, it serves as an input to the power-on reset (POR) and undervoltage lockout (UVLO) functions. The VCC trace from the integrated circuit should connect directly to the positive terminal of R_{SENSE} to minimize the voltage sensing error. Bypass capacitor C_1 , shown in the typical application diagram on the front page, should be connected to the positive terminal of R_{SENSE} . A capacitance of at least 10 nF is recommended.

8.4 Device Functional Modes

The TPS24710/11/12/13 provides all the features needed for a positive hot-swap controller. These features include:

- Undervoltage lockout
- Adjustable (system-level) enable
- turn-on inrush limiting
- High-side gate drive for an external N-channel MOSFET
- MOSFET protection by power limiting
- Adjustable overload timeout — also called an electronic circuit breaker
- Charge-complete indicator for downstream converter coordination
- A choice of latch (TPS24710/12) or automatic restart mode (TPS24711/13)

The [典型应用 \(12V/10A\)](#), and oscilloscope plots shown in [Figure 27](#) through [Figure 29](#) and [Figure 31](#) through [Figure 34](#), demonstrate many of the functions described previously.

8.4.1 Board Plug In

[Figure 27](#) and [Figure 28](#) illustrate the inrush current that flows when a hot swap board under the control of the TPS24710/11/12/13 is plugged into a system bus. Only the bypass capacitor charge current and small bias currents are evident when a board is first plugged in. The TPS24710/11/12/13 is held inactive, for a short period while internal voltages stabilize. During this period GATE, PROG, TIMER are held low and PG, FLT, PGb, and FLTb are held open drain. When the voltage on the internal VCC rail exceeds approximately 1.5 V, the power-on reset (POR) circuit initializes the TPS24710/11/12/13 and a start-up cycle is ready to take place.

GATE, PROG, TIMER, PG, FLT, PGb, and FLTb are released after the internal voltages have stabilized and the external EN (enable) thresholds have been exceeded. The part begins sourcing current from the GATE pin to turn on MOSFET M₁. The TPS24710/11/12/13 monitors both the drain-to-source voltage across MOSFET M₁ and the drain current passing through it. Based on these measurements, the TPS24710/11/12/13 limits the drain current by controlling the gate voltage so that the power dissipation within the MOSFET does not exceed the power limit programmed by the user. The current increases as the voltage across the MOSFET decreases until finally the current reaches the current limit I_{LIM} .

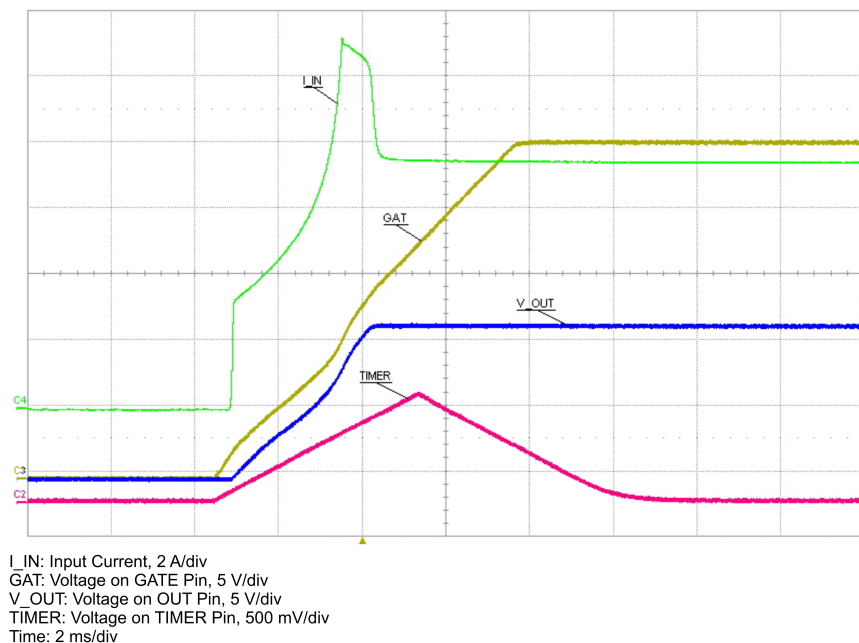

C001

Figure 27. Inrush Mode at Hot-Swap Circuit Insertion

Device Functional Modes (continued)

8.4.2 Inrush Operation

After TPS24710/11/12/13 initialization is complete (as described in the Board Plug-In section) and EN is active, GATE is enabled (V_{GATE} starts increasing). When V_{GATE} reaches the MOSFET M1 gate threshold, a current flows into the downstream bulk storage capacitors. When this current exceeds the limit set by the power limit engine, the gate of the MOSFET is regulated by a feedback loop to make the MOSFET current rise in a controlled manner. This not only limits the inrush current charging capacitance but it also limits the power dissipation of the MOSFET to safe levels. A more complete explanation of the power limiting scheme is given in the section entitled *Action of the Constant Power Engine*. When Gate is enabled, the TIMER pin begins to charge the timing capacitor C_T with a current of approximately $10\ \mu\text{A}$. The TIMER pin continues to charge C_T until $V_{(GATE - VCC)}$ reaches the timer activation voltage (5.9 V for $V_{VCC} = 12\ \text{V}$). The TIMER then begins to discharge C_T with a current of approximately $10\ \mu\text{A}$. This indicates that the inrush mode is finished. If the TIMER exceeds its upper threshold of 1.35 V before $V_{(GATE - VCC)}$ reaches the timer activation voltage, the GATE pin is pulled to GND and the hot-swap circuit enters either latch mode (TPS24710/12) or auto-retry mode (TPS24711/13).

The power limit feature is disabled once the inrush operation is finished and the hotswap circuit becomes a circuit breaker. The TPS24710/11/12/13 will turn off the MOSFET, M1, after a fault timer period once the load exceeds the current limit threshold.

8.4.3 Action of the Constant-Power Engine

Figure 28 illustrates the operation of the constant-power engine during start-up. The circuit used to generate the waveforms of Figure 28 was programmed to a power limit of 29.3 W by means of the resistor connected between PROG and GND. At the moment current begins to flow through the MOSFET, a voltage of 12 V appears across it (input voltage $V_{VCC} = 12\ \text{V}$), and the constant-power engine therefore allows a current of 2.44 A (equal to 29.3 W divided by 12 V) to flow. This current increases in inverse ratio as the drain-to-source voltage diminishes, so as to maintain a constant dissipation of 29.3 W. The constant-power engine adjusts the current by altering the reference signal fed to the current limit amplifier. The lower part of Figure 29 shows the measured power dissipated within the MOSFET, labeled *FET PWR*, remaining substantially constant during this period of operation, which ends when the current through the MOSFET reaches the current limit I_{LIM} . This behavior can be considered a form of foldback limiting, but unlike the standard linear form of foldback limiting, it allows the power device to operate near its maximum capability, thus reducing the start-up time and minimizing the size of the required MOSFET.

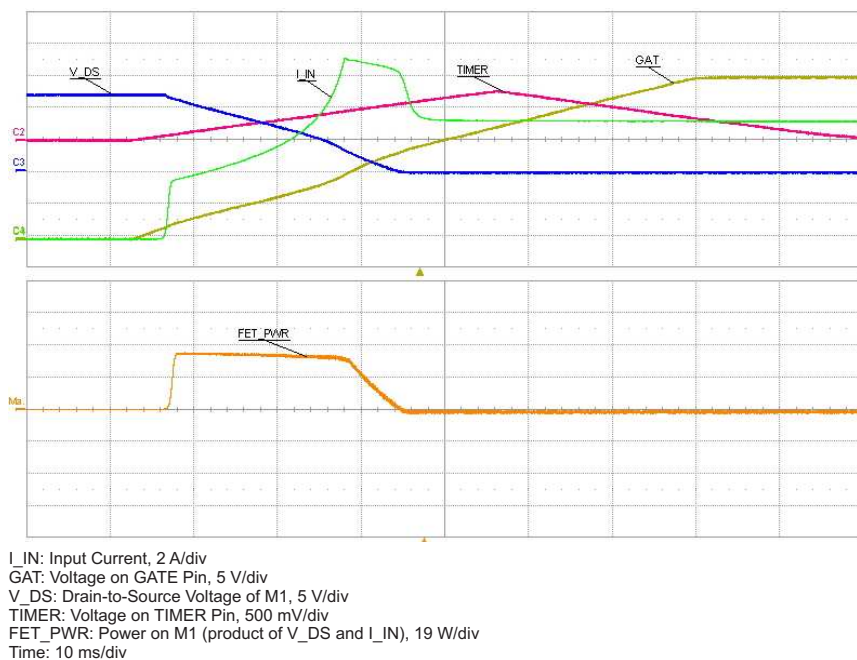

C002

Figure 28. Computation of M_1 Power Stress During Start-Up

Device Functional Modes (continued)

8.4.4 Circuit Breaker and Fast Trip

The TPS24710/11/12/13 monitors load current by sensing the voltage across R_{SENSE} . The TPS24710/11/12/13 incorporates two distinct thresholds: a current-limit threshold and a fast-trip threshold.

The functions of circuit breaker and fast-trip turn off are shown in Figure 29 through Figure 32.

Figure 29 shows the behavior of the TPS24710/11 when a fault in the output load causes the current passing through R_{SENSE} to increase to a value above the current limit but less than the fast-trip threshold. When the current exceeds the current-limit threshold, a current of approximately 10 μA begins to charge timing capacitor C_T . If the voltage on C_T reaches 1.35 V, then the external MOSFET is turned off. The TPS24710 latches off and the TPS24711 commences a restart cycle. In either event, fault pin FLTb pulls low to signal a fault condition. Overload between the current limit and the fast trip threshold is permitted for this period. This shutdown scheme is sometimes called an electronic circuit breaker.

The fast-trip threshold protects the system against a severe overload or a dead short circuit. When the voltage across the sense resistor R_{SENSE} exceeds the 60 mV fast-trip threshold, the GATE pin immediately pulls the external MOSFET gate to ground with approximately 1 A of current. This extremely rapid shutdown may generate disruptive transients in the system, in which case a low-value resistor inserted between the GATE pin and the MOSFET gate can be used to moderate the turn off current. The fast-trip circuit holds the MOSFET off for only a few microseconds, after which the TPS24710/11/12/13 turns back on slowly, allowing the current-limit feedback loop to take over the gate control of M_1 . Then the hot-swap circuit goes into either latch mode (TPS24710/12) or auto-retry mode (TPS24711/13). Figure 31 and Figure 32 illustrate the behavior of the system implementing TPS24710/11 when the current exceeds the fast-trip threshold.

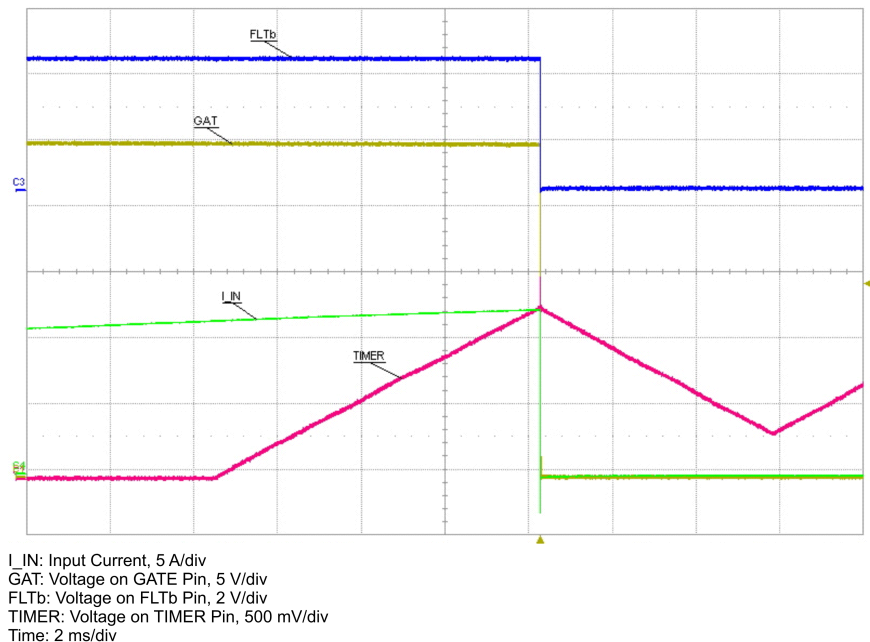

C003

Figure 29. Circuit Breaker Mode During Over Load Condition

Device Functional Modes (continued)

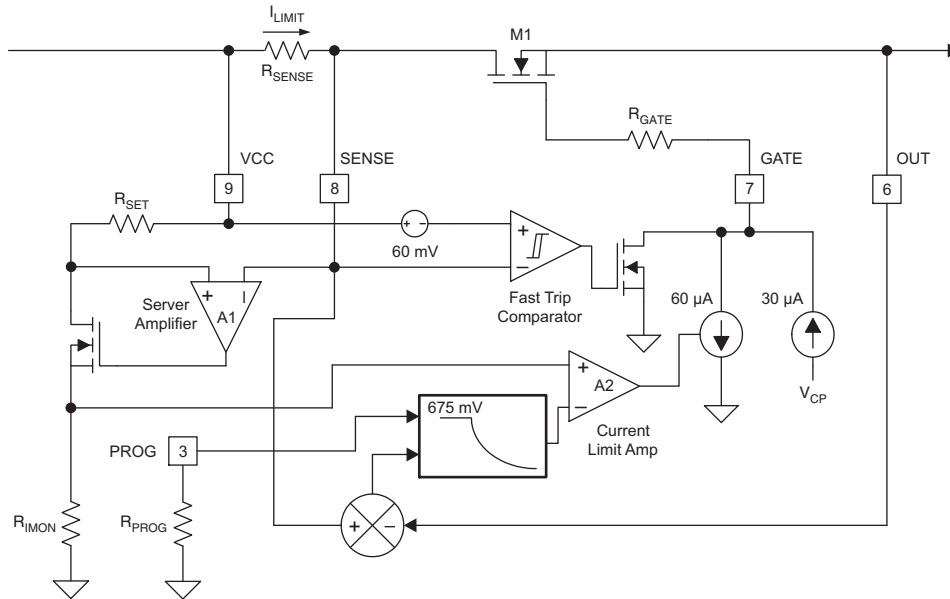

B0439-02

Figure 30. Partial Diagram of the TPS24710/11/12/13 With Selected External Components

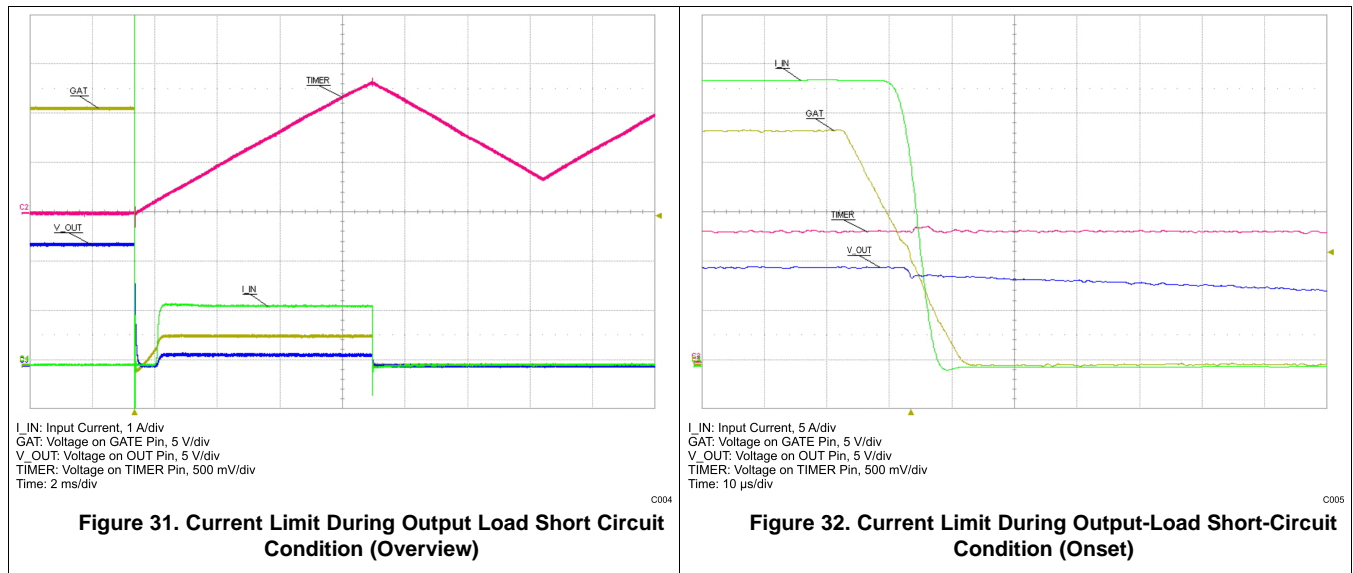

Figure 31. Current Limit During Output Load Short Circuit Condition (Overview)

Figure 32. Current Limit During Output-Load Short-Circuit Condition (Onset)

Device Functional Modes (continued)

8.4.5 Automatic Restart

The TPS24711/13 automatically initiates a restart after a fault has caused it to turn off the external MOSFET M_1 . Internal control circuits use C_T to count 16 cycles before re-enabling M_1 as shown in Figure 33 (TPS24711). This sequence repeats if the fault persists. The timer has a 1 : 1 charge-to-discharge current ratio. For the very first cycle, the TIMER pin starts from 0 V and rises to the upper threshold of 1.35 V and subsequently falls to 0.35 V before restarting. For the following 16 cycles, 0.35 V is used as the lower threshold. This small duty cycle often reduces the average short-circuit power dissipation to levels associated with normal operation and eliminates special thermal considerations for surviving a prolonged output short.

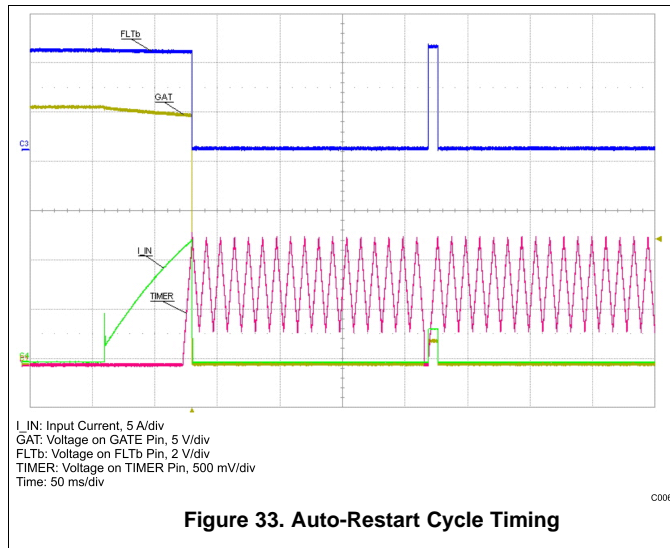

Figure 33. Auto-Restart Cycle Timing

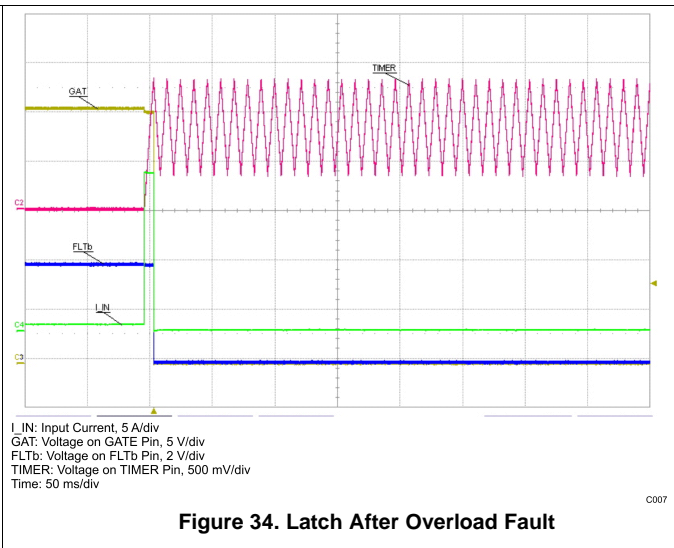

Figure 34. Latch After Overload Fault

8.4.6 PG, FLT, PGb, FLTb, and Timer Operations

The open-drain PG/PGb (PG is for TPS24712/13 and PGb is for TPS24710/11) output provides a deglitched end-of-inrush indication based on the voltage across M_1 . PG/PGb is useful for preventing a downstream dc/dc converter from starting while its input capacitor C_{OUT} is still charging. PG goes active-high and PGb goes active-low about 3.4 ms after C_{OUT} is charged. This delay allows M_1 to fully turn on and any transients in the power circuits to end before the converter starts up. This type of sequencing prevents the downstream converter from demanding full current before the power-limiting engine allows the MOSFET to conduct the full current set by the current limit I_{LIM} . Failure to observe this precaution may prevent the system from starting. The pullup resistor shown on the PG/PGb pin in the typical application diagram on the front page is illustrative only; the actual connection to the converter depends on the application. The PG/PGb pin may indicate that inrush has ended before the MOSFET is fully enhanced, but the downstream capacitor will have been charged to substantially its full operating voltage. Care should be taken to ensure that the MOSFET on-resistance is sufficiently small to ensure that the voltage drop across this transistor is less than the minimum power-good threshold of 140 mV. After the hot-swap circuit successfully starts up, the PG pin can return to a low-impedance status and PGb to high-impedance status whenever the drain-to-source voltage of MOSFET M_1 exceeds its upper threshold of 340 mV, which presents the downstream converters a warning flag. This flag may occur as a result of overload fault, output short fault, input overvoltage, higher die temperature, or the GATE shutdown by UVLO and EN.

FLT/FLTb (FLT is for TPS24712/13 and FLTb is for TPS24710/11) is an indicator that the allowed fault-timer period during which the load current can exceed the programmed current limit (but not the fast-trip threshold) has expired. The fault timer starts when a current of approximately 10 μ A begins to flow into the external capacitor, C_T , and ends when the voltage of C_T reaches TIMER upper threshold, i.e., 1.35 V. FLT goes high and FLTb pulls low at the end of the fault timer. Otherwise, FLT assumes a low-impedance state and FLTb a high-impedance state.

The fault-timer state requires an external capacitor C_T connected between the TIMER pin and GND pin. The length of the fault timer is the charging time of C_T from 0 V to its upper threshold of 1.35 V. The fault timer begins to count under any of the following three conditions:

Device Functional Modes (continued)

1. In the inrush mode, TIMER begins to source current to the timer capacitor, C_T , when MOSFET M_1 is enabled. TIMER begins to sink current from the timer capacitor, C_T when $V_{(GATE - VCC)}$ exceeds the timer activation voltage (see the *Inrush Operation* section). If $V_{(GATE - VCC)}$ does not reach the timer activation voltage before TIMER reaches 1.35 V, then the TPS24710/11/12/13 disables the external MOSFET M_1 . After the MOSFET turns off, the timer goes into either latch mode (TPS24710/12) or retry mode (TPS24711/13).
2. In an overload fault, TIMER begins to source current to the timer capacitor, C_T , when the load current exceeds the programmed current limits. When the timer capacitor voltage reaches its upper threshold of 1.35 V, TIMER begins to sink current from the timer capacitor, C_T , and the GATE pin is pulled to ground. After the fault timer period, TIMER may go into latch mode (TPS24710/12) or retry mode (TPS24711/13).
3. In output short-circuit fault, TIMER begins to source current to the timer capacitor, C_T , when the load current exceeds the programmed current limits following a fast-trip shutdown of M_1 . When the timer capacitor voltage reaches its upper threshold of 1.35 V, TIMER begins to sink current from the timer capacitor, C_T , and the GATE pin is pulled to ground. After the fault timer period, TIMER may go into latch mode (TPS24710/12) or retry mode (TPS24711/13).

If the fault current drops below the programmed current limit within the fault timer period, V_{TIMER} decreases and the pass MOSFET remains enabled.

The behaviors of TIMER are different in the latch mode (TPS24710/12) and retry mode (TPS24711/13). If the timer capacitor reaches the upper threshold of 1.35 V, then:

- In latch mode, the GATE remains low and the TIMER pin continues to charge and discharge the attached capacitor periodically until TPS24710/12 is disabled by UVLO or EN as shown in [Figure 34](#).
- In retry mode, TIMER charges and discharges C_T between the lower threshold of 0.35 V and the upper threshold of 1.35 V for sixteen cycles before the TPS24711/13 attempts to re-start. The TIMER pin is pulled to GND at the end of the 16th cycle of charging and discharging and then ramps from 0 V to 1.35 V for the initial half-cycle in which the GATE pin sources current. This periodic pattern is stopped once the overload fault is removed or the TPS24711/13 is disabled by UVLO or EN.

8.4.7 Overtemperature Shutdown

The TPS24710/11/12/13 includes a built-in overtemperature shutdown circuit designed to disable the gate driver if the die temperature exceeds approximately 140°C. An overtemperature condition also causes the FLT, PG, FLTb and PGb pins to go to high-impedance states. Normal operation resumes once the die temperature has fallen approximately 10°C.

Device Functional Modes (continued)

8.4.8 Start-Up of Hot-Swap Circuit by VCC or EN

The connection and disconnection between a load and the system bus are controlled by turning on and turning off the MOSFET, M_1 .

The TPS24710/11/12/13 has two ways to turn on MOSFET M_1 :

1. Increasing V_{VCC} above UVLO upper threshold while EN is already higher than its upper threshold sources current to the GATE pin. After an inrush period, TPS24710/11/12/13 fully turns on MOSFET M_1 .
2. Increasing EN above its upper threshold while V_{VCC} is already higher than UVLO upper threshold sources current to the GATE pin. After an inrush period, TPS24710/11/12/13 fully turns on MOSFET M_1 .

The EN pin can be used to start up the TPS24710/11/12/13 at a selected input voltage V_{VCC} .

To isolate the load from the system bus, the GATE pin sinks current and pulls the gate of MOSFET M_1 low. The MOSFET can be disabled by any of the following conditions: UVLO, EN, load current above current limit threshold, hard short at load, or OTSD. Three separate conditions pull down the GATE pin:

1. GATE is pulled down by an 11-mA current source when any of the following occurs.
 - The fault timer expires during an overload current fault ($V_{SENSE} > 25$ mV).
 - V_{EN} is below its falling threshold.
 - V_{VCC} drops below the UVLO threshold.
2. GATE is pulled down by a 1-A current source for 13.5 μ s when a hard output short circuit occurs and $V_{(VCC - SENSE)}$ is greater than 60 mV, i.e., the fast-trip shutdown threshold. After fast-trip shutdown is complete, an 11-mA sustaining current ensures that the external MOSFET remains off.
3. GATE is discharged by a 20-k Ω resistor to GND if the chip die temperature exceeds the OTSD rising threshold.

9 Application and Implementation

NOTE

Information in the following applications sections is not part of the TI component specification, and TI does not warrant its accuracy or completeness. TI's customers are responsible for determining suitability of components for their purposes. Customers should validate and test their design implementation to confirm system functionality.

9.1 Application Information

The TPS2471x is a hotswap used to manage inrush current and provide load fault protection. When designing a hotswap, three key scenarios should be considered:

- Start-up
- Output of a hotswap is shorted to ground when the hotswap is on. This is often referred to as a hot-short.
- Powering-up a board when the output and ground are shorted. This is usually called a start-into-short.

Each of these scenarios place stress on the hotswap MOSFET. Take special care when designing the hotswap circuit to keep the MOSFET within its SOA. The following design example is provided as a guide. Use the TPS24710 Design Calculator ([SLVC566](#)) to assist with the detailed design equation calculations.

9.2 Typical Application

This section provides an application example utilizing power limited start-up and MOSFET SOA protection. The design parameters are listed in the [Design Requirements](#) section and represent a more moderate level of fault current. For more stringent current levels, refer to either the TPS2471xEVM ([SLUU459](#)) (25 A design) or the calculator tool ([SLVC566](#)) (50 A design).

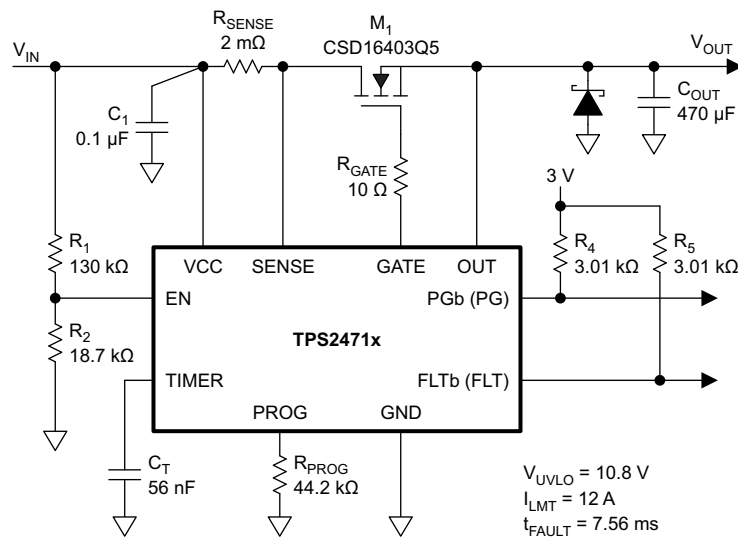

Figure 35. Typical Application (12 V at 10 A)

Typical Application (continued)

9.2.1 Design Requirements

For this design example, use the parameters shown in Table 1.

Table 1. Design Parameters

PARAMETER	VALUE
Input voltage	12 V \pm 2V
Maximum operating load current	10 A
Operating temperature	20°C –50°C
Fault trip current	12 A
Load capacitance	470 μ F

9.2.2 Detailed Design Procedure

9.2.2.1 Power-Limited Start-Up

This design example assumes a 12-V system voltage with an operating tolerance of ± 2 V. The rated load current is 10 A, corresponding to a dc load of 1.2 Ω . If the current exceeds 12 A, then the controller should shut down and then attempt to restart. Ambient temperatures may range from 20°C to 50°C. The load has a minimum input capacitance of 470 μ F. Figure 36 shows a simplified system block diagram of the proposed application.

This design procedure seeks to control the junction temperature of MOSFET M_1 under both static and transient conditions by proper selection of package, cooling, $r_{DS(on)}$, current limit, fault timeout, and power limit. The design procedure further assumes that a unit running at full load and maximum ambient temperature experiences a brief input-power interruption sufficient to discharge C_{OUT} , but short enough to keep M_1 from cooling. A full C_{OUT} recharge then takes place. Adjust this procedure to fit your application and design criteria.

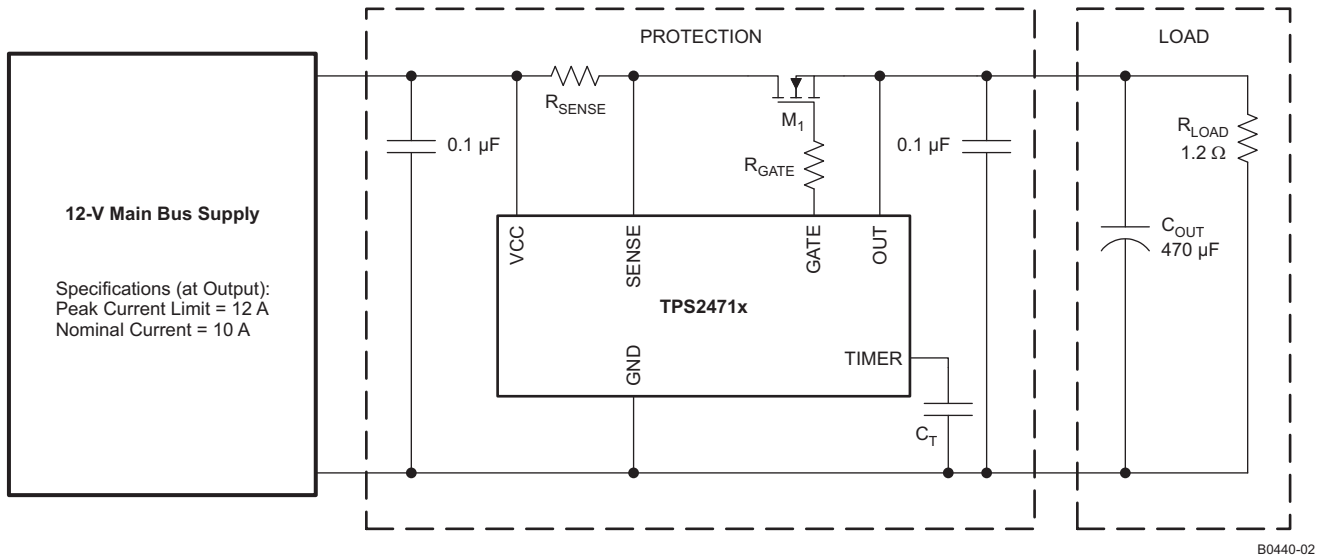

Figure 36. Simplified Block Diagram of the System Constructed in the Design Example

9.2.2.1.1 STEP 1. Choose R_{SENSE}

From the TPS24710/11/12/13 electrical specifications, the current-limit threshold voltage, $V_{(\text{VCC} - \text{SENSE})}$, is around 25 mV. A resistance of 2 m Ω is selected for the peak current limit of 12 A, while dissipating only 200 mW at the rated 10-A current (see Equation 6). This represents a 0.17% power loss.

$$R_{\text{SENSE}} = \frac{V_{(\text{VCC} - \text{SENSE})}}{I_{\text{LIM}}},$$

therefore,

$$R_{\text{SENSE}} = \frac{25 \text{ mV}}{12 \text{ A}} \approx 2 \text{ m}\Omega \quad (6)$$

9.2.2.1.2 STEP 2. Choose MOSFET M_1

The next design step is to select M_1 . The TPS24710/11/12/13 is designed to use an N-channel MOSFET with a gate-to-source voltage rating of 20 V.

Devices with lower gate-to-source voltage ratings can be used if a Zener diode is connected so as to limit the maximum gate-to-source voltage across the transistor.

The next factor to consider is the drain-to-source voltage rating, $V_{\text{DS}(\text{MAX})}$, of the MOSFET. Although the MOSFET only sees 12 V DC, it may experience much higher transient voltages during extreme conditions, such as the abrupt shutoff that occurs during a fast trip. A TVS may be required to limit inductive transients under such conditions. A transistor with a $V_{\text{DS}(\text{MAX})}$ rating of at least twice the nominal input power-supply voltage is recommended regardless of whether a TVS is used or not.

Next select the on resistance of the transistor, $r_{\text{DS}(\text{on})}$. The maximum on-resistance must not generate a voltage greater than the minimum power-good threshold voltage of 140 mV. Assuming a current limit of 12 A, a maximum $r_{\text{DS}(\text{on})}$ of 11.67 m Ω is required. Also consider the effect of $r_{\text{DS}(\text{on})}$ upon the maximum operating temperature $T_{\text{J}(\text{MAX})}$ of the MOSFET. Equation 7 computes the value of $r_{\text{DS}(\text{on})(\text{MAX})}$ at a junction temperature of $T_{\text{J}(\text{MAX})}$. Most manufacturers list $r_{\text{DS}(\text{on})(\text{MAX})}$ at 25°C and provide a derating curve from which values at other temperatures can be derived. Compute the maximum allowable on-resistance, $r_{\text{DS}(\text{on})(\text{MAX})}$, using Equation 7.

$$r_{\text{DS}(\text{on})(\text{MAX})} = \frac{T_{\text{J}(\text{MAX})} - T_{\text{A}(\text{MAX})}}{I_{\text{MAX}}^2 \times R_{\theta\text{JA}}},$$

therefore,

$$r_{\text{DS}(\text{on})(\text{MAX})} = \frac{150^\circ\text{C} - 50^\circ\text{C}}{(12 \text{ A})^2 \times 51^\circ\text{C}/\text{W}} = 13.6 \text{ m}\Omega \quad (7)$$

Taking these factors into consideration, the TI CSD16403Q5 was selected for this example. This transistor has a $V_{\text{GS}(\text{MAX})}$ rating of 16 V, a $V_{\text{DS}(\text{MAX})}$ rating of 25 V, and a maximum $r_{\text{DS}(\text{on})}$ of 2.8 m Ω at room temperature. During normal circuit operation, the MOSFET can have up to 10 A flowing through it. The power dissipation of the MOSFET equates to 0.24 W and a 9.6°C rise in junction temperature. This is well within the data sheet limits for the MOSFET. The power dissipated during a fault (e.g., output short) is far larger than the steady-state power. The power handling capability of the MOSFET must be checked during fault conditions.

9.2.2.1.3 STEP 3. Choose Power-Limit Value, P_{LIM} , and R_{PROG}

MOSFET M_1 dissipates large amounts of power during inrush. The power limit P_{LIM} of the TPS24710/11/12/13 should be set to prevent the die temperature from exceeding a short-term maximum temperature, $T_{J(MAX)2}$. The short-term $T_{J(MAX)2}$ could be set as high as 130°C while still leaving ample margin to the usual manufacturer's rating of 150°C. Equation 8 is an expression for calculating P_{LIM} ,

$$P_{LIM} \leq 0.8 \times \frac{T_{J(MAX)2} - \left[(I_{MAX}^2 \times r_{DS(on)} \times R_{\theta CA}) + T_{A(MAX)} \right]}{R_{\theta JC}},$$

therefore,

$$P_{LIM} \leq 0.8 \times \frac{130^\circ\text{C} - \left[\left((12 \text{ A})^2 \times 0.002 \Omega \times (51^\circ\text{C/W} - 1.8^\circ\text{C/W}) \right) + 50^\circ\text{C} \right]}{1.8^\circ\text{C/W}} = 29.3 \text{ W} \quad (8)$$

where $R_{\theta JC}$ is the junction-to-case thermal resistance of the MOSFET, $r_{DS(on)}$ is the resistance at the maximum operating temperature, and the factor of 0.8 represents the tolerance of the constant-power engine. For an ambient temperature of 50°C, the calculated maximum P_{LIM} is 29.3 W. From Equation 2, a 44.2-kΩ, 1% resistor is selected for R_{PROG} (see Equation 9).

$$R_{PROG} = \frac{3125}{P_{LIM} \times R_{SENSE} + 0.9 \text{ mV} \times V_{VCC(MAX)}}$$

therefore,

$$R_{PROG} = \frac{3125}{29.3 \times 0.002 \Omega + 0.0009 \text{ V} \times 14 \text{ V}} = 43.89 \text{ k}\Omega \quad (9)$$

V_{SNS-PL_MIN} is the minimum sense voltage during power limit operation. Due to offsets of internal amplifiers, programmed power limit (P_{LIM}) accuracy degrades at low V_{SNS-PL_MIN} and could cause start-up issues. To ensure reliable operation, verify that $V_{SNS-PL_MIN} > 3 \text{ mV}$ using Equation 10.

$$V_{SNS-PL_MIN} = \frac{P_{LIM} \times R_{SENSE}}{V_{IN_MAX}} = \frac{29.3 \text{ W} \times 2 \text{ m}\Omega}{14 \text{ V}} = 4.19 \text{ mV} (> 3 \text{ mV}) \quad (10)$$

9.2.2.1.4 STEP 4. Choose Output Voltage Rising Time, t_{ON} , C_T

The maximum output voltage rise time, t_{ON} , set by the timer capacitor C_T must suffice to fully charge the load capacitance C_{OUT} without triggering the fault circuitry. Equation 11 defines t_{ON} for two possible inrush cases. Assuming that only the load capacitance draws current during start-up,

$$t_{ON} = \begin{cases} \frac{C_{OUT} \times P_{LIM}}{2 \times I_{LIM}^2} + \frac{C_{OUT} \times V_{VCC(MAX)}^2}{2 \times P_{LIM}} - \frac{C_{OUT} \times V_{VCC(MAX)}}{I_{LIM}} & \text{if } P_{LIM} < I_{LIM} \times V_{VCC(MAX)} \\ \frac{C_{OUT} \times V_{VCC(MAX)}}{I_{LIM}} & \text{if } P_{LIM} > I_{LIM} \times V_{VCC(MAX)} \end{cases}$$

therefore,

$$t_{ON} = \frac{470 \mu\text{F} \times 29.3 \text{ W}}{2 \times (12 \text{ A})^2} + \frac{470 \mu\text{F} \times (12 \text{ V})^2}{2 \times 29.3 \text{ W}} - \frac{470 \mu\text{F} \times 12 \text{ V}}{12 \text{ A}} = 0.614 \text{ ms} \quad (11)$$

The next step is to determine the minimum fault-timer period. In Equation 11, the output rise time is t_{ON} . This is the amount of time it takes to charge the output capacitor up to the final output voltage. However, the fault timer uses the difference between the input voltage and the gate voltage to determine if the TPS24710/11/12/13 is still in inrush limit. The fault timer continues to run until V_{GS} rises 5.9 V (for $V_{VCC} = 12$ V) above the input voltage. Some additional time must be added to the charge time to account for this additional gate voltage rise. The minimum fault time can be calculated using Equation 12,

$$t_{FLT} = t_{ON} + \frac{5.9 \text{ V} \times C_{ISS}}{I_{GATE}},$$

therefore,

$$t_{FLT} = 0.614 \text{ ms} + \frac{5.9 \text{ V} \times 2040 \text{ pF}}{20 \text{ } \mu\text{A}} = 1.22 \text{ ms} \quad (12)$$

where C_{ISS} is the MOSFET input capacitance and I_{GATE} is the minimum gate sourcing current of TPS24710/11/12/13, or 20 μA . Using the example parameters in Equation 12 and the CSD16403Q5 data sheet (SLPS201) leads to a minimum fault time of 1.22 ms. This time is derived considering the tolerances of C_{OUT} , C_{ISS} , I_{LIM} , P_{LIM} , I_{GATE} , and $V_{VCC(MAX)}$. The fault timer must be set to a value higher than 1.22 ms to avoid turning off during start-up, but lower than any maximum fault time limit determined by the SOA curve (see Figure 38) derated for operating junction temperature.

For this example, select 7 ms to allow for variation of system parameters such as temperature, load, component tolerance, and input voltage. The timing capacitor is calculated in Equation 5 as 52 nF. Selecting the next-highest standard value, 56 nF, yields a 7.56-ms fault time (see Equation 13).

$$C_T = \frac{10 \text{ } \mu\text{A}}{1.35 \text{ V}} \times t_{FLT},$$

therefore,

$$C_T = \frac{10 \text{ } \mu\text{A}}{1.35 \text{ V}} \times 7 \text{ ms} = 52 \text{ nF} \quad (13)$$

9.2.2.1.5 STEP 5. Calculate the Retry-Mode Duty Ratio

In retry mode, the TPS24711/13 is on for one charging cycle and off for 16 charge/discharge cycles, as can be seen in Figure 33. The first C_T charging cycle is from 0 V to 1.35 V, which gives 7.56 ms. The first C_T discharging cycle is from 1.35 V to 0.35 V, which gives 5.6 ms. Therefore, the total time is 7.56 ms + 33 \times 5.6 ms = 192.36 ms. As a result, the retry mode duty ratio is 7.56 ms/192.36 ms = 3.93%.

9.2.2.1.6 STEP 6. Select R_1 and R_2 for UV

Next, select the values of the UV resistors, R_1 and R_2 , as shown in the typical application diagram on the front page. From the TPS24710/11/12/13 electrical specifications, $V_{ENTHRESH} = 1.35$ V. The V_{UV} is the undervoltage trip voltage, which for this example equals 10.7 V.

$$V_{ENTHRESH} = \frac{R_2}{R_1 + R_2} \times V_{VCC} \quad (14)$$

Assume R_1 is 130 k Ω and use Equation 14 to solve for the R_2 value of 18.7 k Ω .

9.2.2.1.7 STEP 7. Choose R_{GATE} , R_4 , R_5 and C_1

In the typical application diagram on the front page, the gate resistor, R_{GATE} , is intended to suppress high-frequency oscillations. A resistor of $10\ \Omega$ will serve for most applications, but if M_1 has a C_{ISS} below $200\ \text{pF}$, then $33\ \Omega$ is recommended. Applications with larger MOSFETs and very short wiring may not require R_{GATE} . R_4 and R_5 are required only if PGb and FLTb are used; these resistors serve as pullups for the open-drain output drivers. The current sunk by each of these pins should not exceed $2\ \text{mA}$ (see the RECOMMENDED OPERATING CONDITIONS table). C_1 is a bypass capacitor to help control transient voltages, unit emissions, and local supply noise while in the disabled state. Where acceptable, a value in the range of $0.001\ \mu\text{F}$ to $0.1\ \mu\text{F}$ is recommended.

9.2.2.2 Additional Design Considerations

9.2.2.2.1 Use of PG/PGb

Use the PG/PGb pin to control and coordinate a downstream dc/dc converter. If this is not done, then a long time delay is needed to allow C_{OUT} to fully charge before the converter starts. An undesirable latch-up condition can be created between the TPS24710/11/12/13 output characteristic and the dc/dc converter input characteristic if the converter starts while C_{OUT} is still charging; the PG/PGb pin is one way to avoid this

9.2.2.2.2 Output Clamp Diode

Inductive loads on the output may drive the OUT pin below GND when the circuit is unplugged or during a current-limit event. The OUT pin ratings can be satisfied by connecting a diode from OUT to GND. The diode should be selected to control the negative voltage at the full short-circuit current. Schottky diodes are generally recommended for this application.

9.2.2.2.3 Gate Clamp Diode

The TPS24710/11/12/13 has a relatively well-regulated gate voltage of $12\ \text{V}$ to $15.5\ \text{V}$ with a supply voltage V_{VCC} higher than $4\ \text{V}$. A small clamp Zener from GATE to source of M_1 is recommended if V_{GS} of M_1 is rated below $12\ \text{V}$. A series resistance of several hundred ohms or a series silicon diode is recommended to prevent the output capacitance from discharging through the gate driver to ground.

9.2.2.2.4 High-Gate-Capacitance Applications

Gate voltage overstress and abnormally large fault current spikes can be caused by large gate capacitance. An external gate clamp Zener diode is recommended to assist the internal Zener if the total gate capacitance of M_1 exceeds about $4000\ \text{pF}$.

9.2.2.2.5 Bypass Capacitors

It is a good practice to provide low-impedance ceramic capacitor bypassing of the VCC and OUT pins. Values in the range of $10\ \text{nF}$ to $1\ \mu\text{F}$ are recommended. Some system topologies are insensitive to the values of these capacitors; however, some are not and require minimization of the value of the bypass capacitor. Input capacitance on a plug-in board may cause a large inrush current as the capacitor charges through the low-impedance power bus when inserted. This stresses the connector contacts and causes a short voltage sag on the input bus. Small amounts of capacitance (e.g., $10\ \text{nF}$ to $0.1\ \mu\text{F}$) are often tolerable in these systems.

9.2.2.2.6 Output Short-Circuit Measurements

Repeatable short-circuit testing results are difficult to obtain. The many details of source bypassing, input leads, circuit layout and component selection, output shorting method, relative location of the short, and instrumentation all contribute to variation in results. The actual short itself exhibits a certain degree of randomness as it microscopically bounces and arcs. Care in configuration and methods must be used to obtain realistic results. Do not expect to see waveforms exactly like those in this data sheet; every setup differs.

9.2.2.2.7 Using Soft Start with TPS2471x

In some applications, it may be desired to have a constant dv/dt ramp on the output of the TPS2471x to ensure a constant inrush current. This is often accomplished by adding a capacitor from GATE to GND as shown in [Figure 37](#). This limits the gate ramp speed, which in turn limits the ramp of the output.

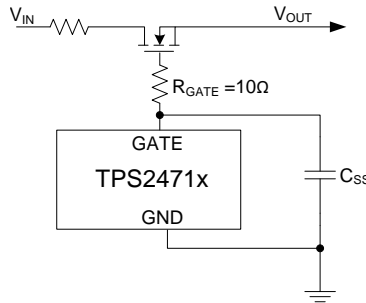

Figure 37. Simplified Diagram for Using Soft Start

Due to the nature of the timer and the gate driver, there are several considerations that must be taken into account when using this type of a design. For a further discussion of this topic, refer to the following Application Note: ([SLVA749](#)).

9.2.3 Application Curve

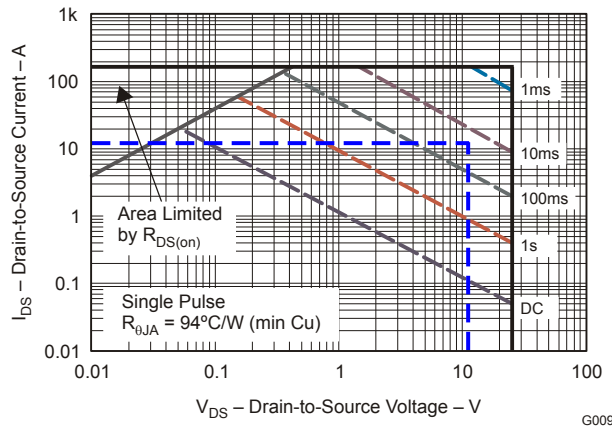

Figure 38. CSD16403Q5 SOA Curve

10 Power Supply Recommendations

Use a 10-nF to 1- μ F ceramic capacitor to bypass the VCC pin to GND. When the input bus power feed is inductive, then a transient voltage suppressor (TVS) may also be required.

11 Layout

11.1 Layout Guidelines

TPS24710/11/12/13 applications require careful attention to layout to ensure proper performance and to minimize susceptibility to transients and noise. In general, all traces should be as short as possible, but the following list deserves first consideration:

- Decoupling capacitors on VCC pin should have minimal trace lengths to the pin and to GND.
- Traces to VCC and SENSE must be short and run side-by-side to maximize common-mode rejection. Kelvin connections should be used at the points of contact with R_{SENSE} . (see [Figure 39](#)).
- Power path connections should be as short as possible and sized to carry at least twice the full load current, more if possible.
- Protection devices such as snubbers, TVS, capacitors, or diodes should be placed physically close to the device they are intended to protect, and routed with short traces to reduce inductance. For example, the protection Schottky diode shown in the typical application diagram on the front page of this data sheet should be physically close to the OUT pin.

11.2 Layout Example

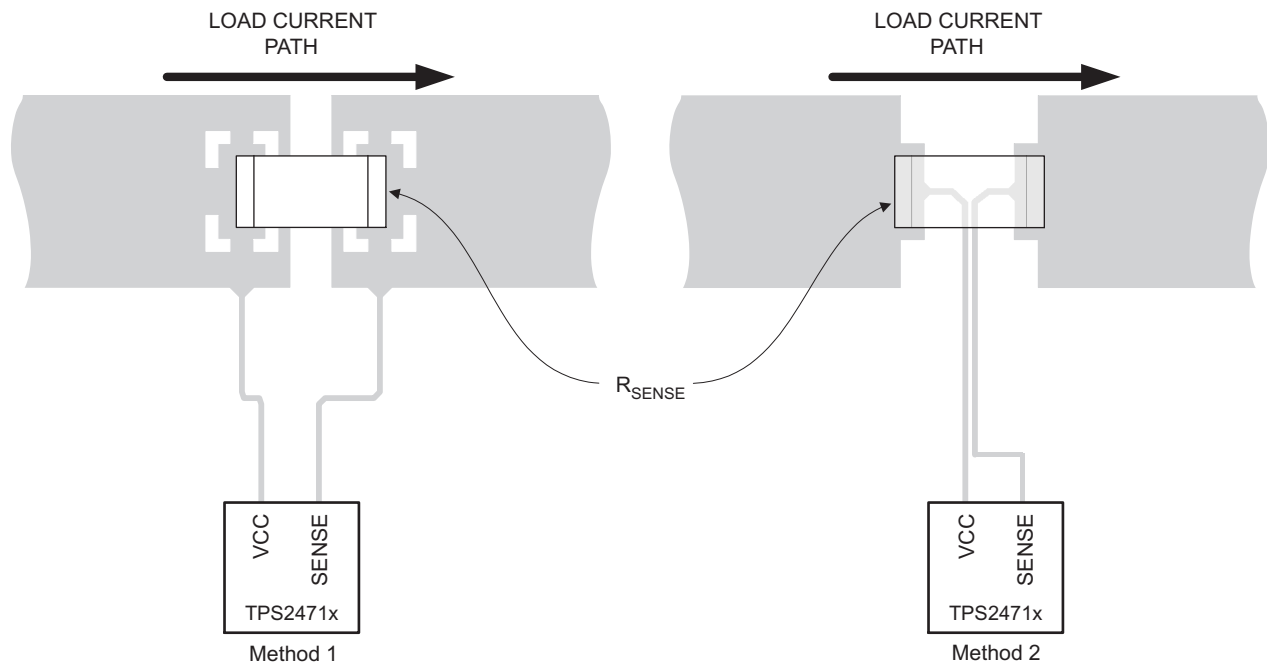

M0217-02

Figure 39. Recommended R_{SENSE} Layout

12 器件和文档支持

12.1 文档支持

《使用 TPS24700EVM、TPS24701EVM、TPS24710EVM 和 TPS24711EVM》，[SLUU459](#)。

《TPS24710 设计计算器》，[SLVC566](#)

《使用 TPS2471x 和 TPS24720 的软启动功能》，[SLVA749](#)

12.2 相关链接

下面的表格列出了快速访问链接。范围包括技术文档、支持和社区资源、工具和软件，以及样片或购买的快速访问。

表 2. 相关链接

器件	产品文件夹	样片与购买	技术文档	工具与软件	支持与社区
TPS24710	请单击此处	请单击此处	请单击此处	请单击此处	请单击此处
TPS24711	请单击此处	请单击此处	请单击此处	请单击此处	请单击此处
TPS24712	请单击此处	请单击此处	请单击此处	请单击此处	请单击此处
TPS24713	请单击此处	请单击此处	请单击此处	请单击此处	请单击此处

12.3 社区资源

The following links connect to TI community resources. Linked contents are provided "AS IS" by the respective contributors. They do not constitute TI specifications and do not necessarily reflect TI's views; see TI's [Terms of Use](#).

TI E2E™ Online Community *TI's Engineer-to-Engineer (E2E) Community*. Created to foster collaboration among engineers. At [e2e.ti.com](#), you can ask questions, share knowledge, explore ideas and help solve problems with fellow engineers.

Design Support *TI's Design Support* Quickly find helpful E2E forums along with design support tools and contact information for technical support.

12.4 商标

E2E is a trademark of Texas Instruments.
All other trademarks are the property of their respective owners.

12.5 静电放电警告



这些装置包含有限的内置 ESD 保护。存储或装卸时，应将导线一起截短或将装置放置于导电泡棉中，以防止 MOS 门极遭受静电损伤。

12.6 Glossary

[SLYZ022](#) — *TI Glossary*.

This glossary lists and explains terms, acronyms, and definitions.

13 机械、封装和可订购信息

以下页中包括机械、封装和可订购信息。这些信息是针对指定器件可提供的最新数据。这些数据会在无通知且不对本文档进行修订的情况下发生改变。欲获得该数据表的浏览器版本，请查阅左侧的导航栏。

重要声明

德州仪器(TI)及其下属子公司有权根据 JESD46 最新标准,对所提供的产品和服务进行更正、修改、增强、改进或其它更改,并有权根据 JESD48 最新标准中止提供任何产品和服务。客户在下订单前应获取最新的相关信息,并验证这些信息是否完整且是最新的。所有产品的销售都遵循在订单确认时所提供的TI 销售条款与条件。

TI 保证其所销售的组件的性能符合产品销售时 TI 半导体产品销售条件与条款的适用规范。仅在 TI 保证的范围内,且 TI 认为有必要时才会使用测试或其它质量控制技术。除非适用法律做出了硬性规定,否则没有必要对每种组件的所有参数进行测试。

TI 对应用帮助或客户产品设计不承担任何义务。客户应对其使用 TI 组件的产品和应用自行负责。为尽量减小与客户产品和应用相关的风险,客户应提供充分的设计与操作安全措施。

TI 不对任何 TI 专利权、版权、屏蔽作品权或其它与使用了 TI 组件或服务的组合设备、机器或流程相关的 TI 知识产权中授予的直接或隐含权限作出任何保证或解释。TI 所发布的与第三方产品或服务有关的信息,不能构成从 TI 获得使用这些产品或服务的许可、授权、或认可。使用此类信息可能需要获得第三方的专利权或其它知识产权方面的许可,或是 TI 的专利权或其它知识产权方面的许可。

对于 TI 的产品手册或数据表中 TI 信息的重要部分,仅在没有对内容进行任何篡改且带有相关授权、条件、限制和声明的情况下才允许进行复制。TI 对此类篡改过的文件不承担任何责任或义务。复制第三方的信息可能需要服从额外的限制条件。

在转售 TI 组件或服务时,如果对该组件或服务参数的陈述与 TI 标明的参数相比存在差异或虚假成分,则会失去相关 TI 组件或服务的所有明示或暗示授权,且这是不正当的、欺诈性商业行为。TI 对任何此类虚假陈述均不承担任何责任或义务。

客户认可并同意,尽管任何应用相关信息或支持仍可能由 TI 提供,但他们将独立负责满足与其产品及其在应用中使用的 TI 产品相关的所有法律、法规和安全相关要求。客户声明并同意,他们具备制定与实施安全措施所需的全部专业技术和知识,可预见故障的危险后果、监测故障及其后果、降低有可能造成人身伤害的故障的发生机率并采取适当的补救措施。客户将全额赔偿因在此类安全关键应用中使用任何 TI 组件而对 TI 及其代理造成的任何损失。

在某些场合中,为了推进安全相关应用有可能对 TI 组件进行特别的促销。TI 的目标是利用此类组件帮助客户设计和创立其特有的可满足适用的功能安全性标准和要求的终端产品解决方案。尽管如此,此类组件仍然服从这些条款。

TI 组件未获得用于 FDA Class III (或类似的生命攸关医疗设备)的授权许可,除非各方授权官员已经达成了专门管控此类使用的特别协议。

只有那些 TI 特别注明属于军用等级或“增强型塑料”的 TI 组件才是设计或专门用于军事/航空应用或环境的。购买者认可并同意,对并非指定面向军事或航空航天用途的 TI 组件进行军事或航空航天方面的应用,其风险由客户单独承担,并且由客户独立负责满足与此类使用相关的所有法律和法规要求。

TI 已明确指定符合 ISO/TS16949 要求的产品,这些产品主要用于汽车。在任何情况下,因使用非指定产品而无法达到 ISO/TS16949 要求, TI 不承担任何责任。

	产品		应用
数字音频	www.ti.com.cn/audio	通信与电信	www.ti.com.cn/telecom
放大器和线性器件	www.ti.com.cn/amplifiers	计算机及周边	www.ti.com.cn/computer
数据转换器	www.ti.com.cn/dataconverters	消费电子	www.ti.com.cn/consumer-apps
DLP® 产品	www.dlp.com	能源	www.ti.com.cn/energy
DSP - 数字信号处理器	www.ti.com.cn/dsp	工业应用	www.ti.com.cn/industrial
时钟和计时器	www.ti.com.cn/clockandtimers	医疗电子	www.ti.com.cn/medical
接口	www.ti.com.cn/interface	安防应用	www.ti.com.cn/security
逻辑	www.ti.com.cn/logic	汽车电子	www.ti.com.cn/automotive
电源管理	www.ti.com.cn/power	视频和影像	www.ti.com.cn/video
微控制器 (MCU)	www.ti.com.cn/microcontrollers		
RFID 系统	www.ti.com.cn/rfidsys		
OMAP应用处理器	www.ti.com/omap		
无线连通性	www.ti.com.cn/wirelessconnectivity	德州仪器在线技术支持社区	www.deyisupport.com

邮寄地址: 上海市浦东新区世纪大道1568号, 中建大厦32楼邮政编码: 200122
Copyright © 2016, 德州仪器半导体技术(上海)有限公司

PACKAGING INFORMATION

Orderable Device	Status (1)	Package Type	Package Drawing	Pins	Package Qty	Eco Plan (2)	Lead finish/ Ball material (6)	MSL Peak Temp (3)	Op Temp (°C)	Device Marking (4/5)	Samples
SN24710DGS	ACTIVE	VSSOP	DGS	10	80	RoHS & Green	NIPDAU	Level-1-260C-UNLIM	-40 to 85	24710	Samples
SN24710DGSR	ACTIVE	VSSOP	DGS	10	2500	RoHS & Green	NIPDAU	Level-1-260C-UNLIM	-40 to 85	24710	Samples
TPS24710DGS	ACTIVE	VSSOP	DGS	10	80	RoHS & Green	NIPDAU	Level-1-260C-UNLIM	-40 to 85	24710	Samples
TPS24710DGSR	ACTIVE	VSSOP	DGS	10	2500	RoHS & Green	NIPDAU	Level-1-260C-UNLIM	-40 to 85	24710	Samples
TPS24711DGS	ACTIVE	VSSOP	DGS	10	80	RoHS & Green	NIPDAU	Level-1-260C-UNLIM	-40 to 85	24711	Samples
TPS24711DGSR	ACTIVE	VSSOP	DGS	10	2500	RoHS & Green	NIPDAU	Level-1-260C-UNLIM	-40 to 85	24711	Samples
TPS24712DGS	ACTIVE	VSSOP	DGS	10	80	RoHS & Green	NIPDAU	Level-1-260C-UNLIM	-40 to 85	24712	Samples
TPS24712DGSR	ACTIVE	VSSOP	DGS	10	2500	RoHS & Green	NIPDAU	Level-1-260C-UNLIM	-40 to 85	24712	Samples
TPS24713DGS	ACTIVE	VSSOP	DGS	10	80	RoHS & Green	NIPDAU	Level-1-260C-UNLIM	-40 to 85	24713	Samples
TPS24713DGSR	ACTIVE	VSSOP	DGS	10	2500	RoHS & Green	NIPDAU	Level-1-260C-UNLIM	-40 to 85	24713	Samples

(1) The marketing status values are defined as follows:

ACTIVE: Product device recommended for new designs.

LIFEBUY: TI has announced that the device will be discontinued, and a lifetime-buy period is in effect.

NRND: Not recommended for new designs. Device is in production to support existing customers, but TI does not recommend using this part in a new design.

PREVIEW: Device has been announced but is not in production. Samples may or may not be available.

OBSOLETE: TI has discontinued the production of the device.

(2) **RoHS:** TI defines "RoHS" to mean semiconductor products that are compliant with the current EU RoHS requirements for all 10 RoHS substances, including the requirement that RoHS substance do not exceed 0.1% by weight in homogeneous materials. Where designed to be soldered at high temperatures, "RoHS" products are suitable for use in specified lead-free processes. TI may reference these types of products as "Pb-Free".

RoHS Exempt: TI defines "RoHS Exempt" to mean products that contain lead but are compliant with EU RoHS pursuant to a specific EU RoHS exemption.

Green: TI defines "Green" to mean the content of Chlorine (Cl) and Bromine (Br) based flame retardants meet JS709B low halogen requirements of <=1000ppm threshold. Antimony trioxide based flame retardants must also meet the <=1000ppm threshold requirement.

(3) MSL, Peak Temp. - The Moisture Sensitivity Level rating according to the JEDEC industry standard classifications, and peak solder temperature.

(4) There may be additional marking, which relates to the logo, the lot trace code information, or the environmental category on the device.

⁽⁵⁾ Multiple Device Markings will be inside parentheses. Only one Device Marking contained in parentheses and separated by a "~" will appear on a device. If a line is indented then it is a continuation of the previous line and the two combined represent the entire Device Marking for that device.

⁽⁶⁾ Lead finish/Ball material - Orderable Devices may have multiple material finish options. Finish options are separated by a vertical ruled line. Lead finish/Ball material values may wrap to two lines if the finish value exceeds the maximum column width.

Important Information and Disclaimer: The information provided on this page represents TI's knowledge and belief as of the date that it is provided. TI bases its knowledge and belief on information provided by third parties, and makes no representation or warranty as to the accuracy of such information. Efforts are underway to better integrate information from third parties. TI has taken and continues to take reasonable steps to provide representative and accurate information but may not have conducted destructive testing or chemical analysis on incoming materials and chemicals. TI and TI suppliers consider certain information to be proprietary, and thus CAS numbers and other limited information may not be available for release.

In no event shall TI's liability arising out of such information exceed the total purchase price of the TI part(s) at issue in this document sold by TI to Customer on an annual basis.

TAPE AND REEL INFORMATION

QUADRANT ASSIGNMENTS FOR PIN 1 ORIENTATION IN TAPE

*All dimensions are nominal

Device	Package Type	Package Drawing	Pins	SPQ	Reel Diameter (mm)	Reel Width W1 (mm)	A0 (mm)	B0 (mm)	K0 (mm)	P1 (mm)	W (mm)	Pin1 Quadrant
TPS24710DGSR	VSSOP	DGS	10	2500	330.0	12.4	5.3	3.4	1.4	8.0	12.0	Q1
TPS24711DGSR	VSSOP	DGS	10	2500	330.0	12.4	5.3	3.4	1.4	8.0	12.0	Q1
TPS24712DGSR	VSSOP	DGS	10	2500	330.0	12.4	5.3	3.4	1.4	8.0	12.0	Q1
TPS24713DGSR	VSSOP	DGS	10	2500	330.0	12.4	5.3	3.4	1.4	8.0	12.0	Q1

TAPE AND REEL BOX DIMENSIONS

*All dimensions are nominal

Device	Package Type	Package Drawing	Pins	SPQ	Length (mm)	Width (mm)	Height (mm)
TPS24710DGSR	VSSOP	DGS	10	2500	358.0	335.0	35.0
TPS24711DGSR	VSSOP	DGS	10	2500	358.0	335.0	35.0
TPS24712DGSR	VSSOP	DGS	10	2500	358.0	335.0	35.0
TPS24713DGSR	VSSOP	DGS	10	2500	358.0	335.0	35.0

DGS0010A



PACKAGE OUTLINE

VSSOP - 1.1 mm max height

SMALL OUTLINE PACKAGE



4221984/A 05/2015

NOTES:

1. All linear dimensions are in millimeters. Any dimensions in parenthesis are for reference only. Dimensioning and tolerancing per ASME Y14.5M.
2. This drawing is subject to change without notice.
3. This dimension does not include mold flash, protrusions, or gate burrs. Mold flash, protrusions, or gate burrs shall not exceed 0.15 mm per side.
4. This dimension does not include interlead flash. Interlead flash shall not exceed 0.25 mm per side.
5. Reference JEDEC registration MO-187, variation BA.

EXAMPLE BOARD LAYOUT

DGS0010A

VSSOP - 1.1 mm max height

SMALL OUTLINE PACKAGE



LAND PATTERN EXAMPLE
SCALE:10X



SOLDER MASK DETAILS
NOT TO SCALE

4221984/A 05/2015

NOTES: (continued)

- 6. Publication IPC-7351 may have alternate designs.
- 7. Solder mask tolerances between and around signal pads can vary based on board fabrication site.

EXAMPLE STENCIL DESIGN

DGS0010A

VSSOP - 1.1 mm max height

SMALL OUTLINE PACKAGE



SOLDER PASTE EXAMPLE
BASED ON 0.125 mm THICK STENCIL
SCALE:10X

4221984/A 05/2015

NOTES: (continued)

8. Laser cutting apertures with trapezoidal walls and rounded corners may offer better paste release. IPC-7525 may have alternate design recommendations.
9. Board assembly site may have different recommendations for stencil design.

重要声明和免责声明

TI 均以“原样”提供技术性及其可靠性数据（包括数据表）、设计资源（包括参考设计）、应用或其他设计建议、网络工具、安全信息和其他资源，不保证其中不含任何瑕疵，且不做任何明示或暗示的担保，包括但不限于对适销性、适合某特定用途或不侵犯任何第三方知识产权的暗示担保。

所述资源可供专业开发人员应用TI 产品进行设计使用。您将对以下行为独自承担全部责任：(1) 针对您的应用选择合适的TI 产品；(2) 设计、验证并测试您的应用；(3) 确保您的应用满足相应标准以及任何其他安全、安保或其他要求。所述资源如有变更，恕不另行通知。TI 对您使用所述资源的授权仅限于开发资源所涉及TI 产品的相关应用。除此之外不得复制或展示所述资源，也不提供其它TI 或任何第三方的知识产权授权许可。如因使用所述资源而产生任何索赔、赔偿、成本、损失及债务等，TI 对此概不负责，并且您须赔偿由此对TI 及其代表造成的损害。

TI 所提供产品均受TI 的销售条款 (<http://www.ti.com.cn/zh-cn/legal/termsofsale.html>) 以及ti.com.cn上或随附TI产品提供的其他可适用条款的约束。TI提供所述资源并不扩展或以其他方式更改TI 针对TI 产品所发布的可适用的担保范围或担保免责声明。

邮寄地址：上海市浦东新区世纪大道 1568 号中建大厦 32 楼，邮政编码：200122

Copyright © 2020 德州仪器半导体技术（上海）有限公司