

## TRF3722 具有集成 PLL 和 VCO 的正交调制器

### 1 特性

- 具有集成 PLL 和 VCO 的 IQ 调制器
- 整数 N/分数 N PLL
- 调制器支持 400MHz 至 4200MHz 频率范围
- PLL 和 VCO 支持 280MHz 至 4100MHz 的频率范围
- 900MHz 时的 OIP3 为 31 dBm
- 1800MHz 时的 OIP3 为 30 dBm
- VCO 1800MHz 开环相位噪声: 1MHz 偏移时为 -141 dBc/Hz
- 独立式 LO 输出支持 1/2/4/8 分频
- 调制器低功耗和高增益模式
- 多种断电模式

### 2 应用

- 无线基础设施
  - CDMA: IS95, UMTS, CDMA2000, TD-SCDMA
  - LTE, TD-LTE, LTE Advanced
  - TDMA: GSM, EDGE, MC-GSM
- 点对点微波, 点对多点微波
- 软件定义的无线电
- 射频中继器, 分布式天线系统

### 3 说明

TRF3722 是一款高性能直接转换正交调制器, 具有优异的线性和低噪声性能。基带共模电压典型值为 0.25V, 支持与电流源 DAC 的无缝连接。此器件集成了 PLL 和 VCO, 能够为调制器提供本地振荡器 (LO)。PLL 和 VCO 可实现卓越的相位噪声性能, 能够满足最为严格的传输通信要求。此器件还提供了额外的 LO 输出, 用于驱动其它调制器或降频混频器。该调制器具有一个可实现典型 3dB 增益提升的高增益模式和一个适用于需要对功耗进行优化的应用的低功耗模式。

器件信息<sup>(1)</sup>

器件型号	封装	封装尺寸 (标称值)
TRF3722	VQFN (48)	7.00mm x 7.00mm

(1) 如需了解所有可用封装, 请见数据表末尾的可订购产品附录。

方框图

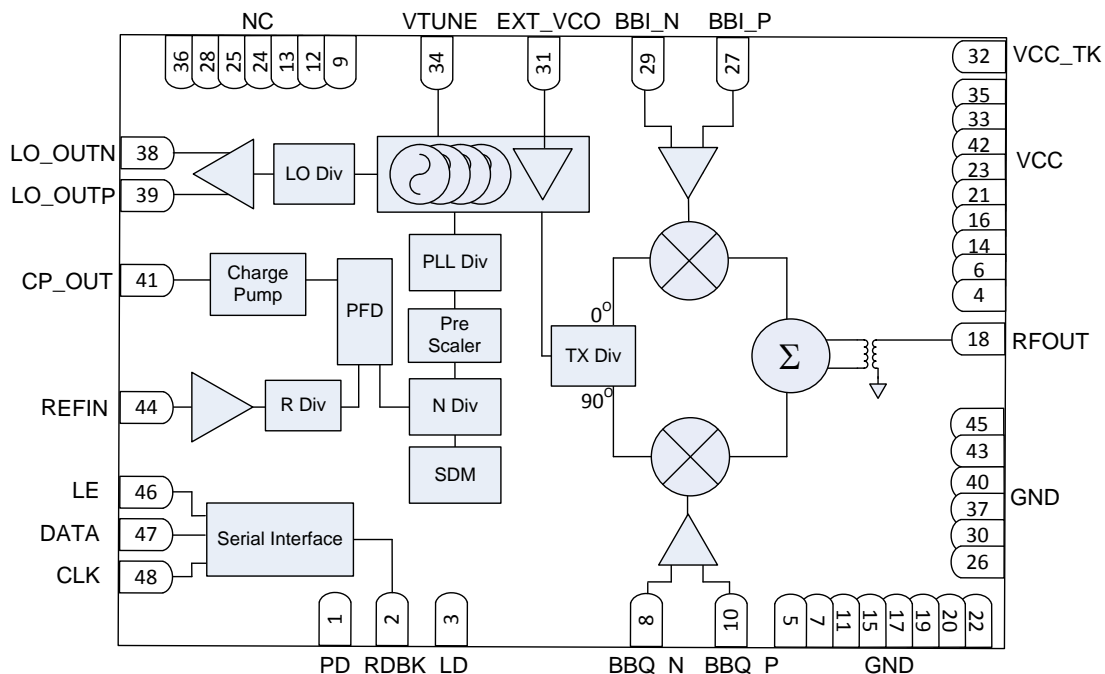

## 目录

<b>1</b>	特性 .....	<b>1</b>	6.19	Typical Characteristics - Current Consumption ....	<b>29</b>
<b>2</b>	应用 .....	<b>1</b>	6.20	Typical Characteristics - Power Dissipation .....	<b>31</b>
<b>3</b>	说明 .....	<b>1</b>	<b>7</b>	<b>Parameter Measurement Information .....</b>	<b>33</b>
<b>4</b>	修订历史记录 .....	<b>2</b>	7.1	Serial Interface Timing Diagram .....	<b>33</b>
<b>5</b>	<b>Pin Configuration and Functions .....</b>	<b>3</b>	<b>8</b>	<b>Detailed Description .....</b>	<b>35</b>
<b>6</b>	<b>Specifications .....</b>	<b>4</b>	8.1	Overview .....	<b>35</b>
6.1	Absolute Maximum Ratings .....	<b>4</b>	8.2	Functional Block Diagram .....	<b>35</b>
6.2	ESD Ratings .....	<b>4</b>	8.3	Feature Description .....	<b>36</b>
6.3	Recommended Operating Conditions .....	<b>4</b>	8.4	Device Functional Modes .....	<b>39</b>
6.4	Thermal Information .....	<b>5</b>	8.5	Register Maps .....	<b>42</b>
6.5	Electrical Characteristics .....	<b>5</b>	<b>9</b>	<b>Application and Implementation .....</b>	<b>55</b>
6.6	Typical Characteristics .....	<b>9</b>	9.1	Application Information .....	<b>55</b>
6.7	Typical Characteristics - Output Power .....	<b>10</b>	9.2	Typical Application .....	<b>55</b>
6.8	Typical Characteristics - Gain .....	<b>11</b>	<b>10</b>	<b>Power Supply Recommendations .....</b>	<b>58</b>
6.9	Typical Characteristics - OIP3 .....	<b>12</b>	<b>11</b>	<b>Layout .....</b>	<b>59</b>
6.10	Typical Characteristics - OIP2 .....	<b>13</b>	11.1	Layout Guidelines .....	<b>59</b>
6.11	Typical Characteristics - OP1dB .....	<b>14</b>	11.2	Layout Example .....	<b>59</b>
6.12	Typical Characteristics - Noise .....	<b>15</b>	<b>12</b>	<b>器件和文档支持 .....</b>	<b>60</b>
6.13	Typical Characteristics - Unadjusted CF .....	<b>16</b>	12.1	接收文档更新通知 .....	<b>60</b>
6.14	Typical Characteristics - Unadjusted SBS .....	<b>17</b>	12.2	社区资源 .....	<b>60</b>
6.15	Typical Characteristics - LO Harmonic .....	<b>18</b>	12.3	商标 .....	<b>60</b>
6.16	Typical Characteristics - BB Harmonic .....	<b>20</b>	12.4	静电放电警告 .....	<b>60</b>
6.17	Typical Characteristics - RF Output Return Loss .....	<b>22</b>	12.5	Glossary .....	<b>60</b>
6.18	Typical Characteristics - PLL/VCO .....	<b>23</b>	<b>13</b>	<b>机械、封装和可订购信息 .....</b>	<b>60</b>

## 4 修订历史记录

<b>Changes from Revision A (June 2014) to Revision B</b>	<b>Page</b>
• 已更改 256MHz 更改为 280MHz (PLL 和 VCO 特性 要点部分) .....	<b>1</b>
• Changed <i>ESD Ratings</i> table title, updated to current standards .....	<b>4</b>
• Added <i>Typical</i> and footnote 2 to <i>Typical VCO frequency range</i> and <i>Typical output frequency range</i> parameters .....	<b>8</b>
• Changed <b>Figure 1</b> .....	<b>9</b>
• Changed location of <i>TRF3722 Application Schematic</i> figure and all associated text to be under <i>Typical Application</i> section .....	<b>55</b>

<b>Changes from Original (May 2014) to Revision A</b>	<b>Page</b>
• 从单页产品预览更改为生产 .....	<b>1</b>

## 5 Pin Configuration and Functions

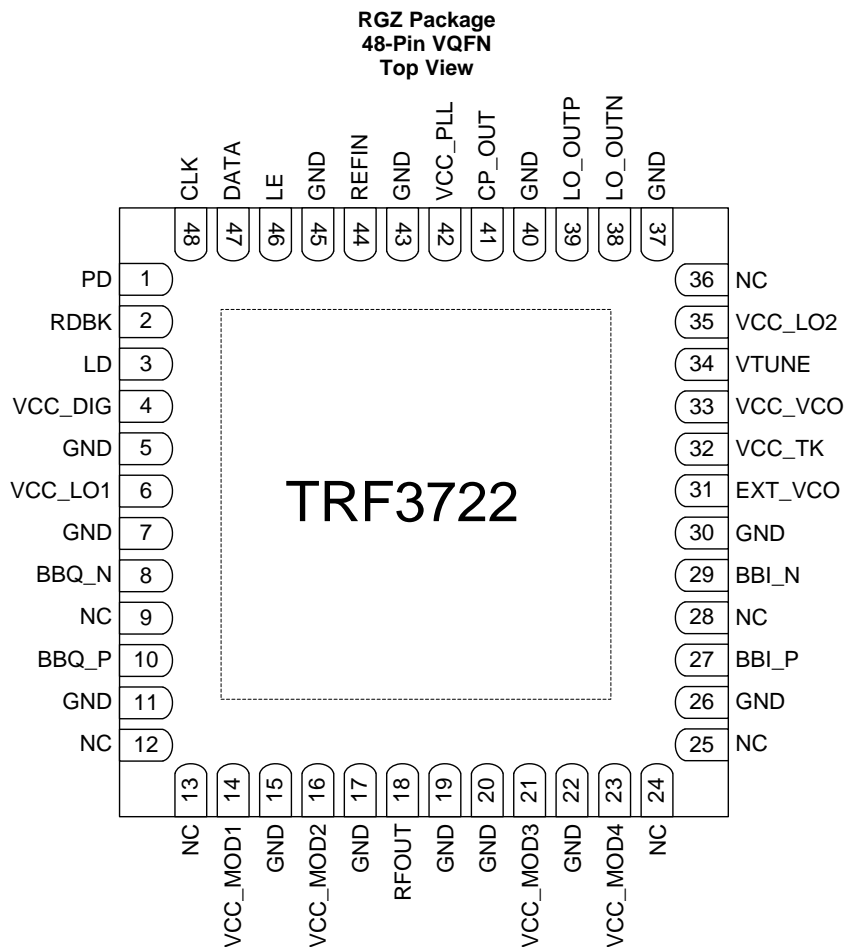

### Pin Functions

PIN		I/O	DESCRIPTION
NAME	NO.		
BBI_N	29	I	BB in-phase input: negative
BBI_P	27	I	BB in-phase input: positive
BBQ_N	8	I	BB quadrature input: negative
BBQ_P	10	I	BB quadrature input: positive
CLK	48	I	Serial interface clock input; digital input
CP_OUT	41	O	Charge pump output
DATA	47	I	Serial interface data input; digital input
EXT_VCO	31	I	External local oscillator input
GND	5, 7, 11, 15, 17, 19, 20, 22, 26, 30, 37, 40, 43, 45		Ground
LD	3	O	PLL lock detect output
LE	46	I	Serial interface latch enable; digital input
LO_OUTN	38	O	Local oscillator output: negative
LO_OUTP	39	O	Local oscillator output: positive
NC	9, 12, 13, 24, 25, 36		No connect
NC	28		No connect; N/C or ground to paddle

**Pin Functions (continued)**

PIN		I/O	DESCRIPTION
NAME	NO.		
PD	1	I	LO Div, TX Div, modulator power down (High = PD)
RDBK	2	O	Serial interface internal registers readback output
REFIN	44	I	Reference clock input
RFOUT	18	O	RF output
VCC_DIG	4		3.3 V digital power supply
VCC_LO1	6		3.3 V TX Div power supply
VCC_LO2	35		3.3 V LO Div power supply
VCC_MOD1	14		3.3 V modulator power supply
VCC_MOD2	16		3.3 V modulator power supply
VCC_MOD3	21		3.3 V modulator power supply
VCC_MOD4	23		3.3 V modulator power supply
VCC_PLL	42		3.3 V PLL power supply
VCC_TK	32		3.3 V or 5 V VCO tank power supply
VCC_VCO	33		3.3 V VCO power supply
VTUNE	34	I	VCO control voltage input

## 6 Specifications

### 6.1 Absolute Maximum Ratings

 over operating free-air temperature range (unless otherwise noted)<sup>(1)</sup>

		MIN	MAX	UNIT
Supply voltage	All VCC except VCC_TK	-0.3	+3.6	V
	VCC_TK	-0.3	+5.5	
Digital I/O voltage		-0.3	3.6	V
Operating junction temperature		-40	150	°C
Storage temperature, T <sub>stg</sub>		-40	150	°C

- (1) Stresses beyond those listed under *Absolute Maximum Ratings* may cause permanent damage to the device. These are stress ratings only, which do not imply functional operation of the device at these or any other conditions beyond those indicated under *Recommended Operating Conditions*. Exposure to absolute-maximum-rated conditions for extended periods may affect device reliability.

### 6.2 ESD Ratings

		VALUE	UNIT
V <sub>(ESD)</sub> Electrostatic discharge	Human-body model (HBM), per ANSI/ESDA/JEDEC JS-001 <sup>(1)</sup>	±2000	V
	Charged-device model (CDM), per JEDEC specification JESD22-C101 <sup>(2)</sup>	±750	

- (1) JEDEC document JEP155 states that 500-V HBM allows safe manufacturing with a standard ESD control process.

- (2) JEDEC document JEP157 states that 250-V CDM allows safe manufacturing with a standard ESD control process.

### 6.3 Recommended Operating Conditions

over operating free-air temperature range (unless otherwise noted)

		MIN	NOM	MAX	UNIT
V <sub>CC</sub>	3.3 V power-supply voltage	3	3.3	3.6	V
	5 V or 3.3 V power-supply voltage, VCC_TK	3	3.3/5	5.5	V
T <sub>J</sub>	Operating junction temperature range	-40		125	°C
T <sub>A</sub>	Ambient temperature range	-40		85	°C

## 6.4 Thermal Information

THERMAL METRIC <sup>(1)</sup>		TRF3722	UNIT
		RGZ (VQFN)	
		48 PINS	
R <sub>θJA</sub>	Junction-to-ambient thermal resistance	27.5	°C/W
R <sub>θJC(top)</sub>	Junction-to-case (top) thermal resistance	12.8	°C/W
R <sub>θJB</sub>	Junction-to-board thermal resistance	4.3	°C/W
ψ <sub>JT</sub>	Junction-to-top characterization parameter	0.2	°C/W
ψ <sub>JB</sub>	Junction-to-board characterization parameter	4.3	°C/W
R <sub>θJC(bot)</sub>	Junction-to-case (bottom) thermal resistance	0.8	°C/W

(1) For more information about traditional and new thermal metrics, see the [Semiconductor and IC Package Thermal Metrics](#) application report.

## 6.5 Electrical Characteristics

Over recommended operating conditions: VCC = 3.3 V, VCC\_TK = 5 V, T<sub>A</sub> = 25°C. Optimized bias settings as per [Table 16](#).

PARAMETER		TEST CONDITIONS	MIN	TYP	MAX	UNIT
<b>DC PARAMETERS</b>						
I <sub>CC</sub>	3.3 V Supply Current	Typical Operating Mode; LO out = Off		328 <sup>(1)</sup>		mA
		Typical Operating Mode; LO out = On		374		mA
I <sub>CC_TK</sub>	5 V Supply Current			21		mA
P <sub>DISS</sub>	Total Power Dissipation	Typical Operating Mode; LO out = Off		1.18		W
		Typical Operating Mode; LO out = On		1.34		W
		Low Power Mode (Mod); LO out = Off		0.91		W
I <sub>PD</sub>	Power Down Current	Hardware Power Down		76		mA
		Serial interface Power Down		2		mA
<b>RFOUT FREQUENCY</b>						
	Frequency		400		4200	MHz
<b>IQ MODULATOR f<sub>LO</sub> = 750 MHz</b>						
G	Gain	Typical Operating Mode		0.8		dB
		High Gain Mode		3.6		dB
	Gain Flatness	In 300MHz bandwidth	-0.5		0.5	dB
OP1dB	Output Compression Point			10.2		dBm
OIP3	Output 3rd Order Intercept Point	F <sub>BB</sub> = 4.5, 5.5 MHz		31		dBm
OIP2	Output 2nd Order Intercept Point	F <sub>BB</sub> = 4.5, 5.5 MHz		62		dBm
SBS	Unadj. SideBand Suppression			-42		dBc
CF	Unadj. Carrier Feedthrough			-50		dBm
NSD <sub>O</sub>	Output Noise Spectral Density	BB inputs terminated on 50 Ω		-159		dBm/Hz
HD2 <sub>LO</sub>	LO Second Harmonic	Measured at 2 × f <sub>LO</sub>		-49		dBc
HD3 <sub>LO</sub>	LO Third Harmonic	Measured at 3 × f <sub>LO</sub>		-47		dBc
HD2 <sub>BB</sub>	Baseband Second Harmonic	Measured at f <sub>LO</sub> ± 2 × f <sub>BB</sub>		-72		dBc
HD3 <sub>BB</sub>	Baseband Third Harmonic	Measured at f <sub>LO</sub> ± 3 × f <sub>BB</sub>		-70		dBc

(1) Powered down output buffer and LO divider.

**Electrical Characteristics (continued)**

 Over recommended operating conditions:  $V_{CC} = 3.3\text{ V}$ ,  $V_{CC\_TK} = 5\text{ V}$ ,  $T_A = 25^\circ\text{C}$ . Optimized bias settings as per [Table 16](#).

PARAMETER		TEST CONDITIONS	MIN	TYP	MAX	UNIT
<b>IQ MODULATOR <math>f_{LO} = 900\text{ MHz}</math></b>						
G	Gain	Typical Operating Mode		0.8		dB
		High Gain Mode		3.6		dB
	Gain Flatness	In 300MHz bandwidth	-0.5		0.5	dB
OP1dB	Output Compression Point			10		dBm
OIP3	Output 3rd Order Intercept Point	$F_{BB} = 4.5, 5.5\text{ MHz}$		31		dBm
OIP2	Output 2nd Order Intercept Point	$F_{BB} = 4.5, 5.5\text{ MHz}$		62.5		dBm
SBS	Unadj. Side Band Suppression			-42.5		dBc
CF	Unadj. Carrier Feed through			-50		dBm
NSD <sub>O</sub>	Output Noise Spectral Density	BB inputs terminated on 50 $\Omega$		-159		dBm/Hz
HD2 <sub>LO</sub>	LO Second Harmonic	Measured at $2 \times f_{LO}$		-47		dBc
HD3 <sub>LO</sub>	LO Third Harmonic	Measured at $3 \times f_{LO}$		-54.5		dBc
HD2 <sub>BB</sub>	Baseband Second Harmonic	Measured at $f_{LO} \pm 2 \times f_{BB}$		-65.5		dBc
HD3 <sub>BB</sub>	Baseband Third Harmonic	Measured at $f_{LO} \pm 3 \times f_{BB}$		-71.5		dBc
<b>IQ MODULATOR <math>f_{LO} = 1800\text{ MHz}</math></b>						
G	Gain	Typical Operating Mode		0.3		dB
		High Gain Mode		3		dB
	Gain Flatness	In 300 MHz bandwidth	-0.5		0.5	dB
OP1dB	Output Compression Point			13		dBm
OIP3	Output 3rd Order Intercept Point	$f_{BB} = 4.5, 5.5\text{ MHz}$		29.5		dBm
OIP2	Output 2nd Order Intercept Point	$f_{BB} = 4.5, 5.5\text{ MHz}$		57		dBm
SBS	Unadj. Side Band Suppression			-54.5		dBc
CF	Unadj. Carrier Feed through			-57		dBm
NSD <sub>O</sub>	Output Noise Spectral Density	BB inputs terminated on 50 $\Omega$		-158		dBm/Hz
HD2 <sub>LO</sub>	LO Second Harmonic	Measured at $2 \times f_{LO}$		-36.5		dBc
HD3 <sub>LO</sub>	LO Third Harmonic	Measured at $3 \times f_{LO}$		-33.5		dBc
HD2 <sub>BB</sub>	Baseband Second Harmonic	Measured at $f_{LO} \pm 2 \times f_{BB}$		-65.5		dBc
HD3 <sub>BB</sub>	Baseband Third Harmonic	Measured at $f_{LO} \pm 3 \times f_{BB}$		-73		dBc
RL <sub>O</sub>	RF Output Return Loss			6		dB
<b>IQ MODULATOR <math>f_{LO} = 2150\text{ MHz}</math></b>						
G	Gain	Typical Operating Mode		0.2		dB
		High Gain Mode		3		dB
	Gain Flatness	In 300 MHz bandwidth	-0.5		0.5	dB
OP1dB	Output Compression Point			11.6		dBm
OIP3	Output 3rd Order Intercept Point	$F_{BB} = 4.5, 5.5\text{ MHz}$		30		dBm
OIP2	Output 2nd Order Intercept Point	$F_{BB} = 4.5, 5.5\text{ MHz}$		43		dBm
SBS	Unadj. Side Band Suppression			-43		dBc
CF	Unadj. Carrier Feedt hrough			-42		dBm
NSD <sub>O</sub>	Output Noise Spectral Density	BB inputs terminated on 50 $\Omega$		-157		dBm/Hz
HD2 <sub>LO</sub>	LO Second Harmonic	Measured at $2 \times f_{LO}$		-40		dBc
HD3 <sub>LO</sub>	LO Third Harmonic	Measured at $3 \times f_{LO}$		-31		dBc
HD2 <sub>BB</sub>	Baseband Second Harmonic	Measured at $f_{LO} \pm 2 \times f_{BB}$		-51		dBc
HD3 <sub>BB</sub>	Baseband Third Harmonic	Measured at $f_{LO} \pm 3 \times f_{BB}$		-69		dBc

## Electrical Characteristics (continued)

Over recommended operating conditions:  $V_{CC} = 3.3\text{ V}$ ,  $V_{CC\_TK} = 5\text{ V}$ ,  $T_A = 25^\circ\text{C}$ . Optimized bias settings as per [Table 16](#).

PARAMETER		TEST CONDITIONS	MIN	TYP	MAX	UNIT
<b>IQ MODULATOR <math>f_{LO} = 2700\text{ MHz}</math></b>						
G	Gain	Typical Operating Mode		0		dB
		High Gain Mode		2.4		dB
	Gain Flatness	In 300MHz bandwidth	-0.5		0.5	dB
OP1dB	Output Compression Point			10.4		dBm
OIP3	Output 3rd Order Intercept Point	$F_{BB} = 4.5, 5.5\text{ MHz}$		29.5		dBm
OIP2	Output 2nd Order Intercept Point	$F_{BB} = 4.5, 5.5\text{ MHz}$		45.5		dBm
SBS	Unadj. Side Band Suppression			-33		dBc
CF	Unadj. Carrier Feed through			-39.6		dBm
NSD <sub>O</sub>	Output Noise Spectral Density	BB inputs terminated on 50 $\Omega$		-156		dBm/Hz
HD2 <sub>LO</sub>	LO Second Harmonic	Measured at $2 \times f_{LO}$		-29		dBc
HD3 <sub>LO</sub>	LO Third Harmonic	Measured at $3 \times f_{LO}$		-37		dBc
HD2 <sub>BB</sub>	Baseband Second Harmonic	Measured at $f_{LO} \pm 2 \times f_{BB}$		-53		dBc
HD3 <sub>BB</sub>	Baseband Third Harmonic	Measured at $f_{LO} \pm 3 \times f_{BB}$		-68		dBc
<b>IQ MODULATOR <math>f_{LO} = 3600\text{ MHz}</math></b>						
G	Gain	Typical Operating Mode		-2		dB
		High Gain Mode		0.4		dB
OP1dB	Output Compression Point			8.7		dBm
OIP3	Output 3rd Order Intercept Point	$F_{BB} = 4.5, 5.5\text{ MHz}$		24.5		dBm
OIP2	Output 2nd Order Intercept Point	$F_{BB} = 4.5, 5.5\text{ MHz}$		45.5		dBm
SBS	Unadj. Side Band Suppression			-31.5		dBc
CF	Unadj. Carrier Feed through			-39.5		dBm
HD2 <sub>LO</sub>	LO Second Harmonic	Measured at $2 \times f_{LO}$		-28.4		dBc
HD3 <sub>LO</sub>	LO Third Harmonic	Measured at $3 \times f_{LO}$		-31.5		dBc
HD2 <sub>BB</sub>	Baseband Second Harmonic	Measured at $f_{LO} \pm 2 \times f_{BB}$		-55		dBc
HD3 <sub>BB</sub>	Baseband Third Harmonic	Measured at $f_{LO} \pm 3 \times f_{BB}$		-65		dBc
<b>BASEBAND INPUTS</b>						
$V_{CM}$	Common Mode Voltage	Baseband I/Q input	0	0.25	0.5	V
$BW_{BB}$	Baseband Bandwidth	1 dB Bandwidth		900		MHz
$Z_{inBB}$	Baseband Input Impedance	Resistance		5		k $\Omega$
		Capacitance		4		pF
<b>REFERENCE OSCILLATOR PARAMETERS</b>						
$F_{ref}$	Reference Frequency	Max		350		MHz
	Reference Input Sensitivity		0.2		3.3	V <sub>PP</sub>
$Z_{inref}$	Reference Input Impedance	Parallel capacitance		2		pF
		Parallel resistance		2.2		k $\Omega$
<b>PFD, CP</b>						
$F_{PFD}$	PFD Frequency	Max, refer to the <a href="#">Typical Application</a>			65	MHz
$I_{CP\_OUT}$	Charge Pump Current	Max		1.94		mA
	In-band Normalized PN Floor	Integer Mode		-221		dBc/Hz

**Electrical Characteristics (continued)**

 Over recommended operating conditions:  $V_{CC} = 3.3\text{ V}$ ,  $V_{CC\_TK} = 5\text{ V}$ ,  $T_A = 25^\circ\text{C}$ . Optimized bias settings as per [Table 16](#).

PARAMETER		TEST CONDITIONS	MIN	TYP	MAX	UNIT
<b>VCO</b>						
$f_{VCO}$	Typical VCO frequency range <sup>(2)</sup>		2050		4100	MHz
$K_V$	VCO gain	VTUNE = 1.1 V		30		MHz/V
PN	VCO Open Loop Phase Noise; $f_{VCO} = 3600\text{ MHz}$ ; TX Div = Div-by-1; $f_{OUT} = 3600\text{ MHz}$ VTUNE = 1.1 V	10 kHz		-74		dBc/Hz
		100 kHz		-109		
		1 MHz		-135		
		10 MHz		-152		
		40 MHz		-156		
	VCO Open Loop Phase Noise; $f_{VCO} = 3600\text{ MHz}$ ; TX Div = Div-by-2; $f_{OUT} = 1800\text{ MHz}$ ; VTUNE = 1.1 V	10 kHz		-80		dBc/Hz
		100 kHz		-115		
		1 MHz		-141		
		10 MHz		-156		
		40 MHz		-158		
<b>LO OUTPUT</b>						
$f_{OUT}$	Typical output frequency range <sup>(2)</sup>	Divide by 1	2050		4100	MHz
		Divide by 2	1025		2050	
		Divide by 4	512.5		1025	
		Divide by 8	256.25		512.5	
$P_{LO}$	Output power	SE at 1800 MHz, OUTBUF_BIAS = 2		1		dBm
	External VCO input Frequency Range		250		4200	MHz
	External VCO Input Level		-10	0	10	dBm
<b>CLOSE LOOP PLL OR VCO</b>						
Integrated Phase Noise		Frac-N; PFD = 15.36 MHz; $f_{OUT} = 3532.89\text{ MHz}$ ; Integration BW = 1 kHz to 10 MHz; SSB		-45.2		dB
		Int-N; PFD = 2.56 MHz; $f_{OUT} = 1799.68\text{ MHz}$ ; Integration BW = 500 Hz to 20 MHz; SSB		-49.8		dB
VCO Close Loop Phase Noise; $f_{VCO} = 3600\text{ MHz}$ ; TX DIV = Div-by-2; $f_{OUT} = 1800\text{ MHz}$ ; Integer Mode, PFD = 2.56MHz		10 kHz		-96		dBc/Hz
		100 kHz		-114		
		1 MHz		-140		
		10 MHz		-156		
		40 MHz		-158		
<b>DIGITAL INTERFACE</b>						
$V_{IH}$	High Level Input Voltage		2	3.3		V
$V_{IL}$	Low Level Input Voltage		0		0.8	V
$V_{OH}$	High Level Output Voltage	Referenced to VCC_DIG	0.8 x VCC			V
$V_{OL}$	Low Level Output Voltage	Referenced to VCC_DIG			0.2 x VCC	V

(2) Divided-down ranges minimum and maximum values are typical but are not specified.



## 6.6 Typical Characteristics

### 6.6.1 Modulator Output Spectrum

Graphical illustration of the modulator output spectrum with two tones is shown in Figure 1.

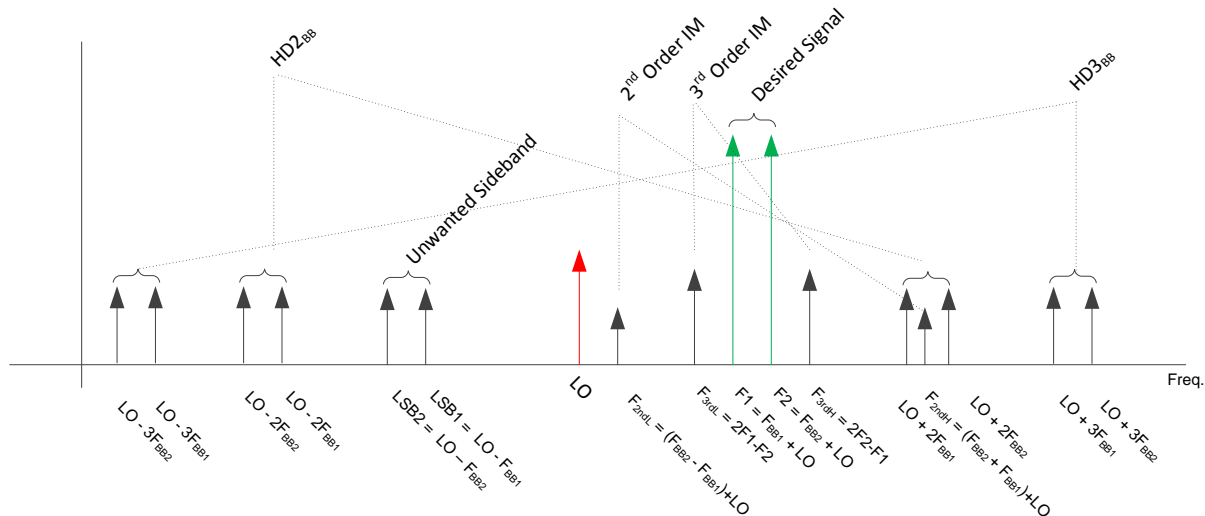

- $F_{BBn}$  = Baseband Frequency
- $F_n$  = RF Frequency
- $F_{3rdH/L}$  = 3<sup>rd</sup> Order Intermodulation Product Frequency (High Side / Low Side)
- $F_{2ndH/L}$  = 2<sup>nd</sup> Order Intermodulation Product Frequency (High Side / Low Side)
- LO = Local Oscillator Frequency
- LSBn = Lower Sideband Frequency
- HD2<sub>BB</sub> = Baseband second harmonic (High Side / Low Side)
- HD3<sub>BB</sub> = Baseband third harmonic (High Side / Low Side)

**Figure 1. Graphical Illustration of Modulator Output Spectrum**

### 6.7 Typical Characteristics - Output Power

Unless specified all plots were created using TRF3722EVM,  $V_{CC} = 3.3\text{ V}$ ,  $V_{CC\_TK} = 5\text{ V}$ ,  $T_A = 25^\circ\text{C}$ , I/Q frequency ( $f_{BB}$ ) 4.5 MHz and 5.5 MHz, 500 mV<sub>PP</sub>,  $V_{CM} = 0.25\text{ V}$ , and 4.7 pF series capacitor at RFOUT. Optimized bias settings as per Table 16. Total  $P_{out}$  is two tones combined power.

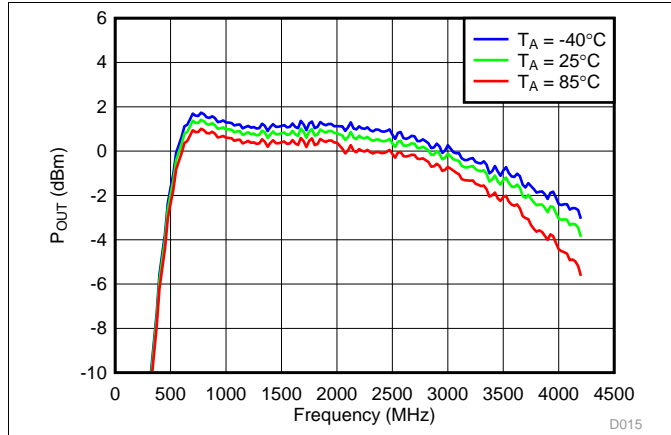

Figure 2. Total  $P_{OUT}$  vs Temperature, Typical Operating Mode

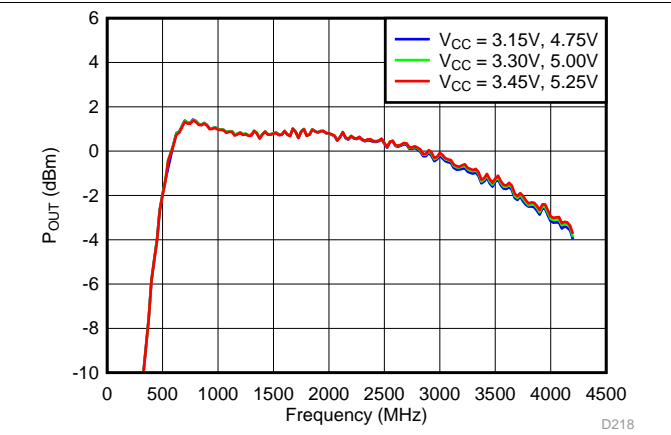

Figure 3. Total  $P_{OUT}$  vs Supply, Typical Operating Mode

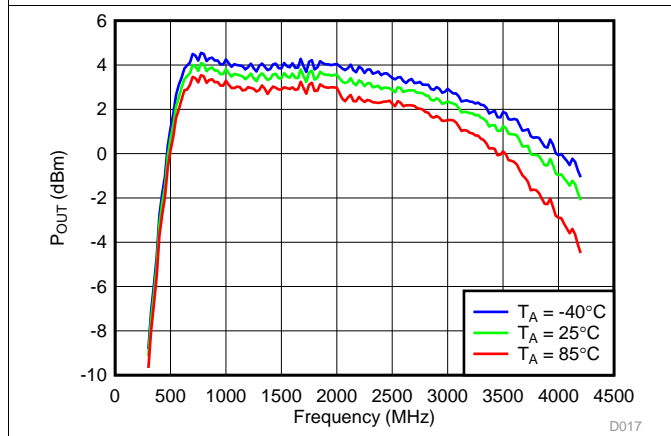

Figure 4. Total  $P_{OUT}$  vs Temperature, High Gain Mode

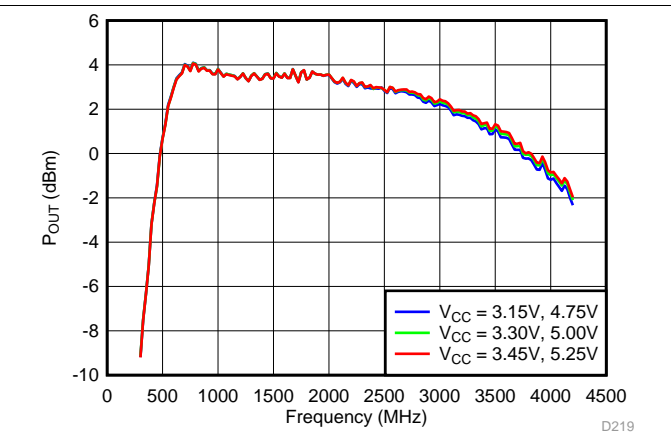

Figure 5. Total  $P_{OUT}$  vs Supply, High Gain Mode

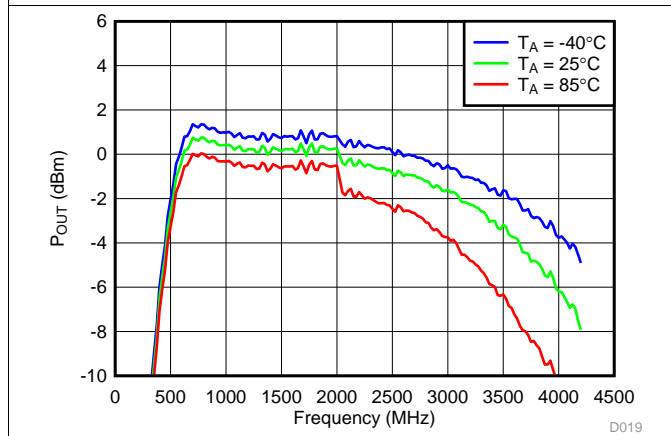

Figure 6. Total  $P_{OUT}$  vs Temperature, Low Power Mode

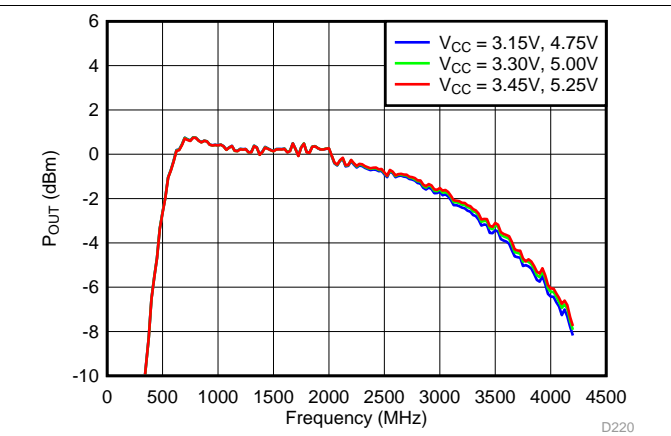

Figure 7. Total  $P_{OUT}$  vs Supply, Low Power Mode

### 6.8 Typical Characteristics - Gain

Unless specified all plots were created using TRF3722EVM,  $V_{CC} = 3.3\text{ V}$ ,  $V_{CC\_TK} = 5\text{ V}$ ,  $T_A = 25^\circ\text{C}$ , I/Q frequency ( $f_{BB}$ ) 4.5 MHz and 5.5 MHz,  $V_{CM} = 0.25\text{ V}$ , and 4.7 pF series capacitor at RFOUT. Optimized bias settings as per Table 16.

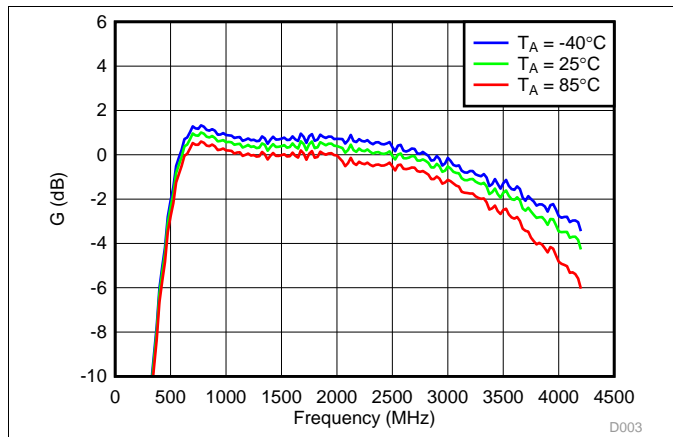

Figure 8. Voltage Gain vs Temperature, Typical Operating Mode

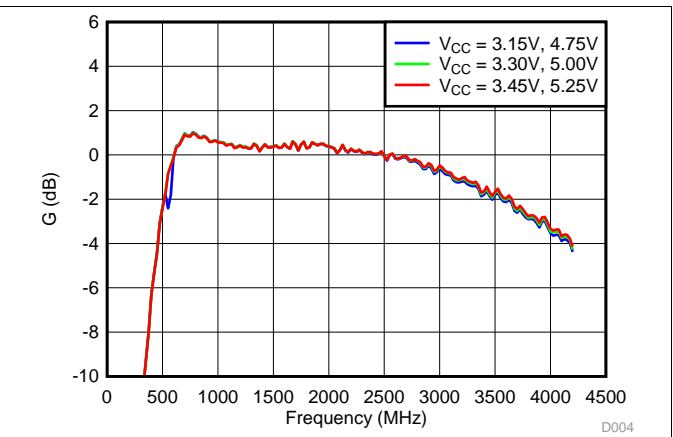

Figure 9. Voltage Gain vs Supply, Typical Operating Mode

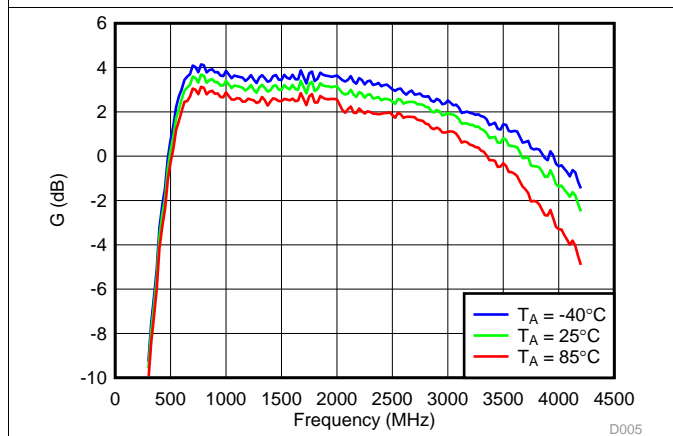

Figure 10. Voltage Gain vs Temperature, High Gain Mode

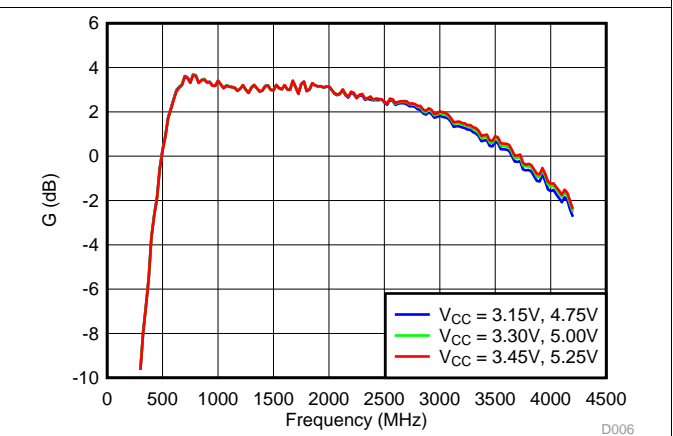

Figure 11. Voltage Gain vs Supply, High Gain Mode

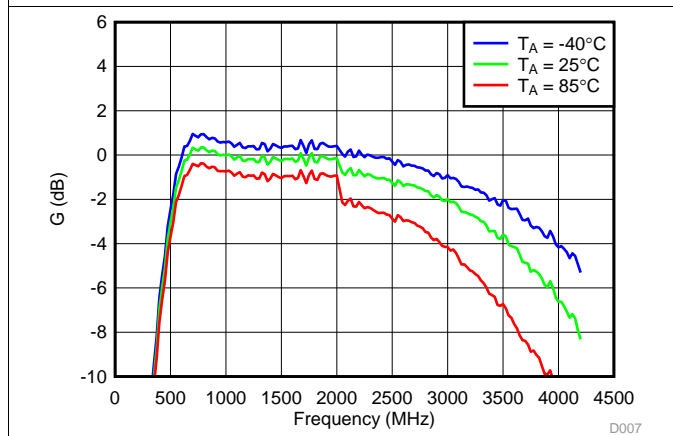

Figure 12. Voltage Gain vs Temperature, Low Power Mode

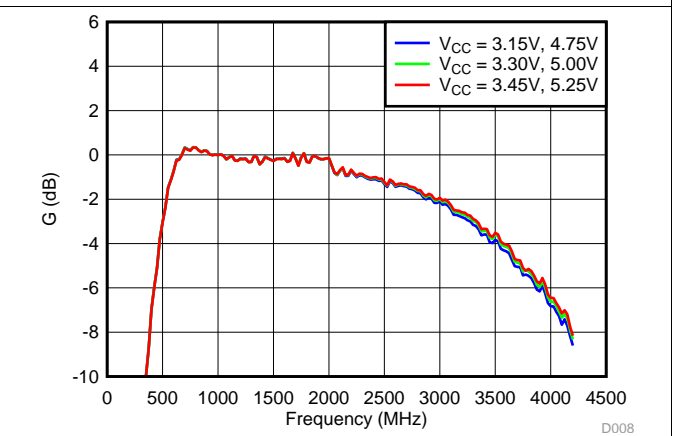

Figure 13. Voltage Gain vs Supply, Low Power Mode

### 6.9 Typical Characteristics - OIP3

Unless specified all plots were created using TRF3722EVM,  $V_{CC} = 3.3\text{ V}$ ,  $V_{CC\_TK} = 5\text{ V}$ ,  $T_A = 25^\circ\text{C}$ , I/Q frequency ( $f_{BB}$ ) 4.5 MHz and 5.5 MHz,  $V_{CM} = 0.25\text{ V}$ , and 4.7 pF series capacitor at RFOUT. Optimized bias settings as per Table 16. Reported OIP3 is minimum of low side and high side.

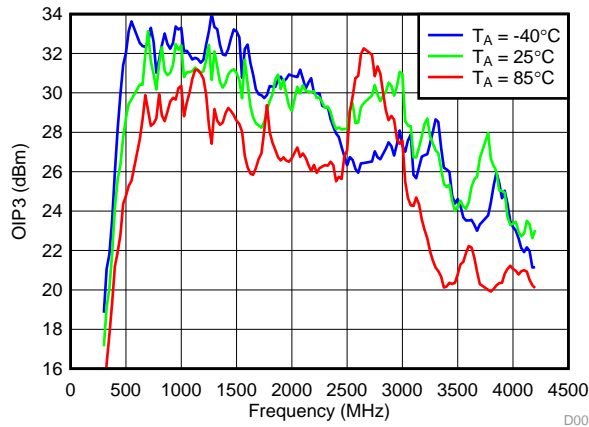

Figure 14. OIP3 vs Temperature, Typical Operating Mode

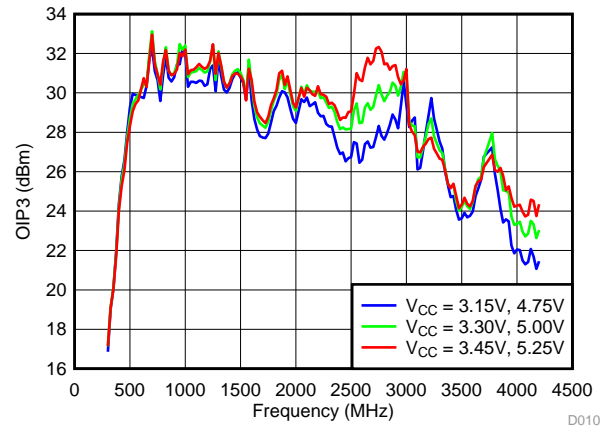

Figure 15. OIP3 vs Supply, Typical Operating Mode

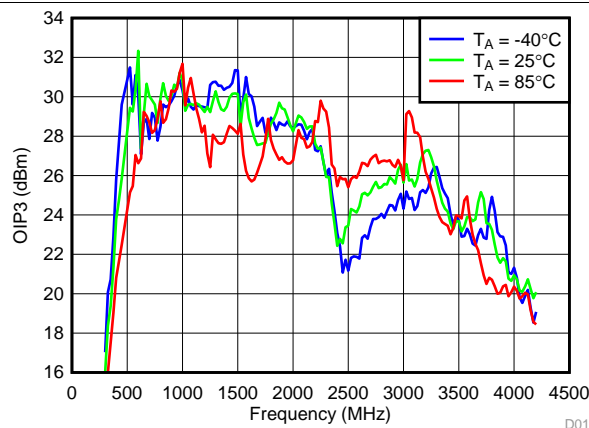

Figure 16. OIP3 vs Temperature, High Gain Mode

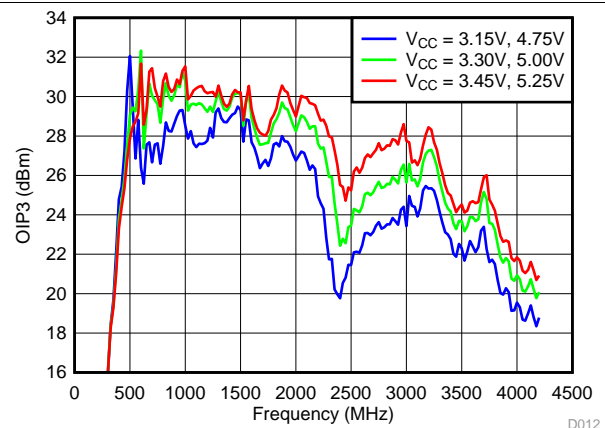

Figure 17. OIP3 vs Supply, High Gain Mode

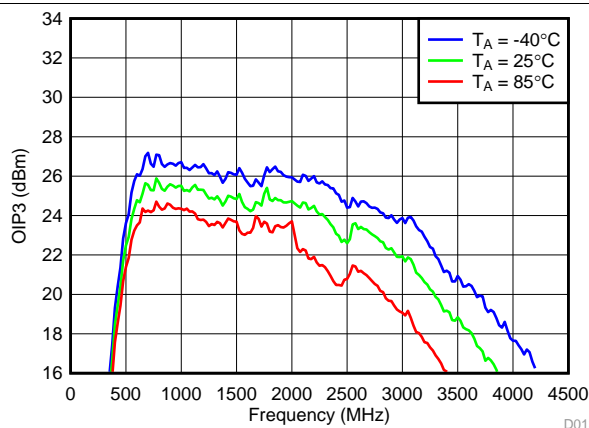

Figure 18. OIP3 vs Temperature, Low Power Mode

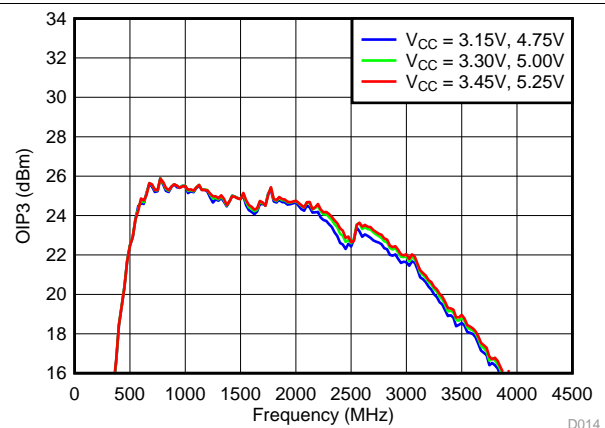

Figure 19. OIP3 vs Supply, Low Power Mode

### 6.10 Typical Characteristics - OIP2

Unless specified all plots were created using TRF3722EVM,  $V_{CC} = 3.3\text{ V}$ ,  $V_{CC\_TK} = 5\text{ V}$ ,  $T_A = 25^\circ\text{C}$ , I/Q frequency ( $f_{BB}$ ) 4.5 MHz and 5.5 MHz,  $V_{CM} = 0.25\text{ V}$ , and 4.7 pF series capacitor at RFOUT. Optimized bias settings as per Table 16. Reported OIP2 is minimum of low side and high side.

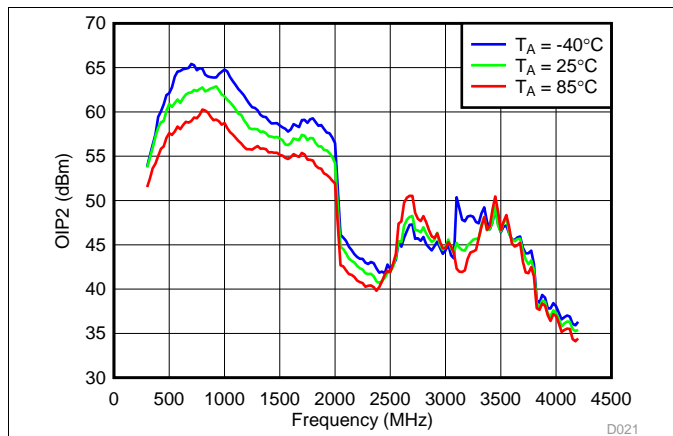

Figure 20. OIP2 vs Temperature, Typical Operating Mode

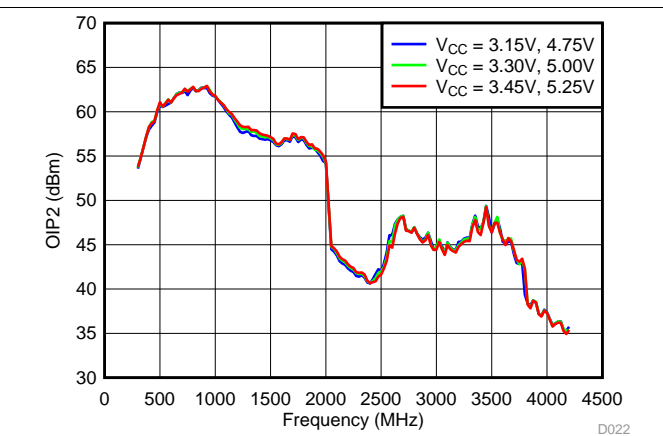

Figure 21. OIP2 vs Supply, Typical Operating Mode

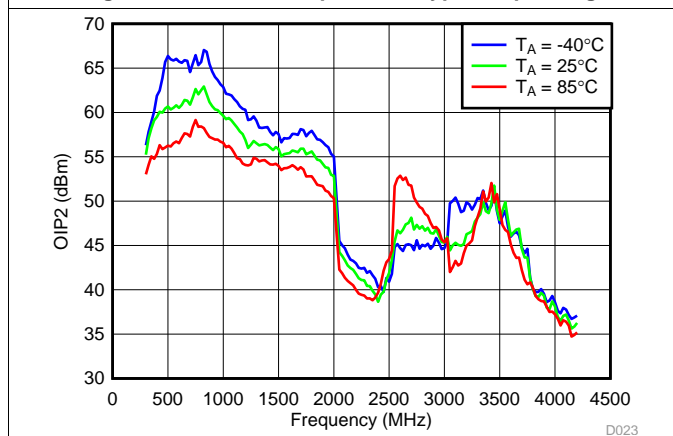

Figure 22. OIP2 vs Temperature, High Gain Mode

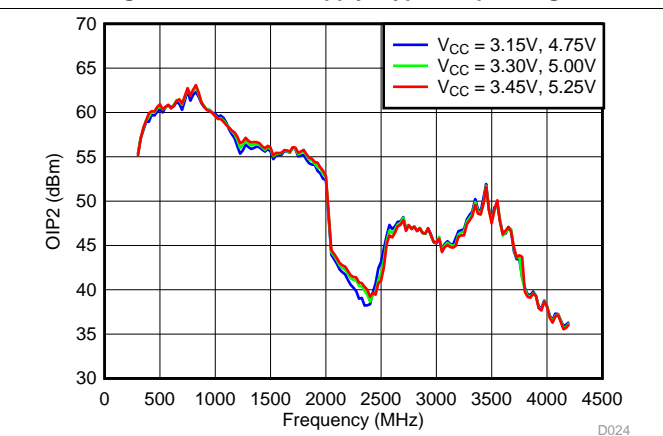

Figure 23. OIP2 vs Supply, High Gain Mode

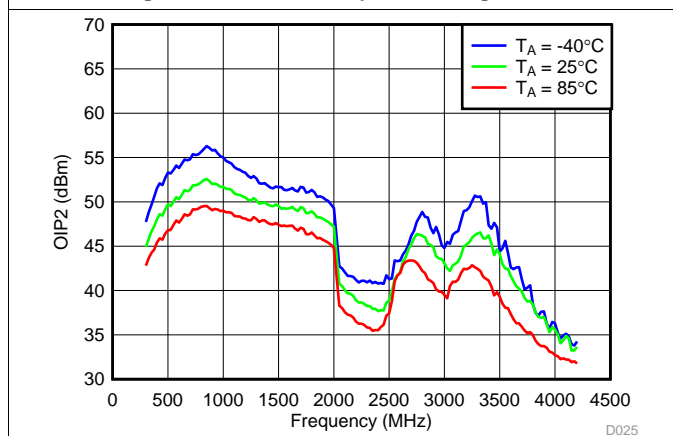

Figure 24. OIP2 vs Temperature, Low Power Mode

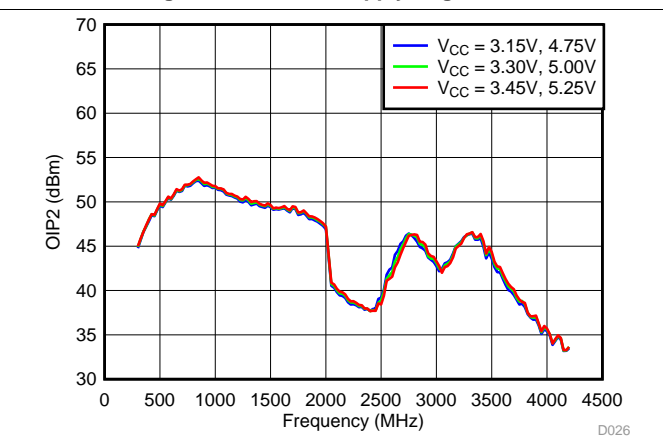

Figure 25. OIP2 vs Supply, Low Power Mode

### 6.11 Typical Characteristics - OP1dB

Unless specified all plots were created using TRF3722EVM,  $V_{CC} = 3.3\text{ V}$ ,  $V_{CC\_TK} = 5\text{ V}$ ,  $T_A = 25^\circ\text{C}$ , I/Q frequency ( $f_{BB}$ ) 5 MHz,  $V_{CM} = 0.25\text{ V}$ , and 4.7 pF series capacitor at RFOUT. Optimized bias settings as per Table 16.

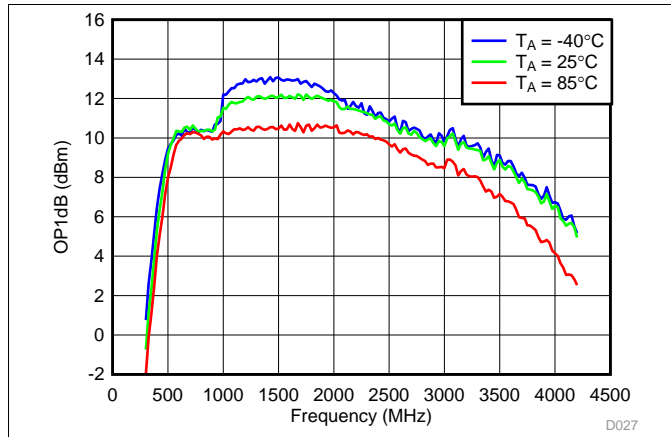

Figure 26. OP1dB vs Temperature, Typical Operating Mode

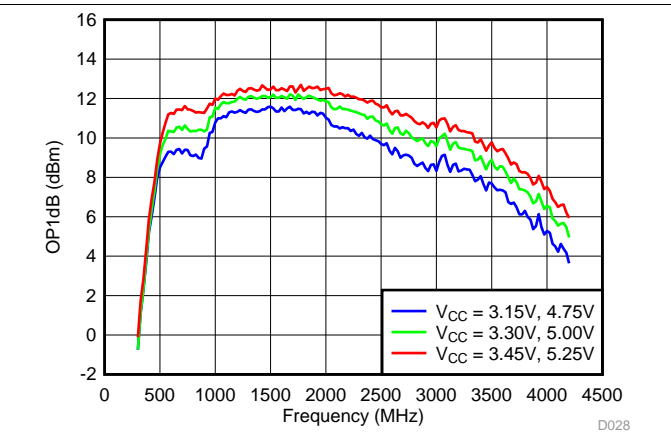

Figure 27. OP1dB vs Supply, Typical Operating Mode

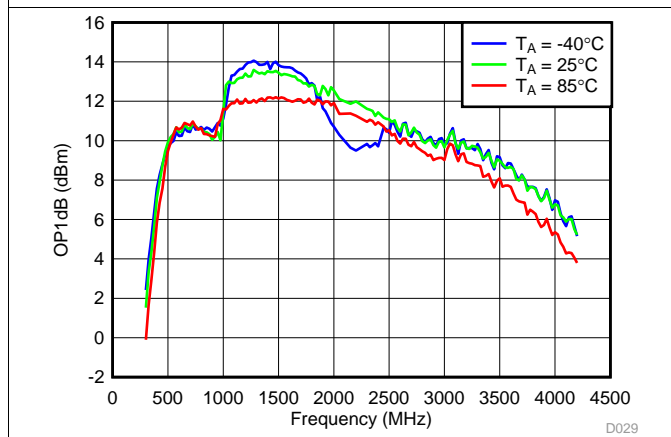

Figure 28. OP1dB vs Temperature, High Gain Mode

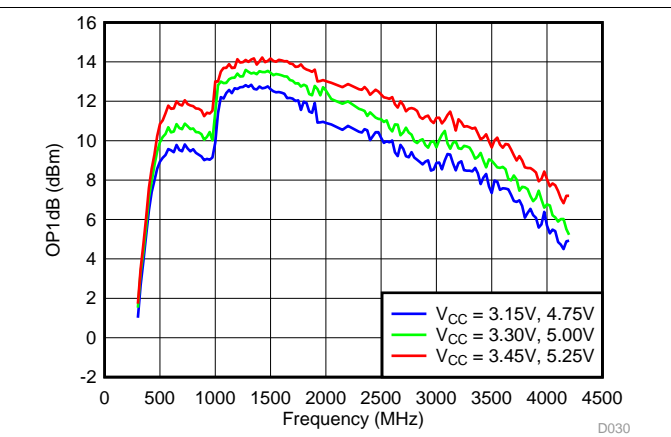

Figure 29. OP1dB vs Supply, High Gain Mode

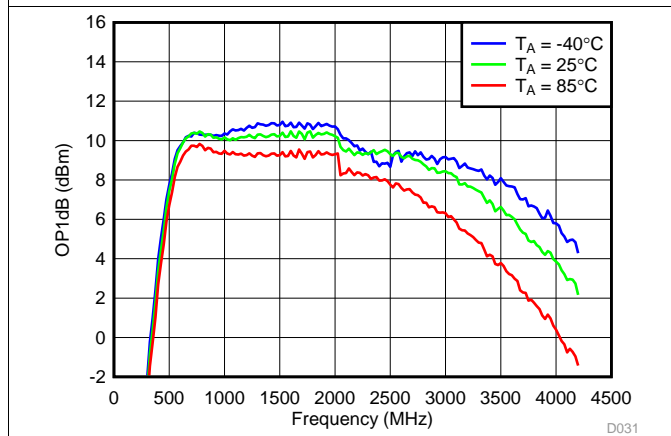

Figure 30. OP1dB vs Temperature, Low Power Mode

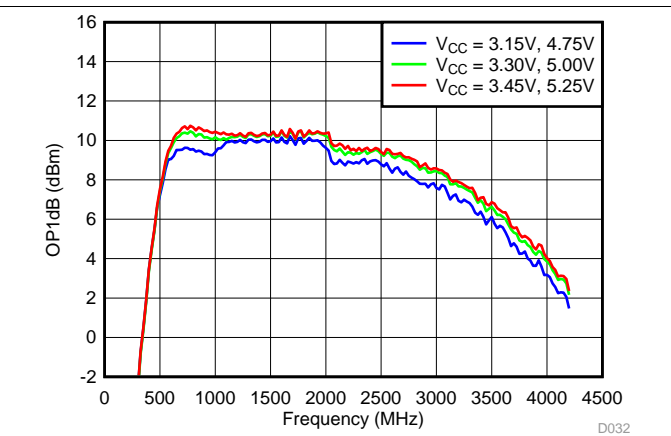

Figure 31. OP1dB vs Supply, Low Power Mode

### 6.12 Typical Characteristics - Noise

Unless specified all plots were created using TRF3722EVM, VCC = 3.3 V, VCC\_TK = 5 V, T<sub>A</sub> = 25°C, BB inputs terminated to 50 Ω and 4.7 pF series capacitor at RFOUT. Optimized bias settings as per Table 16.

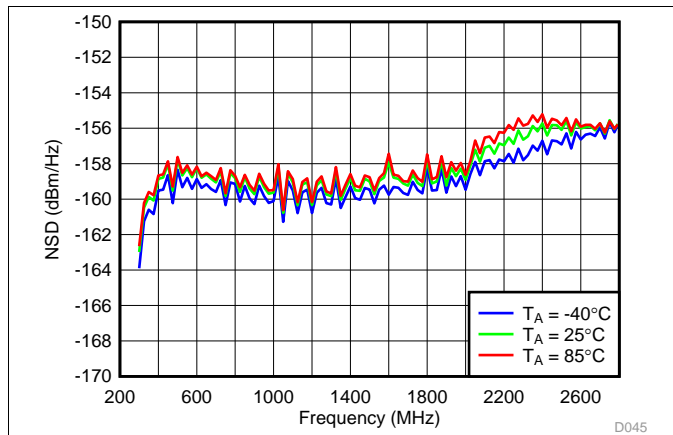

Figure 32. Noise vs Temperature, Typical Operating Mode

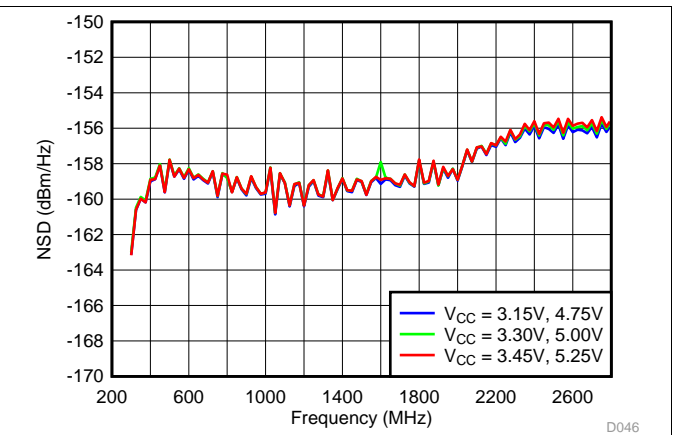

Figure 33. Noise vs Supply, Typical Operating Mode

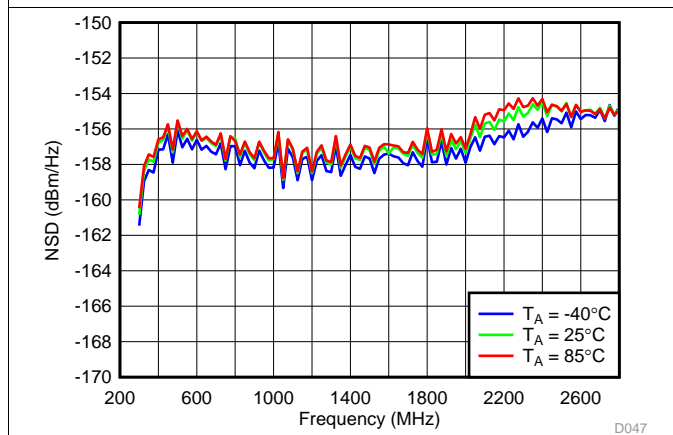

Figure 34. Noise vs Temperature, High Gain Mode

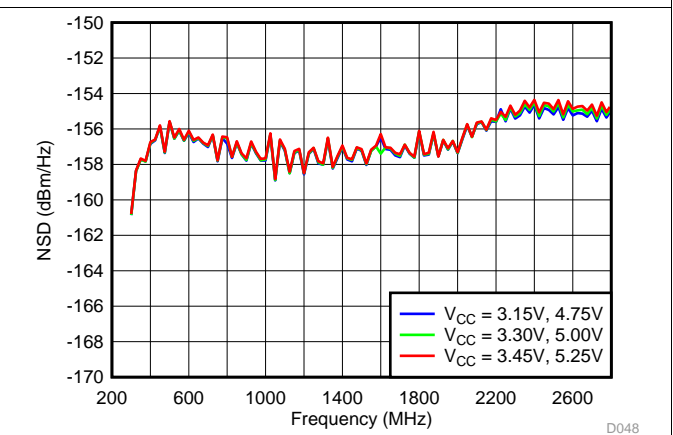

Figure 35. Noise vs Supply, High Gain Mode

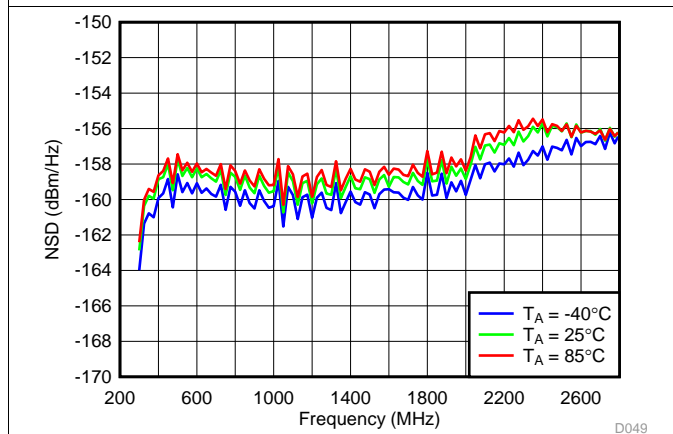

Figure 36. Noise vs Temperature, Low Power Mode

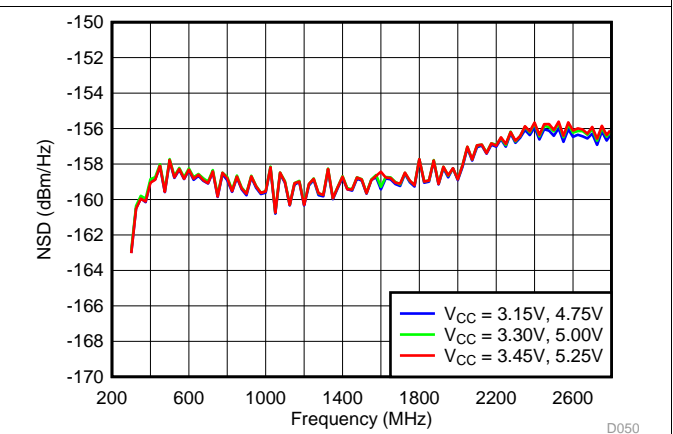

Figure 37. Noise vs Supply, Low Power Mode

### 6.13 Typical Characteristics - Unadjusted CF

Unless specified all plots were created using TRF3722EVM,  $V_{CC} = 3.3\text{ V}$ ,  $V_{CC\_TK} = 5\text{ V}$ ,  $T_A = 25^\circ\text{C}$ , I/Q frequency ( $f_{BB}$ ) 4.5 MHz and 5.5 MHz,  $V_{CM} = 0.25\text{ V}$ , and 4.7 pF series capacitor at RFOUT. Optimized bias settings as per Table 16.

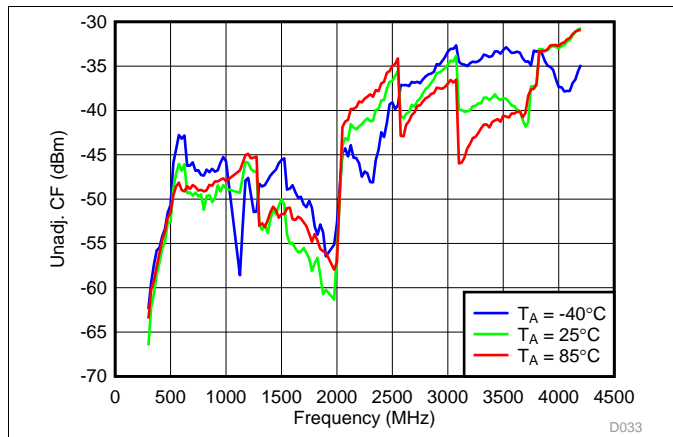

Figure 38. Unadjustable CF vs Temperature, Typical Operating Mode

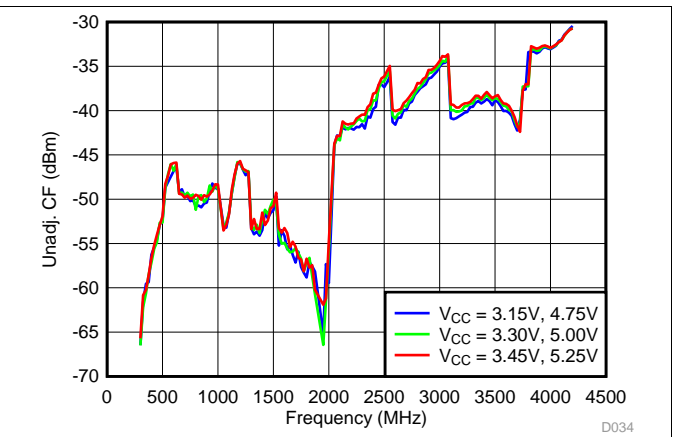

Figure 39. Unadjustable CF vs Supply, Typical Operating Mode

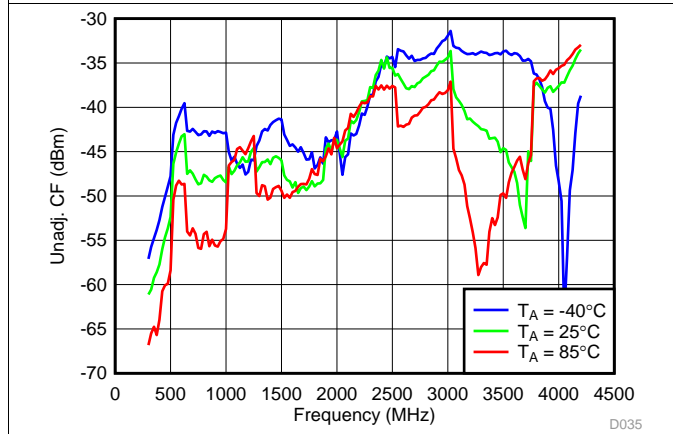

Figure 40. Unadjustable CF vs Temperature, High Gain Mode

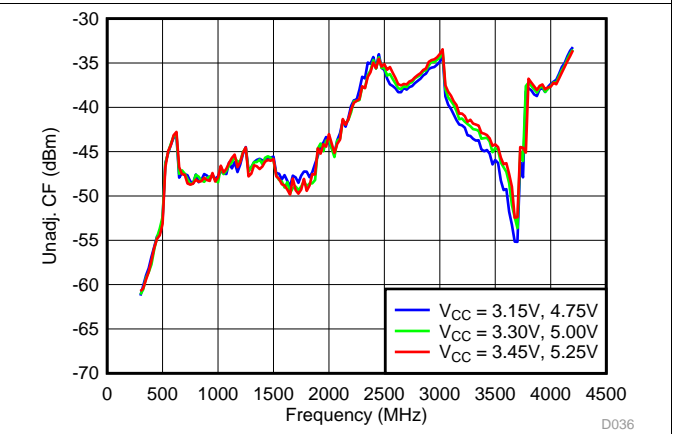

Figure 41. Unadjustable CF vs Supply, High Gain Mode

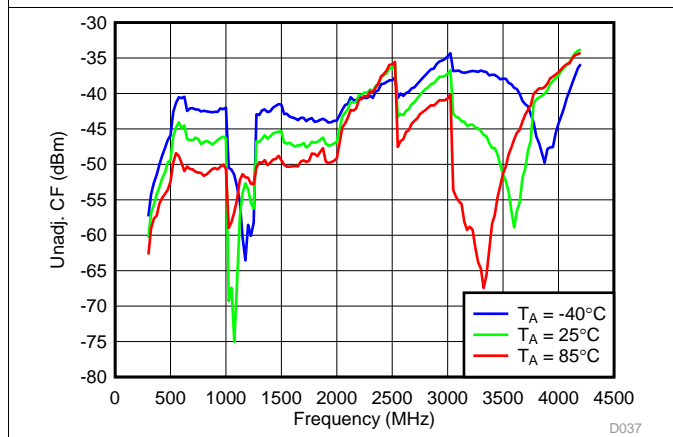

Figure 42. Unadjustable CF vs Temperature, Low Power Mode

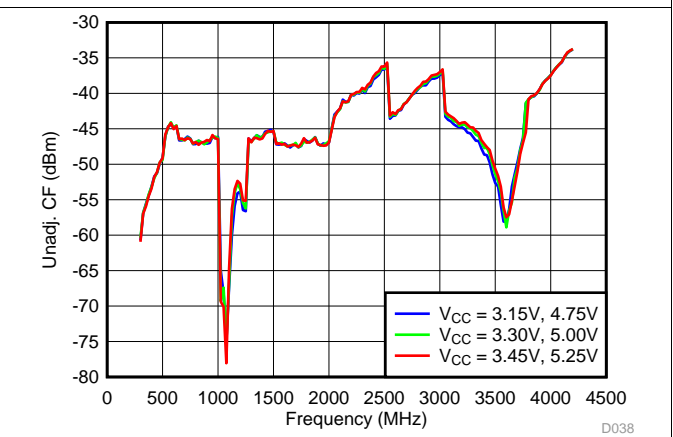

Figure 43. Unadjustable CF vs Supply, Low Power Mode



### 6.14 Typical Characteristics - Unadjusted SBS

Unless specified all plots were created using TRF3722EVM,  $V_{CC} = 3.3\text{ V}$ ,  $V_{CC\_TK} = 5\text{ V}$ , and  $T_A = 25^\circ\text{C}$ , I/Q frequency ( $f_{BB}$ ) 4.5 MHz and 5.5 MHz,  $V_{CM} = 0.25\text{ V}$ , and 4.7 pF series capacitor at RFOUT. Optimized bias settings as per Table 16.

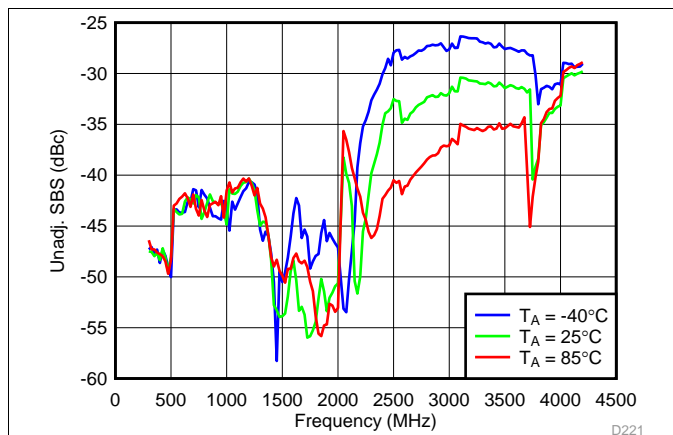

Figure 44. Unadjustable SBS vs Temperature, Typical Operating Mode

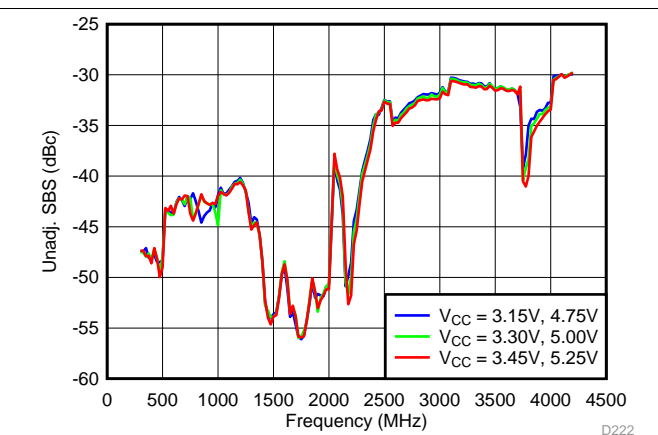

Figure 45. Unadjustable SBS vs Supply, Typical Operating Mode

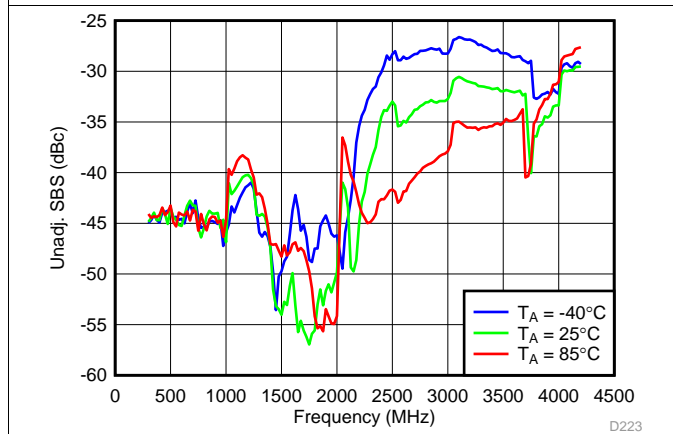

Figure 46. Unadjustable SBS vs Temperature, High Gain Mode

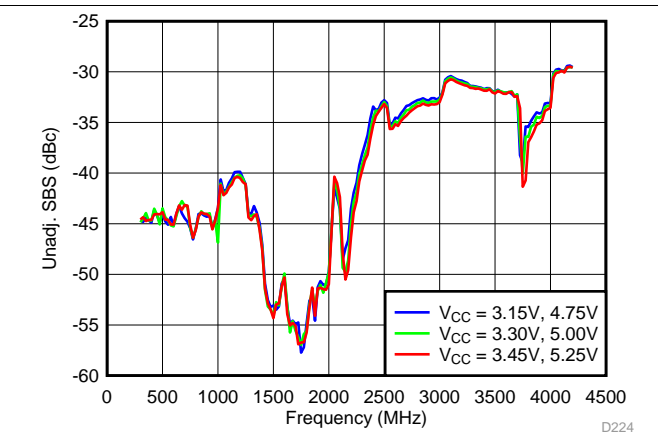

Figure 47. Unadjustable SBS vs Supply, High Gain Mode

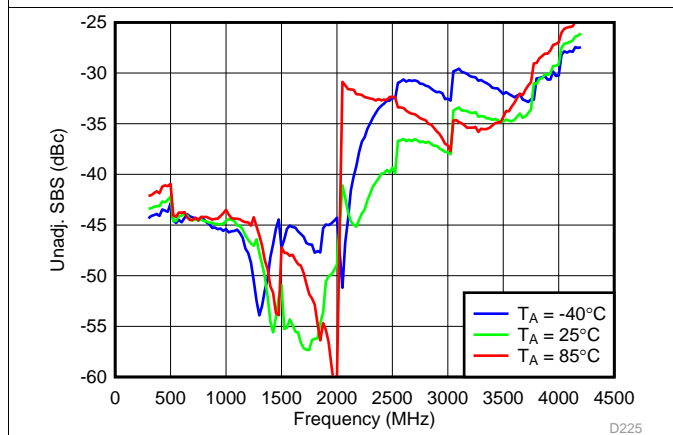

Figure 48. Unadjustable SBS vs Temperature, Low Power Mode

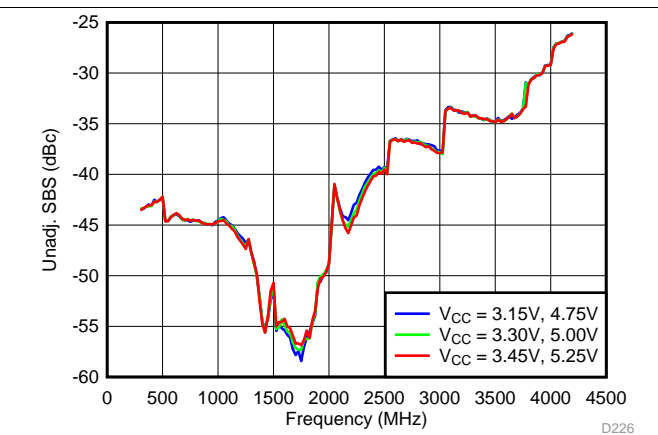

Figure 49. Unadjustable SBS vs Supply, Low Power Mode

### 6.15 Typical Characteristics - LO Harmonic

Unless specified all plots were created using TRF3722EVM,  $V_{CC} = 3.3\text{ V}$ ,  $V_{CC\_TK} = 5\text{ V}$ , and  $T_A = 25^\circ\text{C}$ , I/Q frequency ( $f_{BB}$ ) 4.5 MHz and 5.5 MHz,  $V_{CM} = 0.25\text{ V}$ , and 4.7 pF series capacitor at RFOUT. Optimized bias settings as per Table 16.

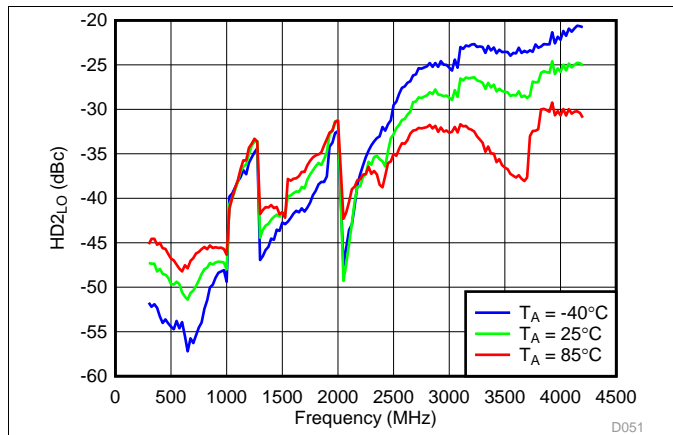

Figure 50. LO Second Harmonic vs Temperature, Typical Operating Mode

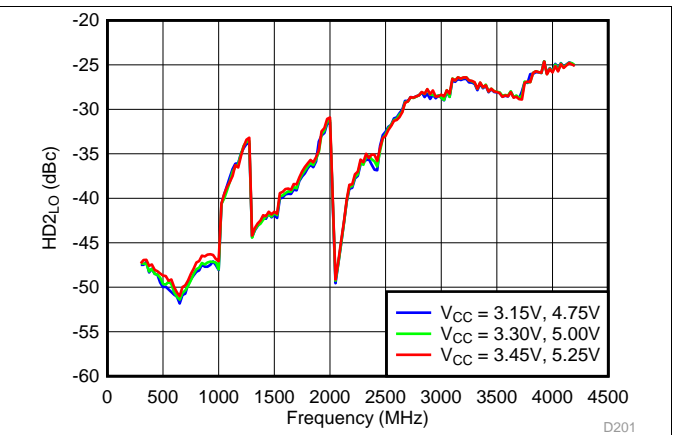

Figure 51. LO Second Harmonic vs Supply, Typical Operating Mode

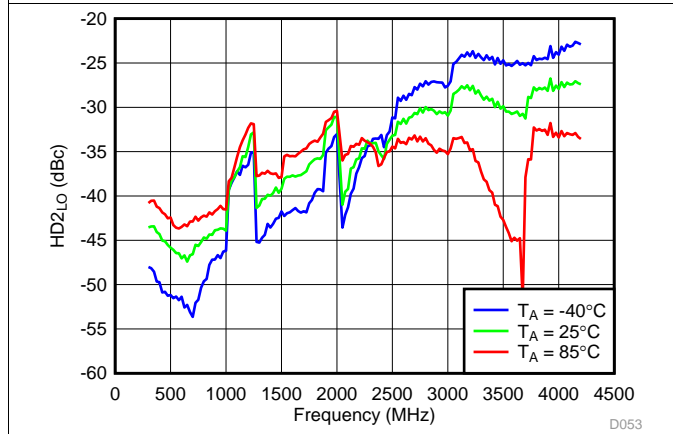

Figure 52. LO Second Harmonic vs Temperature, High Gain Mode

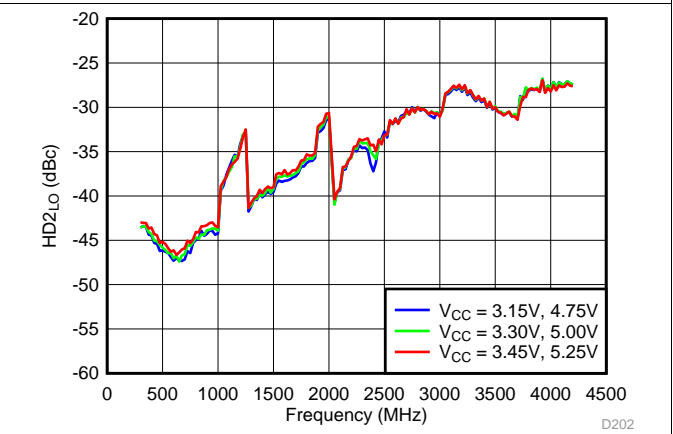

Figure 53. LO Second Harmonic vs Supply, High Gain Mode

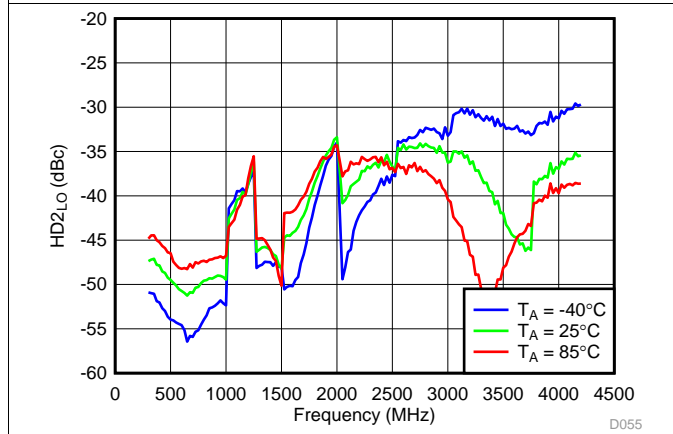

Figure 54. LO Second Harmonic vs Temperature, Low Power Mode

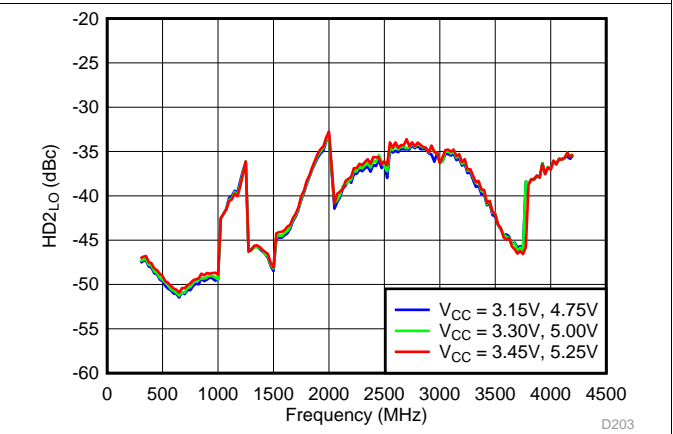
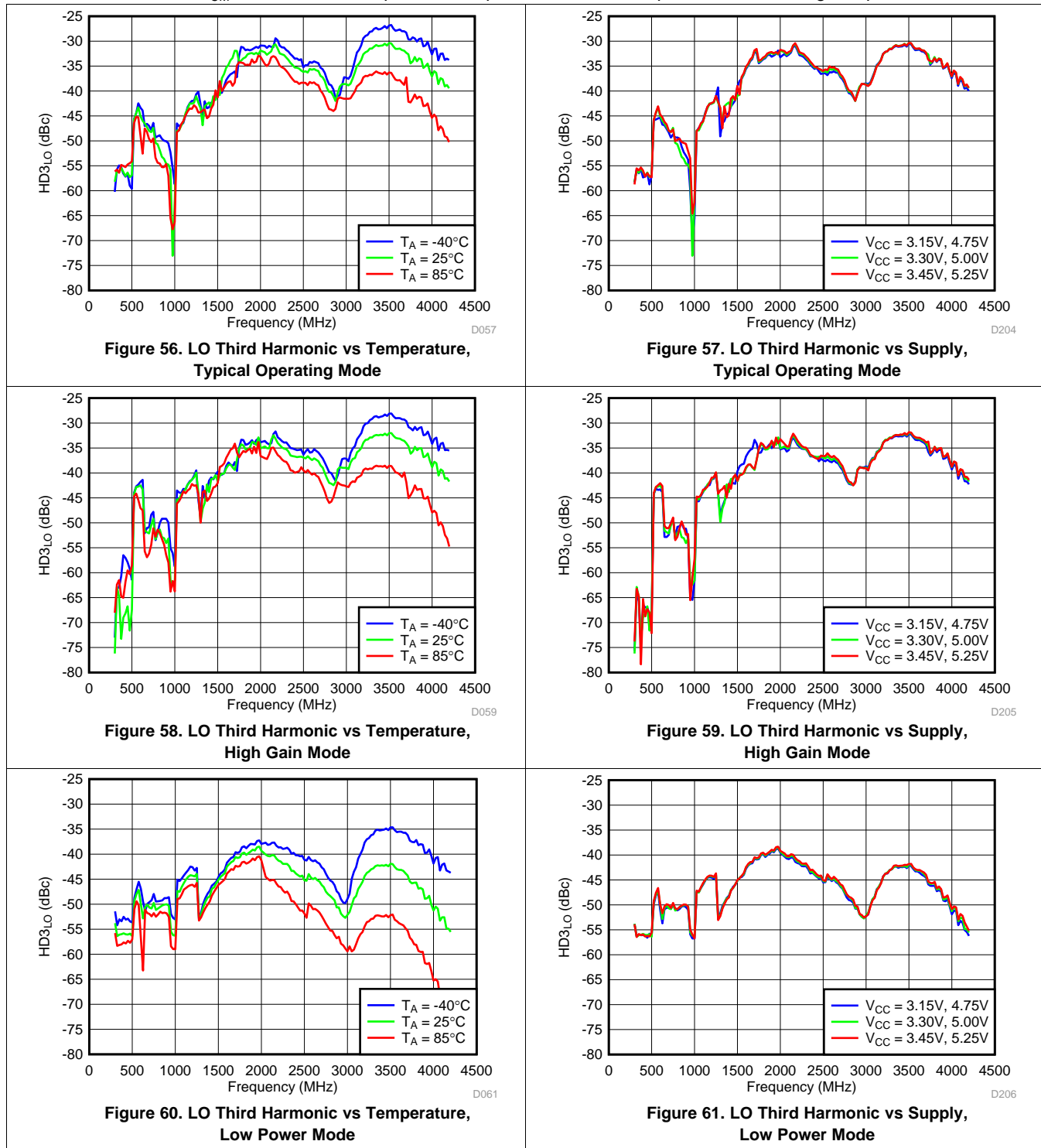

Figure 55. LO Second Harmonic vs Supply, Low Power Mode

Typical Characteristics - LO Harmonic (continued)

Unless specified all plots were created using TRF3722EVM, VCC = 3.3 V, VCC\_TK = 5 V, and TA = 25°C, I/Q frequency (fBB) 4.5 MHz and 5.5 MHz, VCM = 0.25 V, and 4.7 pF series capacitor at RFOUT. Optimized bias settings as per Table 16.



### 6.16 Typical Characteristics - BB Harmonic

Unless specified all plots were created using TRF3722EVM,  $V_{CC} = 3.3\text{ V}$ ,  $V_{CC\_TK} = 5\text{ V}$ , and  $T_A = 25^\circ\text{C}$ , I/Q frequency ( $f_{BB}$ ) 4.5 MHz and 5.5 MHz,  $V_{CM} = 0.25\text{ V}$ , and 4.7 pF series capacitor at RFOUT. Optimized bias settings as per Table 16. Reported BB harmonic is from ( $f_{BB}$ ) 4.5MHz.

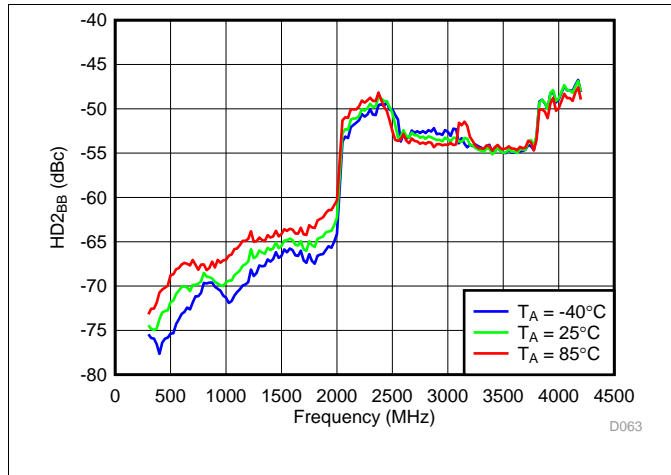

Figure 62. BB-HD2 vs Temperature, Typical Operating Mode

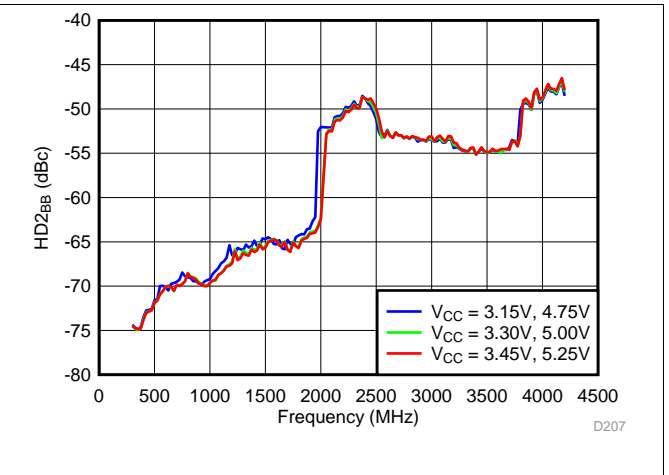

Figure 63. BB-HD2 vs Supply, Typical Operating Mode

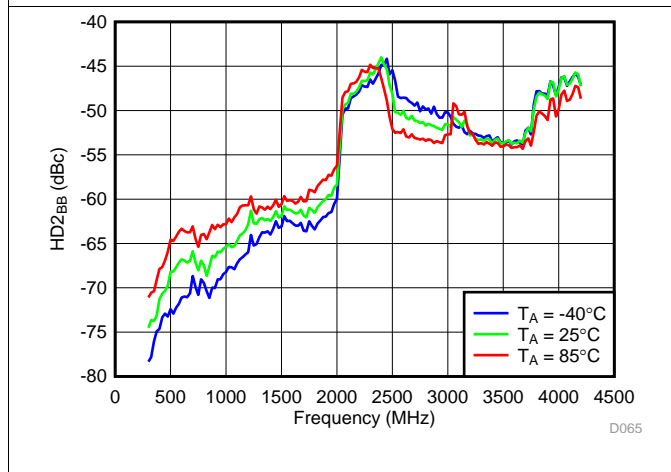

Figure 64. BB-HD2 vs Temperature, High Gain Mode

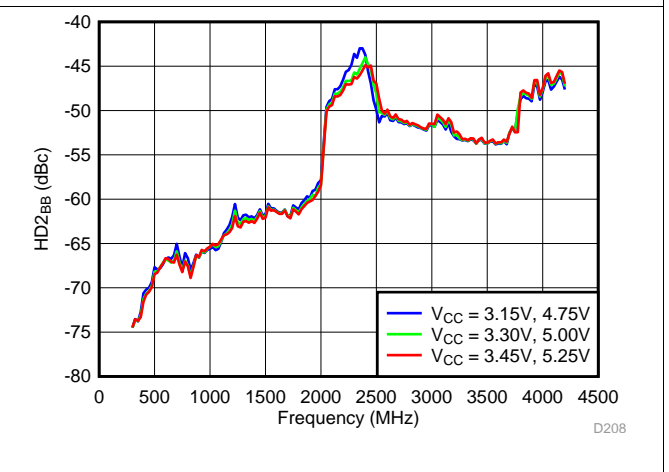

Figure 65. BB-HD2 vs Supply, High Gain Mode

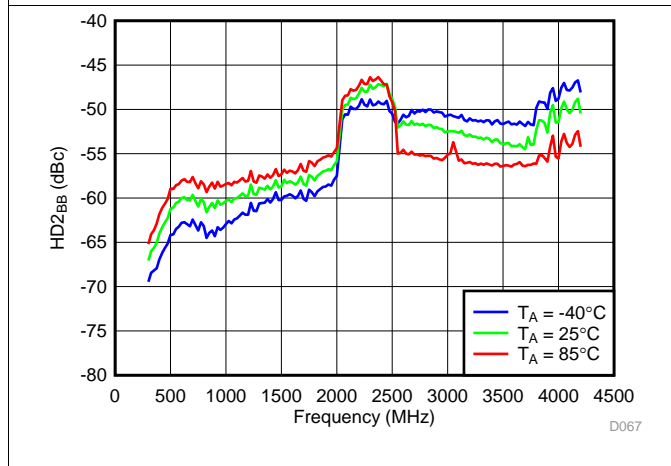

Figure 66. BB-HD2 vs Temperature, Low Power Mode

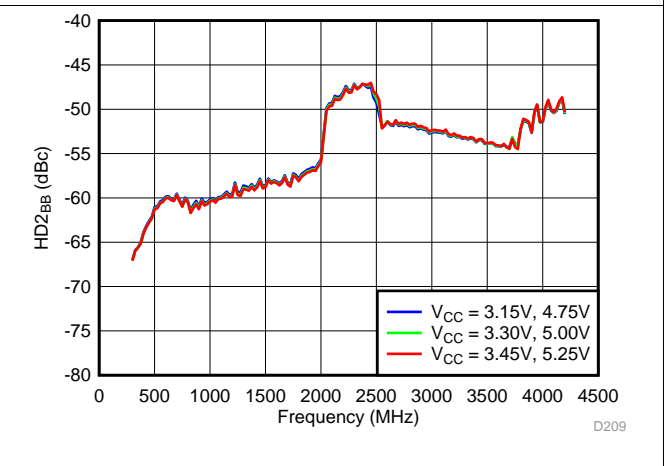
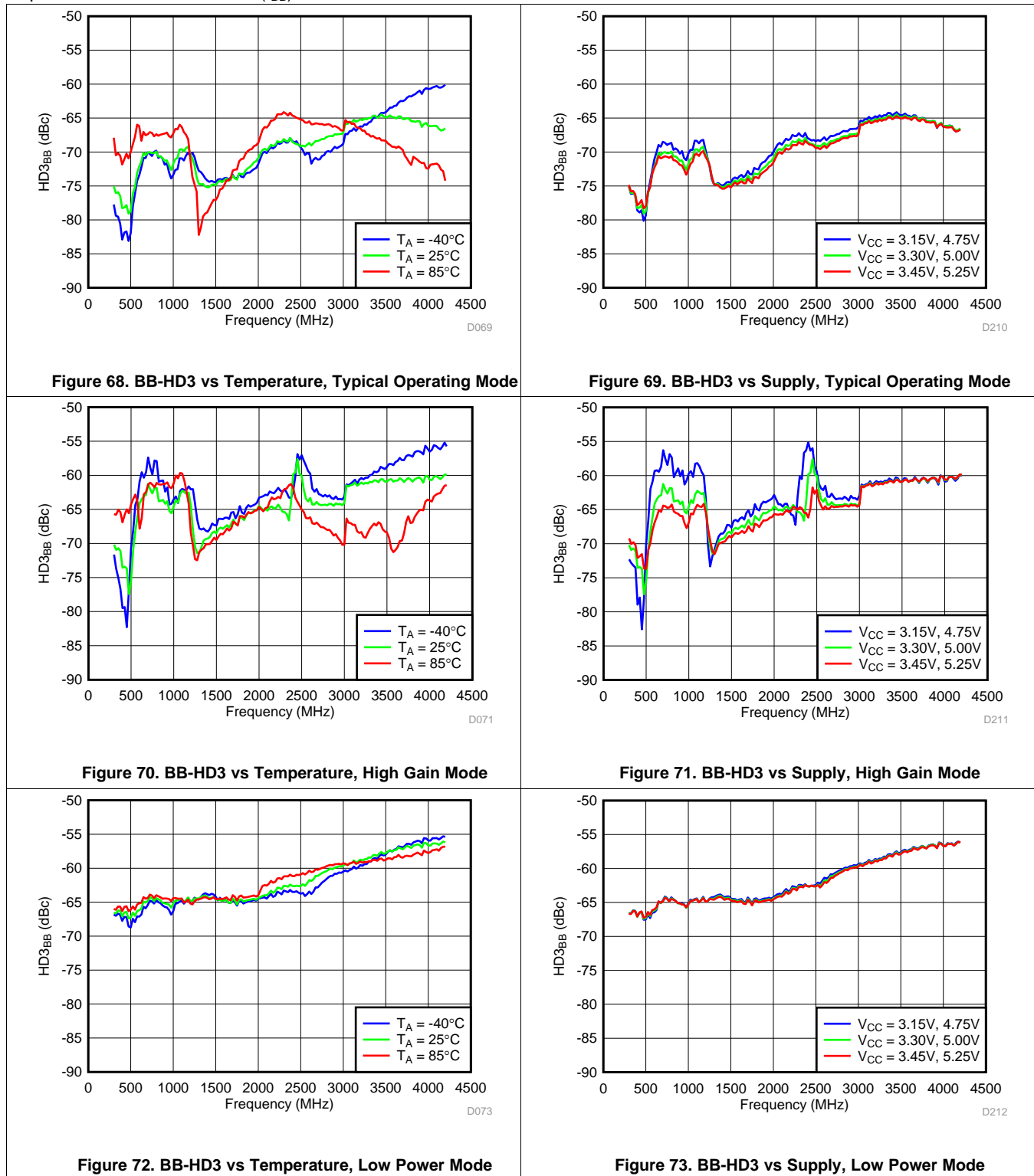

Figure 67. BB-HD2 vs Supply, Low Power Mode

### Typical Characteristics - BB Harmonic (continued)

Unless specified all plots were created using TRF3722EVM,  $V_{CC} = 3.3\text{ V}$ ,  $V_{CC\_TK} = 5\text{ V}$ , and  $T_A = 25^\circ\text{C}$ , I/Q frequency ( $f_{BB}$ ) 4.5 MHz and 5.5 MHz,  $V_{CM} = 0.25\text{ V}$ , and 4.7 pF series capacitor at RFOUT. Optimized bias settings as per Table 16. Reported BB harmonic is from ( $f_{BB}$ ) 4.5MHz.



### 6.17 Typical Characteristics - RF Output Return Loss

Unless specified all plots were created at RFOUT pin using TRF3722EVM, VCC = 3.3 V, VCC\_TK = 5 V, and T<sub>A</sub> = 25°C

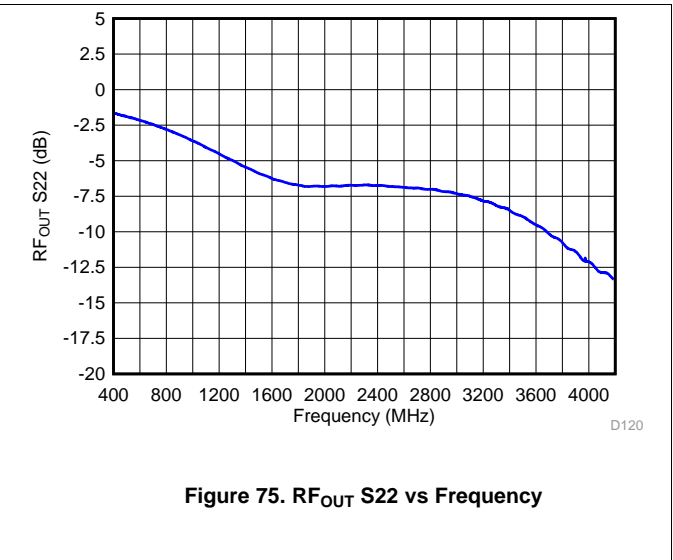
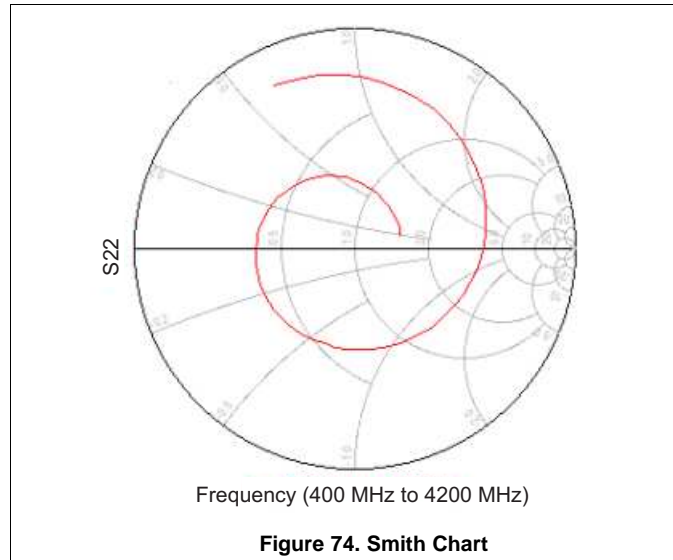

### 6.18 Typical Characteristics - PLL/VCO

Unless specified all plots were created using TRF3722EVM,  $V_{CC} = 3.3\text{ V}$ ,  $V_{CC\_TK} = 5\text{ V}$ , and  $T_A = 25^\circ\text{C}$ . Measured at LO\_OUTP with  $50\ \Omega$  bias resistor and  $47\text{ pF}$  series capacitor. Modulator section powered down. Reference frequency is set to  $61.44\text{ MHz}$ . Optimized bias settings as per [Table 16](#).

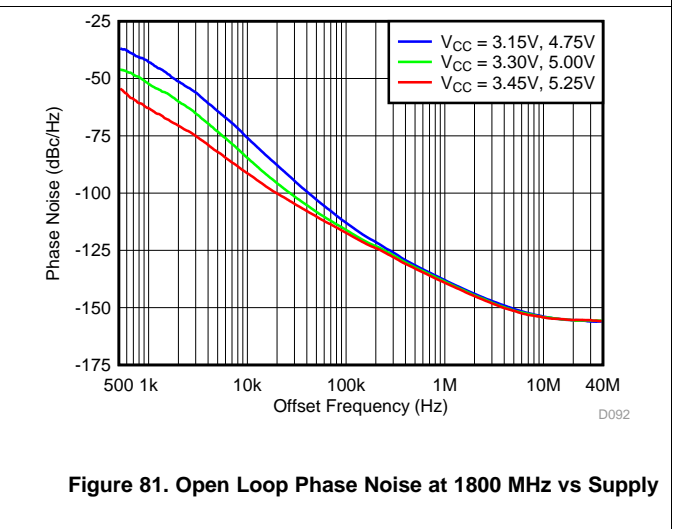
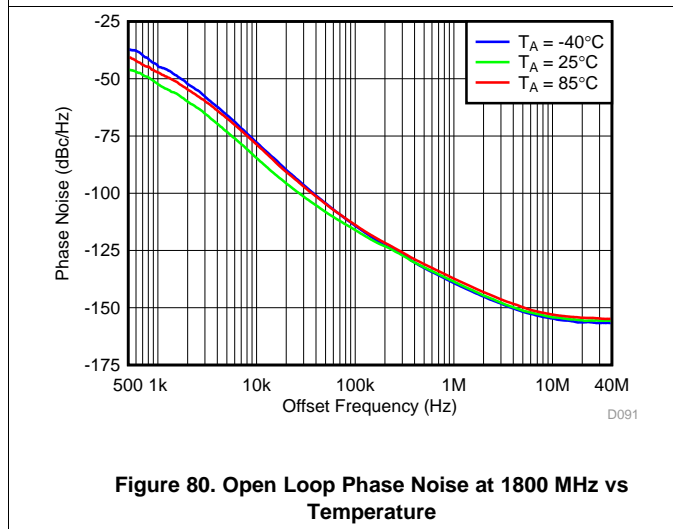
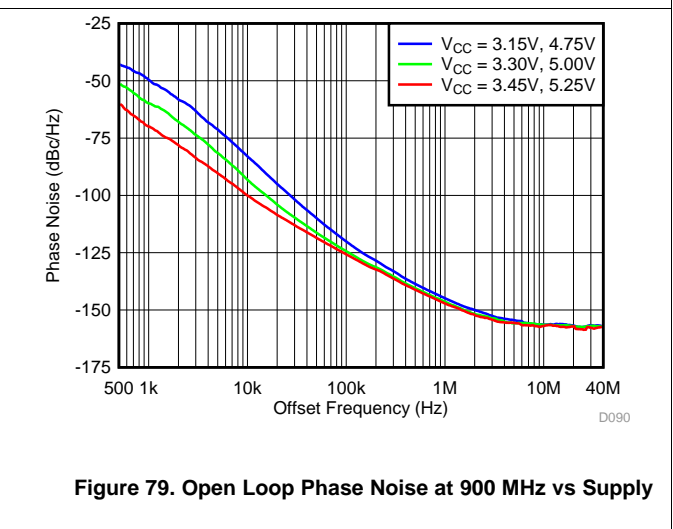
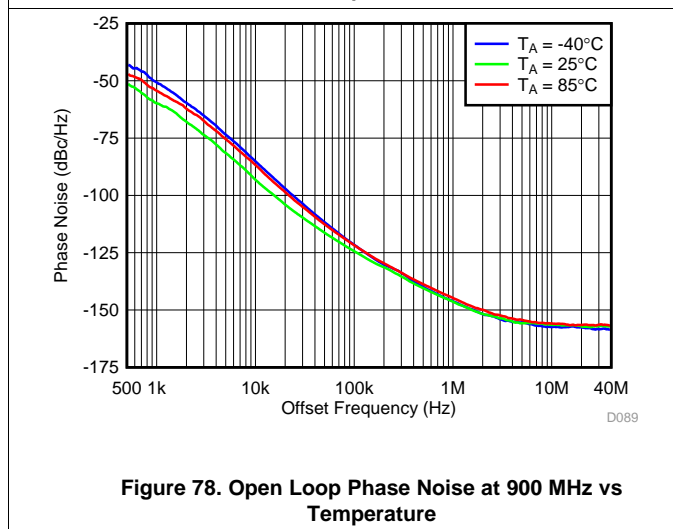
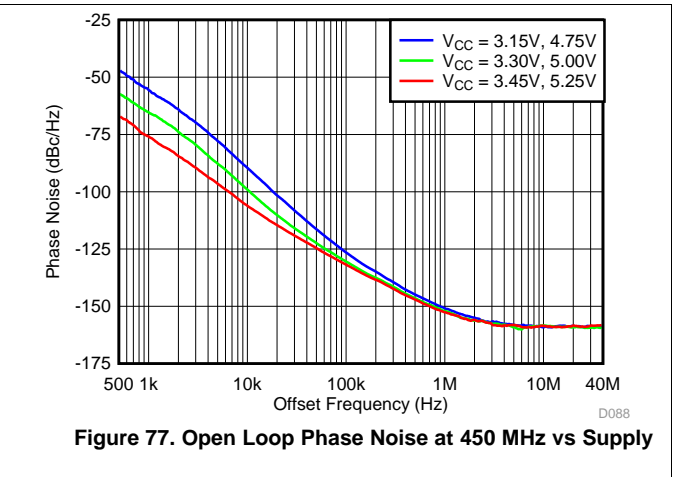
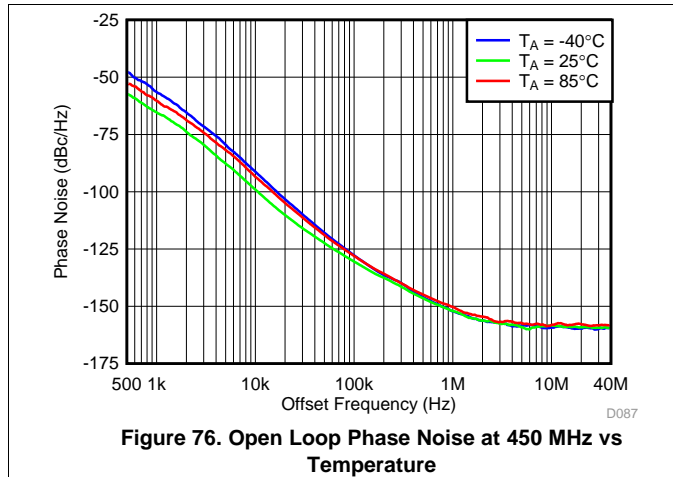

Typical Characteristics - PLL/VCO (continued)

Unless specified all plots were created using TRF3722EVM, VCC = 3.3 V, VCC\_TK = 5 V, and T<sub>A</sub> = 25°C. Measured at LO\_OUTP with 50 Ω bias resistor and 47 pF series capacitor. Modulator section powered down. Reference frequency is set to 61.44 MHz. Optimized bias settings as per Table 16.

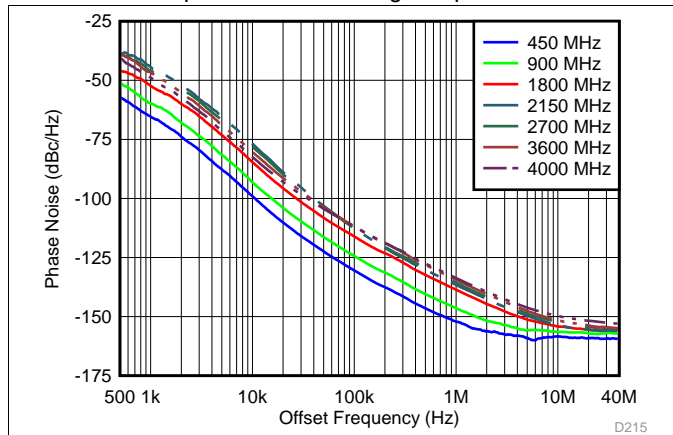

Figure 82. Open Loop Phase Noise vs Frequency

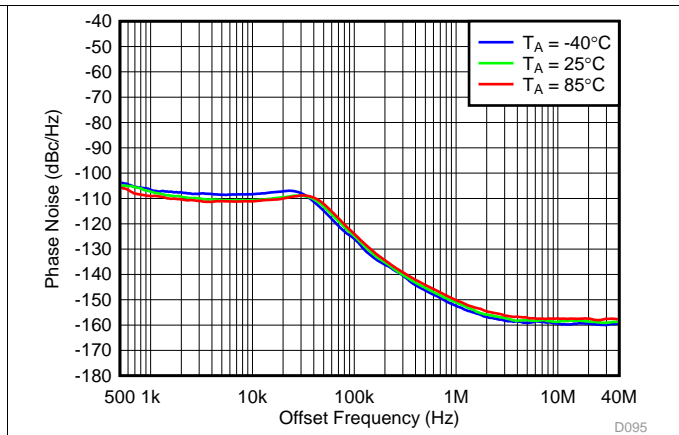

Figure 83. 450 MHz Frac-N (Closed Loop Phase Noise) vs Temperature

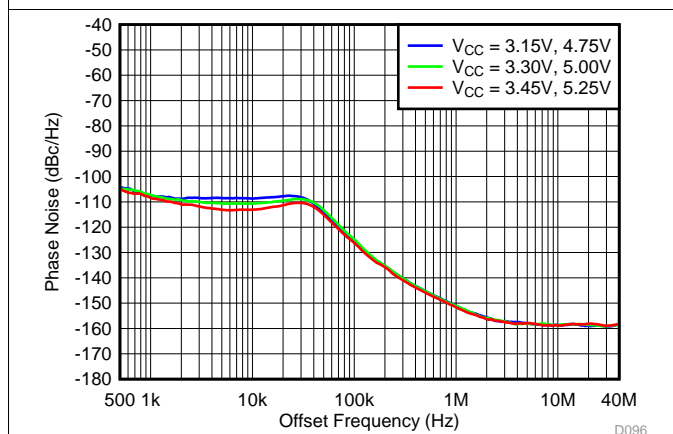

Figure 84. 450 MHz Frac-N (Closed Loop Phase Noise) vs Supply

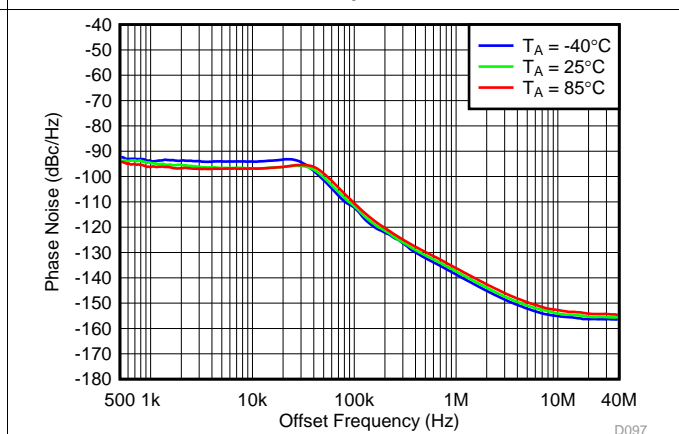

Figure 85. 1800 MHz Frac-N (Closed Loop Phase Noise) vs Temperature

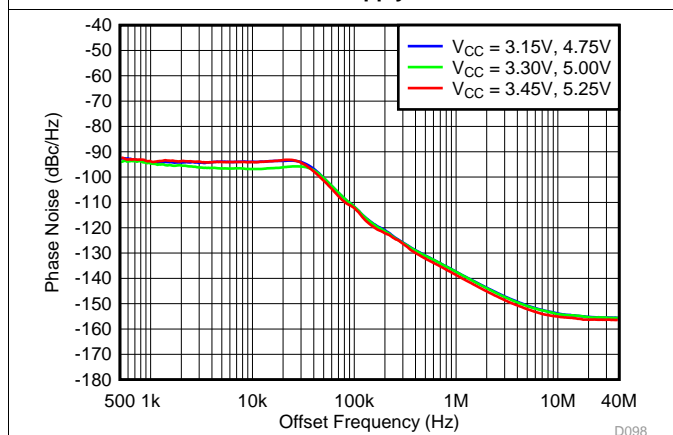

Figure 86. 1800 MHz Frac-N (Closed Loop Phase Noise) vs Supply

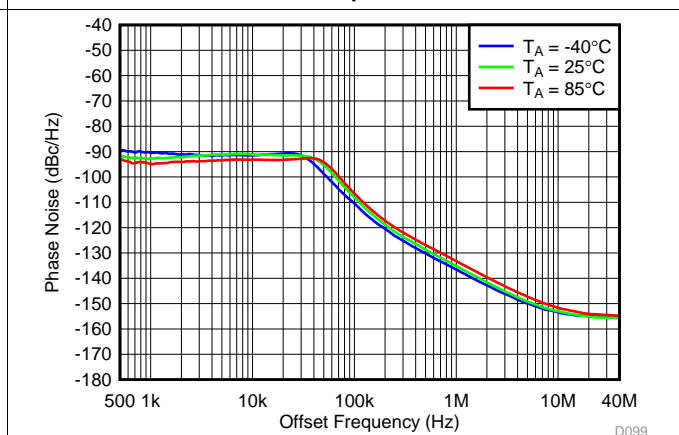

Figure 87. 2150 MHz Frac-N (Closed Loop Phase Noise) vs Temperature



Typical Characteristics - PLL/VCO (continued)

Unless specified all plots were created using TRF3722EVM, VCC = 3.3 V, VCC\_TK = 5 V, and TA = 25°C. Measured at LO\_OUTP with 50 Ω bias resistor and 47 pF series capacitor. Modulator section powered down. Reference frequency is set to 61.44 MHz. Optimized bias settings as per Table 16.

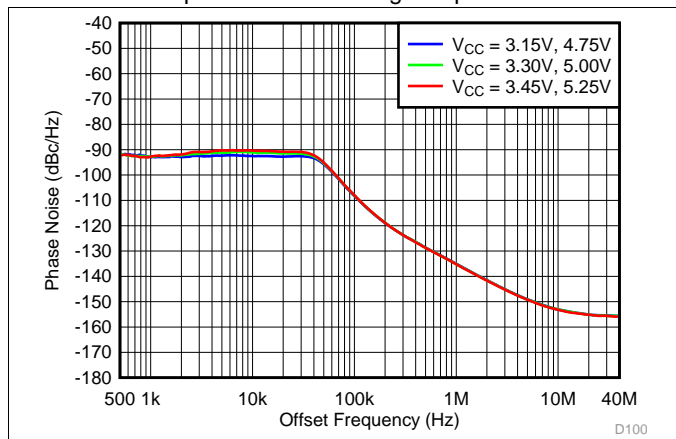

Figure 88. 2150 MHz Frac-N (Closed Loop Phase Noise) vs Supply

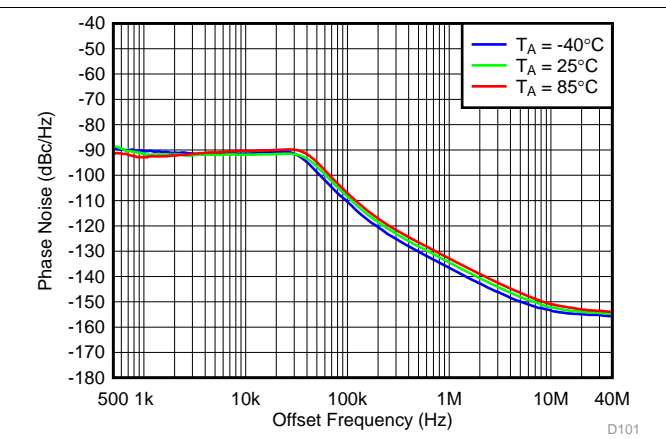

Figure 89. 2700 MHz Frac-N (Closed Loop Phase Noise) vs Temperature

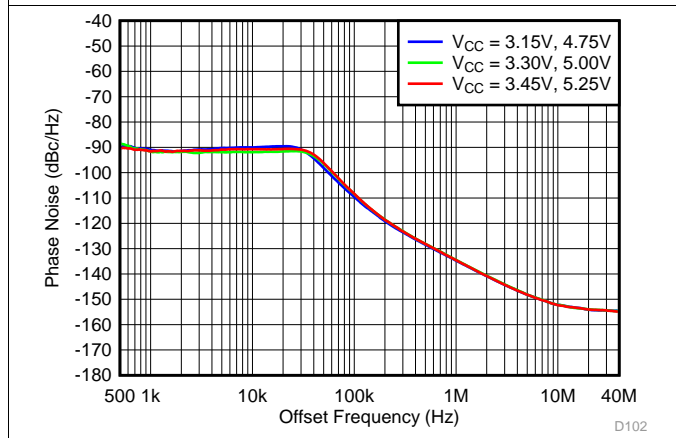

Figure 90. 2700 MHz Frac-N (Closed Loop Phase Noise) vs Supply

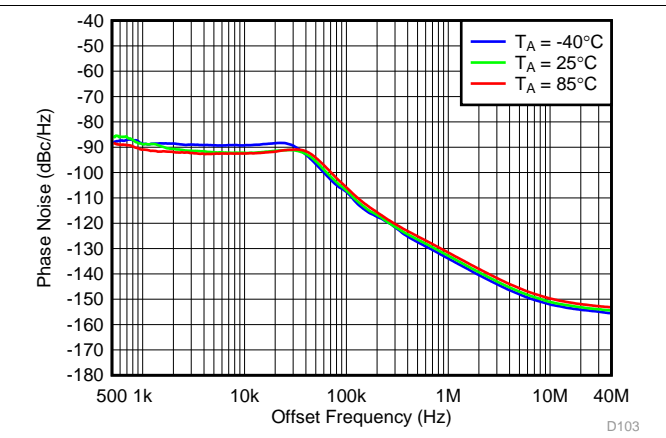

Figure 91. 3600 MHz Frac-N (Closed Loop Phase Noise) vs Temperature

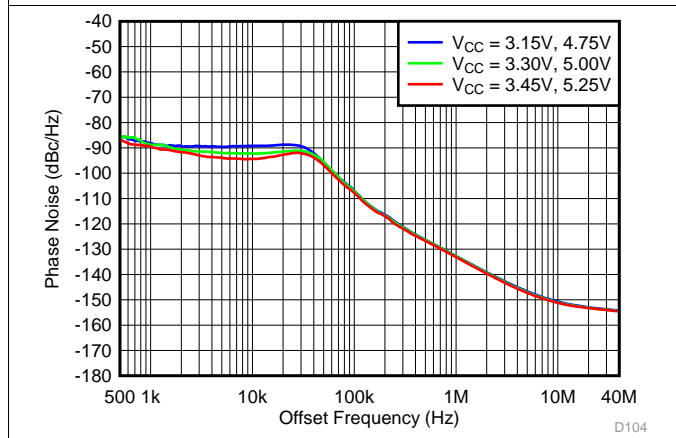

Figure 92. 3600 MHz Frac-N (Closed Loop Phase Noise) vs Supply

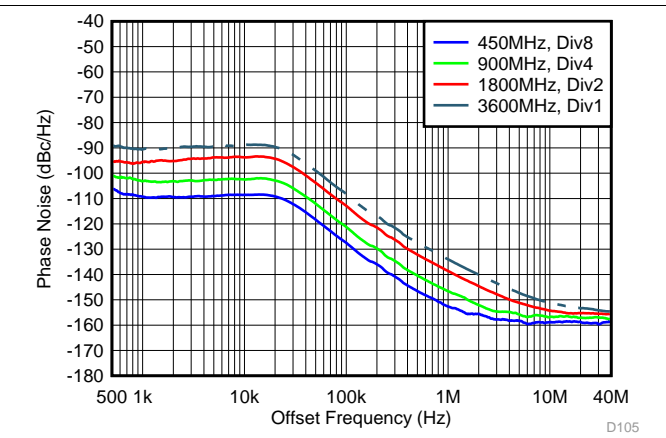
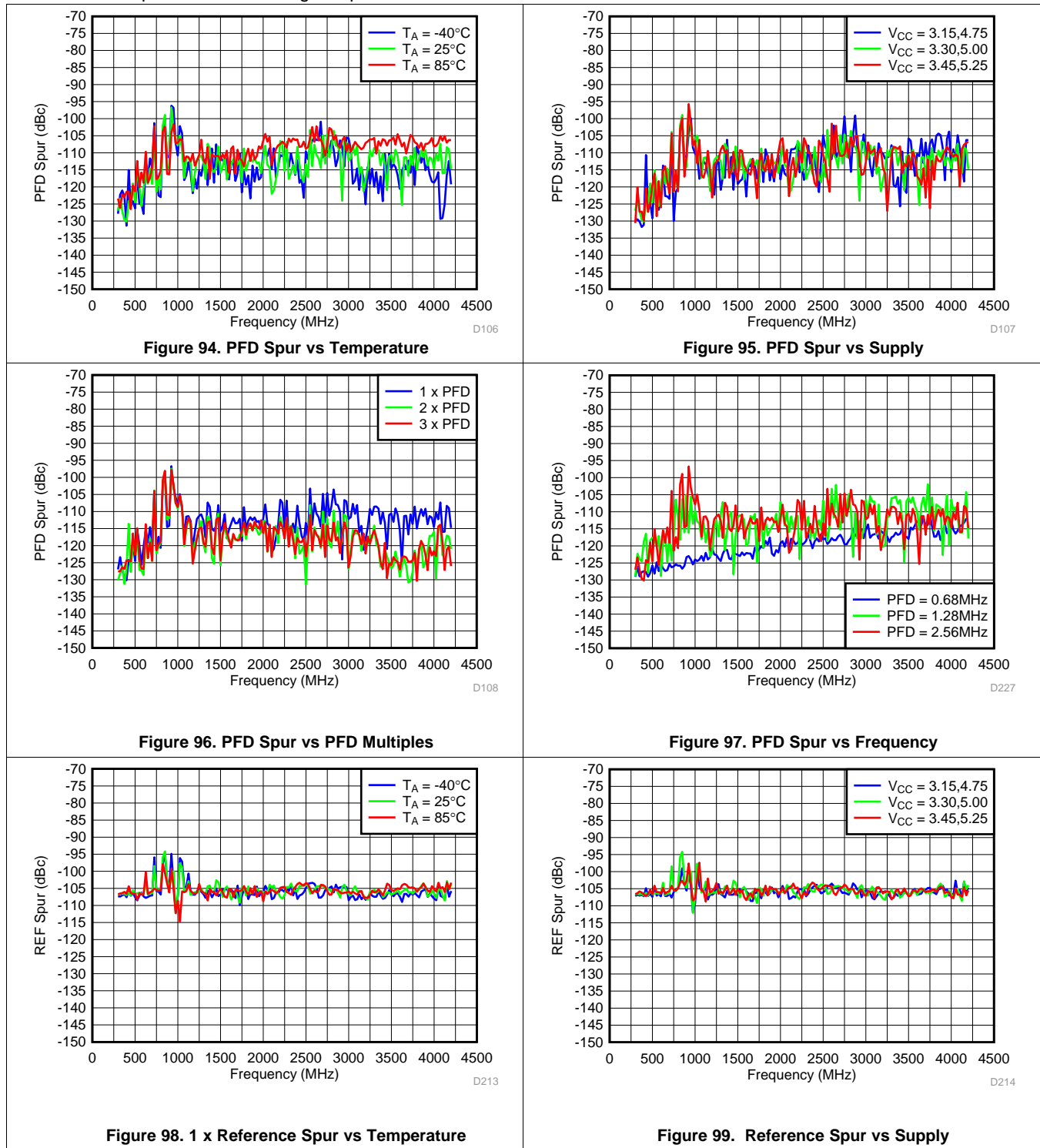

Figure 93. 450, 900, 1800, 3600 MHz Closed Loop Phase Noise vs Offset Frequency

### Typical Characteristics - PLL/VCO (continued)

Unless specified all plots were created using TRF3722EVM, VCC = 3.3 V, VCC\_TK = 5 V, and T<sub>A</sub> = 25°C. Measured at LO\_OUTP with 50 Ω bias resistor and 47 pF series capacitor. Modulator section powered down. Reference frequency is set to 61.44 MHz. Optimized bias settings as per Table 16.



Typical Characteristics - PLL/VCO (continued)

Unless specified all plots were created using TRF3722EVM, VCC = 3.3 V, VCC\_TK = 5 V, and TA = 25°C. Measured at LO\_OUTP with 50 Ω bias resistor and 47 pF series capacitor. Modulator section powered down. Reference frequency is set to 61.44 MHz. Optimized bias settings as per Table 16.

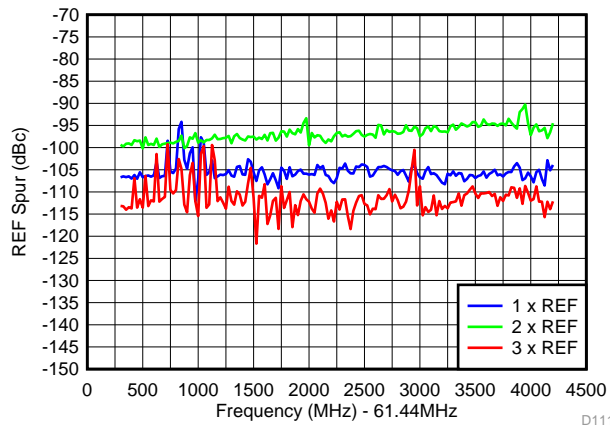

Figure 100. Reference Spur vs Reference Multiples

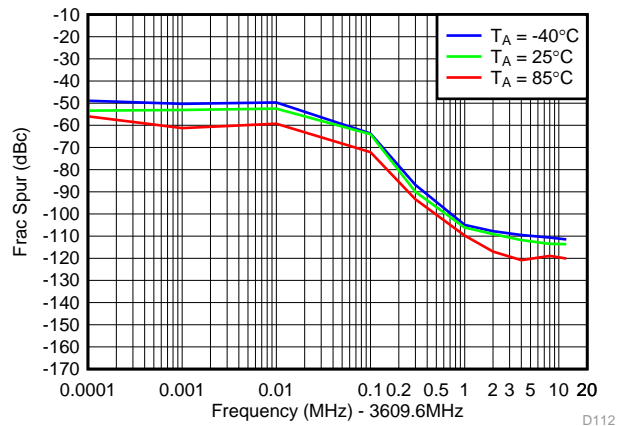

Figure 101. 3609.6 MHz Integer Boundary Spur vs Temperature

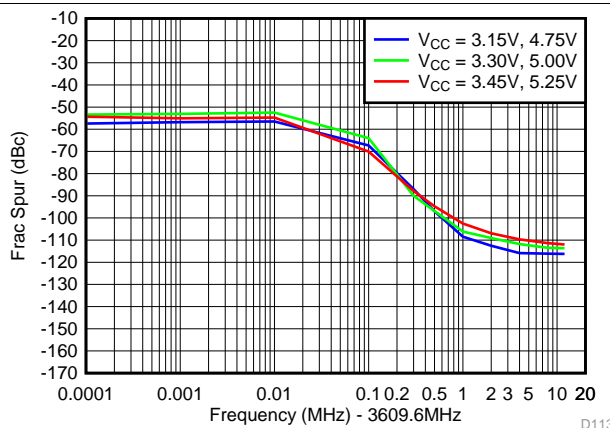

Figure 102. 3609.6 MHz Integer Boundary Spur vs Supply

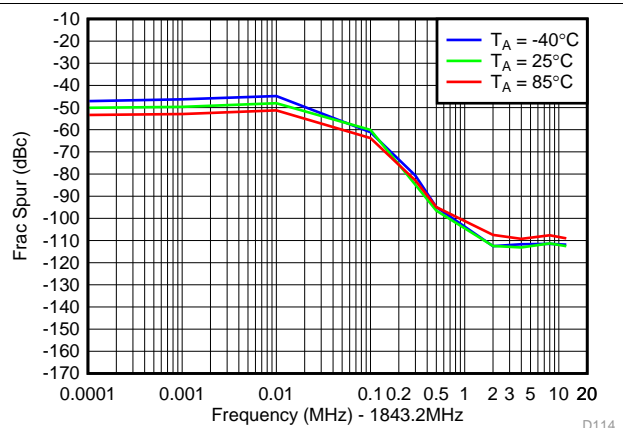

Figure 103. 1843.2 MHz Integer Boundary Spur vs Temperature

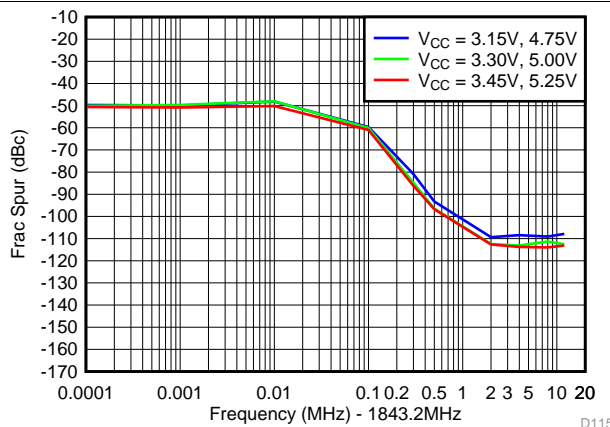

Figure 104. 1842.2 MHz Integer Boundary Spur vs Supply

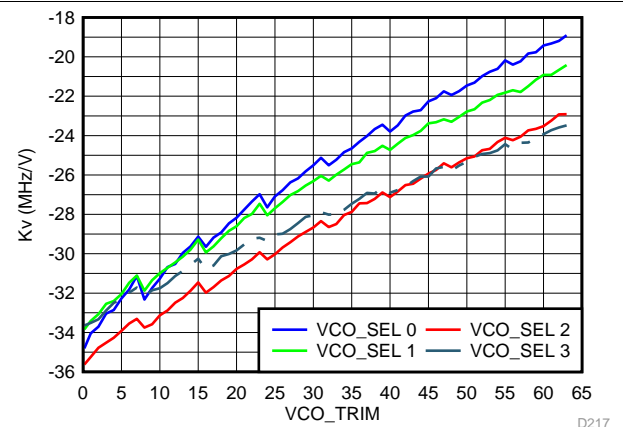

Figure 105. KVCO vs VCO Trim

### Typical Characteristics - PLL/VCO (continued)

Unless specified all plots were created using TRF3722EVM,  $V_{CC} = 3.3\text{ V}$ ,  $V_{CC\_TK} = 5\text{ V}$ , and  $T_A = 25^\circ\text{C}$ . Measured at LO\_OUTP with  $50\ \Omega$  bias resistor and  $47\text{ pF}$  series capacitor. Modulator section powered down. Reference frequency is set to  $61.44\text{ MHz}$ . Optimized bias settings as per Table 16.

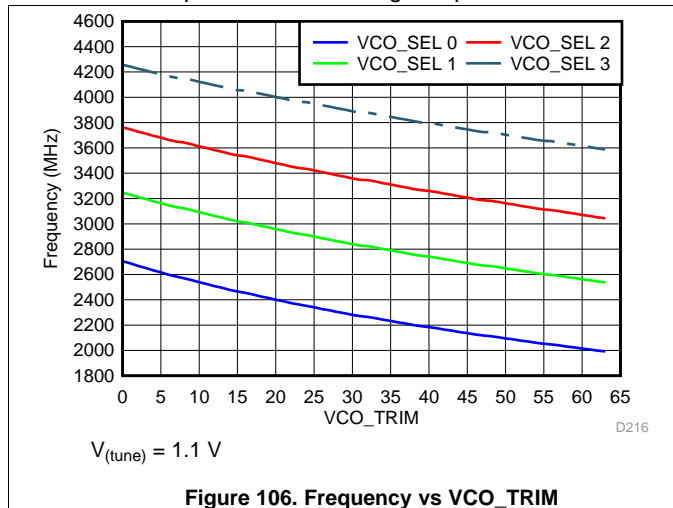

Figure 106. Frequency vs VCO\_TRIM

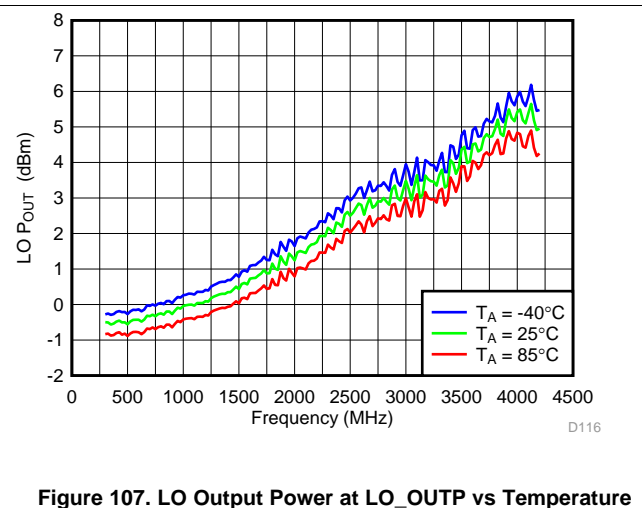

Figure 107. LO Output Power at LO\_OUTP vs Temperature

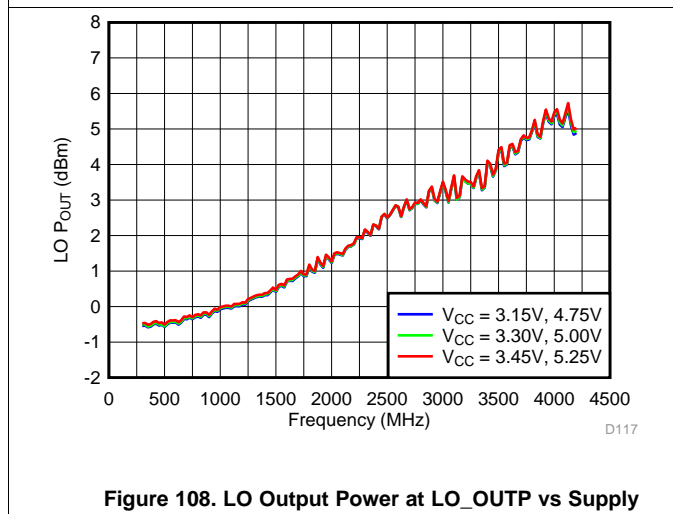

Figure 108. LO Output Power at LO\_OUTP vs Supply

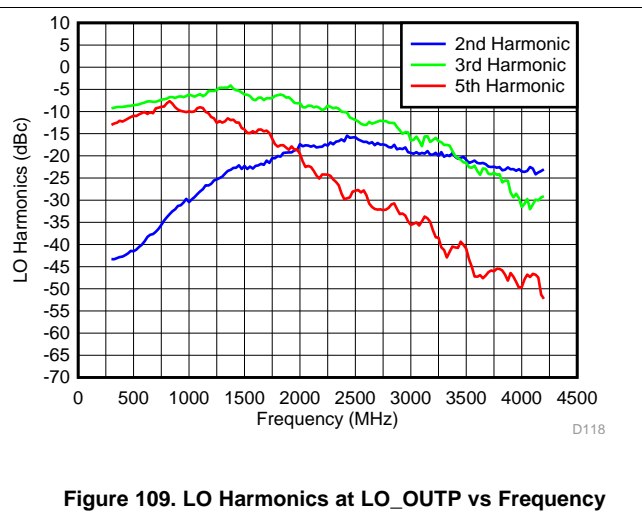

Figure 109. LO Harmonics at LO\_OUTP vs Frequency

### 6.19 Typical Characteristics - Current Consumption

Unless specified all plots were created using TRF3722EVM, VCC = 3.3 V, VCC\_TK = 5 V, and T<sub>A</sub> = 25°C. Optimized bias settings as per Table 16

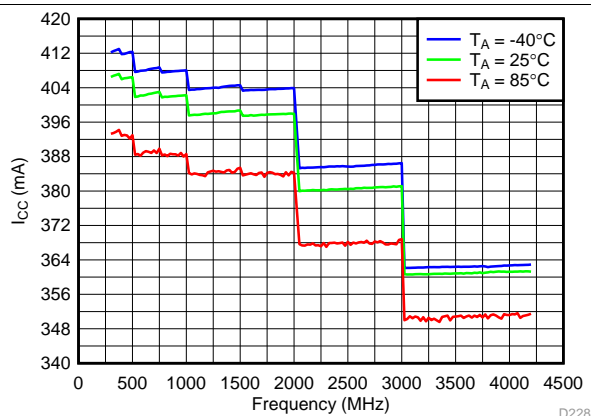

Figure 110. 3.3V Supply Current vs Temperature, Typical Operating Mode

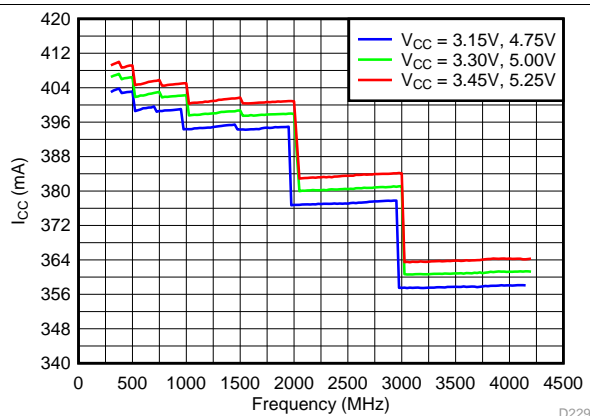

Figure 111. 3.3V Supply Current vs Supply, Typical Operating Mode

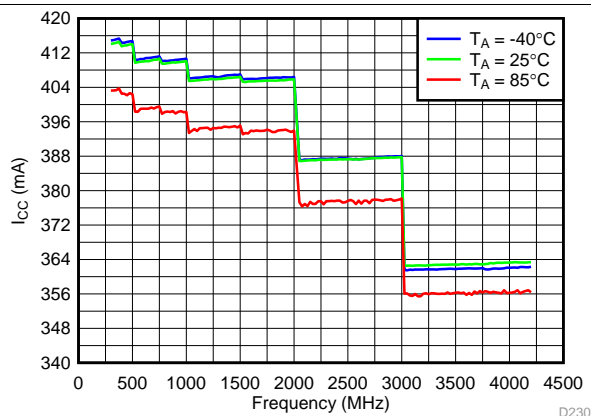

Figure 112. 3.3V Supply Current vs Temperature, High Gain Mode

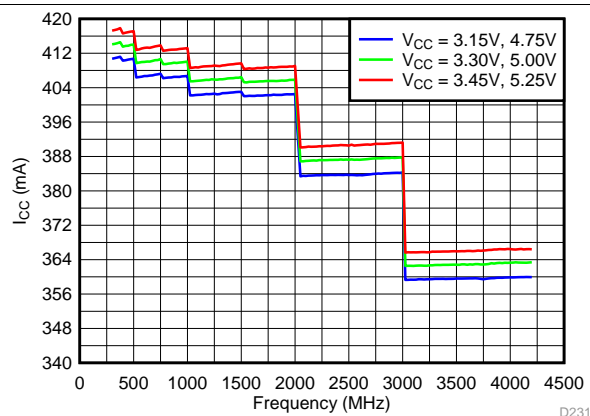

Figure 113. 3.3V Supply Current vs Supply, High Gain Mode

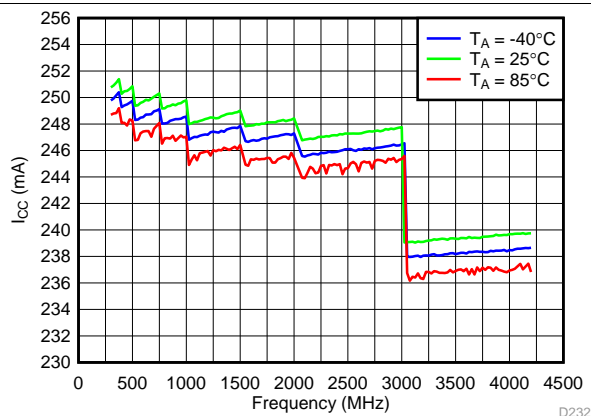

Figure 114. 3.3V Supply Current vs Temperature, Low Power Mode

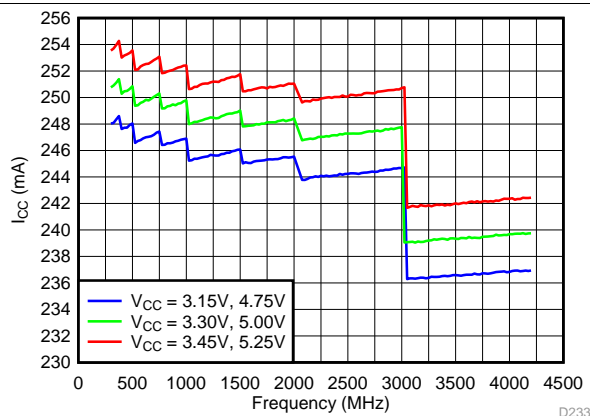
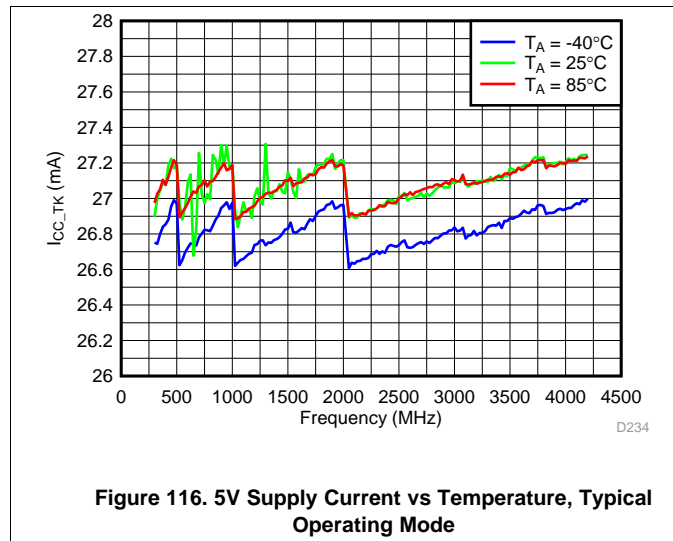
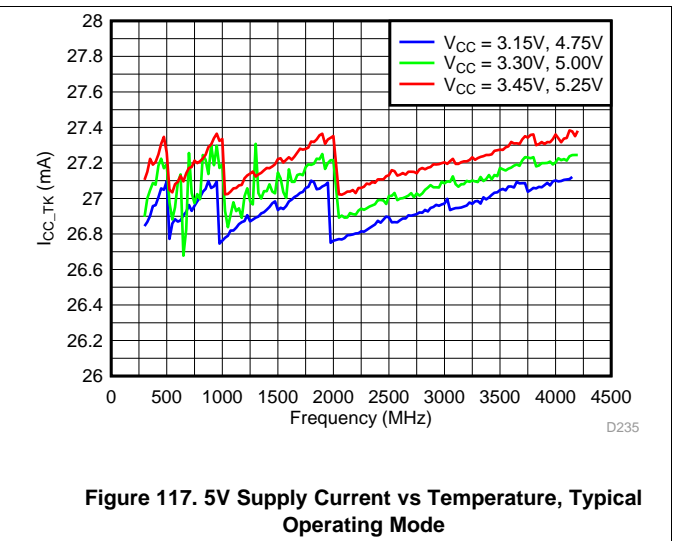

Figure 115. 5V Supply Current vs Supply, Low Power Mode

**Typical Characteristics - Current Consumption (continued)**



**Figure 116. 5V Supply Current vs Temperature, Typical Operating Mode**



**Figure 117. 5V Supply Current vs Temperature, Typical Operating Mode**

## 6.20 Typical Characteristics - Power Dissipation

Unless specified all plots were created using TRF3722EVM, VCC = 3.3 V, VCC\_TK = 5 V, and T<sub>A</sub> = 25°C. Optimized bias settings as per Table 16.

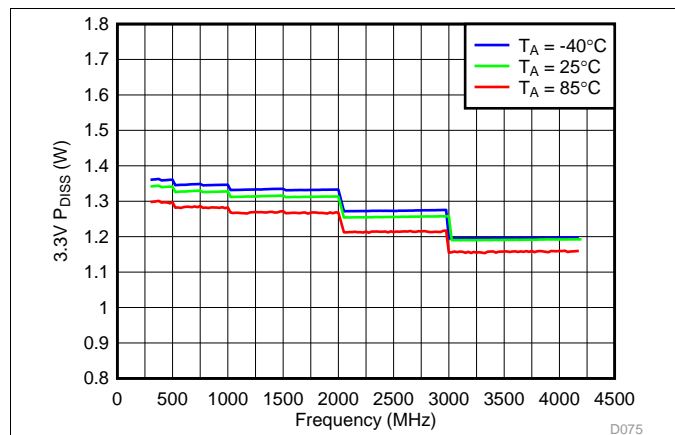

Figure 118. 3.3 V P<sub>DISS</sub> vs Temperature, Typical Operating Mode

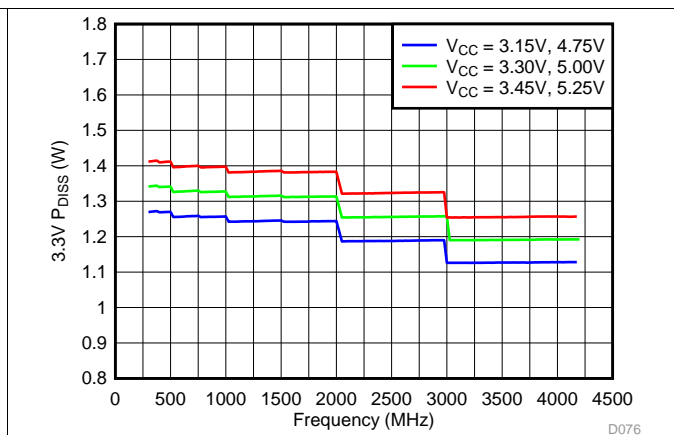

Figure 119. 3.3 V P<sub>DISS</sub> vs Supply, Typical Operating Mode

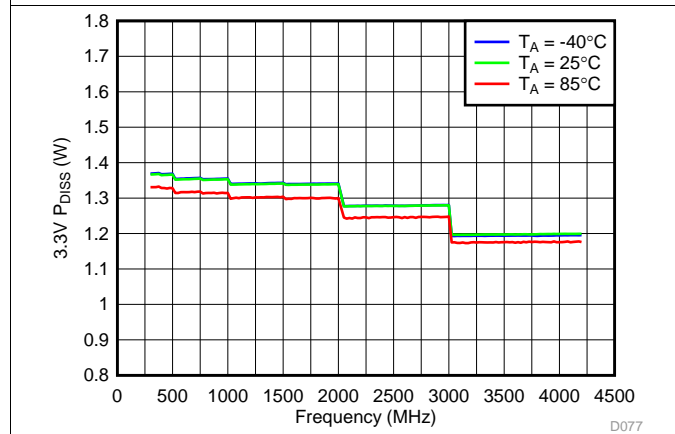

Figure 120. 3.3 V P<sub>DISS</sub> vs Temperature, High Gain Mode

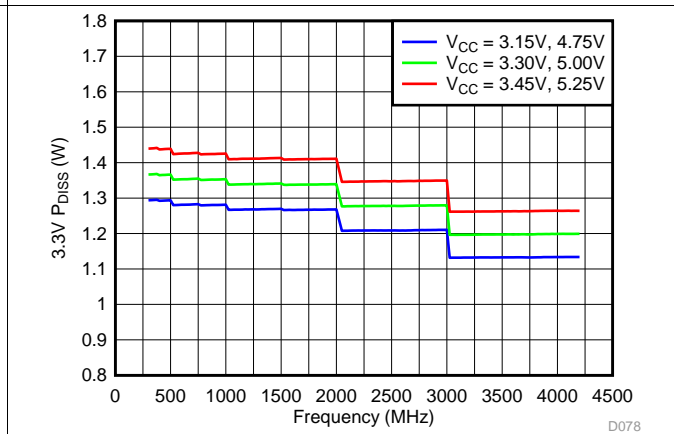

Figure 121. 3.3 V P<sub>DISS</sub> vs Supply, High Gain Mode

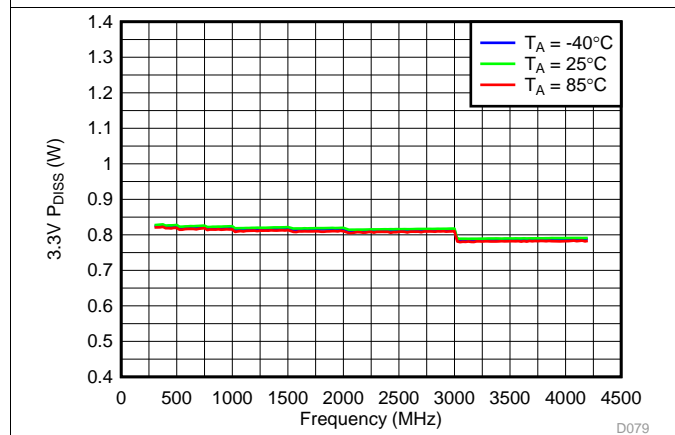

Figure 122. 3.3 V P<sub>DISS</sub> vs Temperature, Low Power Mode

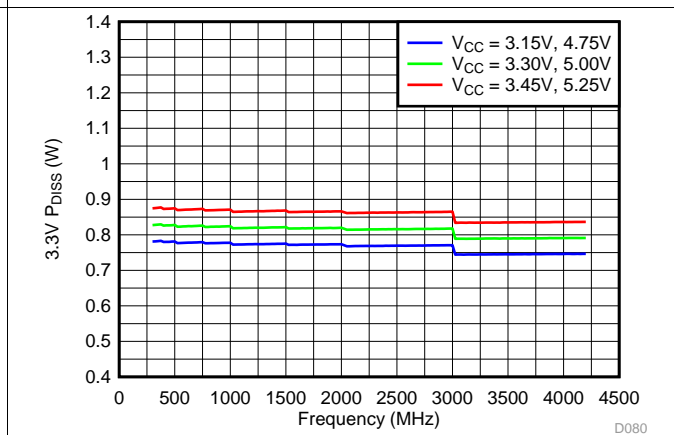

Figure 123. 3.3 V P<sub>DISS</sub> vs Supply, Low Power Mode

### Typical Characteristics - Power Dissipation (continued)

Unless specified all plots were created using TRF3722EVM, VCC = 3.3 V, VCC\_TK = 5 V, and T<sub>A</sub> = 25°C. Optimized bias settings as per Table 16.

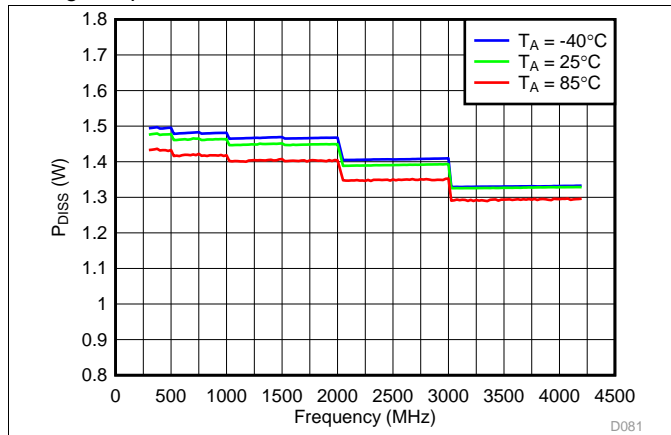

Figure 124. Total P<sub>DISS</sub> vs Temperature, Typical Operating Mode

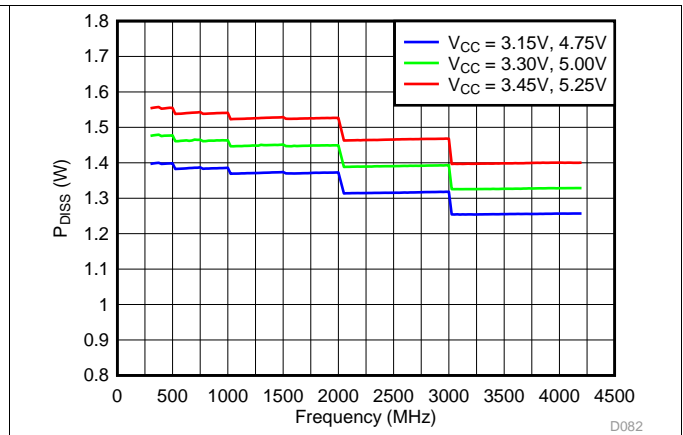

Figure 125. Total P<sub>DISS</sub> vs Supply, Typical Operating Mode

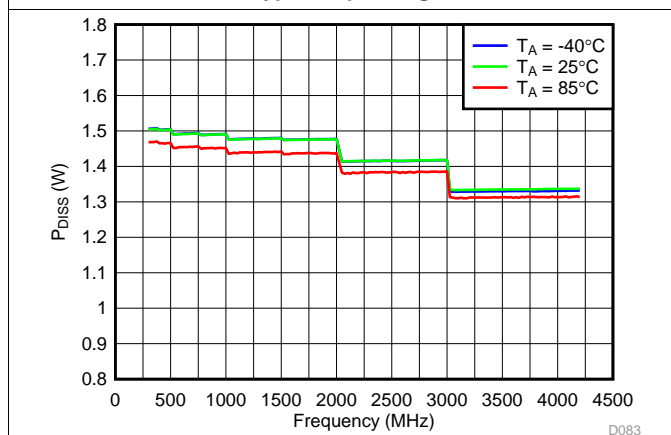

Figure 126. Total P<sub>DISS</sub> vs Temperature, High Gain Mode

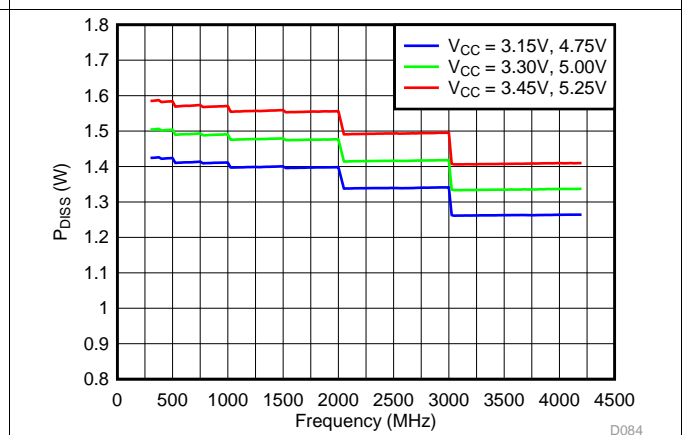

Figure 127. Total P<sub>DISS</sub> vs Supply, High Gain Mode

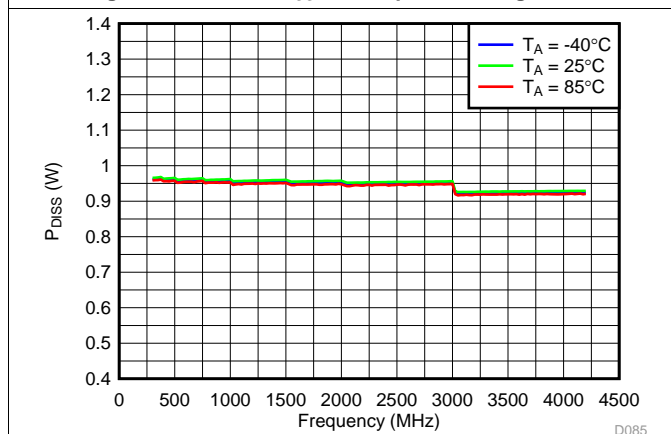

Figure 128. Total P<sub>DISS</sub> vs Temperature, Low Power Mode

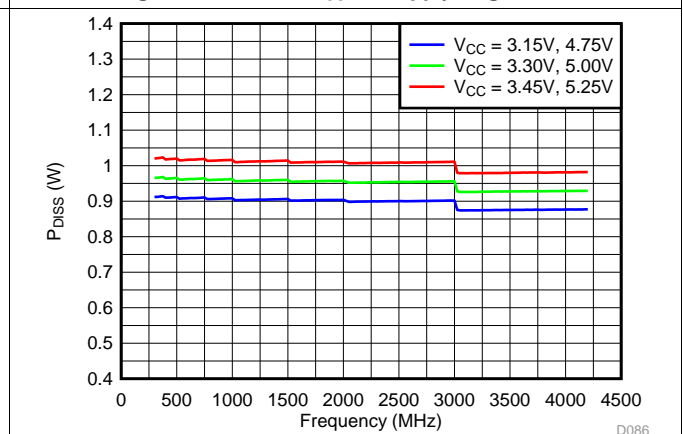

Figure 129. Total P<sub>DISS</sub> vs Supply, Low Power Mode



## 7 Parameter Measurement Information

### 7.1 Serial Interface Timing Diagram

The TRF3722 features a four-wire serial programming interface (4WI) that controls an internal 32-bit shift register with seven parallel registers. There are total of three signals that must be applied: the clock (CLK), the serial data (DATA), and the latch enable (LE). The fourth signal is the read back (RDBK) signal. The serial data (DB0-DB31) are loaded least significant bit (LSB) first, and read on the rising edge of the CLK. LE is asynchronous to the CLK signal; at its rising edge, the data in the shift register are loaded into the selected internal register. Figure 130 shows the timing diagram the 4WI. Table 1 lists the 4WI timing for the write operation.

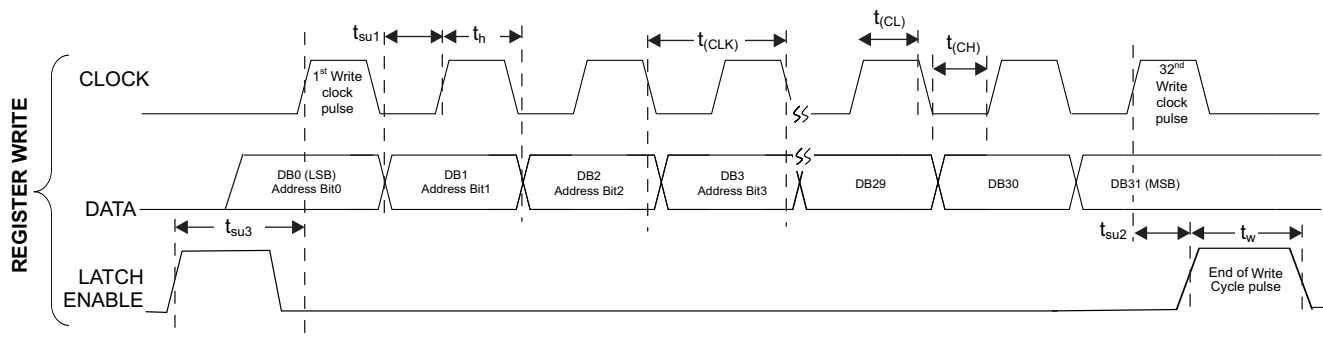

Figure 130. 4WI Writing Timing Diagram

Table 1. 4WI Timing for Write Operation

		MIN	TYP	MAX	UNIT
$t_h$	Hold time, data to clock	20			ns
$t_{su1}$	Setup time, data to clock	20			ns
$t_{CH}$	Clock low duration	20			ns
$t_{CL}$	Clock High duration	20			ns
$t_{su2}$	Setup time, clock to enable	20			ns
$t_{CLK}$	Clock period	50			ns
$t_w$	Enable Time	50			ns
$t_{su3}$	Setup time, Latch to Data	70			ns

TRF3722 integrates 7 registers: Register 0 (000) to Register 6 (110). Registers 1 through 6 are used to set-up and control the TRF3722 functionalities, while register 0 is used for the read-back function. Each read-back is composed by two phases: writing followed by the actual reading of the internal data. This is shown in the timing diagram in [Figure 131](#).

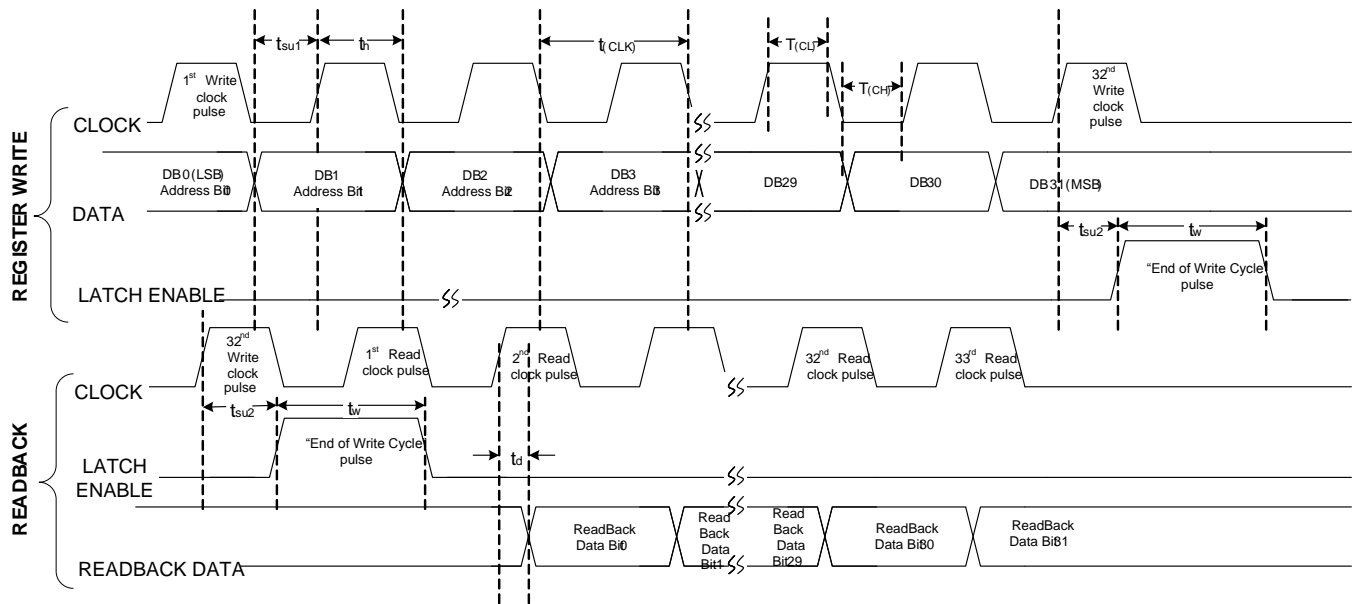

Figure 131. 4WI Read-Back Timing Diagram

During the writing phase a command is sent to TRF3722 register 0 to set it in read-back mode and to specify which register is to be read. In the proper reading phase, at each rising clock edge, the internal data is transferred into the RDBK pin and can be read at the following falling edge (LSB first). The first clock after the LE goes high (end of writing cycle) is idle and the following 32 clocks pulses will transfer the internal register content to the RDBK pin. [Table 2](#) shows the Readback timing.

Table 2. 4WI Timing for Readback Timing

		MIN	TYP	MAX	UNIT	COMMENT
$t_h$	Hold time, data to clock	20			ns	
$t_{su1}$	Setup time, data to clock	20			ns	
$t_{CH}$	Clock low duration	20			ns	
$t_{CL}$	Clock High duration	20			ns	
$t_{su2}$	Setup time, clock to enable	20			ns	
$t_{su3}$	Setup time, enable to Readback clock	20			ns	
$t_d$	Delay time, clock to Readback data output	10				
$t_w$	Enable Time	50			ns	Equals Clock period
$t_{(CLK)}$	Clock period	50			ns	

## 8 Detailed Description

### 8.1 Overview

TRF3722 integrates a high performance direct conversion quadrature modulator with exceptional linearity and low noise performance. The modulator which upconverts low frequency baseband signal to high frequency RF typically operates at 0.25 V common mode. It supports seamless interface with current source DACs. It also features high gain and low power operating modes. Additionally, TRF3722 integrates PLL and VCO to provide the local oscillator (LO) to the integrated modulator. The PLL and VCO provides excellent phase noise and extremely low spurious performance. The device also provides an LO output for driving another modulator or mixer. TRF3722 supports the use of an external VCO or LO signal.

### 8.2 Functional Block Diagram

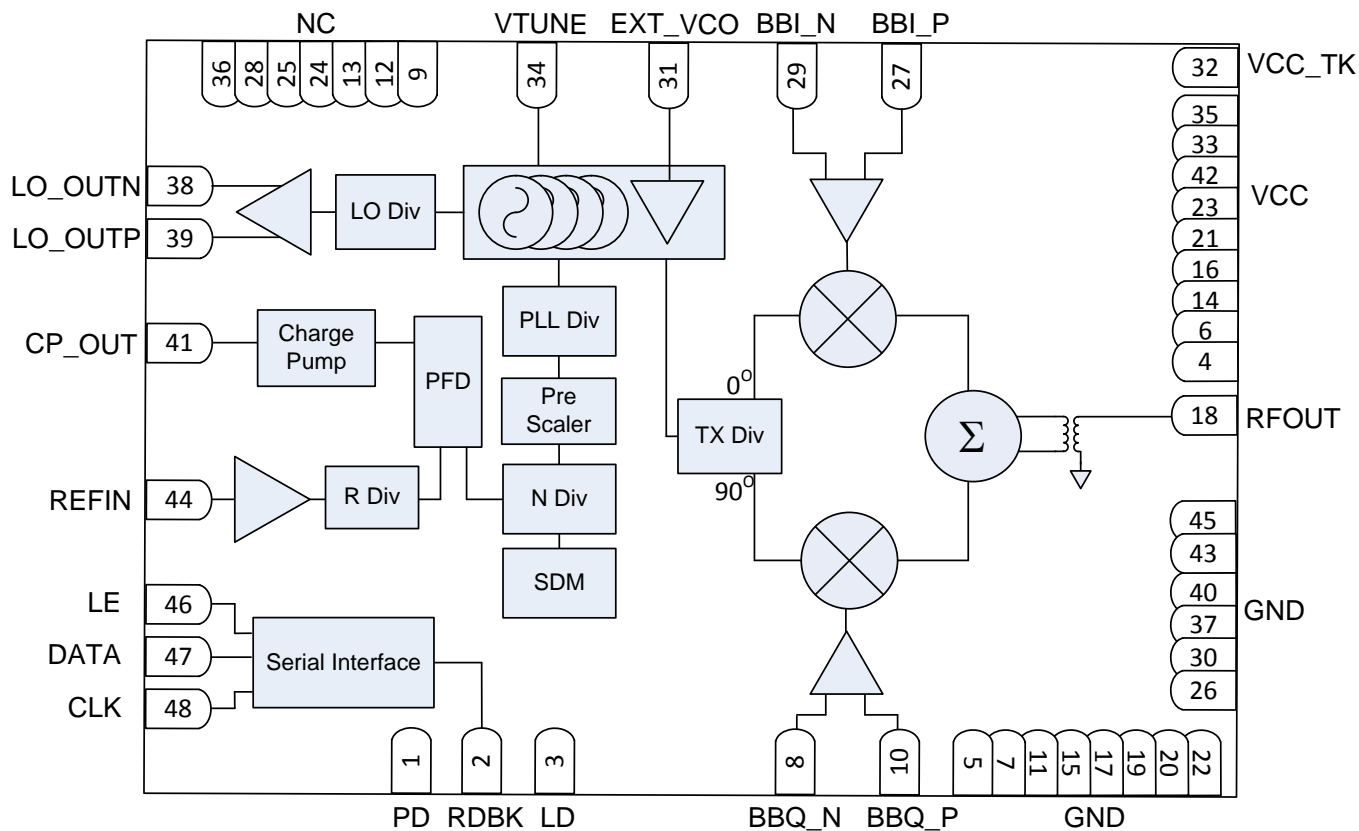

## 8.3 Feature Description

### 8.3.1 RF Output

The RF output is single ended and can drive a 50-Ω load. It can be tuned with the use of an output matching network to optimize the linearity and return loss performance within a selected band.

### 8.3.2 Baseband Inputs

The baseband inputs consist of the in-phase signal (I) and the quadrature-phase signals (Q). These I and Q signals are differential. The baseband lines are nominally biased at 0.25-V common-mode voltage ( $V_{CM}$ ); however, the device can operate with a  $V_{CM}$  in the range of 0 V to 0.5 V. The baseband input lines are normally terminated externally 50 Ω on TRF3722 evaluation board, though it is possible to modify this value if necessary to match to an external filter load impedance requirement.

### 8.3.3 LO Output

The LO outputs are open collector differential outputs and are biased externally. These differential outputs can be tuned to optimized output power along with OUTBUF\_BIAS register settings. It also is possible to use LO outputs in single ended mode.

### 8.3.4 PLL Architecture

Figure 132 illustrates a block diagram of the PLL architecture.

The VCO output frequency ( $f_{VCO}$ ) is given by Equation 1:

$$f_{VCO} = \frac{f_{REF}}{RDIV} \times PLL\ DIV \times \left( NINT + \frac{NFRAC}{2^{25}} \right) \quad (1)$$

$$f_{PFD} = \frac{f_{REF}}{RDIV} \quad (2)$$

$$PLL\ DIV = 2^{PLL\_DIV\_SEL} \quad (3)$$

$$f_{VCO} = f_{PFD} \times PLL\ DIV \times \left( NINT + \frac{NFRAC}{2^{25}} \right) \quad (4)$$

Where  $f_{REF}$  is the reference input frequency,  $RDIV$  is the reference divider division ratio and the phase - frequency detector frequency is  $f_{PFD}$ .  $PLL\_DIV\_SEL$  controls the division ratio of the programmable divider (PLL DIV) before the dual-modulus prescaler (DMP).  $NINT$  and  $NFRAC/2^{25}$  is the integer and fractional part of the fractional divider (N.f), respectively. In Integer mode, the fractional setting is ignored and Equation 5 is applied.

$$f_{VCO} = f_{PFD} \times PLL\ DIV \times NINT \quad (5)$$

The complete feedback divider block consists of a PLL DIV, DMP, and N.f. The prescaler can be programmed as either a 4/5 or an 8/9. N.f includes an  $A$  and  $M$  digital counters.

Feature Description (continued)

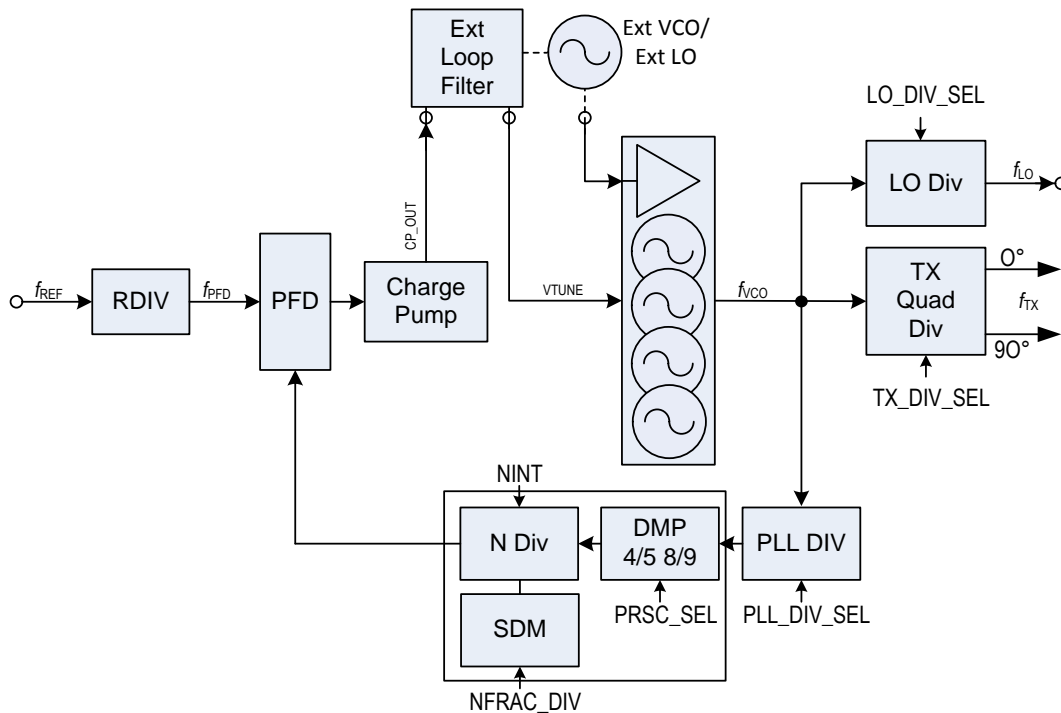

Figure 132. PLL Architecture

8.3.5 External VCO

An external LO or VCO signal may be applied. If an external LO is used the internal PLL can be powered down. Alternatively, dividers, phase-frequency detector, and charge pump can remain enabled and may be used to control the  $V_{TUNE}$  of an external VCO.  $EN\_EXTVCO$  is used to select the internal or external VCO.

8.3.6 Loop Filter

Loop filter design is critical for achieving low closed loop phase noise. Complete modulator performance data has been measured using integer mode loop filter. The integer mode loop filter was designed considering loop bandwidth 40 kHz and  $f_{PFD}$  2.56 MHz. Phase margin of 60 degrees was considered. Refer to TRF3722EVM User's Guide to obtain the details on TRF3722 loop component calculations. Figure 133 shows integer loop filter.

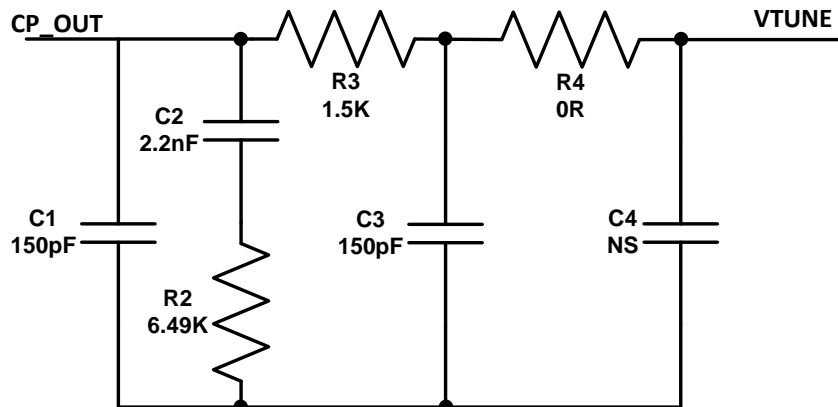
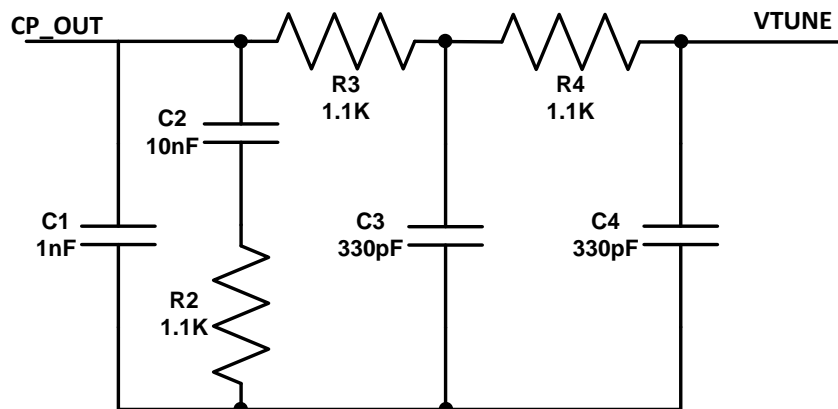

Figure 133. Integer Loop Filter

## Feature Description (continued)

Frac-N performance data is obtained using the fractional loop filter shown in Figure 134. 40 kHz loop bandwidth and 15.36 MHz PFD was considered.



**Figure 134. Fractional Loop Filter**

### 8.3.7 Lock Detect

The lock detect signal is generated in the phase frequency detector by comparing the two input signals. When the two compared phase signals remain aligned for several clock cycles, an internal signal goes high. The precision of this comparison is controlled through the LD\_ANA\_PREC bits. This internal signal is then averaged and compared against a reference voltage to generate the lock detect (LD) signal. The number of averages used is controlled through LD\_DIG\_PREC. Therefore, when the VCO is frequency locked, LD is high. When the VCO frequency is not locked, LD may pulse high or exhibit periodic behavior.

By default, the internal lock detect signal is made available on the LD terminal. Register bits MUX\_CTRL can be used to control a multiplexer to output other diagnostic signals on the LD output.

## 8.4 Device Functional Modes

### 8.4.1 Selecting PLL Divider Values

With reference to the PLL architecture illustrated in [Figure 132](#), operation of the PLL requires TX\_DIV\_SEL / LO\_DIV\_SEL, PLL\_DIV\_SEL, RDIV, NINT, NFRAC and PRSC\_SEL bits to be calculated.

#### a. TX\_DIV\_SEL / LO\_DIV\_SEL

The LO to the integrated modulator ( $f_{TX}$ ) and additional LO output ( $f_{LO}$ ) frequency is related to  $f_{VCO}$  according to the following:

$$f_{TX} = f_{VCO} / \text{TX DIV}$$

$$f_{LO} = f_{VCO} / \text{LO DIV}$$

Where TX DIV and LO DIV are related to TX\_DIV\_SEL and LO\_DIV\_SEL as:

TX_DIV_SEL / LO_DIV_SEL	TX_DIV / LO_DIV	FREQUENCY RANGE
TX_DIV_SEL = 0	TX DIV = 1	2050 MHz $\leq$ $f_{TX}$ $\leq$ 4100 MHz
TX_DIV_SEL = 1	TX DIV = 2	1025 MHz $\leq$ $f_{TX}$ $\leq$ 2050 MHz
TX_DIV_SEL = 2	TX DIV = 4	512.5 MHz $\leq$ $f_{TX}$ $\leq$ 1025 MHz
TX_DIV_SEL = 3	TX DIV = 8	256.25 MHz $\leq$ $f_{TX}$ $\leq$ 512.5 MHz
LO_DIV_SEL = 0	LO DIV = 1	2050 MHz $\leq$ $f_{LO}$ $\leq$ 4100 MHz
LO_DIV_SEL = 1	LO DIV = 2	1025 MHz $\leq$ $f_{LO}$ $\leq$ 2050 MHz
LO_DIV_SEL = 2	LO DIV = 4	512.5 MHz $\leq$ $f_{LO}$ $\leq$ 1025 MHz
LO_DIV_SEL = 3	LO DIV = 8	256.25 MHz $\leq$ $f_{LO}$ $\leq$ 512.5 MHz

#### b. PLL\_DIV\_SEL

Given  $f_{VCO}$ , select PLL\_DIV\_SEL so that the division ratio PLL DIV limits the input frequency to the prescaler,  $f_{DMP}$ , is limited to a maximum of 3000 MHz.

$$\text{PLL DIV} = \min(1, 2, 4) \text{ such that } f_{DMP} \leq 3000 \text{ MHz}$$

PLL DIV is related to PLL\_DIV\_SEL according to the following equation:

$$\text{PLL\_DIV} = 2^{\text{PLL\_DIV\_SEL}}$$

This calculation can be restated as [Equation 6](#).

$$\text{PLL DIV} = \text{Ceiling} \left( \frac{\text{LO DIV} \times f_{LO}}{3000 \text{ MHz}} \right) = \text{Ceiling} \left( \frac{\text{TX DIV} \times f_{TX}}{3000 \text{ MHz}} \right) \quad (6)$$

For both integer and fractional mode it is preferable to operate the  $f_{PFD}$  at the highest possible frequency determined by the required frequency step of the RFOUT or LO\_OUT. In Integer mode, select the maximum  $f_{PFD}$  according to [Equation 7](#).

$$f_{PFD} = \frac{f_{VCO, \text{Stepsize}}}{\text{PLL DIV}} = \frac{f_{TX, \text{Stepsize}} \times \text{TX DIV}}{\text{PLL DIV}} \quad (7)$$

In Fractional mode, small RF stepsize can be obtained through the fractional divider. In this case, the highest  $f_{PFD}$  frequency should be selected according to the reference clock and system requirements.

### c. RDIV, NINT, NFRAC, PRSC\_SEL

The remaining PLL parameters are calculated according to the following equations:

$$\text{RDIV} = \frac{f_{\text{REF}}}{f_{\text{PFD}}}$$

$$\text{NINT} = \text{floor} \left( \frac{f_{\text{VCO}} \times \text{RDIV}}{f_{\text{REF}} \times \text{PLL DIV}} \right)$$

$$\text{NFRAC} = \text{floor} \left( \left[ \left( \frac{f_{\text{VCO}} \times \text{RDIV}}{f_{\text{REF}} \times \text{PLL DIV}} \right) - \text{NINT} \right] \times 2^{25} \right)$$

The DMP division ratio (P/P+1) can be set to 4/5 or 8/9 through the PRSC\_SEL bit. To allow proper fractional operation, set PRSC\_SEL according to:

PRSC\_SEL = 0, (P/P+1) = 4/5 for 20 ≤ NINT < 72 in integer mode or 23 ≤ NINT < 75 in fractional mode.

PRSC\_SEL = 1, (P/P+1) = 8/9 for NINT ≥ 72 in integer mode or NINT ≥ 75 in fractional mode.

The PRSC\_SEL limit at NINT < 75 applies to Fractional mode with third-order modulation. In Integer mode, the PRSC\_SEL = 8/9 should be used with NINT as low as 72. The divider block accounts for either value of PRSC\_SEL without requiring NINT or NFRAC to be adjusted. Then, calculate the maximum input frequency (f<sub>N</sub>) to the digital divider. Use the lower of the possible prescaler divide settings, P = (4,8), as shown by [Equation 8](#).

$$f_{\text{N}} = \frac{f_{\text{VCO}}}{\text{PLL DIV} \times \text{P}} \quad (8)$$

Verify that the frequency into the digital divider, f<sub>N</sub>, is less than or equal to 375 MHz. If f<sub>N</sub> exceeds 375 MHz, choose a larger value for PLL\_DIV\_SEL and recalculate f<sub>PFD</sub>, RDIV, NINT, NFRAC, and PRSC\_SEL.

#### 8.4.2 Setup Example for Integer Mode

Suppose the following operating characteristics fractional example are desired for Integer mode operation:

- f<sub>REF</sub> = 61.44 MHz (reference input frequency)
- Step at RF = 2.56 MHz (RF channel spacing)
- f<sub>RF</sub> = 1799.68 MHz (RF frequency)

The VCO range is 2050 MHz to 4100 MHz. Therefore:

- LO DIV = 2 (LO\_DIV\_SEL = 1)
- f<sub>VCO</sub> = LO DIV × 1799.68 MHz = 3599.36 MHz

In order to keep the frequency of the prescaler below 3000 MHz:

- PLL\_DIV = 2 (PLL\_DIV\_SEL = 1)

The desired stepsize at RF is 2.56 MHz, so:

- f<sub>PFD</sub> = 2.56 MHz
- f<sub>VCO</sub>, stepsize = PLL\_DIV × f<sub>PFD</sub> = 5.12 MHz

Using the reference frequency along with the required f<sub>PFD</sub> gives:

- RDIV = 24
- NINT = 703

NINT ≥ 75; therefore, select the 8/9 prescaler.

$$f_{\text{N}} = 3599.36 \text{ MHz} / (2 \times 8) = 224.96 \text{ MHz} < 375 \text{ MHz}$$

This example shows that Integer mode operation gives sufficient resolution for the required stepsize.

#### 8.4.3 Integer and Fractional Mode Selection

The PLL is designed to operate in either Integer mode or Fractional mode. If the desired local oscillator (LO) frequency is an integer multiple of f<sub>PFD</sub>, then select integer mode otherwise select fractional mode. In Integer mode, the feedback divider ratio is an integer, and the fraction is zero. Thus, bits corresponding to the fractional control in integer mode are *don't care* and fractional divider functionality is disabled.



In Fractional mode, the accuracy of the final frequency is set by 25-bit resolution. The RF stepsize is  $f_{\text{PFD}}/2^{25}$  which is less than 1 Hz for  $f_{\text{PFD}}$  up to 33 MHz. The appropriate fractional control bits in the serial register must be programmed. Optimal performance may require tuning the MOD\_ORD, ISOURCE\_SINK, and ISOURCE\_TRIM values according to the chosen frequency band.

#### 8.4.4 Selecting the VCO and VCO Frequency Control

To achieve a broad frequency tuning range, the TRF3722 integrates multiple VCOs. Each VCO tank uses a bank of coarse tuning capacitor to bring VCO frequency within a few MHz of the desired value. For a given LO frequency an appropriate VCO and capacitor array must be selected. The device integrates logic that automatically selects an appropriate VCO and capacitor array, such that in closed loop  $V_{(\text{TUNE})}$  is approximately equal to the open loop calibration reference voltage set by VCO\_CAL\_REF. An on-chip temperature sensor automatically adjusts this reference voltage so that proper lock can be maintained over the temperature range.

The calibration logic is driven by a CAL\_CLK signal which is scaled version of the reference frequency according to CAL\_CLK\_SEL. For optimum accuracy It is recommended to limit the CAL\_CLK frequency to 600 kHz.

When VCO\_SEL\_MODE is '0', the device automatically selects the VCO and the capacitor array. When VCO\_SEL\_MODE is '1', the VCO selected by VCO\_SEL is used and the logic automatically selects the capacitor array. The VCO and capacitor array settings resulting from the calibration can be read from Register 0 - read back register.

Automatic calibration can be disabled by setting CAL\_BYPASS to '1'. In this manual calibration mode, the VCO is selected through register bits VCO\_SEL, while the capacitor array is selected through register bits VCO\_TRIM. Calibration modes are summarized in [Table 3](#).

**Table 3. VCO Calibration Modes**

CAL_BYPASS	VCO_SEL_MODE	MAX CYCLES CAL_CLK	VCO	CAPACITOR ARRAY
0	0	46	Automatic	
0	1	34	VCO_SEL	Automatic
1	<i>don't care</i>	N/A	VCO_SEL	VCO_TRIM

## 8.5 Register Maps

**Table 4. Serial interface Register Summary**

Bit	Register 1	Register 2	Register 3	Register 4	Register 5	Register 6
Bit0	Register Address	Register Address	Register Address	Register Address	Register Address	Register Address
Bit1						
Bit2						
Bit3						
Bit4						
Bit5	RDIV	NINT	NFRAC	PWD_PLL	RSV	RSV
Bit6				PWD_CP	IB_MOD_GM	
Bit7				PWD_VCO	IB_MOD_LO	VCO_TRIM
Bit8				PWD_VCO_MUX		
Bit9				PWD_DIV124		
Bit10				PWD_PRESC	VCO_BIAS	
Bit11				RSV		
Bit12				PWD_OUTBUF		
Bit13				PWD_LO_DIV	VCOBUF_BIAS	
Bit14				PWD_TX_DIV		VCO_TEST_MODE
Bit15				PWD_MOD	VCOMUX_BIAS	CAL_BYPASS
Bit16				EN_EXTVCO	VCOMUX_BIAS	MUX_CTRL
Bit17				RSV		
Bit18				RSV	OUTBUF_BIAS	ISOURCE_SINKB
Bit19				REF_INV		
Bit20				NEG_VCO	PLL_DIV_SEL	ISOURCE_TRIM
Bit21				ICP		
Bit22	PRSC_SEL					
Bit23	RSV					
Bit24	SPEEDUP					
Bit25	LD_DIG_PREC	VCO_CAL_REF	LO_DIV_SEL			
Bit26	ICPDOUBLE	VCO_SEL	VCO_AMPL_CTRL	LO_DIV_BIAS		
Bit27	CAL_CLK_SEL	VCO_SEL_MODE	VCO_VB_CTRL	TX_DIV_SEL		
Bit28		CAL_ACC		TX_DIV_BIAS		
Bit29		RSV	EN_FRAC_MODE	EN_LD_ISOURCE	GAIN_CTRL	
Bit30	RSV	EN_CAL	RSV	EN_FRAC_MODE	EN_LD_ISOURCE	GAIN_CTRL
Bit31						

### 8.5.1 Serial interface Register Definition

**Table 5. Register 1**

Register 1	Bit Name	Reset Value	Description
Bit0	ADDR<0>	1	Register Address Bits
Bit1	ADDR<1>	0	
Bit2	ADDR<2>	0	
Bit3	ADDR<3>	1	
Bit4	ADDR<4>	0	
Bit5	RDIV<0>	1	13-bit Reference Divider Value (Rmin = 1, Rmax = 8191)
Bit6	RDIV<1>	0	
Bit7	RDIV<2>	0	
Bit8	RDIV<3>	0	
Bit9	RDIV<4>	0	
Bit10	RDIV<5>	0	
Bit11	RDIV<6>	0	
Bit12	RDIV<7>	0	
Bit13	RDIV<8>	0	
Bit14	RDIV<9>	0	
Bit15	RDIV<10>	0	
Bit16	RDIV<11>	0	
Bit17	RDIV<12>	0	
Bit18	RSV	0	Reserved
Bit19	REF_INV	0	Invert Reference Clock Polarity; 1 = use falling edge
Bit20	NEG_VCO	1	VCO polarity control; 1 = negative slope (negative Kv)
Bit21	ICP<0>	0	Program charge pump DC current: [00000] = 1.94 mA [11111] = 0.47 mA [01010] = 0.97 mA
Bit22	ICP<1>	1	
Bit23	ICP<2>	0	
Bit24	ICP<3>	1	
Bit25	ICP<4>	0	
Bit26	ICPDOUBLE	0	1 = Set ICP to double the current
Bit27	CAL_CLK_SEL<0>	0	Multiplication or division factor to create VCO calibration clock from the PFD frequency: [0000] = Fastest ( Rdiv / 128) [1111] = Slowest (Rdiv x 128), [1000] = Default (1x Rdiv)
Bit28	CAL_CLK_SEL<1>	0	
Bit29	CAL_CLK_SEL<2>	0	
Bit30	CAL_CLK_SEL<3>	1	
Bit31	RSV	0	Reserved

CAL\_CLK\_SEL[3..0]: Set the frequency divider value used to derive the VCO calibration clock from the reference frequency.

**Table 6. CAL\_CLK\_SEL Scaling Factor Setting**

CAL_CLK_SEL	Scaling Factor	CAL_CLK_SEL	Scaling Factor
1111	1/128	0111	NA
1110	1/64	0110	2
1101	1/32	0101	4
1100	1/16	0100	8
1011	1/8	0011	16
1010	1/4	0010	32
1001	1/2	0001	64
1000	1	0000	128

ICP[4..0]: Set the charge pump current.

**Table 7. Charge Pump Current Set-Point**

ICP[4..0]	Current (mA)	ICP[4..0]	Current (mA)
00 000	1.94	10 000	0.75
00 001	1.76	10 001	0.72
00 010	1.62	10 010	0.69
00 011	1.49	10 011	0.67
00 100	1.38	10 100	0.65
00 101	1.29	10 101	0.63
00 110	1.21	10 110	0.61
00 111	1.14	10 111	0.59
01 000	1.08	11 000	0.57
01 001	1.02	11 001	0.55
01 010	0.97	11 010	0.54
01 011	0.92	11 011	0.52
01 100	0.88	11 100	0.51
01 101	0.84	11 101	0.50
01 110	0.81	11 110	0.48
01 111	0.78	11 111	0.47

**Table 8. Register 2**

Register 2	Bit Name	Reset Value	Description
Bit0	ADDR<0>	0	Register Address Bits
Bit1	ADDR<1>	1	
Bit2	ADDR<2>	0	
Bit3	ADDR<3>	1	
Bit4	ADDR<4>	0	
Bit5	NINT<0>	0	PLL N-Divider Value
Bit6	NINT<1>	0	
Bit7	NINT<2>	0	
Bit8	NINT<3>	0	
Bit9	NINT<4>	0	
Bit10	NINT<5>	0	
Bit11	NINT<6>	0	
Bit12	NINT<7>	1	
Bit13	NINT<8>	0	
Bit14	NINT<9>	0	
Bit15	NINT<10>	0	
Bit16	NINT<11>	0	
Bit17	NINT<12>	0	
Bit18	NINT<13>	0	
Bit19	NINT<14>	0	
Bit20	NINT<15>	0	
Bit21	PLL_DIV_SEL<0>	1	Select division ratio of divider in front of prescaler [00] = 1X, [01] = div2, [10] = div4
Bit22	PLL_DIV_SEL<1>	0	
Bit23	PRSC_SEL	1	Select precaler modulus: [0] = 4/5, [1] =8/9
Bit24	RSV	0	Reserved
Bit25	RSV	0	
Bit26	VCO_SEL<0>	0	Selects between the four integrated VCOs [00] = lowest frequency, [11] = highest frequency
Bit27	VCO_SEL<1>	1	
Bit28	VCO_SEL_MODE	0	Single VCO auto-calibration mode: [1] = active
Bit29	CAL_ACC<0>	0	Error count during the cap array calibration [00] = 0, [01] = 1/32, [10] = 1/64, [11] =1/128)
Bit30	CAL_ACC<1>	0	
Bit31	EN_CAL	0	Initiate VCO auto-calibration, resets automatically

**Table 9. Register 3**

Register 3	Bit Name	Reset Value	Description
Bit0	ADDR<0>	1	Register Address Bits
Bit1	ADDR<1>	1	
Bit2	ADDR<2>	0	
Bit3	ADDR<3>	1	
Bit4	ADDR<4>	0	
Bit5	NFRAC<0>	0	Fractional PLL N-Divider 0 to 0.99999 in fractional mode
Bit6	NFRAC<1>	0	
Bit7	NFRAC<2>	0	
Bit8	NFRAC<3>	0	
Bit9	NFRAC<4>	0	
Bit10	NFRAC<5>	0	
Bit11	NFRAC<6>	0	
Bit12	NFRAC<7>	0	
Bit13	NFRAC<8>	0	
Bit14	NFRAC<9>	0	
Bit15	NFRAC<10>	0	
Bit16	NFRAC<11>	0	
Bit17	NFRAC<12>	0	
Bit18	NFRAC<13>	0	
Bit19	NFRAC<14>	0	
Bit20	NFRAC<15>	0	
Bit21	NFRAC<16>	0	
Bit22	NFRAC<17>	0	
Bit23	NFRAC<18>	0	
Bit24	NFRAC<19>	0	
Bit25	NFRAC<20>	0	
Bit26	NFRAC<21>	0	
Bit27	NFRAC<22>	0	
Bit28	NFRAC<23>	0	
Bit29	NFRAC<24>	0	
Bit30	RSV	0	Reserved
Bit31	RSV	0	

**Table 10. Register 4**

Register 4	Bit Name	Reset Value	Description
Bit0	ADDR<0>	0	Register Address Bits
Bit1	ADDR<1>	0	
Bit2	ADDR<2>	1	
Bit3	ADDR<3>	1	
Bit4	ADDR<4>	0	
Bit5	PWD_PLL	0	Power -down all PLL blocks: (1 = off)
Bit6	PWD_CP	0	Power-down Charge Pump: (1=off)
Bit7	PWD_VCO	0	Power-down VCO: (1=off)
Bit8	PWD_VCO_MUX	0	Power-down VCO Mux blocks: (1=off)
Bit9	PWD_DIV124	0	Power-down the div 1,2,4 in the PLL f/b path: (1=off)
Bit10	PWD_PRESC	0	Power-down Prescaler: (1=off)
Bit11	RSV	1	Reserved
Bit12	PWD_OUTBUF	1	Power-down Ouput Buffer: (1=off)
Bit13	PWD_LO_DIV	1	Power-down LO divider block: (1=off)
Bit14	PWD_TX_DIV	1	Power-down TX divider block: (1=off)
Bit15	PWD_MOD	1	Power-down modulator block: (1=off)
Bit16	EN_EXTVCO	0	Enable external VCO input buffer: (1 = enabled)
Bit17	RSV	0	Reserved
Bit18	EN_ISOURCE	0	Enable offset current at CP output (frac-n mode only).
Bit19	LD_ANA_PREC<0>	0	Control precision of Analog Lock Detector: [00] = H/H (High), [01] = L/L (Low), [10] = H/L , [11] = L/L
Bit20	LD_ANA_PREC<1>	0	
Bit21	CP_TRISTATE<0>	0	Set the charge pump output in Tristate mode: [00] = Off, [01] = Down, [10] = Up, [11] = Tristate
Bit22	CP_TRISTATE<1>	0	
Bit23	SPEEDUP	0	Enable fast turn on/off time of bias blocks.
Bit24	LD_DIG_PREC	0	Lock detector precision (increases sampling time if set to 1)
Bit25	MOD_ORD<0>	1	Modulator order (1-4). Not used in integer mode (default 3rd order + dither)
Bit26	MOD_ORD<1>	0	
Bit27	MOD_ORD<2>	1	
Bit28	DITH_SEL	0	Dither Mode: [0] = pseudo-random, [1] = constant
Bit29	DEL_SD_CLK<0>	0	DS modulator clock delay. Frac-n mode only. [00] = Min delay, [11] = max delay
Bit30	DEL_SD_CLK<1>	1	
Bit31	EN_FRAC_MODE	0	Enable Frac-n mode when set to 1

**Table 11. Register 5**

Register 5	Bit Name	Reset Value	Description
Bit0	ADDR<0>	1	Register Address Bits
Bit1	ADDR<1>	0	
Bit2	ADDR<2>	1	
Bit3	ADDR<3>	1	
Bit4	ADDR<4>	0	
Bit5	RSV	0	Reserved
Bit6	IB_MOD_GM<0>	0	Adjust modulator bias current gm
Bit7	IB_MOD_GM<1>	1	
Bit8	IB_MOD_LO<0>	0	Adjust modulator BB and LO bias current
Bit9	IB_MOD_LO<1>	1	
Bit10	VCO_BIAS<0>	0	Adjust VCO bias reference current
Bit11	VCO_BIAS<1>	0	
Bit12	VCO_BIAS<2>	0	
Bit13	VCO_BIAS<3>	1	
Bit14	VCOBUF_BIAS<0>	0	Adjust VCO buffer reference current
Bit15	VCOBUF_BIAS<1>	1	
Bit16	VCOMUX_BIAS<0>	0	Adjust VCO Mux reference current
Bit17	VCOMUX_BIAS<1>	1	
Bit18	OUTBUF_BIAS<0>	0	Adjust output buffer current
Bit19	OUTBUF_BIAS<1>	1	
Bit20	RSV	0	Reserved
Bit21	RSV	1	
Bit22	VCO_CAL_IB	0	Bias current for CAL reference voltage: [0] = PTAT, [1] = Constant
Bit23	VCO_CAL_REF<0>	0	VCO calibration reference voltage adjustment [000] = 0.9 V, [111] = 1.4 V [011] = recommended = 1.11 V
Bit24	VCO_CAL_REF<1>	0	
Bit25	VCO_CAL_REF<2>	1	
Bit26	VCO_AMPL_CTRL<0>	0	Adjusts the signal level at the VCO_MUX input: [00] =max, [11] = min
Bit27	VCO_AMPL_CTRL<1>	1	
Bit28	VCO_VB_CTRL<0>	0	Adjusts the VCO core bias voltage: [00] = 1.2 V, [01] = 1.35 V, [10] = 1.5 V, [11] = 1.65 V
Bit29	VCO_VB_CTRL<1>	1	
Bit30	RSV	0	Reserved
Bit31	EN_LD_MON_ISOURCE	1	Enable monitoring of LD to turn on Isource; recommend [0] = Isource ctrl



**Table 12. Register 6**

Register 6	Bit Name	Reset Value	Description
Bit0	ADDR<0>	0	Register Address Bits
Bit1	ADDR<1>	1	
Bit2	ADDR<2>	1	
Bit3	ADDR<3>	1	
Bit4	ADDR<4>	0	
Bit5	RSV	0	Reserved
Bit6	RSV	0	
Bit7	VCO_TRIM<0>	0	VCO capacitor array control bits; used in manual cal mode
Bit8	VCO_TRIM<1>	0	
Bit9	VCO_TRIM<2>	0	
Bit10	VCO_TRIM<3>	0	
Bit11	VCO_TRIM<4>	0	
Bit12	VCO_TRIM<5>	1	
Bit13	EN_LOCKDET	0	Enable monitor of lock detector output for autocal mode
Bit14	VCO_TEST_MODE	0	Counter mode, measure max and min freq for each VCO
Bit15	CAL_BYPASS	0	Bypass auto-cal; sets VCO_SEL and VCO_TRIM from Serial interface
Bit16	MUX_CTRL<0>	1	Select signal for test output: [001] = LD, [010] = NDIV, [100] = RDIV, [110] = A_counter
Bit17	MUX_CTRL<1>	0	
Bit18	MUX_CTRL<2>	0	
Bit19	ISOURCE_SINKB	0	Offset current polarity
Bit20	ISOURCE_TRIM<0>	0	Adjust Isource bias current in frac-n mode.
Bit21	ISOURCE_TRIM<1>	0	
Bit22	ISOURCE_TRIM<2>	1	
Bit23	LO_DIV_SEL<0>	0	Adjust LO path divider: [00] = Div/1, [01] = Div/2, [10] = Div/4. [11] = Div/8
Bit24	LO_DIV_SEL<1>	0	
Bit25	LO_DIV_BIAS<0>	0	Adjust LO divider bias current: [00] = 25 uA, [01] = 37.5 uA, [10] = 50 uA, [11] = 62.5 uA
Bit26	LO_DIV_BIAS<1>	1	
Bit27	TX_DIV_SEL<0>	0	Adjust TX path divider.
Bit28	TX_DIV_SEL<1>	1	[00] = Div/1, [01] = Div/2, [10] = Div/4. [11] = Div/8
Bit29	TX_DIV_BIAS<0>	0	Adjust TX divider bias current: [00] = 25 uA, [01] = 37.5 uA, [10] = 50 uA, [11] = 62.5 uA
Bit30	TX_DIV_BIAS<1>	1	
Bit31	GAIN_CTRL	0	Modulator gain control: [0] = Default, [1] = High Gain

**Table 13. READBACK Mode Summary Serial interface Map**

Bit	Register 0		RDBK			
Bit0	Register Address		Register Address			
Bit1						
Bit2						
Bit3						
Bit4						
Bit5	CHIP_ID		N/C			
Bit6	NU					
Bit7						
Bit8						
Bit9						
Bit10						
Bit11	R_SAT_ERR					
Bit12	COUNT			N/C		
Bit13					VCO_TRIM	
Bit14						
Bit15						
Bit16						
Bit17						
Bit18			VCO_SEL			
Bit19						
Bit20						
Bit21						
Bit22						
Bit23	MUX_COUNT		MUX_COUNT			
Bit24						
Bit25						
Bit26						
Bit27						
Bit28	RB_REG		RB_REG			
Bit29						
Bit30						
Bit31	MUX_COUNT		RB_ENABLE			

**Table 14. Register 0 (Readback Only)**

Register 0	Bit Name	Reset Value	Description
Bit0	ADDR<0>	0	Register Address Bits
Bit1	ADDR<1>	0	
Bit2	ADDR<2>	0	
Bit3	ADDR<3>	1	
Bit4	ADDR<4>	0	
Bit5	CHIP_ID<0>	1	Chip ID
Bit6	CHIP_ID<1>	0	
Bit7	NU	x	Not Used
Bit8	NU	x	
Bit9	NU	x	
Bit10	NU	x	
Bit11	NU	x	
Bit12	R_SAT_ERR	x	R-div saturation error for cal
Bit13	COUNT<0>/NU	x	VCO frequency counter high when MUX_COUNT = 0 and VCO_TEST_MODE = 1 VCO frequency counter low when MUX_COUNT = 1 and VCO_TEST_MODE = 1 Autocal results for VCO_TRIM and VCO_SEL when VCO_TEST_MODE = 0
Bit14	COUNT<1>/NU	x	
Bit15	COUNT<2>/VCO_TRIM<0>	x	
Bit16	COUNT<3>/VCO_TRIM<1>	x	
Bit17	COUNT<4>/VCO_TRIM<2>	x	
Bit18	COUNT<5>/VCO_TRIM<3>	x	
Bit19	COUNT<6>/VCO_TRIM<4>	x	
Bit20	COUNT<7>/VCO_TRIM<5>	x	
Bit21	COUNT<8>/VCO_SEL<0>	x	
Bit22	COUNT<9>/VCO_SEL<1>	x	
Bit23	COUNT<10>/VCO_SEL<2>	x	
Bit24	COUNT<11>	x	
Bit25	COUNT<12>	x	
Bit26	COUNT<13>	x	
Bit27	COUNT<14>	x	
Bit28	COUNT<15>	x	
Bit29	COUNT<16>	x	
Bit30	COUNT<17>	x	
Bit31	MUX_COUNT	x	[0] = max freq count, [1] = min freq count

**Table 15. Register RDBK (Write Register for Readback)**

RDBK	Bit Name	Reset Value	Description
Bit0	ADDR<0>	0	Register Address Bits
Bit1	ADDR<1>	0	
Bit2	ADDR<2>	0	
Bit3	ADDR<3>	1	
Bit4	ADDR<4>	0	
Bit5	N/C	0	
Bit6	N/C	0	
Bit7	N/C	0	
Bit8	N/C	0	
Bit9	N/C	0	
Bit10	N/C	0	
Bit11	N/C	0	
Bit12	N/C	0	
Bit13	N/C	0	
Bit14	N/C	0	
Bit15	N/C	0	
Bit16	N/C	0	
Bit17	N/C	0	
Bit18	N/C	0	
Bit19	N/C	0	
Bit20	N/C	0	
Bit21	N/C	0	
Bit22	N/C	0	
Bit23	N/C	0	
Bit24	N/C	0	
Bit25	N/C	0	
Bit26	N/C	0	
Bit27	MUX_COUNT	0	[0] = max freq count, [1] = min freq count
Bit28	RB_REG<0>	x	Three LSBs of the address for the register that is being read: [001] = Register 1 [110] = Register 6
Bit29	RB_REG<1>	x	
Bit30	RB_REG<2>	x	
Bit31	RB_ENABLE	1	Puts device in Readback mode

### 8.5.1.1 BIAS SETTINGS

Optimum TRF7322 bias settings used in the performance measurements are shown in [Table 16](#).

**Table 16. Register Settings With Optimized Bias Set Used in the Performance Measurement.**

REGISTER	BITS	TYPICAL OPERATING MODE [256MHz-2GHz], INT MODE	TYPICAL OPERATING MODE [2GHz - 3GHz], INT MODE	TYPICAL OPERATING MODE [3GHz - 4.1GHz], INT MODE	LOW POWER MODE, INT MODE	FRACTIONAL MODE
REGISTER 1	RDIV	x	x	x	x	x
REGISTER 1	REF_INV	0	0	0	0	0
REGISTER 1	NEG_VCO	1	1	1	1	1
REGISTER 1	ICP	0	0	0	0	0
REGISTER 1	ICPDOUBLE	0	0	0	0	0
REGISTER 1	CAL_CLK_SEL	13	13	13	13	15
REGISTER 2	NINT	x	x	x	x	x
REGISTER 2	PLL_DIV_SEL	x	x	x	x	x
REGISTER 2	PRSC_SEL	x	x	x	x	x
REGISTER 2	VCO_SEL	x	x	x	x	x
REGISTER 2	VCO_SEL_MODE	x	x	x	x	x
REGISTER 2	CAL_ACC	0	0	0	0	0
REGISTER 2	EN_CAL	1	1	1	1	1
REGISTER 3	NFRAC	0	0	0	0	x
REGISTER 4	PWD_PLL	0	0	0	0	0
REGISTER 4	PWD_CP	0	0	0	0	0
REGISTER 4	PWD_VCO	0	0	0	0	0
REGISTER 4	PWD_VCO_MUX	0	0	0	0	0
REGISTER 4	PWD_DIV124	0	0	0	0	0
REGISTER 4	PWD_PRESC	0	0	0	0	0
REGISTER 4	PWD_OUTBUF	0	0	0	1	0
REGISTER 4	PWD_LO_DIV	0	0	0	1	0
REGISTER 4	PWD_TX_DIV	0	0	0	0	0
REGISTER 4	PWD_MOD	0	0	0	0	0
REGISTER 4	EN_EXTVCO	0	0	0	0	0
REGISTER 4	EN_ISOURCE	0	0	0	0	1
REGISTER 4	LD_ANA_PREC	0	0	0	0	3
REGISTER 4	CP_TRISTATE	0	0	0	0	0
REGISTER 4	SPEEDUP	0	0	0	0	0
REGISTER 4	LD_DIG_PREC	0	0	0	0	0
REGISTER 4	MOD_ORD	5	5	5	5	4
REGISTER 4	DITH_SEL	0	0	0	0	0
REGISTER 4	DEL_SD_CLK	2	2	2	2	0
REGISTER 4	EN_FRAC_MODE	0	0	0	0	1
REGISTER 5	IB_MOD_GM	3	3	2	0	3
REGISTER 5	IB_MOD_LO	0	1	0	0	0
REGISTER 5	VCO_BIAS	15	15	15	15	15
REGISTER 5	VCOBUF_BIAS	2	2	2	2	2
REGISTER 5	OUTBUF_BIAS	2	2	2	0	2
REGISTER 5	VCOMUX_BIAS	2	2	2	2	2
REGISTER 5	VCO_CAL_IB	0	0	0	0	0
REGISTER 5	VCO_CAL_REF	3	3	3	3	3
REGISTER 5	VCO_AMPL_CTRL	0	0	0	0	0
REGISTER 5	VCO_VB_CTRL	3	3	3	3	3
REGISTER 5	EN_LD_ISOURCE	0	0	0	0	0

**Table 16. Register Settings With Optimized Bias Set Used in the Performance Measurement. (continued)**

REGISTER	BITS	TYPICAL OPERATING MODE [256MHz-2GHz], INT MODE	TYPICAL OPERATING MODE [2GHz - 3GHz], INT MODE	TYPICAL OPERATING MODE [3GHz - 4.1GHz], INT MODE	LOW POWER MODE, INT MODE	FRACTIONAL MODE
REGISTER 6	VCO_TRIM	x	x	x	x	x
REGISTER 6	EN_LOCKDET	0	0	0	0	0
REGISTER 6	VCO_TEST_MODE	0	0	0	0	0
REGISTER 6	CAL_BYPASS	0	0	0	0	0
REGISTER 6	MUX_CTRL	1	1	1	1	5
REGISTER 6	ISOURCE_SINKB	0	0	0	0	0
REGISTER 6	ISOURCE_TRIM	4	4	4	4	7
REGISTER 6	LO_DIV_SEL	x	x	x	x	x
REGISTER 6	LO_DIV_BIAS	2	2	2	0	2
REGISTER 6	TX_DIV_SEL	x	x	x	x	x
REGISTER 6	TX_DIV_BIAS	1	1	1	0	1
REGISTER 6	GAIN_CTRL	0	0	0	0	0

## 9 Application and Implementation

### NOTE

Information in the following applications sections is not part of the TI component specification, and TI does not warrant its accuracy or completeness. TI's customers are responsible for determining suitability of components for their purposes. Customers should validate and test their design implementation to confirm system functionality.

### 9.1 Application Information

### 9.2 Typical Application

Figure 135 shows a typical application schematic for the TRF3722.

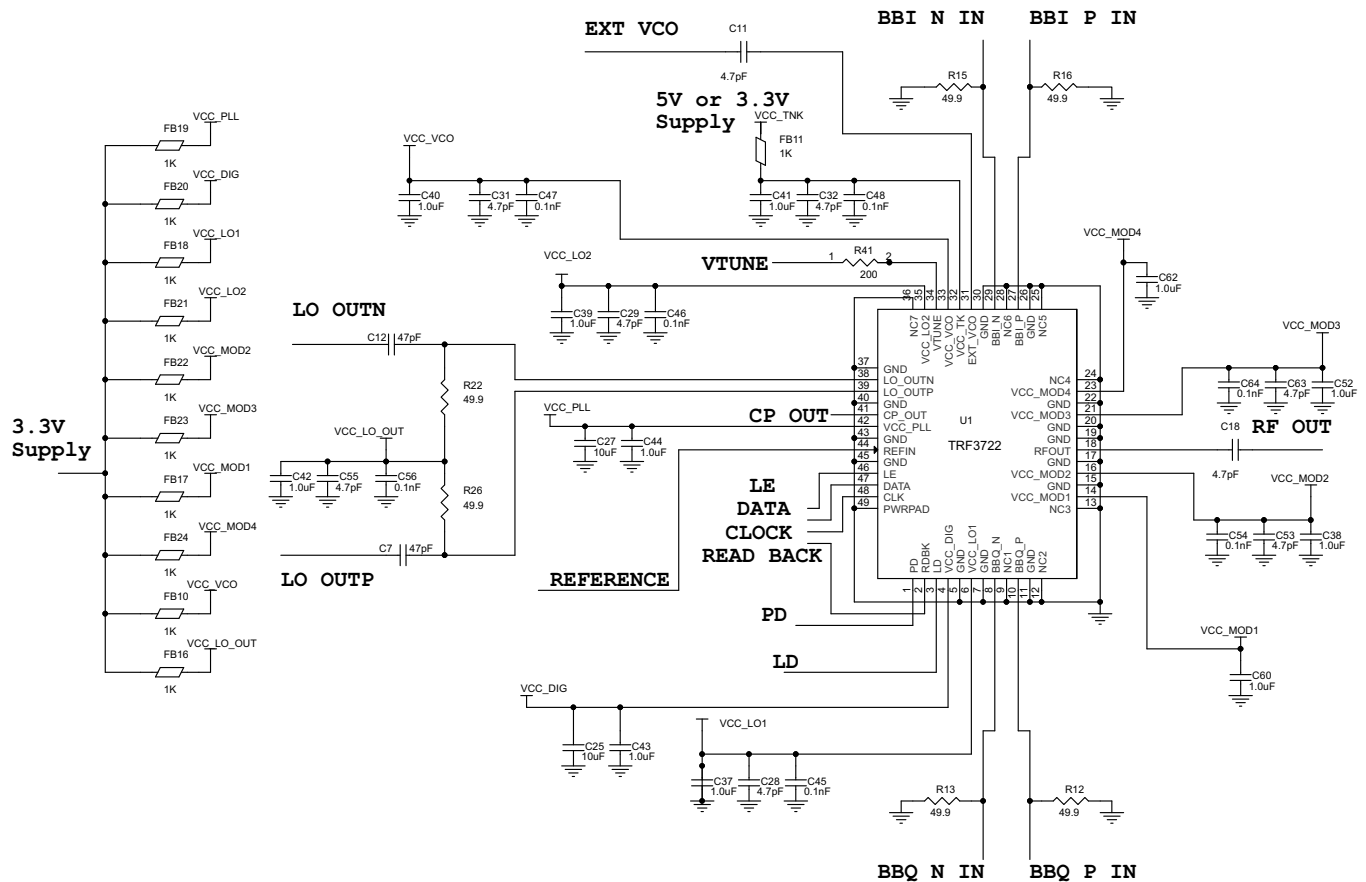

Figure 135. TRF3722 Application Schematic

## Typical Application (continued)

### 9.2.1 Design Requirements

Table 17 lists the pin termination requirements and interfacing for the circuit.

**Table 17. Termination Requirements and Interfacing**

PIN	NAME	DESCRIPTION
47	DATA	4WI data input: digital input, high impedance
2	RDBK	Readback output; digital output pins can source or sink up to 8 mA of current
3	LD	Lock detector digital output, as configured by MUX_CTRL
8,10,27,29	BBI_P, BBI_N, BBQ_P, BBQ_N	In-phase and quadrature baseband differential baseband signals. Typical 0.25V common mode is needed
18	RFOUT	Modulator RF output: must be ac-coupled and can drive 50 $\Omega$ load
31	EXT_VCO	External local oscillator input: high impedance, normally ac-coupled. If unused terminate to 50 ohms load
38,39	LO_OUTP, LO_OUTN	Local oscillator output: open-collector output. A pull-up resistor is LO_OUT required, normally ac-coupled.
44	REFIN	Reference clock input: high impedance, normally ac-coupled
46	LE	Serial interface latch enable: digital input, high impedance
48	CLK	Serial interface clock input: digital input, high impedance
47	DATA	Serial interface data input: digital input, high impedance



### 9.2.2 Detailed Design Procedures: DAC to Modulator Interface Network

Digital-to-analog converter (DAC) can interface directly with the TRF3722 modulator. The common-mode voltage of the DAC and the modulator baseband inputs should be properly maintained. With the proper interface network, the common-mode voltage of the DAC can be translated to the proper common-mode voltage of the modulator. The TRF3722 common-mode voltage is typically 0.25 V, and is ideally suited to interface with the DAC3482/3484 (DAC348x) and DAC38J8x family. The interface network is shown in Figure 136.

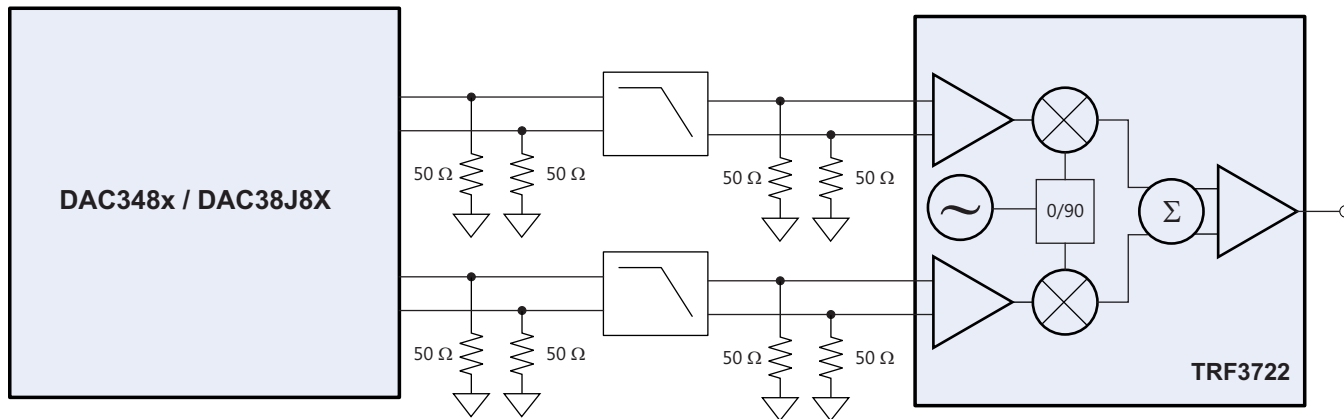

Figure 136. DAC348x Interface with the TRF3722 Modulator

The DAC348x requires a load resistance of 25  $\Omega$  per branch to maintain its optimum voltage swing of 1- $V_{PP}$  differential with a 20-mA max current setting. The load of the DAC is separated into two parallel 50- $\Omega$  resistors placed on the input and output side of the low-pass filter. This configuration provides the proper resistive load to the DAC while also providing a convenient 50- $\Omega$  source and load termination for the filter.

### 9.2.3 Application Curves: DAC34H84 with TRF3722 Modulator Performance

The cascaded combination of the DAC34H84 and TRF3722 modulator yields excellent system parameters suitable for high-performance applications. Figure 137 and Figure 138 show 152.9 MHz IF adjacent channel power ratio (ACPR) performance.

- Mode integer
- PFD: 3.2 MHz
- Reference: 153.6 MHz
- LO = 1689.6 MHz
- IF = 152.9 MHz
- RF = 1842.5 MHz

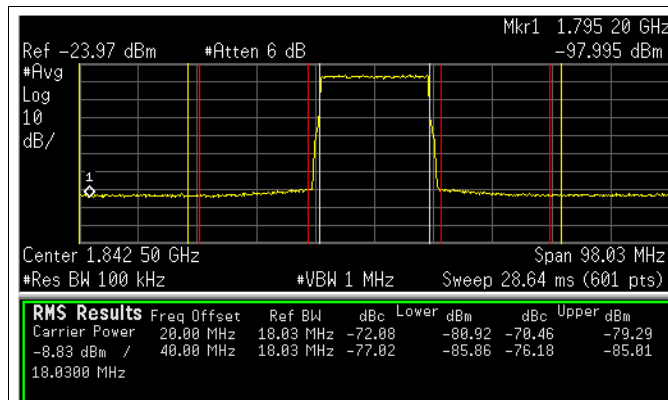

Figure 137. 152.9 MHz IF, DAC34H84 + TRF3722 20 MHz LTE ACPR

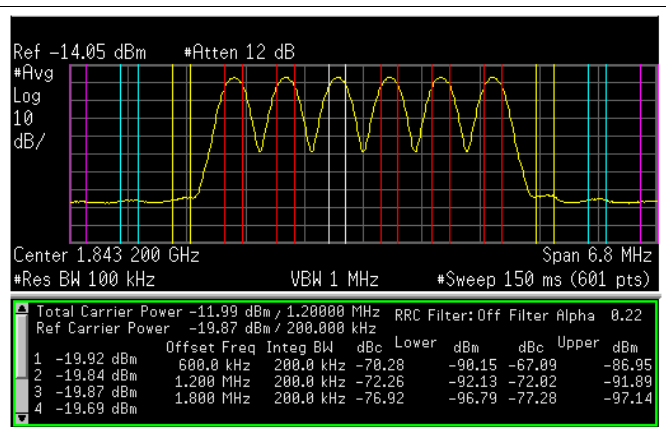

Figure 138. 152.9 MHz IF, 6 Carrier MC-GSM DAC34H84 + TRF3722 ACPR Performance

## 10 Power Supply Recommendations

The TRF3722 is powered by supplying a nominal 3.3 V and 5 V. It can also be powered using only 3.3V supply. Proper RF bypassing should be placed close to each power supply pin. Ground pin connections should have at least one ground via close to each ground pin to minimize ground inductance. The PowerPAD™ must be tied to ground, preferably with the recommended ground via pattern to provide a good thermal conduction path to the alternate side of the board and to provide a good RF ground for the device. (Refer to [Layout Guidelines](#) section for additional information.)

## 11 Layout

### 11.1 Layout Guidelines

Layout of the application board significantly impacts the analog performance of the TRF3722 device. Noise and high-speed signals should be prevented from leaking onto power-supply terminals or analog signals. The TRF3722 device is fitted with a ground slug on the back of the package that must be soldered to the printed circuit board (PCB) ground with adequate ground vias to ensure a good thermal and electrical connection. The ground pins of the device can be directly tied to the ground slug pad for a low-inductance path to ground. Additional ground vias may be added if space allows. Follow these recommendations:

- Place supply decoupling capacitors physically close to the device, on the same side of the board. Isolate supply terminals with a ferrite bead.
- Maintain a continuous ground plane in the vicinity of the device and as return paths for all high-speed signal lines. Place reference plane vias or decoupling capacitors near any signal line reference transition.
- Power planes should not overlap each other or high-speed signal lines.
- Isolate REFIN routing from loop filter lines, control lines, and other high-speed lines.

### 11.2 Layout Example

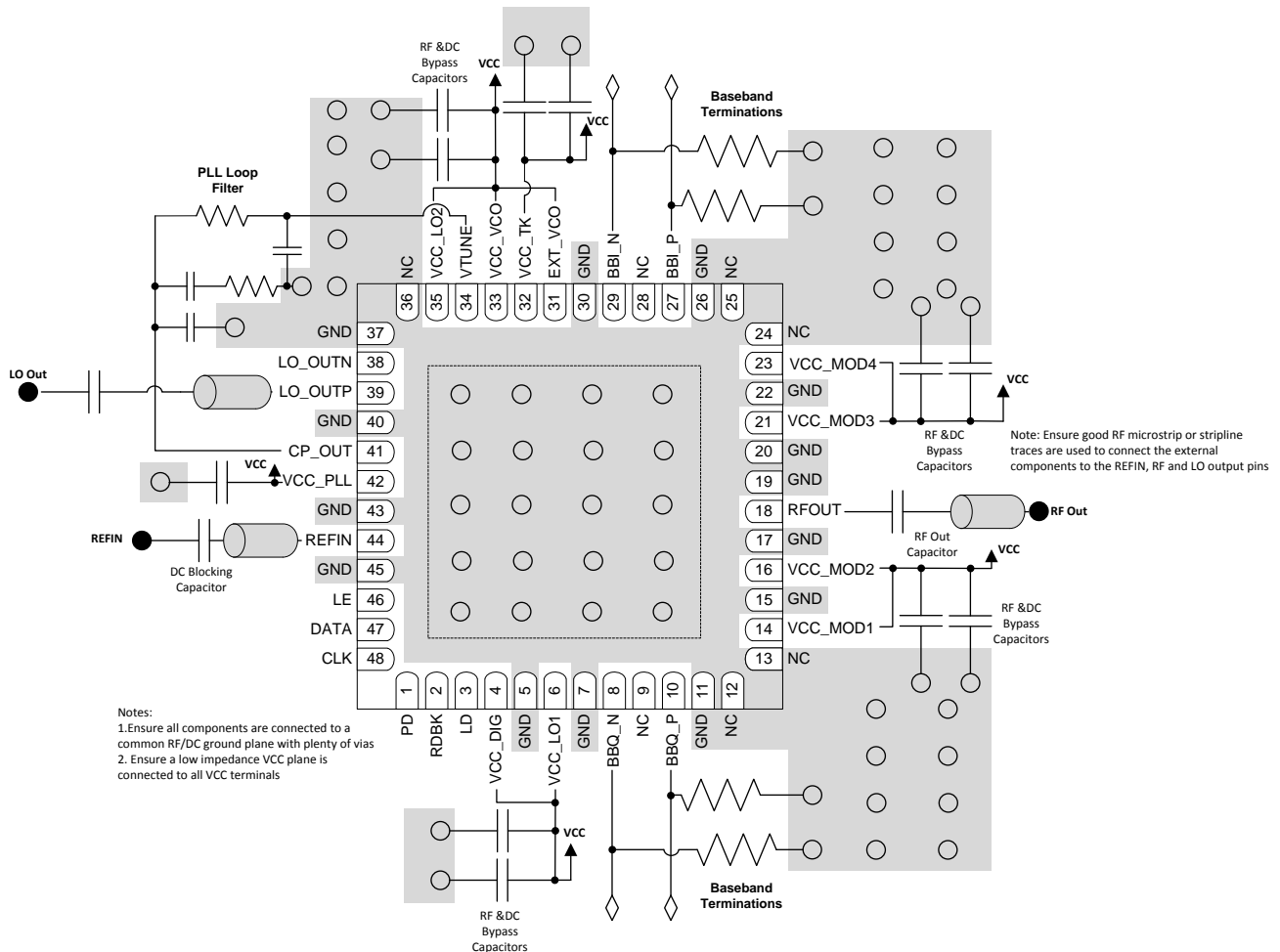

Figure 139. Layout

## 12 器件和文档支持

### 12.1 接收文档更新通知

要接收文档更新通知，请导航至 [ti.com](http://ti.com) 上的器件产品文件夹。请单击右上角的通知我进行注册，即可收到任意产品信息更改每周摘要。有关更改的详细信息，请查看任意已修订文档中包含的修订历史记录。

### 12.2 社区资源

下列链接提供到 TI 社区资源的连接。链接的内容由各个分销商“按照原样”提供。这些内容并不构成 TI 技术规范，并且不一定反映 TI 的观点；请参阅 TI 的《使用条款》。

**TI E2E™ 在线社区** *TI 的工程师对工程师 (E2E) 社区*。此社区的创建目的在于促进工程师之间的协作。在 [e2e.ti.com](http://e2e.ti.com) 中，您可以咨询问题、分享知识、拓展思路并与同行工程师一道帮助解决问题。

**设计支持** *TI 参考设计支持* 可帮助您快速查找有帮助的 E2E 论坛、设计支持工具以及技术支持的联系信息。

### 12.3 商标

PowerPAD, E2E are trademarks of Texas Instruments.  
All other trademarks are the property of their respective owners.

### 12.4 静电放电警告



ESD 可能会损坏该集成电路。德州仪器 (TI) 建议通过适当的预防措施处理所有集成电路。如果不遵守正确的处理措施和安装程序，可能会损坏集成电路。

ESD 的损坏小至导致微小的性能降级，大至整个器件故障。精密的集成电路可能更容易受到损坏，这是因为非常细微的参数更改都可能会导致器件与其发布的规格不相符。

### 12.5 Glossary



[SLYZ022](#) — *TI Glossary*.

This glossary lists and explains terms, acronyms, and definitions.

## 13 机械、封装和可订购信息

以下页面包括机械、封装和可订购信息。这些信息是指定器件的最新可用数据。这些数据发生变化时，我们可能不会另行通知或修订此文档。如欲获取此产品说明书的浏览器版本，请参见左侧的导航栏。

**PACKAGING INFORMATION**

Orderable Device	Status (1)	Package Type	Package Drawing	Pins	Package Qty	Eco Plan (2)	Lead finish/ Ball material (6)	MSL Peak Temp (3)	Op Temp (°C)	Device Marking (4/5)	Samples
TRF3722IRGZR	ACTIVE	VQFN	RGZ	48	2500	RoHS & Green	NIPDAU	Level-2-260C-1 YEAR	-40 to 85	TRF3722 IRGZ	
TRF3722IRGZT	ACTIVE	VQFN	RGZ	48	250	RoHS & Green	NIPDAU	Level-2-260C-1 YEAR	-40 to 85	TRF3722 IRGZ	

(1) The marketing status values are defined as follows:

**ACTIVE:** Product device recommended for new designs.

**LIFEBUY:** TI has announced that the device will be discontinued, and a lifetime-buy period is in effect.

**NRND:** Not recommended for new designs. Device is in production to support existing customers, but TI does not recommend using this part in a new design.

**PREVIEW:** Device has been announced but is not in production. Samples may or may not be available.

**OBsolete:** TI has discontinued the production of the device.

(2) **RoHS:** TI defines "RoHS" to mean semiconductor products that are compliant with the current EU RoHS requirements for all 10 RoHS substances, including the requirement that RoHS substance do not exceed 0.1% by weight in homogeneous materials. Where designed to be soldered at high temperatures, "RoHS" products are suitable for use in specified lead-free processes. TI may reference these types of products as "Pb-Free".

**RoHS Exempt:** TI defines "RoHS Exempt" to mean products that contain lead but are compliant with EU RoHS pursuant to a specific EU RoHS exemption.

**Green:** TI defines "Green" to mean the content of Chlorine (Cl) and Bromine (Br) based flame retardants meet JS709B low halogen requirements of <=1000ppm threshold. Antimony trioxide based flame retardants must also meet the <=1000ppm threshold requirement.

(3) MSL, Peak Temp. - The Moisture Sensitivity Level rating according to the JEDEC industry standard classifications, and peak solder temperature.

(4) There may be additional marking, which relates to the logo, the lot trace code information, or the environmental category on the device.

(5) Multiple Device Markings will be inside parentheses. Only one Device Marking contained in parentheses and separated by a "~" will appear on a device. If a line is indented then it is a continuation of the previous line and the two combined represent the entire Device Marking for that device.

(6) Lead finish/Ball material - Orderable Devices may have multiple material finish options. Finish options are separated by a vertical ruled line. Lead finish/Ball material values may wrap to two lines if the finish value exceeds the maximum column width.

**Important Information and Disclaimer:**The information provided on this page represents TI's knowledge and belief as of the date that it is provided. TI bases its knowledge and belief on information provided by third parties, and makes no representation or warranty as to the accuracy of such information. Efforts are underway to better integrate information from third parties. TI has taken and continues to take reasonable steps to provide representative and accurate information but may not have conducted destructive testing or chemical analysis on incoming materials and chemicals. TI and TI suppliers consider certain information to be proprietary, and thus CAS numbers and other limited information may not be available for release.

In no event shall TI's liability arising out of such information exceed the total purchase price of the TI part(s) at issue in this document sold by TI to Customer on an annual basis.



## TAPE AND REEL INFORMATION



### QUADRANT ASSIGNMENTS FOR PIN 1 ORIENTATION IN TAPE



\*All dimensions are nominal

Device	Package Type	Package Drawing	Pins	SPQ	Reel Diameter (mm)	Reel Width W1 (mm)	A0 (mm)	B0 (mm)	K0 (mm)	P1 (mm)	W (mm)	Pin1 Quadrant
TRF3722IRGZR	VQFN	RGZ	48	2500	330.0	16.4	7.3	7.3	1.5	12.0	16.0	Q2
TRF3722IRGZT	VQFN	RGZ	48	250	180.0	16.4	7.3	7.3	1.5	12.0	16.0	Q2

**TAPE AND REEL BOX DIMENSIONS**

\*All dimensions are nominal

Device	Package Type	Package Drawing	Pins	SPQ	Length (mm)	Width (mm)	Height (mm)
TRF3722IRGZR	VQFN	RGZ	48	2500	350.0	350.0	43.0
TRF3722IRGZT	VQFN	RGZ	48	250	213.0	191.0	55.0



## GENERIC PACKAGE VIEW

**RGZ 48**

**VQFN - 1 mm max height**

7 x 7, 0.5 mm pitch

PLASTIC QUADFLAT PACK- NO LEAD

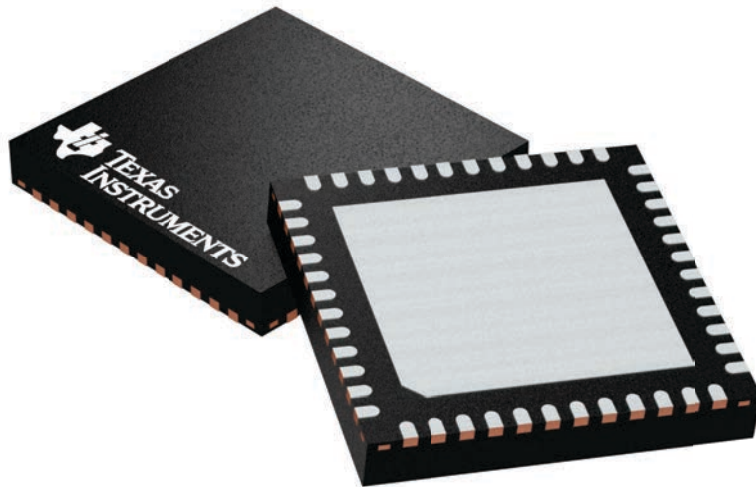

Images above are just a representation of the package family, actual package may vary.  
Refer to the product data sheet for package details.

4224671/A



NOTES:

1. All linear dimensions are in millimeters. Any dimensions in parenthesis are for reference only. Dimensioning and tolerancing per ASME Y14.5M.
2. This drawing is subject to change without notice.
3. The package thermal pad must be soldered to the printed circuit board for optimal thermal and mechanical performance.

# EXAMPLE BOARD LAYOUT

RGZ0048A

VQFN - 1 mm max height

PLASTIC QUADFLAT PACK- NO LEAD

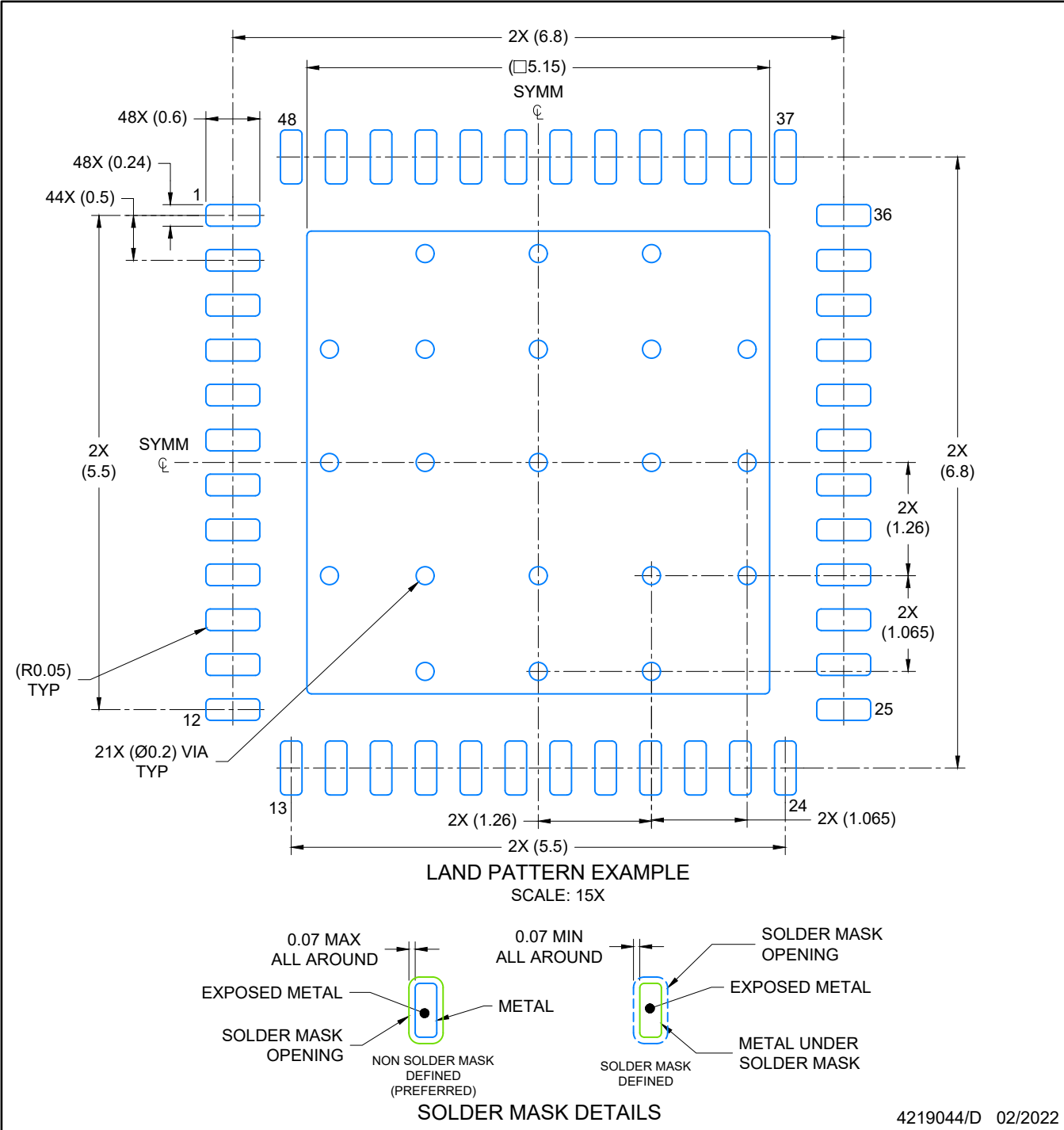

NOTES: (continued)

- 4. This package is designed to be soldered to a thermal pad on the board. For more information, see Texas Instruments literature number SLUA271 ([www.ti.com/lit/slua271](http://www.ti.com/lit/slua271)).
- 5. Vias are optional depending on application, refer to device data sheet. If any vias are implemented, refer to their locations shown on this view. It is recommended that vias under paste be filled, plugged or tented.

# EXAMPLE STENCIL DESIGN

RGZ0048A

VQFN - 1 mm max height

PLASTIC QUADFLAT PACK- NO LEAD

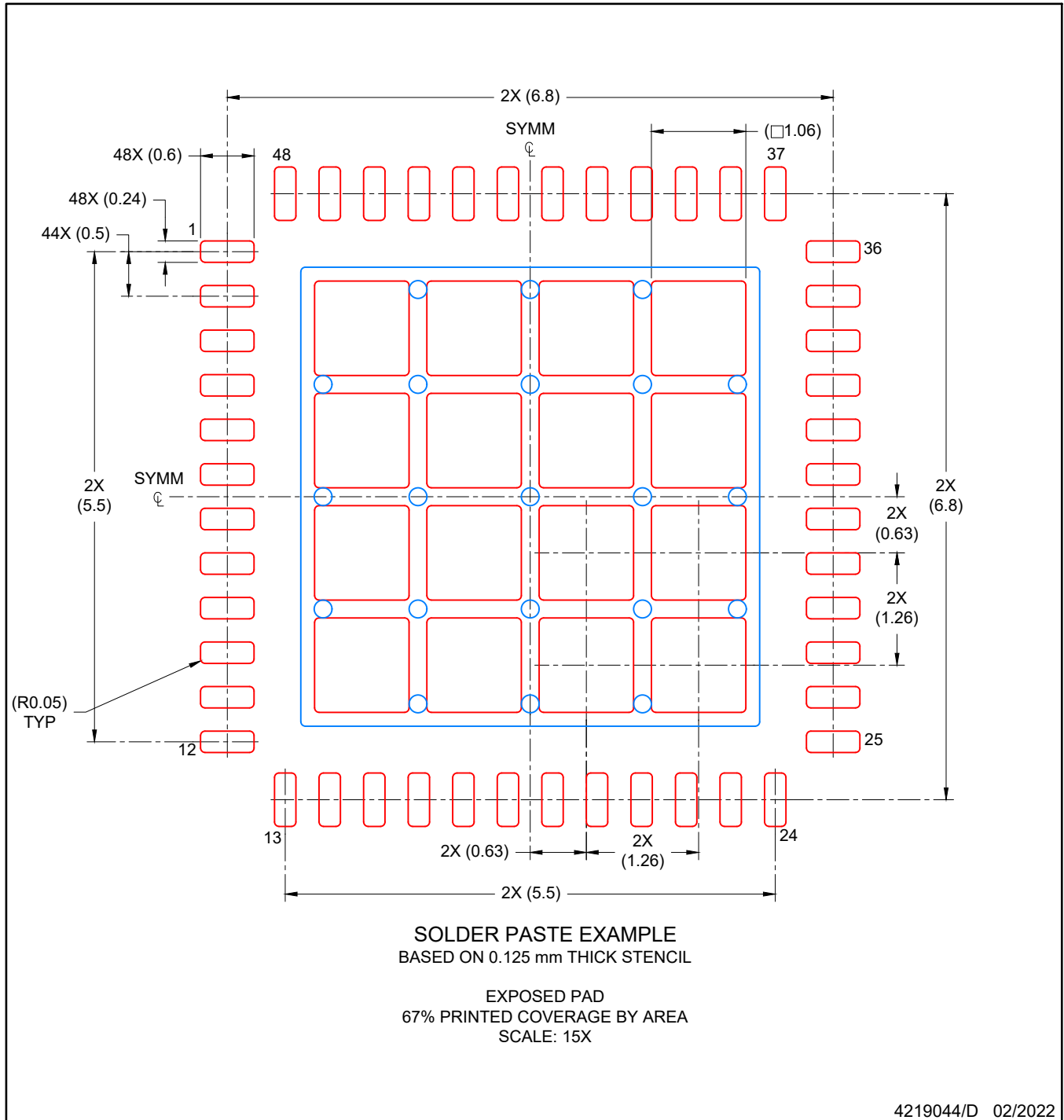

NOTES: (continued)

6. Laser cutting apertures with trapezoidal walls and rounded corners may offer better paste release. IPC-7525 may have alternate design recommendations.

## 重要声明和免责声明

TI“按原样”提供技术和可靠性数据（包括数据表）、设计资源（包括参考设计）、应用或其他设计建议、网络工具、安全信息和其他资源，不保证没有瑕疵且不做任何明示或暗示的担保，包括但不限于对适销性、某特定用途方面的适用性或不侵犯任何第三方知识产权的暗示担保。

这些资源可供使用 TI 产品进行设计的熟练开发人员使用。您将自行承担以下全部责任：(1) 针对您的应用选择合适的 TI 产品，(2) 设计、验证并测试您的应用，(3) 确保您的应用满足相应标准以及任何其他功能安全、信息安全、监管或其他要求。

这些资源如有变更，恕不另行通知。TI 授权您仅可将这些资源用于研发本资源所述的 TI 产品的应用。严禁对这些资源进行其他复制或展示。您无权使用任何其他 TI 知识产权或任何第三方知识产权。您应全额赔偿因在这些资源的使用中对 TI 及其代表造成的任何索赔、损害、成本、损失和债务，TI 对此概不负责。

TI 提供的产品受 [TI 的销售条款](#) 或 [ti.com](#) 上其他适用条款/TI 产品随附的其他适用条款的约束。TI 提供这些资源并不会扩展或以其他方式更改 TI 针对 TI 产品发布的适用的担保或担保免责声明。

TI 反对并拒绝您可能提出的任何其他或不同的条款。

邮寄地址：Texas Instruments, Post Office Box 655303, Dallas, Texas 75265

Copyright © 2022，德州仪器 (TI) 公司