

## LP5560 具有单线制接口的可编程 LED 驱动器

### 1 特性

- 宽输入电压范围：2.7V 至 5.5V
- 可调节输出电流：2.8mA 至 19.5mA
- 具有电流上升及下降时间控制的可编程闪烁序列
- 用于无编程功能的简易系统的默认闪烁序列
- 单线制接口
- 恒流高侧输出驱动器
- 极低的余量电压（典型值为 40mV）
- 超小解决方案尺寸 - 无外部组件

### 2 应用

- 手机及其他便携式设备的 LED 指示灯
- 读卡器
- 加油机
- 计步器
- 电子门禁控制
- 需要简单反馈的设备

### 3 说明

LP5560 是一款可编程的 LED 驱动器，能够生成各种闪烁序列，每个序列最多由 3 个不同长度的脉冲组成。可以通过单线制接口对闪烁序列进行编程。可编程参数包括导通和关断时间，以及上升和下降时间。LP5560 内置默认序列，能够应用于无编程功能的简易系统中。

该器件具有超低余量电压，无需使用升压放大器。指示灯 LED 可以由电池直接驱动。该器件采用小型封装，并且无需任何外部组件，最大限度地减小了解决方案的尺寸。

LP5560 采用间距为 0.4mm 的 TI 微型 4 引脚 DSBGA 封装。

#### 器件信息<sup>(1)</sup>

器件型号	封装	封装尺寸（标称值）
LP5560	DSBGA (4)	0.886mm x 0.886mm

(1) 要了解所有可用封装，请见数据表末尾的可订购产品附录。

#### 典型应用

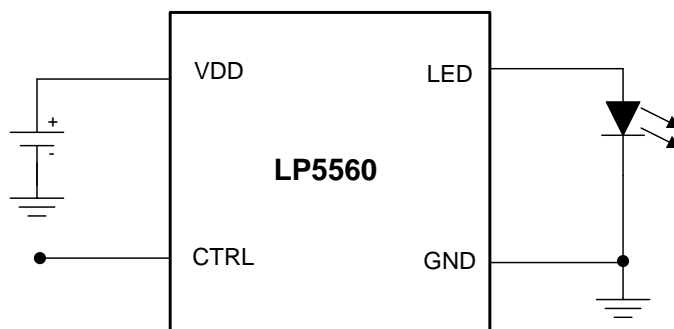

Copyright © 2016, Texas Instruments Incorporated



## 目录

<b>1</b>	<b>特性</b> .....	<b>1</b>	7.5	Programming .....	<b>18</b>
<b>2</b>	<b>应用</b> .....	<b>1</b>	7.6	Registers .....	<b>18</b>
<b>3</b>	<b>说明</b> .....	<b>1</b>	<b>8</b>	<b>Application and Implementation</b> .....	<b>19</b>
<b>4</b>	<b>修订历史记录</b> .....	<b>2</b>	8.1	Application Information .....	<b>19</b>
<b>5</b>	<b>Pin Configuration and Functions</b> .....	<b>3</b>	8.2	Typical Application .....	<b>19</b>
<b>6</b>	<b>Specifications</b> .....	<b>4</b>	<b>9</b>	<b>Power Supply Recommendations</b> .....	<b>22</b>
6.1	Absolute Maximum Ratings .....	<b>4</b>	<b>10</b>	<b>Layout</b> .....	<b>22</b>
6.2	ESD Ratings .....	<b>4</b>	10.1	Layout Guidelines .....	<b>22</b>
6.3	Recommended Operating Conditions .....	<b>4</b>	10.2	Layout Example .....	<b>22</b>
6.4	Thermal Information .....	<b>5</b>	<b>11</b>	<b>器件和文档支持</b> .....	<b>23</b>
6.5	Electrical Characteristics .....	<b>5</b>	11.1	文档支持 .....	<b>23</b>
6.6	Single-Wire Interface Timing Requirements .....	<b>6</b>	11.2	接收文档更新通知 .....	<b>23</b>
6.7	Typical Characteristics .....	<b>7</b>	11.3	社区资源 .....	<b>23</b>
<b>7</b>	<b>Detailed Description</b> .....	<b>8</b>	11.4	商标 .....	<b>23</b>
7.1	Overview .....	<b>8</b>	11.5	静电放电警告 .....	<b>23</b>
7.2	Functional Block Diagram .....	<b>8</b>	11.6	Glossary .....	<b>23</b>
7.3	Feature Description .....	<b>9</b>	<b>12</b>	<b>机械、封装和可订购信息</b> .....	<b>23</b>
7.4	Device Functional Modes .....	<b>17</b>			

## 4 修订历史记录

注：之前版本的页码可能与当前版本有所不同。

<b>Changes from Revision C (May 2013) to Revision D</b>	<b>Page</b>
• 已添加 其他应用，器件信息和引脚配置和功能部分，ESD 额定值和热性能信息表，特性描述，器件功能模式，应用和实施，电源相关建议，布局，器件和文档支持以及机械、封装和可订购信息部分 .....	<b>1</b>
• Changed R <sub>θJA</sub> value from "120°C/W" to "184.3°C/W"; added additional thermal values .....	<b>5</b>

<b>Changes from Revision B (April 2013) to Revision C</b>	<b>Page</b>
• Changed layout of National Data Sheet to TI format .....	<b>18</b>

## 5 Pin Configuration and Functions

**YFQ Package  
4-Pin DSBGA  
Top View**

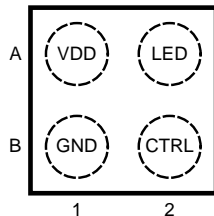

**Pin Functions**

PIN		TYPE <sup>(1)</sup>	DESCRIPTION
NO.	NAME		
A1	VDD	P	Power supply pin
A2	LED	A	Current source output
B1	GND	G	Ground
B2	CTRL	DI	Single-wire interface input

(1) A: Analog Pin D: Digital Pin G: Ground Pin P: Power Pin I: Input Pin

## 6 Specifications

### 6.1 Absolute Maximum Ratings

over operating free-air temperature range (unless otherwise noted)<sup>(1)(2)(3)</sup>

	MIN	MAX	UNIT
Voltage on VDD pin	-0.3	6	V
Voltage on other pins (CTRL,LED) <sup>(4)</sup>	-0.3	VDD + 0.3 V with 6 V maximum	V
Continuous power dissipation <sup>(5)</sup>	Internally Limited		
Junction temperature, T <sub>J-MAX</sub>		125	°C
Storage temperature, T <sub>stg</sub>	-65	150	°C

- (1) Stresses beyond those listed under *Absolute Maximum Ratings* may cause permanent damage to the device. These are stress ratings only, which do not imply functional operation of the device at these or any other conditions beyond those indicated under *Recommended Operating Conditions*. Exposure to absolute-maximum-rated conditions for extended periods may affect device reliability.
- (2) All voltages are with respect to the potential at the GND pins.
- (3) If Military/Aerospace specified devices are required, contact the Texas Instruments Sales Office/ Distributors for availability and specifications. Voltage
- (4) Undervoltage lockout (UVLO) shuts down the LED driver with V<sub>IN</sub> drops to 2.3 V (typical). Power-on reset (POR) trips at V<sub>IN</sub> = 2 V (typical).
- (5) Internal thermal shutdown circuitry protects the device from permanent damage. Thermal shutdown engages at T<sub>J</sub> = 160°C (typical) and disengages at T<sub>J</sub>=140°C (typical).

### 6.2 ESD Ratings

		VALUE	UNIT
V <sub>(ESD)</sub> Electrostatic discharge	Human-body model (HBM), per ANSI/ESDA/JEDEC JS-001 <sup>(1)</sup>	±2000	V
	Charged-device model (CDM), per JEDEC specification JESD22-C101 <sup>(2)</sup>	±1000	

- (1) JEDEC document JEP155 states that 500-V HBM allows safe manufacturing with a standard ESD control process.
- (2) JEDEC document JEP157 states that 250-V CDM allows safe manufacturing with a standard ESD control process.

### 6.3 Recommended Operating Conditions

over operating free-air temperature range (unless otherwise noted)<sup>(1)(2)</sup>

	MIN	NOM	MAX	UNIT
Voltage on power pin (VDD)	2.7		5.5	V
Junction temperature, T <sub>J</sub>	-30		125	°C
Ambient temperature, T <sub>A</sub> <sup>(1)</sup>	-30		85	°C

- (1) In applications where high power dissipation and/or poor package thermal resistance is present, the maximum ambient temperature may have to be derated. Maximum ambient temperature (T<sub>A-MAX</sub>) is dependent on the maximum operating junction temperature (T<sub>J-MAX-OP</sub> = 125°C), the maximum power dissipation of the device in the application (P<sub>D-MAX</sub>), and the junction-to ambient thermal resistance of the part/package in the application (R<sub>θJA</sub>), as given by the following equation: T<sub>A-MAX</sub> = T<sub>J-MAX-OP</sub> - (R<sub>θJA</sub> × P<sub>D-MAX</sub>).
- (2) All voltages are with respect to the potential at the GND pin.

## 6.4 Thermal Information

THERMAL METRIC <sup>(1)</sup>		LP5560	UNIT
		YFQ (DSBGA)	
		4 PINS	
R <sub>θJA</sub>	Junction-to-ambient thermal resistance	184.3	°C/W
R <sub>θJC(top)</sub>	Junction-to-case (top) thermal resistance	1.8	°C/W
R <sub>θJB</sub>	Junction-to-board thermal resistance	103.2	°C/W
ψ <sub>JT</sub>	Junction-to-top characterization parameter	9.1	°C/W
ψ <sub>JB</sub>	Junction-to-board characterization parameter	103.1	°C/W

(1) For more information about traditional and new thermal metrics, see [Semiconductor and IC Package Thermal Metrics](#).

## 6.5 Electrical Characteristics

Unless otherwise specified: V<sub>IN</sub> = 3.6 V, CTRL = 3.6 V, V<sub>LED</sub> = 3.1 V; typical limits are for T<sub>A</sub> = 25°C, and minimum and maximum limits apply over the operating ambient temperature range (–30°C < T<sub>A</sub> < +85°C).<sup>(1)(2)</sup>

PARAMETER	TEST CONDITIONS	MIN	TYP	MAX	UNIT	
I <sub>SD</sub>	Shutdown supply current	CTRL = 0 V	0.4	0.75	μA	
I <sub>Q</sub>	Quiescent supply current	I <sub>LED</sub> = 0 mA	25	30		
I <sub>LED</sub>	LED output current	ISET = 0	2.26	2.8	3.34	mA
		ISET = 1 (default)	4.61	5.3	5.99	
		ISET = 2	6.78	7.8	8.82	
		ISET = 3	8.87	10.2	11.53	
		ISET = 4	10.96	12.6	14.24	
		ISET = 5	13.5	15.0	16.5	
		ISET = 6	15.05	17.3	19.55	
		ISET = 7	16.96	19.5	22.04	
ΔI <sub>LED</sub> %/ΔV <sub>IN</sub>	Line regulation	2.7 V ≤ V <sub>IN</sub> ≤ 4.5 V I <sub>DX</sub> = 5.3 mA, V <sub>f</sub> = 2.5 V	–3%	3%	%/1V	
ΔI <sub>LED</sub> %/ΔV <sub>LED</sub> <sup>(3)</sup>	Load regulation	1.7 V ≤ V <sub>LED</sub> ≤ 3.4 V, I <sub>LED</sub> = 5.3 mA	0.6			
V <sub>HR</sub>	Headroom voltage <sup>(4)</sup>	I <sub>LED</sub> = 5.3 mA	40	100	mV	
		I <sub>LED</sub> = 19.5 mA	40			
V <sub>IH</sub>	Logic input high level	V <sub>IN</sub> = 2.7 V to 5.5 V	1.1		V	
V <sub>IL</sub>	Logic input low level	V <sub>IN</sub> = 2.7 V to 5.5 V		0.6	V	
I <sub>CTRL</sub>	CTRL pin leakage current	CTRL = 1.8 V		400	nA	
T <sub>cycle_H</sub>	LED On time	Adjustable <sup>(5)</sup> , T <sub>A</sub> = 25°C	13.2	3009.6	ms	
T <sub>cycle_L</sub>	LED OFF time		26.4	6019.2	ms	
Trise	LED current rise time <sup>(6)</sup>		0	1584	ms	
Tfall	LED current fall time <sup>(6)</sup>		0	1584	ms	
Fade resolution	Rise/fall time resolution		See <sup>(5)</sup>	105.6		ms

(1) All voltages are with respect to the potential at the GND pins.

(2) Minimum and Maximum limits are specified by design, test, or statistical analysis. Typical numbers are not ensured, but do represent the most likely norm.

(3) I<sub>LED</sub> = LED output current, V<sub>LED</sub> = LED forward voltage.

(4) For LED output pin, headroom voltage is defined as the voltage across the internal current source when the LED current has dropped 10% from the value measured at V<sub>IN</sub> – 0.5 V. If headroom voltage requirement is not met, LED current regulation is compromised.

(5) Specified by design.

(6) LED current ramp-up and ramp-down uses a combined PWM-current adjustment.

## 6.6 Single-Wire Interface Timing Requirements

 See <sup>(1)(2)</sup> and [Figure 1](#)

		MIN	MAX	UNIT
$T_{C\_ON}$	Command pulse on time	15		$\mu\text{s}$
$T_{C\_OFF}$	Command pulse off time	30		$\mu\text{s}$
$T_{T\_ON}$	Minimum training pulse on time <sup>(3)</sup>	200		$\mu\text{s}$
$T_{T\_OFF}$	Minimum training pulse off time <sup>(4)</sup>	200		$\mu\text{s}$
$T_{CAL}$	Calibration pulse length	0.35	8	ms
$T_{ENTER}$	Command entering period	500		$\mu\text{s}$
$T_{ENTER}+T_{BLANK}$	Command entering period + Blank period		1500	$\mu\text{s}$

- (1) Specified by design.
- (2) Minimum and Maximum limits are specified by design, test, or statistical analysis. Typical numbers are not ensured, but do represent the most likely norm.
- (3) All CTRL signal high times between calibration pulse and training end are considered as training pulse on times.
- (4) All CTRL signal low times between calibration pulse and training end are considered as training pulse off times.

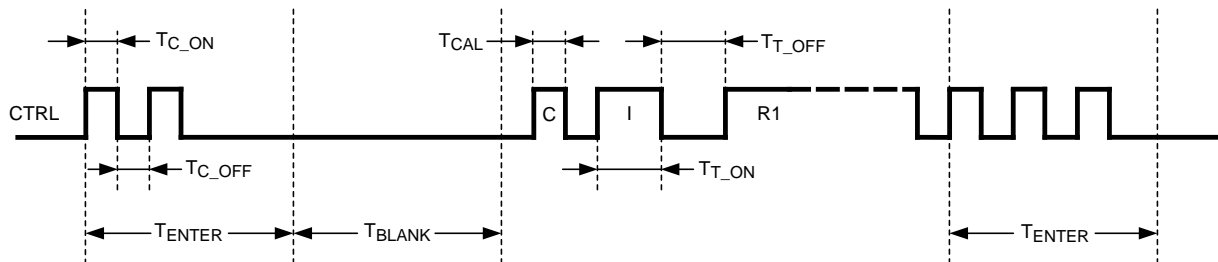

**Figure 1. Interface Timing**

### 6.7 Typical Characteristics

$T_J = 25^\circ\text{C}$ . Unless otherwise noted, typical characteristics apply to the *Functional Block Diagram* with:  $V_{IN} = 3.6\text{ V}$ ,  $R_{ISET} = 24\text{ k}\Omega$ ,  $C_{IN} = 100\text{ nF}$ .

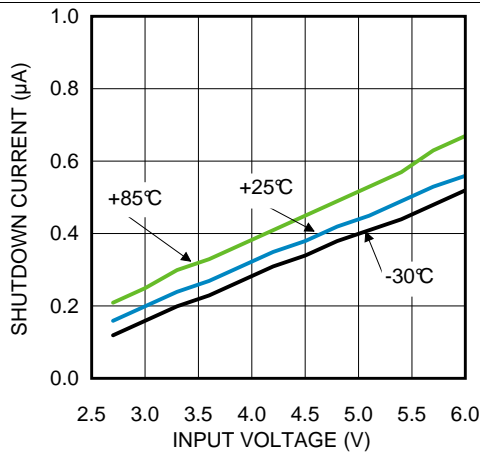

Figure 2. Standby Current vs  $V_{IN}$

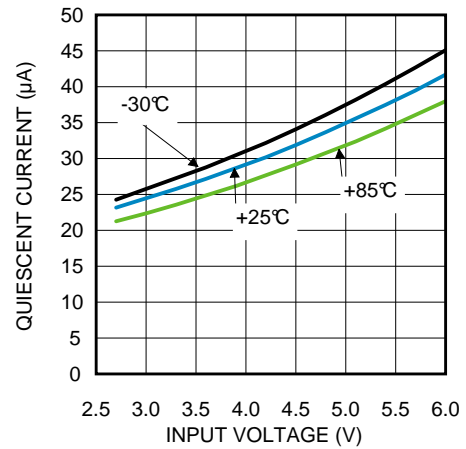

Figure 3. Quiescent Current vs  $V_{IN}$

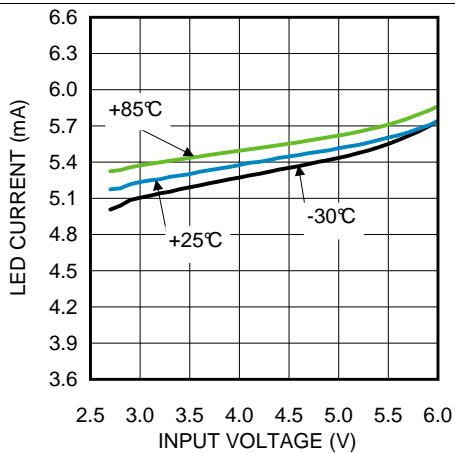

Figure 4. LED Current vs Input Voltage

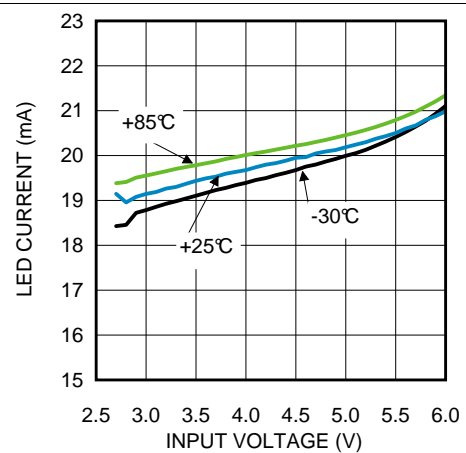

Figure 5. LED Current vs Input Voltage

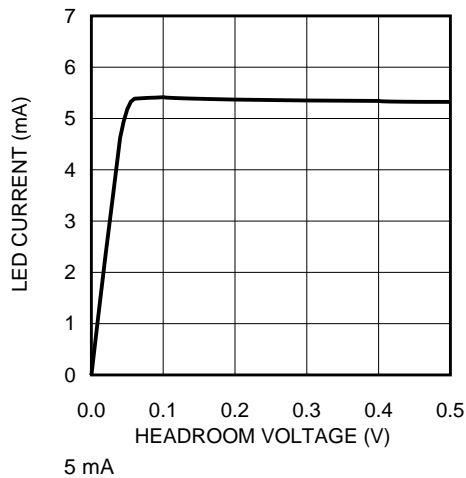

Figure 6.  $I_{OUT}$  vs Headroom Voltage

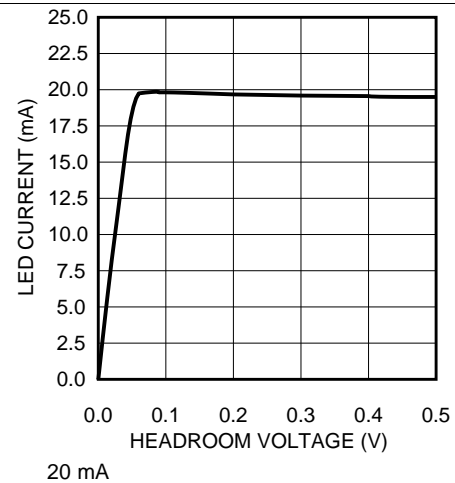

Figure 7.  $I_{OUT}$  vs Headroom Voltage

## 7 Detailed Description

### 7.1 Overview

The LP5560 is a programmable LED driver with a single-wire interface. It is designed to drive a single indicator LED with different blinking sequences. Up to three pulses with different on and off times can be programmed into the device. LED current rise and fall times can also be independently controlled. Blinking sequence is stored into volatile memory, thus removing input voltage  $V_{IN}$  resets the memory into default state.

The high-side LED driver has very low headroom voltage requirement and can drive most indicator LEDs directly from battery voltage. A single CTRL pin is used to control the device on and off and to change settings of the device. A default blinking sequence is programmed into the LP5560 to enable use of the devices in simply applications without programming capabilities.

### 7.2 Functional Block Diagram

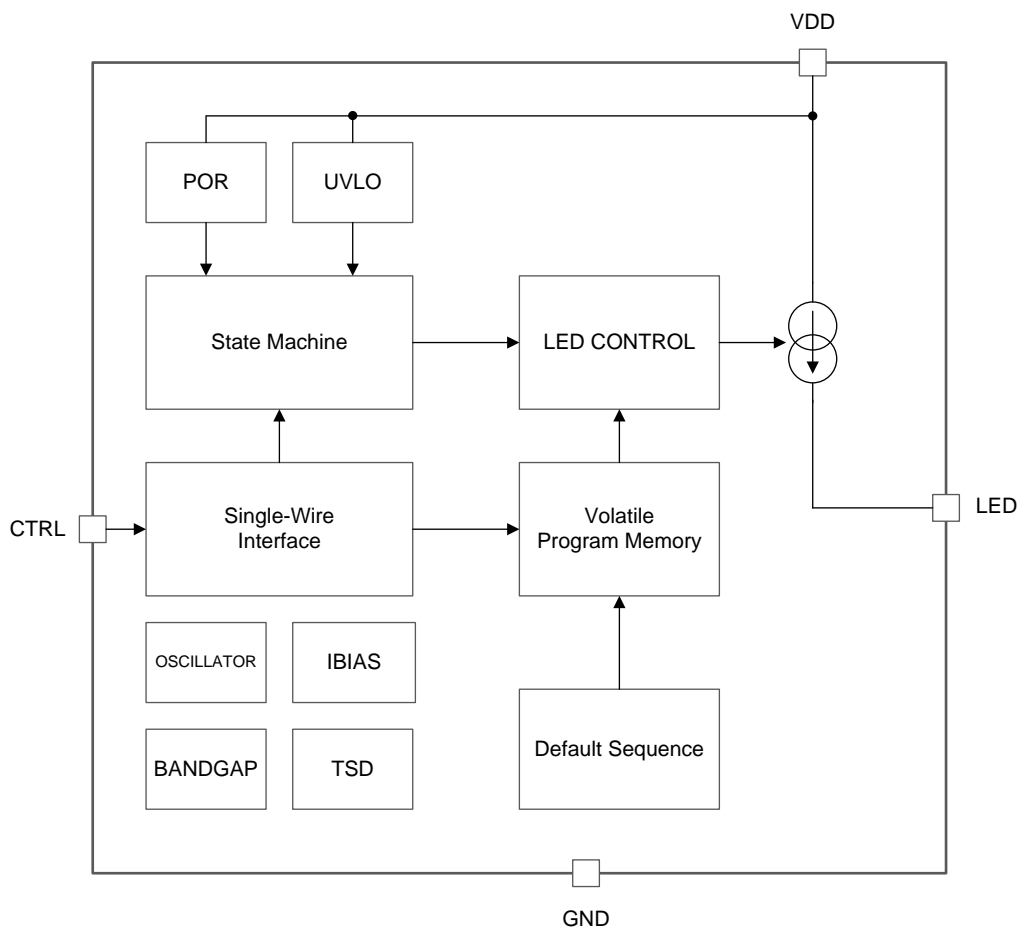

Copyright © 2016, Texas Instruments Incorporated



### 7.3 Feature Description

#### 7.3.1 LED Driver Headroom Voltage

The current source is connected internally between the VDD and LED output pins. The voltage across the current source, ( $V_{VDD} - V_{LED}$ ), is referred as headroom voltage ( $V_{HR}$ ). The current source requires a sufficient amount of headroom voltage to be present across it in order to regulate the output current properly. The LP5560 headroom voltage requirement is 40 mV (typical) and does not depend on the current setting.

#### 7.3.2 Single-Wire Interface

The LP5560 has one digital control input (CTRL). Threshold levels of CTRL input are fixed to support control from low-voltage controller. The CTRL signal is used to control the mode of the circuit. The rising edge of the CTRL signal activates the circuit and starts a command entering period. During the command entering period all rising edges are counted. After command entering period there is a blank period when no rising edges are allowed. If there are any rising edges during blank period these are not detected. User must take care not to start the training sequence before blank period has elapsed or the training sequence is corrupted.

If CTRL is left high after command entering period, the consequent command is performed right after the blank period. In case of run once command CTRL pin can be set low after the command entering period and execution of the command starts once CTRL pin is pulled high after blank period.

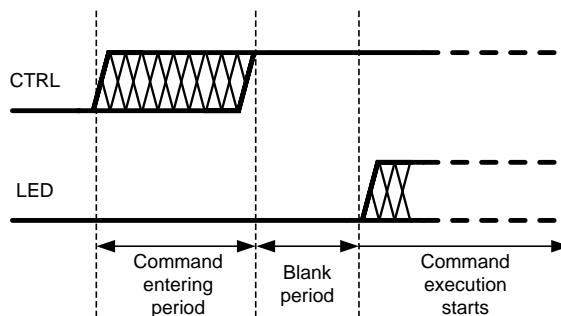

Figure 8. Single-Wire Interface

The LP5560 has four different commands. Command depends on the number of rising edges during command entering period. If there are more than 4 rising edges during command entering period command is ignored. Note that even in this case blank period needs to elapse before next command can be given.

Table 1. LP5560 Commands

COMMAND	NUMBER OF RISING EDGES DURING COMMAND ENTERING PERIOD
Run	1
Training start	2
Training end	3
Run once	4

### 7.3.2.1 Run Command

One rising edge of the CTRL signal within command entering period is interpreted as a run command. The CTRL pin must be kept high during blank period. If the CTRL pin is pulled low during command entering period or blank period device goes to stand by. In run mode (mode bit = 1) blinking sequence is started right after Blank period and it is repeated as long as CTRL signal is kept high. When the CTRL signal is set low device goes into standby mode (Figure 9).

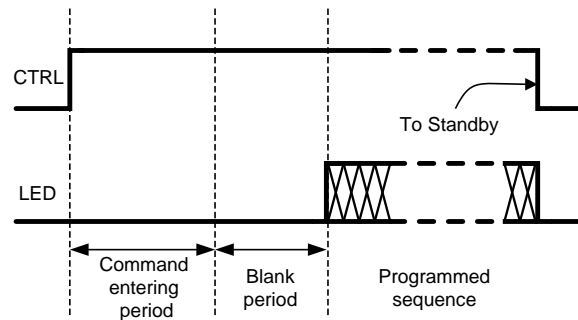

Figure 9. Run Mode

In follow mode (mode bit = 0) LED is turned on right after a blank period, and it stays on as long as CTRL is kept high. When CTRL signal is set low LED is turned off and device goes into standby mode (Figure 10).

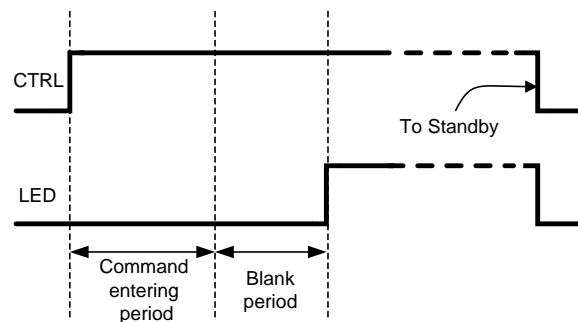

Figure 10. Follow Mode

### 7.3.2.2 Training Start Command

Two rising edges of CTRL signal within command entering period is interpreted as training start command. Training start command starts training sequence. Different blinking sequences can be trained into device in training mode. Training mode is described in more details in [Training Mode](#).

### 7.3.2.3 Training End Command

Three rising edges of CTRL signal within command entering period is interpreted as training end command. Training end is used to stop the training sequence.

### 7.3.2.4 Run-Once Command

Four rising edges of the CTRL signal within command entering period is interpreted as a run-once command. Programmed blinking sequence is performed once after a run-once command. If CTRL is kept high after command entering period the programmed blinking sequence starts right after the blank period has elapsed (Figure 11). The CTRL signal must stay high as long as programmed blinking sequence is executed. If CTRL is set low during execution of blinking sequence, device goes to standby and execution of blinking sequence is stopped.

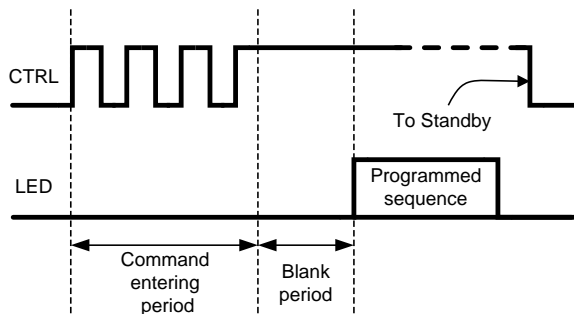

Figure 11. Run-Once Command

If CTRL signal is low after command entering period, blinking sequence is executed once the CTRL is set high (Figure 12).

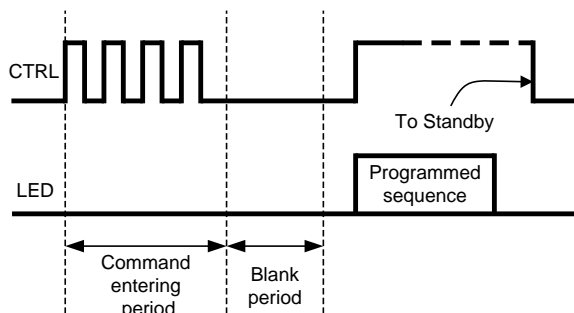

Figure 12. Delayed Run-Once Command

If device is in follow mode (mode bit is 0) the run-once command turns the LED on, and it is kept on as long as CTRL is held high.

### 7.3.3 Training Mode

Figure 17 shows an example of a full training sequence with three pulses. Training mode starts with a training start command. Training start command is followed by blank time during which no rising edges are allowed. Blank time is followed by calibration pulse. Calibration pulse length ( $T_{CAL}$ ) defines the speed of the training sequence and can vary from 350  $\mu$ s to 8 ms. During parameter settings register values are incremented at speed defined by  $T_{CAL}$ . For example, if calibration pulse length is 1 ms and current setting pulse length is 3.3 ms, the current-setting value is 3 (current-set register is incremented 3 times). If the parameter-setting pulse is shorter than the calibration pulse, then the corresponding parameter is set to 0.

The next rising edge after calibration pulse starts LED driver current setting (I). LED driver current is recorded once CTRL is pulled low. Note that there are *empty* low times before and after current setting pulse. For the following pulses both CTRL high and CTRL low times are used to set the parameters. Next the CTRL high time defines the LED current rise time setting for pulse 1 (R1). When R1 setting is started mode bit is set to 0. This sets the LP5560 device into follow mode. Mode bit is set to 1 after first off time has been saved into register. This means that at least one full pulse must be trained into memory to set the device into run mode.

CTRL low time after R1 defines the LED on time for pulse 1 (ON1). CTRL high time after ON1 sets the LED current fall time (F1). CTRL low time after F1 sets pulse 1 off time (OFF1). Once rising edge of CTRL is detected after first off time setting mode bit is set to 1 (run mode) and the number of pulses register (NOP[1:0]) is set to 1. This indicates that one full pulse has been trained into memory.

Rise, on, fall, and off times for pulse 2 and 3 are set the same way as for pulse 1. Note that NOP register is always incremented after OFF<sub>x</sub> time setting. This means that all pulse parameters (rise, on, fall, and off times) must be trained for each pulse make it valid. The training sequence is ended with training end command.

### 7.3.3.1 Ending the Training Sequence

A training end command can be given at any time of the training sequence except during blank time. Outcome of the training sequence depends on the place of the training end command. If a training end command is given after any of the off-time setting (OFF1, OFF2 or OFF3), mode bit is set to 1, and the corresponding number of pulses are stored into memory. If a training end command is given after any of the other pulse parameters (Rx, ONx or Fx) that pulse is ignored. For example, if training end command is given after ON2 pulse 2 is ignored and blinking sequence includes only pulse 1.

### 7.3.3.2 Reset to Default

If a training end command is given right after a training start command, the LP5560 is reset back to factory defaults (Figure 13). In this case the mode bit is set to 1 (run mode) with the factory-set default blinking sequence.

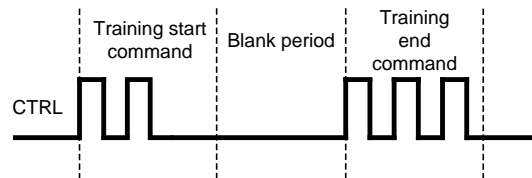

Figure 13. Reset to Default

### 7.3.3.3 Changing the LED Current

The LP5560 devices allows changing the LED output current without the need to reprogram the previously programmed blinking sequence. This is done by giving the training end command after current setting (Figure 14). In this case only the current setting changes. If a blinking sequence was programmed into the LP5560 device it remains unchanged. If mode bit was 0 (follow mode) before the training sequence it remains 0.

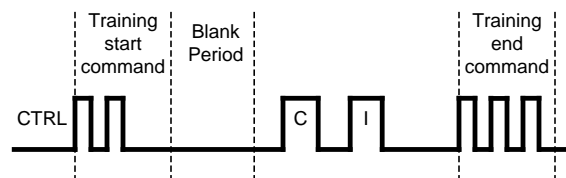

Figure 14. Current Programming Sequence

### 7.3.3.4 Entering Follow Mode

Mode bit can be set to 0 (follow mode) in two ways. If training end command is given after calibration pulse mode bit is set to 0 (follow mode) and the previously set LED output current setting remains unchanged (Figure 15).

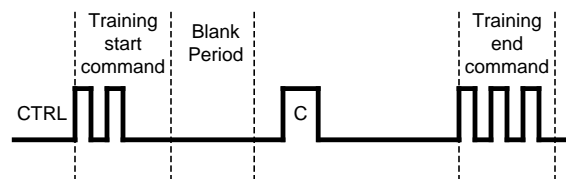

Figure 15. Entering Follow Mode

If training end command is given after R1, ON1 or F1 mode bit is set to 0 (follow mode) and new current setting is stored to current register (Figure 16). If a training end command is given after F1 CTRL low time before training end command needs to be less than minimum training pulse off time (200 μs). Otherwise off time OFF1 is set to minimum value, and pulse 1 is stored into memory.

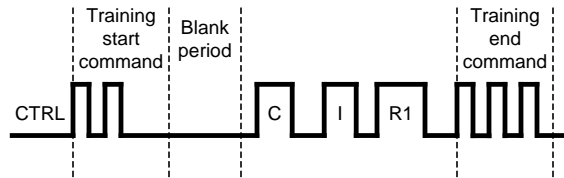

Figure 16. Entering Follow Mode With New Current Setting

### 7.3.3.5 Timeout

If during training CTRL stays constant for more than  $127 \times T_{CAL}$  time this is interpreted as timeout. For example, if calibration pulse length  $T_{CAL}$  is 1 ms, timeout time is 127 ms. Timeout ends the training sequence. Timeout is considered as a false training, and it is a good practice to always give a complete training sequence after timeout to ensure correct data is stored into memory.

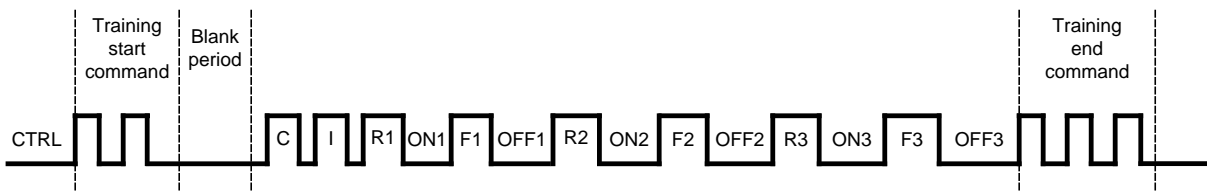

Figure 17. Full Training Sequence

### 7.3.4 LED Output Current Setting

The LED output current can be set from 2.8 mA to 19.5 mA in 7 steps. Duration of the current setting pulse (I) defines the current setting.

Table 2. LED Current Setting

CURRENT SETTING	LED CURRENT (mA)
0	2.8
1	5.3 default
2	7.8
3	10.2
4	12.6
5	15.0
6	17.3
7	19.5

### 7.3.5 Rise and Fall Time Settings

Rise and fall times of each pulse can be programmed independently. Rise and fall time can be set from 0 to 1584 ms with 105.6 ms steps. Rise and fall times are generated using a combined PWM and current control. Ramp has 32 PWM steps. For the first 8 steps LED current is decreased to 12.5%. For the remaining steps current is set to 100%. Each step is 3.3 ms long. This results in the minimum ramp time of  $3.3 \text{ ms} \times 32 = 105.6 \text{ ms}$ . When ramp time is increased each PWM step is done multiple times. When setting rise and fall times they are always rounded down. For example if calibration pulse length is 1 ms and rise time setting pulse is 2.9 ms rise time is set to 2 which is 211.2 ms. Rise and fall times can be set to zero by giving pulse that is shorter than calibration pulse.

**Table 3. Rise and Fall Time Settings**

RAMP SETTING	RAMP TIME (ms)
0	0
1	105.6
2	211.2
3	316.8
4	422.4
5	528 default
6	633.6
7	739.2
8	844.8
9	950.4
10	1056
11	1161.6
12	1267.2
13	1372.8
14	1478.4
15	1584

### 7.3.6 LED ON-Time Setting

LED on time has 5-bit control. On time can be controlled from 13.2 ms to 3009.6 ms in 31 steps. Step size is not constant to increase resolution on shorter ON times. With longer on times also the step size is increased. [Table 4](#) shows the available on times.

**Table 4. LED ON-Time Setting**

SETTING	LED ON TIME (ms)
0	13.2
1	26.4
2	52.8
3	105.6
4	158.4
5	211.2
6	264
7	316.8
8	369.6
9	435.6
10	501.6 default
11	594
12	699.6
13	805.2
14	910.8
15	1016.4
16	1122
17	1227.6
18	1353
19	1478.4
20	1603.8
21	1729.2
22	1854.6
23	1980
24	2105.4
25	2230.8
26	2356.2
27	2481.6
28	2613.6
29	2745.6
30	2877.6
31	3009.6

### 7.3.7 LED OFF-Time Setting

LED off time has also 5-bit control. Off time can be controlled from 26.4 ms to 6019.2 ms in 31 steps. Off time is always twice as long as on time with same setting.

**Table 5. LED OFF-Time Setting**

SETTING	LED OFF TIME (ms)
0	26.4
1	52.8
2	105.6
3	211.2
4	316.8
5	422.4
6	528
7	633.6
8	739.2
9	871.2
10	1003.2
11	1188
12	1399.2
13	1610.4 default
14	1821.6
15	2032.8
16	2244
17	2455.2
18	2706
19	2956.8
20	3207.6
21	3458.4
22	3709.2
23	3960
24	4210.8
25	4461.6
26	4712.4
27	4963.2
28	5227.2
29	5491.2
30	5755.2
31	6019.2



### 7.4 Device Functional Modes

**POWER-ON RESET** When input voltage is applied to VDD pin device goes through power on reset (POR). During POR defaults are set into control registers.

**STANDBY:** After POR device goes to standby. This is the low power mode when all the internal blocks are shut down.

**COMMAND ENTERING PERIOD + BLANK PERIOD:** Rising edge of the CTRL signal activates the circuit and starts a command entering period. During the command entering period all rising edges are counted. After command entering period there is a blank period when no rising edges are allowed.

**RUN:** If mode bit is 1 (run mode) and run command has been detected device goes into run mode. In run mode LP5560 generates the programmed blinking sequence.

**FOLLOW MODE:** If mode bit is 0 (follow mode) and run command or run once command has been detected LP5560 goes into follow mode. In follow mode LED stays on as long as CTRL pin is held high.

**RUN-ONCE MODE:** If run once command has been detected and mode bit is 1 (run mode) device goes into run-once mode. In run-once mode LP5560 generates the programmed blinking sequence once. CTRL must be high as long as blinking sequence is running.

**TRAINING:** If training start command has been detected device goes into training mode. In training mode a new blinking sequence can be programmed into the device.

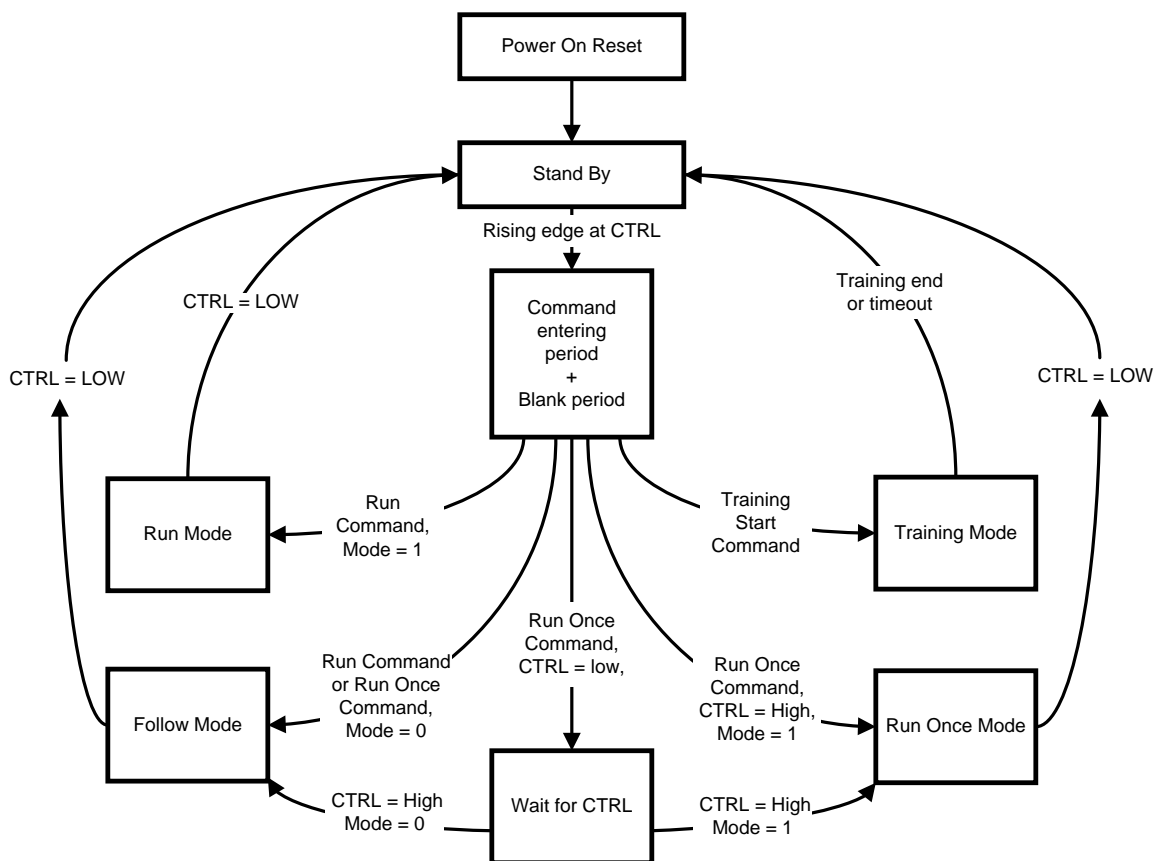

## 7.5 Programming

### 7.5.1 Default Sequence

Default blinking sequence is programmed into the LP5560 to enable the use of a device in simple systems without programming capabilities. Default sequence has a single pulse with parameters as follows:

I = 5.3 mA; R1 = 528 ms; ON1 = 501.6 ms; F1 = 528; OFF1 = 1610.4 ms

## 7.6 Registers

### 7.6.1 Control Registers

Control registers are shown only for a reference. There is no direct way to write or read these registers. Register values are set in the training mode as described earlier in the document.

**Table 6. Control Registers**

7	6	5	4	3	2	1	0
F1[3:0]				R1[3:0]			
F2[3:0]				R2[3:0]			
F3[3:0]				R3[3:0]			
MODE	NOP[1:0]			ON1[4:0]			
I_LED[2:0]				OFF1[4:0]			
n/a				ON2[4:0]			
n/a				OFF2[4:0]			
n/a				ON3[4:0]			
n/a				OFF3[4:0]			

## 8 Application and Implementation

### NOTE

Information in the following applications sections is not part of the TI component specification, and TI does not warrant its accuracy or completeness. TI's customers are responsible for determining suitability of components for their purposes. Customers should validate and test their design implementation to confirm system functionality.

### 8.1 Application Information

The LP5560 is a programmable LED driver designed to generate variety of blinking sequences for indicator LEDs. It can drive single LED with up to 19.5 mA output current. Very low headroom voltage allows driving most indicator LEDs straight from a single Li-ion battery. Default blinking sequence with one pulse is programmed into the LP5560 to enable the use of device in simple systems without programming capabilities. Pulling CTRL signal high starts the default blinking sequence. Different blinking sequences with up to three pulses can be programmed into the LP5560 through a single-wire interface. Programmable parameters include on and off times as well as rise and fall times.

### 8.2 Typical Application

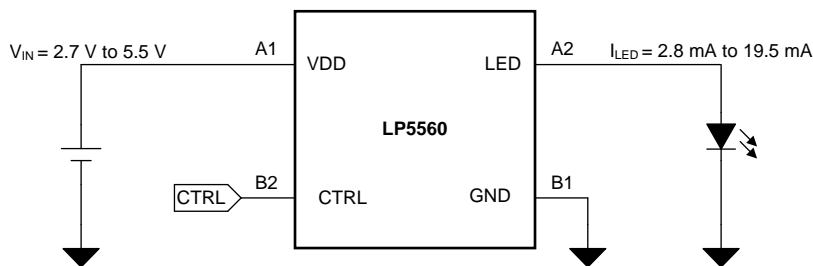

Copyright © 2016, Texas Instruments Incorporated

**Figure 18. LP5560 Typical Application**

#### 8.2.1 Design Requirements

In this example LP5560 is used to drive a blue 0406-size indicator LED with a 5.3-mA output current. For this example, use the parameters listed in [Table 7](#).

**Table 7. Design Parameters**

DESIGN PARAMETER	EXAMPLE VALUE
LED Output Current	5.3 mA
Maximum LED forward voltage at 5 mA	3.1 V
$V_{IN}$ voltage	from 3.2 V to 5.5 V

#### 8.2.2 Detailed Design Procedure

##### 8.2.2.1 Step-by-Step Design Procedure

To design in the LP5560 use the following simple design steps:

- Define the input voltage range of the system. For the LP5560 device the maximum input voltage must not exceed 5.5 V. The minimum input voltage is critical parameter for LED selection.
- Define the LED current. LED current affects the LED forward voltage and must be taken into account when selecting the LED for the application.
- Choose a LED which maximum forward voltage with desired LED current is less than minimum input voltage - 100 mV. This ensures that there is always enough headroom voltage available for the LED driver.

### 8.2.2.2 Running the Default Blinking Sequence

To run the default blinking sequence apply input voltage to VDD pin. Allow the VDD voltage settle before pulling the CTRL pin high. It is not recommended to connect the CTRL and VDD lines together. When CTRL line is pulled high the LP5560 starts to generate the default blinking sequence. [Figure 19](#) shows the LP5560 generating default sequence. Rise and fall times are generated using a combined PWM and current control. Ramp has 32 PWM steps. For the first 8 steps LED current is decreased to 12.5%. For the remaining steps current is set to 100%. Each step is 3.3 ms long. This result's the minimum ramp time of  $3.3 \text{ ms} \times 32 = 105.6 \text{ ms}$ . [Figure 22](#) shows LED current with minimum rise time. When ramp time is increased each PWM step is done multiple times. In the default sequence rise and fall times are set to 528 ms.

### 8.2.2.3 Programming New Blinking Sequence to the Memory

[Figure 22](#) shows an example of a training sequence which programs a new blinking sequence into the LP5560 memory. This example has a single pulse with 105.6 ms rise time, 105.6 ms on time, 105.6 ms fall time and 211.2 ms off time. LED current is set to 5.3 mA. Training sequence is started by giving a training start command (two rising edges within 500  $\mu\text{s}$ ). First pulse after a training start command is the calibration pulse which determines the speed of the training sequence. Note that there must always be at least 1500  $\mu\text{s}$  from the first rising edge of the training start command before calibration pulse can be given. Second pulse after the calibration pulse is the LED current setting. Note that there are *empty* low times before and after current setting pulse. For the following pulses both CTRL high and CTRL low times are used to set the parameters. Next CTRL high time defines LED current rise time setting for pulse 1 (R1). CTRL low time after R1 defines the LED on time for pulse 1 (ON1). CTRL high time after ON1 sets the LED current fall time (F1). CTRL low time after F1 sets pulse 1 off time (OFF1). The training sequence is finished with a training stop command (three rising edges within 500  $\mu\text{s}$ ). [Figure 23](#) show the LED current after programming the new pulse into the LP5560 memory.

[Figure 24](#) and [Figure 25](#) show another example of a training sequence with three pulses and the resulting blinking sequence. In this example all three pulses have different rise, on, fall, and off times. LED current is set to 10.2 mA. [Figure 26](#) show how this sequence is run only once using the run-once command. Even though the CTRL is held high for a long time the blinking sequence is only executed one time because a run-once command (four rising edges within 500  $\mu\text{s}$ ) is given at the beginning of the frame.

### 8.2.3 Application Curves

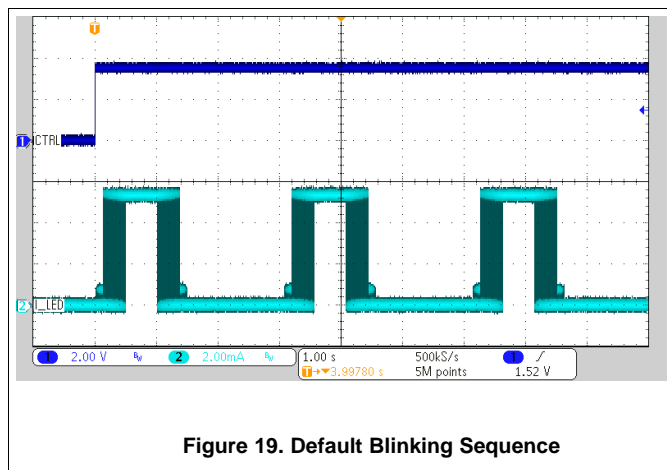

Figure 19. Default Blinking Sequence

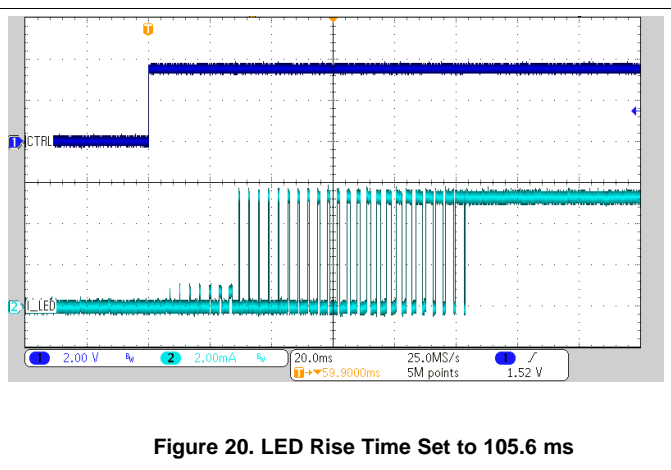

Figure 20. LED Rise Time Set to 105.6 ms

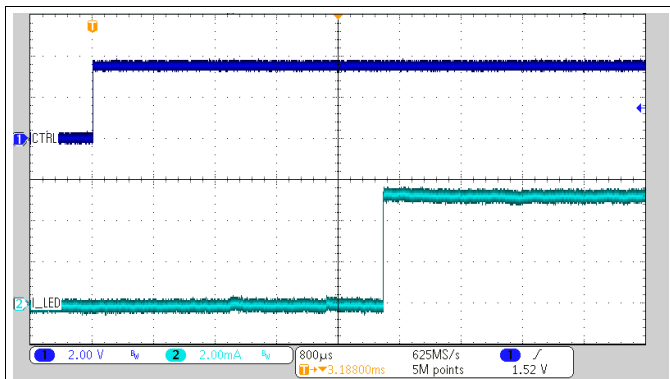

Figure 21. LED Rise Time Set to 0 ms

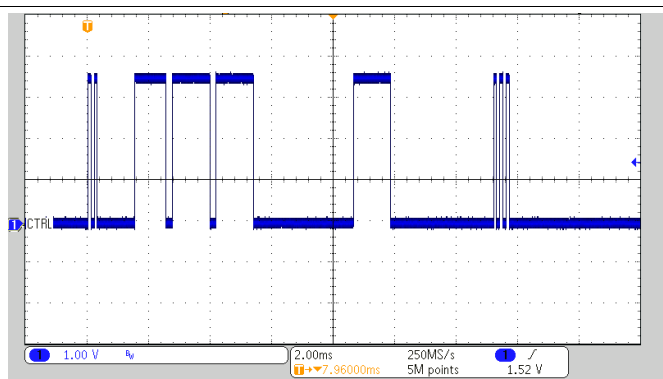

Figure 22. Example Training Sequence with One Pulse

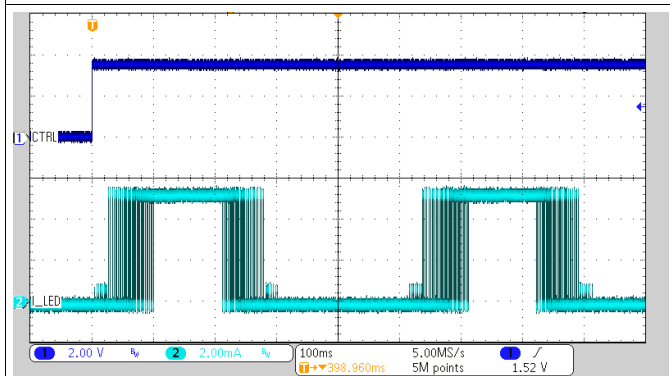

Figure 23. Example Blinking Sequence with One Pulse

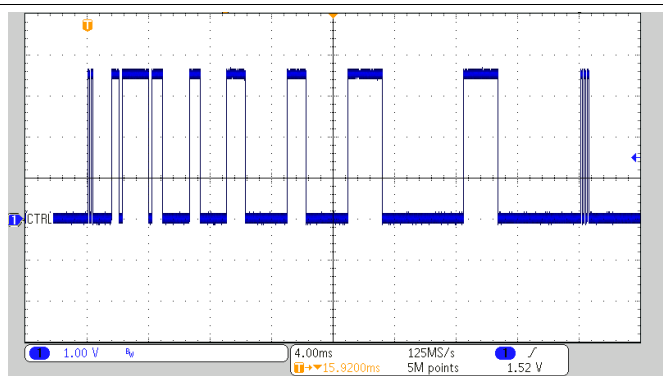

Figure 24. Example Training Sequence with Three Pulses

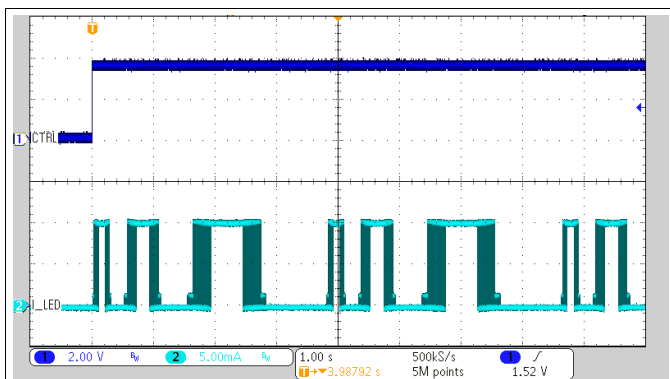

Figure 25. Example Blinking Sequence with Three Pulses

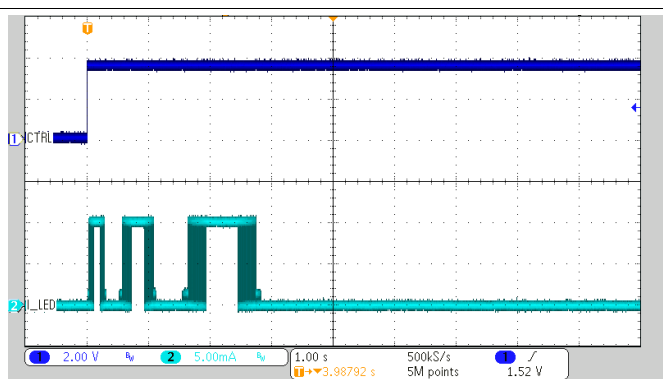

Figure 26. Run-Once Command

## 9 Power Supply Recommendations

The LP5560 is designed to operate from an input voltage supply range between 2.7 V and 5.5 V. This input supply must be well regulated. If the input voltage has high noise content TI recommends adding a dedicated ceramic bypass capacitor close to the VDD and GND pins. Depending on the selected LED it may be necessary to increase the minimum input voltage. The minimum input voltage must always be 100 mV higher than the LED maximum forward voltage.

## 10 Layout

### 10.1 Layout Guidelines

- Normally the LP5560 device does not require any external components except for the LED. However, in a noisy environment a small 0.1- $\mu\text{F}$  bypass capacitor can be connected between VIN and GND pins.
- TI recommends routing the pins in a 45-degree angle to avoid component rotation during soldering process.
- Use traces with similar width for all pins. This makes the exposed copper area similar for all pins and improves the soldering reliability.
- Obtain the minimum clearance and trace width from the manufacturer of the PCB used for the board.

### 10.2 Layout Example

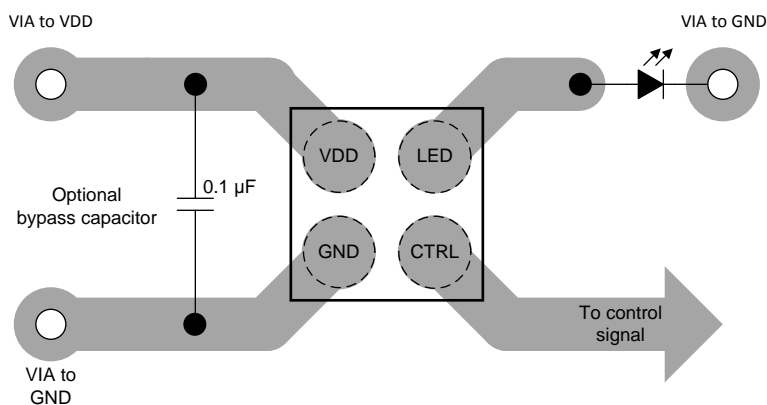

**Figure 27. LP5560 Layout Example**

## 11 器件和文档支持

### 11.1 文档支持

#### 11.1.1 相关文档

更多信息，请参见以下文档：

[AN-1112 DSBGA 晶圆级芯片级封装](#)

### 11.2 接收文档更新通知

如需接收文档更新通知，请访问 [www.ti.com.cn](http://www.ti.com.cn) 网站上的器件产品文件夹。点击右上角的提醒我 (Alert me) 注册后，即可每周定期收到已更改的产品信息。有关更改的详细信息，请查阅已修订文档中包含的修订历史记录。

### 11.3 社区资源

The following links connect to TI community resources. Linked contents are provided "AS IS" by the respective contributors. They do not constitute TI specifications and do not necessarily reflect TI's views; see TI's [Terms of Use](#).

**TI E2E™ Online Community** *TI's Engineer-to-Engineer (E2E) Community*. Created to foster collaboration among engineers. At [e2e.ti.com](http://e2e.ti.com), you can ask questions, share knowledge, explore ideas and help solve problems with fellow engineers.

**Design Support** *TI's Design Support* Quickly find helpful E2E forums along with design support tools and contact information for technical support.

### 11.4 商标

E2E is a trademark of Texas Instruments.

All other trademarks are the property of their respective owners.

### 11.5 静电放电警告



ESD 可能会损坏该集成电路。德州仪器 (TI) 建议通过适当的预防措施处理所有集成电路。如果不遵守正确的处理措施和安装程序，可能会损坏集成电路。

ESD 的损坏小至导致微小的性能降级，大至整个器件故障。精密的集成电路可能更容易受到损坏，这是因为非常细微的参数更改都可能会导致器件与其发布的规格不相符。

### 11.6 Glossary

[SLYZ022](#) — *TI Glossary*.

This glossary lists and explains terms, acronyms, and definitions.

## 12 机械、封装和可订购信息

以下页中包括机械、封装和可订购信息。这些信息是针对指定器件可提供的最新数据。这些数据会在无通知且不对本文档进行修订的情况下发生改变。欲获得该数据表的浏览器版本，请查阅左侧的导航栏。

**PACKAGING INFORMATION**

Orderable Device	Status (1)	Package Type	Package Drawing	Pins	Package Qty	Eco Plan (2)	Lead finish/ Ball material (6)	MSL Peak Temp (3)	Op Temp (°C)	Device Marking (4/5)	Samples
LP5560TME/NOPB	ACTIVE	DSBGA	YFQ	4	250	RoHS & Green	SNAGCU	Level-1-260C-UNLIM	-30 to 85		<b>Samples</b>
LP5560TMX/NOPB	ACTIVE	DSBGA	YFQ	4	3000	RoHS & Green	SNAGCU	Level-1-260C-UNLIM	-30 to 85		<b>Samples</b>

(1) The marketing status values are defined as follows:

**ACTIVE:** Product device recommended for new designs.

**LIFEBUY:** TI has announced that the device will be discontinued, and a lifetime-buy period is in effect.

**NRND:** Not recommended for new designs. Device is in production to support existing customers, but TI does not recommend using this part in a new design.

**PREVIEW:** Device has been announced but is not in production. Samples may or may not be available.

**OBSOLETE:** TI has discontinued the production of the device.

(2) **RoHS:** TI defines "RoHS" to mean semiconductor products that are compliant with the current EU RoHS requirements for all 10 RoHS substances, including the requirement that RoHS substance do not exceed 0.1% by weight in homogeneous materials. Where designed to be soldered at high temperatures, "RoHS" products are suitable for use in specified lead-free processes. TI may reference these types of products as "Pb-Free".

**RoHS Exempt:** TI defines "RoHS Exempt" to mean products that contain lead but are compliant with EU RoHS pursuant to a specific EU RoHS exemption.

**Green:** TI defines "Green" to mean the content of Chlorine (Cl) and Bromine (Br) based flame retardants meet JS709B low halogen requirements of <=1000ppm threshold. Antimony trioxide based flame retardants must also meet the <=1000ppm threshold requirement.

(3) MSL, Peak Temp. - The Moisture Sensitivity Level rating according to the JEDEC industry standard classifications, and peak solder temperature.

(4) There may be additional marking, which relates to the logo, the lot trace code information, or the environmental category on the device.

(5) Multiple Device Markings will be inside parentheses. Only one Device Marking contained in parentheses and separated by a "~" will appear on a device. If a line is indented then it is a continuation of the previous line and the two combined represent the entire Device Marking for that device.

(6) Lead finish/Ball material - Orderable Devices may have multiple material finish options. Finish options are separated by a vertical ruled line. Lead finish/Ball material values may wrap to two lines if the finish value exceeds the maximum column width.

**Important Information and Disclaimer:** The information provided on this page represents TI's knowledge and belief as of the date that it is provided. TI bases its knowledge and belief on information provided by third parties, and makes no representation or warranty as to the accuracy of such information. Efforts are underway to better integrate information from third parties. TI has taken and continues to take reasonable steps to provide representative and accurate information but may not have conducted destructive testing or chemical analysis on incoming materials and chemicals. TI and TI suppliers consider certain information to be proprietary, and thus CAS numbers and other limited information may not be available for release.

In no event shall TI's liability arising out of such information exceed the total purchase price of the TI part(s) at issue in this document sold by TI to Customer on an annual basis.





**TAPE AND REEL INFORMATION**

**QUADRANT ASSIGNMENTS FOR PIN 1 ORIENTATION IN TAPE**

\*All dimensions are nominal

Device	Package Type	Package Drawing	Pins	SPQ	Reel Diameter (mm)	Reel Width W1 (mm)	A0 (mm)	B0 (mm)	K0 (mm)	P1 (mm)	W (mm)	Pin1 Quadrant
LP5560TME/NOPB	DSBGA	YFQ	4	250	178.0	8.4	0.92	0.99	0.7	4.0	8.0	Q1
LP5560TMX/NOPB	DSBGA	YFQ	4	3000	178.0	8.4	0.92	0.99	0.7	4.0	8.0	Q1

## TAPE AND REEL BOX DIMENSIONS



\*All dimensions are nominal

Device	Package Type	Package Drawing	Pins	SPQ	Length (mm)	Width (mm)	Height (mm)
LP5560TME/NOPB	DSBGA	YFQ	4	250	208.0	191.0	35.0
LP5560TMX/NOPB	DSBGA	YFQ	4	3000	208.0	191.0	35.0



## 重要声明和免责声明

TI“按原样”提供技术和可靠性数据（包括数据表）、设计资源（包括参考设计）、应用或其他设计建议、网络工具、安全信息和其他资源，不保证没有瑕疵且不做任何明示或暗示的担保，包括但不限于对适销性、某特定用途方面的适用性或不侵犯任何第三方知识产权的暗示担保。

这些资源可供使用 TI 产品进行设计的熟练开发人员使用。您将自行承担以下全部责任：(1) 针对您的应用选择合适的 TI 产品，(2) 设计、验证并测试您的应用，(3) 确保您的应用满足相应标准以及任何其他功能安全、信息安全、监管或其他要求。

这些资源如有变更，恕不另行通知。TI 授权您仅可将这些资源用于研发本资源所述的 TI 产品的应用。严禁对这些资源进行其他复制或展示。您无权使用任何其他 TI 知识产权或任何第三方知识产权。您应全额赔偿因在这些资源的使用中对 TI 及其代表造成的任何索赔、损害、成本、损失和债务，TI 对此概不负责。

TI 提供的产品受 [TI 的销售条款](#) 或 [ti.com](#) 上其他适用条款/TI 产品随附的其他适用条款的约束。TI 提供这些资源并不会扩展或以其他方式更改 TI 针对 TI 产品发布的适用的担保或担保免责声明。

TI 反对并拒绝您可能提出的任何其他或不同的条款。

邮寄地址：Texas Instruments, Post Office Box 655303, Dallas, Texas 75265

Copyright © 2022，德州仪器 (TI) 公司