

## OPA356-Q1 200MHz CMOS 运算放大器

### 1 特性

- 符合汽车类应用要求
- 具有符合 AEC-Q100 标准的下列特性：
  - 器件温度等级：-40°C 至 125°C 环境温度范围
  - 器件 HBM ESD 分类等级 2
  - 器件 CDM ESD 分类等级 C6
- 单位增益带宽：450MHz
- 高带宽：200MHz GBW
- 高压摆率：360V/ $\mu$ s
- 低噪声：5.8 nV/ $\sqrt{\text{Hz}}$
- 出色的视频性能：
  - 差分增益：0.02%
  - 差分相位：0.05°
  - 0.1dB 增益平坦度：75MHz
- 输入范围包括接地
- 轨到轨输出（在 100mV 以内）
- 低输入偏置电流：3pA
- 热关断
- 单电源工作电压范围：2.5V 至 5.5V

### 2 应用

- 信息娱乐系统
- ADAS 系统
- 雷达
- 动态稳定控制 (DSC)

### 3 说明

OPA356-Q1 是一款高速电压反馈 CMOS 运算放大器，专为视频应用和其他需要宽带宽的应用而设计。OPA356-Q1 具有单位增益稳定性，可以驱动大输出电流。差分增益为 0.02%，而差分相位为 0.05°。静态电流只有 8.3mA。

OPA356-Q1 针对低至 2.5V ( $\pm 1.25$ V) 和高达 5.5V ( $\pm 2.75$ V) 的单电源或双电源供电运行进行了优化。OPA356-Q1 的共模输入范围的下限可扩展至低于接地电压 100mV，上限可扩展至高于  $V+ 1.5$ V。电源轨的输出摆幅在 100mV 以内，从而支持宽动态范围。

OPA356-Q1 采用 SOT23-5 封装，额定温度范围为 -40°C 至 125°C。

#### 器件信息(1)

器件型号	封装	封装尺寸 (标称值)
OPA356-Q1	SOT-23 (5)	2.90mm x 1.60mm

(1) 如需了解所有可用封装，请参阅数据表末尾的可订购产品附录。

简化原理图

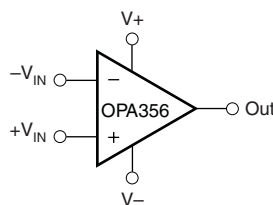

## 目录

1	特性 .....	1	7.4	Device Functional Modes.....	12
2	应用 .....	1	<b>8</b>	<b>Application and Implementation .....</b>	<b>13</b>
3	说明 .....	1	8.1	Application Information.....	13
4	修订历史记录 .....	2	8.2	Typical Applications .....	13
<b>5</b>	<b>Pin Configuration and Functions .....</b>	<b>3</b>	<b>9</b>	<b>Power Supply Recommendations .....</b>	<b>18</b>
<b>6</b>	<b>Specifications.....</b>	<b>4</b>	<b>10</b>	<b>Layout.....</b>	<b>19</b>
6.1	Absolute Maximum Ratings .....	4	10.1	Layout Guidelines .....	19
6.2	ESD Ratings.....	4	10.2	Layout Example .....	19
6.3	Recommended Operating Conditions.....	4	<b>11</b>	<b>器件和文档支持 .....</b>	<b>20</b>
6.4	Thermal Information .....	4	11.1	文档支持 .....	20
6.5	Electrical Characteristics.....	5	11.2	接收文档更新通知 .....	20
6.6	Typical Characteristics .....	6	11.3	社区资源.....	20
<b>7</b>	<b>Detailed Description .....</b>	<b>11</b>	11.4	商标.....	20
7.1	Overview .....	11	11.5	静电放电警告.....	20
7.2	Functional Block Diagram .....	11	11.6	术语表 .....	20
7.3	Feature Description.....	12	<b>12</b>	<b>机械、封装和可订购信息.....</b>	<b>20</b>

## 4 修订历史记录

注：之前版本的页码可能与当前版本有所不同。

Changes from Original (March 2009) to Revision A	Page
• 已添加 器件信息表、ESD 额定值表、热性能信息表、特性说明部分，器件功能模式部分，应用和实施部分，电源相关建议部分，布局部分，器件和文档支持部分以及机械、封装和可订购信息部分 .....	1
• 已添加 通过 AEC-Q100 认证 特性要点 .....	1
• Deleted <i>Ordering Information</i> table .....	3
• Deleted footnote 2 from <i>Absolute Maximum Ratings</i> table .....	4
• Deleted the SR, $t_r$ , $t_f$ , $t_{settle}$ , and Overload recovery time rows from the <i>Electrical Characteristics</i> table and moved to the <i>Timing Requirements</i> table .....	5
• Changed <i>Layout Guidelines</i> title from <i>PCB Layout</i> .....	19

## 5 Pin Configuration and Functions

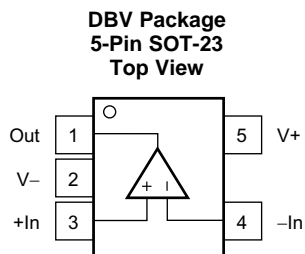

### Pin Functions

PIN		I/O	DESCRIPTION
NO.	NAME		
1	Out	O	Output pin
2	V-	—	Negative power supply
3	+In	I	Noninverting input pin
4	-In	I	Inverting input pin
5	V+	—	Positive power supply

## 6 Specifications

### 6.1 Absolute Maximum Ratings

 over operating free-air temperature range (unless otherwise noted)<sup>(1)</sup>

		MIN	MAX	UNIT
V <sub>S</sub>	Supply voltage, V+ to V–		7.5	V
V <sub>IN</sub>	Signal input pins voltage range	–0.5	(V+) + 0.5	V
	V– current		10	mA
	Output short-circuit duration <sup>(2)</sup>		Continuous	
T <sub>A</sub>	Operating free-air temperature range	–40	125	°C
T <sub>J</sub>	Junction temperature		160	°C
T <sub>stg</sub>	Storage temperature	–65	150	°C

- (1) Stresses beyond those listed under *Absolute Maximum Ratings* may cause permanent damage to the device. These are stress ratings only, which do not imply functional operation of the device at these or any other conditions beyond those indicated under *Recommended Operating Conditions*. Exposure to absolute-maximum-rated conditions for extended periods may affect device reliability.
- (2) Short-circuit to ground one amplifier per package.

### 6.2 ESD Ratings

		VALUE	UNIT
V <sub>(ESD)</sub>	Electrostatic discharge	Human-body model (HBM), per AEC Q100-002 <sup>(1)</sup>	±2000
		Charged-device model (CDM), per AEC Q100-011	±500
			V

- (1) AEC Q100-002 indicates that HBM stressing shall be in accordance with the ANSI/ESDA/JEDEC JS-001 specification.

### 6.3 Recommended Operating Conditions

over operating free-air temperature range (unless otherwise noted)

		MIN	MAX	UNIT
V <sub>S</sub>	Supply voltage, V– to V+	2.7	5.5	V
T <sub>A</sub>	Operating free-air temperature	–40	125	°C

### 6.4 Thermal Information

THERMAL METRIC <sup>(1)</sup>		OPA356-Q1	UNIT
		DBV (SOT-23)	
		5 PINS	
R <sub>θJA</sub>	Junction-to-ambient thermal resistance	185.0	°C/W
R <sub>θJC(top)</sub>	Junction-to-case (top) thermal resistance	102.5	°C/W
R <sub>θJB</sub>	Junction-to-board thermal resistance	43.9	°C/W
ψ <sub>JT</sub>	Junction-to-top characterization parameter	18.2	°C/W
ψ <sub>JB</sub>	Junction-to-board characterization parameter	43.6	°C/W
R <sub>θJC(bot)</sub>	Junction-to-case (bottom) thermal resistance	N/A	°C/W

- (1) For more information about traditional and new thermal metrics, see the [Semiconductor and IC Package Thermal Metrics](#) application report.

## 6.5 Electrical Characteristics

 $V_S = 2.7\text{ V to }5.5\text{ V}$ ,  $R_F = 604\ \Omega$ ,  $R_L = 150\ \Omega$  connected to  $V_S / 2$  (unless otherwise noted)

PARAMETER		TEST CONDITIONS	$T_A$ <sup>(1)</sup>	MIN	TYP	MAX	UNIT
$V_{OS}$	Input offset voltage	$V_S = 5\text{ V}$ , $V_{CM} = V^- + 0.8\text{ V}$	25°C		±2	±9	mV
			Full range			±15	
$\Delta V_{OS}/\Delta T$	Offset voltage drift over temperature		Full range		±7		µV/°C
PSRR	Offset voltage drift vs power supply	$V_S = 2.7\text{ V to }5.5\text{ V}$ , $V_{CM} = V_S / 2 - 0.15\text{ V}$	25°C		±80	±350	µV/V
$I_B$	Input bias current		25°C		3	±50	pA
$I_{OS}$	Input offset current		25°C		±1	±50	pA
$V_n$	Input voltage noise density	$f = 1\text{ MHz}$	25°C		5.8		nV/√Hz
$I_n$	Input current noise density	$f = 1\text{ MHz}$	25°C		50		fA/√Hz
$V_{CM}$	Input common-mode voltage range		25°C	$V^- - 0.1$		$V^+ - 1.5$	V
CMRR	Input common-mode rejection ratio	$V_S = 5.5\text{ V}$ , $-0.1\text{ V} < V_{CM} < 4\text{ V}$	25°C	66	80		dB
			Full range	66			
$Z_{ID}$	Differential input impedance		25°C		$10^{13} \parallel 1.5$		Ω    pF
$Z_{ICM}$	Common-mode input impedance		25°C		$10^{13} \parallel 1.5$		Ω    pF
$A_{OL}$	Open-loop gain	$V_S = 5\text{ V}$ , $0.3\text{ V} < V_O < 4.7\text{ V}$	25°C	84	92		dB
			Full range	80			
$f_{-3dB}$	Small-signal bandwidth	$G = 1$ , $V_O = 100\text{ mVp-p}$ , $R_F = 0\ \Omega$	25°C		450		MHz
		$G = 2$ , $V_O = 100\text{ mVp-p}$ , $R_L = 50\ \Omega$			100		
		$G = 2$ , $V_O = 100\text{ mVp-p}$ , $R_L = 150\ \Omega$			170		
		$G = 2$ , $V_O = 100\text{ mVp-p}$ , $R_L = 1\text{ k}\Omega$			200		
GBW	Gain-bandwidth product	$G = 10$ , $R_L = 1\text{ k}\Omega$	25°C		200		MHz
$f_{0.1dB}$	Bandwidth for 0.1-dB gain flatness	$G = 2$ , $V_O = 100\text{ mVp-p}$ , $R_F = 560\ \Omega$	25°C		75		MHz
SR	Slew rate	$V_S = 5\text{ V}$ , $G = 2$ , 4-V output step	25°C		+300		V/µs
					-360		
$t_r$ , $t_f$	Rise and fall times	$G = 2$ , $V_O = 200\text{ mVp-p}$ , 10% to 90%	25°C		2.4		ns
		$G = 2$ , $V_O = 2\text{ Vp-p}$ , 10% to 90%			8		
$t_{settle}$	Settling time	$V_S = 5\text{ V}$ , $G = 2$ , 2-V output step	25°C	0.1%	30		ns
				0.01%	120		
Overload recovery time		$V_{IN} \times \text{Gain} = V_S$	25°C		8		ns
Harmonic distortion	Second harmonic	$G = 2$ , $f = 1\text{ MHz}$ , $V_O = 2\text{ Vp-p}$ , $R_L = 200\ \Omega$	25°C		-81		dBc
	Third harmonic		25°C		-93		
Differential gain error		NTSC, $R_L = 150\ \Omega$	25°C		0.02%		
Differential phase error		NTSC, $R_L = 150\ \Omega$	25°C		0.05		°
Voltage output swing from rail		$V_S = 5\text{ V}$ , $R_L = 150\ \Omega$ , $A_{OL} > 84\text{ dB}$	25°C		0.2	0.3	V
		$V_S = 5\text{ V}$ , $R_L = 1\text{ k}\Omega$			0.1		
		$V_S = 5\text{ V}$ , $R_L = 50\ \Omega$			0.4	0.6	
$I_O$	Output current <sup>(2)</sup>	Continuous	25°C		±60		mA
		Peak		$V_S = 5\text{ V}$	±100		
	$V_S = 3\text{ V}$				±80		
Short-circuit current			25°C		+250	-200	mA
Closed-loop output impedance			25°C		0.02		Ω
$I_Q$	Quiescent current	$V_S = 5\text{ V}$ , $I_O = 0$	25°C		8.3	11	mA
			Full range			14	
Thermal shutdown junction temperature		Shutdown	25°C		160		°C
		Reset from shutdown			140		

(1) Full range  $T_A = -40^\circ\text{C}$  to  $125^\circ\text{C}$ .

(2) See Figure 20.

### 6.6 Typical Characteristics

$T_A = 25^\circ\text{C}$ ,  $V_S = 5\text{ V}$ ,  $G = 2$ ,  $R_F = 604\ \Omega$ ,  $R_L = 150\ \Omega$  connected to  $V_S / 2$  (unless otherwise noted)

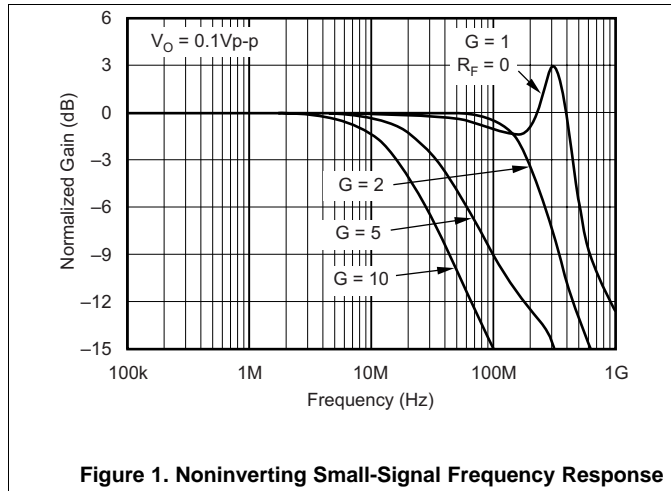

Figure 1. Noninverting Small-Signal Frequency Response

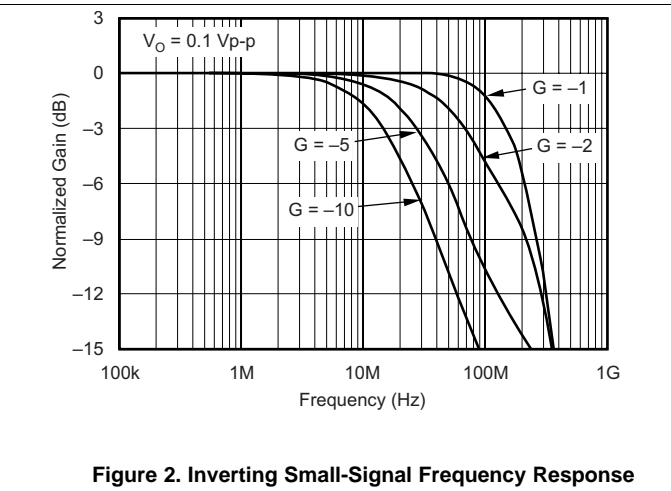

Figure 2. Inverting Small-Signal Frequency Response

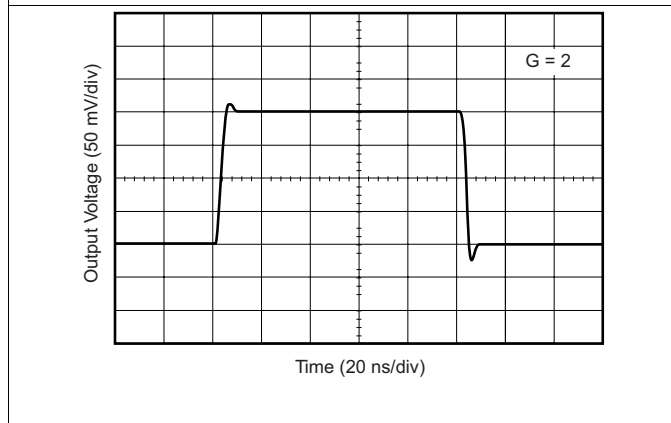

Figure 3. Noninverting Small-Signal Step Response

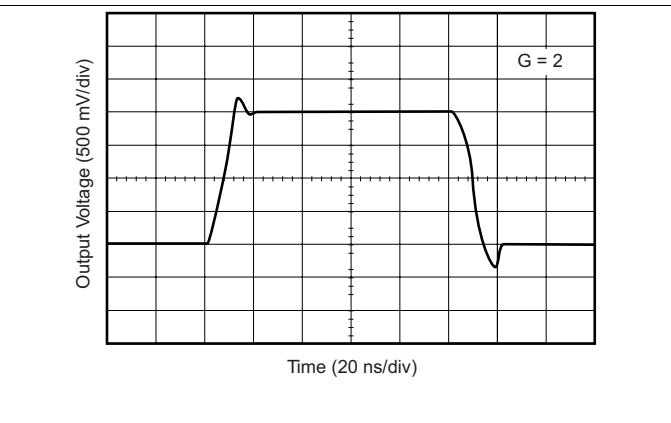

Figure 4. Noninverting Large-Signal Step Response

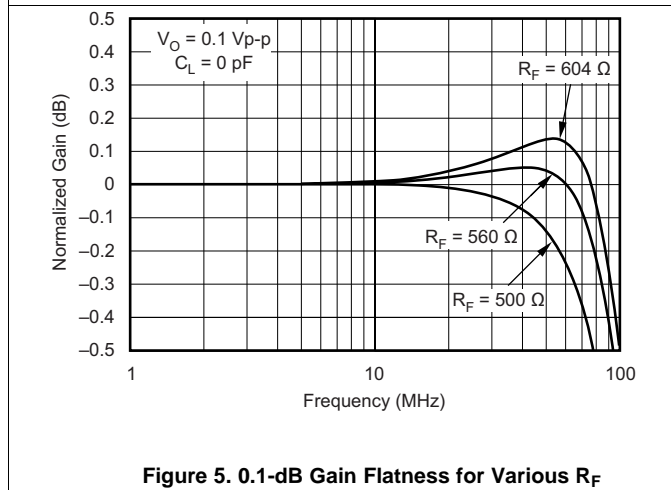

Figure 5. 0.1-dB Gain Flatness for Various  $R_F$

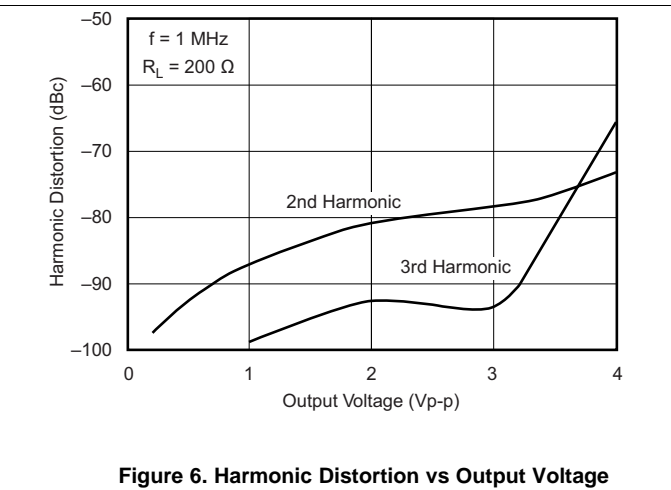

Figure 6. Harmonic Distortion vs Output Voltage

Typical Characteristics (continued)

$T_A = 25^\circ\text{C}$ ,  $V_S = 5\text{ V}$ ,  $G = 2$ ,  $R_F = 604\ \Omega$ ,  $R_L = 150\ \Omega$  connected to  $V_S / 2$  (unless otherwise noted)

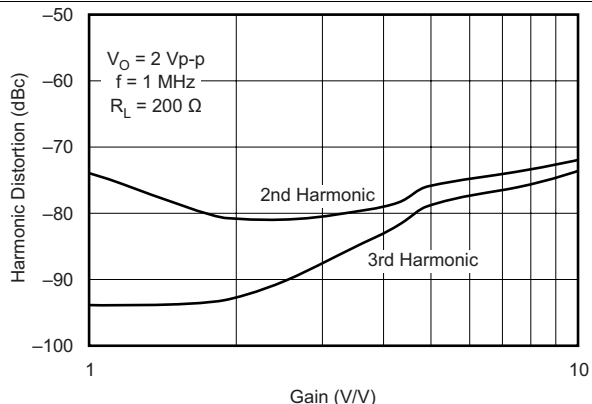

Figure 7. Harmonic Distortion vs Non-Inverting Gain

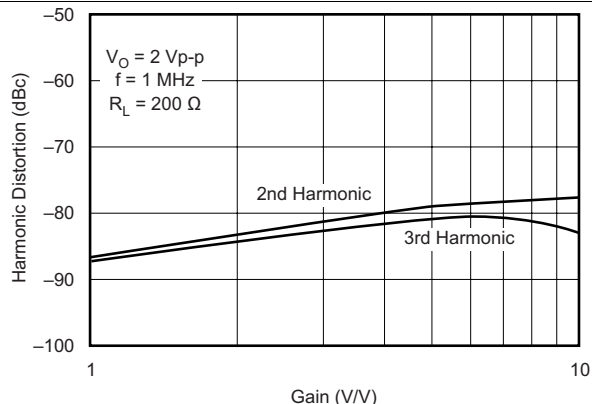

Figure 8. Harmonic Distortion vs Inverting Gain

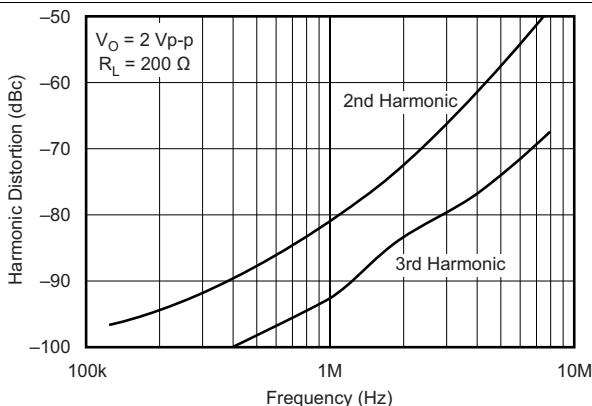

Figure 9. Harmonic Distortion vs Frequency

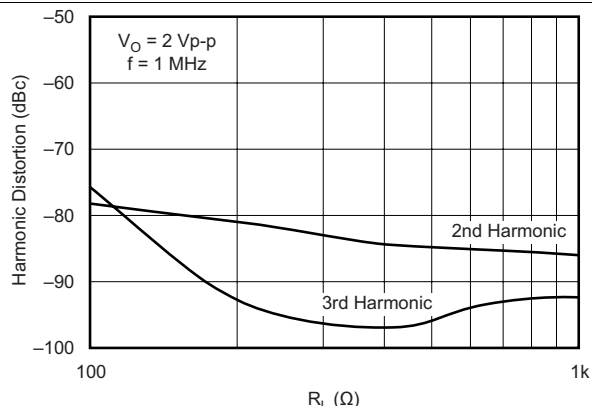

Figure 10. Harmonic Distortion vs Load Resistance

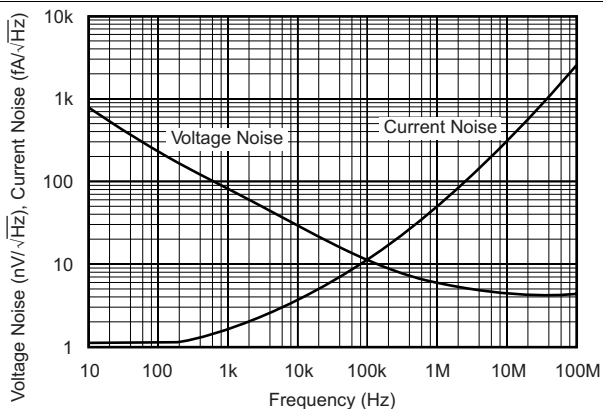

Figure 11. Input Voltage and Current Noise Spectral Density vs Frequency

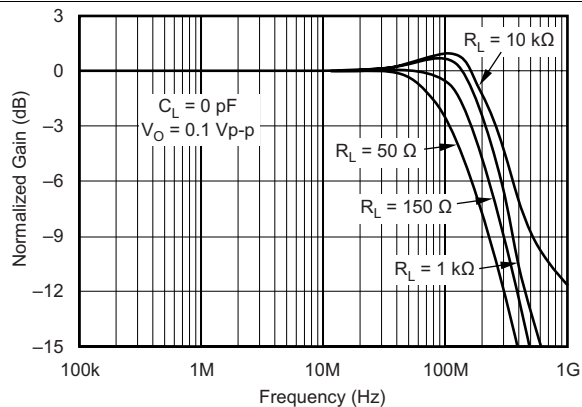

Figure 12. Frequency Response for Various  $R_L$

Typical Characteristics (continued)

$T_A = 25^\circ\text{C}$ ,  $V_S = 5\text{ V}$ ,  $G = 2$ ,  $R_F = 604\ \Omega$ ,  $R_L = 150\ \Omega$  connected to  $V_S / 2$  (unless otherwise noted)

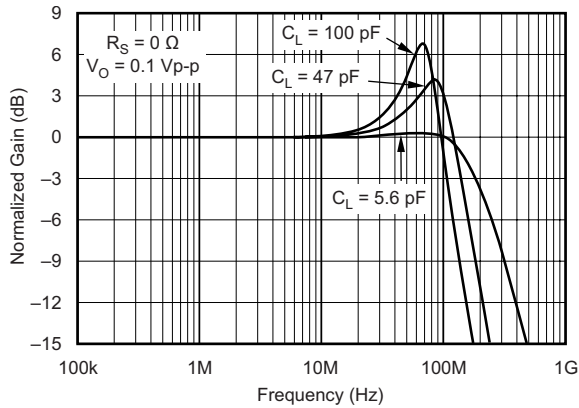

Figure 13. Frequency Response for Various  $C_L$

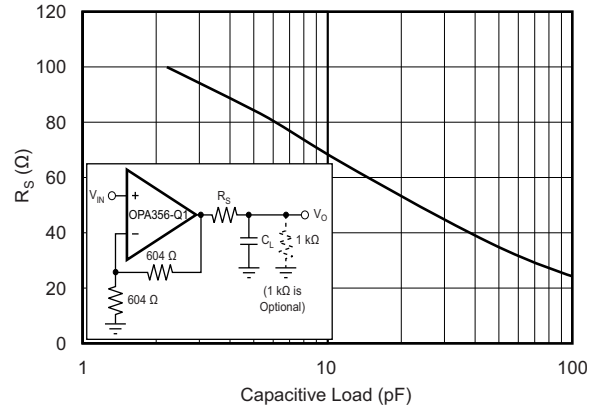

Figure 14. Recommended  $R_S$  vs Capacitive Load

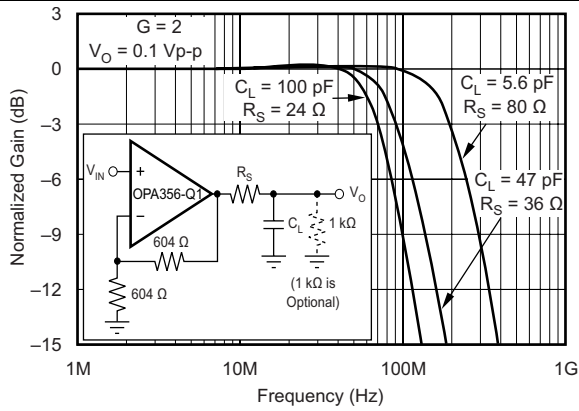

Figure 15. Frequency Response vs Capacitive Load

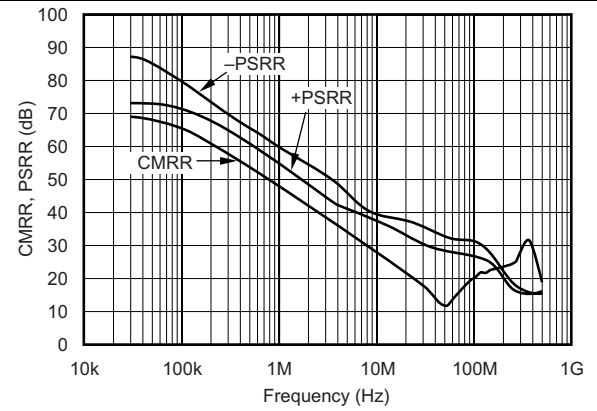

Figure 16. Common-Mode Rejection Ratio and Power-Supply Rejection Ratio vs Frequency

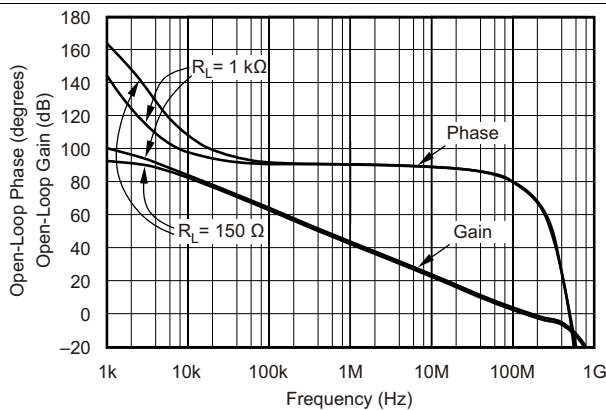

Figure 17. Open-Loop Gain and Phase

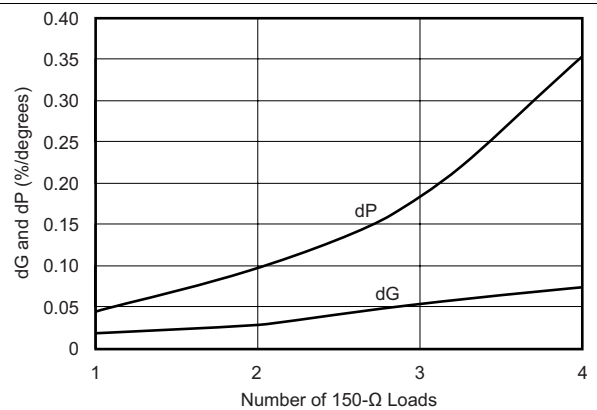
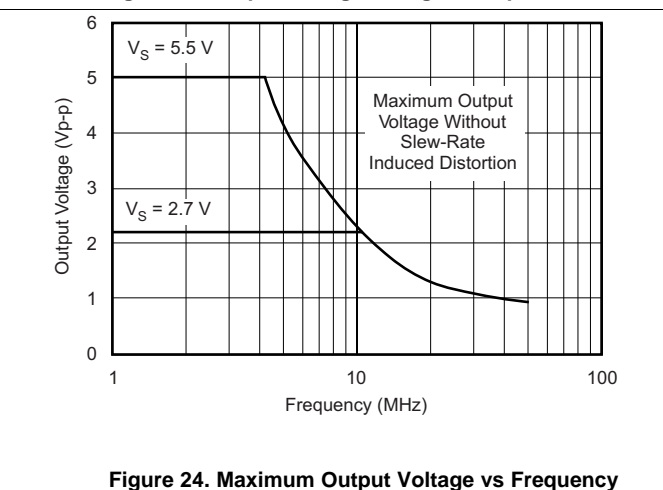
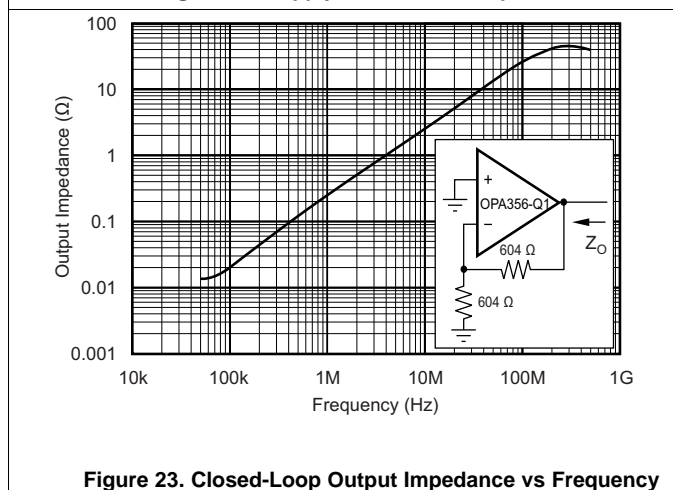
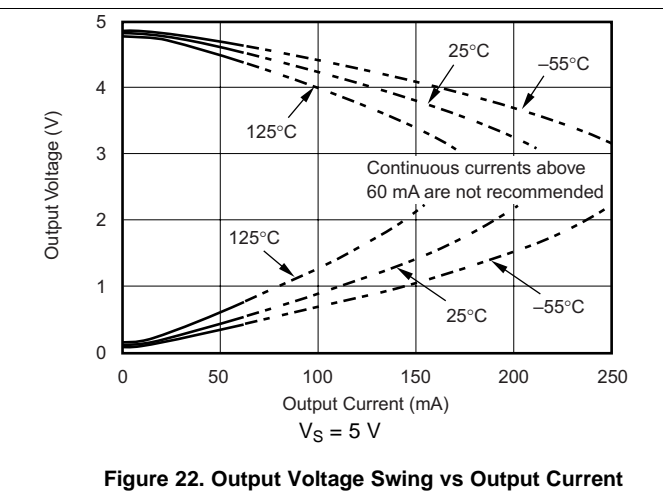
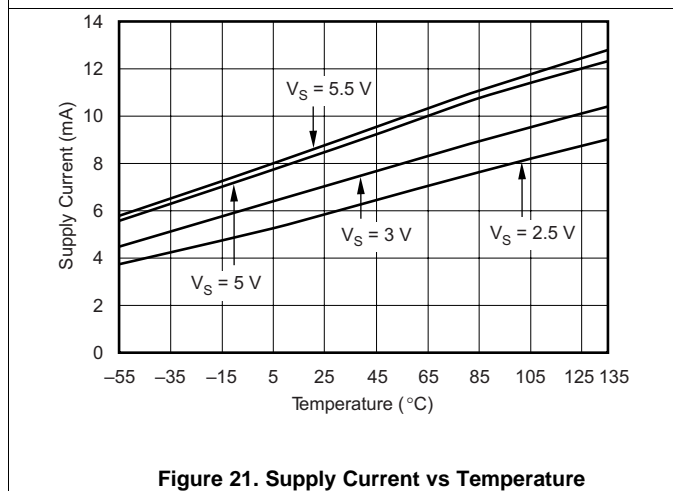
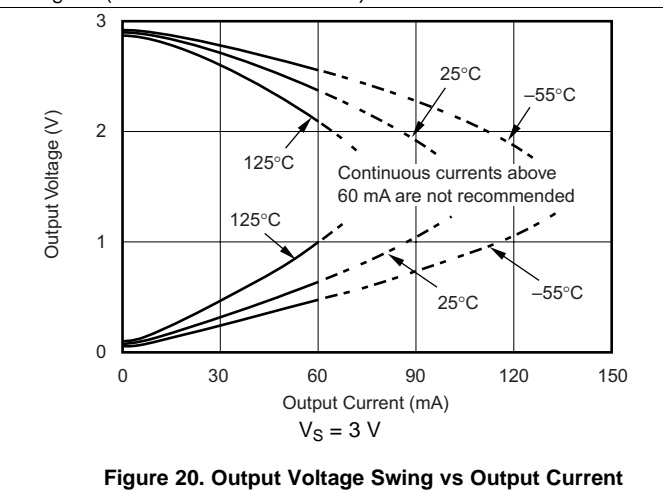
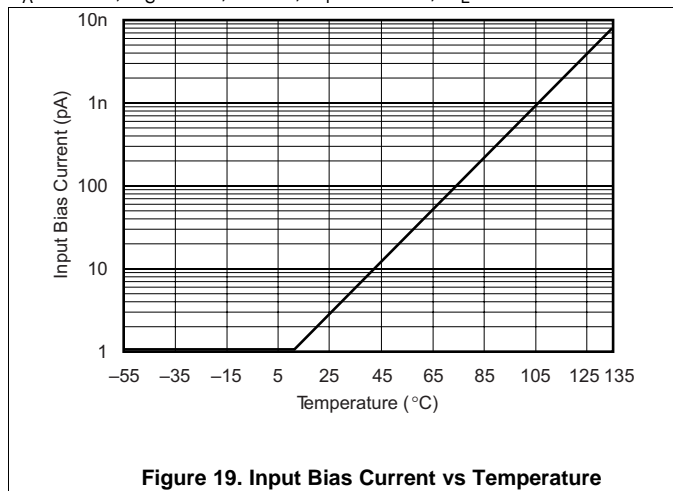

Figure 18. Composite Video Differential Gain and Phase



Typical Characteristics (continued)

$T_A = 25^\circ\text{C}$ ,  $V_S = 5\text{ V}$ ,  $G = 2$ ,  $R_F = 604\ \Omega$ ,  $R_L = 150\ \Omega$  connected to  $V_S / 2$  (unless otherwise noted)



**Typical Characteristics (continued)**

$T_A = 25^\circ\text{C}$ ,  $V_S = 5\text{ V}$ ,  $G = 2$ ,  $R_F = 604\ \Omega$ ,  $R_L = 150\ \Omega$  connected to  $V_S / 2$  (unless otherwise noted)

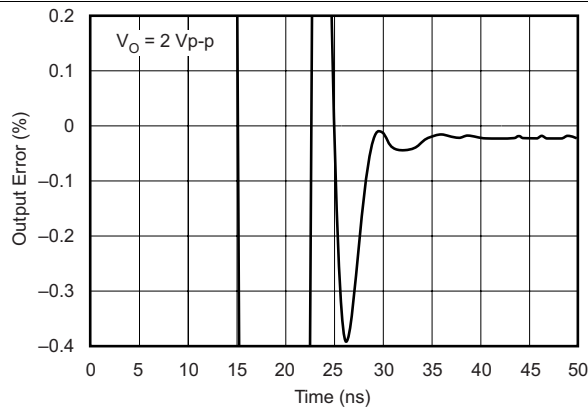

**Figure 25. Output Settling Time to 0.1%**

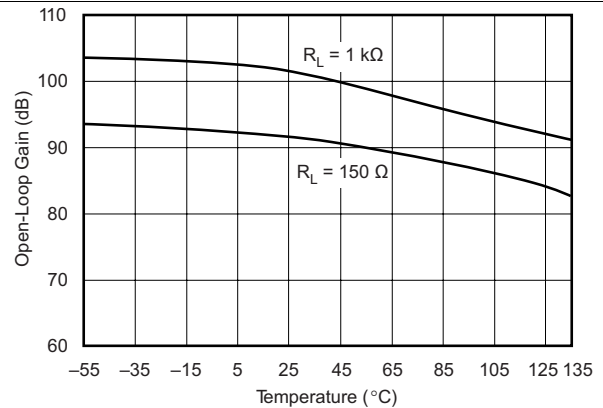

**Figure 26. Open-Loop Gain vs Temperature**

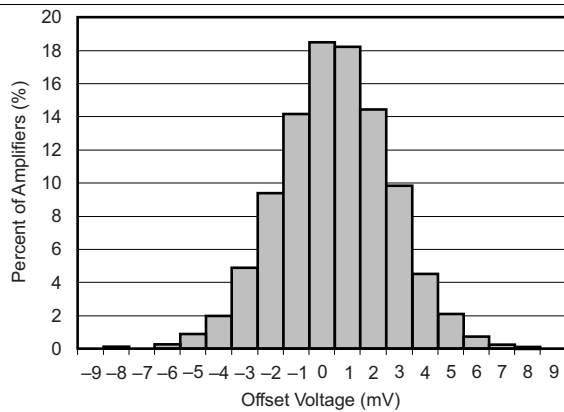

**Figure 27. Offset Voltage Production Distribution**

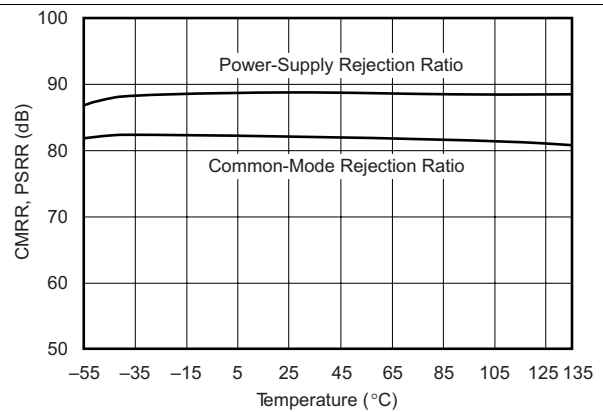

**Figure 28. Common-Mode Rejection Ratio and Power-Supply Rejection Ratio vs Temperature**

## 7 Detailed Description

### 7.1 Overview

The OPA356-Q1 operational amplifier is a high-speed, 360-V/ $\mu$ s, amplifier, making the device a great option for transimpedance applications. The device is unity-gain stable and can operate on a single-supply voltage (2.7 V to 5.5 V), or a split-supply voltage ( $\pm 1.35$  V to  $\pm 2.75$  V), making the device highly versatile and simple to use. The OPA356-Q1 amplifier is specified from 2.7 V to 5.5 V and over the automotive temperature range of  $-40^{\circ}\text{C}$  to  $+125^{\circ}\text{C}$ .

### 7.2 Functional Block Diagram

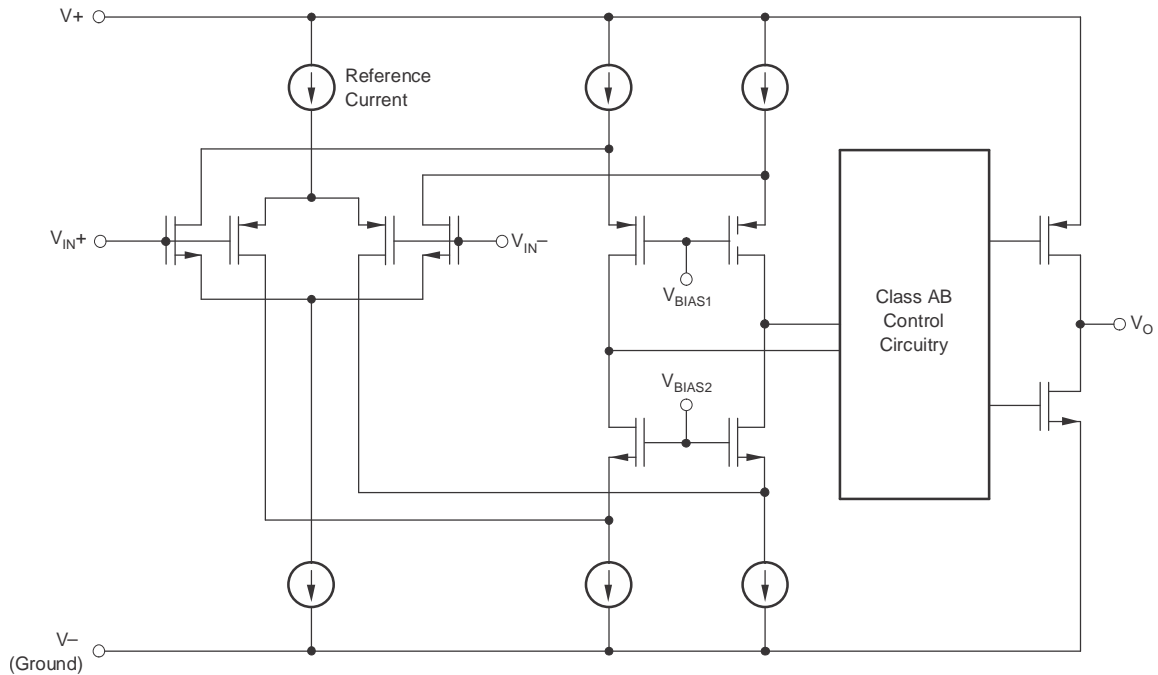

## 7.3 Feature Description

### 7.3.1 Operating Voltage

The OPA356-Q1 is specified over a power-supply range of 2.7 V to 5.5 V ( $\pm 1.35$  V to  $\pm 2.75$  V). However, the supply voltage may range from 2.5 V to 5.5 V ( $\pm 1.25$  V to  $\pm 2.75$  V). Supply voltages higher than 7.5 V (absolute maximum) can permanently damage the amplifier.

Parameters that vary significantly over supply voltage or temperature are shown in the [Typical Characteristics](#) section of this data sheet.

### 7.3.2 Output Drive

The output stage of the OPA356-Q1 is capable of driving a standard back-terminated 75- $\Omega$  video cable. A back-terminated transmission line does not exhibit a capacitive load to its driver. A properly back-terminated 75- $\Omega$  cable does not appear as capacitance; the cable presents only a 150- $\Omega$  resistive load to the OPA356-Q1 output.

The output stage can supply high short-circuit current (typically over 200 mA). Therefore, an on-chip thermal shutdown circuit is provided to protect the OPA356-Q1 from dangerously high junction temperatures. At 160°C, the protection circuit shuts down the amplifier. Normal operation resumes when the junction temperature cools to below 140°C.

---

#### NOTE

TI does not recommend running a continuous dc current in excess of  $\pm 60$  mA. See [Figure 20](#) in the [Typical Characteristics](#) section.

---

## 7.4 Device Functional Modes

The OPA356-Q1 is powered on when the supply is connected. The device can operate as a single-supply operational amplifier or dual-supply amplifier depending on the application. The device can also be used with asymmetrical supplies as long as the differential voltage ( $V_-$  to  $V_+$ ) is at least 1.8 V and no greater than 5.5 V (for example,  $V_-$  is set to  $-3.5$  V and  $V_+$  is set to 1.5 V).

## 8 Application and Implementation

### 8.1 Application Information

The OPA355-Q1 is a CMOS, high-speed, voltage-feedback, operational amplifier (op-amp) designed for general-purpose applications.

The amplifier features a 200-MHz gain bandwidth and 300-V/ $\mu$ s slew rate, but the device is unity-gain stable and operates as a 1-V/V voltage follower.

The input common-mode voltage range of the device includes ground, which allows the OPA356-Q1 to be used in virtually any single-supply application up to a supply voltage of 5.5 V.

### 8.2 Typical Applications

#### 8.2.1 Transimpedance Amplifier

Wide gain bandwidth, low input bias current, low input voltage, and current noise make the OPA356-Q1 a preferred wideband photodiode transimpedance amplifier. Low-voltage noise is important because photodiode capacitance causes the effective noise gain of the circuit to increase at high frequency.

The key elements to a transimpedance design, as shown in Figure 29, are the expected diode capacitance ( $C_{(D)}$ ), which must include the parasitic input common-mode and differential-mode input capacitance (4 pF + 5 pF), the desired transimpedance gain ( $R_{(FB)}$ ), and the gain-bandwidth (GBW) for the OPA356-Q1 (20 MHz). With these three variables set, the feedback capacitor value ( $C_{(FB)}$ ) is set to control the frequency response.  $C_{(FB)}$  includes the stray capacitance of  $R_{(FB)}$ , which is 0.2 pF for a typical surface-mount resistor.

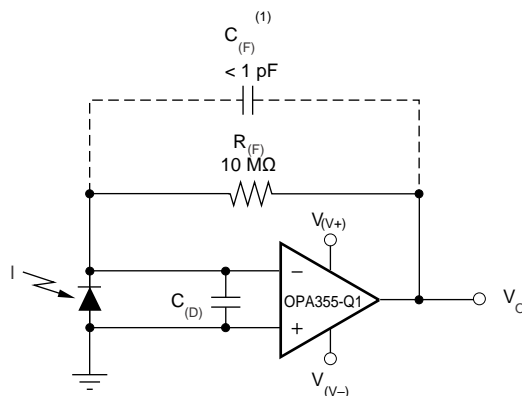

(1)  $C_{(FB)}$  is optional to prevent gain peaking.  $C_{(FB)}$  includes the stray capacitance of  $R_{(FB)}$ .

Figure 29. Dual-Supply Transimpedance Amplifier

#### 8.2.1.1 Design Requirements

PARAMETER	VALUE
Supply voltage $V_{(V+)}$	2.5 V
Supply voltage $V_{(V-)}$	-2.5 V

#### 8.2.1.2 Detailed Design Procedure

To achieve a maximally-flat, second-order Butterworth frequency response, the feedback pole must be set to:

$$\frac{1}{2 \times \pi \times R_{(FB)} \times C_{(FB)}} = \sqrt{\frac{\text{GBW}}{4 \times \pi \times R_{(FB)} \times C_{(D)}}} \quad (1)$$

Use Equation 2 to calculate the bandwidth.

$$f_{(-3 \text{ dB})} = \sqrt{\frac{\text{GBW}}{2 \times \pi \times R_{(FB)} \times C_{(D)}}} \quad (2)$$

For other transimpedance bandwidths, consider the high-speed CMOS [OPA380](#) (90-MHz GBW), [OPA354](#) (100-MHz GBW), [OPA300](#) (180-MHz GBW), [OPA355](#) (200-MHz GBW), or [OPA656](#) and [OPA657](#) (400-MHz GBW).

For single-supply applications, the +INx input can be biased with a positive DC voltage to allow the output to reach true zero when the photodiode is not exposed to any light, and respond without the added delay that results from coming out of the negative rail; this configuration is shown in [Figure 30](#). This bias voltage appears across the photodiode, providing a reverse bias for faster operation.

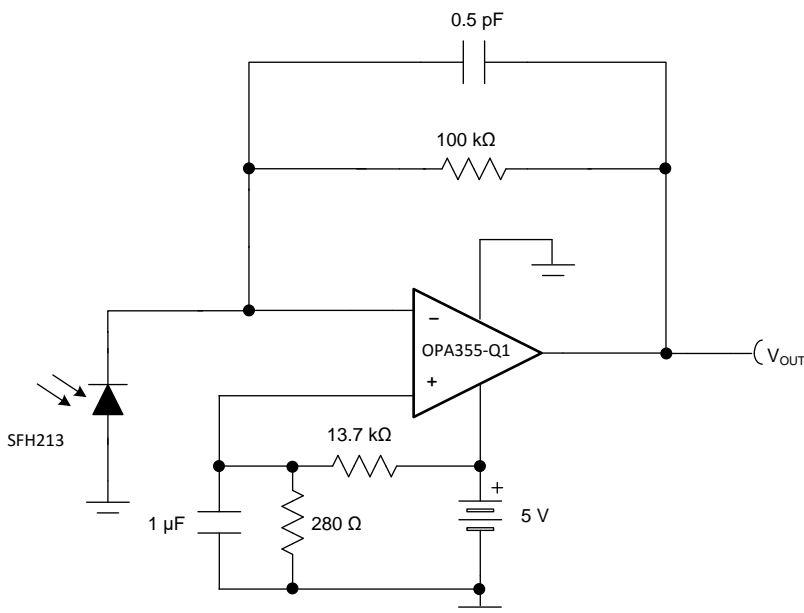

**Figure 30. Single-Supply Transimpedance Amplifier**

For additional information, see the [Compensate Transimpedance Amplifiers Intuitively](#) application bulletin.

#### 8.2.1.2.1 Optimizing The Transimpedance Circuit

To achieve the best performance, select components according to the following guidelines:

1. For lowest noise, select  $R_{(FB)}$  to create the total required gain. Using a lower value for  $R_{(FB)}$  and adding gain after the transimpedance amplifier generally produces poorer noise performance. The noise produced by  $R_{(FB)}$  increases with the square-root of  $R_{(FB)}$ , whereas the signal increases linearly. Therefore, signal-to-noise ratio improves when all the required gain is placed in the transimpedance stage.
2. Minimize photodiode capacitance and stray capacitance at the summing junction (inverting input). This capacitance causes the voltage noise of the op amp to amplify (increasing amplification at high frequency). Using a low-noise voltage source to reverse-bias a photodiode can significantly reduce the capacitance. Smaller photodiodes have lower capacitance. Use optics to concentrate light on a small photodiode.
3. Noise increases with increased bandwidth. Limit the circuit bandwidth to only that required. Use a capacitor across the  $R_{(FB)}$  to limit bandwidth, even if not required for stability.
4. Circuit board leakage can degrade the performance of an otherwise well-designed amplifier. Clean the circuit board carefully. A circuit board guard trace that encircles the summing junction and is driven at the same voltage can help control leakage.

For additional information, see the [Noise Analysis of FET Transimpedance Amplifiers](#) and [Noise Analysis for High-Speed Op Amps](#) application bulletins).

### 8.2.1.3 Application Curve

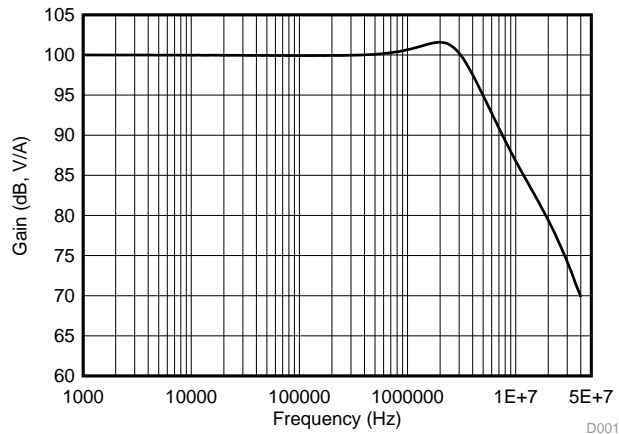

-3 dB bandwidth is 4.56 MHz

Figure 31. AC Transfer Function

### 8.2.2 High-Impedance Sensor Interface

Many sensors have high source impedances that may range up to 10 MΩ, or even higher. The output signal of sensors often must be amplified or otherwise conditioned by means of an amplifier. The input bias current of this amplifier can load the sensor output and cause a voltage drop across the source resistance, as shown in Figure 32, where  $V_{(+INx)} = V_S - I_{(BIAS)} \times R_{(S)}$ . The last term,  $I_{(BIAS)} \times R_{(S)}$ , shows the voltage drop across  $R_{(S)}$ . To prevent errors introduced to the system as a result of this voltage, an op amp with very low input bias current must be used with high impedance sensors. This low current keeps the error contribution by  $I_{(BIAS)} \times R_{(S)}$  less than the input voltage noise of the amplifier, so that the input voltage noise does not become the dominant noise factor. The OPA356-Q1 op amp features very low input bias current (typically 200 fA), and is therefore a preferred choice for such applications.

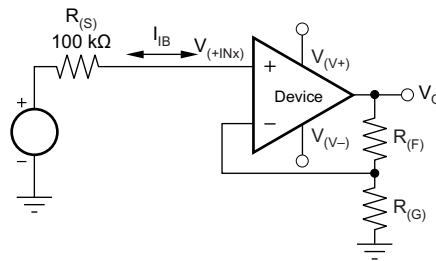
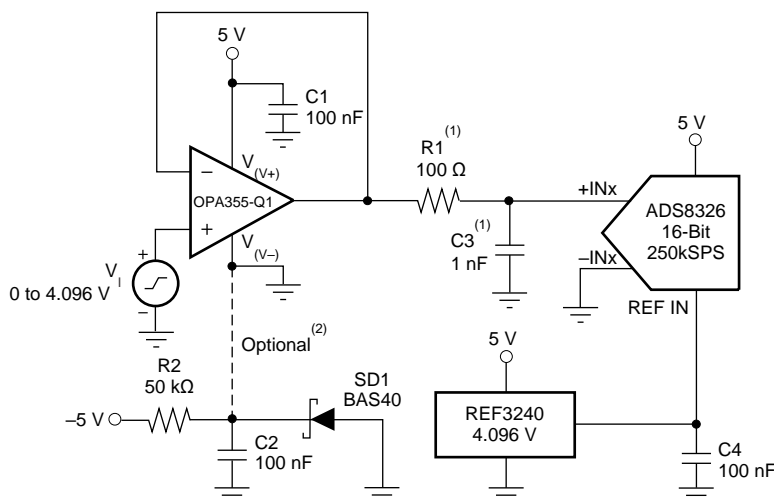

Figure 32. Noise as a Result of  $I_{(BIAS)}$

### 8.2.3 Driving ADCs

The OPA356-Q1 op amps are designed for driving sampling analog-to-digital converters (ADCs) with sampling speeds up to 1 MSPS. The zero-crossover distortion input stage topology allows the OPA356-Q1 to drive ADCs without degradation of differential linearity and THD.

The OPA356-Q1 can be used to buffer the ADC switched input capacitance and resulting charge injection while providing signal gain. Figure 33 shows the OPA356-Q1 configured to drive the ADS8326.



(1) Suggested value; may require adjustment based on specific application.

(2) Single-supply applications lose a small number of ADC codes near ground as a result of op amp output swing limitation. If a negative power supply is available, this simple circuit creates a  $-0.3\text{-V}$  supply to allow output swing to true ground potential.

**Figure 33. Driving the ADS8326**

### 8.2.4 Active Filter

The OPA356-Q1 is designed for active filter applications that require a wide bandwidth, fast slew rate, low-noise, single-supply operational amplifier. Figure 34 depicts a 500-kHz, second-order, low-pass filter using the multiple-feedback (MFB) topology. The components are selected to provide a maximally-flat Butterworth response. Beyond the cutoff frequency, roll-off is  $-40\text{ dB/dec}$ . The Butterworth response is preferred for applications requiring predictable gain characteristics, such as the anti-aliasing filter used in front of an ADC.

One point to observe when considering the MFB filter is that the output is inverted, relative to the input. If this inversion is not required, or not desired, a noninverting output can be achieved through one of the following options:

1. Adding an inverting amplifier
2. Adding an additional second-order MFB stage
3. Using a noninverting filter topology, such as the Sallen-Key (see Figure 35).

MFB and Sallen-Key, low-pass and high-pass filter synthesis is quickly accomplished using TI's FilterPro™ program. This software is available as a free download at [www.ti.com](http://www.ti.com).



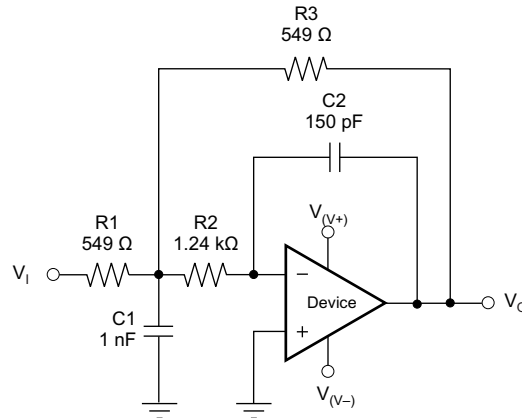

Figure 34. Second-Order Butterworth 500-kHz Low-Pass Filter

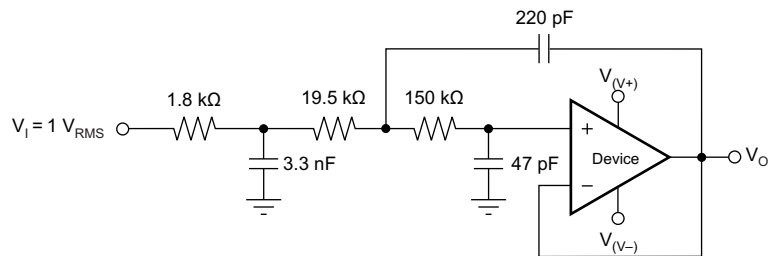

Figure 35. OPA356-Q1 Configured as a Three-Pole, 20-kHz, Sallen-Key Filter

## 9 Power Supply Recommendations

The OPA356-Q1 is specified for operation from 2.7 to 5.5 V ( $\pm 1.35$  to  $\pm 2.75$  V); many specifications apply from  $-40^{\circ}\text{C}$  to  $+125^{\circ}\text{C}$ . Parameters that can exhibit significant variance with regard to operating voltage or temperature are shown in the [Typical Characteristics](#) section.

Place 0.1- $\mu\text{F}$  bypass capacitors close to the power-supply pins to reduce errors coupling in from noisy or high-impedance power supplies. For more detailed information on bypass capacitor placement, see the [Layout Guidelines](#) section.

Power dissipation depends on power-supply voltage, signal and load conditions. With DC signals, power dissipation is equal to the product of output current times the voltage across the conducting output transistor,  $V_S - V_O$ . Minimize power dissipation by using the lowest possible power-supply voltage required to ensure the required output voltage swing.

For resistive loads, the maximum power dissipation occurs at a DC output voltage of one-half the power-supply voltage. Dissipation with AC signals is lower. Application bulletin AB-039, *Power Amplifier Stress and Power Handling Limitations* explains how to calculate or measure power dissipation with unusual signals and loads, and is available on [www.ti.com](http://www.ti.com).

Any tendency to activate the thermal protection circuit indicates excessive power dissipation or an inadequate heat sink. For reliable operation, limit junction temperature to  $150^{\circ}\text{C}$  maximum. To estimate the margin of safety in a complete design, increase the ambient temperature to trigger the thermal protection at  $160^{\circ}\text{C}$ . The thermal protection must trigger more than  $35^{\circ}\text{C}$  above the maximum expected ambient condition of the application.

## 10 Layout

### 10.1 Layout Guidelines

- Good high-frequency PC board layout techniques should be employed for the OPA356-Q1. Generous use of ground planes, short direct signal traces, and a suitable bypass capacitor located at the V+ pin assure clean, stable operation. Large areas of copper also provide a means of dissipating heat that is generated within the amplifier in normal operation.
- Sockets are definitely not recommended for use with any high-speed amplifier.
- A 10- $\mu$ F ceramic bypass capacitor is the minimum recommended value; adding a 1- $\mu$ F or larger tantalum capacitor in parallel can be beneficial when driving a low-resistance load. Providing adequate bypass capacitance is essential to achieving very low harmonic and intermodulation distortion.

### 10.2 Layout Example

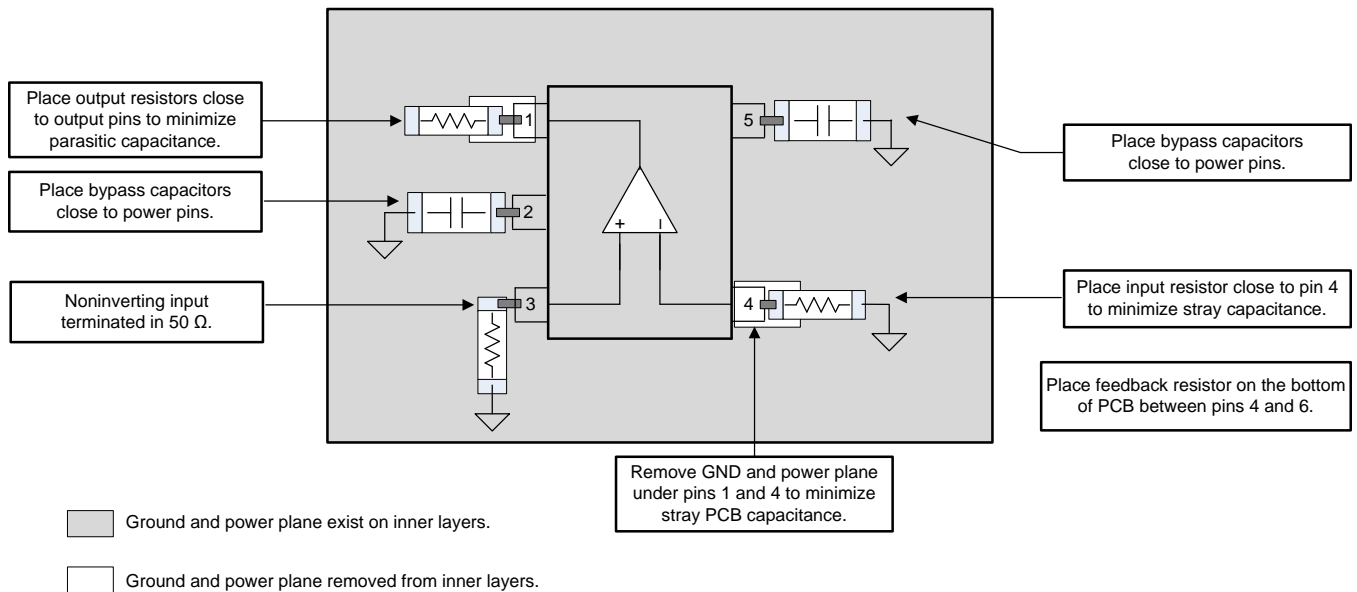

Figure 36. Example Layout

## 11 器件和文档支持

### 11.1 文档支持

#### 11.1.1 相关文档

请参阅如下相关文档：

- 《[OPAx380 精密高速跨阻放大器](#)》
- 《[OPAx354 250MHz、轨至轨 I/O CMOS 运算放大器](#)》
- 《[OPAx300 低噪声高速 16 位精确 CMOS 运算放大器](#)》
- 《[具有关断功能的 OPAx355 200MHz CMOS 运算放大器](#)》
- 《[OPA656 宽带单位增益稳定 FET 输入运算放大器](#)》
- 《[OPA657 1.6GHz、低噪声、FET 输入运算放大器](#)》
- 《[用直观方式补偿跨阻放大器](#)》
- 《[FET 跨阻放大器噪声分析](#)》
- 《[高速运算放大器噪声分析](#)》
- 《[ADS8326 16 位、2.7V 至 5.5V 高速低功耗采样模数转换器](#)》
- [FilterPro™](#)

#### 11.2 接收文档更新通知

如需接收文档更新通知，请访问 [TI.com.cn](http://TI.com.cn) 网站上的器件产品文件夹。单击右上角的通知我进行注册，即可每周接收产品信息更改摘要。有关更改的详细信息，请查看任何已修订文档中包含的修订历史记录。

#### 11.3 社区资源

下列链接提供到 TI 社区资源的连接。链接的内容由各个分销商“按照原样”提供。这些内容并不构成 TI 技术规范，并且不一定反映 TI 的观点；请参阅 TI 的《[使用条款](#)》。

**TI E2E™ 在线社区** [TI 的工程师对工程师 \(E2E\) 社区](#)。此社区的创建目的在于促进工程师之间的协作。在 [e2e.ti.com](http://e2e.ti.com) 中，您可以咨询问题、分享知识、拓展思路并与同行工程师一道帮助解决问题。

**设计支持** [TI 参考设计支持](#) 可帮助您快速查找有帮助的 E2E 论坛、设计支持工具以及技术支持的联系信息。

#### 11.4 商标

E2E is a trademark of Texas Instruments.

FilterPro is a trademark of Texas Instruments Incorporated.

All other trademarks are the property of their respective owners.

#### 11.5 静电放电警告



ESD 可能会损坏该集成电路。德州仪器 (TI) 建议通过适当的预防措施处理所有集成电路。如果不遵守正确的处理措施和安装程序，可能会损坏集成电路。

ESD 的损坏小至导致微小的性能降级，大至整个器件故障。精密的集成电路可能更容易受到损坏，这是因为非常细微的参数更改都可能会导致器件与其发布的规格不相符。

#### 11.6 术语表

**SLYZ022** — [TI 术语表](#)。

这份术语表列出并解释术语、缩写和定义。

## 12 机械、封装和可订购信息

以下页面包含机械、封装和可订购信息。这些信息是指定器件的最新可用数据。数据如有变更，恕不另行通知，且不会对此文档进行修订。如需获取此数据表的浏览器版本，请参阅左侧的导航栏。

**PACKAGING INFORMATION**

Orderable Device	Status (1)	Package Type	Package Drawing	Pins	Package Qty	Eco Plan (2)	Lead finish/ Ball material (6)	MSL Peak Temp (3)	Op Temp (°C)	Device Marking (4/5)	Samples
OPA356AQDBVRQ1	ACTIVE	SOT-23	DBV	5	3000	RoHS & Green	NIPDAU	Level-2-260C-1 YEAR	-40 to 125	OOVQ	Samples

(1) The marketing status values are defined as follows:

**ACTIVE:** Product device recommended for new designs.

**LIFEBUY:** TI has announced that the device will be discontinued, and a lifetime-buy period is in effect.

**NRND:** Not recommended for new designs. Device is in production to support existing customers, but TI does not recommend using this part in a new design.

**PREVIEW:** Device has been announced but is not in production. Samples may or may not be available.

**OBSOLETE:** TI has discontinued the production of the device.

(2) **RoHS:** TI defines "RoHS" to mean semiconductor products that are compliant with the current EU RoHS requirements for all 10 RoHS substances, including the requirement that RoHS substance do not exceed 0.1% by weight in homogeneous materials. Where designed to be soldered at high temperatures, "RoHS" products are suitable for use in specified lead-free processes. TI may reference these types of products as "Pb-Free".

**RoHS Exempt:** TI defines "RoHS Exempt" to mean products that contain lead but are compliant with EU RoHS pursuant to a specific EU RoHS exemption.

**Green:** TI defines "Green" to mean the content of Chlorine (Cl) and Bromine (Br) based flame retardants meet JS709B low halogen requirements of <=1000ppm threshold. Antimony trioxide based flame retardants must also meet the <=1000ppm threshold requirement.

(3) MSL, Peak Temp. - The Moisture Sensitivity Level rating according to the JEDEC industry standard classifications, and peak solder temperature.

(4) There may be additional marking, which relates to the logo, the lot trace code information, or the environmental category on the device.

(5) Multiple Device Markings will be inside parentheses. Only one Device Marking contained in parentheses and separated by a "-" will appear on a device. If a line is indented then it is a continuation of the previous line and the two combined represent the entire Device Marking for that device.

(6) Lead finish/Ball material - Orderable Devices may have multiple material finish options. Finish options are separated by a vertical ruled line. Lead finish/Ball material values may wrap to two lines if the finish value exceeds the maximum column width.

**Important Information and Disclaimer:** The information provided on this page represents TI's knowledge and belief as of the date that it is provided. TI bases its knowledge and belief on information provided by third parties, and makes no representation or warranty as to the accuracy of such information. Efforts are underway to better integrate information from third parties. TI has taken and continues to take reasonable steps to provide representative and accurate information but may not have conducted destructive testing or chemical analysis on incoming materials and chemicals. TI and TI suppliers consider certain information to be proprietary, and thus CAS numbers and other limited information may not be available for release.

In no event shall TI's liability arising out of such information exceed the total purchase price of the TI part(s) at issue in this document sold by TI to Customer on an annual basis.

**TAPE AND REEL INFORMATION**

**QUADRANT ASSIGNMENTS FOR PIN 1 ORIENTATION IN TAPE**

\*All dimensions are nominal

Device	Package Type	Package Drawing	Pins	SPQ	Reel Diameter (mm)	Reel Width W1 (mm)	A0 (mm)	B0 (mm)	K0 (mm)	P1 (mm)	W (mm)	Pin1 Quadrant
OPA356AQDBVRQ1	SOT-23	DBV	5	3000	178.0	9.0	3.3	3.2	1.4	4.0	8.0	Q3

TAPE AND REEL BOX DIMENSIONS



\*All dimensions are nominal

Device	Package Type	Package Drawing	Pins	SPQ	Length (mm)	Width (mm)	Height (mm)
OPA356AQDBVRQ1	SOT-23	DBV	5	3000	190.0	190.0	30.0

# DBV0005A



# PACKAGE OUTLINE

SOT-23 - 1.45 mm max height

SMALL OUTLINE TRANSISTOR

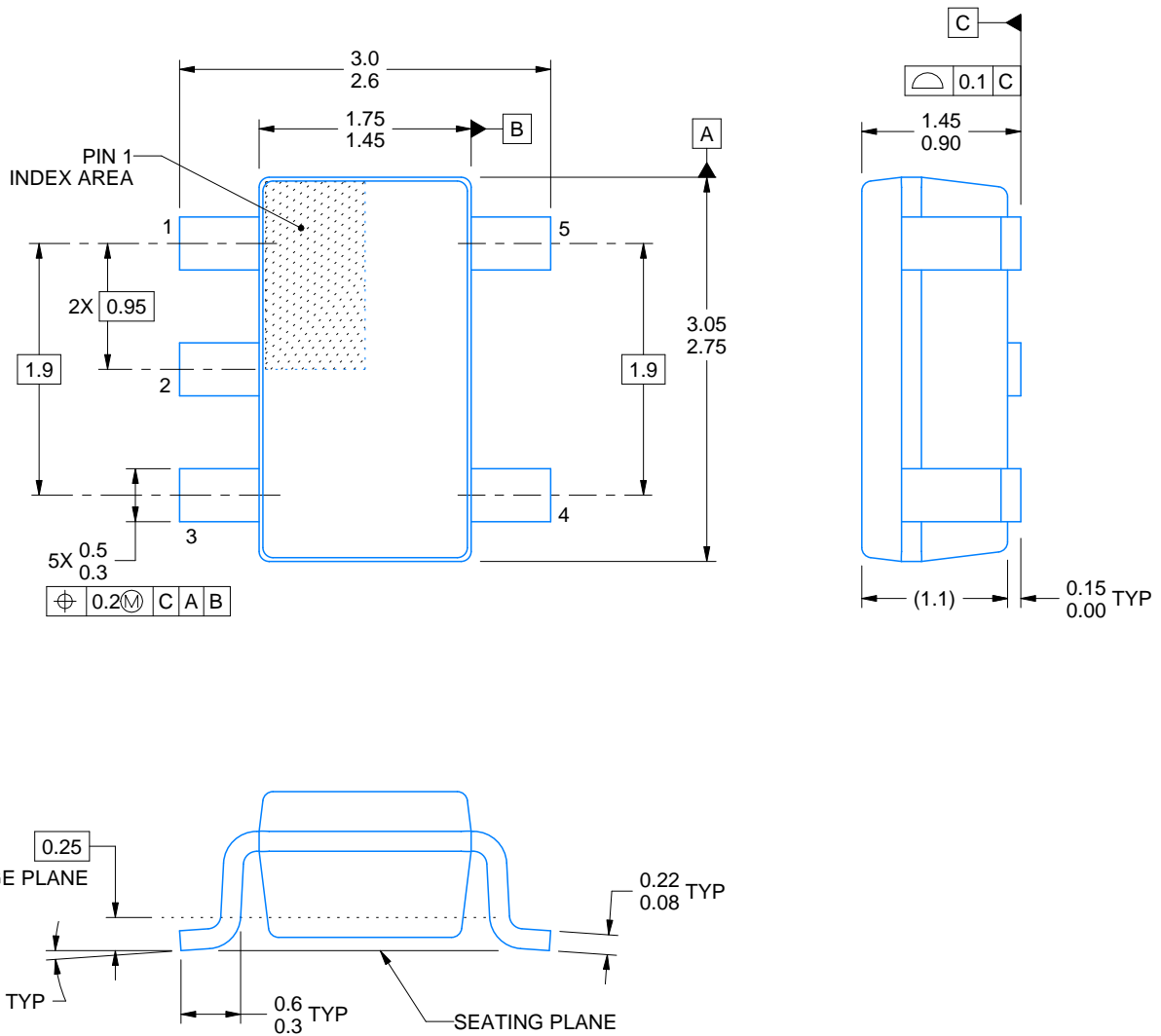

4214839/F 06/2021

## NOTES:

1. All linear dimensions are in millimeters. Any dimensions in parenthesis are for reference only. Dimensioning and tolerancing per ASME Y14.5M.
2. This drawing is subject to change without notice.
3. Reference JEDEC MO-178.
4. Body dimensions do not include mold flash, protrusions, or gate burrs. Mold flash, protrusions, or gate burrs shall not exceed 0.25 mm per side.



# EXAMPLE BOARD LAYOUT

DBV0005A

SOT-23 - 1.45 mm max height

SMALL OUTLINE TRANSISTOR



LAND PATTERN EXAMPLE  
EXPOSED METAL SHOWN  
SCALE:15X

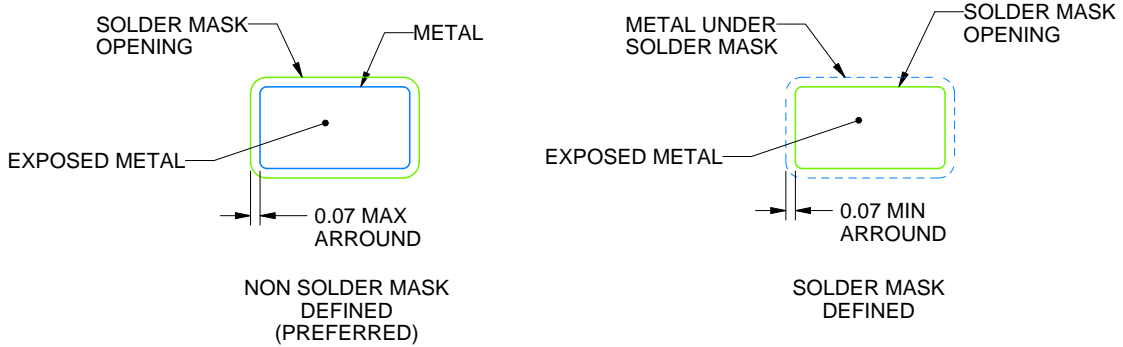

SOLDER MASK DETAILS

4214839/F 06/2021

NOTES: (continued)

- 5. Publication IPC-7351 may have alternate designs.
- 6. Solder mask tolerances between and around signal pads can vary based on board fabrication site.

# EXAMPLE STENCIL DESIGN

DBV0005A

SOT-23 - 1.45 mm max height

SMALL OUTLINE TRANSISTOR



SOLDER PASTE EXAMPLE  
BASED ON 0.125 mm THICK STENCIL  
SCALE:15X

4214839/F 06/2021

NOTES: (continued)

7. Laser cutting apertures with trapezoidal walls and rounded corners may offer better paste release. IPC-7525 may have alternate design recommendations.
8. Board assembly site may have different recommendations for stencil design.

## 重要声明和免责声明

TI“按原样”提供技术和可靠性数据（包括数据表）、设计资源（包括参考设计）、应用或其他设计建议、网络工具、安全信息和其他资源，不保证没有瑕疵且不做任何明示或暗示的担保，包括但不限于对适销性、某特定用途方面的适用性或不侵犯任何第三方知识产权的暗示担保。

这些资源可供使用 TI 产品进行设计的熟练开发人员使用。您将自行承担以下全部责任：(1) 针对您的应用选择合适的 TI 产品，(2) 设计、验证并测试您的应用，(3) 确保您的应用满足相应标准以及任何其他功能安全、信息安全、监管或其他要求。

这些资源如有变更，恕不另行通知。TI 授权您仅可将这些资源用于研发本资源所述的 TI 产品的应用。严禁对这些资源进行其他复制或展示。您无权使用任何其他 TI 知识产权或任何第三方知识产权。您应全额赔偿因在这些资源的使用中对 TI 及其代表造成的任何索赔、损害、成本、损失和债务，TI 对此概不负责。

TI 提供的产品受 [TI 的销售条款](#) 或 [ti.com](#) 上其他适用条款/TI 产品随附的其他适用条款的约束。TI 提供这些资源并不会扩展或以其他方式更改 TI 针对 TI 产品发布的适用的担保或担保免责声明。

TI 反对并拒绝您可能提出的任何其他或不同的条款。

邮寄地址：Texas Instruments, Post Office Box 655303, Dallas, Texas 75265

Copyright © 2021，德州仪器 (TI) 公司