

TPS61322 6.5 μ A 静态电流、1.8A 开关电流升压转换器

1 特性

- 工作输入电压范围：0.9V 至 5.5V
- 输出电压范围：1.8V 至 5.5V
- VOUT 引脚静态电流为 6.5 μ A
- 温度范围内输出电压精度为 $\pm 3\%$
- 最小开关峰值电流限制：
 - TPS613223A 为 0.42A
 - TPS61322 为 0.5A
 - TPS613221A 和 TPS613226A 为 0.75A
 - TPS61322 为 1.10A
- 10mA 负载条件下进行 1.5V 至 2.2V 转换时效率高于 90%
- 热关断保护
- 2.9mm \times 1.3mm 3 引脚 SOT 封装和 2.9mm \times 1.6mm 5 引脚 SOT 封装
- 使用 TPS61322 并借助 WEBENCH[®] 电源设计器创建定制设计

2 应用

- 1 至 3 节碱性电池或镍氢电池供电型应用
- 游戏控制
- 平板电脑
- 便携式电子产品
- 医疗设备

3 说明

TPS61322 是一款具有仅 6.5 μ A 静态电流的同步升压转换器。TPS61322 可以为由碱性电池、镍氢可再充电电池或单节锂离子电池供电的产品提供电源解决方案。该升压转换器建立在采用同步整流的迟滞控制拓扑基础之上，能够以最小静态电流实现最高的效率。TPS61322 也支持使用小型外部电感器和电容器。10mA 负载条件下进行 1.5V 输入至 2.2V 输出转换时效率高于 90%。

TPS61322 还可以通过外部肖特基二极管支持高输出电流应用。利用与内部整流器 FET 并联的外部肖特基二极管，TPS613222A 可以在进行 3V 输入电压至 5V 输出电压转换时提供高于 500mA 的输出电流能力。

可以在内部将输出电压设置为 1.8V 至 5.5V 范围内的某个固定输出（单位增量为 0.1V）。因此，仅需两个外部组件即可实现所需的输出电压。TPS61322 还具有热关断保护功能。

TPS61322 采用 2.9mm \times 1.3mm 3 引脚 SOT 封装或 2.9mm \times 1.6mm 5 引脚 SOT 封装。

器件信息⁽¹⁾

器件号	封装	封装尺寸（标称值）
TPS61322	SOT-23 (3)	2.90mm \times 1.30mm
	SOT-23 (5)	2.90mm \times 1.60mm

(1) 如需了解所有可用封装，请参阅数据表末尾的可订购产品附录。

典型应用电路

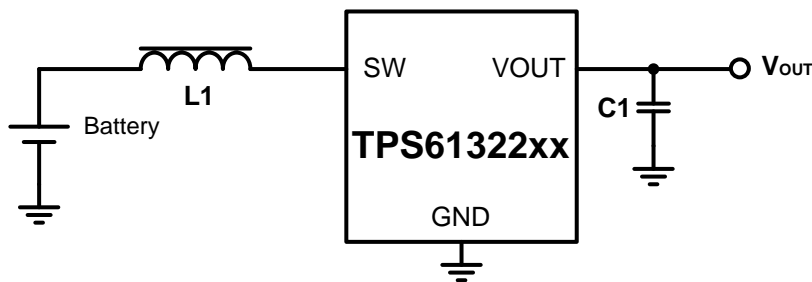

目录

1	特性	1	9	Application and Implementation	11
2	应用	1	9.1	Application Information.....	11
3	说明	1	9.2	Typical Application	11
4	修订历史记录	2	9.3	System Examples	19
5	Device Comparison Table	3	10	Power Supply Recommendations	20
6	Pin Configuration and Functions	3	11	Layout.....	21
7	Specifications.....	4	11.1	Layout Guidelines	21
7.1	Absolute Maximum Ratings	4	11.2	Layout Examples.....	22
7.2	ESD Ratings	4	12	器件和文档支持	23
7.3	Recommended Operating Conditions.....	4	12.1	器件支持	23
7.4	Thermal Information	4	12.2	文档支持	23
7.5	Electrical Characteristics.....	5	12.3	接收文档更新通知	23
7.6	Typical Characteristics	6	12.4	社区资源	23
8	Detailed Description	9	12.5	商标	23
8.1	Overview	9	12.6	静电放电警告.....	23
8.2	Functional Block Diagram	9	12.7	术语表	24
8.3	Feature Description.....	9	13	机械、封装和可订购信息	24

4 修订历史记录

注：之前版本的页码可能与当前版本有所不同。

Changes from Revision C (May 2018) to Revision D	Page
• 已删除 从 TPS61322 标题中删除了“准 GPN”并将“TPS61322xx”更改成了“TPS61322”	1
• 已添加 添加了 WEBENCH 链接	1
• Changed the NFET symbol in <i>Functional Block Diagram</i>	9
• Added <i>Device Functional Modes</i>	10

Changes from Revision B (April 2018) to Revision C	Page
• Deleted Cross Reference to <i>Device Comparison Table</i> and the Electrical Characteristics table footnotes regarding device TPS61223A, that was <i>Product Preview</i> device in the SLVSDY5B revision.	3
• Added graphs pertaining to TPS613223A device to the Typical Characteristics matrix.	6

Changes from Revision A (January 2018) to Revision B	Page
• Deleted Cross Reference to <i>Device Comparison Table</i> and the Electrical Characteristics table footnotes regarding devices TPS61221A, TPS61222A, and TPS61226A that were <i>Product Preview</i> devices in the SLVSDY5A revision.	3
• Added <i>Figure 3</i> , <i>Figure 4</i> and <i>Figure 5</i>	6
• Added <i>Figure 7</i> , <i>Figure 8</i> , and <i>Figure 11</i>	8

Changes from Original (September 2017) to Revision A	Page
• 2018 年 1 月生产数据发布。	1

5 Device Comparison Table

PART NUMBER	OUTPUT VOLTAGE	TYPICAL CURRENT LIMIT
TPS61322	2.2 V	0.75A
TPS613221A	3.3 V	1.2 A
TPS613222A	5 V	1.8 A
TPS613223A	2 V	0.75 A
TPS613224A ⁽¹⁾	2.5 V	0.75 A
TPS613225A ⁽¹⁾	3 V	1.2 A
TPS613226A	3.6 V	1.2 A

(1) Product Preview. Contact TI factory for more information.

6 Pin Configuration and Functions

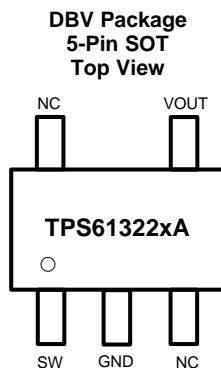
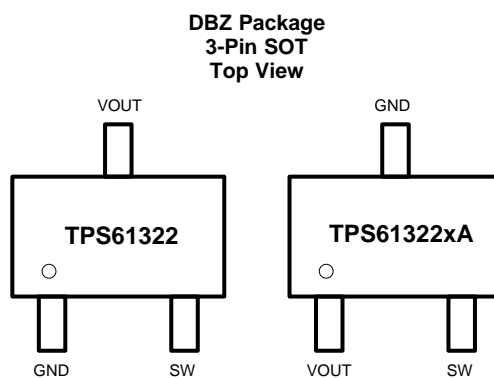

Pin Functions

PIN			NAME	TYPE	DESCRIPTION
TPS61322	TPS61322xA				
DBZ	DBZ	DBV			
1	3	2	GND	PWR	Ground of the IC.
2	2	1	SW	PWR	The switch pin of the converter. It is connected to the inductor.
3	1	4	VOUT	PWR	Boost converter output.
-	-	3	NC	-	No connection inside the device.
-	-	5	NC	-	No connection inside the device.

7 Specifications

7.1 Absolute Maximum Ratings

over operating free-air temperature range (unless otherwise noted)⁽¹⁾

	MIN	MAX	UNIT
Voltage range at terminals ⁽²⁾ SW, VOUT	-0.3	6.0	V
Operating Junction Temperature, T _J	-40	150	°C
Storage Temperature, T _{stg}	-65	150	°C

- (1) Stresses beyond those listed under *Absolute Maximum Ratings* may cause permanent damage to the device. These are stress ratings only, which do not imply functional operation of the device at these or any other conditions beyond those indicated under *Recommended Operating Conditions*. Exposure to absolute-maximum-rated conditions for extended periods may affect device reliability.
- (2) All voltage values are with respect to network ground terminal.

7.2 ESD Ratings

	VALUE	UNIT
V _(ESD) Electrostatic discharge	Human-body model (HBM), per ANSI/ESDA/JEDEC JS-001 ⁽¹⁾	±2000
	Charged-device model (CDM), per JEDEC specification JESD22-C101 ⁽²⁾	±500

- (1) JEDEC document JEP155 states that 500-V HBM allows safe manufacturing with a standard ESD control process.
- (2) JEDEC document JEP157 states that 250-V CDM allows safe manufacturing with a standard ESD control process.

7.3 Recommended Operating Conditions

over operating free-air temperature range (unless otherwise noted)

	MIN	NOM	MAX	UNIT
V _{IN} Input voltage range	0.9		5.5	V
V _{OUT} Output voltage range	1.8		5.5	V
L Inductor (effective)	0.7	2.2	13	μH
C _{OUT} Output capacitor (effective)	4.7	16	100	μF
T _J Operating junction temperature	-40		125	°C

7.4 Thermal Information

THERMAL METRIC ⁽¹⁾	TPS61322		UNIT
	DBZ (SOT-23)	DBV (SOT-23)	
	3-PIN	5-PIN	
R _{θJA} Junction-to-ambient thermal resistance	322.2	189.7	°C/W
R _{θJC(top)} Junction-to-case (top) thermal resistance	107.0	109.4	°C/W
R _{θJB} Junction-to-board thermal resistance	65.8	56.5	°C/W
ψ _{JT} Junction-to-top characterization parameter	7.5	33.3	°C/W
ψ _{JB} Junction-to-board characterization parameter	64.5	56.5	°C/W
R _{θJC(bot)} Junction-to-case (bottom) thermal resistance	N/A	N/A	°C/W

- (1) For more information about traditional and new thermal metrics, see the [Semiconductor and IC Package Thermal Metrics](#) application report.

7.5 Electrical Characteristics

$T_J = -40^{\circ}\text{C}$ to $+125^{\circ}\text{C}$ and $V_{IN} = 0.9\text{ V}$ to 5.5 V . Typical values are at $V_{IN} = 1.2\text{ V}$, $T_J = 25^{\circ}\text{C}$, unless otherwise noted

PARAMETER		TEST CONDITIONS	MIN	TYP	MAX	UNIT	
POWER SUPPLY							
V_{IN}	Input voltage range		0.9		5.5	V	
V_{VOUT_START}	Minimum voltage for startup at VOUT pin	$R_{Load} \geq 250\Omega$, $T_J = -40^{\circ}\text{C}$ to 85°C		0.83	0.87	V	
I_Q	Quiescent current into VOUT pin	$V_{OUT} = 1.2 \times \text{Target}$		6.5	10	μA	
OUTPUT							
V_{OUT}		TPS61322	$V_{IN} < V_{OUT}$, $T_J = -40^{\circ}\text{C}$ to 125°C	2.134	2.2	2.266	V
		TPS613221A	$V_{IN} < V_{OUT}$, $T_J = -40^{\circ}\text{C}$ to 125°C	3.2	3.3	3.4	V
		TPS613222A	$V_{IN} < V_{OUT}$, $T_J = -40^{\circ}\text{C}$ to 125°C	4.85	5.0	5.15	V
		TPS613223A	$V_{IN} < V_{OUT}$, $T_J = -40^{\circ}\text{C}$ to 125°C	1.94	2.0	2.06	V
		TPS613226A	$V_{IN} < V_{OUT}$, $T_J = -40^{\circ}\text{C}$ to 125°C	3.49	3.6	3.71	V
I_{SW_LKG}	Leakage current into SW pin	$V_{SW} = V_{OUT} = 1.2 \times \text{Target}$		3.5		nA	
POWER SWITCH							
$R_{DS(on)_LS}$	Low side switch on resistance	TPS61322		300		$\text{m}\Omega$	
		TPS613221A		200		$\text{m}\Omega$	
		TPS613222A		150		$\text{m}\Omega$	
		TPS613223A		400		$\text{m}\Omega$	
		TPS613226A		190		$\text{m}\Omega$	
$R_{DS(on)_HS}$	High side switch on resistance	TPS61322		1300		$\text{m}\Omega$	
		TPS613221A		1000		$\text{m}\Omega$	
		TPS613222A		750		$\text{m}\Omega$	
		TPS613223A		1680		$\text{m}\Omega$	
		TPS613226A		950		$\text{m}\Omega$	
I_{LIM}	Peak switch current limit	TPS61322		0.50	0.75	1.20	A
		TPS613221A		0.75	1.20	1.60	A
		TPS613222A		1.10	1.80	2.50	A
		TPS613223A		0.42	0.75	1.2	A
		TPS613226A		0.75	1.20	1.60	A
Protection							
T_{SD}	Over-temperature protection	T_J rising		150		$^{\circ}\text{C}$	
T_{SD_HYS}	Over-temperature protection hysteresis			20		$^{\circ}\text{C}$	

7.6 Typical Characteristics

T_J = 25°C unless otherwise noted.

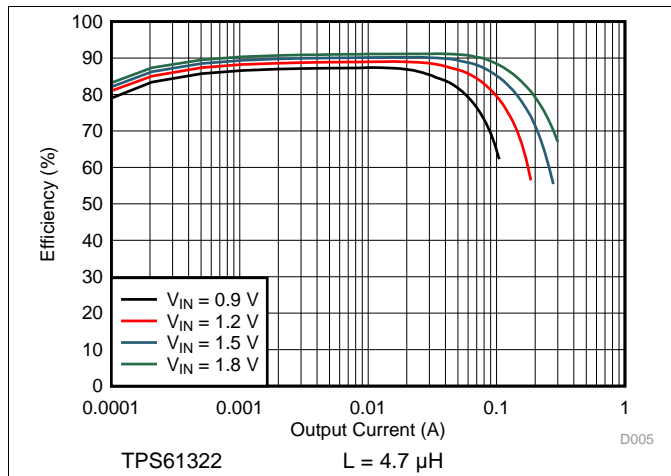

Figure 1. Load Efficiency with Different Inputs

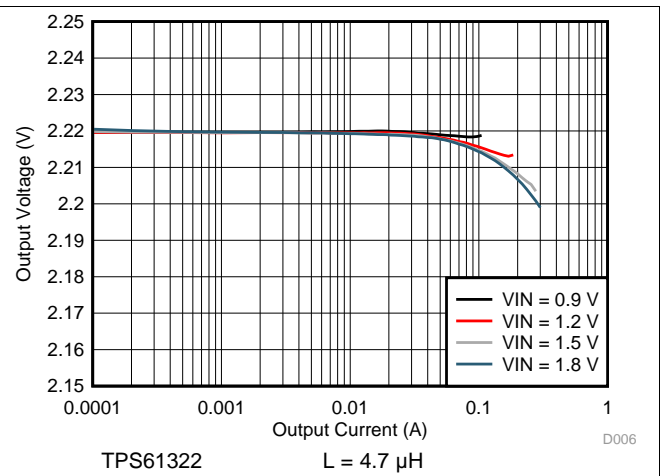

Figure 2. Load Regulation

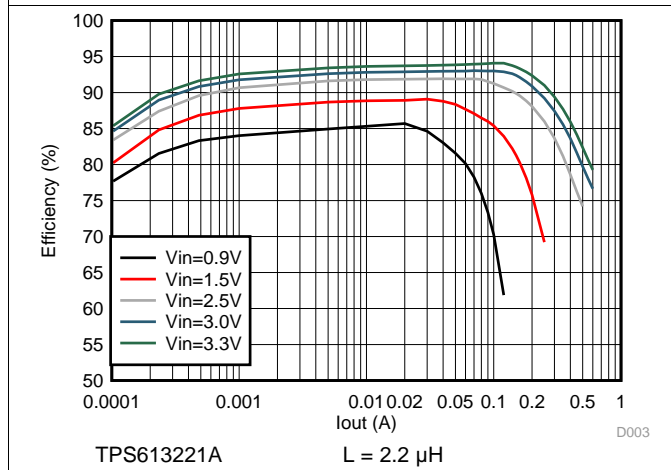

Figure 3. Load Efficiency with Different Inputs

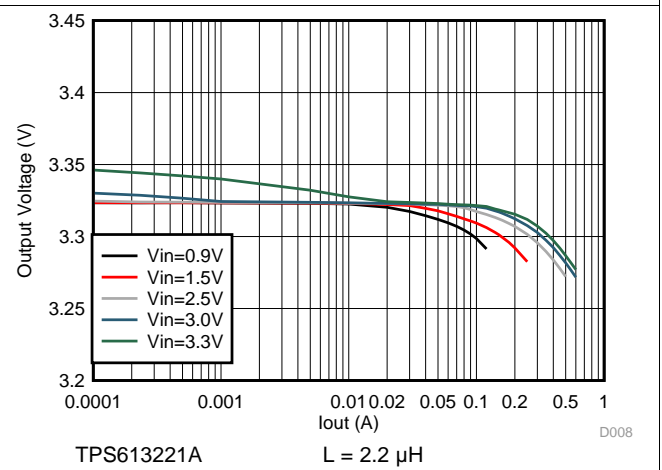

Figure 4. Load Regulation

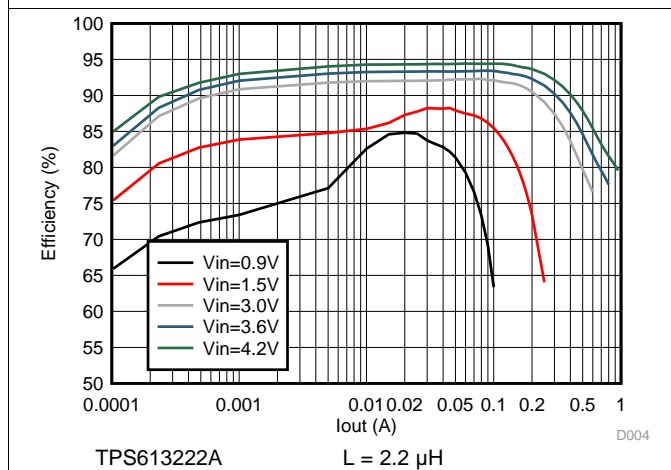

Figure 5. Load Efficiency with Different Inputs

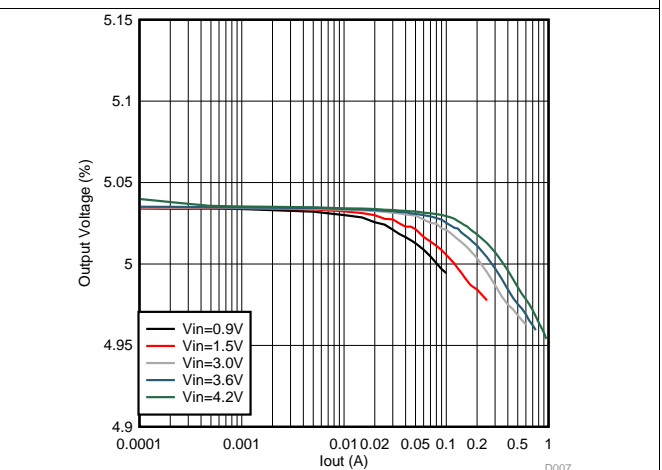

Figure 6. Load Regulation

Typical Characteristics (continued)

T_J = 25°C unless otherwise noted.

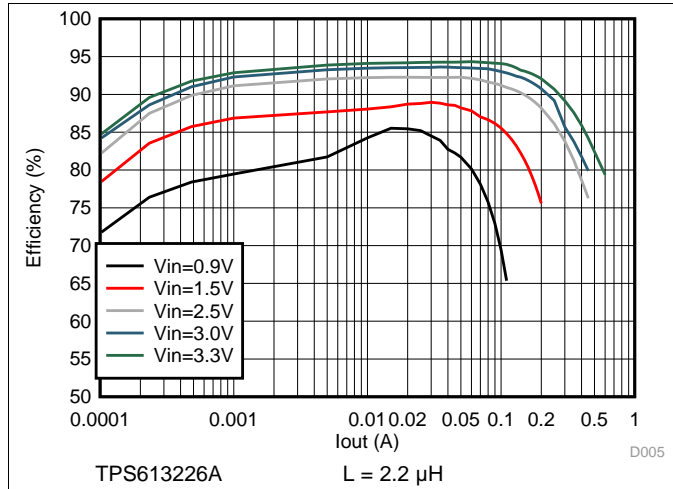

Figure 7. Load Efficiency with Different Inputs

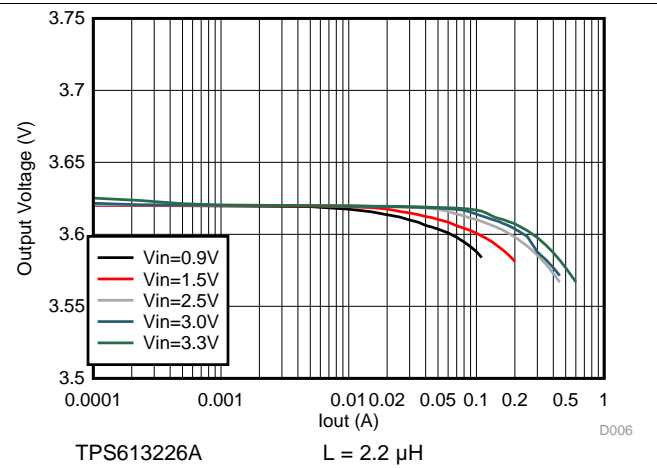

Figure 8. Load Regulation

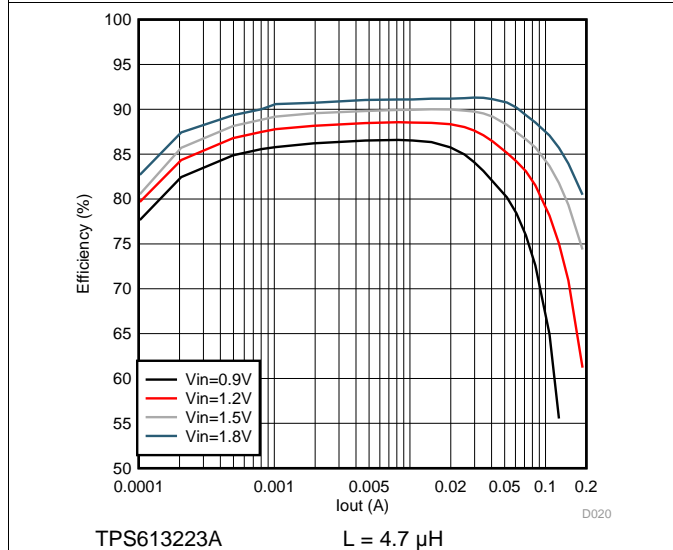

Figure 9. Load Efficiency with Different Inputs

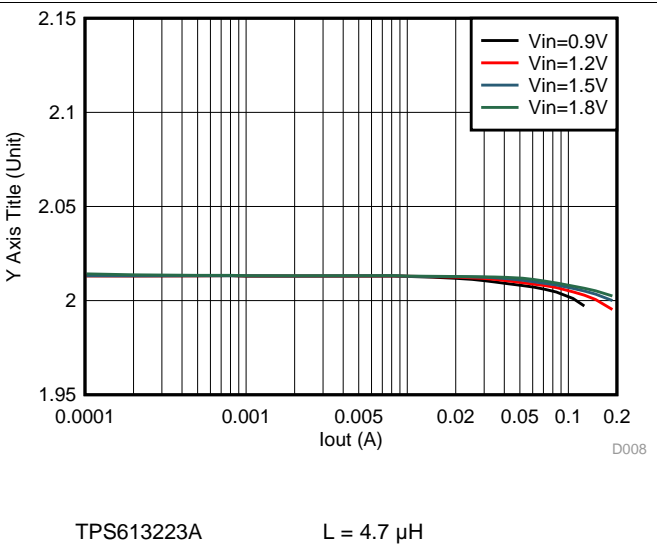

Figure 10. Load Regulation

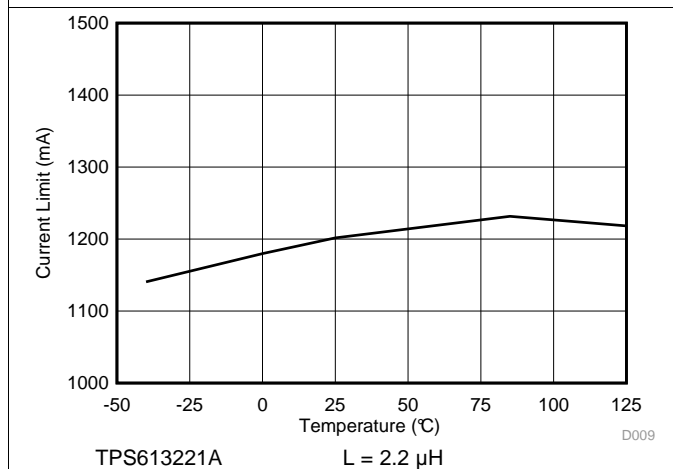

Figure 11. Current Limit with Different Temperature

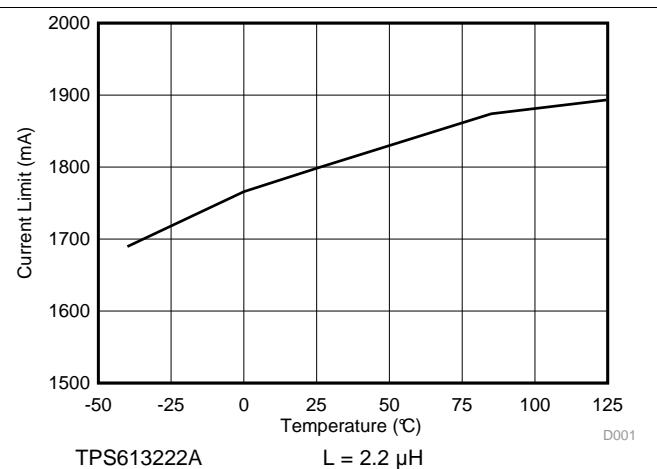
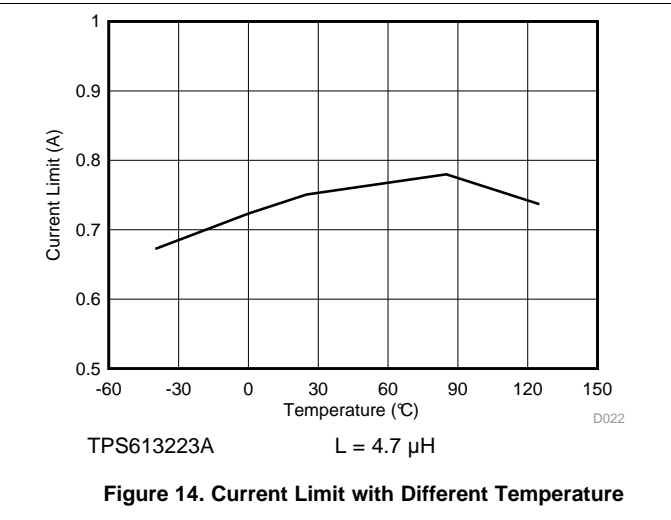
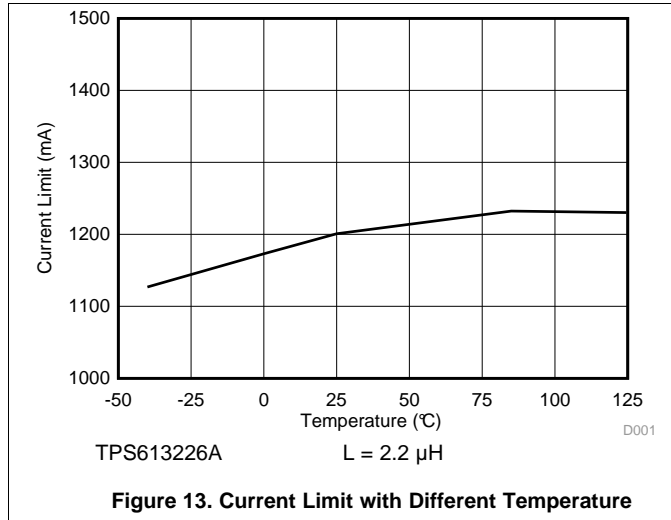

Figure 12. Current Limit with Different Temperature

Typical Characteristics (continued)

T_J = 25°C unless otherwise noted.



8 Detailed Description

8.1 Overview

The TPS61322xx is a low quiescent current, high efficiency synchronous boost converter. The TPS61322xx uses hysteretic current control scheme. The TPS61322xx is designed for systems powered by alkaline battery, NiMH rechargeable battery, Li-ion battery or Li-polymer battery. The input voltage range is from 0.9 V to 5.5 V. After start-up is completed, the TPS61322xx can work with the input voltage down to 0.4 V. The TPS61322xx consumes only 6.5- μ A quiescent current and achieves high efficiency under light load conditions. The TPS61322xx is designed as an always-on power. Higher than 90% efficiency is achieved under 10-mA load from 1.5-V input voltage to 2.2-V output voltage conversion to extend battery lifetime. The TPS613222A can support as high as 500-mA output current from 3-V input voltage to 5-V output voltage conversion with an external schottky diode in parallel with internal high-side MOSFET.

8.2 Functional Block Diagram

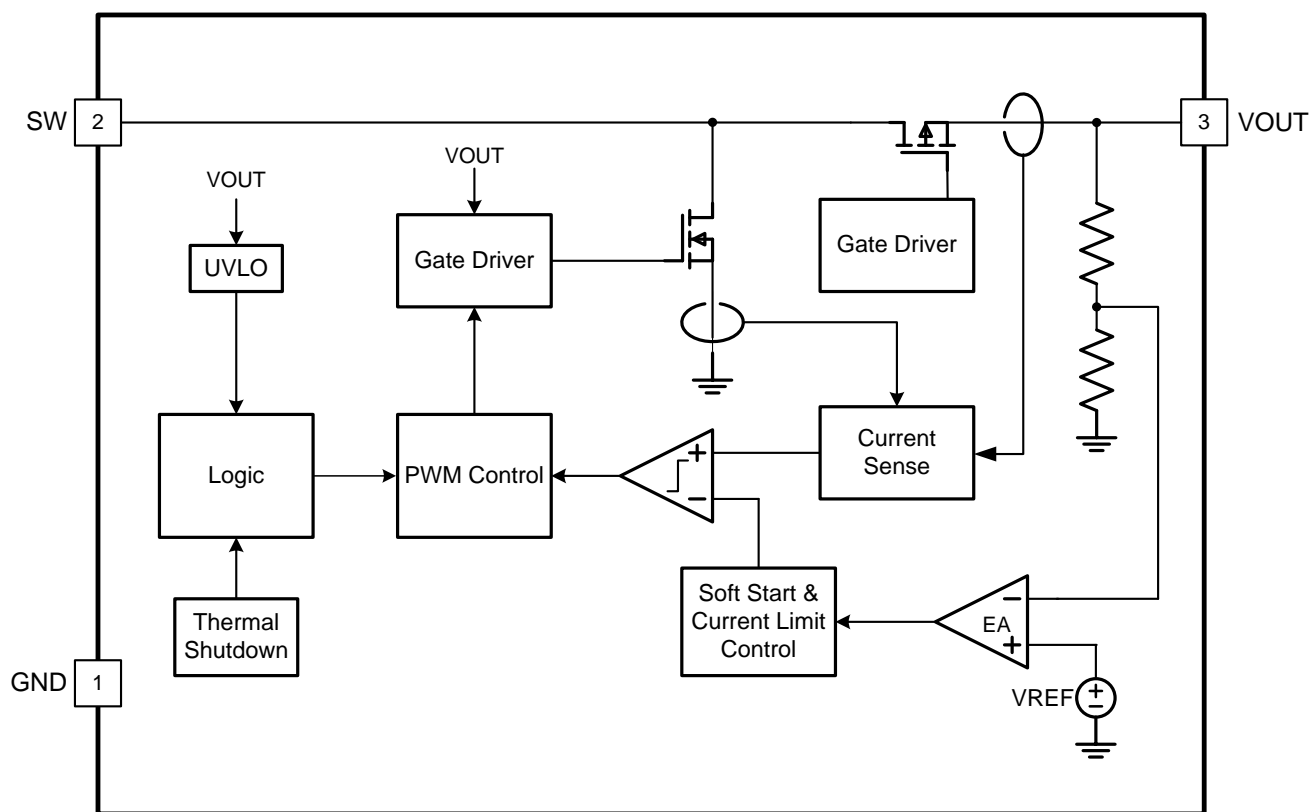

Copyright © 2017, Texas Instruments Incorporated

8.3 Feature Description

8.3.1 Soft Start

When the input voltage is applied, the high side MOSFET is turned on. The input voltage charges the output capacitors through the inductor and the high side MOSFET. When the output capacitors are charged to 0.83-V typical value, the TPS61322xx starts switching at 1.6-MHz fixed frequency and the high-side MOSFET is turned off. When the output voltage goes up to typical 1.6 V, an internal soft-start control circuit ramps the reference voltage to 0.8 V within 2 ms. In this way, the soft-start function reduces the input inrush current. After the output voltage reaches the target value, soft start ends, and the inductor peak current is determined by the output of an internal error amplifier. After start-up, the TPS61322xx can work with the input voltage down to 0.4 V.

Feature Description (continued)

8.3.2 Boost Controller Circuit

The TPS61322xx boost converter is controlled by a hysteretic current mode scheme. The TPS61322xx regulates the output voltage by keeping the inductor ripple constant of 200-mA typical value and adjusting the offset of this inductor current depending on the output load. If the required average input current is lower than average inductor current defined by this constant ripple current, the inductor current becomes discontinuous to keep the efficiency high under light load conditions. Figure 15 illustrates the hysteretic current operation.

The output voltage V_{OUT} is monitored via the internal feedback network connected to a voltage error amplifier. To regulate the output voltage, the voltage error amplifier compares this feedback voltage to the internal voltage reference and adjusts the required offset of the inductor current accordingly.

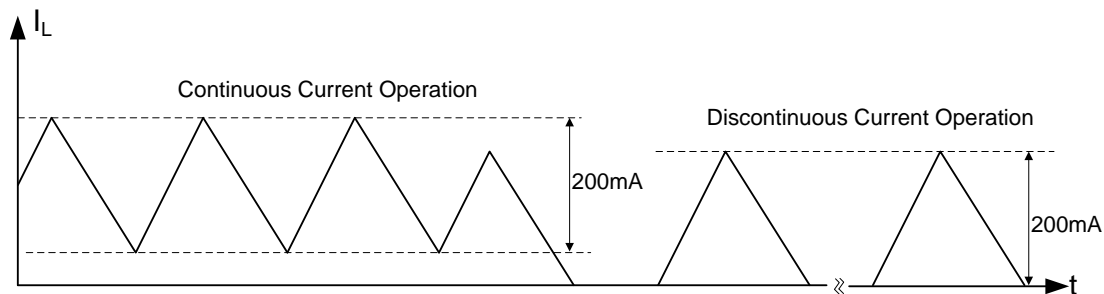

Figure 15. Hysteretic Current Operation

The TPS61322xx boost converter can increase the output load capacity by connecting an external schottky diode from SW pin to VOUT pin. Higher than 500 mA output current is supported for 5-V output voltage applications such as USB OTG and HDMI power supply. For such applications, an adaptive constant off time circuit will generate the signal to turn off high-side FET. The inductor current ripple is greater than 200 mA if with this external diode. A higher inductance can help reduce the inductor current ripple.

8.3.3 Undervoltage Lockout

An undervoltage lockout function stops operation of the converter if the input voltage drops below the typical undervoltage lockout threshold of 0.4 V while the output voltage is still higher than 1.8 V. A hysteresis of 100 mV is added so that the device does not switch again until the input voltage goes up to 0.5 V.

8.3.4 Current Limit Operation

The TPS61322xx employs cycle-by-cycle peak current limit operation. If the inductor peak current hits the peak current limit I_{LIM} , the low-side MOSFET is turned off and stops the further increase of the inductor current. In this case the output voltage drops until power balance between the input side and output side is achieved. If the output voltage drops below the input voltage, the inductor current will be clamped by the DCR of the inductor and the on-resistance ($R_{ds,on}$) of the high-side MOSFET.

8.3.5 Overtemperature Protection

The TPS61322xx has a built-in temperature sensor which monitors the internal junction temperature in boost mode operation. If the junction temperature exceeds the threshold 150°C, the device stops operating. As soon as the junction temperature drops below the shutdown temperature minus the hysteresis, typically 130°C, the device starts operating again.

8.3.6 Device Functional Modes

- [Boost Controller Circuit](#) - Continuous and discontinuous current operation
- Protective mechanisms
 - [Current Limit Operation](#)
 - [Undervoltage Lockout](#)
 - [Overtemperature Protection](#)

9 Application and Implementation

NOTE

Information in the following applications sections is not part of the TI component specification, and TI does not warrant its accuracy or completeness. TI's customers are responsible for determining suitability of components for their purposes. Customers should validate and test their design implementation to confirm system functionality.

9.1 Application Information

The TPS61322xx is designed to operate at a wide input voltage range from 0.9-V to 5.5-V. The minimum peak switch current limit is 0.5 A for TPS61322, with 0.75 A for TPS613221A and 1.1 A for TPS613222A. The TPS61322xx supports output voltage from 1.8 V to 5.5 V with increment of 0.1 V, refer to [Device Comparison Table](#) for device details to select the right device for the target applications. Use the following design procedure to select component values for the TPS61322xx.

9.2 Typical Application

9.2.1 Boost without Schottky Diode

A typical application example is the wireless mouse, which normally requires 2.2-V voltage as its supply voltage and consumes less than 50-mA current from one-cell alkaline battery. The following design procedure can be used to select external component values for TPS61322xx.

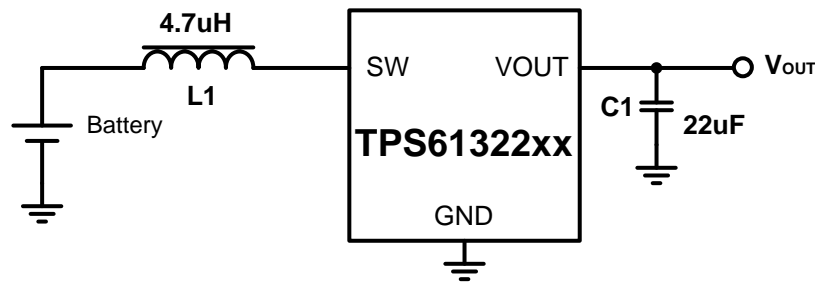

Copyright © 2017, Texas Instruments Incorporated

Figure 16. Typical Application Circuit without Schottky Diode

9.2.1.1 Design Requirements

Table 1. Design Requirements

PARAMETERS	VALUES
Input voltage	0.9 V to 1.6 V
Output voltage	2.2 V
Output current	50 mA
Output voltage ripple	±10 mV

9.2.1.2 Detailed Design Procedure

9.2.1.2.1 Custom Design With WEBENCH® Tools

[Click here](#) to create a custom design using the TPS61322 device with the WEBENCH® Power Designer.

1. Start by entering the input voltage (V_{IN}), output voltage (V_{OUT}), and output current (I_{OUT}) requirements.
2. Optimize the design for key parameters such as efficiency, footprint, and cost using the optimizer dial.
3. Compare the generated design with other possible solutions from Texas Instruments.

The WEBENCH Power Designer provides a customized schematic along with a list of materials with real-time pricing and component availability.

In most cases, these actions are available:

- Run electrical simulations to see important waveforms and circuit performance
- Run thermal simulations to understand board thermal performance
- Export customized schematic and layout into popular CAD formats
- Print PDF reports for the design, and share the design with colleagues

Get more information about WEBENCH tools at www.ti.com/WEBENCH.

9.2.1.2.2 Maximum Output Current

For boost converters, the maximum output current capability is determined by the input to output ratio, the efficiency, the inductor current ripple and the current limit. The maximum output current can be estimated by [Equation 1](#)

$$I_{OUT (max)} = \frac{V_{IN} \times (I_{LIM} - \frac{I_{LH}}{2}) \times \eta}{V_{OUT}}$$

where

- I_{LIM} is the peak inductor current limit
 - I_{LH} is the inductor current ripple
 - η is the boost converter power convert efficiency
- (1)

Minimum input voltage, maximum boost output voltage and minimum current limit should be used as the worst case condition for the estimation.

In this example, assume the power efficiency is 70% at the minimum input voltage of 0.9 V. The calculated maximum output current is 114 mA, which satisfies the application requirements.

9.2.1.2.3 Inductor Selection

Because the inductor affects steady state operation, transient behavior, and loop stability, the inductor is the most important component in power regulator design. There are three important inductor specifications, inductor value, saturation current, and dc resistance (DCR).

The TPS61322xx is optimized to work with inductor values between 0.7 μH and 13 μH . The inductor values affect the switching frequency. The estimated switching frequency in continuous conduction mode (CCM) can be calculated by [Equation 2](#). The switching frequency f_{SW} is not a constant value, which is determined by the inductance, the inductor current ripple, the input voltage and the output voltage. The current ripple I_{LH} is fixed to 200 mA typically, but it can be affected by the inductor value indirectly. Normally when a smaller inductor value is applied, the inductor current ramps up and down more quickly. The current ripple becomes bigger because the internal current comparator has delay to respond. If a smaller inductor peak current is required in applications, a higher inductor value can be used. However, The inductor and output capacitor must be considered together for the loop stability. The output capacitor and the inductance will influence the bandwidth and phase margin of the converter. Consequently, with a larger inductor, a bigger capacitor normally must be used to ensure the same L/C ratio for a stable loop. For best stability consideration, a 4.7- μH inductor is recommended for 2.2-V output voltage application.

$$f_{SW} = \frac{V_{IN} \times (V_{OUT} - V_{IN} \times \eta)}{L \times I_{LH} \times V_{OUT}}$$

where

- f_{SW} is the switching frequency of the converter
 - I_{LH} is the inductor current ripple
 - η is the boost converter power convert efficiency
- (2)

Having selected the inductance value, follow [Equation 3](#) to [Equation 5](#) to calculate the inductor's peak current for the application. Depending on different load conditions, the TPS61322xx works in continuous current mode or discontinuous conduction mode(DCM). In different modes, the peak currents of the inductor are also different. [Equation 3](#) provides an easy way to estimate whether the device works in CCM or DCM. [Equation 4](#) shows the peak current when the device works in CCM and [Equation 5](#) shows the peak current when the device works in DCM.

$$\frac{V_{OUT} \times I_{OUT}}{V_{IN} \times \eta} > \frac{I_{LH}}{2}$$

where

- I_{LH} is the inductor current ripple
 - η is the boost converter power convert efficiency
- (3)

$$I_{L,peak} = \frac{V_{OUT} \times I_{OUT}}{V_{IN} \times \eta} + \frac{I_{LH}}{2}$$

where

- $I_{L,peak}$ is the peak current of the inductor
 - I_{LH} is the inductor current ripple
 - η is the boost converter power convert efficiency
- (4)

$$I_{L,peak} = I_{LH}$$

where

- $I_{L,peak}$ is the peak inductor.
 - I_{LH} is the inductor current ripple
- (5)

The saturation current of the inductor must be higher than the calculated peak inductor current, otherwise the excessive peak current in the inductor harms the device and reduces the system reliability.

In this example, the maximum load for the boost converter is 50 mA, the minimum input voltage is 0.9 V, and the efficiency under this condition can be estimated at 80%, so the boost converter works in continuous operation mode by the calculation. The inductor peak current is calculated as 258 mA. To have some margin, a 4.7- μ H inductor with at least 300 mA saturation current is recommended for this application. A 10- μ H inductor can be used as well by increasing the output capacitance to higher than 22 μ F to make the loop stable. [Table 2](#) lists the recommended inductors for TPS61322xx device.

Table 2. List of Inductors

INDUCTAN CE [μ H]	SATURATION CURRENT [A]	DC RESISTAN CE [m Ω]	SIZE (L \times W \times H)(mm)	PART NUMBER	MANUFACTURER ⁽¹⁾
4.7	1.7	165	2.5 \times 2 \times 1.2	DFE252012P-4R7M=P2	MURATA
4.7	1.5	141	3 \times 3 \times 1.5	74438335047	Wurth
4.7	1.5	209	2.5 \times 2 \times 1.2	SDEM25201B-4R7MS	CYNTEC

(1) See [Third-party Products Disclaimer](#)

9.2.1.2.4 Capacitor Selection

For better output voltage filtering, TI recommends low ESR X5R or X7R ceramic capacitors.

For the output capacitor at the VOUT pin, TI recommends small ceramic capacitors. Place the capacitors as close as possible to the VOUT and GND pins of the device. If, for any reason, the application requires the use of large capacitors that cannot be placed close to the device, the use of a small ceramic capacitor with a capacitance value of 1 μF in parallel to the large one is recommended. Place this small capacitor as close as possible to the VOUT and GND pins of the device.

Considering loop stability, for inductance of 4.7 μH , the minimal output capacitor value is 10 μF (effective value). Refer to Table 3 for inductor and capacitor combination. Increasing the output capacitor makes the output ripple smaller.

When selecting capacitors, ceramic capacitor's derating effect under DC bias voltage must be considered. Choose the right nominal capacitance by checking capacitor's DC bias characteristics. In this example, GRM188R60J106ME84D, which is a 10- μF ceramic capacitor with high effective capacitance value at DC biased condition, is selected for V_{OUT} rail. Two 10- μF capacitors in parallel are recommended to get the desired effective capacitance.

Table 3. List of Inductor and Capacitor

INDUCTANCE [μH]	CAPACITANCE [μF]	LOAD [mA]	PACKAGE	PART NUMBER	MANUFACTURER ⁽¹⁾
1.0	2 × 10	50	0603	GRM188R60J106ME84D	MURATA
2.2	2 × 10	50	0603	GRM188R60J106ME84D	MURATA
4.7	22	50	0805	GRM21BZ71A226ME15	MURATA

(1) See [Third-party Products Disclaimer](#)

9.2.1.3 Application Curves

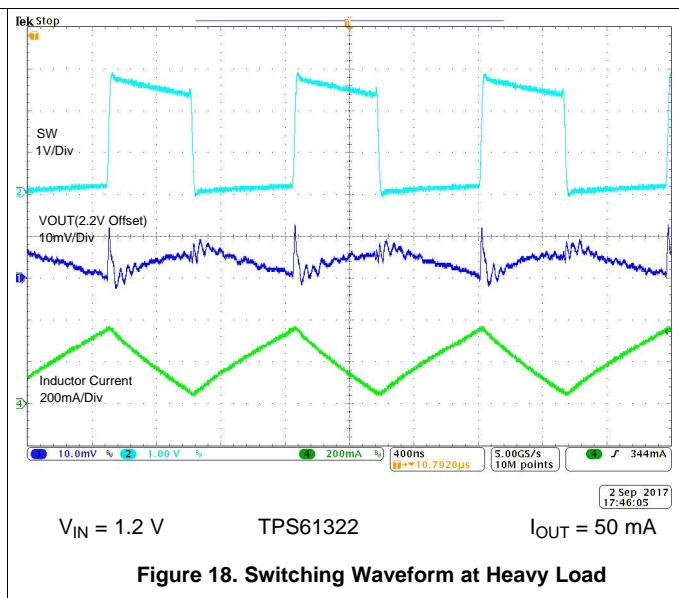
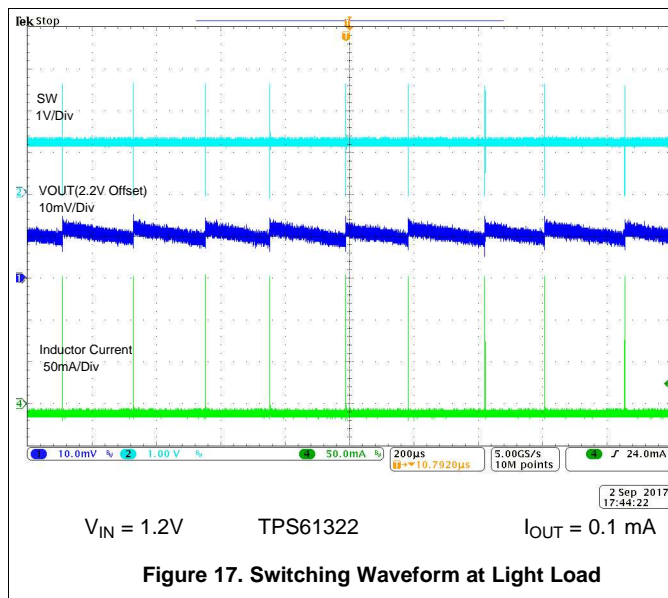

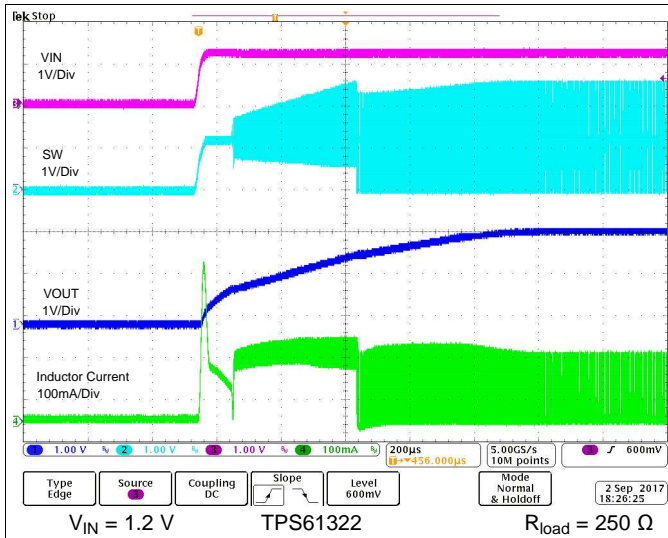

Figure 19. Start-up by VIN

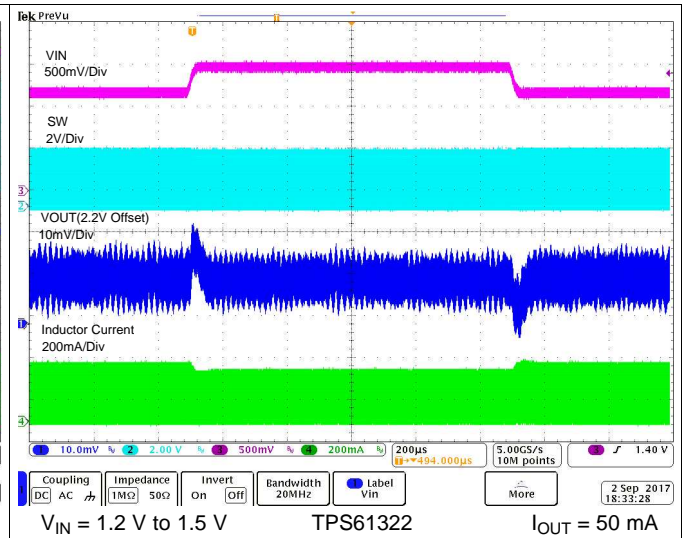

Figure 20. Line Transient

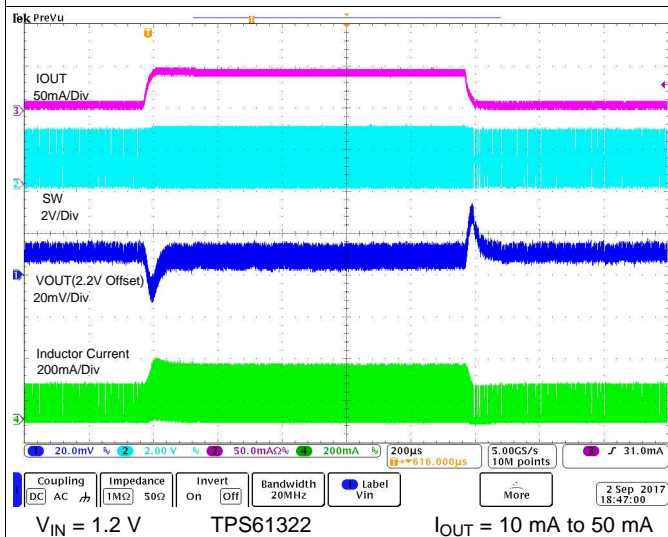

Figure 21. Load Transient

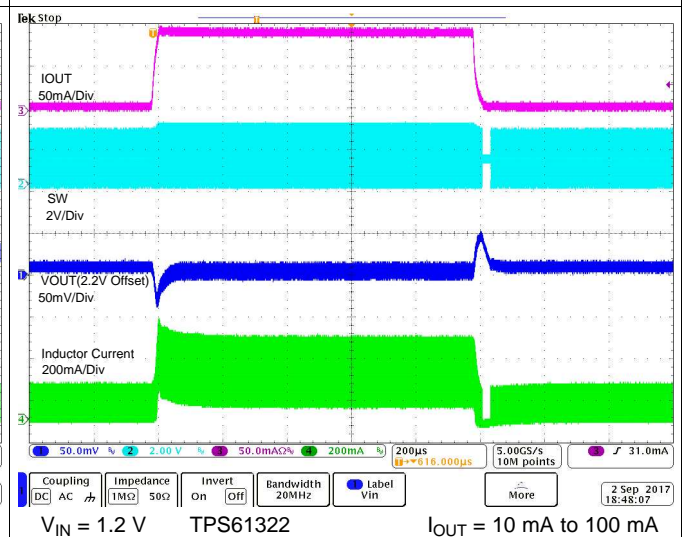
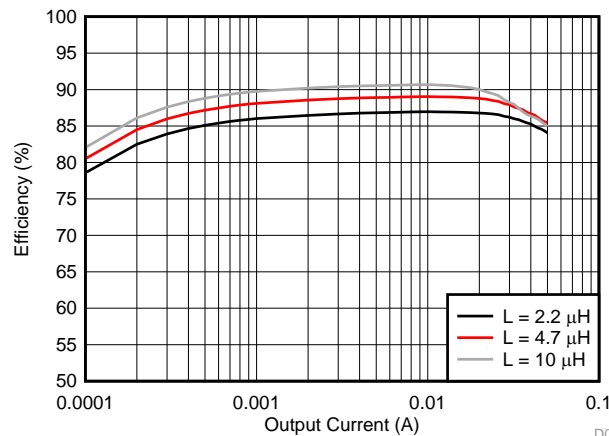

Figure 22. Load Transient



Wurth Electronics, 74438335XXX family

2.2 μH, 4.7 μH, 10 μH

D007

V_{IN} = 1.2 V

TPS61322

Figure 23. Efficiency with Different Inductance

9.2.2 Boost with Schottky Diode

Another typical application example is the USB OTG which normally requires 5-V output as its supply voltage and consumes as high as 500-mA current. The following design procedure can be used to select external component values for this application.

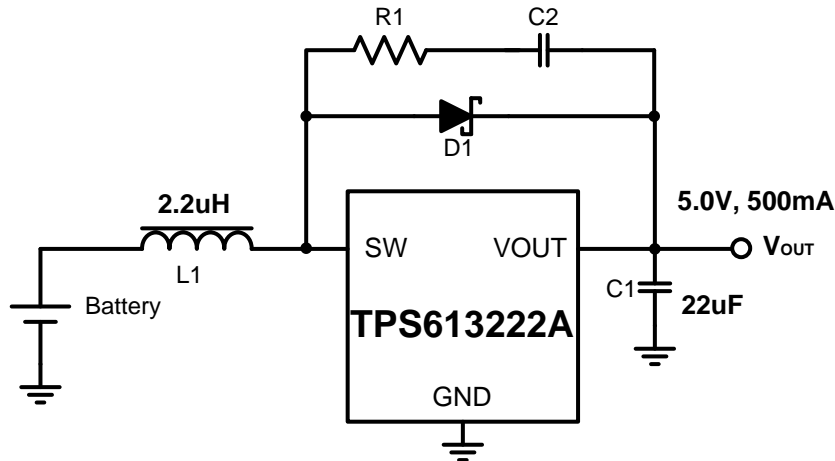

Figure 24. Typical Application Circuit with Schottky Diode

9.2.2.1 Design Requirements

Table 4. Design Requirements

PARAMETERS	VALUES
Input voltage	3 V to 4.35 V
Output voltage	5 V
Output current	500 mA
Output voltage ripple	± 25 mV

9.2.2.2 Detailed Design Procedure

9.2.2.2.1 Inductor Selection

The peak current is calculated according to Equation 4 and Equation 5. The saturation current of the inductor must be higher than the calculated peak inductor current.

In this example, the maximum load for the boost converter is 500 mA, and the minimum input voltage is 3 V. Assuming the efficiency under this condition is 90%, and a typical 2.2-μH inductor is adopted in this application, so the boost converter works in continuous operation mode by the calculation. The current ripple is 500mA and the inductor peak current is calculated as 1.18 A. To leave some margin, a 2.2-μH inductor with at least 1.4-A saturation current is recommended for this application. Table 5 lists the recommended inductors for TPS61322A device.

Table 5. List of Inductors

INDUCTANCE [μH]	SATURATION CURRENT [A]	DC RESISTANCE [mΩ]	SIZE (LxWxH) (mm)	PART NUMBER	MANUFACTURER ⁽¹⁾
2.2	2.3	82	2.5 × 2 × 1.2	DFE252012F-2R2M	MURATA
2.2	2.4	89	2.5 × 2 × 1	HMLQ25201T-2R2MSR	CYNTEC
2.2	2.5	75	3.2 × 2.5 × 1.2	HMME32251B--2R2MS	CYNTEC

(1) See [Third-party Products Disclaimer](#)

9.2.2.2.2 Schottky Diode Selection

The high switching frequency of TPS61322xx demands a high-speed rectifying switch for optimum efficiency. Ensure that the average and peak current rating of the diode exceeds the average output current and peak inductor current. In addition, the reverse breakdown voltage of the diode must exceed the maximum output voltage of the converter. A snubber circuit consisting of a resistor R1 and a capacitor C2 is needed if the Schottky diode D1 is soldered. The capacitance of C2 must be larger than triple times of the diode capacitance. The typical value of the resistor R1 is 5 Ω , and the typical value of the capacitor C2 is 120 pF.

9.2.2.2.3 Capacitor Selection

Refer to [Capacitor Selection](#) for the detailed design steps. Table 6 lists the recommended inductor and capacitor combination. Three 10- μ F capacitors in parallel are recommended to get the desired effective capacitance.

Table 6. List of Inductor and Capacitor

INDUCTANCE [μ H]	CAPACITANCE [μ F]	LOAD [mA]	PACKAGE	PART NUMBER	MANUFACTURER ⁽¹⁾
1	3 \times 10	500	0603	GRM188R60J106ME84D	MURATA
2.2	3 \times 10	500	0603	GRM188R60J106ME84D	MURATA
4.7	2 \times 22	500	0805	GRM21BZ71A226ME15	MURATA

(1) See [Third-party Products Disclaimer](#)

9.2.2.3 Application Curves

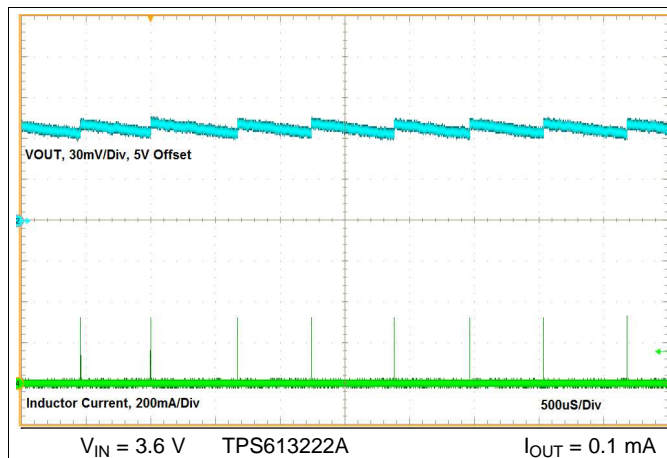

Figure 25. Switching Waveform at Light Load

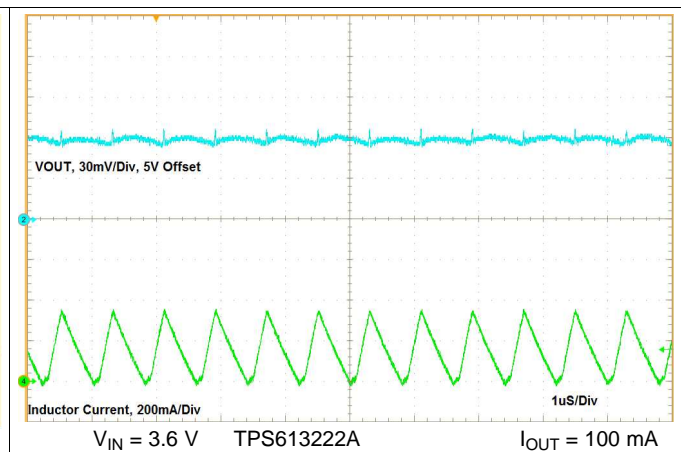

Figure 26. Switching Waveform at Heavy Load

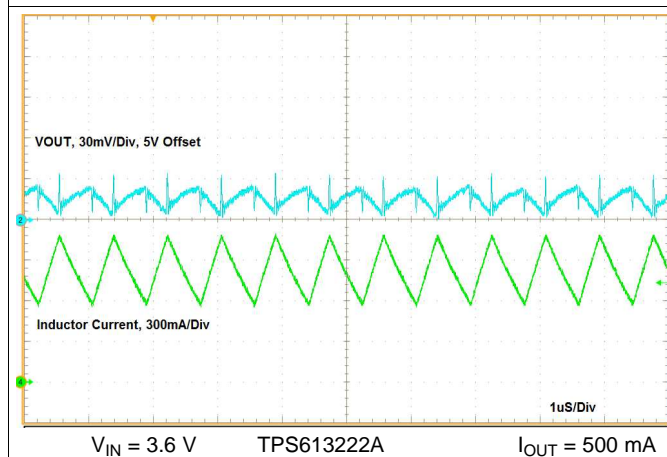

Figure 27. Switching Waveform at Heavy Load

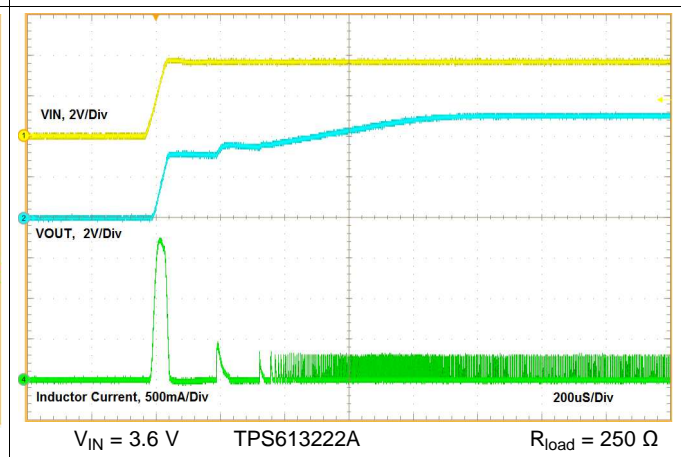

Figure 28. Start-up by VIN

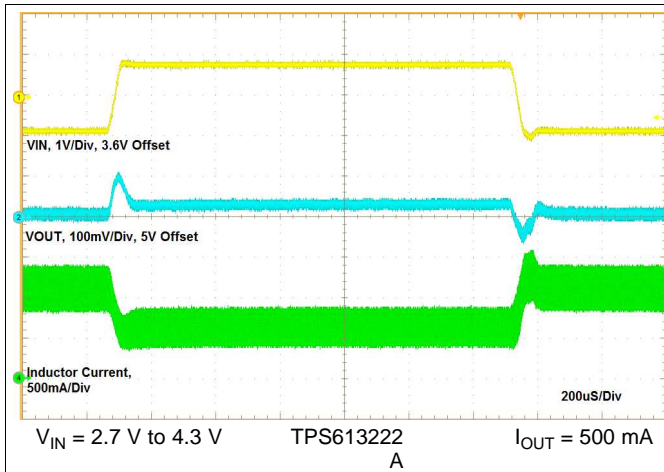

Figure 29. Line Transient

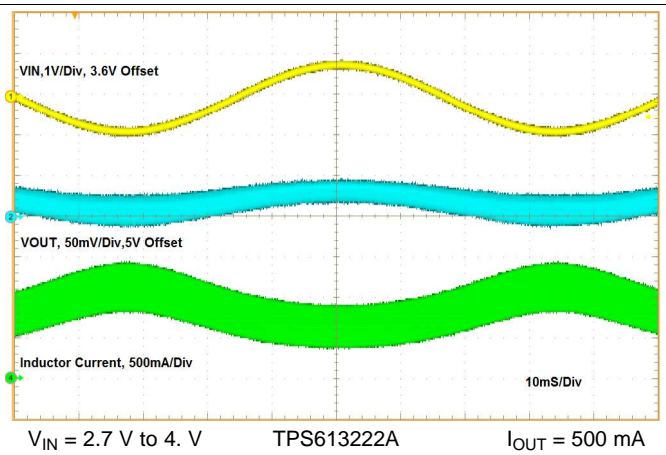

Figure 30. Line Regulation

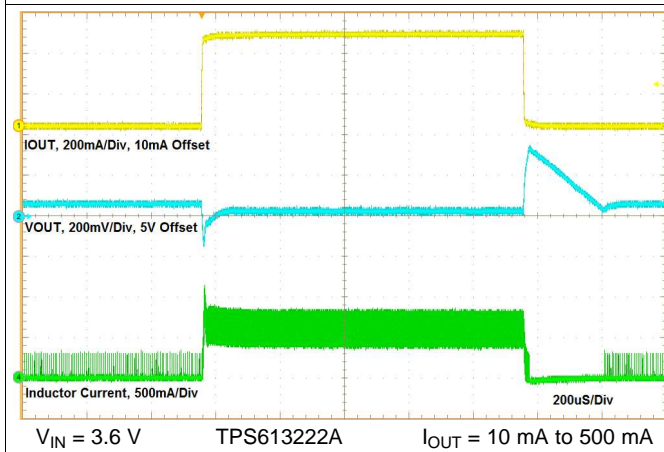

Figure 31. Load Transient

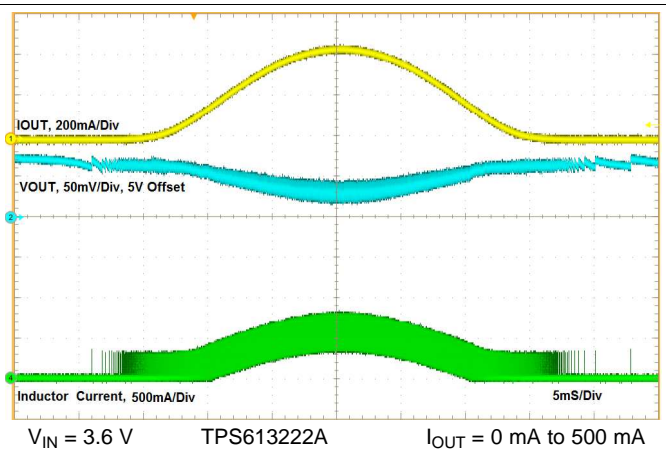

Figure 32. Load Regulation

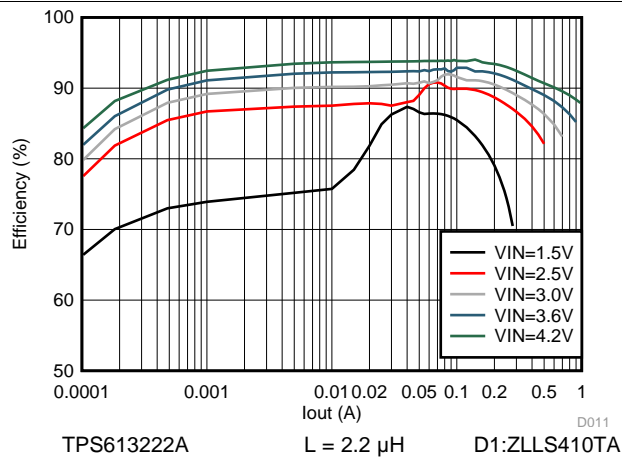

Figure 33. Efficiency with Different Input Voltage

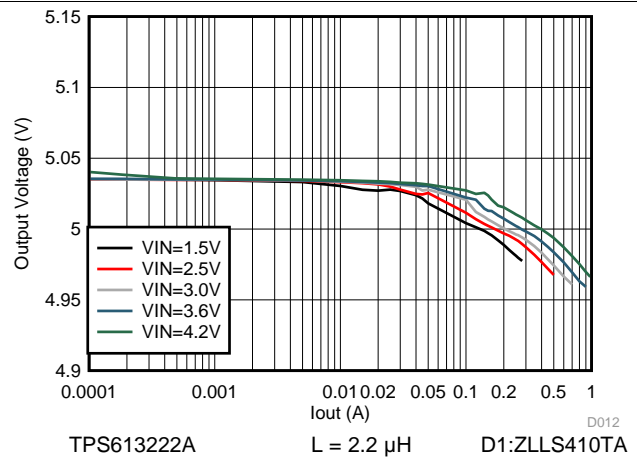

Figure 34. Load Regulation

9.3 System Examples

TPS61322xx can be easily shut down with an external switch Q1 as shown in Figure 35. The switch can be mechanical switch, a P-channel MOSFET, or a PNP transistor. For a mechanical switch, there is no control logic needed to turn on or turn off the switch.

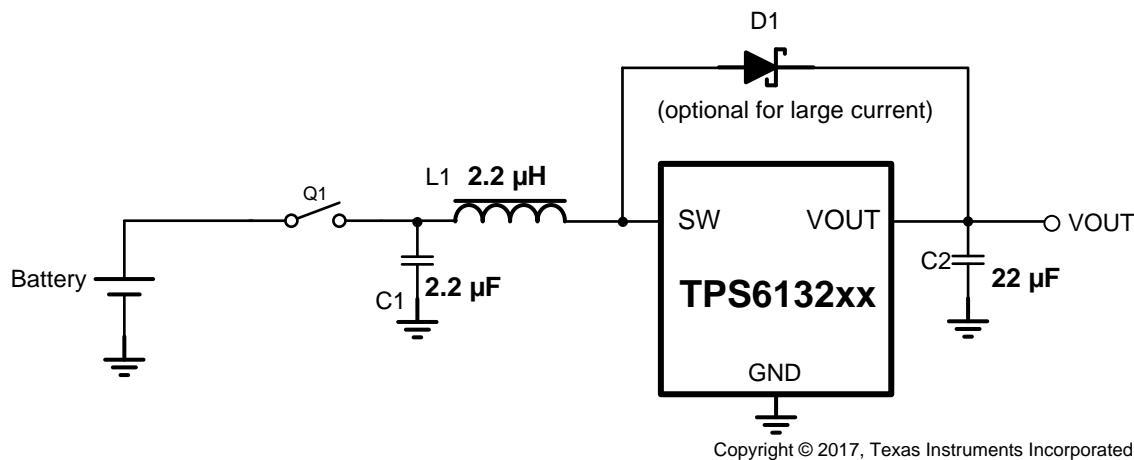

Figure 35. True Shutdown for TPS61322xx

9.3.1 Detail Design Schematics

The Figure 36 shows the application circuit when the power supply of the micro controller unit (MCU) is not less than the battery voltage. The Figure 37 shows the application circuit when the power supply of the micro controller unit (MCU) is less than the battery voltage

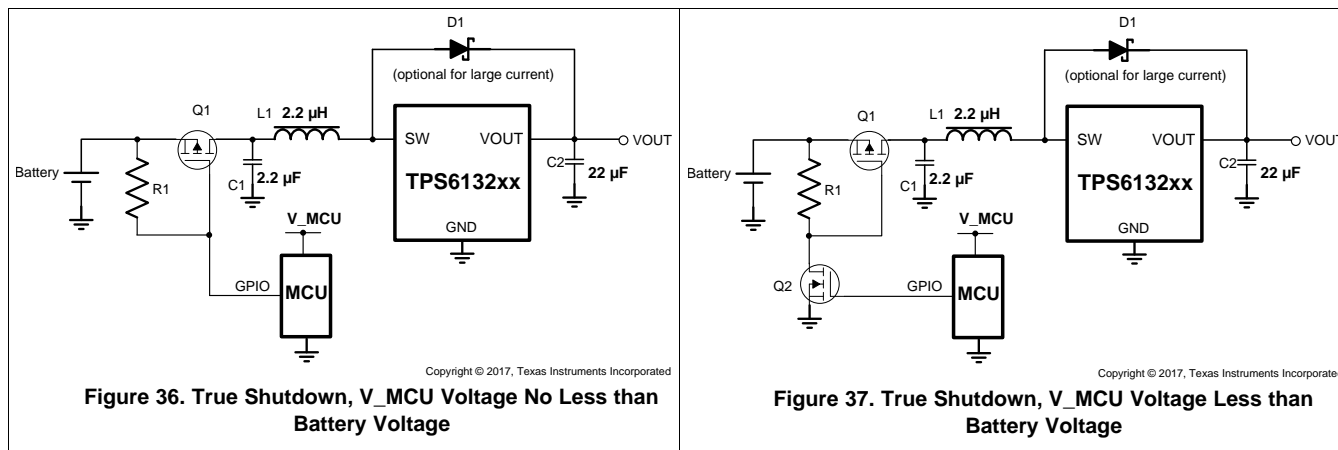

Figure 36. True Shutdown, V_MCU Voltage No Less than Battery Voltage

Figure 37. True Shutdown, V_MCU Voltage Less than Battery Voltage

10 Power Supply Recommendations

The TPS61322xx is designed to operate from an input voltage supply range between 0.9 V to 5.5 V. The power supply can be alkaline battery, NiMH rechargeable battery, Li-Mn battery or rechargeable Li-ion battery. The input supply must be well regulated with the rating of the TPS61322xx.

11 Layout

11.1 Layout Guidelines

As for all switching power supplies, the layout is an important step in the design, especially at high peak currents and high switching frequencies. If the layout is not carefully done, the regulator could show stability problems as well as EMI problems. Therefore, use wide and short traces for the main current path and for the power ground paths. Place the output capacitor, as well as the inductor, as close as possible to the device.

TPS61322

11.2 Layout Examples

A large ground plane on the top and bottom is good for thermal performance.

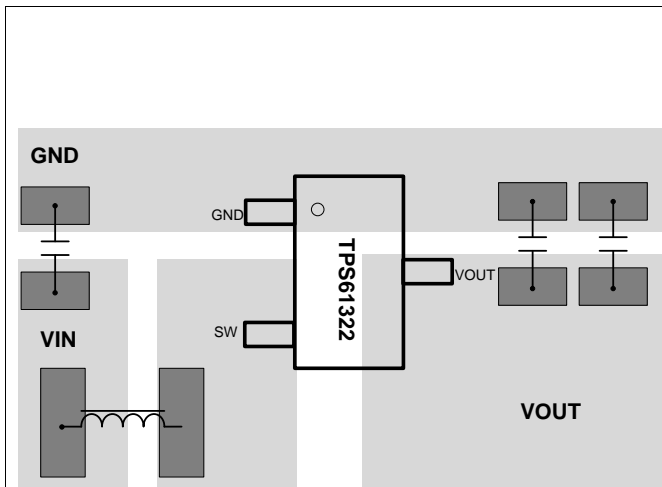

Figure 38. TPS61322 Layout

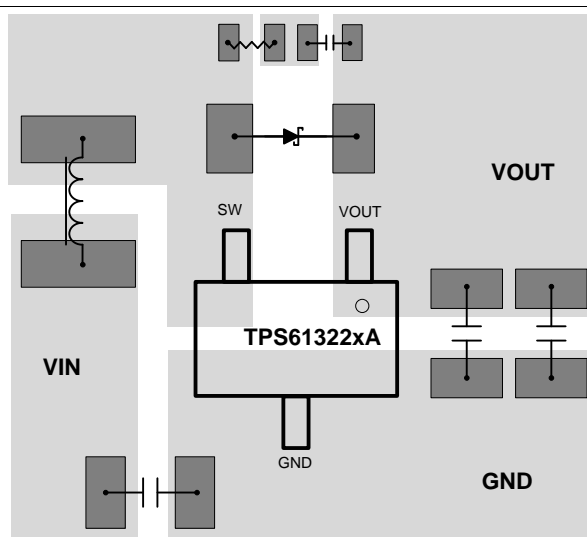

Figure 39. TPS61322xA DBZ Package Layout

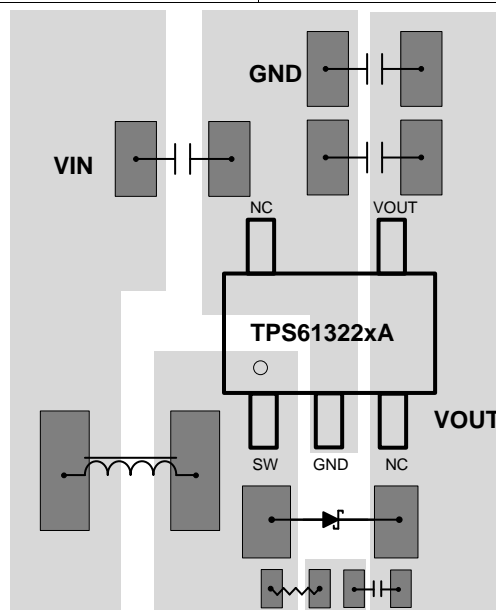

Figure 40. TPS61322xA DBV Package Layout

12 器件和文档支持

12.1 器件支持

12.1.1 第三方产品免责声明

TI 发布的与第三方产品或服务有关的信息，不能构成与此类产品或服务或保修的适用性有关的认可，不能构成此类产品或服务单独或与任何 TI 产品或服务一起的表示或认可。

12.1.2 开发支持

12.1.2.1 使用 **WEBENCH®** 工具创建定制设计

单击[此处](#)，使用 TPS61322 器件并借助 WEBENCH® 电源设计器创建定制设计。

1. 首先输入输入电压 (V_{IN})、输出电压 (V_{OUT}) 和输出电流 (I_{OUT}) 要求。
2. 使用优化器拨盘优化该设计的关键参数，如效率、尺寸和成本。
3. 将生成的设计与德州仪器 (TI) 的其他可行的解决方案进行比较。

WEBENCH 电源设计器可提供定制原理图以及罗列实时价格和组件供货情况的物料清单。

在多数情况下，可执行以下操作：

- 运行电气仿真，观察重要波形以及电路性能
- 运行热性能仿真，了解电路板热性能
- 将定制原理图和布局方案以常用 CAD 格式导出
- 打印设计方案的 PDF 报告并与同事共享

有关 WEBENCH 工具的详细信息，请访问 www.ti.com.cn/WEBENCH。

12.2 文档支持

12.2.1 相关文档

请参阅如下相关文档：

《[TPS61322-BMC001 评估模块用户指南](#)》

12.3 接收文档更新通知

要接收文档更新通知，请导航至 TI.com.cn 上的器件产品文件夹。单击右上角的 [通知我](#) 进行注册，即可每周接收产品信息更改摘要。有关更改的详细信息，请查看任何已修订文档中包含的修订历史记录。

12.4 社区资源

下列链接提供到 TI 社区资源的连接。链接的内容由各个分销商“按照原样”提供。这些内容并不构成 TI 技术规范，并且不一定反映 TI 的观点；请参阅 TI 的 [《使用条款》](#)。

TI E2E™ Online Community *TI's Engineer-to-Engineer (E2E) Community*. Created to foster collaboration among engineers. At e2e.ti.com, you can ask questions, share knowledge, explore ideas and help solve problems with fellow engineers.

Design Support *TI's Design Support* Quickly find helpful E2E forums along with design support tools and contact information for technical support.

12.5 商标

E2E is a trademark of Texas Instruments.

WEBENCH is a registered trademark of Texas Instruments.

All other trademarks are the property of their respective owners.

12.6 静电放电警告



ESD 可能会损坏该集成电路。德州仪器 (TI) 建议通过适当的预防措施处理所有集成电路。如果不遵守正确的处理措施和安装程序，可能会损坏集成电路。

ESD 的损坏小至导致微小的性能降级，大至整个器件故障。精密的集成电路可能更容易受到损坏，这是因为非常细微的参数更改都可能会导致器件与其发布的规格不相符。

12.7 术语表

[SLYZ022](#) — TI 术语表。

这份术语表列出并解释术语、缩写和定义。

13 机械、封装和可订购信息

以下页面包含机械、封装和可订购信息。这些信息是指定器件的最新可用数据。数据如有变更，恕不另行通知，且不会对此文档进行修订。如需获取此数据表的浏览器版本，请查阅左侧的导航栏。

PACKAGING INFORMATION

Orderable Device	Status (1)	Package Type	Package Drawing	Pins	Package Qty	Eco Plan (2)	Lead finish/ Ball material (6)	MSL Peak Temp (3)	Op Temp (°C)	Device Marking (4/5)	Samples
TPS613221ADBVR	ACTIVE	SOT-23	DBV	5	3000	RoHS & Green	NIPDAU SN	Level-2-260C-1 YEAR	-40 to 85	1N4L	Samples
TPS613221ADBVT	ACTIVE	SOT-23	DBV	5	250	RoHS & Green	NIPDAU SN	Level-2-260C-1 YEAR	-40 to 85	1N4L	Samples
TPS613222ADBVR	ACTIVE	SOT-23	DBV	5	3000	RoHS & Green	NIPDAU SN	Level-2-260C-1 YEAR	-40 to 85	1N5L	Samples
TPS613222ADBVT	ACTIVE	SOT-23	DBV	5	250	RoHS & Green	NIPDAU SN	Level-2-260C-1 YEAR	-40 to 85	1N5L	Samples
TPS613223ADBVR	ACTIVE	SOT-23	DBV	5	3000	RoHS & Green	NIPDAU SN	Level-2-260C-1 YEAR	-40 to 85	1NRL	Samples
TPS613223ADBVT	ACTIVE	SOT-23	DBV	5	250	RoHS & Green	NIPDAU SN	Level-2-260C-1 YEAR	-40 to 85	1NRL	Samples
TPS613226ADBVR	ACTIVE	SOT-23	DBV	5	3000	RoHS & Green	NIPDAU SN	Level-2-260C-1 YEAR	-40 to 85	1N6L	Samples
TPS613226ADBVT	ACTIVE	SOT-23	DBV	5	250	RoHS & Green	NIPDAU SN	Level-2-260C-1 YEAR	-40 to 85	1N6L	Samples
TPS61322DBZR	ACTIVE	SOT-23	DBZ	3	3000	RoHS & Green	SN	Level-1-260C-UNLIM	-40 to 85	1EME	Samples
TPS61322DBZT	ACTIVE	SOT-23	DBZ	3	250	RoHS & Green	SN	Level-1-260C-UNLIM	-40 to 85	1EME	Samples

(1) The marketing status values are defined as follows:

ACTIVE: Product device recommended for new designs.

LIFEBUY: TI has announced that the device will be discontinued, and a lifetime-buy period is in effect.

NRND: Not recommended for new designs. Device is in production to support existing customers, but TI does not recommend using this part in a new design.

PREVIEW: Device has been announced but is not in production. Samples may or may not be available.

OBSOLETE: TI has discontinued the production of the device.

(2) **RoHS:** TI defines "RoHS" to mean semiconductor products that are compliant with the current EU RoHS requirements for all 10 RoHS substances, including the requirement that RoHS substance do not exceed 0.1% by weight in homogeneous materials. Where designed to be soldered at high temperatures, "RoHS" products are suitable for use in specified lead-free processes. TI may reference these types of products as "Pb-Free".

RoHS Exempt: TI defines "RoHS Exempt" to mean products that contain lead but are compliant with EU RoHS pursuant to a specific EU RoHS exemption.

Green: TI defines "Green" to mean the content of Chlorine (Cl) and Bromine (Br) based flame retardants meet JS709B low halogen requirements of <=1000ppm threshold. Antimony trioxide based flame retardants must also meet the <=1000ppm threshold requirement.

(3) MSL, Peak Temp. - The Moisture Sensitivity Level rating according to the JEDEC industry standard classifications, and peak solder temperature.

(4) There may be additional marking, which relates to the logo, the lot trace code information, or the environmental category on the device.

⁽⁵⁾ Multiple Device Markings will be inside parentheses. Only one Device Marking contained in parentheses and separated by a "~" will appear on a device. If a line is indented then it is a continuation of the previous line and the two combined represent the entire Device Marking for that device.

⁽⁶⁾ Lead finish/Ball material - Orderable Devices may have multiple material finish options. Finish options are separated by a vertical ruled line. Lead finish/Ball material values may wrap to two lines if the finish value exceeds the maximum column width.

Important Information and Disclaimer:The information provided on this page represents TI's knowledge and belief as of the date that it is provided. TI bases its knowledge and belief on information provided by third parties, and makes no representation or warranty as to the accuracy of such information. Efforts are underway to better integrate information from third parties. TI has taken and continues to take reasonable steps to provide representative and accurate information but may not have conducted destructive testing or chemical analysis on incoming materials and chemicals. TI and TI suppliers consider certain information to be proprietary, and thus CAS numbers and other limited information may not be available for release.

In no event shall TI's liability arising out of such information exceed the total purchase price of the TI part(s) at issue in this document sold by TI to Customer on an annual basis.

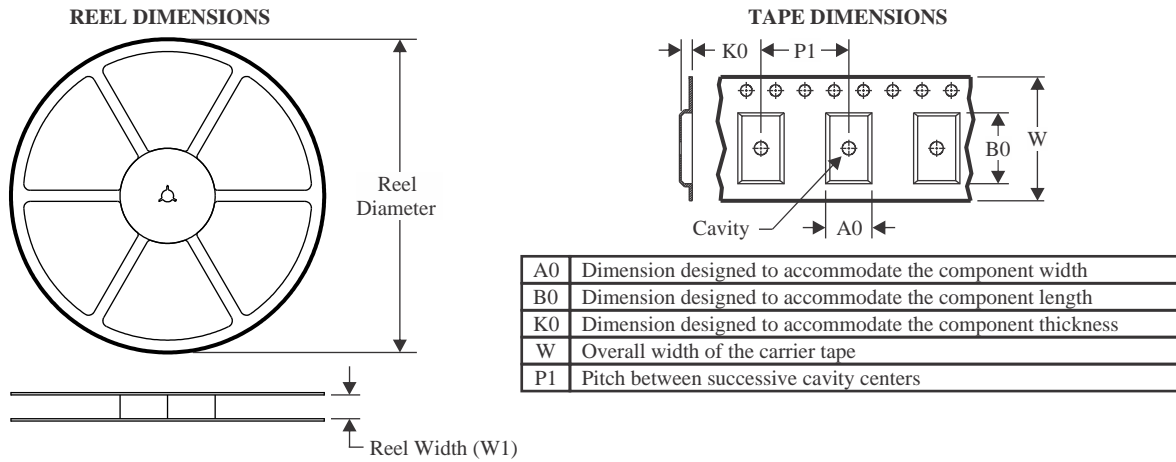
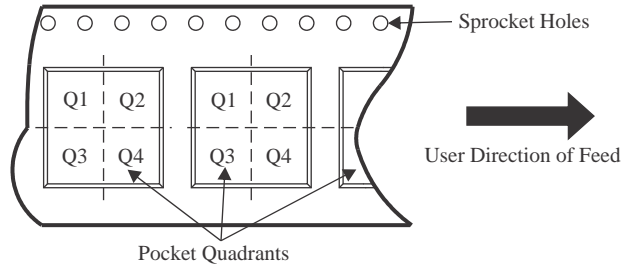
TAPE AND REEL INFORMATION

QUADRANT ASSIGNMENTS FOR PIN 1 ORIENTATION IN TAPE

*All dimensions are nominal

Device	Package Type	Package Drawing	Pins	SPQ	Reel Diameter (mm)	Reel Width W1 (mm)	A0 (mm)	B0 (mm)	K0 (mm)	P1 (mm)	W (mm)	Pin1 Quadrant
TPS613221ADBVR	SOT-23	DBV	5	3000	180.0	8.4	3.2	3.2	1.4	4.0	8.0	Q3
TPS613221ADBVR	SOT-23	DBV	5	3000	180.0	8.4	3.2	3.2	1.4	4.0	8.0	Q3
TPS613221ADBVT	SOT-23	DBV	5	250	180.0	8.4	3.2	3.2	1.4	4.0	8.0	Q3
TPS613221ADBVT	SOT-23	DBV	5	250	180.0	8.4	3.2	3.2	1.4	4.0	8.0	Q3
TPS613222ADBVR	SOT-23	DBV	5	3000	180.0	8.4	3.2	3.2	1.4	4.0	8.0	Q3
TPS613222ADBVR	SOT-23	DBV	5	3000	180.0	8.4	3.2	3.2	1.4	4.0	8.0	Q3
TPS613222ADBVT	SOT-23	DBV	5	250	180.0	8.4	3.2	3.2	1.4	4.0	8.0	Q3
TPS613222ADBVT	SOT-23	DBV	5	250	180.0	8.4	3.2	3.2	1.4	4.0	8.0	Q3
TPS613223ADBVR	SOT-23	DBV	5	3000	180.0	8.4	3.2	3.2	1.4	4.0	8.0	Q3
TPS613223ADBVR	SOT-23	DBV	5	3000	180.0	8.4	3.2	3.2	1.4	4.0	8.0	Q3
TPS613223ADBVT	SOT-23	DBV	5	250	180.0	8.4	3.2	3.2	1.4	4.0	8.0	Q3
TPS613223ADBVT	SOT-23	DBV	5	250	180.0	8.4	3.2	3.2	1.4	4.0	8.0	Q3
TPS613226ADBVR	SOT-23	DBV	5	3000	180.0	8.4	3.2	3.2	1.4	4.0	8.0	Q3
TPS613226ADBVR	SOT-23	DBV	5	3000	180.0	8.4	3.2	3.2	1.4	4.0	8.0	Q3
TPS613226ADBVT	SOT-23	DBV	5	250	180.0	8.4	3.2	3.2	1.4	4.0	8.0	Q3
TPS613226ADBVT	SOT-23	DBV	5	250	180.0	8.4	3.2	3.2	1.4	4.0	8.0	Q3

Device	Package Type	Package Drawing	Pins	SPQ	Reel Diameter (mm)	Reel Width W1 (mm)	A0 (mm)	B0 (mm)	K0 (mm)	P1 (mm)	W (mm)	Pin1 Quadrant
TPS61322DBZR	SOT-23	DBZ	3	3000	178.0	9.0	3.15	2.77	1.22	4.0	8.0	Q3
TPS61322DBZT	SOT-23	DBZ	3	250	178.0	9.0	3.15	2.77	1.22	4.0	8.0	Q3

TAPE AND REEL BOX DIMENSIONS

*All dimensions are nominal

Device	Package Type	Package Drawing	Pins	SPQ	Length (mm)	Width (mm)	Height (mm)
TPS613221ADBVR	SOT-23	DBV	5	3000	210.0	185.0	35.0
TPS613221ADBVR	SOT-23	DBV	5	3000	210.0	185.0	35.0
TPS613221ADBVT	SOT-23	DBV	5	250	210.0	185.0	35.0
TPS613221ADBVT	SOT-23	DBV	5	250	210.0	185.0	35.0
TPS613222ADBVR	SOT-23	DBV	5	3000	210.0	185.0	35.0
TPS613222ADBVR	SOT-23	DBV	5	3000	210.0	185.0	35.0
TPS613222ADBVT	SOT-23	DBV	5	250	210.0	185.0	35.0
TPS613222ADBVT	SOT-23	DBV	5	250	210.0	185.0	35.0
TPS613223ADBVR	SOT-23	DBV	5	3000	210.0	185.0	35.0
TPS613223ADBVR	SOT-23	DBV	5	3000	210.0	185.0	35.0
TPS613223ADBVT	SOT-23	DBV	5	250	210.0	185.0	35.0
TPS613223ADBVT	SOT-23	DBV	5	250	210.0	185.0	35.0
TPS613226ADBVR	SOT-23	DBV	5	3000	210.0	185.0	35.0
TPS613226ADBVR	SOT-23	DBV	5	3000	210.0	185.0	35.0
TPS613226ADBVT	SOT-23	DBV	5	250	210.0	185.0	35.0
TPS613226ADBVT	SOT-23	DBV	5	250	210.0	185.0	35.0
TPS61322DBZR	SOT-23	DBZ	3	3000	180.0	180.0	18.0
TPS61322DBZT	SOT-23	DBZ	3	250	180.0	180.0	18.0

EXAMPLE BOARD LAYOUT

DBV0005A

SOT-23 - 1.45 mm max height

SMALL OUTLINE TRANSISTOR

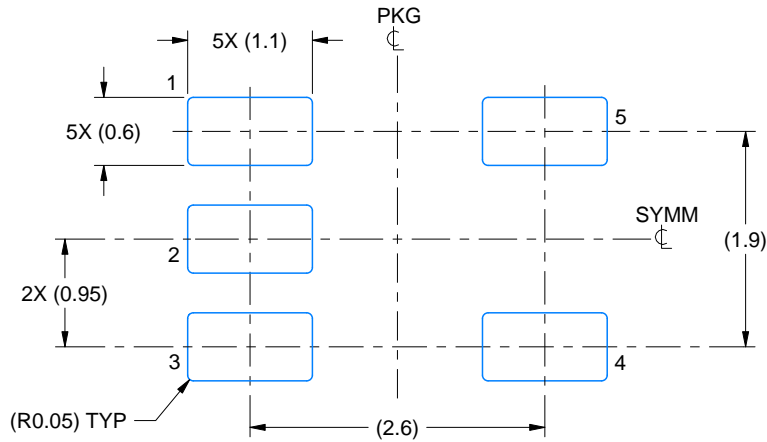

LAND PATTERN EXAMPLE
EXPOSED METAL SHOWN
SCALE:15X

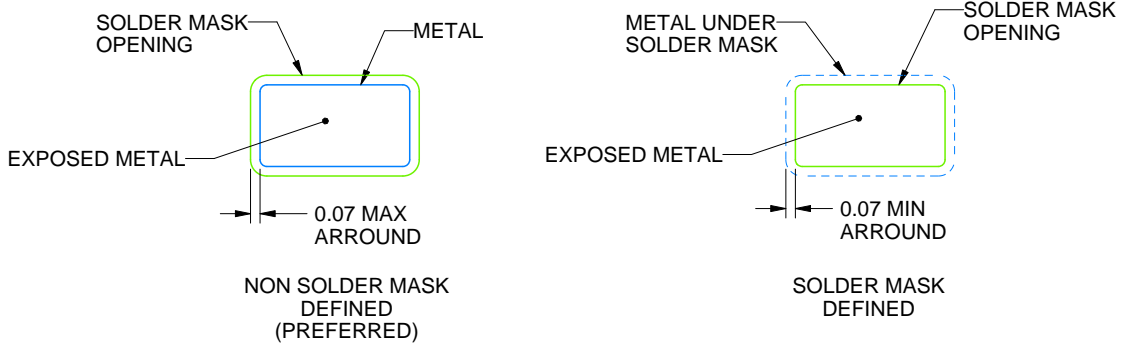

SOLDER MASK DETAILS

4214839/F 06/2021

NOTES: (continued)

- 5. Publication IPC-7351 may have alternate designs.
- 6. Solder mask tolerances between and around signal pads can vary based on board fabrication site.

EXAMPLE STENCIL DESIGN

DBV0005A

SOT-23 - 1.45 mm max height

SMALL OUTLINE TRANSISTOR

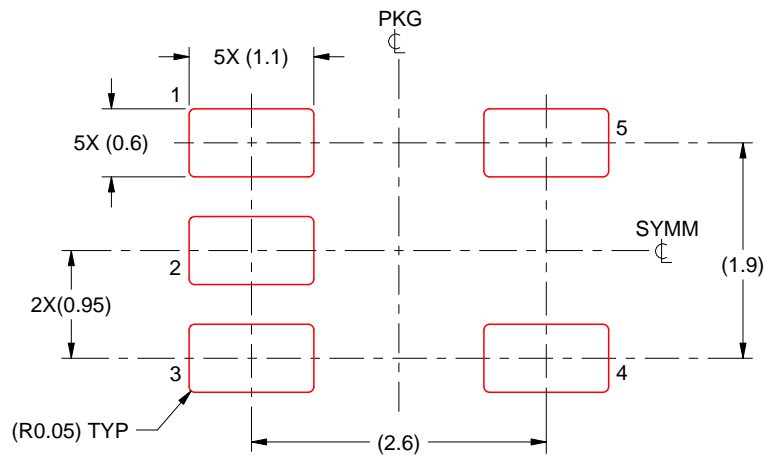

SOLDER PASTE EXAMPLE
BASED ON 0.125 mm THICK STENCIL
SCALE:15X

4214839/F 06/2021

NOTES: (continued)

7. Laser cutting apertures with trapezoidal walls and rounded corners may offer better paste release. IPC-7525 may have alternate design recommendations.
8. Board assembly site may have different recommendations for stencil design.

GENERIC PACKAGE VIEW

DBZ 3

SOT-23 - 1.12 mm max height

SMALL OUTLINE TRANSISTOR

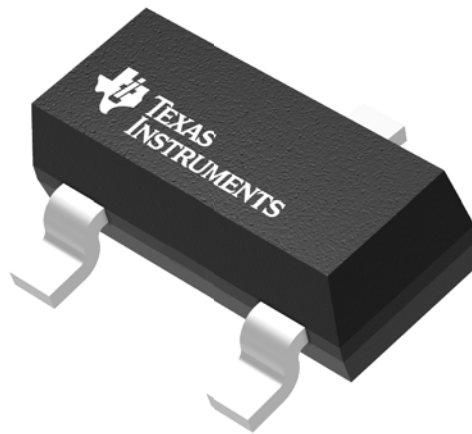

Images above are just a representation of the package family, actual package may vary.
Refer to the product data sheet for package details.

4203227/C

DBZ0003A

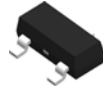

PACKAGE OUTLINE

SOT-23 - 1.12 mm max height

SMALL OUTLINE TRANSISTOR

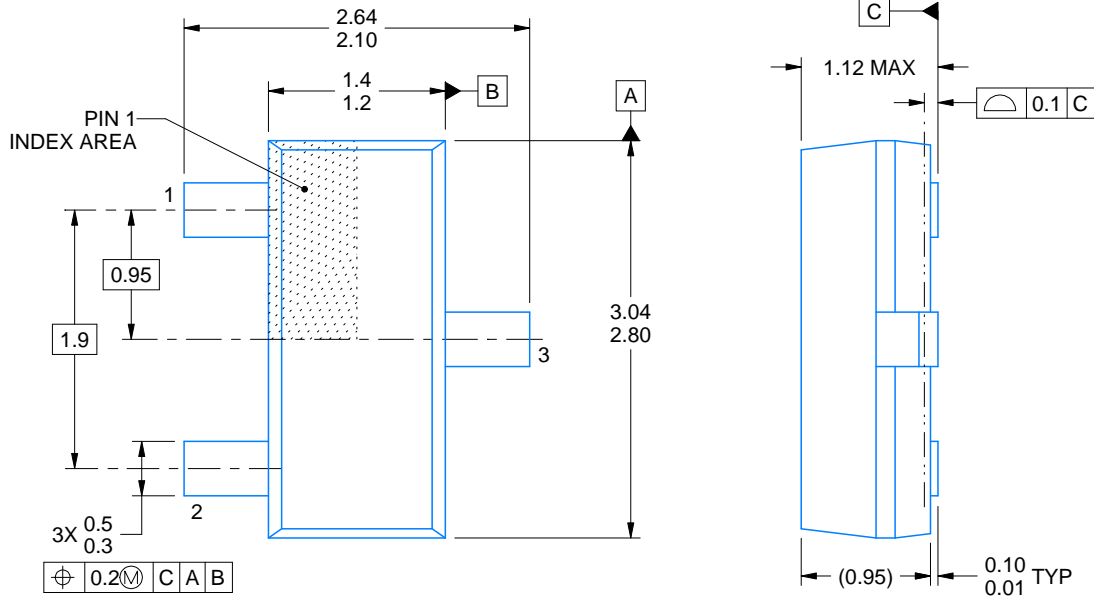

4214838/C 04/2017

NOTES:

1. All linear dimensions are in millimeters. Any dimensions in parenthesis are for reference only. Dimensioning and tolerancing per ASME Y14.5M.
2. This drawing is subject to change without notice.
3. Reference JEDEC registration TO-236, except minimum foot length.

EXAMPLE BOARD LAYOUT

DBZ0003A

SOT-23 - 1.12 mm max height

SMALL OUTLINE TRANSISTOR

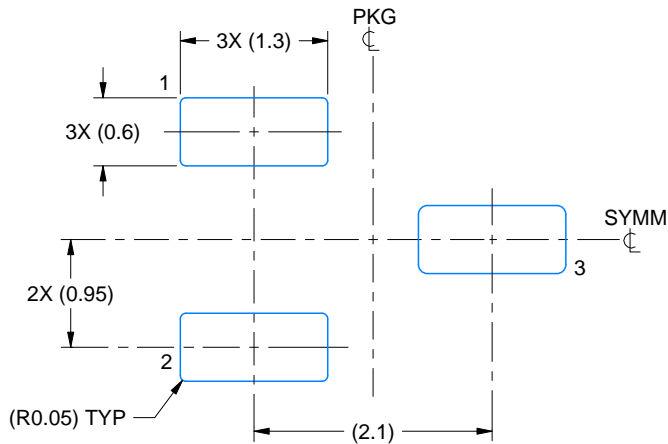

LAND PATTERN EXAMPLE
SCALE:15X

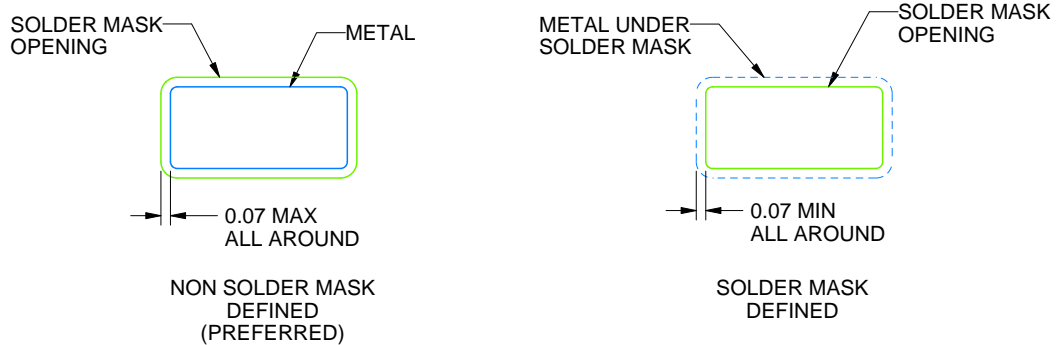

SOLDER MASK DETAILS

4214838/C 04/2017

NOTES: (continued)

4. Publication IPC-7351 may have alternate designs.
5. Solder mask tolerances between and around signal pads can vary based on board fabrication site.

EXAMPLE STENCIL DESIGN

DBZ0003A

SOT-23 - 1.12 mm max height

SMALL OUTLINE TRANSISTOR

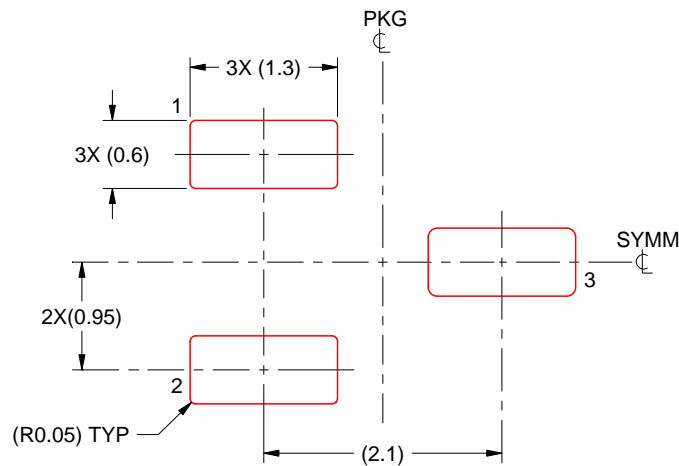

SOLDER PASTE EXAMPLE
BASED ON 0.125 THICK STENCIL
SCALE:15X

4214838/C 04/2017

NOTES: (continued)

6. Laser cutting apertures with trapezoidal walls and rounded corners may offer better paste release. IPC-7525 may have alternate design recommendations.
7. Board assembly site may have different recommendations for stencil design.

重要声明和免责声明

TI“按原样”提供技术和可靠性数据（包括数据表）、设计资源（包括参考设计）、应用或其他设计建议、网络工具、安全信息和其他资源，不保证没有瑕疵且不做任何明示或暗示的担保，包括但不限于对适销性、某特定用途方面的适用性或不侵犯任何第三方知识产权的暗示担保。

这些资源可供使用 TI 产品进行设计的熟练开发人员使用。您将自行承担以下全部责任：(1) 针对您的应用选择合适的 TI 产品，(2) 设计、验证并测试您的应用，(3) 确保您的应用满足相应标准以及任何其他功能安全、信息安全、监管或其他要求。

这些资源如有变更，恕不另行通知。TI 授权您仅可将这些资源用于研发本资源所述的 TI 产品的应用。严禁对这些资源进行其他复制或展示。您无权使用任何其他 TI 知识产权或任何第三方知识产权。您应全额赔偿因在这些资源的使用中对 TI 及其代表造成的任何索赔、损害、成本、损失和债务，TI 对此概不负责。

TI 提供的产品受 [TI 的销售条款](#) 或 [ti.com](#) 上其他适用条款/TI 产品随附的其他适用条款的约束。TI 提供这些资源并不会扩展或以其他方式更改 TI 针对 TI 产品发布的适用的担保或担保免责声明。

TI 反对并拒绝您可能提出的任何其他或不同的条款。

邮寄地址：Texas Instruments, Post Office Box 655303, Dallas, Texas 75265

Copyright © 2022，德州仪器 (TI) 公司