

TPS6256x 采用 TSOT 和 2mm x 2mm x 0.8mm QFN 封装的 2.25MHz、600mA 降压转换器

1 特性

- 输出电流最高达 600mA
- 输入电压范围：2.5V 至 5.5V
- PWM 模式下的输出电压精度为 $\pm 2.5\%$
- 静态电流典型值为 15 μ A
- 可实现最低压降的 100% 占空比
- 软启动
- 采用小外形尺寸晶体管 (SOT) 和 2mm x 2mm x 0.8mm 小外形尺寸无引线 (SON) 封装
- 有关改进的特性集，请参见《TPS62290 器件》（文献编号：SLVS764）

2 应用

- 个人数字助理 (PDA)、掌上电脑和便携式媒体播放器
- 低功耗数字信号处理器 (DSP) 电源
- 负载点 (POL) 应用

3 说明

TPS62560 器件是一款高效同步降压转换器，针对由电池供电的便携式应用进行了优化。在诸如单节锂离子电池或由其他常见化学成分组成的 AA 或 AAA 电池供电下，该器件可提供高达 600mA 的输出电流。

凭借 2.5V 至 5.5V 的输入电压范围，该器件适用于为各类便携式手持设备或 POL 应用供电。

TPS62560 系列工作在 2.25MHz 固定开关频率下，并且在轻负载电流条件下会进入节能模式，从而在整个负载电流范围内保持高效率。

该节能模式针对低输出电压纹波进行了优化。对于低噪声应用，可通过将 MODE 引脚拉为高电平来强制器件进入固定频率 PWM 模式。在关断模式中，电流消耗减小至 1 μ A 以下。TPS62560 允许使用小型电感和电容，以减小解决方案尺寸。

TPS62560 和 TPS62562 采用 2mm x 2mm、6 引脚 SON 封装，而 TPS62561 则采用 5 引脚 SOT 封装。

器件信息⁽¹⁾

器件型号	封装	封装尺寸 (标称值)
TPS62560, TPS62562	SON (6)	2.00mm x 2.00mm
TPS62561	小外形尺寸晶体管 (SOT) (5)	2.90mm x 1.60mm

(1) 要了解所有可用封装，请见数据表末尾的可订购产品附录。

典型应用电路原理图

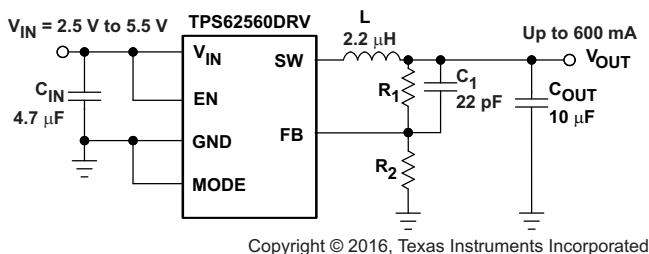

效率与输出电流间的关系

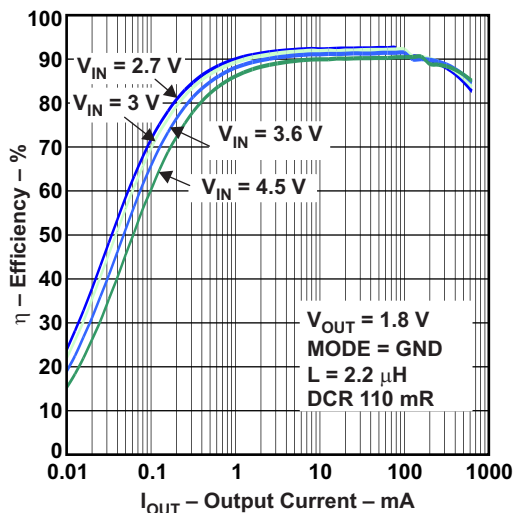

目录

1	特性	1	9	Application and Implementation	10
2	应用	1	9.1	Application Information.....	10
3	说明	1	9.2	Typical Application	10
4	修订历史记录	2	9.3	System Examples	17
5	Device Comparison Table	3	10	Power Supply Recommendations	17
6	Pin Configuration and Functions	3	11	Layout	18
7	Specifications	4	11.1	Layout Guidelines	18
7.1	Absolute Maximum Ratings	4	11.2	Layout Examples.....	18
7.2	ESD Ratings.....	4	12	器件和文档支持	20
7.3	Recommended Operating Conditions.....	4	12.1	器件支持	20
7.4	Thermal Information	4	12.2	相关链接	20
7.5	Electrical Characteristics.....	5	12.3	接收文档更新通知	20
7.6	Typical Characteristics	6	12.4	社区资源	20
8	Detailed Description	7	12.5	商标	20
8.1	Overview	7	12.6	静电放电警告	20
8.2	Functional Block Diagram	7	12.7	Glossary	20
8.3	Feature Description.....	8	13	机械、封装和可订购信息	20
8.4	Device Functional Modes.....	9			

4 修订历史记录

注：之前版本的页码可能与当前版本有所不同。

Changes from Revision C (December 2009) to Revision D	Page
• 已添加 ESD 额定值表，特性 描述部分，器件功能模式，应用和实施部分，电源相关建议部分，布局部分，器件和文档支持部分以及机械、封装和可订购信息部分。	1
• 已删除所有层级下的订购信息表	1
• 已更改 文本字符串，从“...高达 1000mA 的输出电流...” 更改为“...高达 600mA 的输出电流...”（说明）。	1
• Corrected typographical errors in Figure 32; from " $V_{IN} = 2\text{ V to }6\text{ V}$ " to " $V_{IN} = 2.5\text{ V to }5.5\text{ V}$ "	17

Changes from Revision B (March 2009) to Revision C	Page
• 已删除 高效降压转换器	1
• 已删除 特性要点中的“宽”	1
• 已删除 特性中的“面向具有扩展电压范围的锂离子电池”	1
• 已删除 特性中的“可调和固定两种输出电压选项”	1
• 已删除 特性中的“2.25MHz 固定工作频率”	1
• 已删除 特性中的“轻负载电流下的节能模式”	1
• 已删除 特性中的“可在轻载时进行电压定位”	1
• 已删除 特性中的“允许 < 1mm 的解决方案高度”	1
• 已更改 说明 以更好地反映器件功能以及与 TPS62260 的差异	1

Changes from Revision A (July 2008) to Revision B	Page
• 已添加 TPS62562 器件编号。	1

Changes from Original (January 2008) to Revision A	Page
• 已更改。版本 A 是本数据表的完全改版。	1

5 Device Comparison Table

Part Number	Package	Mode Pin	Output Voltage ⁽¹⁾	Device Marking ⁽²⁾
TPS62560	SON (6)	yes	Adjustable	CEY
TPS62561	SOT (5)	forced PWM only	Adjustable	CVO
TPS62562	SON (6)	yes	1.8 V fixed	NXT

(1) Contact TI for other fixed output voltage options

(2) For the most current package and ordering information, see [机械、封装和可订购信息](#), or see the TI website at www.ti.com

6 Pin Configuration and Functions



Pin Functions

NAME	PIN		I/O	DESCRIPTION
	No. QFN-6	No. TSOT23-5		
EN	4	3	I	This is the enable pin of the device. Pulling this pin to low forces the device into shutdown mode. Pulling this pin to high enables the device. This pin must be terminated.
FB	3	4	I	Feedback pin for the internal regulation loop. Connect the external resistor divider to this pin. In the fixed-output-voltage option, connect this terminal directly to the output capacitor.
GND	6	2	—	GND supply pin
MODE	2	N/A	I	This pin is only available as a QFN package option. MODE pin = high forces the device to operate in the fixed-frequency PWM mode. MODE pin = low enables the power-save mode with automatic transition from PFM mode to fixed-frequency PWM mode.
SW	1	5	O	This is the switch pin and is connected to the internal MOSFET switches. Connect the external inductor between this pin and the output capacitor.
V_{IN}	5	1	—	V_{IN} power-supply pin
Exposed Thermal Pad	—	N/A	—	Must be soldered to achieve appropriate power dissipation. Should be connected to GND.

7 Specifications

7.1 Absolute Maximum Ratings

over operating free-air temperature range (unless otherwise noted)⁽¹⁾

	MIN	MAX	UNIT
Input voltage range ⁽²⁾	-0.3	7	V
Voltage range at EN, MODE	-0.3	$V_{IN} + 0.3, \leq 7$	
Voltage on SW	-0.3	7	
Peak output current	Internally limited		A
T _J Maximum operating junction temperature	-40	125	°C
T _{stg} Storage temperature	-65	150	°C

- (1) Stresses beyond those listed under *absolute maximum ratings* may cause permanent damage to the device. These are stress ratings only and functional operation of the device at these or any other conditions beyond those indicated under *recommended operating conditions* is not implied. Exposure to absolute-maximum-rated conditions for extended periods may affect device reliability.
- (2) All voltage values are with respect to the network ground terminal.

7.2 ESD Ratings

		VALUE	UNIT
V _(ESD) Electrostatic discharge ⁽¹⁾	Human-body model (HBM), per ANSI/ESDA/JEDEC JS-001 ⁽²⁾	±2000	V
	Charged-device model (CDM), per JEDEC specification JESD22-C101 ⁽³⁾	±1000	
	Machine model	±200	

- (1) The human-body model is a 100-pF capacitor discharged through a 1.5-kΩ resistor into each terminal. The machine model is a 200-pF capacitor discharged directly into each terminal.
- (2) JEDEC document JEP155 states that 500-V HBM allows safe manufacturing with a standard ESD control process. Manufacturing with less than 500-V HBM is possible with the necessary precautions.
- (3) JEDEC document JEP157 states that 250-V CDM allows safe manufacturing with a standard ESD control process. Manufacturing with less than 250-V CDM is possible with the necessary precautions.

7.3 Recommended Operating Conditions

	MIN	MAX	UNIT
V _{IN} Supply voltage	2.5	5.5	V
V _{OUT} Output voltage range for adjustable voltage	0.85	V _{IN}	V
T _A Operating ambient temperature	-40	85	°C
T _J Operating junction temperature	-40	125	°C

7.4 Thermal Information

THERMAL METRIC ⁽¹⁾	TPS62560, TPS62562	TPS62561	UNIT
	DRV (SON)	DDC (SOT)	
	6 PINS	5 PINS	
R _{θJA} Junction-to-ambient thermal resistance	67.8	226.9	°C/W
R _{θJC(top)} Junction-to-case (top) thermal resistance	88.5	40.7	°C/W
R _{θJB} Junction-to-board thermal resistance	37.2	48.8	°C/W
ψ _{JT} Junction-to-top characterization parameter	2.0	0.5	°C/W
ψ _{JB} Junction-to-board characterization parameter	37.6	48.1	°C/W
R _{θJC(bot)} Junction-to-case (bottom) thermal resistance	7.9	n/a	°C/W

- (1) For more information about traditional and new thermal metrics, see the *Semiconductor and IC Package Thermal Metrics* application report, [SPRA953](#).

7.5 Electrical Characteristics

Over full operating ambient temperature range, typical values are at $T_A = 25^\circ\text{C}$. Unless otherwise noted, specifications apply for condition $V_{IN} = EN = 3.6\text{ V}$. External components $C_{IN} = 4.7\ \mu\text{F}$ 0603, $C_{OUT} = 10\ \mu\text{F}$ 0603, $L = 2.2\ \mu\text{H}$

PARAMETER		TEST CONDITIONS	MIN	TYP	MAX	UNIT
SUPPLY						
V_{IN}	Input voltage range		2.5		5.5	V
I_{OUT}	Output current	$V_{IN} = 2.5\text{ V to }5.5\text{ V}$			600	mA
I_Q	Operating quiescent current	$I_{OUT} = 0\text{ mA}$, PFM mode enabled (MODE = GND), device not switching		15		μA
		$I_{OUT} = 0\text{ mA}$, PFM mode enabled (MODE = GND), device switching, $V_{OUT} = 1.8\text{ V}$, See (1)		18.5		
		$I_{OUT} = 0\text{ mA}$, switching with no load (MODE = V_{IN}), PWM operation, $V_{OUT} = 1.8\text{ V}$, $V_{IN} = 3\text{ V}$		3.8		mA
I_{SD}	Shutdown current	EN = GND		0.5		μA
UVLO	Undervoltage lockout threshold	Falling		1.85		V
		Rising		1.95		
ENABLE, MODE						
V_{IH}	High-level input voltage, EN, MODE	$2\text{ V} \leq V_{IN} \leq 5.5\text{ V}$	1		V_{IN}	V
V_{IL}	Low-level input voltage, EN, MODE	$2\text{ V} \leq V_{IN} \leq 5.5\text{ V}$	0		0.4	V
I_{IN}	Input bias current, EN, MODE	EN, MODE = GND or V_{IN}		0.01	1	μA
POWER SWITCH						
$R_{DS(on)}$	High side MOSFET on-resistance	$V_{IN} = V_{GS} = 3.6\text{ V}$, $T_A = 25^\circ\text{C}$		252	492	$\text{m}\Omega$
	Low side MOSFET on-resistance			194	391	
I_{LIMF}	Forward current limit, high and low side MOSFET	$V_{IN} = V_{GS} = 3.6\text{ V}$	0.8	1	1.2	A
T_{SD}	Thermal shutdown	Increasing junction temperature		140		$^\circ\text{C}$
	Thermal-shutdown hysteresis	Decreasing junction temperature		20		
OSCILLATOR						
f_{SW}	Oscillator frequency	$2\text{ V} \leq V_{IN} \leq 5.5\text{ V}$		2.25		MHz
OUTPUT						
V_{OUT}	Adjustable-output voltage range		0.85		V_{IN}	V
V_{OUT}	TPS62562 fixed output voltage	$V_{IN} \geq 1.8\text{ V}$		1.8		V
V_{ref}	Reference voltage			600		mV
V_{FB}	Feedback voltage, PWM mode	MODE = V_{IN} , PWM operation, for fixed-output-voltage versions $V_{FB} = V_{OUT}$, $2.5\text{ V} \leq V_{IN} \leq 5.5\text{ V}$, $0\text{ mA} \leq I_{OUT} \leq 600\text{ mA}$ (2)	-2.5%	0%	2.5%	
	Feedback voltage, PFM mode	MODE = GND, device in PFM mode, voltage positioning active (1)		1%		
	Load regulation	PWM mode		-1		
$t_{Start\ Up}$	Start-up time	Time from active EN to reach 95% of V_{OUT} nominal		500		μs
t_{Ramp}	V_{OUT} ramp-up time	Time to ramp from 5% to 95% of V_{OUT}		250		μs
I_{ikg}	Leakage current into SW terminal	$V_{IN} = 3.6\text{ V}$, $V_{IN} = V_{OUT} = V_{SW}$, EN = GND (3)		0.5	1	μA

(1) In PFM mode, the internal reference voltage is set to typ. $1.01 \times V_{ref}$. See the section.

(2) For $V_{IN} = V_{OUT} + 0.6\text{ V}$

(3) In fixed-output-voltage versions, the internal resistor divider network is disconnected from the FB terminal.

7.6 Typical Characteristics

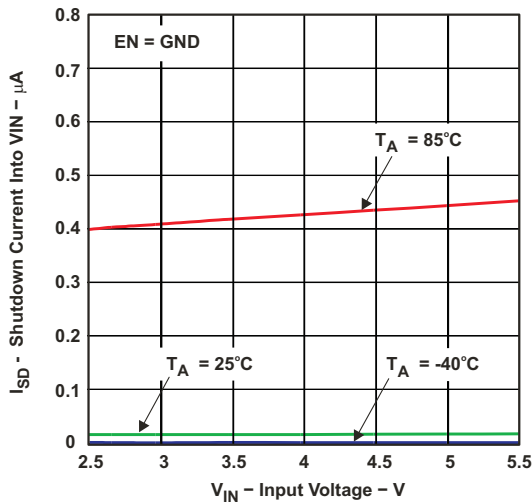

Figure 1. Shutdown Current into VIN vs Input Voltage

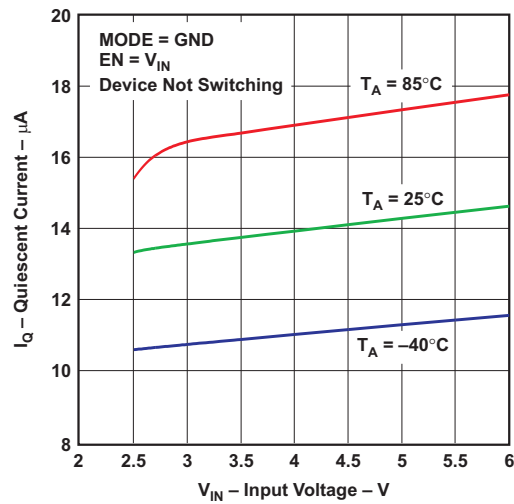

Figure 2. Quiescent Current vs Input Voltage

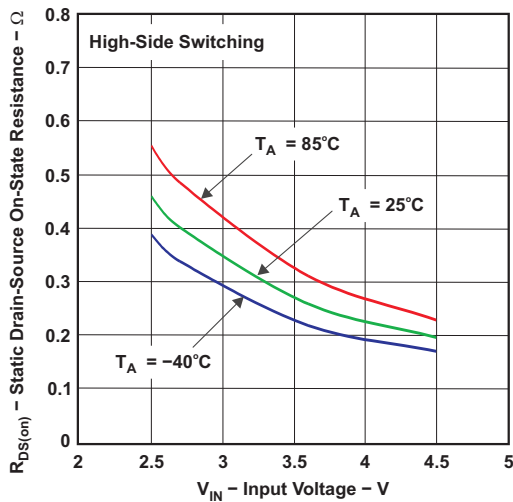

Figure 3. Static Drain-Source ON-State Resistance

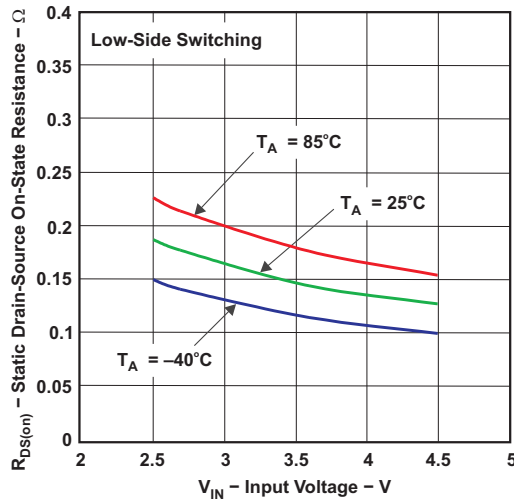

Figure 4. Static Drain-Source ON-State Resistance vs Input Voltage

8 Detailed Description

8.1 Overview

The TPS62560/62 step-down converters operate with typically 2.25-MHz fixed-frequency pulse-width modulation (PWM) at moderate to heavy load currents. At light load currents, the converter can automatically enter power-save mode, and then operates in PFM mode. However, the TPS62561 operates with fixed-frequency PWM only, also at light load conditions.

During PWM operation, the converter uses a unique fast-response voltage-mode control scheme with input-voltage feed-forward to achieve good line and load regulation, allowing the use of small ceramic input and output capacitors. At the beginning of each clock cycle initiated by the clock signal, the high-side MOSFET switch is turned on. The current flows from the input capacitor via the high-side MOSFET switch through the inductor to the output capacitor and load. During this phase, the current ramps up until the PWM comparator trips and the control logic turns off the switch. The current-limit comparator also turns off the switch in case the current limit of the high-side MOSFET switch is exceeded. After a dead time, which prevents shoot-through current, the low-side MOSFET rectifier is turned on and the inductor current ramps down. The current flows from the inductor to the output capacitor and to the load. It returns back to the inductor through the low-side MOSFET rectifier.

The next cycle is initiated by the clock signal again turning off the low-side MOSFET rectifier and turning on the on the high-side MOSFET switch.

8.2 Functional Block Diagram

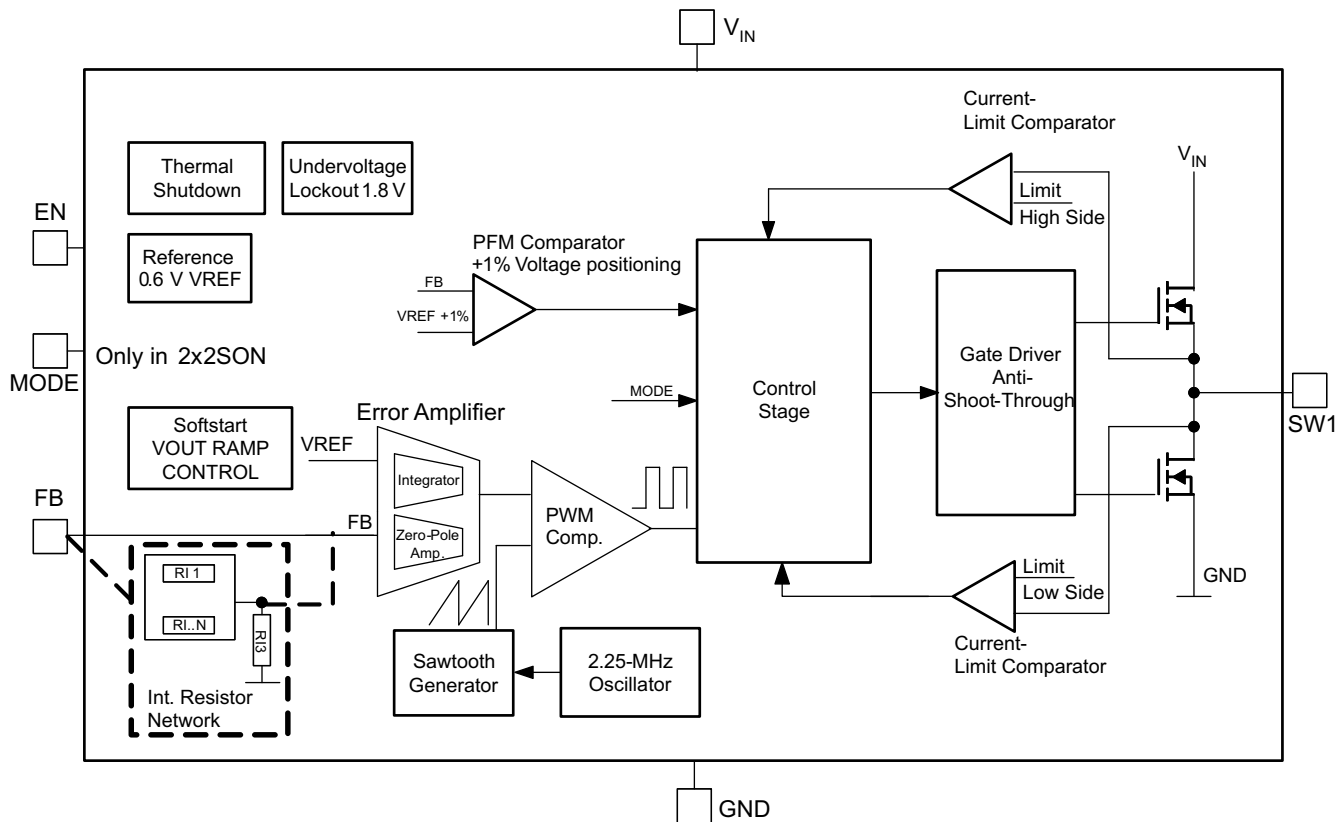

Copyright © 2016, Texas Instruments Incorporated

8.3 Feature Description

8.3.1 Dynamic Voltage Positioning

This feature reduces the voltage under/overshoots at load steps from light to heavy load and vice versa. It is active in power-save mode and regulates the output voltage 1% higher than the nominal value. This provides more headroom for both the voltage drop at a load step, and the voltage increase at a load throw-off.

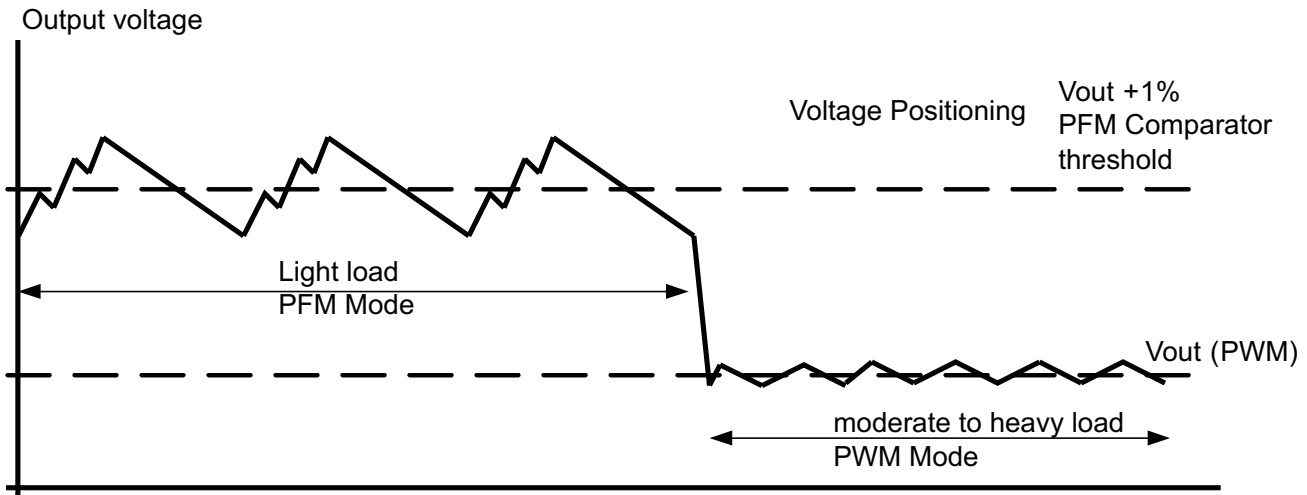

Figure 5. Power Save Mode Operation With Automatic Mode Transition

8.3.2 Undervoltage Lockout

The undervoltage lockout circuit prevents the device from malfunctioning at low input voltages and from excessive discharge of the battery and disables the output stage of the converter. The undervoltage lockout threshold is typically 1.85 V with falling V_{IN} .

8.3.3 Mode Selection

The MODE terminal allows mode selection between forced-PWM mode and power-save mode.

Connecting this terminal to GND enables the power-save mode with automatic transition between PWM and PFM modes. Pulling the MODE terminal high forces the converter to operate in fixed-frequency PWM mode even at light load currents. This allows simple filtering of the switching frequency for noise-sensitive applications. In this mode, the efficiency is lower compared to the power-save mode during light loads.

The state of the MODE terminal can be changed during operation to allow efficient power management by adjusting the operation mode of the converter to the specific system requirements.

8.3.4 Enable

The device is enabled by setting the EN terminal to high. During the start-up time $t_{Start Up}$, the internal circuits are settled and the soft-start circuit is activated. The EN input can be used to control power sequencing in a system with various dc/dc converters. The EN terminal can be connected to the output of another converter, to drive the EN terminal high to achieve a sequencing of the given supply rails. With EN = GND, the device enters shutdown mode, in which all internal circuits are disabled. In fixed-output-voltage versions, the internal resistor divider network is then disconnected from the FB terminal.

8.3.5 Thermal Shutdown

As soon as the junction temperature, T_J , exceeds 140°C (typical), the device goes into thermal shutdown. In this mode, the high-side and low-side MOSFETs are turned off. The device continues its operation when the junction temperature falls below the thermal shutdown hysteresis.

8.4 Device Functional Modes

8.4.1 Soft-Start

The TPS62560 has an internal soft-start circuit that controls the ramp-up of the output voltage. The output voltage ramps up from 5% to 95% of its nominal value typically within 250 μ s. This limits the inrush current into the converter during ramp-up and prevents possible input voltage drops when a battery or high-impedance power source is used. The soft-start circuit is enabled within the start-up time $t_{\text{Start Up}}$.

8.4.2 Power-Save Mode

The power-save mode is enabled with the MODE terminal set to the low level. If the load current decreases, the converter enters the power-save mode of operation automatically. During power-save mode, the converter skips switching and operates with reduced frequency in PFM mode with a minimum quiescent current to maintain high efficiency. The converter positions the output voltage typically 1% above the nominal output voltage. This voltage positioning feature minimizes voltage drops caused by a sudden load step.

The transition from PWM mode to PFM mode occurs once the inductor current in the low-side MOSFET switch becomes zero, which indicates discontinuous conduction mode.

During the power-save mode, the output voltage is monitored with a PFM comparator. As the output voltage falls below the PFM comparator threshold of $V_{\text{OUT nominal}} + 1\%$, the device starts a PFM current pulse. The high-side MOSFET switch turns on, and the inductor current ramps up. After the on-time expires, the switch is turned off and the low-side MOSFET switch is turned on until the inductor current becomes zero.

The converter effectively delivers a current to the output capacitor and the load. If the load is below the delivered current, the output voltage rises. If the output voltage is equal to or higher than the PFM comparator threshold, the device stops switching and enters a sleep mode with typical 15- μ A current consumption.

If the output voltage is still below the PFM comparator threshold, a sequence of further PFM current pulses is generated until the PFM comparator threshold is reached. The converter starts switching again once the output voltage drops below the PFM comparator threshold.

With a fast single-threshold comparator, the output-voltage ripple during PFM-mode operation can be kept small. The PFM pulse is time controlled, which allows modifying the charge transferred to the output capacitor by the value of the inductor. The resulting PFM output-voltage ripple and PFM frequency depend primarily on the size of the output capacitor and the inductor value. Increasing output capacitor values and inductor values minimizes the output ripple. The PFM frequency decreases with smaller inductor values and increases with larger values.

The PFM mode is left and PWM mode entered in case the output current can no longer be supported in PFM mode. The power-save mode can be disabled by setting the MODE terminal to high. The converter then operates in the fixed-frequency PWM mode.

8.4.2.1 100% Duty-Cycle Low-Dropout Operation

The device starts to enter 100% duty-cycle mode once the input voltage comes close to the nominal output voltage. In order to maintain the output voltage, the high-side MOSFET switch is turned on 100% for one or more cycles.

With further decreasing V_{IN} , the high-side MOSFET switch is turned on completely. In this case, the converter offers a low input-to-output voltage difference. This is particularly useful in battery-powered applications to achieve longest operation time by taking full advantage of the whole battery-voltage range.

The minimum input voltage to maintain regulation depends on the load current and output voltage; and, can be calculated as:

$$V_{\text{IN min}} = V_{\text{OUT max}} + I_{\text{OUT max}} \times (R_{\text{DS(on)}} \text{max} + R_{\text{L}})$$

where

- $I_{\text{OUT max}}$ = maximum output current plus inductor ripple current
- $R_{\text{DS(on)}} \text{max}$ = maximum P-channel switch $R_{\text{DS(on)}}$
- R_{L} = dc resistance of the inductor
- $V_{\text{OUT max}}$ = nominal output voltage plus maximum output voltage tolerance

(1)

Device Functional Modes (continued)

8.4.2.2 Short-Circuit Protection

The high-side and low-side MOSFET switches are short-circuit protected with maximum switch current = I_{LIMF} . The current in the switches is monitored by current-limit comparators. Once the current in the high-side MOSFET switch exceeds the threshold of its current-limit comparator, it turns off and the low-side MOSFET switch is activated to ramp down the current in the inductor and high-side MOSFET switch. The high-side MOSFET switch can only turn on again after the current in the low-side MOSFET switch has decreased below the threshold of its current-limit comparator.

9 Application and Implementation

NOTE

Information in the following applications sections is not part of the TI component specification, and TI does not warrant its accuracy or completeness. TI's customers are responsible for determining suitability of components for their purposes. Customers should validate and test their design implementation to confirm system functionality.

9.1 Application Information

The TPS6256x devices are high-efficiency synchronous step-down DC–DC converter featuring power-save mode or 2.25-MHz fixed frequency operation.

9.2 Typical Application

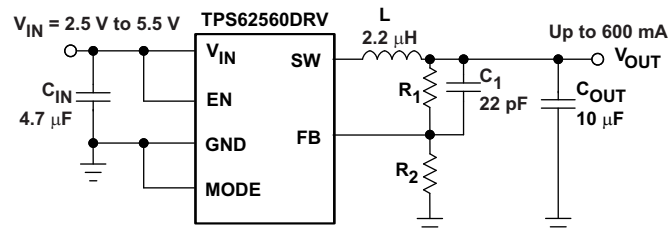

Copyright © 2016, Texas Instruments Incorporated

Figure 6. TPS62560DRV Adjustable

9.2.1 Design Requirements

The TPS6256x is a highly integrated DC/DC converter. The output voltage is set with an external voltage divider for the adjustable output voltage version. The output voltage is fixed to 1.8V for the TPS62562. For proper operation a input- and output capacitor and an inductor is required. Table 2 shows the components used for the application characteristic curves.

9.2.2 Detailed Design Procedure

9.2.2.1 Output Voltage Setting

For adjustable output voltage versions, the output voltage can be calculated by Equation 2 with the internal reference voltage $V_{REF} = 0.6$ V typically.

$$V_{OUT} = V_{REF} \times \left(1 + \frac{R_1}{R_2} \right) \quad (2)$$

To minimize the current through the feedback divider network, R_2 should be 180 k Ω or 360 k Ω . The sum of R_1 and R_2 should not exceed ~1 M Ω , to keep the network robust against noise. An external feed-forward capacitor C_1 is required for optimum load transient response. The value of C_1 should be in the range between 22 pF and 33 pF.

In case of using the fixed output voltage version (TPS62562), V_{out} has to be connected to the feedback pin FB.

Typical Application (continued)

Route the FB line away from noise sources, such as the inductor or the SW line.

9.2.2.2 Output Filter Design (inductor and Output Capacitor)

The TPS62560 is designed to operate with inductors in the range of 1.5 μH to 4.7 μH and with output capacitors in the range of 4.7 μF to 22 μF . The part is optimized for operation with a 2.2- μH inductor and 10- μF output capacitor.

Larger or smaller inductor values can be used to optimize the performance of the device for specific operation conditions. For stable operation, the L and C values of the output filter may not fall below 1 μH effective inductance and 3.5 μF effective capacitance.

9.2.2.2.1 Inductor Selection

The inductor value has a direct effect on the ripple current. The selected inductor must be rated for its dc resistance and saturation current. The inductor ripple current (ΔI_L) decreases with higher inductance and increases with higher V_{IN} or V_{OUT} .

The inductor selection also impacts the output voltage ripple in PFM mode. Higher inductor values lead to lower output voltage ripple and higher PFM frequency; lower inductor values lead to a higher output voltage ripple but lower PFM frequency.

[Equation 3](#) calculates the maximum inductor current in PWM mode under static load conditions. The saturation current of the inductor should be rated higher than the maximum inductor current as calculated with [Equation 4](#). This is recommended because during heavy load transients the inductor current rises above the calculated value.

$$\Delta I_L = V_{\text{OUT}} \times \frac{1 - \frac{V_{\text{OUT}}}{V_{\text{IN}}}}{L \times f} \quad (3)$$

$$I_{L \text{ max}} = I_{\text{out max}} + \frac{\Delta I_L}{2}$$

where

- f = Switching frequency (2.25 MHz, typical)
 - L = Inductor value
 - ΔI_L = Peak-to-peak inductor ripple current
 - $I_{L \text{ max}}$ = Maximum inductor current
- (4)

A more conservative approach is to select the inductor current rating just for the switch current limit $I_{L \text{ LIMF}}$ of the converter.

Accepting larger values of ripple current allows the use of lower inductance values, but results in higher output voltage ripple, greater core losses, and lower output current capability.

The total losses of the coil have a strong impact on the efficiency of the dc/dc conversion and consist of both the losses in the dc resistance (R_{DC}) and the following frequency-dependent components:

- The losses in the core material (magnetic hysteresis loss, especially at high switching frequencies)
- Additional losses in the conductor from the skin effect (current displacement at high frequencies)
- Magnetic field losses of the neighboring windings (proximity effect)
- Radiation losses

Table 1. List of Inductors

DIMENSIONS, mm	INDUCTANCE, μH	INDUCTOR TYPE	SUPPLIER ⁽¹⁾
2,5 × 2 × 1 max	2	MIPS2520D2R2	FDK
2,5 × 2 × 1,2 max	2	MIPSA2520D2R2	FDK
2,5 × 2 × 1 max	2.2	KSLI-252010AG2R2	Hitachi Metals
2,5 × 2 × 1,2 max	2.2	LQM2HPN2R2MJ0L	Murata
3 × 3 × 1,5 max	2.2	LPS3015 2R2	Coilcraft

(1) See [Third-Party Products Disclaimer](#)

9.2.2.2.2 Output Capacitor Selection

The advanced fast-response voltage-mode control scheme of the TPS62560 allows the use of tiny ceramic capacitors. Ceramic capacitors with low ESR values have the lowest output voltage ripple and are recommended. The output capacitor requires either an X7R or X5R dielectric. Y5V and Z5U dielectric capacitors, aside from their wide variation in capacitance over temperature, become resistive at high frequencies.

At nominal load current, the device operates in PWM mode, and the RMS ripple current is calculated by [Equation 5](#):

$$I_{\text{RMS}C_{\text{OUT}}} = V_{\text{OUT}} \times \frac{1 - \frac{V_{\text{OUT}}}{V_{\text{IN}}}}{L \times f} \times \frac{1}{2\sqrt{3}} \quad (5)$$

At nominal load current, the device operates in PWM mode, and the overall output voltage ripple is the sum of the voltage spike caused by the output capacitor ESR plus the voltage ripple caused by charging and discharging the output capacitor shown in [Equation 6](#):

$$\Delta V_{\text{OUT}} = V_{\text{OUT}} \times \frac{1 - \frac{V_{\text{OUT}}}{V_{\text{IN}}}}{L \times f} \times \left(\frac{1}{8 \times C_{\text{OUT}} \times f} + \text{ESR} \right) \quad (6)$$

At light load currents, the converter operates in power-save mode, and the output voltage ripple is dependent on the output capacitor and inductor values. Larger output capacitor and inductor values minimize the voltage ripple in PFM mode and tighten dc output accuracy in PFM mode.

9.2.2.2.3 Input Capacitor Selection

An input capacitor is required for best input voltage filtering and minimizing the interference with other circuits caused by high input voltage spikes. For most applications, a 4.7- μF to 10- μF ceramic capacitor is recommended. Because a ceramic capacitor loses up to 80% of its initial capacitance at 5 V, it is recommended that 10- μF input capacitors be used for input voltages > 4.5 V. The input capacitor can be increased without any limit for better input voltage filtering. Take care when using only small ceramic input capacitors. When a ceramic capacitor is used at the input and the power is being supplied through long wires, such as from a wall adapter, a load step at the output or V_{IN} step on the input can induce ringing at the V_{IN} terminal. This ringing can couple to the output and be mistaken as loop instability or could even damage the part by exceeding the maximum ratings.

Table 2. List of Capacitors⁽¹⁾

CAPACITANCE	TYPE	SIZE	SUPPLIER
4.7 μF	GRM188R60J475K	0603—1,6 × 0,8 × 0,8 mm	Murata
10 μF	GRM188R60J106M69D	0603—1,6 × 0,8 × 0,8 mm	Murata

(1) See [Third-Party Products Disclaimer](#)

9.2.3 Application Curves

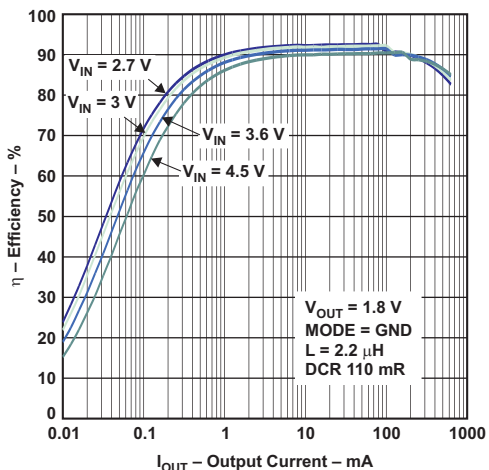

Figure 7. Efficiency vs Output Current

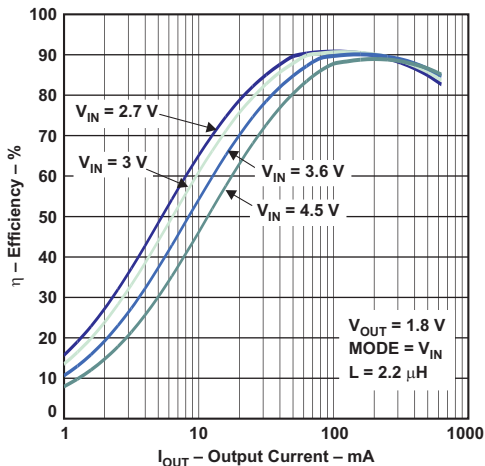

Figure 8. Efficiency vs Output Current

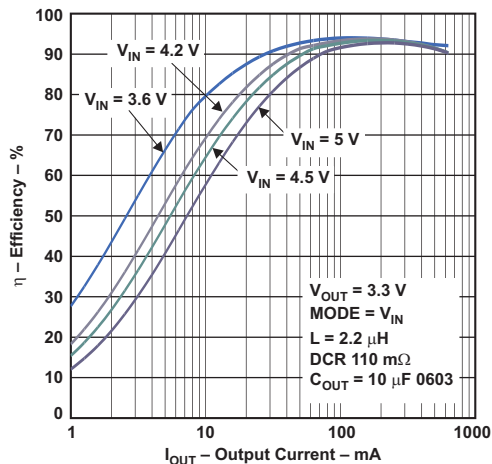

Figure 9. Efficiency vs Output Current

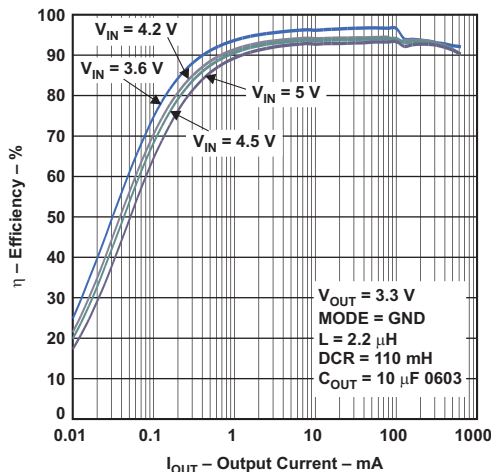

Figure 10. Efficiency vs Output Current

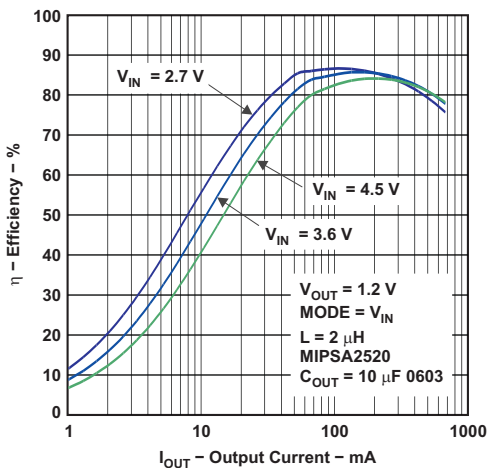

Figure 11. Efficiency vs Output Current

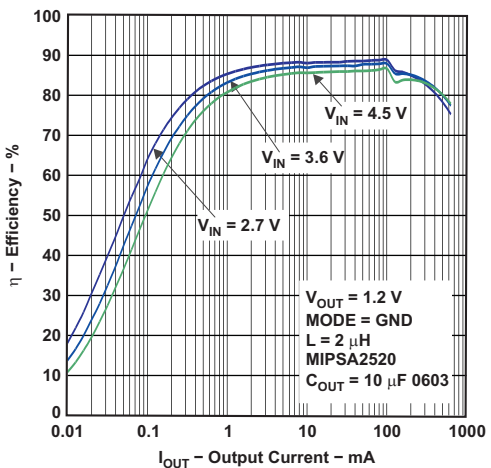

Figure 12. Efficiency vs Output Current

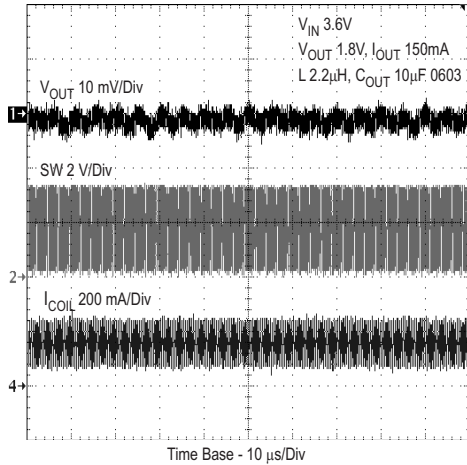

Figure 13. Typical Operation - PWM Mode

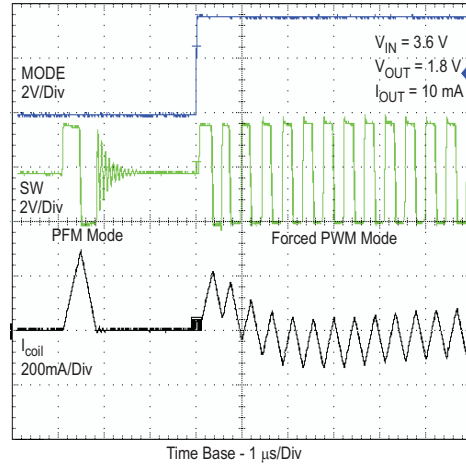

Figure 14. Mode Pin Transition from PFM to FORCED PWM Mode at Light Load

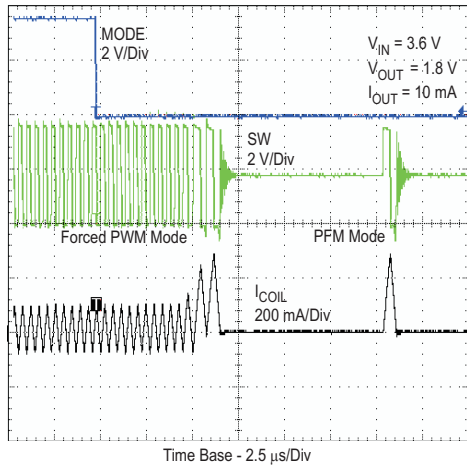

Figure 15. Mode Pin Transition from PWM to PFM MODE at Light Load

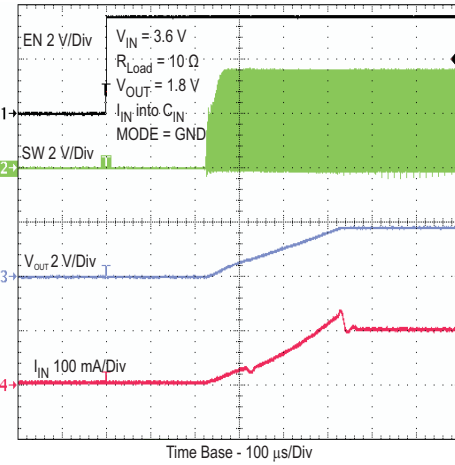

Figure 16. Start-UP Timing

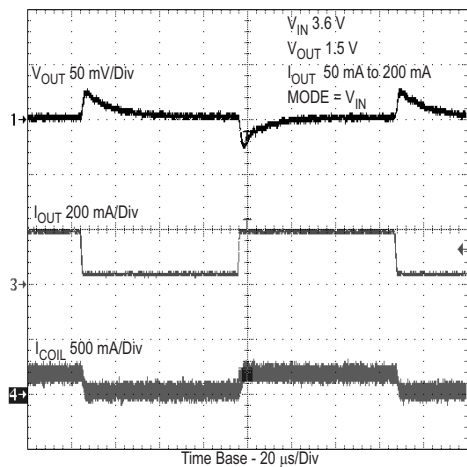

Figure 17. Forced PWM Load Transient

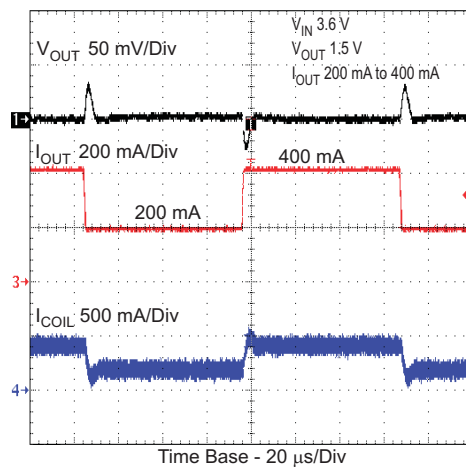

Figure 18. Forced PWM Load Transient

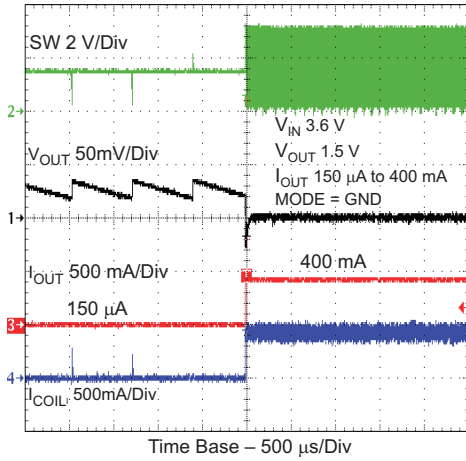

Figure 19. PFM Load Transient

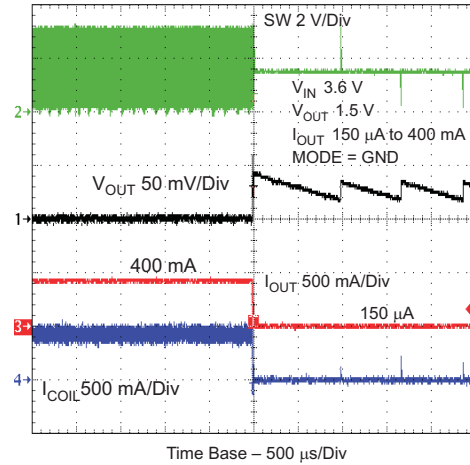

Figure 20. PFM Load Transient

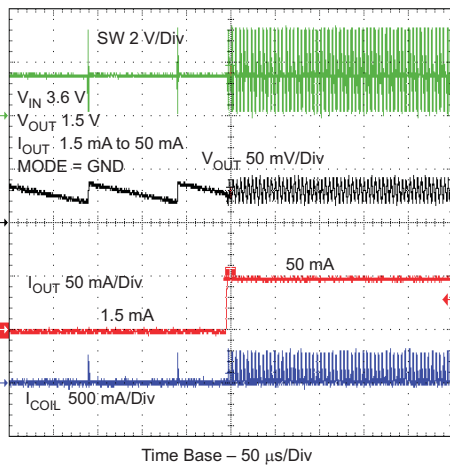

Figure 21. PFM Load Transient

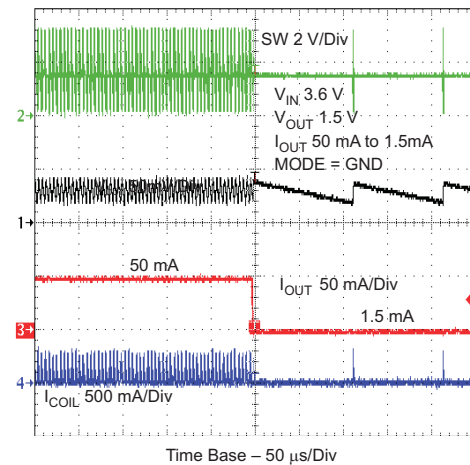

Figure 22. PFM Load Transient

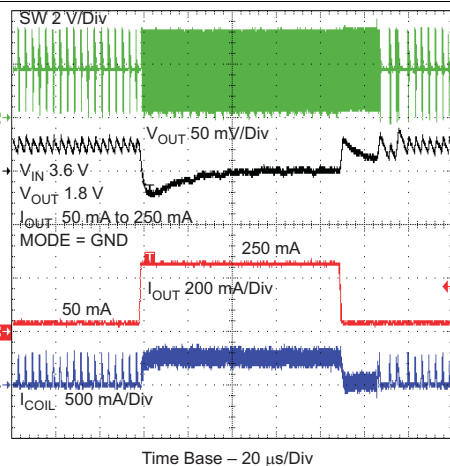

Figure 23. PFM Load Transient

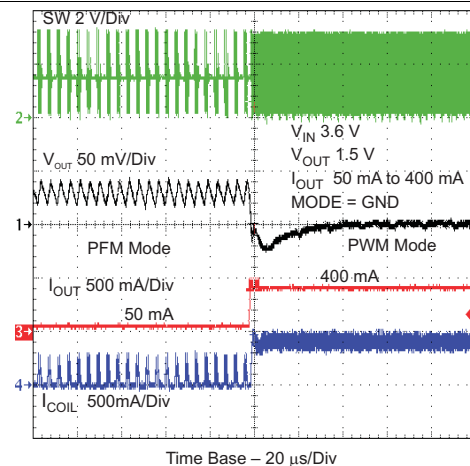

Figure 24. PFM Load Transient

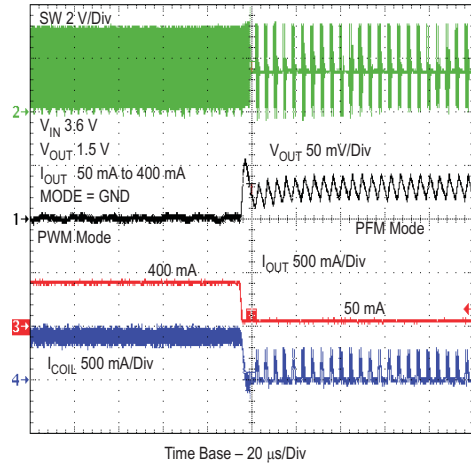

Figure 25. PFM Load Transient

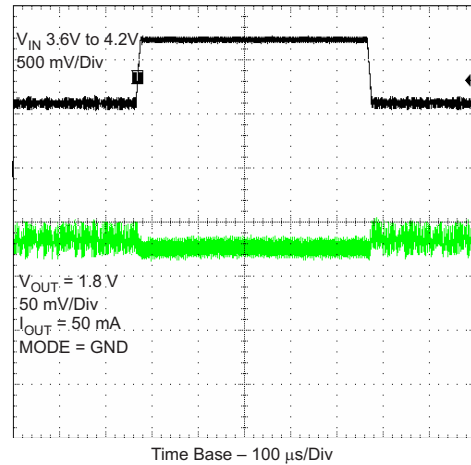

Figure 26. PFM Line Transient

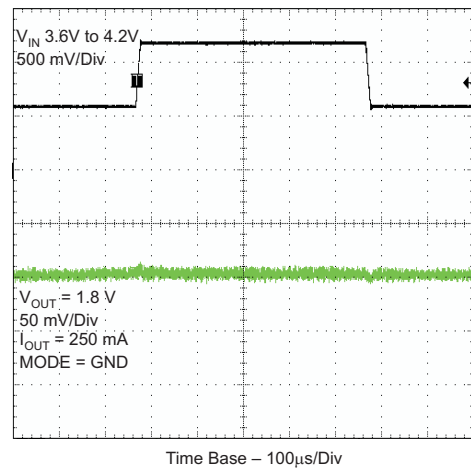

Figure 27. PWM Line Transient

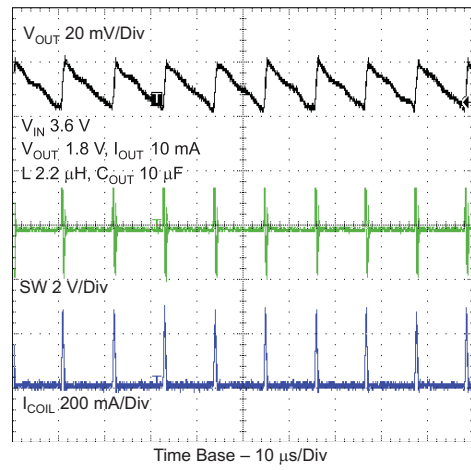

Figure 28. Typical Operation - PFM Mode

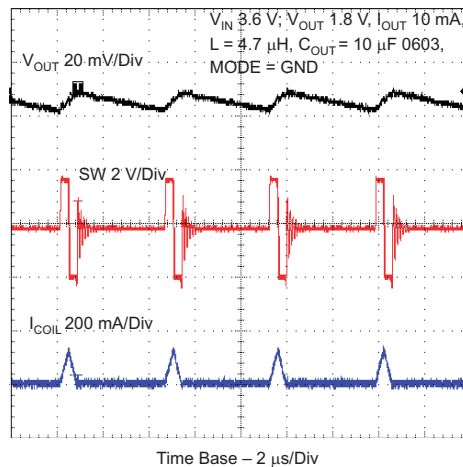

Figure 29. Typical Operation - PFM Mode

9.3 System Examples

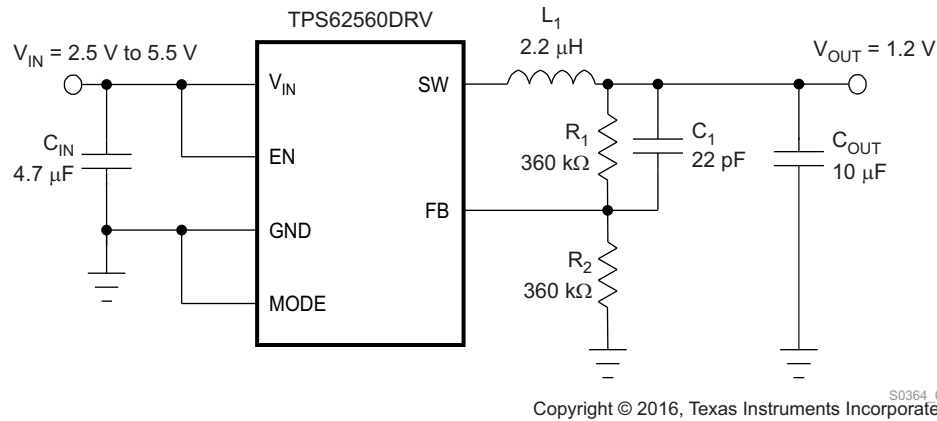

Figure 30. TPS62560 Adjustable 1.2-V Output

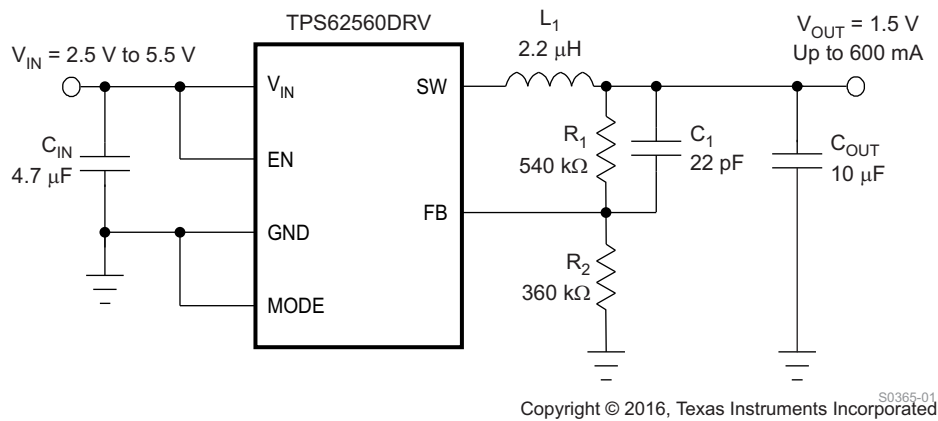

Figure 31. TPS62560 Adjustable 1.5-V Output

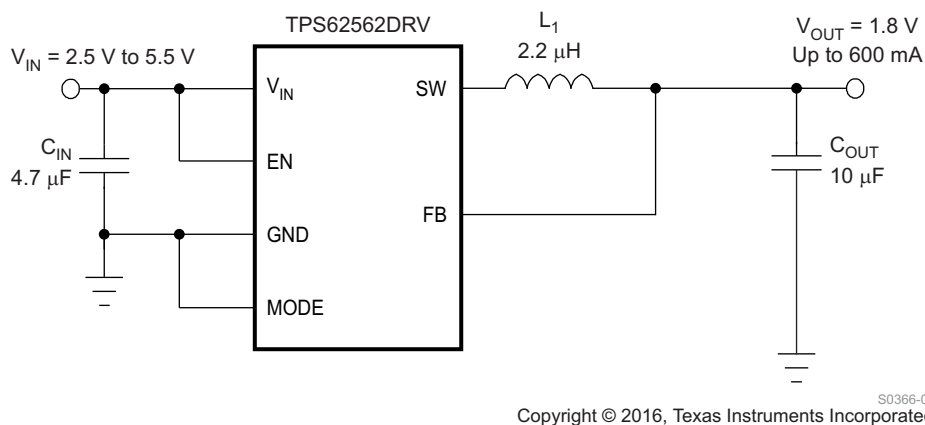

Figure 32. TPS62562 Fixed 1.8-V Output

10 Power Supply Recommendations

The TPS6226x device has no special requirements for its input power supply. The input power supply output current must be rated according to the supply voltage, output voltage, and output current of the TPS6226x.

11 Layout

11.1 Layout Guidelines

As for all switching power supplies, the layout is an important step in the design. Proper function of the device demands careful attention to PCB layout. Take care in board layout to get the specified performance. If the layout is not carefully done, the regulator could show poor line and/or load regulation, stability issues as well as EMI problems. It is critical to provide a low inductance, impedance ground path. Therefore, use wide and short traces for the main current paths. The input capacitor should be placed as close as possible to the IC pins as well as the inductor and output capacitor.

Connect the GND pin of the device to the exposed thermal pad of the PCB and use this pad as a star point. Use a common power GND node and a different node for the signal GND to minimize the effects of ground noise. Connect these ground nodes together to the exposed thermal pad (star point) underneath the IC. Keep the common path to the GND pin, which returns the small signal components and the high current of the output capacitors as short as possible to avoid ground noise. The FB line should be connected right to the output capacitor and routed away from noisy components and traces (for example, the SW line).

11.2 Layout Examples

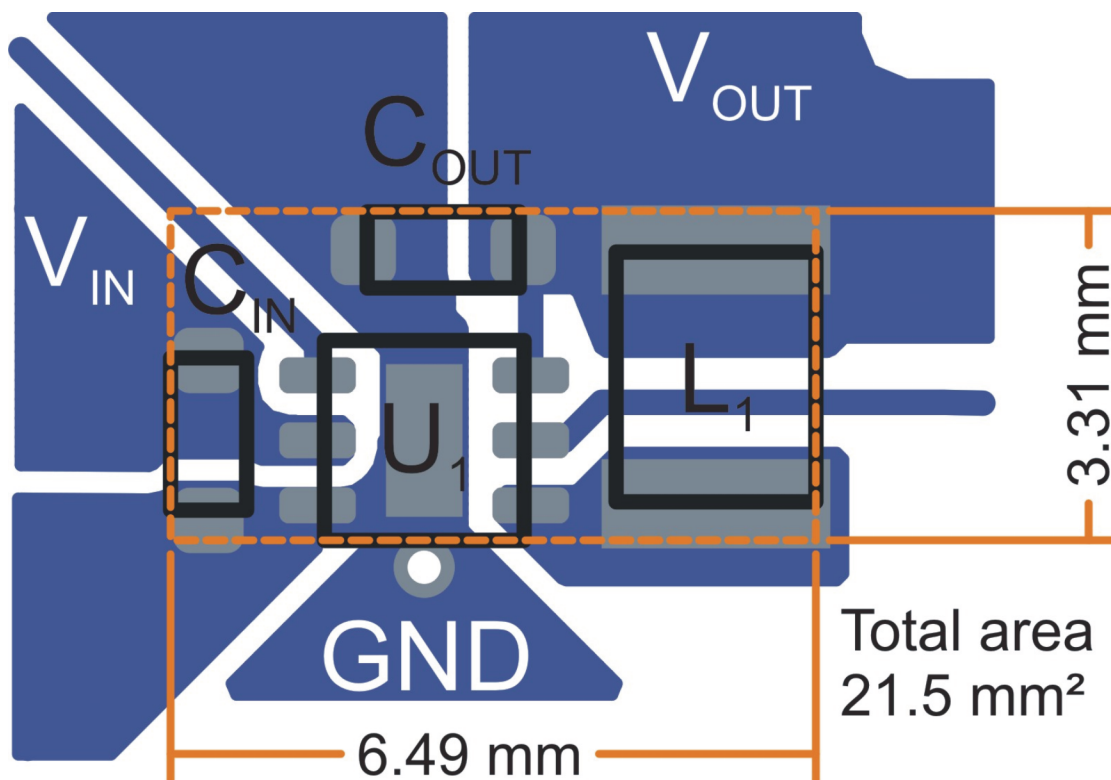

Figure 33. Suggested Layout for Fixed-Output-Voltage Options

Layout Examples (continued)

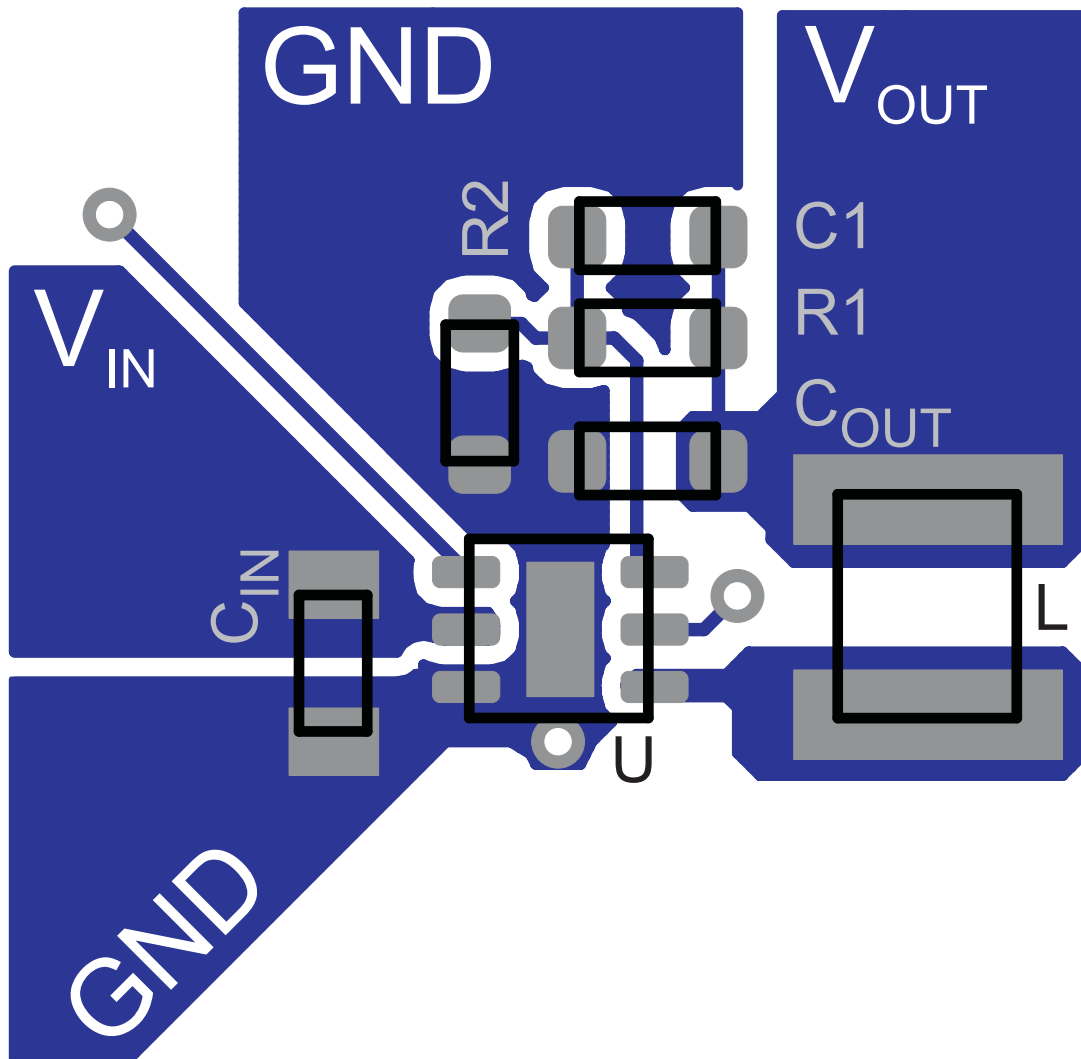

Figure 34. Suggested Layout for Adjustable-Output-Voltage Version

12 器件和文档支持

12.1 器件支持

12.1.1 Third-Party Products Disclaimer

TI'S PUBLICATION OF INFORMATION REGARDING THIRD-PARTY PRODUCTS OR SERVICES DOES NOT CONSTITUTE AN ENDORSEMENT REGARDING THE SUITABILITY OF SUCH PRODUCTS OR SERVICES OR A WARRANTY, REPRESENTATION OR ENDORSEMENT OF SUCH PRODUCTS OR SERVICES, EITHER ALONE OR IN COMBINATION WITH ANY TI PRODUCT OR SERVICE.

12.2 相关链接

以下表格列出了快速访问链接。范围包括技术文档、支持与社区资源、工具和软件，并且可以快速访问样片或购买链接。

表 3. 相关链接

器件	产品文件夹	样片与购买	技术文档	工具与软件	支持与社区
TPS62560	请单击此处	请单击此处	请单击此处	请单击此处	请单击此处
TPS62561	请单击此处	请单击此处	请单击此处	请单击此处	请单击此处
TPS62562	请单击此处	请单击此处	请单击此处	请单击此处	请单击此处

12.3 接收文档更新通知

如需接收文档更新通知，请访问 www.ti.com.cn 网站上的器件产品文件夹。点击右上角的提醒我 (Alert me) 注册后，即可每周定期收到已更改的产品信息。有关更改的详细信息，请查阅已修订文档中包含的修订历史记录。

12.4 社区资源

The following links connect to TI community resources. Linked contents are provided "AS IS" by the respective contributors. They do not constitute TI specifications and do not necessarily reflect TI's views; see TI's [Terms of Use](#).

TI E2E™ Online Community *TI's Engineer-to-Engineer (E2E) Community*. Created to foster collaboration among engineers. At e2e.ti.com, you can ask questions, share knowledge, explore ideas and help solve problems with fellow engineers.

Design Support *TI's Design Support* Quickly find helpful E2E forums along with design support tools and contact information for technical support.

12.5 商标

E2E is a trademark of Texas Instruments.
All other trademarks are the property of their respective owners.

12.6 静电放电警告



这些装置包含有限的内置 ESD 保护。存储或装卸时，应将导线一起截短或将装置放置于导电泡棉中，以防止 MOS 门极遭受静电损伤。

12.7 Glossary

[SLYZ022](#) — *TI Glossary*.

This glossary lists and explains terms, acronyms, and definitions.

13 机械、封装和可订购信息

以下页中包括机械、封装和可订购信息。这些信息是针对指定器件可提供的最新数据。这些数据会在无通知且不对本文档进行修订的情况下发生改变。欲获得该数据表的浏览器版本，请查阅左侧的导航栏。

PACKAGING INFORMATION

Orderable Device	Status (1)	Package Type	Package Drawing	Pins	Package Qty	Eco Plan (2)	Lead finish/ Ball material (6)	MSL Peak Temp (3)	Op Temp (°C)	Device Marking (4/5)	Samples
TPS62560DRVR	ACTIVE	WSON	DRV	6	3000	RoHS & Green	NIPDAU	Level-1-260C-UNLIM	-40 to 85	CEY	Samples
TPS62560DRVT	ACTIVE	WSON	DRV	6	250	RoHS & Green	NIPDAU	Level-1-260C-UNLIM	-40 to 85	CEY	Samples
TPS62561DDCR	ACTIVE	SOT-23-THIN	DDC	5	3000	RoHS & Green	NIPDAU	Level-1-260C-UNLIM	-40 to 85	CVO	Samples
TPS62561DDCT	ACTIVE	SOT-23-THIN	DDC	5	250	RoHS & Green	NIPDAU	Level-1-260C-UNLIM	-40 to 85	CVO	Samples
TPS62562DRVR	ACTIVE	WSON	DRV	6	3000	RoHS & Green	NIPDAU	Level-1-260C-UNLIM	-40 to 85	NXT	Samples
TPS62562DRVT	ACTIVE	WSON	DRV	6	250	RoHS & Green	NIPDAU	Level-1-260C-UNLIM	-40 to 85	NXT	Samples

(1) The marketing status values are defined as follows:

ACTIVE: Product device recommended for new designs.

LIFEBUY: TI has announced that the device will be discontinued, and a lifetime-buy period is in effect.

NRND: Not recommended for new designs. Device is in production to support existing customers, but TI does not recommend using this part in a new design.

PREVIEW: Device has been announced but is not in production. Samples may or may not be available.

OBSOLETE: TI has discontinued the production of the device.

(2) **RoHS:** TI defines "RoHS" to mean semiconductor products that are compliant with the current EU RoHS requirements for all 10 RoHS substances, including the requirement that RoHS substance do not exceed 0.1% by weight in homogeneous materials. Where designed to be soldered at high temperatures, "RoHS" products are suitable for use in specified lead-free processes. TI may reference these types of products as "Pb-Free".

RoHS Exempt: TI defines "RoHS Exempt" to mean products that contain lead but are compliant with EU RoHS pursuant to a specific EU RoHS exemption.

Green: TI defines "Green" to mean the content of Chlorine (Cl) and Bromine (Br) based flame retardants meet JS709B low halogen requirements of <=1000ppm threshold. Antimony trioxide based flame retardants must also meet the <=1000ppm threshold requirement.

(3) MSL, Peak Temp. - The Moisture Sensitivity Level rating according to the JEDEC industry standard classifications, and peak solder temperature.

(4) There may be additional marking, which relates to the logo, the lot trace code information, or the environmental category on the device.

(5) Multiple Device Markings will be inside parentheses. Only one Device Marking contained in parentheses and separated by a "~" will appear on a device. If a line is indented then it is a continuation of the previous line and the two combined represent the entire Device Marking for that device.

(6) Lead finish/Ball material - Orderable Devices may have multiple material finish options. Finish options are separated by a vertical ruled line. Lead finish/Ball material values may wrap to two lines if the finish value exceeds the maximum column width.

Important Information and Disclaimer: The information provided on this page represents TI's knowledge and belief as of the date that it is provided. TI bases its knowledge and belief on information provided by third parties, and makes no representation or warranty as to the accuracy of such information. Efforts are underway to better integrate information from third parties. TI has taken and continues to take reasonable steps to provide representative and accurate information but may not have conducted destructive testing or chemical analysis on incoming materials and chemicals. TI and TI suppliers consider certain information to be proprietary, and thus CAS numbers and other limited information may not be available for release.

In no event shall TI's liability arising out of such information exceed the total purchase price of the TI part(s) at issue in this document sold by TI to Customer on an annual basis.

TAPE AND REEL INFORMATION

QUADRANT ASSIGNMENTS FOR PIN 1 ORIENTATION IN TAPE

*All dimensions are nominal

Device	Package Type	Package Drawing	Pins	SPQ	Reel Diameter (mm)	Reel Width W1 (mm)	A0 (mm)	B0 (mm)	K0 (mm)	P1 (mm)	W (mm)	Pin1 Quadrant
TPS62560DRVR	WSON	DRV	6	3000	179.0	8.4	2.2	2.2	1.2	4.0	8.0	Q2
TPS62560DRVT	WSON	DRV	6	250	179.0	8.4	2.2	2.2	1.2	4.0	8.0	Q2
TPS62561DDCR	SOT-23-THIN	DDC	5	3000	179.0	8.4	3.2	3.2	1.4	4.0	8.0	Q3
TPS62561DDCT	SOT-23-THIN	DDC	5	250	179.0	8.4	3.2	3.2	1.4	4.0	8.0	Q3
TPS62562DRVR	WSON	DRV	6	3000	179.0	8.4	2.2	2.2	1.2	4.0	8.0	Q2
TPS62562DRVT	WSON	DRV	6	250	179.0	8.4	2.2	2.2	1.2	4.0	8.0	Q2

TAPE AND REEL BOX DIMENSIONS

*All dimensions are nominal

Device	Package Type	Package Drawing	Pins	SPQ	Length (mm)	Width (mm)	Height (mm)
TPS62560DRVR	WSON	DRV	6	3000	200.0	183.0	25.0
TPS62560DRVT	WSON	DRV	6	250	200.0	183.0	25.0
TPS62561DDCR	SOT-23-THIN	DDC	5	3000	200.0	183.0	25.0
TPS62561DDCT	SOT-23-THIN	DDC	5	250	200.0	183.0	25.0
TPS62562DRVR	WSON	DRV	6	3000	200.0	183.0	25.0
TPS62562DRVT	WSON	DRV	6	250	200.0	183.0	25.0

GENERIC PACKAGE VIEW

DRV 6

WSON - 0.8 mm max height

PLASTIC SMALL OUTLINE - NO LEAD



Images above are just a representation of the package family, actual package may vary.
Refer to the product data sheet for package details.

4206925/F

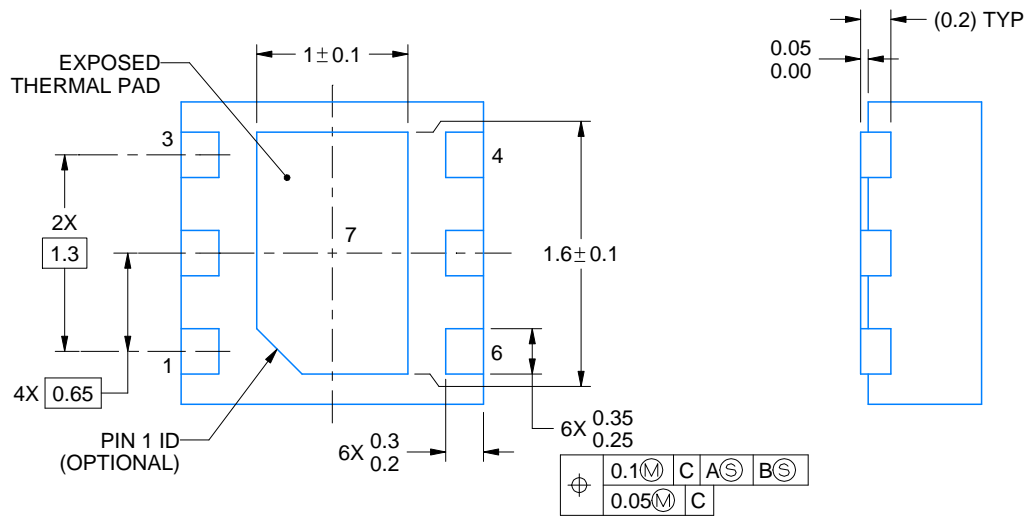

4222173/B 04/2018

NOTES:

1. All linear dimensions are in millimeters. Any dimensions in parenthesis are for reference only. Dimensioning and tolerancing per ASME Y14.5M.
2. This drawing is subject to change without notice.
3. The package thermal pad must be soldered to the printed circuit board for thermal and mechanical performance.

EXAMPLE STENCIL DESIGN

DRV0006A

WSON - 0.8 mm max height

PLASTIC SMALL OUTLINE - NO LEAD



SOLDER PASTE EXAMPLE
BASED ON 0.125 mm THICK STENCIL

EXPOSED PAD #7
88% PRINTED SOLDER COVERAGE BY AREA UNDER PACKAGE
SCALE:30X

4222173/B 04/2018

NOTES: (continued)

6. Laser cutting apertures with trapezoidal walls and rounded corners may offer better paste release. IPC-7525 may have alternate design recommendations.

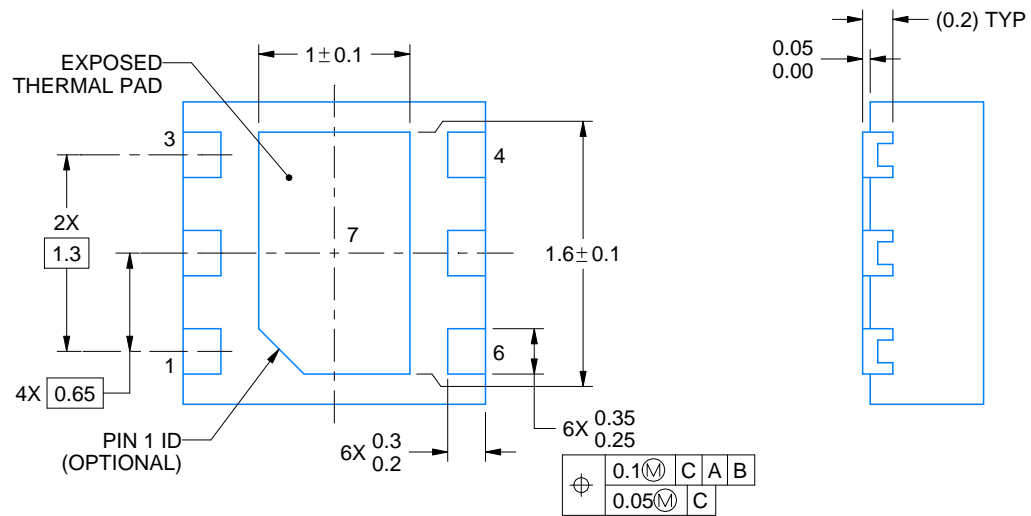
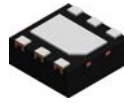

4225563/A 12/2019

NOTES:

1. All linear dimensions are in millimeters. Any dimensions in parenthesis are for reference only. Dimensioning and tolerancing per ASME Y14.5M.
2. This drawing is subject to change without notice.
3. The package thermal pad must be soldered to the printed circuit board for thermal and mechanical performance.

EXAMPLE BOARD LAYOUT

DRV0006D

WSON - 0.8 mm max height

PLASTIC SMALL OUTLINE - NO LEAD



LAND PATTERN EXAMPLE
EXPOSED METAL SHOWN
SCALE:25X



SOLDER MASK DETAILS

4225563/A 12/2019

NOTES: (continued)

4. This package is designed to be soldered to a thermal pad on the board. For more information, see Texas Instruments literature number SLUA271 (www.ti.com/lit/sluea271).
5. Vias are optional depending on application, refer to device data sheet. If some or all are implemented, recommended via locations are shown.

EXAMPLE STENCIL DESIGN

DRV0006D

WSON - 0.8 mm max height

PLASTIC SMALL OUTLINE - NO LEAD



SOLDER PASTE EXAMPLE
BASED ON 0.125 mm THICK STENCIL

EXPOSED PAD #7
88% PRINTED SOLDER COVERAGE BY AREA UNDER PACKAGE
SCALE:30X

4225563/A 12/2019

NOTES: (continued)

6. Laser cutting apertures with trapezoidal walls and rounded corners may offer better paste release. IPC-7525 may have alternate design recommendations.

DDC (R-PDSO-G5)

PLASTIC SMALL-OUTLINE

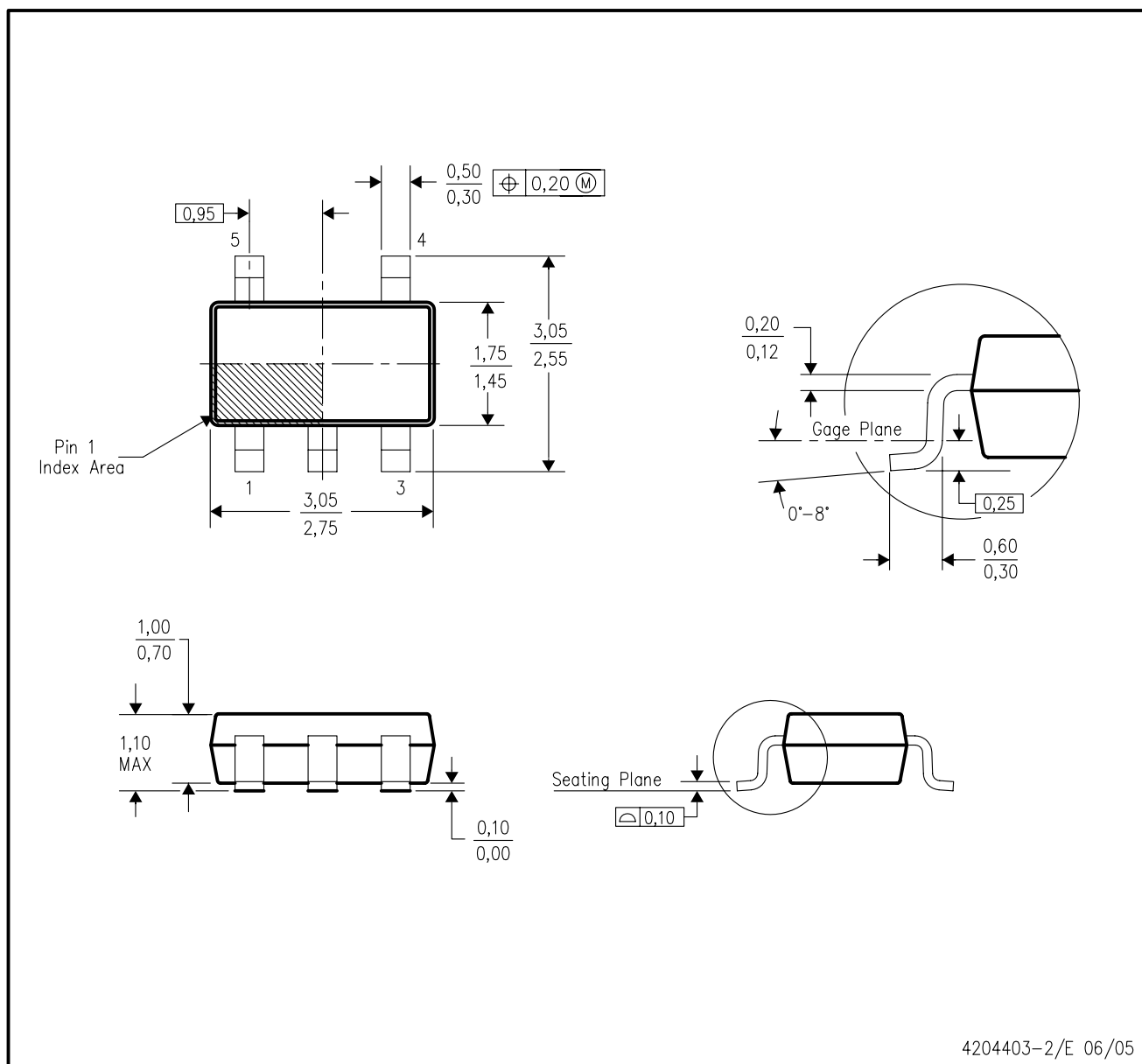

- NOTES:
- All linear dimensions are in millimeters.
 - This drawing is subject to change without notice.
 - Body dimensions do not include mold flash or protrusion.
 - Falls within JEDEC MO-193 variation AB (5 pin).

重要声明和免责声明

TI“按原样”提供技术和可靠性数据（包括数据表）、设计资源（包括参考设计）、应用或其他设计建议、网络工具、安全信息和其他资源，不保证没有瑕疵且不做任何明示或暗示的担保，包括但不限于对适销性、某特定用途方面的适用性或不侵犯任何第三方知识产权的暗示担保。

这些资源可供使用 TI 产品进行设计的熟练开发人员使用。您将自行承担以下全部责任：(1) 针对您的应用选择合适的 TI 产品，(2) 设计、验证并测试您的应用，(3) 确保您的应用满足相应标准以及任何其他功能安全、信息安全、监管或其他要求。

这些资源如有变更，恕不另行通知。TI 授权您仅可将这些资源用于研发本资源所述的 TI 产品的应用。严禁对这些资源进行其他复制或展示。您无权使用任何其他 TI 知识产权或任何第三方知识产权。您应全额赔偿因在这些资源的使用中对 TI 及其代表造成的任何索赔、损害、成本、损失和债务，TI 对此概不负责。

TI 提供的产品受 [TI 的销售条款](#) 或 [ti.com](#) 上其他适用条款/TI 产品随附的其他适用条款的约束。TI 提供这些资源并不会扩展或以其他方式更改 TI 针对 TI 产品发布的适用的担保或担保免责声明。

TI 反对并拒绝您可能提出的任何其他或不同的条款。

邮寄地址：Texas Instruments, Post Office Box 655303, Dallas, Texas 75265

Copyright © 2022，德州仪器 (TI) 公司