

超小型，低输入电压低，低 $R_{\text{导通}}$ 负载开关

查询样品: [TPS22924D](#)

特性

- 集成单负载开关
- 输入电压: **0.75V 至 3.6V**
- 超低导通电阻
 - $V_{\text{输入}} = 3.6\text{V}$ 时, $r_{\text{导通}} = 18.3\text{m}\Omega$
 - $V_{\text{输入}} = 2.5\text{V}$ 时, $r_{\text{导通}} = 18.5\text{m}\Omega$
 - $V_{\text{输入}} = 1.8\text{V}$ 时, $r_{\text{导通}} = 19.6\text{m}\Omega$
 - $V_{\text{输入}} = 1.2\text{V}$ 时, $r_{\text{导通}} = 19.4\text{m}\Omega$
 - $V_{\text{输入}} = 1.0\text{V}$ 时, $r_{\text{导通}} = 20.3\text{m}\Omega$
 - $V_{\text{输入}} = 0.75\text{V}$ 时, $r_{\text{导通}} = 22.7\text{m}\Omega$
- **1.4mm x 0.9mm**, 焊球间距 **0.5mm**, 超小型芯片比例 (CSP)-6 封装
- **2A** 最大持续开关电流
- 低关断电流
- 低阈值控制输入
- 受控转换率以避免涌入电流
- 快速输出放电晶体管
- 静电放电 (ESD) 性能测试符合 **JESD 22** 标准
 - **5000V** 人体模型 (A114-B, II 类)
 - **1000V** 充电器件模型 (C101)

应用范围

- 电池供电类设备
- 便携式工业设备
- 便携式医疗设备
- 便携式媒体播放器
- 销售点终端
- 全球卫星定位(GPS)设备
- 数码摄像机
- 笔记本/平板电脑/电子阅读器
- 智能电话

说明

TPS22924D 是一款小型，超低 $R_{\text{导通}}$ 负载开关，此开关具有可控接通功能。此器件包含一个 N 通道 MOSFET，此 MOSFET 可运行在 0.75V 至 3.6V 的输入电压范围内。一个集成的电荷泵把 NMOS 开关偏置，以实现一个最小的开关导通电阻。此开关可由一个打开/关闭输入 (ON) 控制，此输入可与低压控制信号直接对接。

添加了一个 1250 Ω 片载负载电阻器，以便在开关被关闭时实现输出快速放电。此器件的上升时间受到内部控制以避免涌入电流。电压为 3.6V 时，TPS22924D 特有一个 6200 μs 的上升时间。

TPS22924D 采用超小型、节省空间的 6 引脚 CSP 封装，并可在 -40 $^{\circ}\text{C}$ 至 85 $^{\circ}\text{C}$ 的自然通风温度范围内运行。

图 1. 典型应用



表 1. 特性列表

	3.6V 时的 $r_{\text{导通}}$ (典型值)	3.6V 时, 转换率 (典型值)	快速输出放电 ⁽¹⁾	最大输出电压	使能
TPS22924D	18.3m Ω	6200 μs	支持	2A	高电平有效

(1) 此特性可通过一个 1250 Ω 电阻器将开关的输出放电至接地水平，从而防止此输出悬空。请参见应用信息中的输出下拉部分。

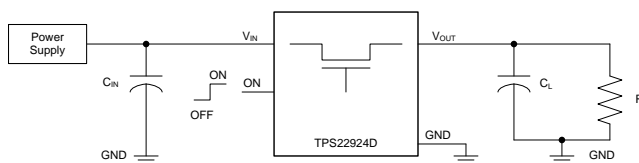

Please be aware that an important notice concerning availability, standard warranty, and use in critical applications of Texas Instruments semiconductor products and disclaimers thereto appears at the end of this data sheet.



This integrated circuit can be damaged by ESD. Texas Instruments recommends that all integrated circuits be handled with appropriate precautions. Failure to observe proper handling and installation procedures can cause damage.

ESD damage can range from subtle performance degradation to complete device failure. Precision integrated circuits may be more susceptible to damage because very small parametric changes could cause the device not to meet its published specifications.

ORDERING INFORMATION

For the most current package and ordering information, see the Package Option Addendum at the end of this document, or see the TI web site at www.ti.com

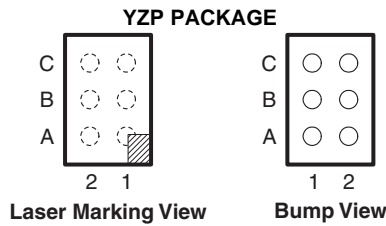

TERMINALS ASSIGNMENTS (YZP PACKAGE)

C	GND	ON
B	VOUT	VIN
A	VOUT	VIN
	1	2

TERMINAL FUNCTIONS

NO.	NAME	DESCRIPTION
C1	GND	Ground
C2	ON	Switch control input, active high. Do not leave floating
A1, B1	VOUT	Switch output
A2, B2	VIN	Switch input. Place a decoupling capacitor from VIN to GND. See Application Information section for details about input capacitors.

BLOCK DIAGRAM

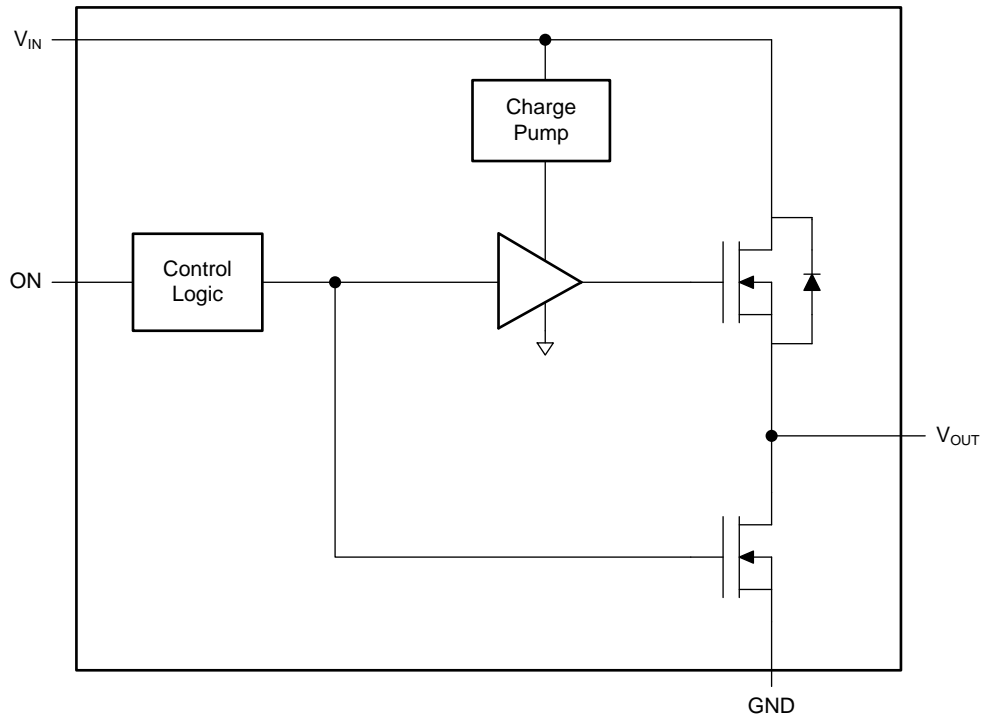

FUNCTION TABLE

ON (Control Signal)	VIN to VOUT	VOUT to GND ⁽¹⁾
L	OFF	ON
H	ON	OFF

(1) See application section *Output Pulldown*.

ABSOLUTE MAXIMUM RATINGS⁽¹⁾

		MIN	MAX	UNIT
V _{IN}	Input voltage range	-0.3	4	V
V _{OUT}	Output voltage range		V _{IN} + 0.3	V
V _{ON}	ON pin voltage range	-0.3	4	V
I _{MAX}	Maximum continuous switch current, T _A = -40°C to 85°C		2	A
I _{PLS}	Maximum pulsed switch current, 100-μs pulse, 2% duty cycle, T _A = -40°C to 85°C		4	A
T _A	Operating free-air temperature range	-40	85	°C
T _{stg}	Storage temperature range	-65	150	°C
ESD	Electrostatic discharge protection	Human-Body Model (HBM)		V
		Charged-Device Model (CDM)		
			5000	
			1000	

- (1) Stresses beyond those listed under absolute maximum ratings may cause permanent damage to the device. These are stress ratings only, and functional operation of the device at these or any other conditions beyond those indicated under *Recommended Operating Conditions* is not implied. Exposure to absolute-maximum-rated conditions for extended periods may affect device reliability.

DISSIPATION RATINGS

BOARD	PACKAGE	R _{θJC}	R _{θJA}	DERATING FACTOR ABOVE T _A = 25°C	T _A < 25°C	T _A = 70°C	T _A = 85°C
High-K ⁽¹⁾	YZP	17.6°C/W	123.36°C/W	- 8.1063 mW/°C	810.63 mW	445.84 mW	324.25 mW

- (1) The JEDEC high-K (2s2p) board used to derive this data was a 3- × 3-inch, multilayer board with 1-ounce internal power and ground planes and 2-ounce copper traces on top and bottom of the board.

RECOMMENDED OPERATING CONDITIONS

		MIN	MAX	UNIT
V _{IN}	Input voltage	0.75	3.6	V
V _{OUT}	Output voltage		V _{IN}	V
V _{IH}	High-level input voltage, ON	V _{IN} = 2.5 V to 3.6 V		V
		V _{IN} = 0.75 V to 2.5 V		
V _{IL}	Low-level input voltage, ON	V _{IN} = 2.5 V to 3.6 V		V
		V _{IN} = 0.75 V to 2.49 V		
C _{IN}	Input capacitance	1 ⁽¹⁾		μF

- (1) See the *Input Capacitor* section in Application Information.

ELECTRICAL CHARACTERISTICS

 $V_{IN} = 0.75\text{ V to }3.6\text{ V}$ (unless otherwise noted)

PARAMETER		TEST CONDITIONS	T_A	MIN	TYP ⁽¹⁾	MAX	UNIT				
$I_{Q, V_{IN}}$	Quiescent current	$V_{OUT} = \text{open}, V_{IN} = V_{ON}$	Full		$V_{IN} = 3.6\text{ V}$	75	160	μA			
					$V_{IN} = 2.5\text{ V}$	42	100				
					$V_{IN} = 1.8\text{ V}$	50	350				
					$V_{IN} = 1.2\text{ V}$	95	200				
					$V_{IN} = 1.0\text{ V}$	65	120				
					$V_{IN} = 0.75\text{ V}$	35	80				
$I_{SD, V_{IN}}$	Shutdown current	$V_{ON} = \text{GND}, V_{OUT} = 0\text{V}$	Full			4.0	μA				
R_{ON}	ON-state resistance	$I_{OUT} = -200\text{ mA}$	25°C	Full	$V_{IN} = 3.6\text{ V}$	18.3	22.8	$\text{m}\Omega$			
					$V_{IN} = 2.5\text{ V}$	18.5	23.0				
			25°C	Full	$V_{IN} = 1.8\text{ V}$	19.6	24.1				
					$V_{IN} = 1.2\text{ V}$	19.4	23.9				
			25°C	Full	$V_{IN} = 1.0\text{ V}$	20.3	24.8				
					$V_{IN} = 0.75\text{ V}$	22.7	27.2				
										27.2	
										34.8	
R_{PD}	Output pulldown resistance ⁽²⁾	$V_{IN} = 3.3\text{ V}, V_{ON} = 0, I_{OUT} = 1\text{ mA}$	25°C	450		1400	Ω				
I_{ON}	ON-pin input leakage current	$V_{ON} = 0.9\text{ V to }3.6\text{ V or GND}$	Full			0.1	μA				

(1) Typical values are at $V_{IN} = 3.3\text{ V}$ and $T_A = 25^\circ\text{C}$.

(2) See [Output Pulldown](#) in *Application Information*.

SWITCHING CHARACTERISTICS

 $V_{IN} = 3.6\text{ V}, T_A = 25^\circ\text{C}$ (unless otherwise noted)

PARAMETER		TEST CONDITIONS	MIN	TYP	MAX	UNIT
t_{ON}	Turn-ON time	$R_L = 10\ \Omega, C_L = 0.1\ \mu\text{F}, V_{IN} = 3.6\text{V}$		7400		μs
t_{OFF}	Turn-OFF time	$R_L = 10\ \Omega, C_L = 0.1\ \mu\text{F}, V_{IN} = 3.6\text{V}$		2.5		μs
t_r	V_{OUT} rise time	$R_L = 10\ \Omega, C_L = 0.1\ \mu\text{F}, V_{IN} = 3.6\text{V}$		6200		μs
t_f	V_{OUT} fall time	$R_L = 10\ \Omega, C_L = 0.1\ \mu\text{F}, V_{IN} = 3.6\text{V}$		2		μs

SWITCHING CHARACTERISTICS

 $V_{IN} = 0.9\text{ V}, T_A = 25^\circ\text{C}$ (unless otherwise noted)

PARAMETER		TEST CONDITIONS	MIN	TYP	MAX	UNIT
t_{ON}	Turn-ON time	$R_L = 10\ \Omega, C_L = 0.1\ \mu\text{F}, V_{IN} = 0.9\text{V}$		6300		μs
t_{OFF}	Turn-OFF time	$R_L = 10\ \Omega, C_L = 0.1\ \mu\text{F}, V_{IN} = 0.9\text{V}$		12		μs
t_r	V_{OUT} rise time	$R_L = 10\ \Omega, C_L = 0.1\ \mu\text{F}, V_{IN} = 0.9\text{V}$		3200		μs
t_f	V_{OUT} fall time	$R_L = 10\ \Omega, C_L = 0.1\ \mu\text{F}, V_{IN} = 0.9\text{V}$		3		μs

PARAMETRIC MEASUREMENT INFORMATION

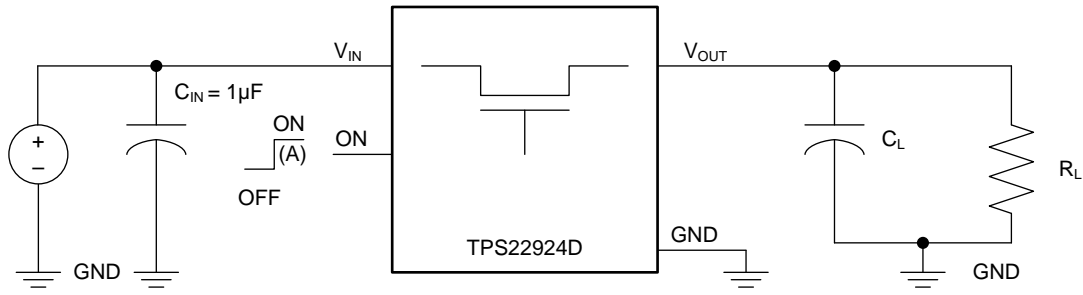

TEST CIRCUIT

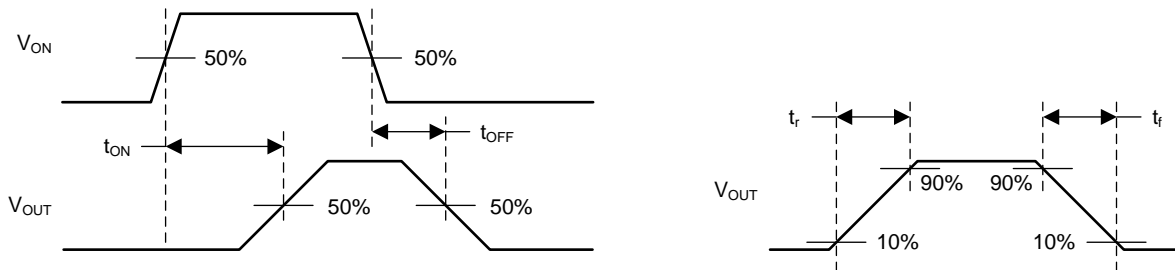

t_{ON}/t_{OFF} WAVEFORMS

A. Rise and fall times of the control signal is 100ns

Figure 2. Test Circuit and t_{ON}/t_{OFF} Waveforms

TYPICAL CHARACTERISTICS

ON-STATE RESISTANCE
vs
INPUT VOLTAGE

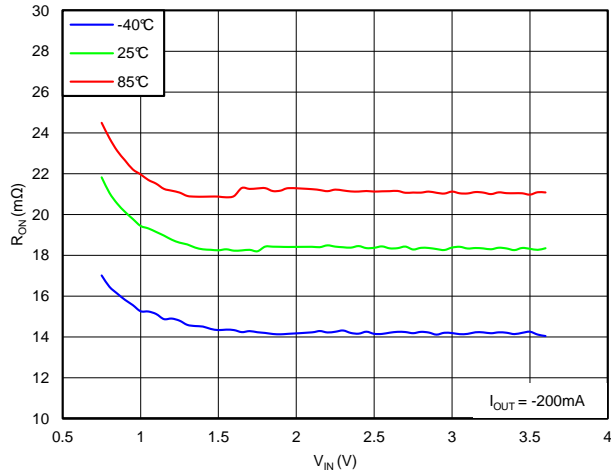

ON-STATE RESISTANCE
vs
TEMPERATURE

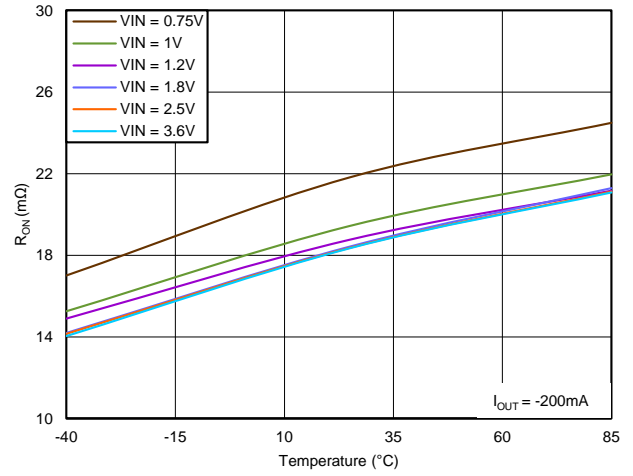

QUIESCENT CURRENT
vs
INPUT VOLTAGE

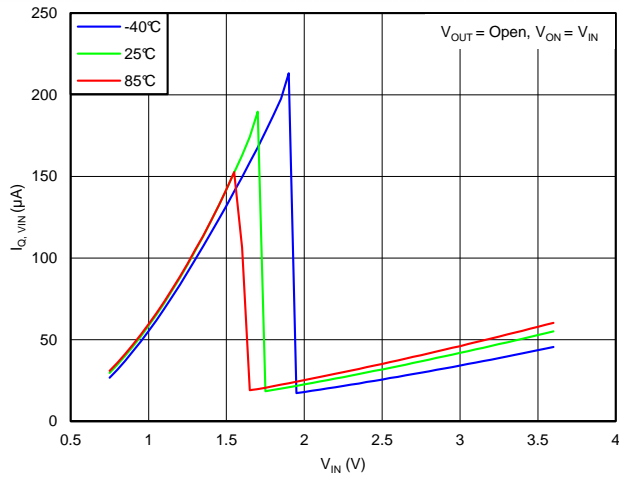

SHUTDOWN CURRENT
vs
INPUT VOLTAGE

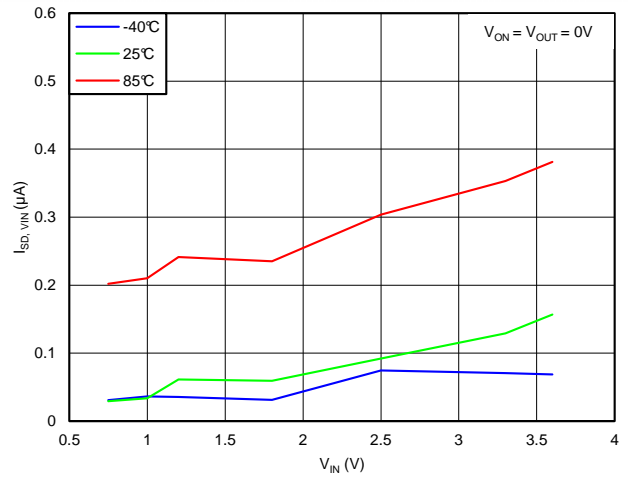

TYPICAL CHARACTERISTICS (continued)
ON INPUT THRESHOLD

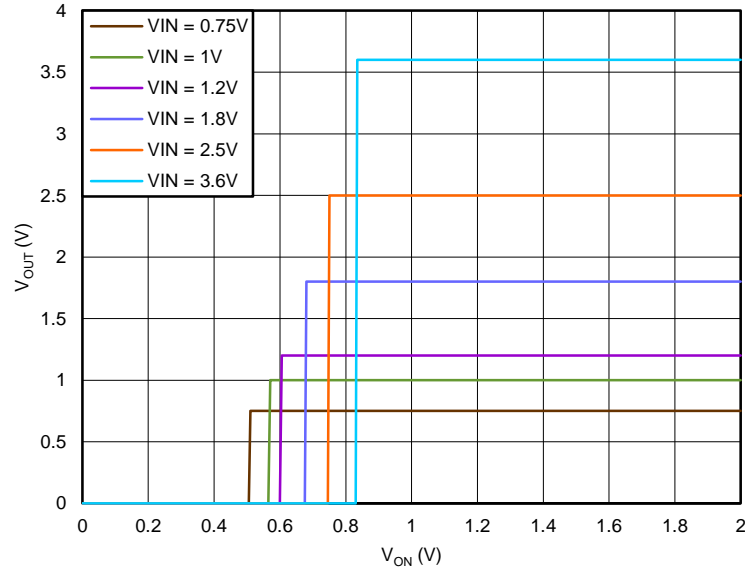

TURN-ON TIME
VS
TEMPERATURE
 $V_{in} = 3.6\text{ V}, C_L = 0.1\ \mu\text{F}, R_L = 10\ \Omega$

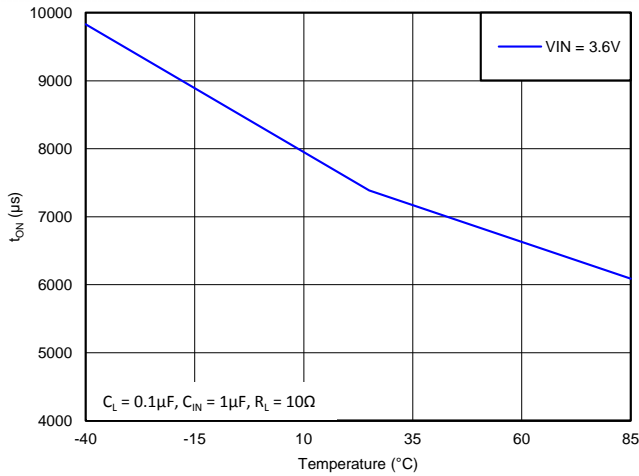

TURN-OFF TIME
VS
TEMPERATURE
 $V_{in} = 3.6\text{ V}, C_L = 0.1\ \mu\text{F}, R_L = 10\ \Omega$

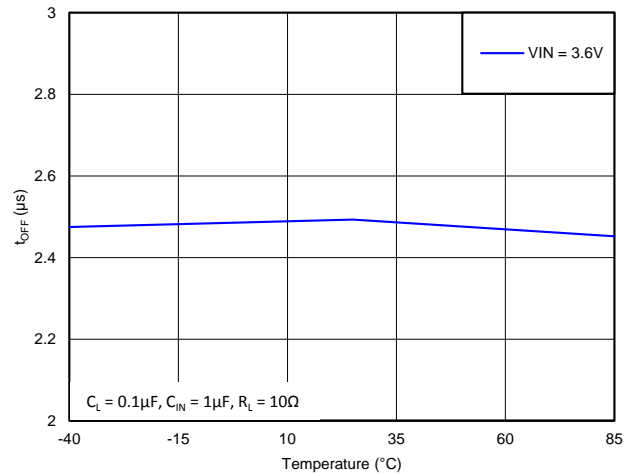

TYPICAL CHARACTERISTICS (continued)

RISE TIME

VS TEMPERATURE

$V_{IN} = 3.6\text{ V}$, $C_L = 0.1\ \mu\text{F}$, $R_L = 10\ \Omega$

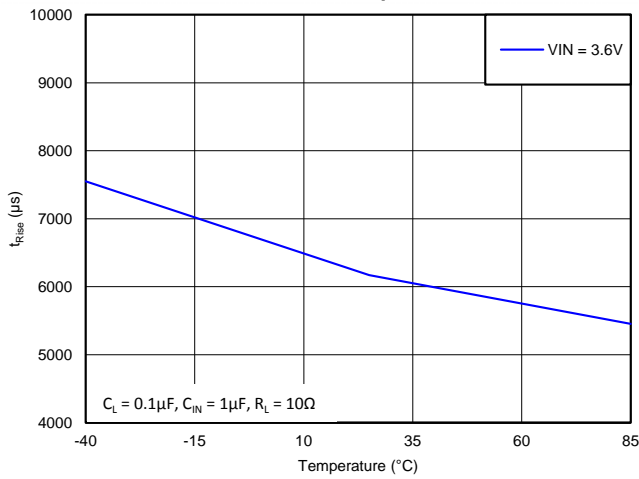

FALL TIME

VS TEMPERATURE

$V_{IN} = 3.6\text{ V}$, $C_L = 0.1\ \mu\text{F}$, $R_L = 10\ \Omega$

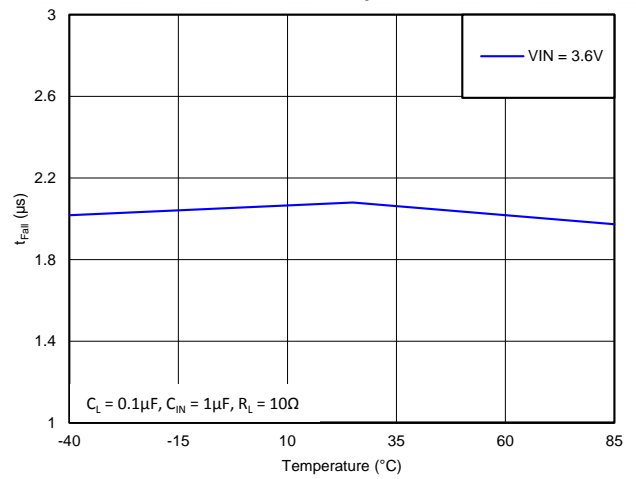

TURN-ON TIME

VS TEMPERATURE

$V_{IN} = 0.9\text{ V}$, $C_L = 0.1\ \mu\text{F}$, $R_L = 10\ \Omega$

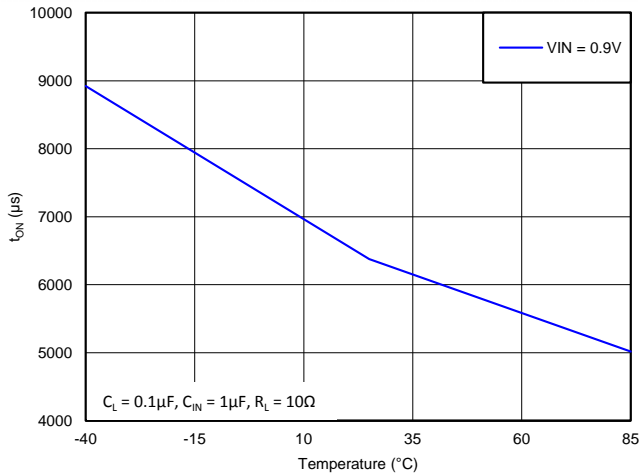

TURN-OFF TIME

VS TEMPERATURE

$V_{IN} = 0.9\text{ V}$, $C_L = 0.1\ \mu\text{F}$, $R_L = 10\ \Omega$

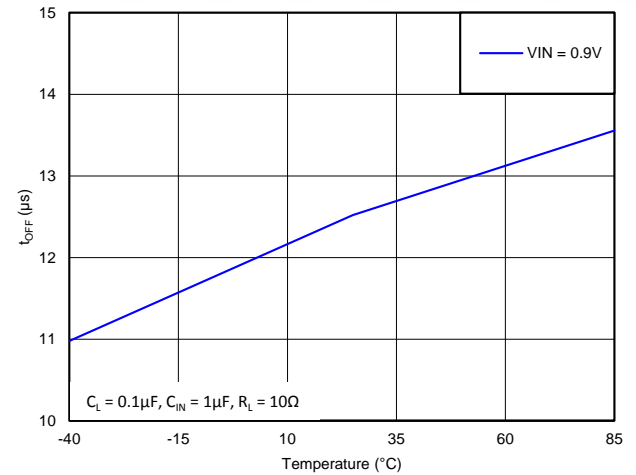

TYPICAL CHARACTERISTICS (continued)

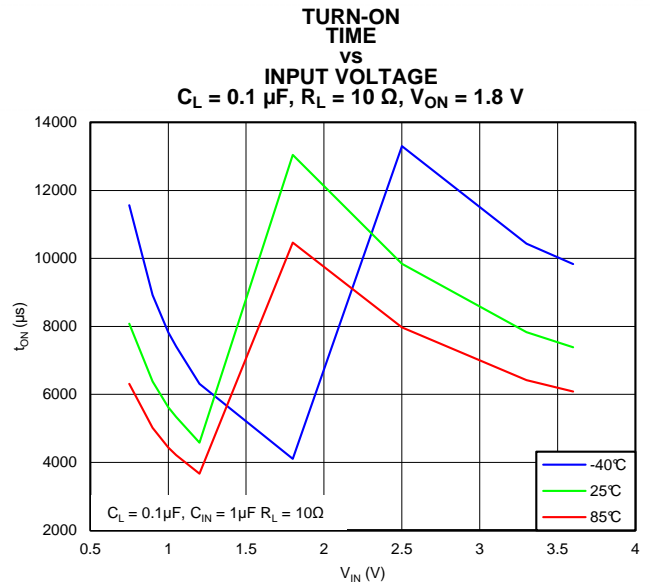
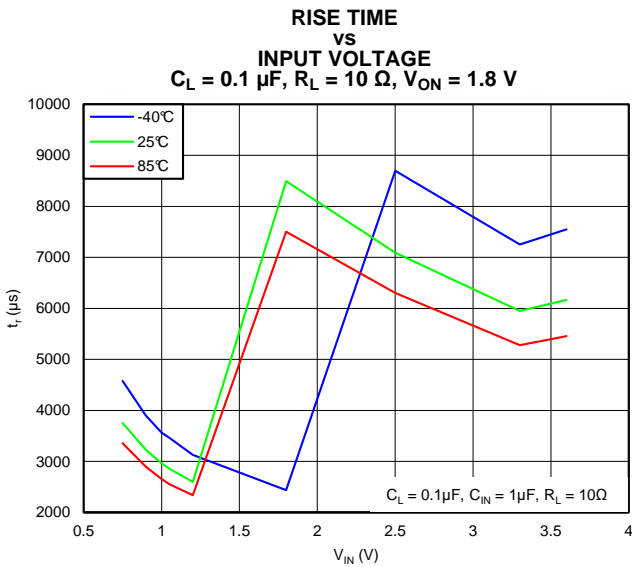
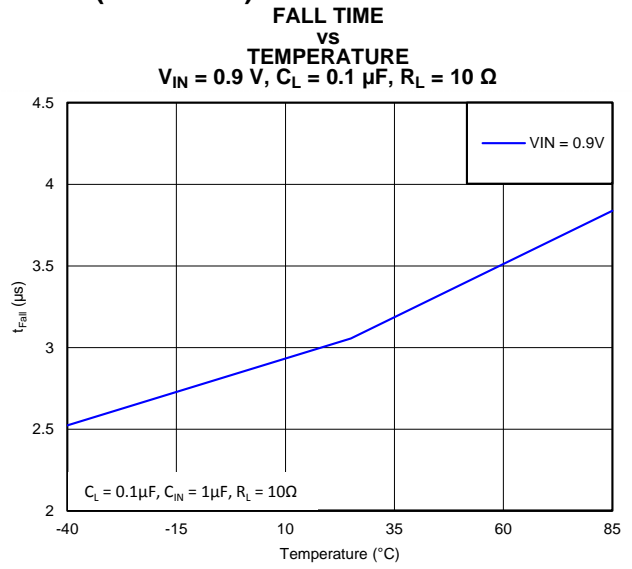
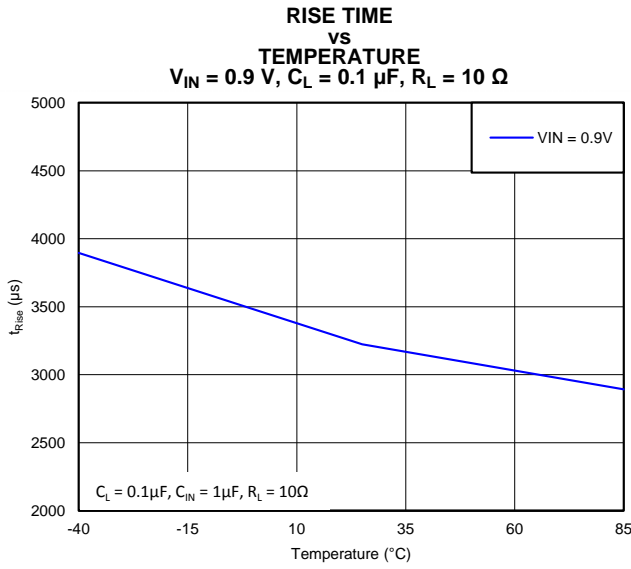

TYPICAL CHARACTERISTICS (continued)

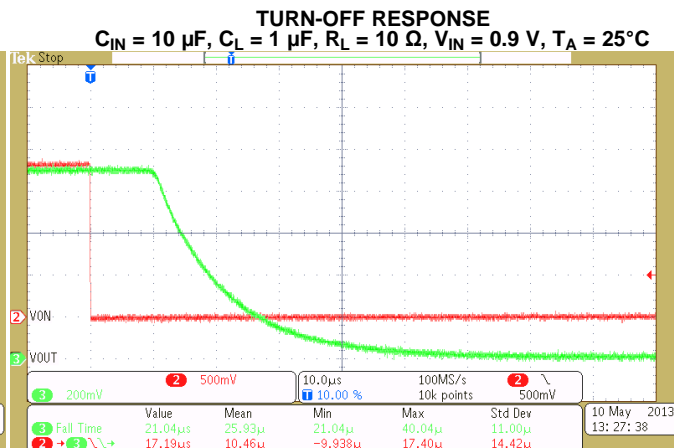
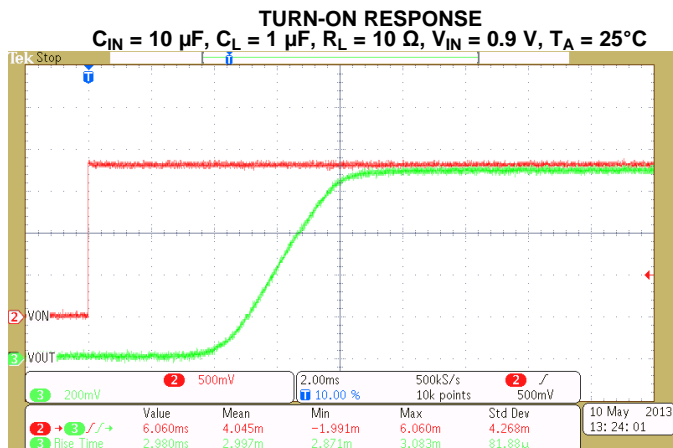
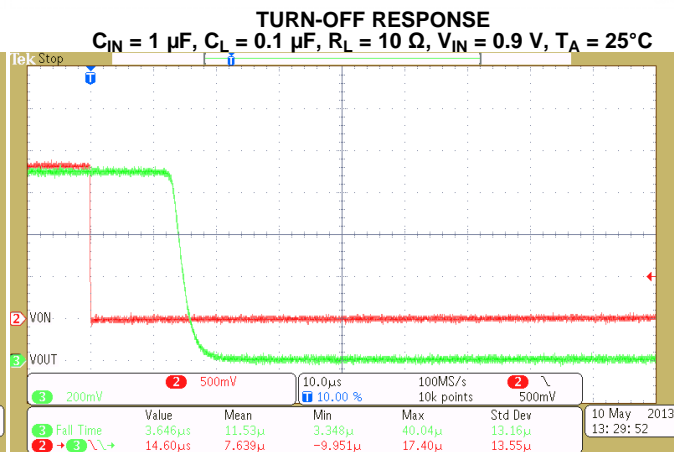
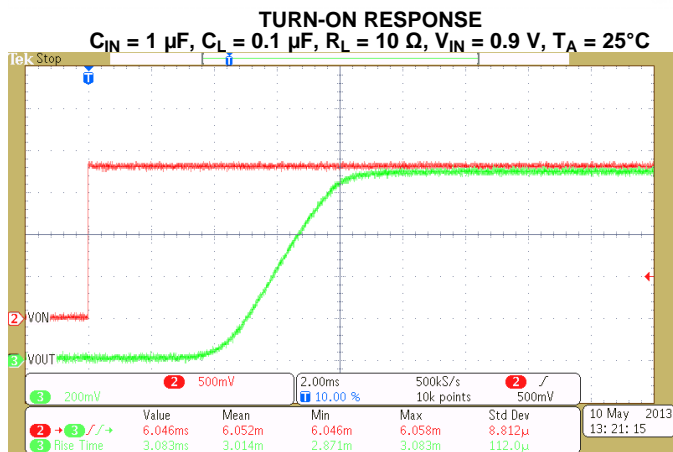
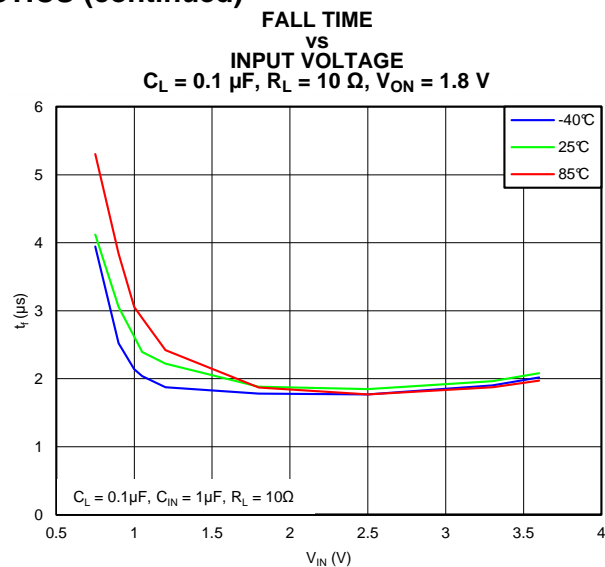
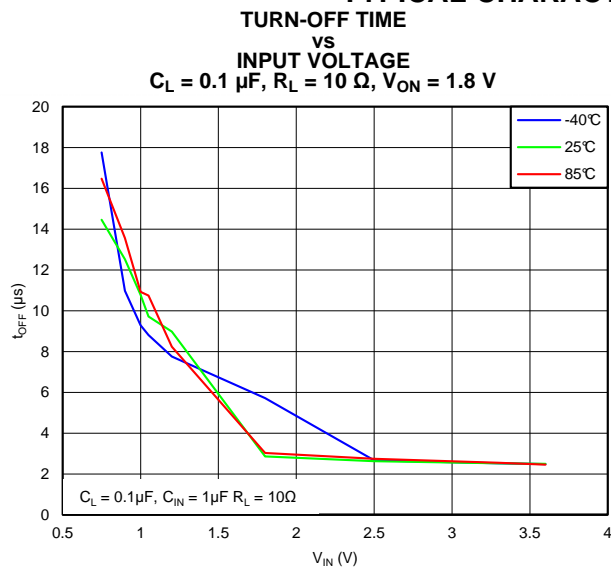

TYPICAL CHARACTERISTICS (continued)

TURN-ON RESPONSE

$C_{IN} = 1 \mu F, C_L = 0.1 \mu F, R_L = 10 \Omega, V_{IN} = 3.6 V, T_A = 25^\circ C$

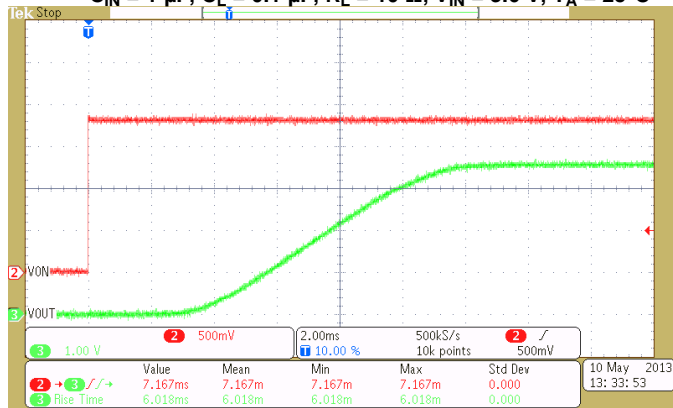

TURN-OFF RESPONSE

$C_{IN} = 1 \mu F, C_L = 0.1 \mu F, R_L = 10 \Omega, V_{IN} = 3.6 V, T_A = 25^\circ C$

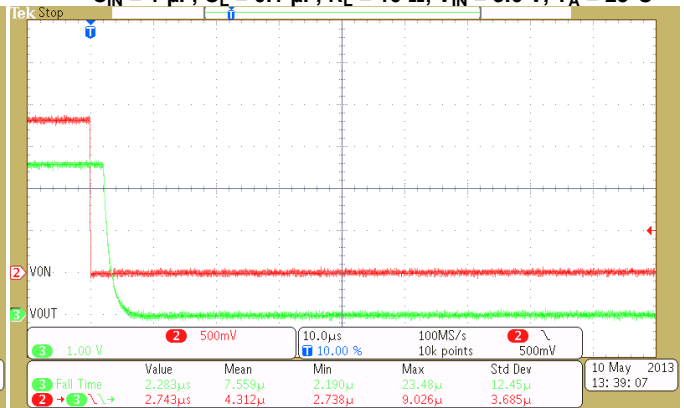

TURN-ON RESPONSE

$C_{IN} = 10 \mu F, C_L = 1 \mu F, R_L = 10 \Omega, V_{IN} = 3.6 V, T_A = 25^\circ C$

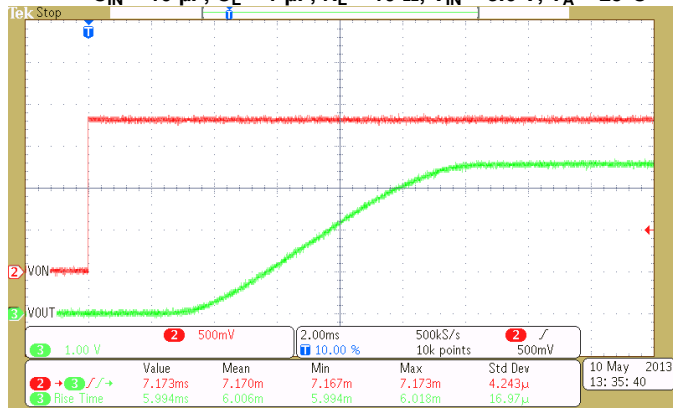

TURN-OFF RESPONSE

$C_{IN} = 10 \mu F, C_L = 1 \mu F, R_L = 10 \Omega, V_{IN} = 3.6 V, T_A = 25^\circ C$

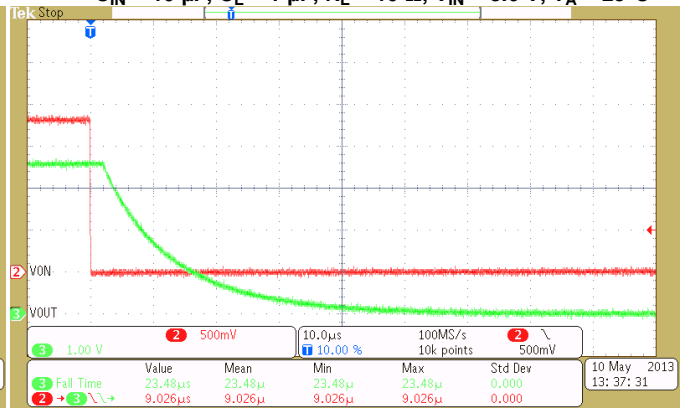

APPLICATION INFORMATION

ON/OFF Control

The ON pin controls the state of the switch. Asserting ON high enables the switch. ON is active high and has a low threshold, making it capable of interfacing with low-voltage signals. The ON pin is compatible with standard GPIO logic threshold. It can be used with any microcontroller with 1.2-V, 1.8-V, 2.5-V or 3.3-V GPIOs.

Input Capacitor

To limit the voltage drop on the input supply caused by transient inrush currents when the switch turns on into a discharged load capacitor or short-circuit, a capacitor needs to be placed between V_{IN} and GND. A 1- μ F ceramic capacitor, C_{IN} , placed close to the pins is usually sufficient. Higher values of C_{IN} can be used to further reduce the voltage drop.

Output Capacitor

Due to the integrated body diode in the NMOS switch, a C_{IN} greater than C_L is highly recommended. A C_L greater than C_{IN} can cause V_{OUT} to exceed V_{IN} when the system supply is removed. This could result in current flow through the body diode from V_{OUT} to V_{IN} . A C_{IN} to C_L ratio of 10 to 1 is recommended for minimizing V_{IN} dip caused by inrush currents during startup.

Output Pulldown

The output pulldown is active when the user is turning off the main pass FET. The pulldown discharges the output rail to approximately 10% of the rail, then the output pulldown is automatically disconnected to optimize the shutdown current.

Board Layout

For best performance, all traces should be as short as possible. To be most effective, the input and output capacitors should be placed close to the device to minimize the effects that parasitic trace inductances may have on normal and short-circuit operation. Using wide traces for V_{IN} , V_{OUT} , and GND helps minimize the parasitic electrical effects along with minimizing the case to ambient thermal impedance.

PACKAGING INFORMATION

Orderable Device	Status (1)	Package Type	Package Drawing	Pins	Package Qty	Eco Plan (2)	Lead finish/ Ball material (6)	MSL Peak Temp (3)	Op Temp (°C)	Device Marking (4/5)	Samples
TPS22924DYZPR	ACTIVE	DSBGA	YZP	6	3000	RoHS & Green	SNAGCU	Level-1-260C-UNLIM	-40 to 85	DL	Samples
TPS22924DYZPT	ACTIVE	DSBGA	YZP	6	250	RoHS & Green	SNAGCU	Level-1-260C-UNLIM	-40 to 85	DL	Samples

(1) The marketing status values are defined as follows:

ACTIVE: Product device recommended for new designs.

LIFEBUY: TI has announced that the device will be discontinued, and a lifetime-buy period is in effect.

NRND: Not recommended for new designs. Device is in production to support existing customers, but TI does not recommend using this part in a new design.

PREVIEW: Device has been announced but is not in production. Samples may or may not be available.

OBSOLETE: TI has discontinued the production of the device.

(2) **RoHS:** TI defines "RoHS" to mean semiconductor products that are compliant with the current EU RoHS requirements for all 10 RoHS substances, including the requirement that RoHS substance do not exceed 0.1% by weight in homogeneous materials. Where designed to be soldered at high temperatures, "RoHS" products are suitable for use in specified lead-free processes. TI may reference these types of products as "Pb-Free".

RoHS Exempt: TI defines "RoHS Exempt" to mean products that contain lead but are compliant with EU RoHS pursuant to a specific EU RoHS exemption.

Green: TI defines "Green" to mean the content of Chlorine (Cl) and Bromine (Br) based flame retardants meet JS709B low halogen requirements of <=1000ppm threshold. Antimony trioxide based flame retardants must also meet the <=1000ppm threshold requirement.

(3) MSL, Peak Temp. - The Moisture Sensitivity Level rating according to the JEDEC industry standard classifications, and peak solder temperature.

(4) There may be additional marking, which relates to the logo, the lot trace code information, or the environmental category on the device.

(5) Multiple Device Markings will be inside parentheses. Only one Device Marking contained in parentheses and separated by a "~" will appear on a device. If a line is indented then it is a continuation of the previous line and the two combined represent the entire Device Marking for that device.

(6) Lead finish/Ball material - Orderable Devices may have multiple material finish options. Finish options are separated by a vertical ruled line. Lead finish/Ball material values may wrap to two lines if the finish value exceeds the maximum column width.

Important Information and Disclaimer:The information provided on this page represents TI's knowledge and belief as of the date that it is provided. TI bases its knowledge and belief on information provided by third parties, and makes no representation or warranty as to the accuracy of such information. Efforts are underway to better integrate information from third parties. TI has taken and continues to take reasonable steps to provide representative and accurate information but may not have conducted destructive testing or chemical analysis on incoming materials and chemicals. TI and TI suppliers consider certain information to be proprietary, and thus CAS numbers and other limited information may not be available for release.

In no event shall TI's liability arising out of such information exceed the total purchase price of the TI part(s) at issue in this document sold by TI to Customer on an annual basis.

EXAMPLE BOARD LAYOUT

YZP0006

DSBGA - 0.5 mm max height

DIE SIZE BALL GRID ARRAY



LAND PATTERN EXAMPLE
SCALE:40X

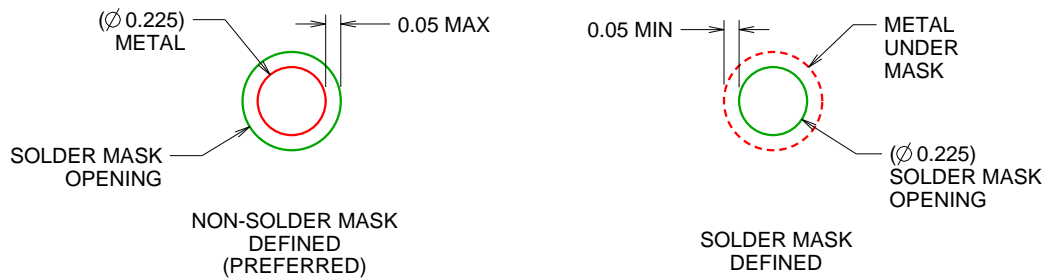

SOLDER MASK DETAILS
NOT TO SCALE

4219524/A 06/2014

NOTES: (continued)

- Final dimensions may vary due to manufacturing tolerance considerations and also routing constraints. For more information, see Texas Instruments literature number SBVA017 (www.ti.com/lit/sbva017).

EXAMPLE STENCIL DESIGN

YZP0006

DSBGA - 0.5 mm max height

DIE SIZE BALL GRID ARRAY

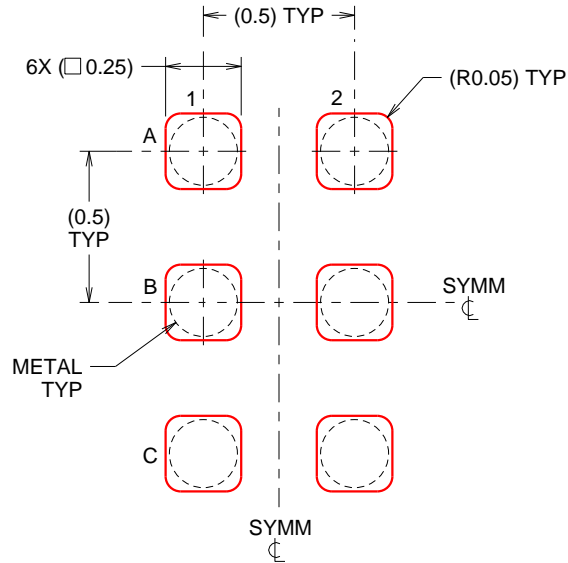

SOLDER PASTE EXAMPLE
BASED ON 0.1 mm THICK STENCIL
SCALE:40X

4219524/A 06/2014

NOTES: (continued)

5. Laser cutting apertures with trapezoidal walls and rounded corners may offer better paste release.

重要声明和免责声明

TI 均以“原样”提供技术性及其可靠性数据（包括数据表）、设计资源（包括参考设计）、应用或其他设计建议、网络工具、安全信息和其他资源，不保证其中不含任何瑕疵，且不做任何明示或暗示的担保，包括但不限于对适销性、适合某特定用途或不侵犯任何第三方知识产权的暗示担保。

所述资源可供专业开发人员应用TI 产品进行设计使用。您将对以下行为独自承担全部责任：(1) 针对您的应用选择合适的TI 产品；(2) 设计、验证并测试您的应用；(3) 确保您的应用满足相应标准以及任何其他安全、安保或其他要求。所述资源如有变更，恕不另行通知。TI 对您使用所述资源的授权仅限于开发资源所涉及TI 产品的相关应用。除此之外不得复制或展示所述资源，也不提供其它TI 或任何第三方的知识产权授权许可。如因使用所述资源而产生任何索赔、赔偿、成本、损失及债务等，TI 对此概不负责，并且您须赔偿由此对TI 及其代表造成的损害。

TI 所提供产品均受TI 的销售条款 (<http://www.ti.com.cn/zh-cn/legal/termsofsale.html>) 以及ti.com.cn上或随附TI产品提供的其他可适用条款的约束。TI提供所述资源并不扩展或以其他方式更改TI 针对TI 产品所发布的可适用的担保范围或担保免责声明。

邮寄地址：上海市浦东新区世纪大道 1568 号中建大厦 32 楼，邮政编码：200122

Copyright © 2020 德州仪器半导体技术（上海）有限公司