

TPS2291xx 5.5V、2A、37mΩ 导通电阻负载开关

1 特性

- 集成单通道负载开关
- 输入电压范围：1.05 V 至 5.5 V
- 低导通电阻 (R_{ON})
 - $R_{ON} = 37m\Omega$ ($V_{IN} = 5V$ 时的典型值)
 - $R_{ON} = 38m\Omega$ ($V_{IN} = 3.3V$ 时的典型值)
 - $R_{ON} = 43m\Omega$ ($V_{IN} = 1.8V$ 时的典型值)
- 2A 最大持续开关电流
- 低静态电流
 - $7.7\mu A$ ($V_{IN} = 3.3V$ 时的典型值)
- 低控制输入阈值允许使用 1 V 或更高电压的通用输入输出 (GPIO) 接口
- 受控转换率
 - $V_{IN} = 3.3V$ 时, $t_R(\text{TPS22914B/15B}) = 64\mu s$
 - $V_{IN} = 3.3V$ 时, $t_R(\text{TPS22914C/15C}) = 913\mu s$
- 快速输出放电 (只适用于 TPS22915)
- 超小型晶圆级芯片尺寸封装
 - $0.78mm \times 0.78mm$, $0.4mm$ 间距, $0.5mm$ 高度 (YFP)
- 根据 JESD 22 测试得出的静电放电 (ESD) 性能
 - 2kV 人体放电模式 (HBM) 和 1kV 器件充电模型 (CDM)

2 应用

- 智能手机、手机
- 超薄、超极本™/笔记本电脑
- 平板电脑、平板手机
- 可穿戴技术
- 固态硬盘
- 数码照相机

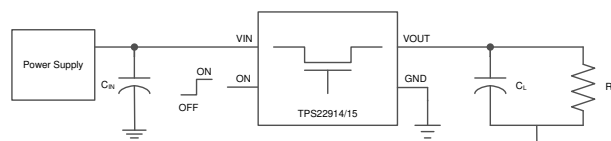

简化版原理图

3 说明

TPS22914/15 是一款小型、低 R_{ON} 、具有受控压摆率的单通道负载开关。此器件包括一个 N 沟道金属氧化物半导体场效应晶体管 (MOSFET)，可在 1.05 V 至 5.5 V 的输入电压范围内运行并可支持 2A 的最大持续电流。此开关由一个开关输入控制，能够直接连接低电压控制信号。

小尺寸和低 R_{ON} 使得此器件非常适合于空间受限、电池供电类应用。此开关的宽输入电压范围使得它成为针对很多不同电压轨的多用途解决方案。器件的受控上升时间大大减少了由大容量负载电容导致的涌入电流，从而减少或消除了电源消耗。通过集成一个在开关关闭时实现快速输出放电 (QOD) 的 143Ω 下拉电阻器，TPS22915 进一步减少了总体解决方案尺寸。

TPS22914/15 采用节省空间的小型 $0.78mm \times 0.78mm$ 、 $0.4mm$ 间距、 $0.5mm$ 高度的 4 引脚晶圆级封装 (WCSP) 封装 (YFP)。该器件在自然通风环境下的额定运行温度范围为 $-40^\circ C$ 至 $+105^\circ C$ 。

器件信息⁽¹⁾

器件型号	封装	封装尺寸 (标称值)
TPS22914B	DSBGA (4)	0.74 mm x 0.74 mm
TPS22914C		
TPS22915B		
TPS22915C		

(1) 如需了解所有可用封装，请参阅数据表末尾的可订购产品附录。

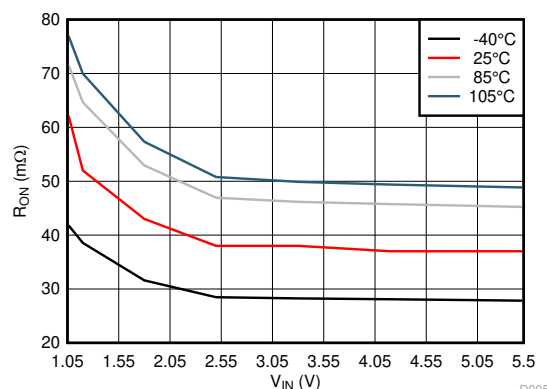

R_{ON} 与 V_{IN} 之间的关系 ($I_{OUT} = -200mA$)

D005



Table of Contents

1 特性	1	9.3 Feature Description.....	16
2 应用	1	9.4 Device Functional Modes.....	17
3 说明	1	10 Application and Implementation	18
4 Revision History	2	10.1 Application Information.....	18
5 Device Comparison Table	3	10.2 Typical Application.....	18
6 Pin Configuration and Functions	3	11 Power Supply Recommendations	20
7 Specifications	4	12 Layout	20
7.1 Absolute Maximum Ratings.....	4	12.1 Layout Guidelines.....	20
7.2 ESD Ratings.....	4	12.2 Layout Example.....	21
7.3 Recommended Operating Conditions.....	4	13 Device and Documentation Support	22
7.4 Thermal Information.....	4	13.1 Documentation Support.....	22
7.5 Electrical Characteristics.....	5	13.2 Related Links.....	22
7.6 Switching Characteristics.....	8	13.3 接收文档更新通知.....	22
7.7 Typical DC Characteristics.....	9	13.4 支持资源.....	22
7.8 Typical AC Characteristics (TPS22914B/15B).....	11	13.5 Trademarks.....	22
7.9 Typical AC Characteristics (TPS22914C/15C).....	13	13.6 静电放电警告.....	22
8 Parameter Measurement Information	15	13.7 术语表.....	22
9 Detailed Description	16	14 Mechanical, Packaging, and Orderable Information	22
9.1 Overview.....	16		
9.2 Functional Block Diagram.....	16		

4 Revision History

注：以前版本的页码可能与当前版本的页码不同

Changes from Revision D (September 2016) to Revision E (October 2020)	Page
• 更新了整个文档中的表格、图和交叉参考的编号格式.....	1
• 更新了 器件信息 表中的封装尺寸.....	1
Changes from Revision C (July 2015) to Revision D (September 2016)	Page
• Changed "TPS22915B" only, to "TPS22915B/C only" in the <i>Electrical Characteristics</i> table	5
Changes from Revision B (September 2014) to Revision C (July 2015)	Page
• 将数据表中的 T_A 额定值从 85°C 更新为 105°C。.....	1
Changes from Revision A (June 2014) to Revision B (September 2014)	Page
• Updated X-axis scales in th Typical Characteristics section.	9
Changes from Revision * (June 2014) to Revision A (June 2014)	Page
• 完整版的最初发布版本。.....	1

5 Device Comparison Table

DEVICE	R _{ON} at 3.3V (TYPICAL)	t _R at 3.3V (TYPICAL)	QUICK OUTPUT DISCHARGE	MAXIMUM OUTPUT CURRENT	ENABLE
TPS22914B	38 mΩ	64 μs	No	2 A	Active High
TPS22914C	38 mΩ	913 μs	No	2 A	Active High
TPS22915B	38 mΩ	64 μs	Yes	2 A	Active High
TPS22915C	38 mΩ	913 μs	Yes	2 A	Active High

6 Pin Configuration and Functions



图 6-1. YFP PACKAGE 4 PIN DSBGA TOP VIEW

表 6-1. Pin Description

B	ON	GND
A	VIN	VOUT
	2	1

表 6-2. Pin Functions

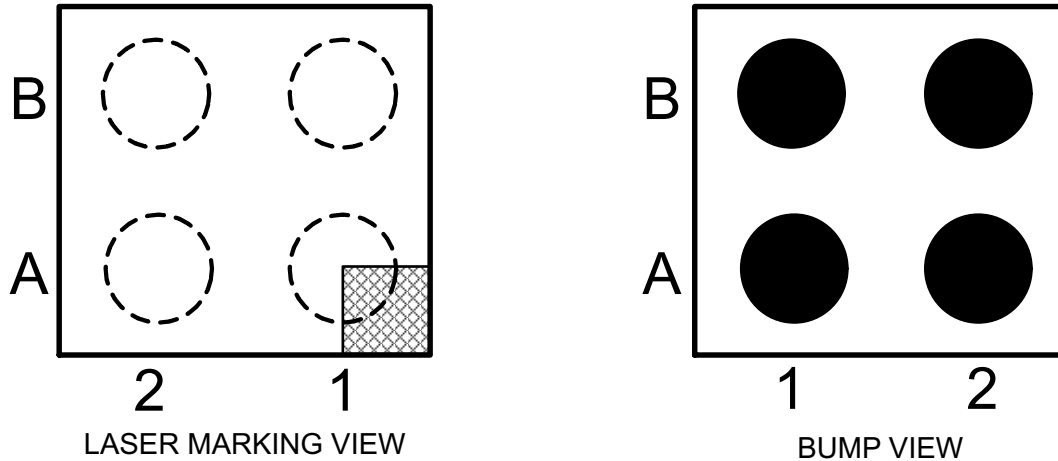
PIN		TYPE	DESCRIPTION
NO.	NAME		
A1	VOUT	O	Switch output. Place ceramic bypass capacitor(s) between this pin and GND. See the Detailed Description section for more information
A2	VIN	I	Switch input. Place ceramic bypass capacitor(s) between this pin and GND. See the Detailed Description section for more information
B1	GND	—	Device ground
B2	ON	I	Active high switch control input. Do not leave floating

7 Specifications

7.1 Absolute Maximum Ratings

Over operating free-air temperature range (unless otherwise noted)^{(1) (2)}

		MIN	MAX	UNIT
V _{IN}	Input voltage	- 0.3	6	V
V _{OUT}	Output voltage	- 0.3	6	V
V _{ON}	ON voltage	- 0.3	6	V
I _{MAX}	Maximum continuous switch current		2	A
I _{PLS}	Maximum pulsed switch current, pulse < 300 μs, 2% duty cycle		2.5	A
T _J	Maximum junction temperature		125	°C
T _{STG}	Storage temperature	- 65	150	°C

- (1) Stresses beyond those listed under *Absolute Maximum Ratings* may cause permanent damage to the device. These are stress ratings only, which do not imply functional operation of the device at these or any other conditions beyond those indicated under *Recommended Operating Conditions*. Exposure to absolute-maximum-rated conditions for extended periods may affect device reliability.
- (2) All voltage values are with respect to network ground terminal.

7.2 ESD Ratings

			VALUE	UNIT
V _(ESD)	Electrostatic discharge	Human-body model (HBM), per ANSI/ESDA/JEDEC JS-001 ⁽¹⁾	±2000	V
		Charged-device model (CDM), per JEDEC specification JESD22-C101 ⁽²⁾	±1000	

- (1) JEDEC document JEP155 states that 500-V HBM allows safe manufacturing with a standard ESD control process. Manufacturing with less than 500-V HBM is possible with the necessary precautions.
- (2) JEDEC document JEP157 states that 250-V CDM allows safe manufacturing with a standard ESD control process. Manufacturing with less than 250-V CDM is possible with the necessary precautions.

7.3 Recommended Operating Conditions

Over operating free-air temperature range (unless otherwise noted)

			MIN	MAX	UNIT
V _{IN}	Input voltage		1.05	5.5	V
V _{ON}	ON voltage		0	5.5	V
V _{OUT}	Output voltage			V _{IN}	V
V _{IH, ON}	High-level input voltage, ON	V _{IN} = 1.05 V to 5.5 V	1	5.5	V
V _{IL, ON}	Low-level input voltage, ON	V _{IN} = 1.05 V to 5.5 V	0	0.5	V
T _A	Operating free-air temperature range ⁽¹⁾		- 40	105	°C
C _{IN}	Input Capacitor		1 ⁽²⁾		μF

- (1) In applications where high power dissipation and/or poor package thermal resistance is present, the maximum ambient temperature may have to be derated. Maximum ambient temperature [T_{A(MAX)}] is dependent on the maximum operating junction temperature [T_{J(MAX)}], the maximum power dissipation of the device in the application [P_{D(MAX)}], and the junction-to-ambient thermal resistance of the part/package in the application (θ_{JA}), as given by the following equation: T_{A(MAX)} = T_{J(MAX)} - (θ_{JA} × P_{D(MAX)}).
- (2) Refer to the [Detailed Description](#) section.

7.4 Thermal Information

THERMAL METRIC ⁽¹⁾	TPS2291x		UNIT
	YFP (DSBGA)		
	4 PINS		
R _{θJA}	Junction-to-ambient thermal resistance	193	°C/W
R _{θJC(top)}	Junction-to-case (top) thermal resistance	2.3	°C/W
R _{θJB}	Junction-to-board thermal resistance	36	°C/W
ψ _{JT}	Junction-to-top characterization parameter	12	°C/W

7.4 Thermal Information (continued)

THERMAL METRIC ⁽¹⁾	TPS2291x	UNIT
	YFP (DSBGA)	
	4 PINS	
ψ_{JB} Junction-to-board characterization parameter	36	°C/W

(1) For more information about traditional and new thermal metrics, see the [Semiconductor and IC Package Thermal Metrics](#) application report.

7.5 Electrical Characteristics

Unless otherwise noted, the specification in the following table applies over the operating ambient temperature $-40^{\circ}\text{C} \leq T_A \leq +105^{\circ}\text{C}$. **Typical values are for $T_A = 25^{\circ}\text{C}$.**

PARAMETER		TEST CONDITION		T_A	MIN	TYP	MAX	UNIT
$I_{Q, VIN}$	Quiescent current (TPS22914B/15B)	$V_{ON} = 5\text{ V}, I_{OUT} = 0\text{ A}$	$V_{IN} = 5.5\text{ V}$	-40°C to +85°C	7.7	10.8	μA	
				-40°C to +105°C	12.1			
			$V_{IN} = 5\text{ V}$	-40°C to +85°C	7.6	9.6		
				-40°C to +105°C	11.9			
			$V_{IN} = 3.3\text{ V}$	-40°C to +85°C	7.7	9.6		
				-40°C to +105°C	12			
			$V_{IN} = 1.8\text{ V}$	-40°C to +85°C	8.4	11		
	-40°C to +105°C	13.5						
	$V_{IN} = 1.2\text{ V}$	-40°C to +85°C	7.4	10.4				
		-40°C to +105°C	13.9					
	$V_{IN} = 1.05\text{ V}$	-40°C to +85°C	6.7	10.9				
		-40°C to +105°C	11.7					
	Quiescent current (TPS22914C/15C)	$V_{ON} = 5\text{ V}, I_{OUT} = 0\text{ A}$	$V_{IN} = 5.5\text{ V}$	-40°C to +85°C	7.7	11.5		μA
				-40°C to +105°C	14.1			
$V_{IN} = 5\text{ V}$			-40°C to +85°C	7.6	11.1			
			-40°C to +105°C	13.7				
$V_{IN} = 3.3\text{ V}$			-40°C to +85°C	7.7	10.7			
			-40°C to +105°C	13.3				
$V_{IN} = 1.8\text{ V}$			-40°C to +85°C	8.4	11.7			
			-40°C to +105°C	13.4				
$V_{IN} = 1.2\text{ V}$			-40°C to +85°C	7.4	11			
			-40°C to +105°C	12.8				
$V_{IN} = 1.05\text{ V}$	-40°C to +85°C	6.7	10.9					
	-40°C to +105°C	10.9						

7.5 Electrical Characteristics (continued)

Unless otherwise noted, the specification in the following table applies over the operating ambient temperature
 $-40^{\circ}\text{C} \leq T_A \leq +105^{\circ}\text{C}$. Typical values are for $T_A = 25^{\circ}\text{C}$.

PARAMETER	TEST CONDITION	T_A	MIN	TYP	MAX	UNIT			
$I_{SD, V_{IN}}$ Shutdown current	$V_{ON} = 0\text{ V}, V_{OUT} = 0\text{ V}$	$V_{IN} = 5.5\text{ V}$	$-40^{\circ}\text{C to }+85^{\circ}\text{C}$	0.5	2	μA			
			$-40^{\circ}\text{C to }+105^{\circ}\text{C}$		3				
		$V_{IN} = 5.0\text{ V}$	$-40^{\circ}\text{C to }+85^{\circ}\text{C}$	0.5	2				
			$-40^{\circ}\text{C to }+105^{\circ}\text{C}$		3				
		$V_{IN} = 3.3\text{ V}$	$-40^{\circ}\text{C to }+85^{\circ}\text{C}$	0.5	2				
			$-40^{\circ}\text{C to }+105^{\circ}\text{C}$		3				
		$V_{IN} = 1.8\text{ V}$	$-40^{\circ}\text{C to }+85^{\circ}\text{C}$	0.5	2				
			$-40^{\circ}\text{C to }+105^{\circ}\text{C}$		3				
		$V_{IN} = 1.2\text{ V}$	$-40^{\circ}\text{C to }+85^{\circ}\text{C}$	0.4	2				
			$-40^{\circ}\text{C to }+105^{\circ}\text{C}$		3				
		$V_{IN} = 1.05\text{ V}$	$-40^{\circ}\text{C to }+85^{\circ}\text{C}$	0.4	2				
			$-40^{\circ}\text{C to }+105^{\circ}\text{C}$		3				
		I_{ON} ON pin input leakage current	$V_{IN} = 5.5\text{ V}, I_{OUT} = 0\text{ A}$	$-40^{\circ}\text{C to }+105^{\circ}\text{C}$				0.1	μA
		R_{ON} On-resistance	$V_{IN} = 5.5\text{ V}, I_{OUT} = -200\text{ mA}$	25°C			37	40	$\text{m}\Omega$
$-40^{\circ}\text{C to }+85^{\circ}\text{C}$					51				
$-40^{\circ}\text{C to }+105^{\circ}\text{C}$					57				
$V_{IN} = 5\text{ V}, I_{OUT} = -200\text{ mA}$	25°C			37	41	$\text{m}\Omega$			
	$-40^{\circ}\text{C to }+85^{\circ}\text{C}$				51				
	$-40^{\circ}\text{C to }+105^{\circ}\text{C}$				57				
$V_{IN} = 4.2\text{ V}, I_{OUT} = -200\text{ mA}$	25°C			37	41	$\text{m}\Omega$			
	$-40^{\circ}\text{C to }+85^{\circ}\text{C}$				52				
	$-40^{\circ}\text{C to }+105^{\circ}\text{C}$				58				
$V_{IN} = 3.3\text{ V}, I_{OUT} = -200\text{ mA}$	25°C			38	41	$\text{m}\Omega$			
	$-40^{\circ}\text{C to }+85^{\circ}\text{C}$				52				
	$-40^{\circ}\text{C to }+105^{\circ}\text{C}$				59				
$V_{IN} = 2.5\text{ V}, I_{OUT} = -200\text{ mA}$	25°C			38	42	$\text{m}\Omega$			
	$-40^{\circ}\text{C to }+85^{\circ}\text{C}$				53				
	$-40^{\circ}\text{C to }+105^{\circ}\text{C}$				58				
$V_{IN} = 1.8\text{ V}, I_{OUT} = -200\text{ mA}$	25°C			43	48	$\text{m}\Omega$			
	$-40^{\circ}\text{C to }+85^{\circ}\text{C}$				59				
	$-40^{\circ}\text{C to }+105^{\circ}\text{C}$				66				
$V_{IN} = 1.2\text{ V}, I_{OUT} = -200\text{ mA}$	25°C			52	61	$\text{m}\Omega$			
	$-40^{\circ}\text{C to }+85^{\circ}\text{C}$				73				
	$-40^{\circ}\text{C to }+105^{\circ}\text{C}$				85				
$V_{IN} = 1.05\text{ V}, I_{OUT} = -200\text{ mA}$	25°C			63	96	$\text{m}\Omega$			
	$-40^{\circ}\text{C to }+85^{\circ}\text{C}$				102				
	$-40^{\circ}\text{C to }+105^{\circ}\text{C}$				107				

7.5 Electrical Characteristics (continued)

Unless otherwise noted, the specification in the following table applies over the operating ambient temperature
 $-40^{\circ}\text{C} \leq T_A \leq +105^{\circ}\text{C}$. **Typical values are for $T_A = 25^{\circ}\text{C}$.**

PARAMETER		TEST CONDITION	T_A	MIN	TYP	MAX	UNIT
V_{HYS}	ON pin hysteresis	$V_{\text{IN}} = 5.5 \text{ V}$	25°C		102		mV
		$V_{\text{IN}} = 5 \text{ V}$			100		
		$V_{\text{IN}} = 3.3 \text{ V}$			98		
		$V_{\text{IN}} = 2.5 \text{ V}$			96		
		$V_{\text{IN}} = 1.8 \text{ V}$			96		
		$V_{\text{IN}} = 1.2 \text{ V}$			94		
		$V_{\text{IN}} = 1.05 \text{ V}$			92		
R_{PD} ⁽¹⁾	Output pull down resistor	$V_{\text{IN}} = V_{\text{OUT}} = 3.3 \text{ V}, V_{\text{ON}} = 0 \text{ V}$	- 40°C to +105°C		143	200	Ω

(1) TPS22915B/C only.

7.6 Switching Characteristics

Refer to the timing test circuit in [Figure 8-1](#) (unless otherwise noted) for references to external components used for the test condition in the switching characteristics table. Switching characteristics shown below are only valid for the power-up sequence where VIN is already in steady state condition before the ON pin is asserted high.

PARAMETER		TEST CONDITION	TYP (TPS22914B/15B)	TYP (TPS22914C/15C)	UNIT
V_{IN} = 5 V, V_{ON} = 5 V, T_A = 25°C (unless otherwise noted)					
t _{ON}	Turnon time	R _L = 10 Ω, C _{IN} = 1 μF, C _{OUT} = 0.1 μF	104	1300	μs
t _{OFF}	Turnoff time	R _L = 10 Ω, C _{IN} = 1 μF, C _{OUT} = 0.1 μF	2	2	μs
t _R	V _{OUT} rise time	R _L = 10 Ω, C _{IN} = 1 μF, C _{OUT} = 0.1 μF	89	1277	μs
t _F	V _{OUT} fall time	R _L = 10 Ω, C _{IN} = 1 μF, C _{OUT} = 0.1 μF	2	2	μs
t _D	Delay time	R _L = 10 Ω, C _{IN} = 1 μF, C _{OUT} = 0.1 μF	59	663	μs
V_{IN} = 3.3 V, V_{ON} = 5 V, T_A = 25°C (unless otherwise noted)					
t _{ON}	Turnon time	R _L = 10 Ω, C _{IN} = 1 μF, C _{OUT} = 0.1 μF	83	1077	μs
t _{OFF}	Turnoff time	R _L = 10 Ω, C _{IN} = 1 μF, C _{OUT} = 0.1 μF	2	2	μs
t _R	V _{OUT} rise time	R _L = 10 Ω, C _{IN} = 1 μF, C _{OUT} = 0.1 μF	64	913	μs
t _F	V _{OUT} fall time	R _L = 10 Ω, C _{IN} = 1 μF, C _{OUT} = 0.1 μF	2	2	μs
t _D	Delay time	R _L = 10 Ω, C _{IN} = 1 μF, C _{OUT} = 0.1 μF	52	622	μs
V_{IN} = 1.05 V, V_{ON} = 5 V, T_A = 25°C (unless otherwise noted)					
t _{ON}	Turnon time	R _L = 10 Ω, C _{IN} = 1 μF, C _{OUT} = 0.1 μF	61	752	μs
t _{OFF}	Turnoff time	R _L = 10 Ω, C _{IN} = 1 μF, C _{OUT} = 0.1 μF	3	3	μs
t _R	V _{OUT} rise time	R _L = 10 Ω, C _{IN} = 1 μF, C _{OUT} = 0.1 μF	28	409	μs
t _F	V _{OUT} fall time	R _L = 10 Ω, C _{IN} = 1 μF, C _{OUT} = 0.1 μF	2	2	μs
t _D	Delay time	R _L = 10 Ω, C _{IN} = 1 μF, C _{OUT} = 0.1 μF	47	547	μs

7.7 Typical DC Characteristics



图 7-1. I_Q vs V_{IN} (TPS22914B/15B)



图 7-2. I_Q vs V_{IN} (TPS22914C/15C)

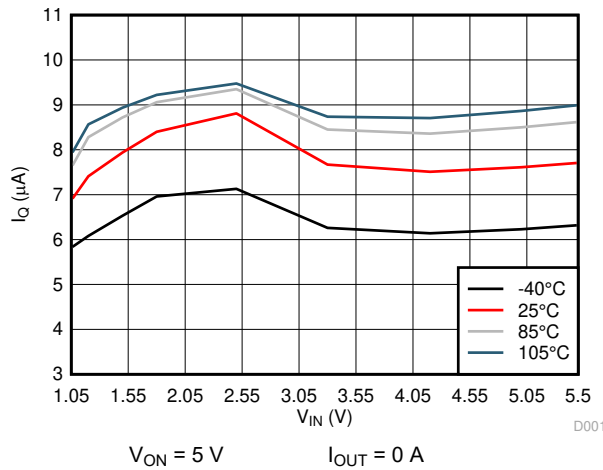

图 7-3. I_{SD} vs V_{IN}

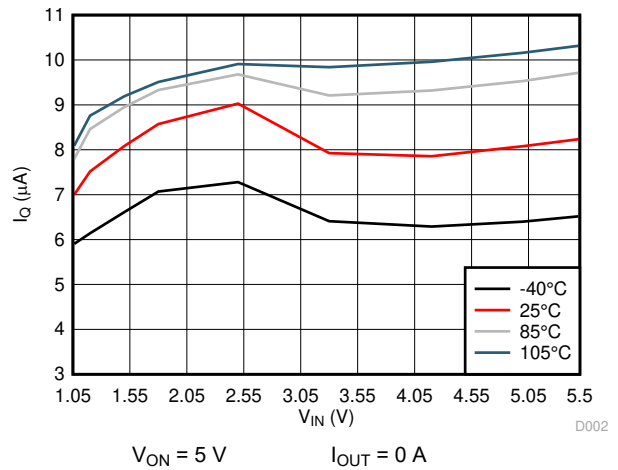

图 7-4. R_{ON} vs T_J

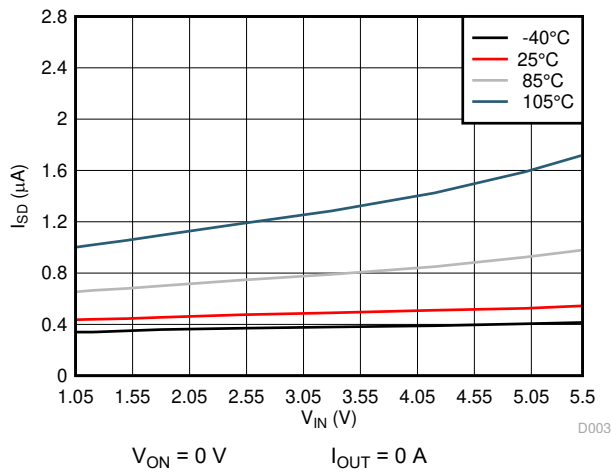

图 7-5. R_{ON} vs V_{IN}

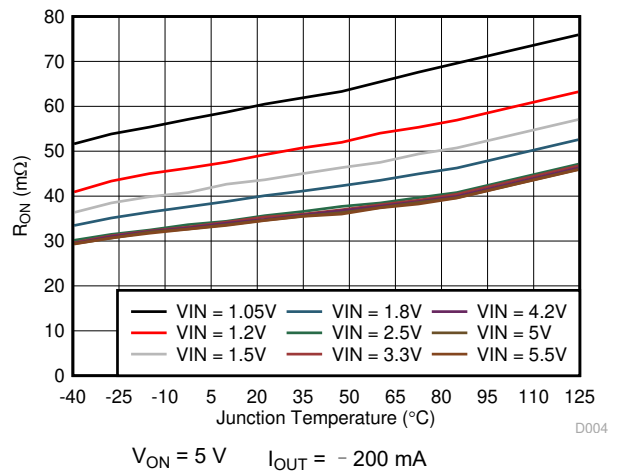

图 7-6. R_{ON} vs I_{OUT}

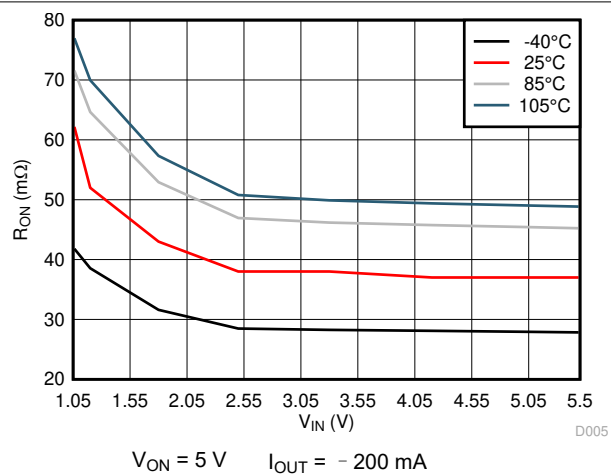

图 7-7. V_{IL} vs V_{IN}

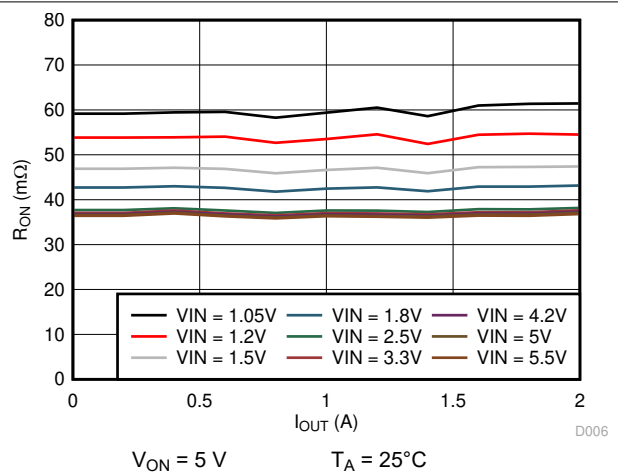

图 7-8. V_{IH} vs V_{IN}

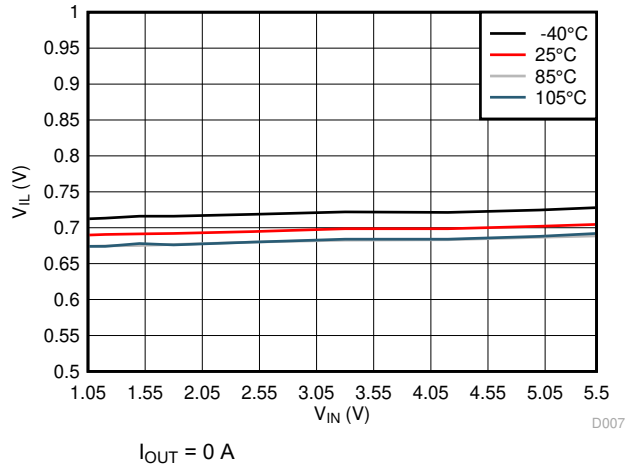

图 7-9. V_{HYS} vs V_{IN}

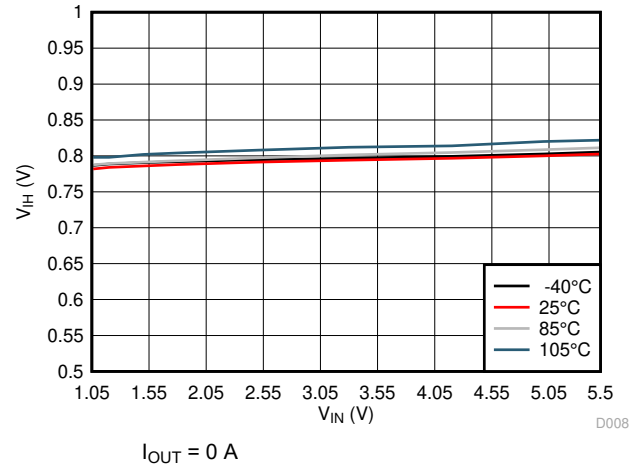

图 7-10. R_{PD} vs V_{IN}

7.8 Typical AC Characteristics (TPS22914B/15B)

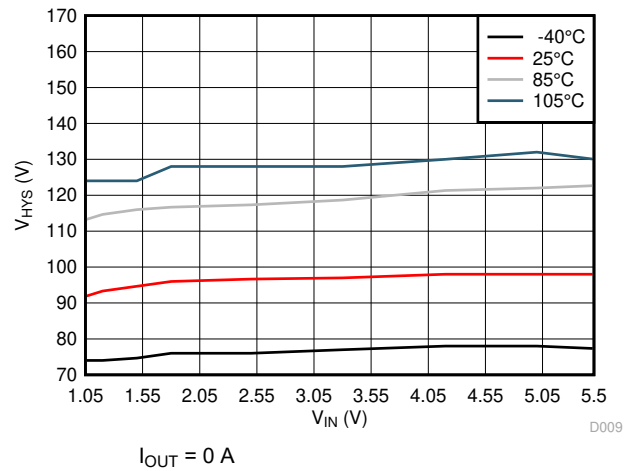

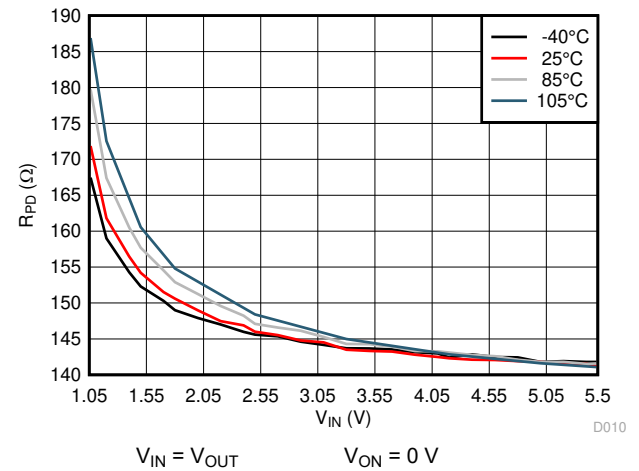
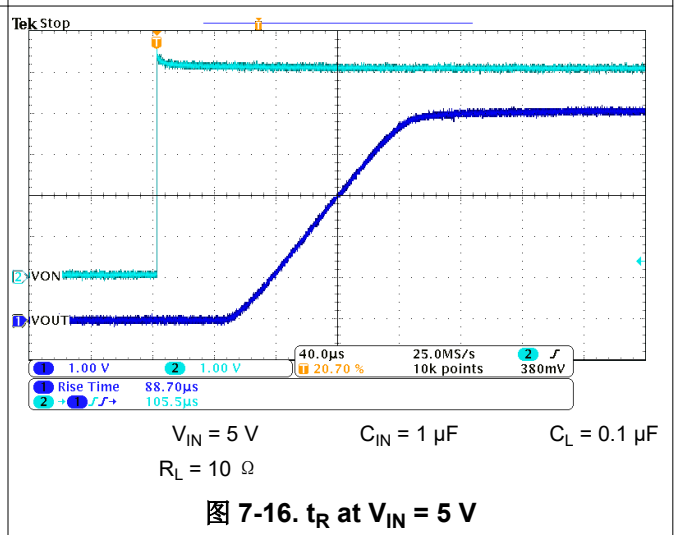
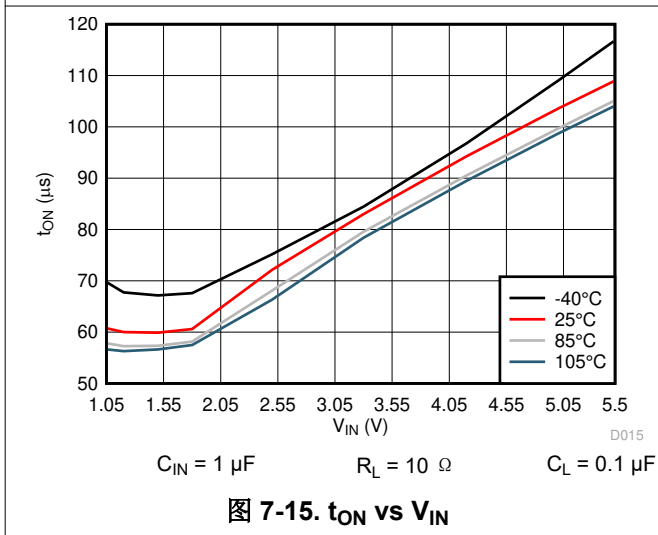
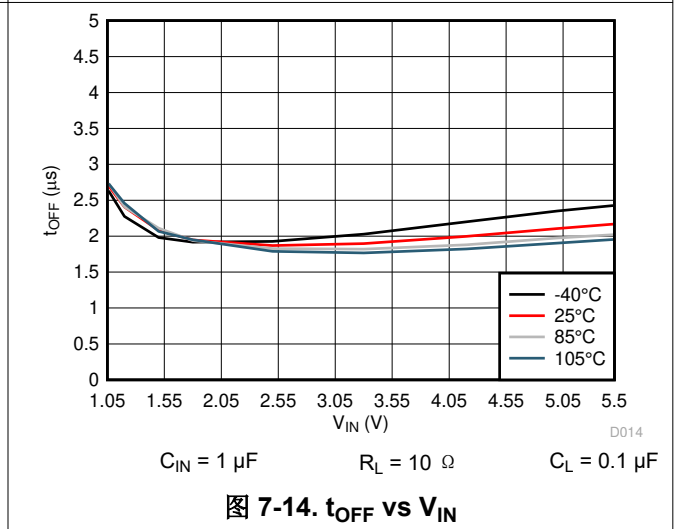
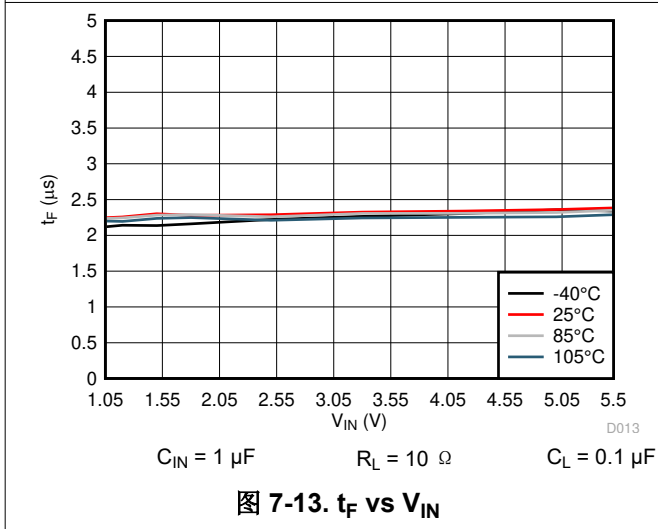
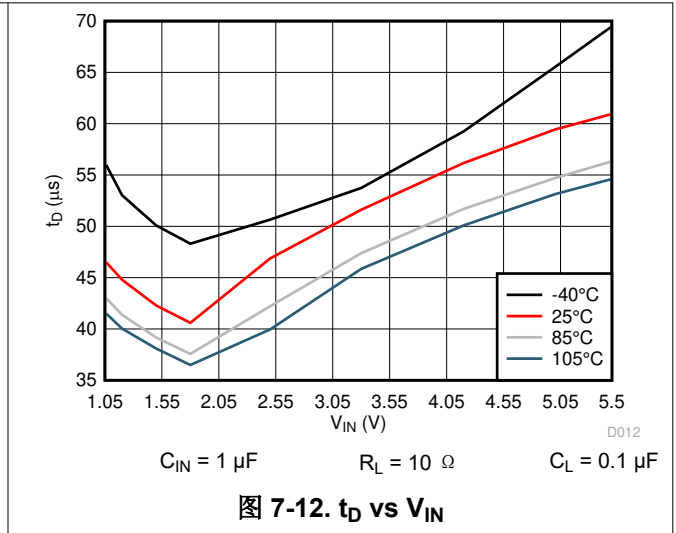
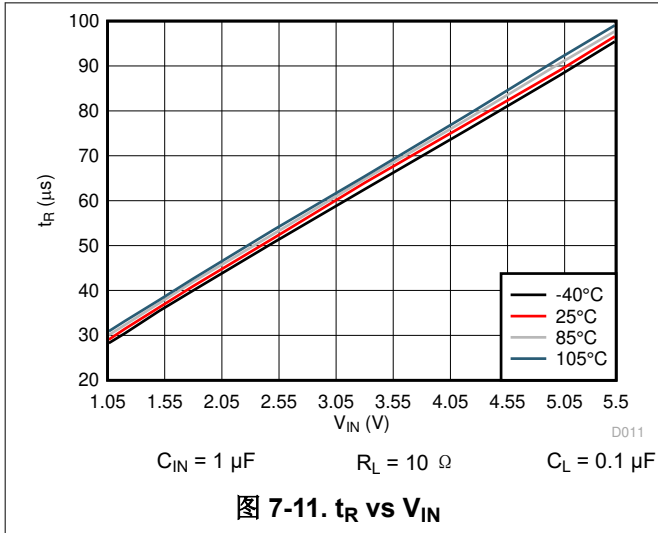

图 7-17. t_F at $V_{IN} = 5\text{ V}$



图 7-18. t_R at $V_{IN} = 3.3\text{ V}$

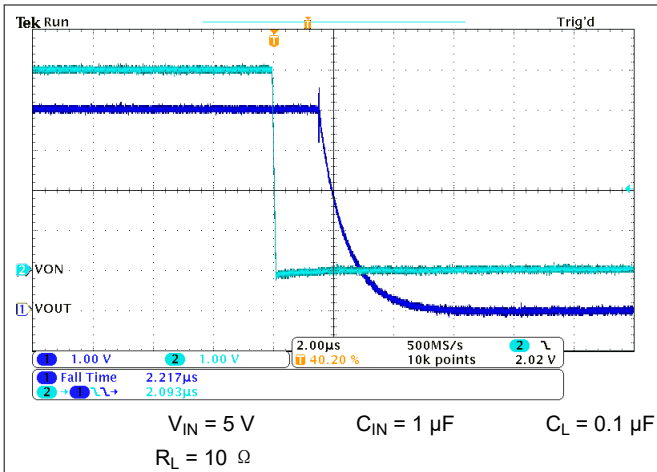

图 7-19. t_F at $V_{IN} = 3.3\text{ V}$

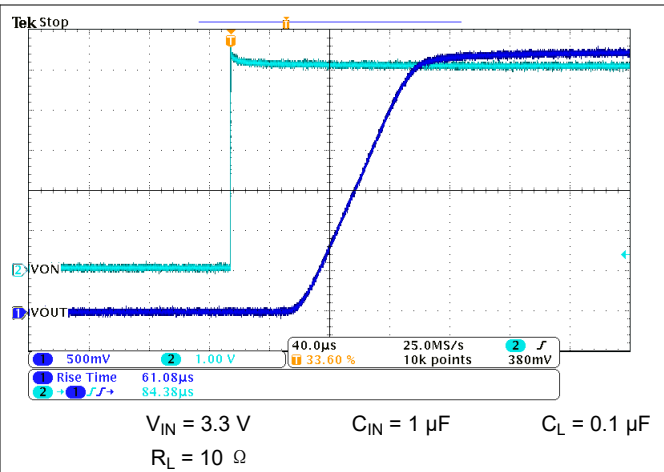

图 7-20. t_R at $V_{IN} = 1.05\text{ V}$

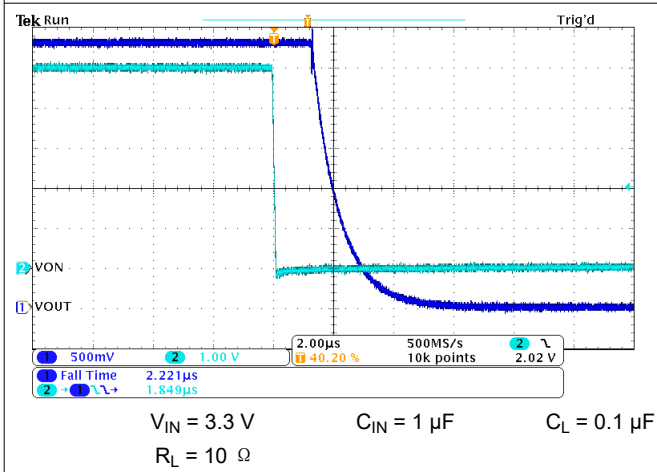

图 7-21. t_F at $V_{IN} = 1.05\text{ V}$

7.9 Typical AC Characteristics (TPS22914C/15C)

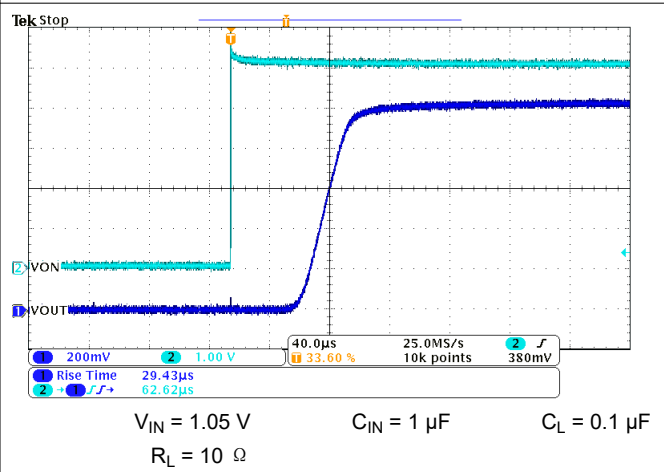

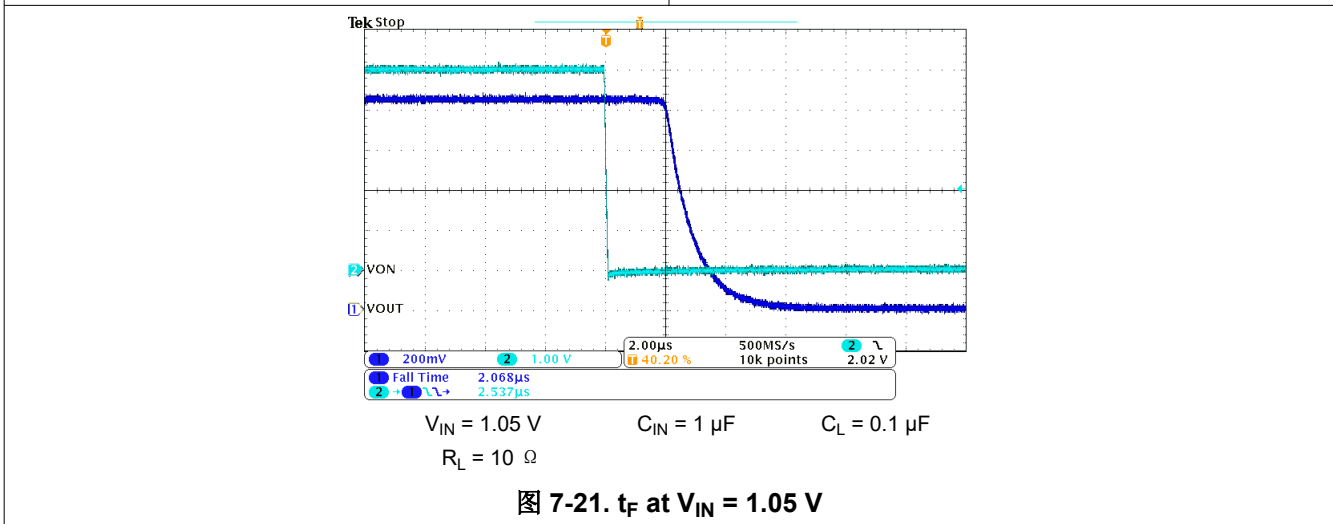
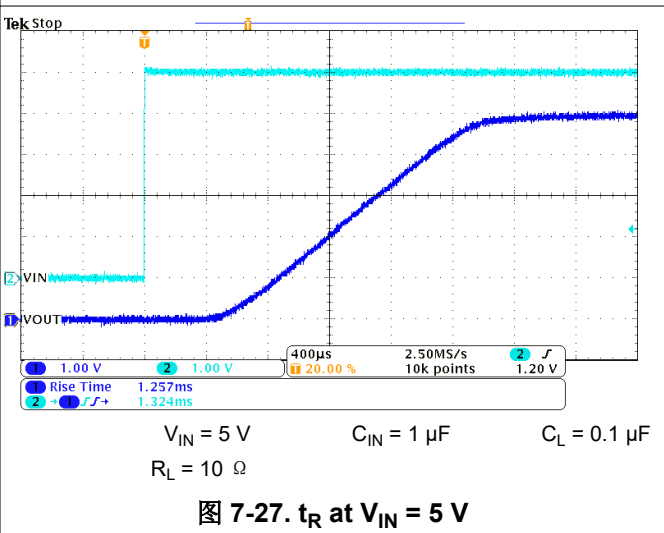
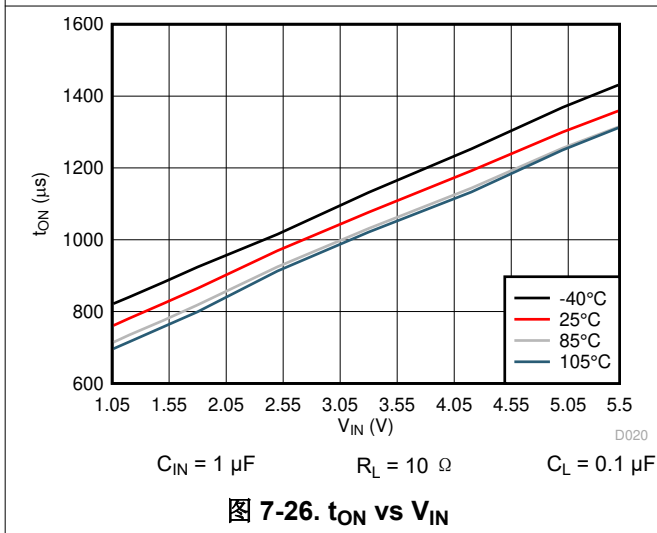
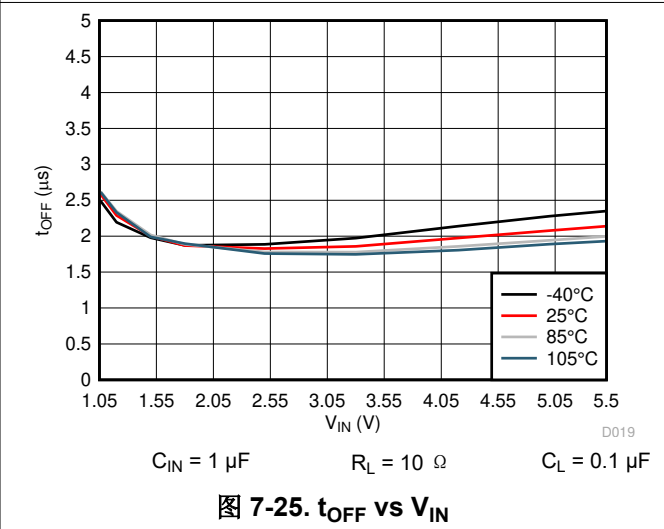
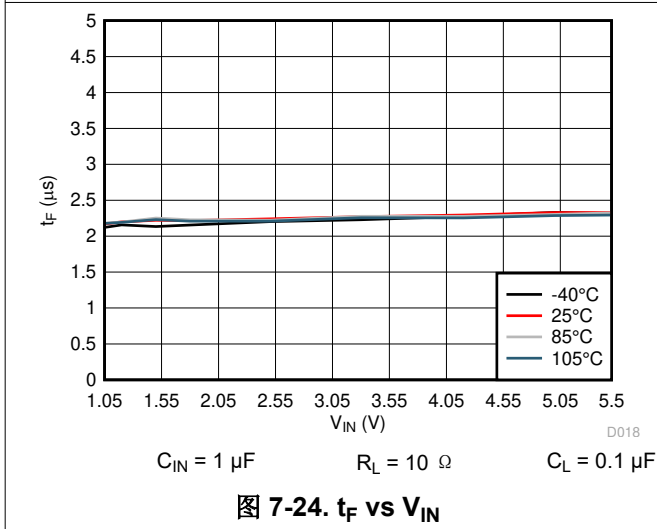
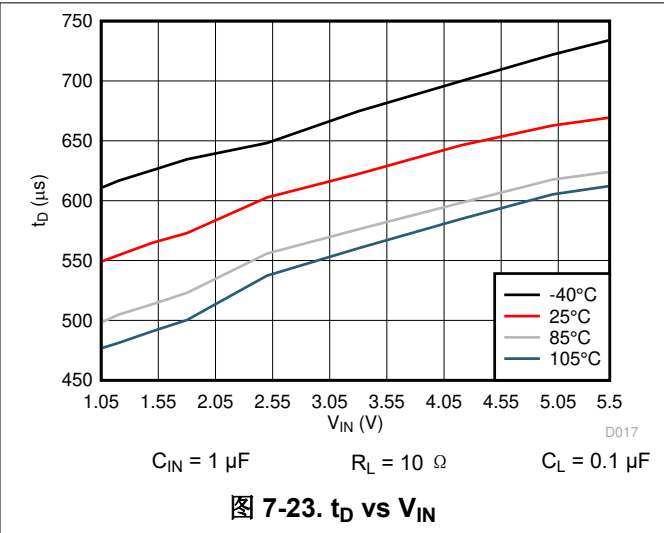
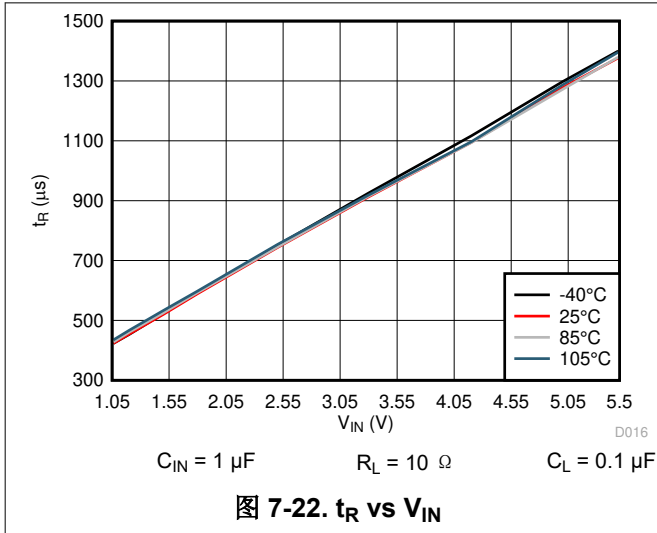

图 7-28. t_F at $V_{IN} = 5\text{ V}$



图 7-29. t_R at $V_{IN} = 3.3\text{ V}$

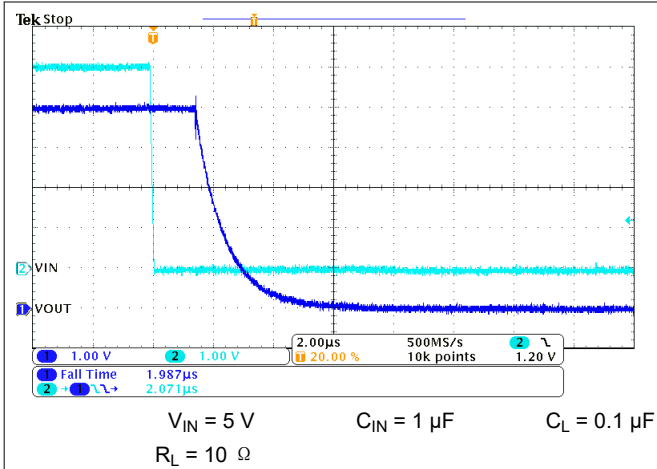

图 7-30. t_F at $V_{IN} = 3.3\text{ V}$

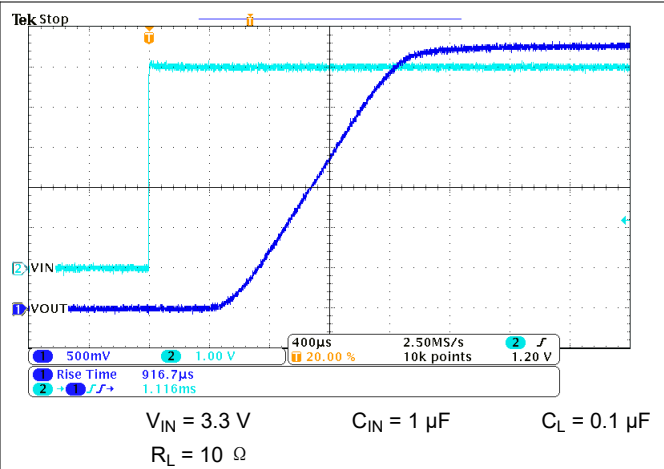

图 7-31. t_R at $V_{IN} = 1.05\text{ V}$

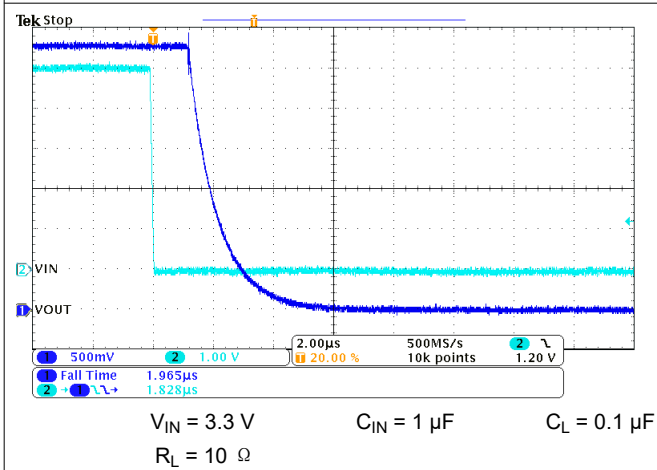

图 7-32. t_F at $V_{IN} = 1.05\text{ V}$

8 Parameter Measurement Information

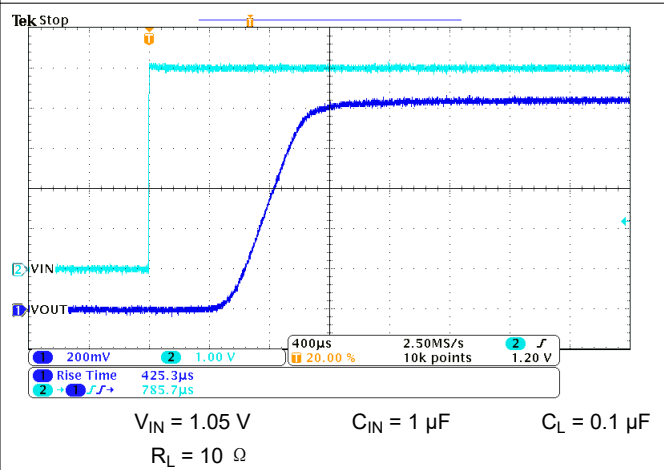

A. Rise and fall times of the control signal is 100ns

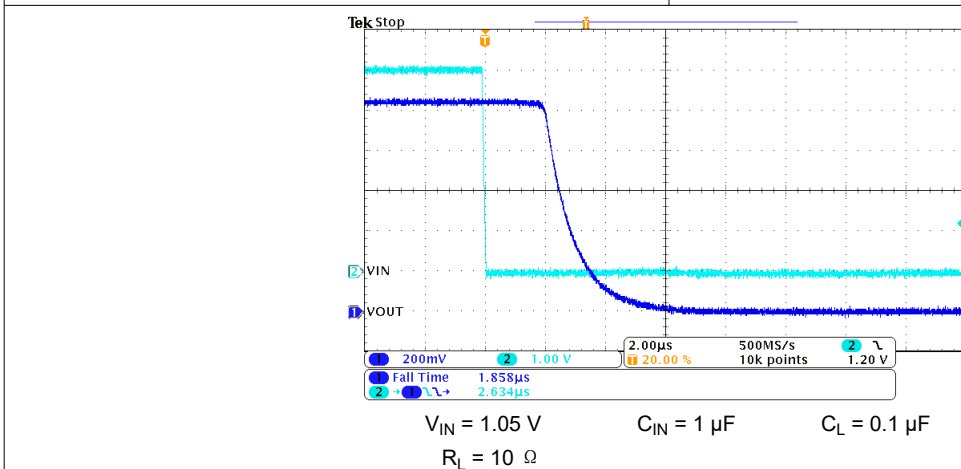
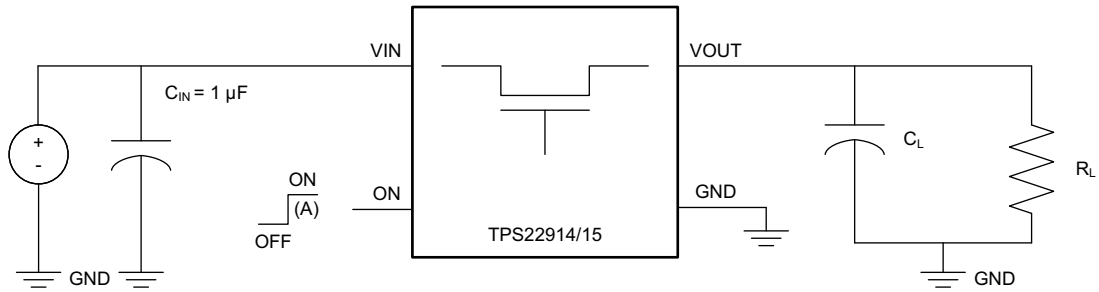
图 8-1. Test Circuit



图 8-2. Timing Waveforms

9 Detailed Description

9.1 Overview

The device is a 5.5-V, 2-A load switch in a 4-pin YFP package. To reduce voltage drop for low voltage and high current rails, the device implements an ultra-low resistance N-channel MOSFET which reduces the drop out voltage through the device.

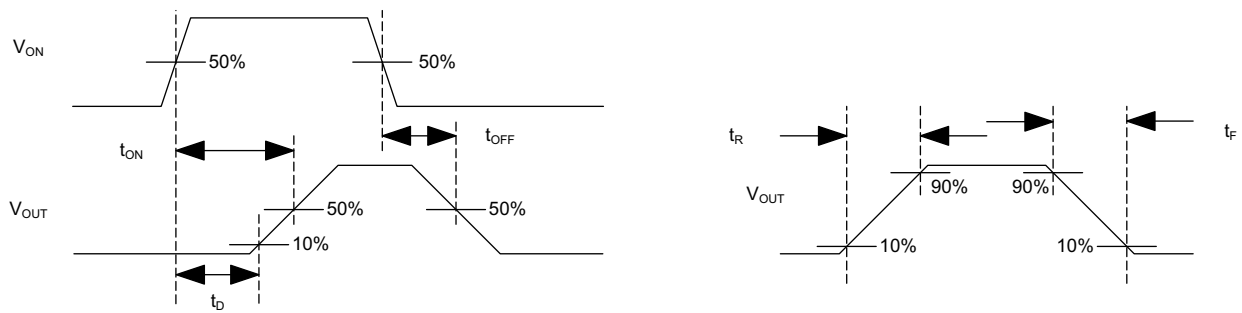
The device has a controlled and fixed slew rate which helps reduce or eliminate power supply droop due to large inrush currents. During shutdown, the device has very low leakage currents, thereby reducing unnecessary leakages for downstream modules during standby. Integrated control logic, driver, charge pump, and output discharge FET eliminates the need for any external components, which reduces solution size and bill of materials (BOM) count.

9.2 Functional Block Diagram

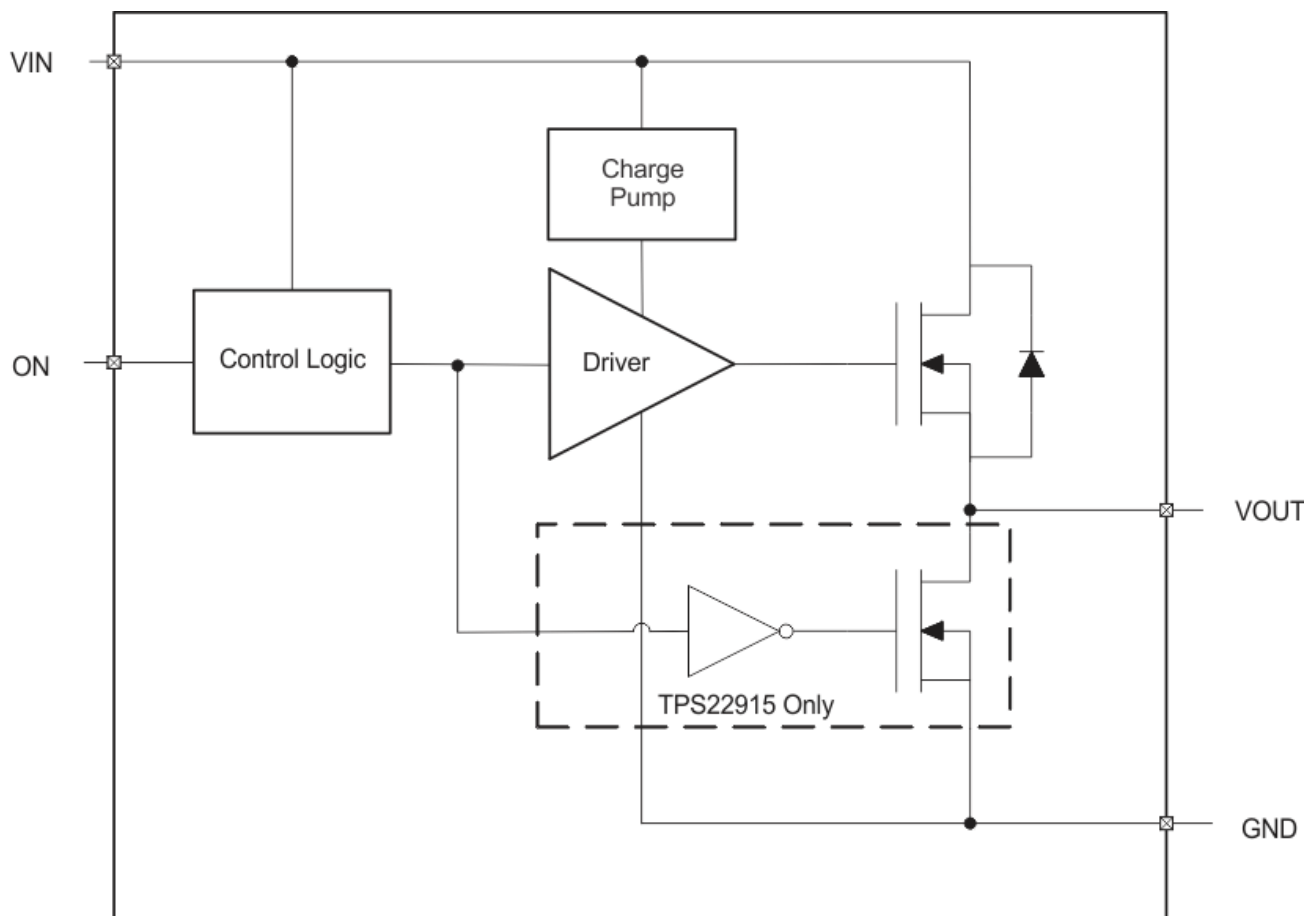

9.3 Feature Description

9.3.1 On and Off Control

The ON pins control the state of the switch. Asserting ON high enables the switch. ON is active high and has a low threshold, making it capable of interfacing with low-voltage signals. The ON pin is compatible with standard GPIO logic threshold. It can be used with any microcontroller with 1 V or higher GPIO voltage. This pin cannot be left floating and must be driven either high or low for proper functionality.

9.3.2 Input Capacitor (C_{IN})

To limit the voltage drop on the input supply caused by transient in-rush currents when the switch turns on into a discharged load capacitor or short-circuit, a capacitor needs to be placed between VIN and GND. A 1- μ F ceramic capacitor, C_{IN} , placed close to the pins, is usually sufficient. Higher values of C_{IN} can be used to further

reduce the voltage drop during high-current application. When switching heavy loads, it is recommended to have an input capacitor about 10 times higher than the output capacitor to avoid excessive voltage drop.

9.3.3 Output Capacitor (C_L)

Due to the integrated body diode in the MOSFET, a C_{IN} greater than C_L is highly recommended. A C_L greater than C_{IN} can cause V_{OUT} to exceed V_{IN} when the system supply is removed. This could result in current flow through the body diode from V_{OUT} to V_{IN} . A C_{IN} to C_L ratio of 10 to 1 is recommended for minimizing V_{IN} dip caused by inrush currents during startup.

9.4 Device Functional Modes

表 9-1 describes the connection of the V_{OUT} pin depending on the state of the ON pin.

表 9-1. V_{OUT} Connection

ON	TPS22914	TPS22915
L	Open	GND
H	VIN	VIN

10 Application and Implementation

Note

以下应用部分的信息不属于 TI 组件规范，TI 不担保其准确性和完整性。客户应负责确定 TI 组件是否适用于其应用。客户应验证并测试其设计，以确保系统功能。

10.1 Application Information

This section highlights some of the design considerations when implementing this device in various applications. A PSPICE model for this device is also available in the product page of this device.

10.2 Typical Application

This typical application demonstrates how the TPS22914 and TPS22915 can be used to power downstream modules.



图 10-1. Typical Application Schematic

10.2.1 Design Requirements

For this design example, use the input parameters shown in 表 10-1.

表 10-1. Design Parameters

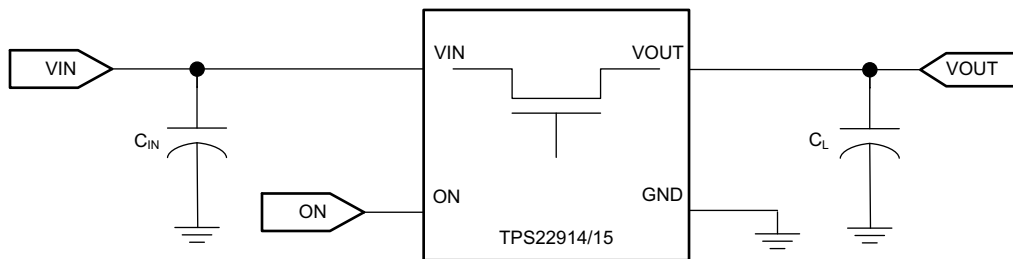
DESIGN PARAMETER	EXAMPLE VALUE
V_{IN}	5 V
Load current	2 A

10.2.2 Detailed Design Procedure

To begin the design process, the designer needs to know the following:

- V_{IN} voltage
- Load Current

10.2.2.1 V_{IN} to V_{OUT} Voltage Drop

The V_{IN} to V_{OUT} voltage drop in the device is determined by the R_{ON} of the device and the load current. The R_{ON} of the device depends upon the V_{IN} conditions of the device. Refer to the R_{ON} specification of the device in the *Electrical Characteristics* table of this datasheet. Once the R_{ON} of the device is determined based upon the V_{IN} conditions, use 方程式 1 to calculate the V_{IN} to V_{OUT} voltage drop.

$$\Delta V = I_{LOAD} \times R_{ON} \quad (1)$$

where

- ΔV = voltage drop from V_{IN} to V_{OUT}
- I_{LOAD} = load current
- R_{ON} = On-resistance of the device for a specific V_{IN}

An appropriate I_{LOAD} must be chosen such that the I_{MAX} specification of the device is not violated.

10.2.2.2 Inrush Current

To determine how much inrush current is caused by the C_L capacitor, use 方程式 2.

$$I_{INRUSH} = C_L \times \frac{dV_{OUT}}{dt} \quad (2)$$

where

- I_{INRUSH} = amount of inrush caused by C_L
- C_L = capacitance on V_{OUT}
- dt = rise time in V_{OUT} during the ramp up of V_{OUT} when the device is enabled
- dV_{OUT} = change in V_{OUT} during the ramp up of V_{OUT} when the device is enabled

An appropriate C_L value must be placed on V_{OUT} such that the I_{MAX} and I_{PLS} specifications of the device are not violated.

10.2.3 Application Curves

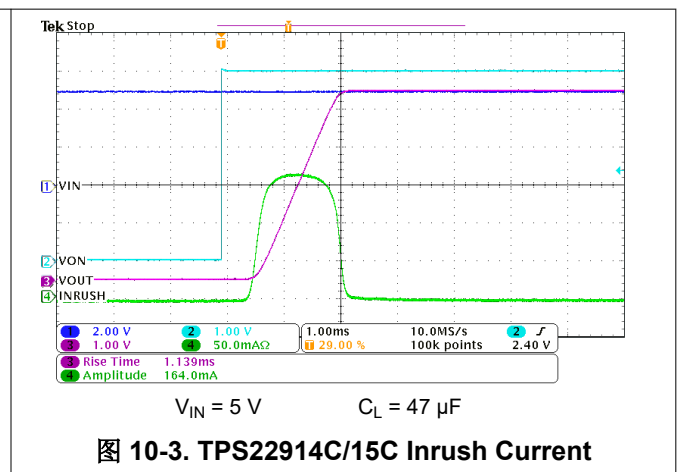
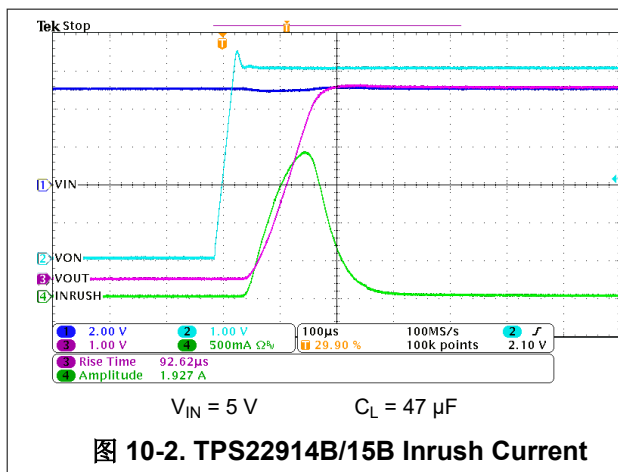

11 Power Supply Recommendations

The device is designed to operate from a VIN range of 1.05 V to 5.5 V. This supply must be well regulated and placed as close to the device terminal as possible with the recommended 1- μ F bypass capacitor. If the supply is located more than a few inches from the device terminals, additional bulk capacitance may be required in addition to the ceramic bypass capacitors. If additional bulk capacitance is required, an electrolytic, tantalum, or ceramic capacitor of 1 μ F may be sufficient.

12 Layout

12.1 Layout Guidelines

1. VIN and VOUT traces must be as short and wide as possible to accommodate for high current.
2. The VIN pin must be bypassed to ground with low ESR ceramic bypass capacitors. The typical recommended bypass capacitance is 1- μ F ceramic with X5R or X7R dielectric. This capacitor must be placed as close to the device pins as possible.
3. The VOUT pin must be bypassed to ground with low ESR ceramic bypass capacitors. The typical recommended bypass capacitance is one-tenth of the VIN bypass capacitor of X5R or X7R dielectric rating. This capacitor must be placed as close to the device pins as possible.

12.1.1 Thermal Considerations

For best performance, all traces must be as short as possible. To be most effective, the input and output capacitors must be placed close to the device to minimize the effects that parasitic trace inductances may have on normal and short-circuit operation. Using wide traces for VIN, VOUT, and GND helps minimize the parasitic electrical effects along with minimizing the case to ambient thermal impedance.

The maximum IC junction temperature must be restricted to 125°C under normal operating conditions. To calculate the maximum allowable dissipation, $P_{D(max)}$ for a given output current and ambient temperature, use [方程式 3](#).

$$P_{D(MAX)} = \frac{T_{J(MAX)} - T_A}{\theta_{JA}} \quad (3)$$

where

- $P_{D(MAX)}$ = maximum allowable power dissipation
- $T_{J(MAX)}$ = maximum allowable junction temperature (125°C for the TPS22914/15)
- T_A = ambient temperature of the device
- θ_{JA} = junction to air thermal impedance. Refer to the [Thermal Information](#) table. This parameter is highly dependent upon board layout.

12.2 Layout Example



图 12-1. Recommended Board Layout

13 Device and Documentation Support

13.1 Documentation Support

13.1.1 Related Documentation

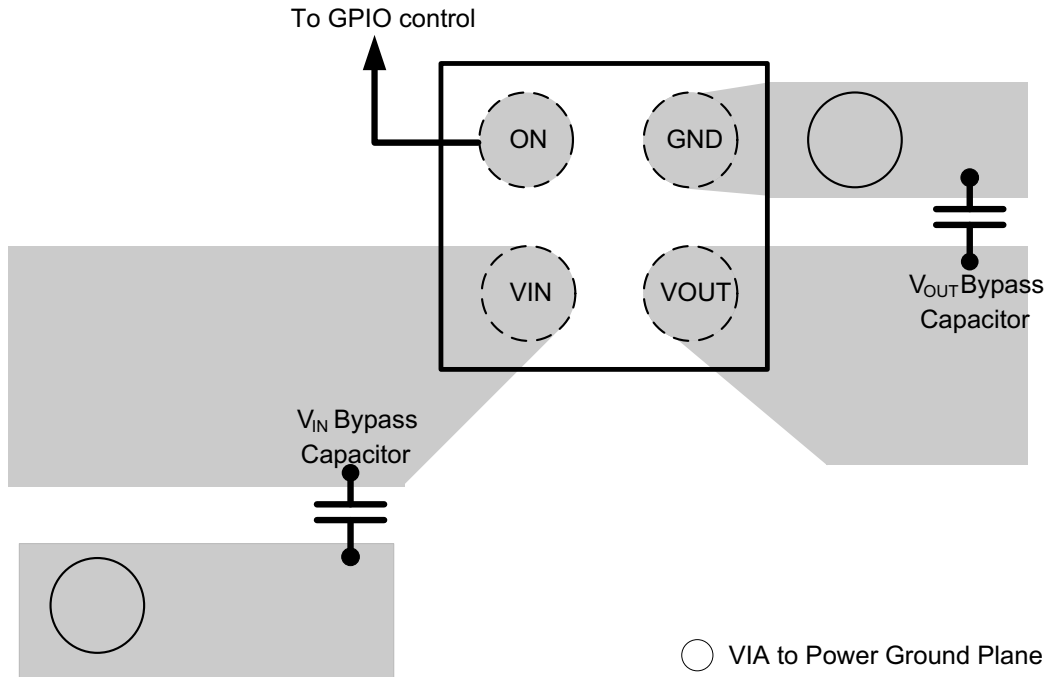
For related documentation see the following:

- [Basics of Load Switches](#)
- [Managing Inrush Current](#)
- [Load Switch Thermal Considerations](#)
- [Using the TPS22915BEVM-078 Single Channel Load Switch IC](#)
- [Implementing Ship Mode Using the TPS22915B Load Switches](#)

13.2 Related Links

The table below lists quick access links. Categories include technical documents, support and community resources, tools and software, and quick access to sample or buy.

表 13-1. Related Links

PARTS	PRODUCT FOLDER	SAMPLE & BUY	TECHNICAL DOCUMENTS	TOOLS & SOFTWARE	SUPPORT & COMMUNITY
TPS22914B	Click here	Click here	Click here	Click here	Click here
TPS22914C	Click here	Click here	Click here	Click here	Click here
TPS22915B	Click here	Click here	Click here	Click here	Click here
TPS22915C	Click here	Click here	Click here	Click here	Click here

13.3 接收文档更新通知

要接收文档更新通知，请导航至 [ti.com](#) 上的器件产品文件夹。点击 [订阅更新](#) 进行注册，即可每周接收产品信息更改摘要。有关更改的详细信息，请查看任何已修订文档中包含的修订历史记录。

13.4 支持资源

TI E2E™ 支持论坛是工程师的重要参考资料，可直接从专家获得快速、经过验证的解答和设计帮助。搜索现有解答或提出自己的问题可获得所需的快速设计帮助。

链接的内容由各个贡献者“按原样”提供。这些内容并不构成 TI 技术规范，并且不一定反映 TI 的观点；请参阅 TI 的《使用条款》。

13.5 Trademarks

超极本™ is a trademark of Intel.

TI E2E™ is a trademark of Texas Instruments.

所有商标均为其各自所有者的财产。

13.6 静电放电警告



静电放电 (ESD) 会损坏这个集成电路。德州仪器 (TI) 建议通过适当的预防措施处理所有集成电路。如果不遵守正确的处理和安装程序，可能会损坏集成电路。

ESD 的损坏小至导致微小的性能降级，大至整个器件故障。精密的集成电路可能更容易受到损坏，这是因为非常细微的参数更改都可能会导致器件与其发布的规格不相符。

13.7 术语表

TI 术语表 本术语表列出并解释了术语、首字母缩略词和定义。

14 Mechanical, Packaging, and Orderable Information

The following pages include mechanical, packaging, and orderable information. This information is the most current data available for the designated devices. This data is subject to change without notice and revision of this document. For browser-based versions of this data sheet, refer to the left-hand navigation.

PACKAGING INFORMATION

Orderable Device	Status (1)	Package Type	Package Drawing	Pins	Package Qty	Eco Plan (2)	Lead finish/ Ball material (6)	MSL Peak Temp (3)	Op Temp (°C)	Device Marking (4/5)	Samples
TPS22914BYFPR	ACTIVE	DSBGA	YFP	4	3000	RoHS & Green	SNAGCU	Level-1-260C-UNLIM	-40 to 105	S3	Samples
TPS22914BYFPT	ACTIVE	DSBGA	YFP	4	250	RoHS & Green	SNAGCU	Level-1-260C-UNLIM	-40 to 105	S3	Samples
TPS22914CYFPR	ACTIVE	DSBGA	YFP	4	3000	RoHS & Green	SNAGCU	Level-1-260C-UNLIM	-40 to 105	S6	Samples
TPS22914CYFPT	ACTIVE	DSBGA	YFP	4	250	RoHS & Green	SNAGCU	Level-1-260C-UNLIM	-40 to 105	S6	Samples
TPS22915BYFPR	ACTIVE	DSBGA	YFP	4	3000	RoHS & Green	SAC396 SNAGCU	Level-1-260C-UNLIM	-40 to 105	S4	Samples
TPS22915BYFPT	ACTIVE	DSBGA	YFP	4	250	RoHS & Green	SAC396 SNAGCU	Level-1-260C-UNLIM	-40 to 105	S4	Samples
TPS22915CYFPR	ACTIVE	DSBGA	YFP	4	3000	RoHS & Green	SNAGCU	Level-1-260C-UNLIM	-40 to 105	S7	Samples
TPS22915CYFPT	ACTIVE	DSBGA	YFP	4	250	RoHS & Green	SNAGCU	Level-1-260C-UNLIM	-40 to 105	S7	Samples

(1) The marketing status values are defined as follows:

ACTIVE: Product device recommended for new designs.

LIFEBUY: TI has announced that the device will be discontinued, and a lifetime-buy period is in effect.

NRND: Not recommended for new designs. Device is in production to support existing customers, but TI does not recommend using this part in a new design.

PREVIEW: Device has been announced but is not in production. Samples may or may not be available.

OBSELETE: TI has discontinued the production of the device.

(2) **RoHS:** TI defines "RoHS" to mean semiconductor products that are compliant with the current EU RoHS requirements for all 10 RoHS substances, including the requirement that RoHS substance do not exceed 0.1% by weight in homogeneous materials. Where designed to be soldered at high temperatures, "RoHS" products are suitable for use in specified lead-free processes. TI may reference these types of products as "Pb-Free".

RoHS Exempt: TI defines "RoHS Exempt" to mean products that contain lead but are compliant with EU RoHS pursuant to a specific EU RoHS exemption.

Green: TI defines "Green" to mean the content of Chlorine (Cl) and Bromine (Br) based flame retardants meet JS709B low halogen requirements of <=1000ppm threshold. Antimony trioxide based flame retardants must also meet the <=1000ppm threshold requirement.

(3) MSL, Peak Temp. - The Moisture Sensitivity Level rating according to the JEDEC industry standard classifications, and peak solder temperature.

(4) There may be additional marking, which relates to the logo, the lot trace code information, or the environmental category on the device.

(5) Multiple Device Markings will be inside parentheses. Only one Device Marking contained in parentheses and separated by a "~" will appear on a device. If a line is indented then it is a continuation of the previous line and the two combined represent the entire Device Marking for that device.

⁽⁶⁾ Lead finish/Ball material - Orderable Devices may have multiple material finish options. Finish options are separated by a vertical ruled line. Lead finish/Ball material values may wrap to two lines if the finish value exceeds the maximum column width.

Important Information and Disclaimer: The information provided on this page represents TI's knowledge and belief as of the date that it is provided. TI bases its knowledge and belief on information provided by third parties, and makes no representation or warranty as to the accuracy of such information. Efforts are underway to better integrate information from third parties. TI has taken and continues to take reasonable steps to provide representative and accurate information but may not have conducted destructive testing or chemical analysis on incoming materials and chemicals. TI and TI suppliers consider certain information to be proprietary, and thus CAS numbers and other limited information may not be available for release.

In no event shall TI's liability arising out of such information exceed the total purchase price of the TI part(s) at issue in this document sold by TI to Customer on an annual basis.

TAPE AND REEL INFORMATION

QUADRANT ASSIGNMENTS FOR PIN 1 ORIENTATION IN TAPE



*All dimensions are nominal

Device	Package Type	Package Drawing	Pins	SPQ	Reel Diameter (mm)	Reel Width W1 (mm)	A0 (mm)	B0 (mm)	K0 (mm)	P1 (mm)	W (mm)	Pin1 Quadrant
TPS22914BYFPR	DSBGA	YFP	4	3000	178.0	9.2	0.85	0.85	0.59	4.0	8.0	Q1
TPS22914BYFPR	DSBGA	YFP	4	3000	180.0	8.4	0.85	0.85	0.64	4.0	8.0	Q1
TPS22914BYFPT	DSBGA	YFP	4	250	178.0	9.2	0.85	0.85	0.59	4.0	8.0	Q1
TPS22914BYFPT	DSBGA	YFP	4	250	180.0	8.4	0.85	0.85	0.64	4.0	8.0	Q1
TPS22914CYFPR	DSBGA	YFP	4	3000	180.0	8.4	0.85	0.85	0.64	4.0	8.0	Q1
TPS22914CYFPT	DSBGA	YFP	4	250	180.0	8.4	0.85	0.85	0.64	4.0	8.0	Q1
TPS22915BYFPR	DSBGA	YFP	4	3000	178.0	9.2	0.85	0.85	0.59	4.0	8.0	Q1
TPS22915BYFPR	DSBGA	YFP	4	3000	180.0	8.4	0.85	0.85	0.64	4.0	8.0	Q1
TPS22915BYFPT	DSBGA	YFP	4	250	178.0	9.2	0.85	0.85	0.59	4.0	8.0	Q1
TPS22915BYFPT	DSBGA	YFP	4	250	180.0	8.4	0.85	0.85	0.64	4.0	8.0	Q1
TPS22915CYFPR	DSBGA	YFP	4	3000	180.0	8.4	0.85	0.85	0.64	4.0	8.0	Q1
TPS22915CYFPT	DSBGA	YFP	4	250	180.0	8.4	0.85	0.85	0.64	4.0	8.0	Q1

TAPE AND REEL BOX DIMENSIONS

*All dimensions are nominal

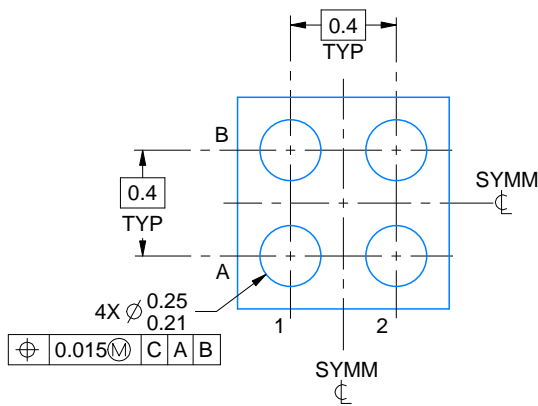
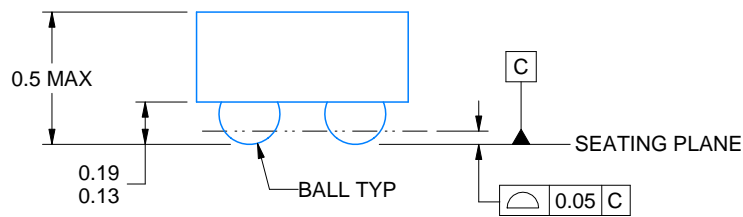
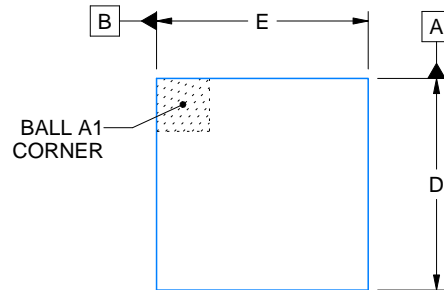
Device	Package Type	Package Drawing	Pins	SPQ	Length (mm)	Width (mm)	Height (mm)
TPS22914BYFPR	DSBGA	YFP	4	3000	220.0	220.0	35.0
TPS22914BYFPR	DSBGA	YFP	4	3000	182.0	182.0	20.0
TPS22914BYFPT	DSBGA	YFP	4	250	220.0	220.0	35.0
TPS22914BYFPT	DSBGA	YFP	4	250	182.0	182.0	20.0
TPS22914CYFPR	DSBGA	YFP	4	3000	182.0	182.0	20.0
TPS22914CYFPT	DSBGA	YFP	4	250	182.0	182.0	20.0
TPS22915BYFPR	DSBGA	YFP	4	3000	220.0	220.0	35.0
TPS22915BYFPR	DSBGA	YFP	4	3000	182.0	182.0	20.0
TPS22915BYFPT	DSBGA	YFP	4	250	220.0	220.0	35.0
TPS22915BYFPT	DSBGA	YFP	4	250	182.0	182.0	20.0
TPS22915CYFPR	DSBGA	YFP	4	3000	182.0	182.0	20.0
TPS22915CYFPT	DSBGA	YFP	4	250	182.0	182.0	20.0



D: Max = 0.778 mm, Min = 0.718 mm
 E: Max = 0.778 mm, Min = 0.718 mm

4223507/A 01/2017

NOTES:

1. All linear dimensions are in millimeters. Any dimensions in parenthesis are for reference only. Dimensioning and tolerancing per ASME Y14.5M.
2. This drawing is subject to change without notice.

EXAMPLE BOARD LAYOUT

YFP0004

DSBGA - 0.5 mm max height

DIE SIZE BALL GRID ARRAY

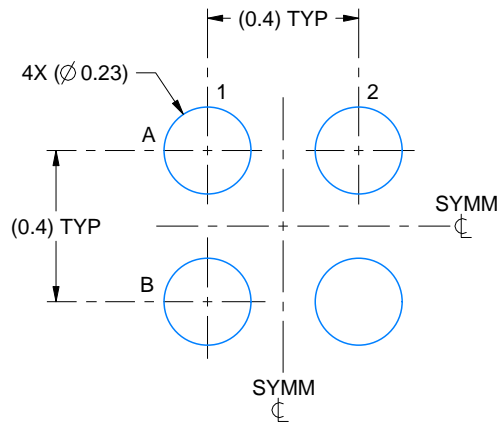

LAND PATTERN EXAMPLE
EXPOSED METAL SHOWN
SCALE:50X

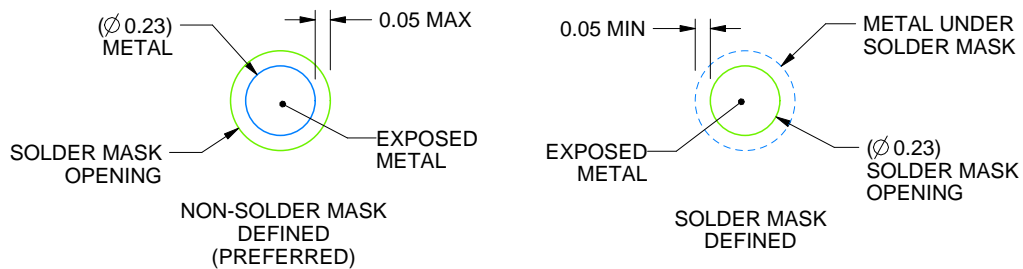

SOLDER MASK DETAILS
NOT TO SCALE

4223507/A 01/2017

NOTES: (continued)

- Final dimensions may vary due to manufacturing tolerance considerations and also routing constraints. For more information, see Texas Instruments literature number SNVA009 (www.ti.com/lit/snva009).

EXAMPLE STENCIL DESIGN

YFP0004

DSBGA - 0.5 mm max height

DIE SIZE BALL GRID ARRAY

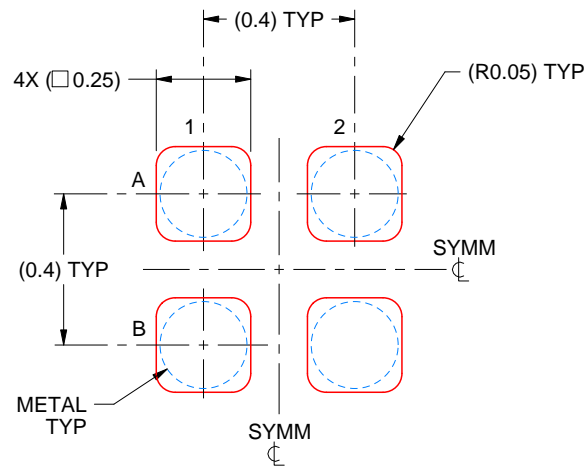

SOLDER PASTE EXAMPLE
BASED ON 0.1 mm THICK STENCIL
SCALE:50X

4223507/A 01/2017

NOTES: (continued)

4. Laser cutting apertures with trapezoidal walls and rounded corners may offer better paste release.

重要声明和免责声明

TI“按原样”提供技术和可靠性数据（包括数据表）、设计资源（包括参考设计）、应用或其他设计建议、网络工具、安全信息和其他资源，不保证没有瑕疵且不做任何明示或暗示的担保，包括但不限于对适销性、某特定用途方面的适用性或不侵犯任何第三方知识产权的暗示担保。

这些资源可供使用 TI 产品进行设计的熟练开发人员使用。您将自行承担以下全部责任：(1) 针对您的应用选择合适的 TI 产品，(2) 设计、验证并测试您的应用，(3) 确保您的应用满足相应标准以及任何其他功能安全、信息安全、监管或其他要求。

这些资源如有变更，恕不另行通知。TI 授权您仅可将这些资源用于研发本资源所述的 TI 产品的应用。严禁对这些资源进行其他复制或展示。您无权使用任何其他 TI 知识产权或任何第三方知识产权。您应全额赔偿因在这些资源的使用中对 TI 及其代表造成的任何索赔、损害、成本、损失和债务，TI 对此概不负责。

TI 提供的产品受 [TI 的销售条款](#) 或 [ti.com](#) 上其他适用条款/TI 产品随附的其他适用条款的约束。TI 提供这些资源并不会扩展或以其他方式更改 TI 针对 TI 产品发布的适用的担保或担保免责声明。

TI 反对并拒绝您可能提出的任何其他或不同的条款。

邮寄地址：Texas Instruments, Post Office Box 655303, Dallas, Texas 75265

Copyright © 2022，德州仪器 (TI) 公司