

## 具有双向控制通道的 DS90UB903Q/DS90UB904Q 10 - 43MHz 18 位彩色平面显示器-链路 (FPD-Link) III 串行化和解串器

 查询样品: [DS90UB903Q-Q1](#), [DS90UB904Q-Q1](#)

### 特性

- 10MHz 至 43MHz 输入并行端口时钟 (PCLK) 支持
- 210Mbps 至 903Mbps 数据吞吐量
- 单个差分对互连
- 具有 I<sup>2</sup>C 支持的双向控制接口通道
- 具有 DC 平衡编码的嵌入式时钟以支持 AC 耦合互连
- 能够驱动长达 10 米的屏蔽双绞线
- I<sup>2</sup>C 兼容串行接口
- 单个硬件器件寻址引脚
- 多达 4 个通用输入 (GPI) / 输出 (GPO)
- LOCK (锁定) 输出报告, 以及 AT-SPEED BIST (全速内置自检) 诊断特性以验证连接完整性
- 集成端接电阻器
- 1.8V 或 3.3V 兼容并行数据接口
- 1.8V 单电源
- 符合 ISO 10605 静电放电 (ESD) 以及 IEC 61000-4-2 ESD 标准
- 汽车应用级产品: 符合 AEC-Q100 2 级要求
- 温度范围: -40°C 至 +105°C
- 解串器上无需基准时钟
- 可编程接收均衡
- 电磁干扰 (EMI) / 电磁兼容性 (EMC) 迁移
  - DES 可编程展频 (SSCG) 输出
  - DES 接收器交错输出

### 应用范围

- 汽车显示系统
  - 中央信息显示屏
  - 导航显示屏
  - 后座娱乐系统
  - 触控显示屏

### 说明

DS90UB903Q/DS90UB904Q 芯片组为一个单个差分对上的数据传输提供了具有高速正向通道和一个双向控制通道的 FPD-Link III 接口。DS90UB903Q/904Q 在高速正向通道和双向控制通道数据路径上都包含差分指令。此串行化/解串器针对图形主机控制器与显示模块间的直接连接。这个芯片组非常适合于将视频数据驱动至要求 18 位色深 (RGB666 + HS, VS 和 DE) 的显示屏以及双向控制通道总线。主传输转换一个单个高速串行数据流上的 21 位数据, 连同从 I<sup>2</sup>C 端口上接受控制信息的独立低延迟双向控制通道传输。使用德州仪器 (TI) 的嵌入时钟技术可实现一个单个差分对上的透明全双工通信, 从而在两个方向上携带非对称双向控制通道信息。这个单个串行数据流通过消除并行数据与时钟路径间的偏差, 简化了印刷电路板 (PCB) 走线和电缆上的宽数据总线传输。这样, 通过限制数据路径的宽度, 大大节省了系统成本, 相应地减少了 PCB 层数、电缆宽度以及连接器尺寸和引脚数量。

此外, 解串器输入提供均衡控制来补偿较长距离介质所造成的损耗。内部 DC 均衡编码/解码被用来支持 AC 耦合互连。

此串行化器采用 40 引脚超薄型四方扁平无引线 (WQFN) 封装, 而解串器采用 48 引脚 WQFN 封装。



Please be aware that an important notice concerning availability, standard warranty, and use in critical applications of Texas Instruments semiconductor products and disclaimers thereto appears at the end of this data sheet.

All trademarks are the property of their respective owners.

Typical Application Diagram

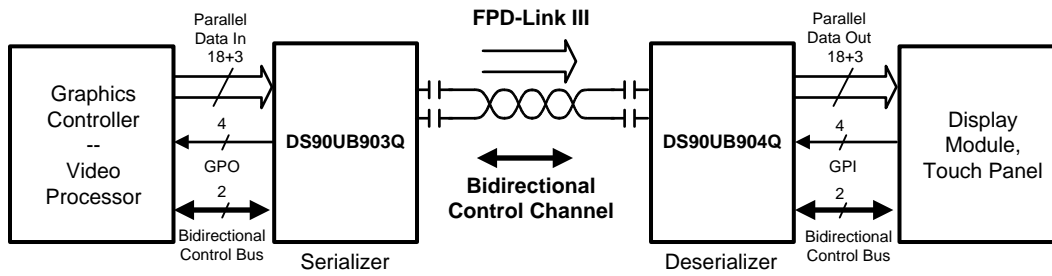

Figure 1. Typical Application Circuit

Block Diagrams

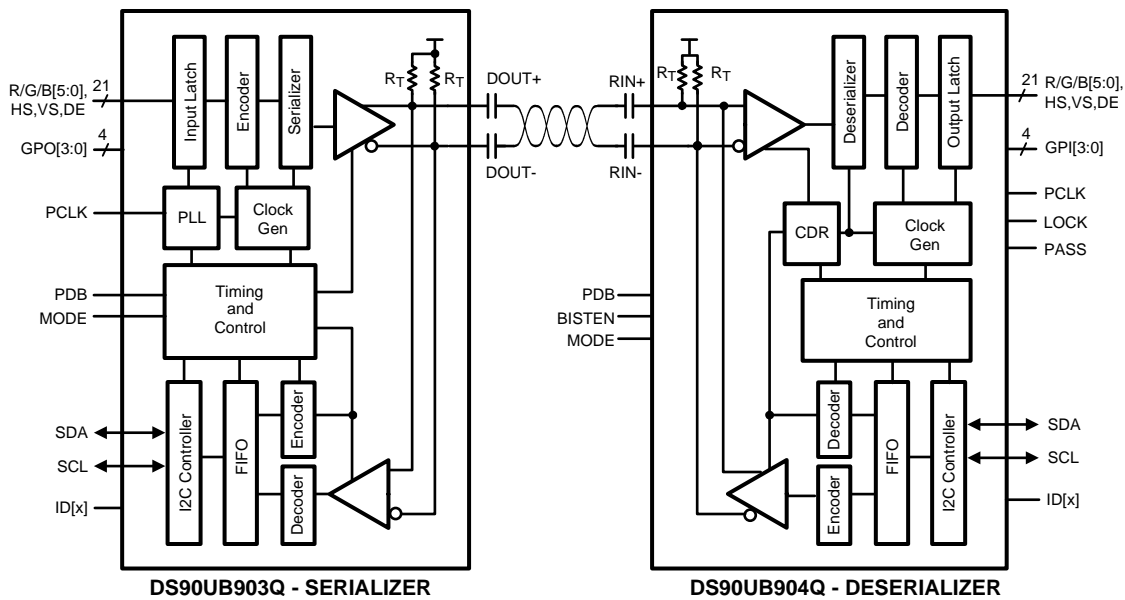

Figure 2. Block Diagram

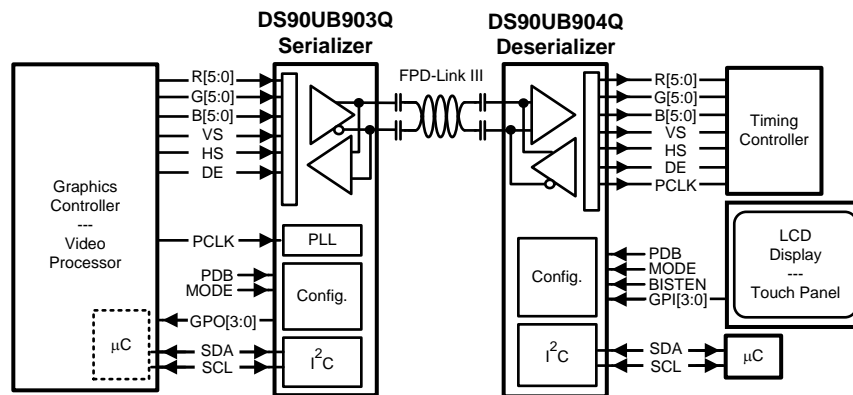
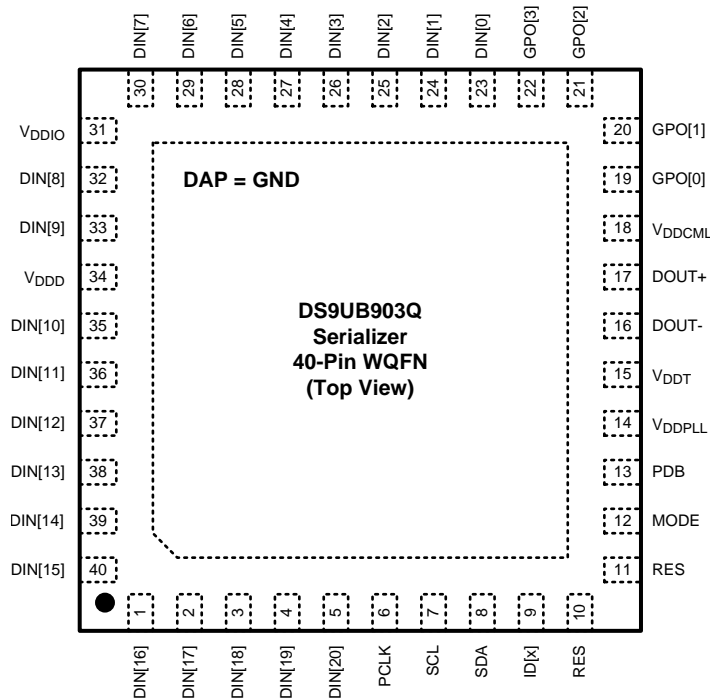

Figure 3. Application Block Diagram

DS90UB903Q Pin Diagram



Serializer - DS90UB903Q  
40 Pin WQFN (Top View)  
See Package Number RTA0040A

DS90UB903Q SERIALIZER PIN DESCRIPTIONS

Pin Name	Pin No.	I/O, Type	Description
<b>LVC MOS PARALLEL INTERFACE</b>			
DIN[20:0]	5, 4, 3, 2, 1, 40, 39, 38, 37, 36, 35, 33, 32, 30, 29, 28, 27, 26, 25, 24, 23	Inputs, LVC MOS w/ pull down	Parallel data inputs.
PCLK	6	Input, LVC MOS w/ pull down	Pixel Clock Input Pin. Strobe edge set by TRFB control register.
<b>GENERAL PURPOSE OUTPUT (GPO)</b>			
GPO[3:0]	22, 21, 20, 19	Output, LVC MOS	General-purpose output pins can be used to control and respond to various commands.
<b>BIDIRECTIONAL CONTROL BUS - I<sup>2</sup>C COMPATIBLE</b>			
SCL	7	Input/Output, Open Drain	Clock line for the bidirectional control bus communication SCL requires an external pull-up resistor to V <sub>DDIO</sub> .
SDA	8	Input/Output, Open Drain	Data line for the bidirectional control bus communication SDA requires an external pull-up resistor to V <sub>DDIO</sub> .
MODE	12	Input, LVC MOS w/ pull down	I <sup>2</sup> C Mode select MODE = L, Master mode (default); Device generates and drives the SCL clock line. Device is connected to slave peripheral on the bus. (Serializer initially starts up in Standby mode and is enabled through remote wakeup by Deserializer) MODE = H, Slave mode; Device accepts SCL clock input and attached to an I <sup>2</sup> C controller master on the bus. Slave mode does not generate the SCL clock, but uses the clock generated by the Master for the data transfers.
ID[x]	9	Input, analog	Device ID Address Select Resistor to Ground and 10 kΩ pull-up to 1.8V rail. See Table 3
<b>CONTROL AND CONFIGURATION</b>			

**DS90UB903Q SERIALIZER PIN DESCRIPTIONS (continued)**

Pin Name	Pin No.	I/O, Type	Description
PDB	13	Input, LVCMOS w/ pull down	Power down Mode Input Pin. PDB = H, Serializer is enabled and is ON. PDB = L, Serailizer is in Power Down mode. When the Serializer is in Power Down, the PLL is shutdown, and IDD is minimized. Programmed control register data are NOT retained and reset to default values
RES	10, 11	Input, LVCMOS w/ pull down	Reserved. This pin MUST be tied LOW.
<b>FPD-LINK III INTERFACE</b>			
DOUT+	17	Input/Output, CML	Non-inverting differential output, bidirectional control channel input. The interconnect must be AC Coupled with a 100 nF capacitor.
DOUT-	16	Input/Output, CML	Inverting differential output, bidirectional control channel input. The interconnect must be AC Coupled with a 100 nF capacitor.
<b>POWER AND GROUND</b>			
VDDPLL	14	Power, Analog	PLL Power, 1.8V ±5%
VDDT	15	Power, Analog	Tx Analog Power, 1.8V ±5%
VDDCML	18	Power, Analog	CML & Bidirectional Channel Driver Power, 1.8V ±5%
VDDD	34	Power, Digital	Digital Power, 1.8V ±5%
VDDIO	31	Power, Digital	Power for I/O stage. The single-ended inputs and SDA, SCL are powered from V <sub>DDIO</sub> . V <sub>DDIO</sub> can be connected to a 1.8V ±5% or 3.3V ±10%
VSS	DAP	Ground, DAP	DAP must be grounded. DAP is the large metal contact at the bottom side, located at the center of the WQFN package. Connected to the ground plane (GND) with at least 16 vias.

DS90UB904Q Pin Diagram

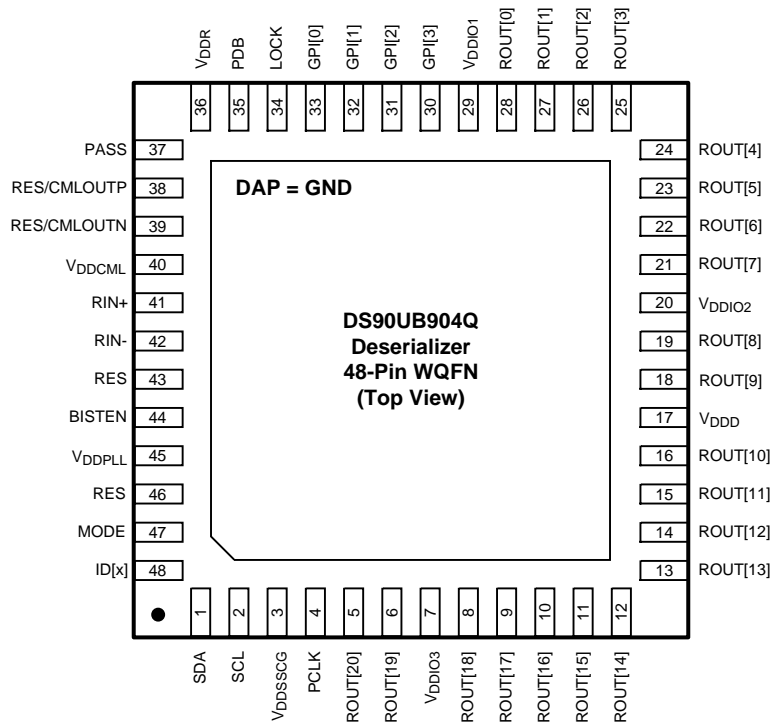

Deserializer - DS90UB904Q  
48 Pin WQFN (Top View)  
See Package Number RHS0048A

DS90UB904Q DESERIALIZER PIN DESCRIPTIONS

Pin Name	Pin No.	I/O, Type	Description
<b>LVCMOS PARALLEL INTERFACE</b>			
ROUT[20:0]	5, 6, 8, 9, 10, 11, 12, 13, 14, 15, 16, 18, 19, 21, 22, 23, 24, 25, 26, 27, 28	Outputs, LVCMOS	Parallel data outputs.
PCLK	4	Output, LVCMOS	Pixel Clock Output Pin. Strobe edge set by RRFb control register.
<b>GENERAL PURPOSE INPUT (GPI)</b>			
GPI[3:0]	30, 31, 32, 33	Input, LVCMOS	General-purpose input pins can be used to control and respond to various commands.
<b>BIDIRECTIONAL CONTROL BUS - I<sup>2</sup>C COMPATIBLE</b>			
SCL	2	Input/Output, Open Drain	Clock line for the bidirectional control bus communication SCL requires an external pull-up resistor to V <sub>DDIO</sub> .
SDA	1	Input/Output, Open Drain	Data line for bidirectional control bus communication SDA requires an external pull-up resistor to V <sub>DDIO</sub> .
MODE	47	Input, LVCMOS w/ pull up	I <sup>2</sup> C Mode select MODE = L, Master mode; Device generates and drives the SCL clock line, where required such as Read. Device is connected to slave peripheral on the bus. MODE = H, Slave mode (default); Device accepts SCL clock input and attached to an I <sup>2</sup> C controller master on the bus. Slave mode does not generate the SCL clock, but uses the clock generated by the Master for the data transfers.
ID[x]	48	Input, analog	Device ID Address Select Resistor to Ground and 10 kΩ pull-up to 1.8V rail. See Table 4.
<b>CONTROL AND CONFIGURATION</b>			

**DS90UB904Q DESERIALIZER PIN DESCRIPTIONS (continued)**

Pin Name	Pin No.	I/O, Type	Description
PDB	35	Input, LVCMOS w/ pull down	Power down Mode Input Pin. PDB = H, Deserializer is enabled and is ON. PDB = L, Deserializer is in Power Down mode. When the Deserializer is in Power Down. Programmed control register data are NOT retained and reset to default values.
LOCK	34	Output, LVCMOS	LOCK Status Output Pin. LOCK = H, PLL is Locked, outputs are active LOCK = L, PLL is unlocked, ROUT and PCLK output states are controlled by OSS_SEL control register. May be used as Link Status.
RES	38, 39, 43, 46	-	Reserved. Pins 38, 39: Route to test point or leave open if unused. See also <b>FPD-LINK III INTERFACE</b> pin description section. Pin 46: This pin MUST be tied LOW. Pin 43: Leave pin open.
<b>BIST MODE</b>			
BISTEN	44	Input, LVCMOS w/ pull down	BIST Enable Pin. BISTEN = H, BIST Mode is enabled. BISTEN = L, BIST Mode is disabled.
PASS	37	Output, LVCOMS	PASS Output Pin for BIST mode. PASS = H, ERROR FREE Transmission PASS = L, one or more errors were detected in the received payload. Leave Open if unused. Route to test point (pad) recommended.
<b>FPD-LINK III INTERFACE</b>			
RIN+	41	Input/Output, CML	Non-inverting differential input, bidirectional control channel output. The interconnect must be AC Coupled with a 100 nF capacitor.
RIN-	42	Input/Output, CML	Inverting differential input, bidirectional control channel output. The interconnect must be AC Coupled with a 100 nF capacitor.
CMLOUTP	38	Output, CML	Non-inverting CML Output Monitor point for equalized differential signal. Test port is enabled via control registers.
CMLOUTN	39	Output, CML	Inverting CML Output Monitor point for equalized differential signal. Test port is enabled via control registers.
<b>POWER AND GROUND</b>			
VDDSSCG	3	Power, Digital	SSCG Power, 1.8V ±5% Power supply must be connected regardless if SSCG function is in operation.
VDDIO1/2/3	29, 20, 7	Power, Digital	LVCMOS I/O Buffer Power, The single-ended outputs and control input are powered from V <sub>DDIO</sub> . V <sub>DDIO</sub> can be connected to a 1.8V ±5% or 3.3V ±10%
VDDD	17	Power, Digital	Digital Core Power, 1.8V ±5%
VDDR	36	Power, Analog	Rx Analog Power, 1.8V ±5%
VDDCML	40	Power, Analog	Bidirectional Channel Driver Power, 1.8V ±5%
VDDPLL	45	Power, Analog	PLL Power, 1.8V ±5%
VSS	DAP	Ground, DAP	DAP must be grounded. DAP is the large metal contact at the bottom side, located at the center of the WQFN package. Connected to the ground plane (GND) with at least 16 vias.



These devices have limited built-in ESD protection. The leads should be shorted together or the device placed in conductive foam during storage or handling to prevent electrostatic damage to the MOS gates.

**Absolute Maximum Ratings<sup>(1)(2)(3)</sup>**

Supply Voltage – $V_{DDn}$ (1.8V)		-0.3V to +2.5V
Supply Voltage – $V_{DDIO}$		-0.3V to +4.0V
LVC MOS Input Voltage I/O Voltage		-0.3V to + ( $V_{DDIO} + 0.3V$ )
CML Driver I/O Voltage ( $V_{DD}$ )		-0.3V to + ( $V_{DD} + 0.3V$ )
CML Receiver I/O Voltage ( $V_{DD}$ )		-0.3V to ( $V_{DD} + 0.3V$ )
Junction Temperature		+150°C
Storage Temperature		-65°C to +150°C
Maximum Package Power Dissipation Capacity		$1/\theta_{JA}$ °C/W above +25°
Package Derating		
40 Lead WQFN	$\theta_{JA}$ (based on 16 thermal vias)	30.7 °C/W
	$\theta_{JC}$ (based on 16 thermal vias)	6.8 °C/W
48 Lead WQFN	$\theta_{JA}$ (based on 16 thermal vias)	26.9 °C/W
	$\theta_{JC}$ (based on 16 thermal vias)	4.4 °C/W
ESD Rating (IEC 61000-4-2)		$R_D = 330\Omega$ , $C_S = 150pF$
Air Discharge (DOU+, DOU-, RIN+, RIN-)		$\geq \pm 25$ kV
Contact Discharge (DOU+, DOU-, RIN+, RIN-)		$\geq \pm 10$ kV
ESD Rating (ISO10605)		$R_D = 330\Omega$ , $C_S = 150/330pF$
ESD Rating (ISO10605)		$R_D = 2K\Omega$ , $C_S = 150/330pF$
Air Discharge (DOU+, DOU-, RIN+, RIN-)		$\geq \pm 15$ kV
Contact Discharge (DOU+, DOU-, RIN+, RIN-)		$\geq \pm 10$ kV
ESD Rating (HBM)		$\geq \pm 8$ kV
ESD Rating (CDM)		$\geq \pm 1$ kV
ESD Rating (MM)		$\geq \pm 250$ V

- (1) "Absolute Maximum Ratings" indicate limits beyond which damage to the device may occur, including inoperability and degradation of device reliability and/or performance. Functional operation of the device and/or non-degradation at the Absolute Maximum Ratings or other conditions beyond those indicated in the Recommended Operating Conditions is not implied. The Recommended Operating Conditions indicate conditions at which the device is functional; the device should not be operated beyond such conditions.
- (2) For soldering specifications: see product folder at [www.ti.com](http://www.ti.com)
- (3) If Military/Aerospace specified devices are required, please contact the Texas Instruments Sales Office/Distributors for availability and specifications.

**Recommended Operating Conditions<sup>(1)</sup>**

	Min	Nom	Max	Units
Supply Voltage ( $V_{DDn}$ )	1.71	1.8	1.89	V
LVC MOS Supply Voltage ( $V_{DDIO}$ ) OR LVC MOS Supply Voltage ( $V_{DDIO}$ )	1.71	1.8	1.89	V
	3.0	3.3	3.6	V
Supply Noise	$V_{DDn}$ (1.8V)		25	mVp-p
	$V_{DDIO}$ (1.8V)		25	mVp-p
	$V_{DDIO}$ (3.3V)		50	mVp-p
Operating Free Air Temperature ( $T_A$ )	-40	+25	+105	°C
PCLK Clock Frequency	10		43	MHz

- (1) Supply noise testing was done with minimum capacitors (as shown on [Figure 37](#) and [Figure 38](#)) on the PCB. A sinusoidal signal is AC coupled to the  $V_{DDn}$  (1.8V) supply with amplitude = 25 mVp-p measured at the device  $V_{DDn}$  pins. Bit error rate testing of input to the Ser and output of the Des with 10 meter cable shows no error when the noise frequency on the Ser is less than 1 MHz. The Des on the other hand shows no error when the noise frequency is less than 750 kHz.

**Electrical Characteristics** <sup>(1)(2)(3)</sup>

Over recommended operating supply and temperature ranges unless otherwise specified.

Symbol	Parameter	Conditions	Min	Typ	Max	Units	
<b>LVC MOS DC SPECIFICATIONS 3.3V I/O (SER INPUTS, DES OUTPUTS, GPI, GPO, CONTROL INPUTS AND OUTPUTS)</b>							
V <sub>IH</sub>	High Level Input Voltage	V <sub>IN</sub> = 3.0V to 3.6V	2.0		V <sub>IN</sub>	V	
V <sub>IL</sub>	Low Level Input Voltage	V <sub>IN</sub> = 3.0V to 3.6V	GND		0.8	V	
I <sub>IN</sub>	Input Current	V <sub>IN</sub> = 0V or 3.6V, V <sub>IN</sub> = 3.0V to 3.6V	-20	±1	+20	µA	
V <sub>OH</sub>	High Level Output Voltage	V <sub>DDIO</sub> = 3.0V to 3.6V, I <sub>OH</sub> = -4 mA	2.4		V <sub>DDIO</sub>	V	
V <sub>OL</sub>	Low Level Output Voltage	V <sub>DDIO</sub> = 3.0V to 3.6V, I <sub>OL</sub> = +4 mA	GND		0.4	V	
I <sub>OS</sub>	Output Short Circuit Current	V <sub>OUT</sub> = 0V	Serializer GPO Outputs		-24	mA	
			Deserializer LVCMOS Outputs		-39		
I <sub>OZ</sub>	TRI-STATE Output Current	PDB = 0V, V <sub>OUT</sub> = 0V or V <sub>DD</sub>	LVC MOS Outputs	-20	±1	+20	µA
<b>LVC MOS DC SPECIFICATIONS 1.8V I/O (SER INPUTS, DES OUTPUTS, GPI, GPO, CONTROL INPUTS AND OUTPUTS)</b>							
V <sub>IH</sub>	High Level Input Voltage	V <sub>IN</sub> = 1.71V to 1.89V	0.65 V <sub>IN</sub>		V <sub>IN</sub> +0.3	V	
V <sub>IL</sub>	Low Level Input Voltage	V <sub>IN</sub> = 1.71V to 1.89V	GND		0.35 V <sub>IN</sub>		
I <sub>IN</sub>	Input Current	V <sub>IN</sub> = 0V or 1.89V, V <sub>IN</sub> = 1.71V to 1.89V	-20	±1	+20	µA	
V <sub>OH</sub>	High Level Output Voltage	V <sub>DDIO</sub> = 1.71V to 1.89V, I <sub>OH</sub> = -4 mA	V <sub>DDIO</sub> - 0.45		V <sub>DDIO</sub>	V	
V <sub>OL</sub>	Low Level Output Voltage	V <sub>DDIO</sub> = 1.71V to 1.89V, I <sub>OL</sub> = +4 mA	Deserializer LVCMOS Outputs	GND	0.45	V	
I <sub>OS</sub>	Output Short Circuit Current	V <sub>OUT</sub> = 0V	Serializer GPO Outputs		-11	mA	
			Deserializer LVCMOS Outputs		-20		
I <sub>OZ</sub>	TRI-STATE Output Current	PDB = 0V, V <sub>OUT</sub> = 0V or V <sub>DD</sub>	LVC MOS Outputs	-20	±1	+20	µA
<b>CML DRIVER DC SPECIFICATIONS (DOUT+, DOUT-)</b>							
V <sub>OD</sub>	Output Differential Voltage	R <sub>T</sub> = 100Ω (Figure 8)	268	340	412	mV	
ΔV <sub>OD</sub>	Output Differential Voltage Unbalance	R <sub>L</sub> = 100Ω		1	50	mV	
V <sub>OS</sub>	Output Differential Offset Voltage	R <sub>L</sub> = 100Ω (Figure 8)	V <sub>DD</sub> (MIN) - V <sub>OD</sub> (MAX)	V <sub>DD</sub> - V <sub>OD</sub>	V <sub>DD</sub> (MAX) - V <sub>OD</sub> (MIN)	V	
ΔV <sub>OS</sub>	Offset Voltage Unbalance	R <sub>L</sub> = 100Ω		1	50	mV	
I <sub>OS</sub>	Output Short Circuit Current	DOUT+/- = 0V		-27		mA	
R <sub>T</sub>	Differential Internal Termination Resistance	Differential across DOUT+ and DOUT-	80	100	120	Ω	
<b>CML RECEIVER DC SPECIFICATIONS (RIN+, RIN-)</b>							

- (1) The Electrical Characteristics tables list ensured specifications under the listed Recommended Operating Conditions except as otherwise modified or specified by the Electrical Characteristics Conditions and/or Notes. Typical specifications are estimations only and are not ensured.
- (2) Current into device pins is defined as positive. Current out of a device pin is defined as negative. Voltages are referenced to ground except V<sub>OD</sub>, ΔV<sub>OD</sub>, V<sub>TH</sub> and V<sub>TL</sub> which are differential voltages.
- (3) Typical values represent most likely parametric norms at 1.8V or 3.3V, T<sub>A</sub> = +25°C, and at the Recommended Operation Conditions at the time of product characterization and are not ensured.



**Electrical Characteristics<sup>(1)(2)(3)</sup>  
(continued)**

Over recommended operating supply and temperature ranges unless otherwise specified.

Symbol	Parameter	Conditions	Min	Typ	Max	Units	
$V_{TH}$	Differential Threshold High Voltage	(Figure 10)			+90	mV	
$V_{TL}$	Differential Threshold Low Voltage		-90				
$V_{IN}$	Differential Input Voltage Range	RIN+ - RIN-	180			mV	
$I_{IN}$	Input Current	$V_{IN} = V_{DD}$ or 0V, $V_{DD} = 1.89V$	-20	$\pm 1$	+20	$\mu A$	
$R_T$	Differential Internal Termination Resistance	Differential across RIN+ and RIN-	80	100	120	$\Omega$	
<b>SER/DES SUPPLY CURRENT *DIGITAL, PLL, AND ANALOG VDD</b>							
$I_{DDT}$	Serializer (Tx) VDDn Supply Current (includes load current)	$R_T = 100\Omega$ WORST CASE pattern (Figure 5)	$V_{DDn} = 1.89V$ PCLK = 43 MHz Default Registers		62	90	mA
		$R_T = 100\Omega$ RANDOM PRBS-7 pattern			55		
$I_{DDIOT}$	Serializer (Tx) VDDIO Supply Current (includes load current)	$R_T = 100\Omega$ WORST CASE pattern (Figure 5)	$V_{DDIO} = 1.89V$ PCLK = 43 MHz Default Registers		2	5	mA
			$V_{DDIO} = 3.6V$ PCLK = 43 MHz Default Registers		7	15	
$I_{DDTZ}$	Serializer (Tx) Supply Current Power-down	PDB = 0V; All other LVCMOS Inputs = 0V	$V_{DDn} = 1.89V$		370	775	$\mu A$
$V_{DDIO} = 1.89V$				55	125		
$V_{DDIO} = 3.6V$				65	135		
$I_{DDR}$	Deserializer (Rx) VDDn Supply Current (includes load current)	$V_{DDn} = 1.89V$ , $C_L = 8$ pF WORST CASE Pattern (Figure 5)	PCLK = 43 MHz SSCG[3:0] = ON Default Registers		60	96	mA
		$V_{DDn} = 1.89V$ , $C_L = 8$ pF RANDOM PRBS-7 Pattern	PCLK = 43 MHz Default Registers		53		
$I_{DDIOR}$	Deserializer (Rx) VDDIO Supply Current (includes load current)	$V_{DDIO} = 1.89V$ , $C_L = 8$ pF WORST CASE Pattern (Figure 5)	PCLK = 43 MHz Default Registers		21	32	mA
			$V_{DDIO} = 3.6V$ , $C_L = 8$ pF WORST CASE Pattern	PCLK = 43 MHz Default Registers		49	
$I_{DDRZ}$	Deserializer (Rx) Supply Current Power-down	PDB = 0V; All other LVCMOS Inputs = 0V	$V_{DDn} = 1.89V$		42	400	$\mu A$
$V_{DDIO} = 1.89V$				8	40		
$V_{DDIO} = 3.6V$				350	800		

**Recommended Serializer Timing for PCLK<sup>(1)</sup>**

Over recommended operating supply and temperature ranges unless otherwise specified.

Symbol	Parameter	Conditions	Min	Typ	Max	Units
$t_{TCP}$	Transmit Clock Period	10 MHz – 43 MHz	23.3	T	100	ns
$t_{TCIH}$	Transmit Clock Input High Time		0.4T	0.5T	0.6T	ns
$t_{TCIL}$	Transmit Clock Input Low Time		0.4T	0.5T	0.6T	ns
$t_{CLKT}$	PCLK Input Transition Time (Figure 11)		0.5		3	ns
$f_{OSC}$	Internal oscillator clock source			25		MHz

(1) Recommended Input Timing Requirements are input specifications and not tested in production.

## Serializer Switching Characteristics

Over recommended operating supply and temperature ranges unless otherwise specified.

Symbol	Parameter	Conditions	Min	Typ	Max	Units
$t_{LHT}$	CML Low-to-High Transition Time	$R_L = 100\Omega$ (Figure 6)		150	330	ps
$t_{HLT}$	CML High-to-Low Transition Time	$R_L = 100\Omega$ (Figure 6)		150	330	ps
$t_{DIS}$	Data Input Setup to PCLK	Serializer Data Inputs (Figure 12)	2.0			ns
$t_{DIH}$	Data Input Hold from PCLK		2.0			ns
$t_{PLD}$	Serializer PLL Lock Time	$R_L = 100\Omega^{(1)(2)}$		1	2	ms
$t_{SD}$	Serializer Delay	$R_T = 100\Omega$ , PCLK = 10–43 MHz Register 0x03h b[0] (TRFB = 1) (Figure 14)	6.386T + 5	6.386T + 12	6.386T + 19.7	ns
$t_{JIND}$	Serializer Output Deterministic Jitter	Serializer output intrinsic deterministic jitter . Measured (cycle-cycle) with PRBS-7 test pattern PCLK = 43 MHz <sup>(3)(4)</sup>		0.13		UI
$t_{JINR}$	Serializer Output Random Jitter	Serializer output intrinsic random jitter (cycle-cycle). Alternating-1,0 pattern. PCLK = 43 MHz <sup>(3)(4)</sup>		0.04		UI
$t_{JINT}$	Peak-to-peak Serializer Output Jitter	Serializer output peak-to-peak jitter includes deterministic jitter, random jitter, and jitter transfer from serializer input. Measured (cycle-cycle) with PRBS-7 test pattern. PCLK = 43 MHz <sup>(3)(4)</sup>		0.396		UI
$\lambda_{STXBW}$	Serializer Jitter Transfer Function -3 dB Bandwidth	PCLK = 43 MHz, Default Registers (Figure 20) <sup>(3)</sup>		1.90		MHz
$\delta_{STX}$	Serializer Jitter Transfer Function (Peaking)	PCLK = 43 MHz, Default Registers (Figure 20) <sup>(3)</sup>		0.944		dB
$\delta_{STXf}$	Serializer Jitter Transfer Function (Peaking Frequency)	PCLK = 43 MHz, Default Registers (Figure 20) <sup>(3)</sup>		500		kHz

- (1)  $t_{PLD}$  and  $t_{DDLt}$  is the time required by the serializer and deserializer to obtain lock when exiting power-down state with an active PCLK
- (2) Specification is ensured by design.
- (3) Typical values represent most likely parametric norms at 1.8V or 3.3V,  $T_A = +25^\circ\text{C}$ , and at the Recommended Operation Conditions at the time of product characterization and are not ensured.
- (4) UI – Unit Interval is equivalent to one ideal serialized data bit width. The UI scales with PCLK frequency.

## Deserializer Switching Characteristics

Over recommended operating supply and temperature ranges unless otherwise specified.

Symbol	Parameter	Conditions	Pin/Freq.	Min	Typ	Max	Units
$t_{RCP}$	Receiver Output Clock Period	$t_{RCP} = t_{TCP}$	PCLK	23.3	T	100	ns
$t_{PDC}$	PCLK Duty Cycle	Default Registers SSCG[3:0] = OFF	PCLK	45	50	55	%
$t_{CLH}$	LVC MOS Low-to-High Transition Time	$V_{DDIO}$ : 1.71V to 1.89V or 3.0 to 3.6V, $C_L = 8$ pF (lumped load) Default Registers (Figure 16) <sup>(1)</sup>	PCLK	1.3	2.0	2.8	ns
$t_{CHL}$	LVC MOS High-to-Low Transition Time			1.3	2.0	2.8	
$t_{CLH}$	LVC MOS Low-to-High Transition Time	$V_{DDIO}$ : 1.71V to 1.89V or 3.0 to 3.6V, $C_L = 8$ pF (lumped load) Default Registers (Figure 16) <sup>(1)</sup>	Deserializer ROUTn Data Outputs	1.6	2.4	3.3	ns
$t_{CHL}$	LVC MOS High-to-Low Transition Time			1.6	2.4	3.3	
$t_{ROS}$	ROUT Setup Data to PCLK	$V_{DDIO}$ : 1.71V to 1.89V or 3.0V to 3.6V, $C_L = 8$ pF (lumped load) Default Registers	Deserializer ROUTn Data Outputs	0.38T	0.5T		ns
$t_{ROH}$	ROUT Hold Data to PCLK			0.38T	0.5T		

- (1) Specification is ensured by characterization and is not tested in production.

## Deserializer Switching Characteristics (continued)

Over recommended operating supply and temperature ranges unless otherwise specified.

Symbol	Parameter	Conditions	Pin/Freq.	Min	Typ	Max	Units
$t_{DD}$	Deserializer Delay	Default Registers Register 0x03h b[0] (RRFB = 1) (Figure 17)	10 MHz–43 MHz	4.571T + 8	4.571T + 12	4.571T + 16	ns
$t_{DDLT}$	Deserializer Data Lock Time	(Figure 15) <sup>(2)</sup>	10 MHz–43 MHz			10	ms
$t_{RJIT}$	Receiver Input Jitter Tolerance	(Figure 19, Figure 21) <sup>(3)(4)</sup>	43 MHz		0.53		UI
$t_{RCJ}$	Receiver Clock Jitter	PCLK SSCG[3:0] = OFF <sup>(1)(5)</sup>	10 MHz		300	550	ps
			43 MHz		120	250	
$t_{DPJ}$	Deserializer Period Jitter	PCLK SSCG[3:0] = OFF <sup>(1)(6)</sup>	10 MHz		425	600	ps
			43 MHz		320	480	
$t_{DCCJ}$	Deserializer Cycle-to-Cycle Clock Jitter	PCLK SSCG[3:0] = OFF <sup>(1)(7)</sup>	10 MHz		320	500	ps
			43 MHz		300	500	
$f_{dev}$	Spread Spectrum Clocking Deviation Frequency	LVCMOS Output Bus SSC[3:0] = ON (Figure 22)	20 MHz–43 MHz		±0.5% to ±2.0%		%
$f_{mod}$	Spread Spectrum Clocking Modulation Frequency		20 MHz–43 MHz		9 kHz to 66 kHz		kHz

- (2)  $t_{PLD}$  and  $t_{DDLT}$  is the time required by the serializer and deserializer to obtain lock when exiting power-down state with an active PCLK
- (3) UI – Unit Interval is equivalent to one ideal serialized data bit width. The UI scales with PCLK frequency.
- (4)  $t_{RJIT}$  max (0.61UI) is limited by instrumentation and actual  $t_{RJIT}$  of in-band jitter at low frequency (<2 MHz) is greater 1 UI.
- (5)  $t_{DCJ}$  is the maximum amount of jitter measured over 30,000 samples based on Time Interval Error (TIE).
- (6)  $t_{DPJ}$  is the maximum amount the period is allowed to deviate measured over 30,000 samples.
- (7)  $t_{DCCJ}$  is the maximum amount of jitter between adjacent clock cycles measured over 30,000 samples.

### Bidirectional Control Bus AC Timing Specifications (SCL, SDA) - I<sup>2</sup>C Compliant

Over recommended supply and temperature ranges unless otherwise specified. See [Figure 4](#).

Symbol	Parameter	Conditions	Min	Typ	Max	Units
<b>RECOMMENDED INPUT TIMING REQUIREMENTS<sup>(1)</sup></b>						
f <sub>SCL</sub>	SCL Clock Frequency	f <sub>SCL</sub> = 100 kHz	>0		100	kHz
t <sub>LOW</sub>	SCL Low Period		4.7			μs
t <sub>HIGH</sub>	SCL High Period		4.0			μs
t <sub>HD:STA</sub>	Hold time for a start or a repeated start condition		4.0			μs
t <sub>SU:STA</sub>	Set Up time for a start or a repeated start condition		4.7			μs
t <sub>HD:DAT</sub>	Data Hold Time		0		3.45	μs
t <sub>SU:DAT</sub>	Data Set Up Time		250			ns
t <sub>SU:STO</sub>	Set Up Time for STOP Condition		4.0			μs
t <sub>r</sub>	SCL & SDA Rise Time				1000	ns
t <sub>f</sub>	SCL & SDA Fall Time				300	ns
C <sub>b</sub>	Capacitive load for bus				400	pF
<b>SWITCHING CHARACTERISTICS<sup>(2)</sup></b>						
f <sub>SCL</sub>	SCL Clock Frequency	Serializer MODE = 0 – R/W Register 0x05 = 0x40'h		100		kHz
		Deserializer MODE = 0 – READ Register 0x06 b[6:4] = 0x00'h		100		
t <sub>LOW</sub>	SCL Low Period	Serializer MODE = 0 – R/W Register 0x05 = 0x40'h	4.7			μs
		Deserializer MODE = 0 – READ Register 0x06 b[6:4] = 0x00'h				
t <sub>HIGH</sub>	SCL High Period	Serializer MODE = 0 – R/W Register 0x05 = 0x40'h	4.0			μs
		Deserializer MODE = 0 – READ Register 0x06 b[6:4] = 0x00'h				
t <sub>HD:STA</sub>	Hold time for a start or a repeated start condition	Serializer MODE = 0 Register 0x05 = 0x40'h	4.0			μs
t <sub>SU:STA</sub>	Set Up time for a start or a repeated start condition	Serializer MODE = 0 Register 0x05 = 0x40'h	4.7			μs
t <sub>HD:DAT</sub>	Data Hold Time		0		3.45	μs
t <sub>SU:DAT</sub>	Data Set Up Time		250			ns
t <sub>SU:STO</sub>	Set Up Time for STOP Condition	Serializer MODE = 0	4.0			μs
t <sub>f</sub>	SCL & SDA Fall Time				300	ns
t <sub>BUF</sub>	Bus free time between a stop and start condition	Serializer MODE = 0	4.7			μs
t <sub>TIMEOUT</sub>	NACK Time out	Serializer MODE = 1		1		ms
		Deserializer MODE = 1 Register 0x06 b[2:0]=111'b		25		

(1) Recommended Input Timing Requirements are input specifications and not tested in production.

(2) Specification is ensured by design.

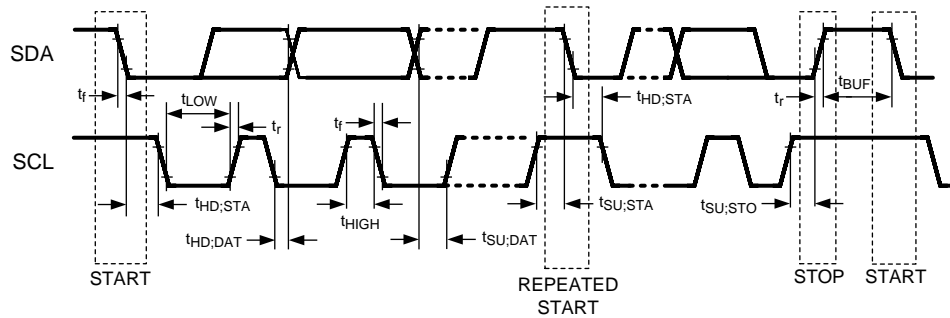

Figure 4. Bidirectional Control Bus Timing

**Bidirectional Control Bus DC Characteristics (SCL, SDA) - I<sup>2</sup>C Compliant**

Over recommended supply and temperature ranges unless otherwise specified.

Symbol	Parameter	Conditions	Min	Typ	Max	Units
V <sub>IH</sub>	Input High Level	SDA and SCL	0.7 x V <sub>DDIO</sub>		V <sub>DDIO</sub>	V
V <sub>IL</sub>	Input Low Level Voltage	SDA and SCL	GND		0.3 x V <sub>DDIO</sub>	V
V <sub>HY</sub>	Input Hysteresis	SDA and SCL		>50		mV
I <sub>OZ</sub>	TRI-STATE Output Current	PDB = 0V, V <sub>OUT</sub> = 0V or V <sub>DD</sub>	-20	±1	+20	µA
I <sub>IN</sub>	Input Current	SDA or SCL, V <sub>in</sub> = V <sub>DDIO</sub> or GND	-20	±1	+20	µA
C <sub>IN</sub>	Input Pin Capacitance			<5		pF
V <sub>OL</sub>	Low Level Output Voltage	SCL and SDA, V <sub>DDIO</sub> = 3.0V I <sub>OL</sub> = 1.5 mA			0.36	V
		SCL and SDA, V <sub>DDIO</sub> = 1.71V I <sub>OL</sub> = 1 mA			0.36	V

**AC Timing Diagrams and Test Circuits**

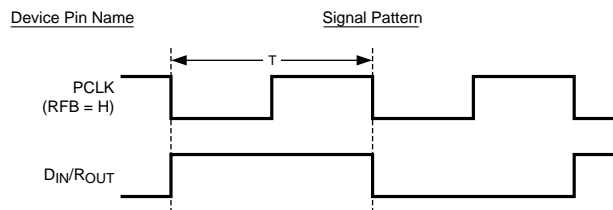

Figure 5. "Worst Case" Test Pattern

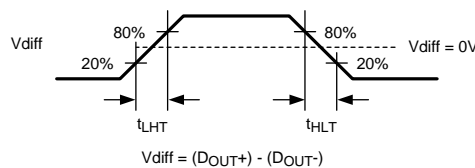

Figure 6. Serializer CML Output Load and Transition Times

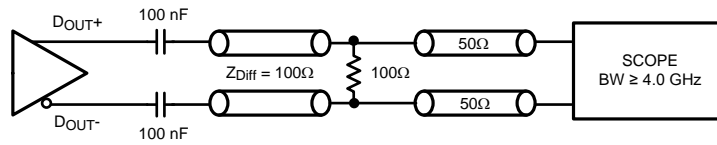

Figure 7. Serializer CML Output Load and Transition Times

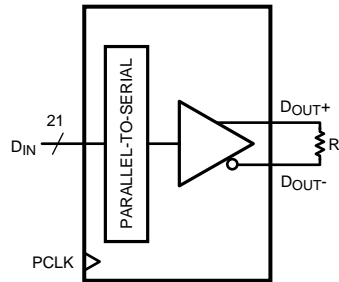

Figure 8. Serializer VOD DC Diagram

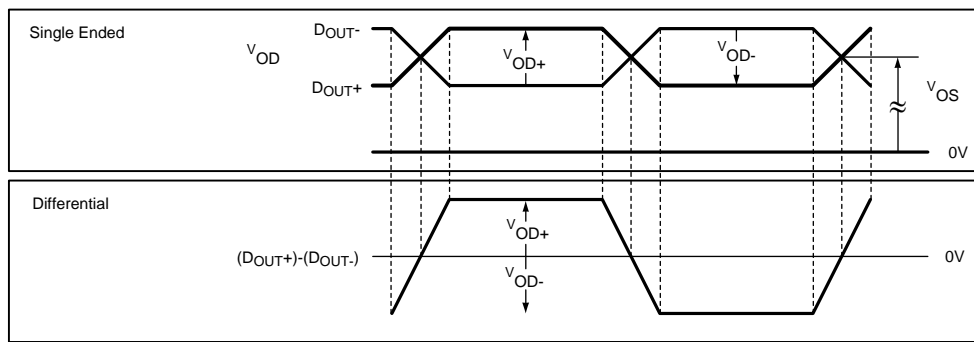

Figure 9. Serializer VOD DC Diagram

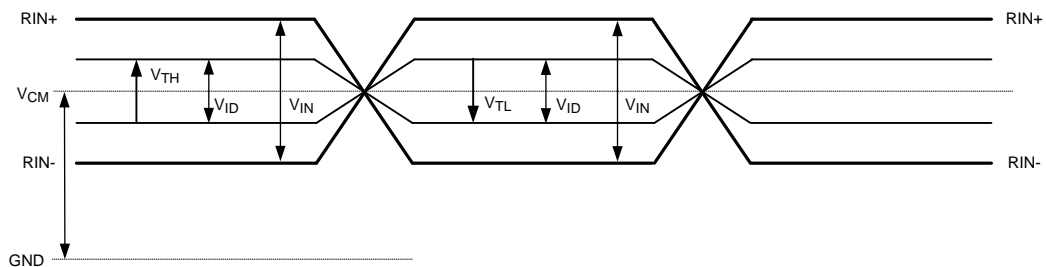

Figure 10. Differential VTH/VTL Definition Diagram

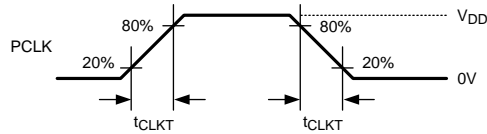

Figure 11. Serializer Input Clock Transition Times

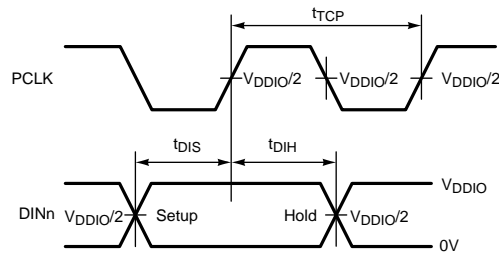

Figure 12. Serializer Setup/Hold Times

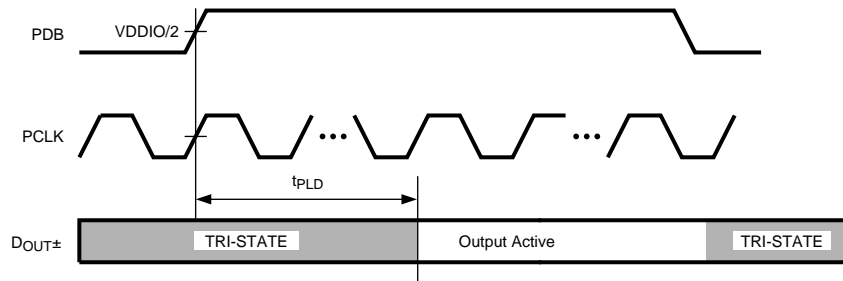

Figure 13. Serializer Data Lock Time

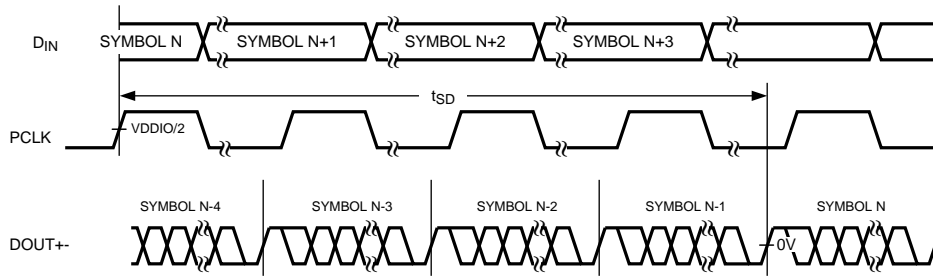

Figure 14. Serializer Delay

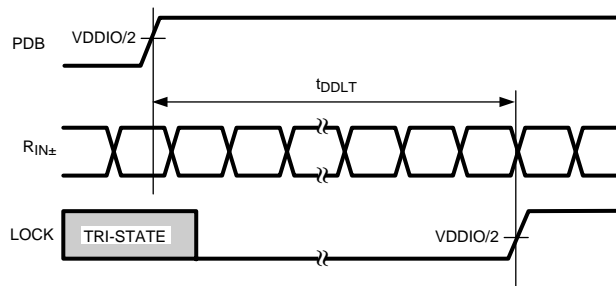

Figure 15. Deserializer Data Lock Time

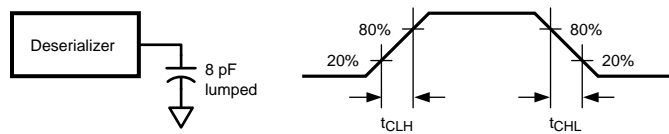

Figure 16. Deserializer LVCMOS Output Load and Transition Times

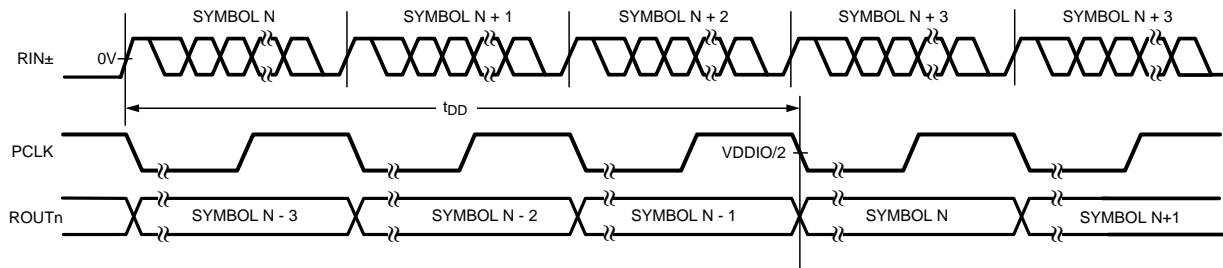

Figure 17. Deserializer Delay

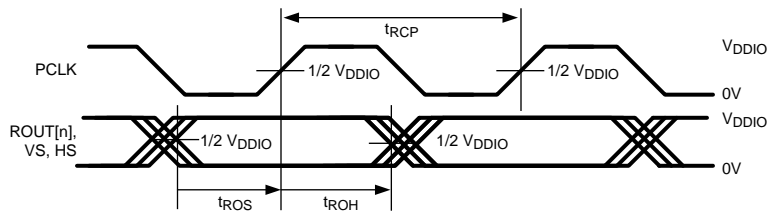

Figure 18. Deserializer Output Setup/Hold Times

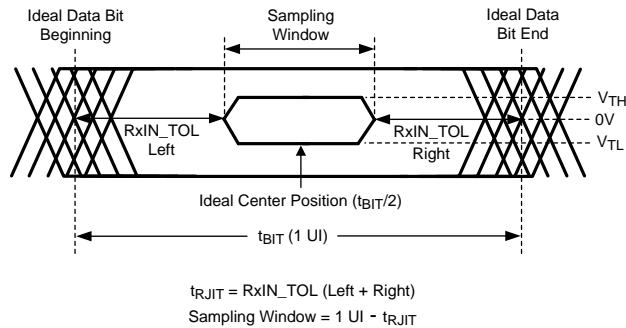

Figure 19. Receiver Input Jitter Tolerance

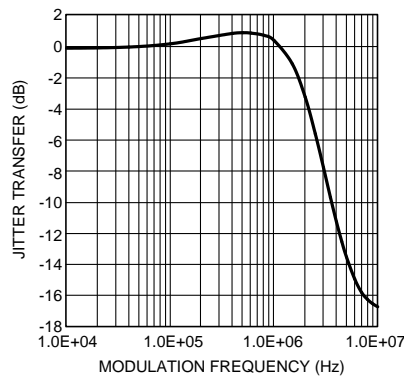

Figure 20. Typical Serializer Jitter Transfer Function Curve at 43 MHz



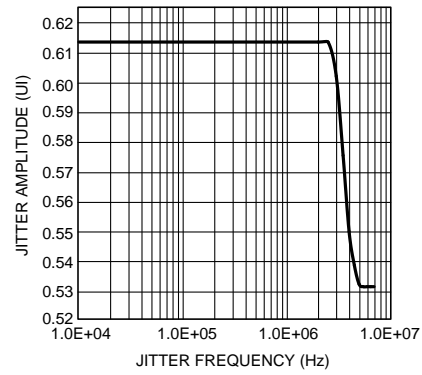

Figure 21. Typical Deserializer Input Jitter Tolerance Curve at 43 MHz

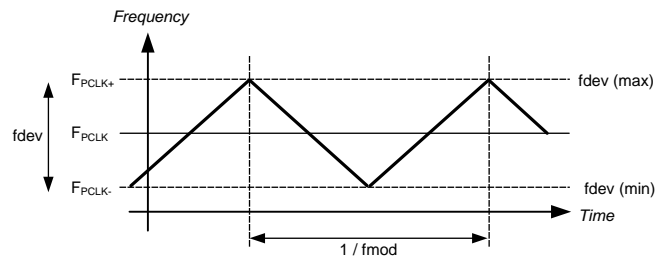

Figure 22. Spread Spectrum Clock Output Profile

**Table 1. DS90UB903Q Control Registers**

Addr (Hex)	Name	Bits	Field	R/W	Default	Description
0	I <sup>2</sup> C Device ID	7:1	DEVICE ID	RW	0xB0'h	7-bit address of Serializer; 0x58'h (1011_000X'b) default
		0	SER ID SEL			0: Device ID is from ID[x] 1: Register I <sup>2</sup> C Device ID overrides ID[x]
1	Reset	7:3	RESERVED		0x00'h	Reserved
		2	STANDBY	RW	0	Standby mode control. Retains control register data. Supported only when MODE = 0 0: Enabled. Low-current Standby mode with wake-up capability. Suspends all clocks and functions. 1: Disabled. Standby and wake-up disabled
		1	DIGITAL RESET0	RW	0 self clear	1: Resets the device to default register values. Does not affect device I <sup>2</sup> C Bus or Device ID
		0	DIGITAL RESET1	RW	0 self clear	1: Digital Reset, retains all register values
2	Reserved	7:0	RESERVED		0x20'h	Reserved
3	Reserved	7:6	RESERVED		11'b	Reserved
	VDDIO Control	5	VDDIO CONTROL	RW	1	Auto V <sub>DDIO</sub> detect Allows manual setting of VDDIO by register. 0: Disable 1: Enable (auto detect mode)
	VDDIO Mode	4	VDDIO MODE	RW	1	VDDIO voltage set Only used when VDDIOCONTROL = 0 0: 1.8V 1: 3.3V
	I <sup>2</sup> C Pass-Through	3	I <sup>2</sup> C PASS-THROUGH	RW	1	I <sup>2</sup> C Pass-Through 0: Disabled 1: Enabled
	RESERVED	2	RESERVED		0	Reserved
	PCLK_AUTO	1	PCLK_AUTO	RW	1	Switch over to internal 25 MHz Oscillator clock in the absence of PCLK 0: Disable 1: Enable
	TRFB	0	TRFB	RW	1	Pixel Clock Edge Select: 0: Parallel Interface Data is strobed on the Falling Clock Edge. 1: Parallel Interface Data is strobed on the Rising Clock Edge.
4	RESERVED	7:0	RESERVED		0x80'h	Reserved
5	I <sup>2</sup> C Bus Rate	7:0	I <sup>2</sup> C BUS RATE	RW	0x40'h	I <sup>2</sup> C SCL frequency is determined by the following: $f_{SCL} = 6.25 \text{ MHz} / \text{Register value (in decimal)}$ 0x40'h = ~100 kHz SCL (default) Note: Register values <0x32'h are NOT supported.
6	DES ID	7:1	DES DEV ID	RW	0xC0'h	Deserializer Device ID = 0x60'h (1100_000X'b) default
		0	RESERVED			Reserved
7	Slave ID	7:1	SLAVE DEV ID	RW	0x00'h	Slave Device ID. Sets remote slave I <sup>2</sup> C address.
		0	RESERVED			Reserved
8	Reserved	7:0	RESERVED		0x00'h	Reserved
9	Reserved	7:0	RESERVED		0x01'h	Reserved
A	Reserved	7:0	RESERVED		0x00'h	Reserved
B	Reserved	7:0	RESERVED		0x00'h	Reserved

**Table 1. DS90UB903Q Control Registers (continued)**

Addr (Hex)	Name	Bits	Field	R/W	Default	Description
C	Reserved	7:3	RESERVED		0x00'h	Reserved
	PCLK Detect	2	PCLK DETECT	R	0	1: Valid PCLK detected 0: Valid PCLK not detected
	Reserved	3	RESERVED		0	Reserved
	Cable Link Detect Status	0	LINK DETECT	R	0	0: Cable link not detected 1: Cable link detected
D	Reserved	7:0	RESERVED		0x11'h	Reserved
E	Reserved	7:0	RESERVED		0x01'h	Reserved
F	Reserved	7:0	RESERVED		0x03'h	Reserved
10	Reserved	7:0	RESERVED		0x03'h	Reserved
11	Reserved	7:0	RESERVED		0x03'h	Reserved
12	Reserved	7:0	RESERVED		0x03'h	Reserved
13	General Purpose Control Reg	7:0	GPCR[7] GPCR[6] GPCR[5] GPCR[4] GPCR[3] GPCR[2] GPCR[1] GPCR[0]	RW	0x00'h	0: LOW 1: HIGH

**Table 2. DS90UB904Q Control Registers**

Addr (Hex)	Name	Bits	Field	R/W	Default	Description
0	I <sup>2</sup> C Device ID	7:1	DEVICE ID	RW	0xC0'h	7-bit address of Deserializer; 0x60h (1100_000X) default
		0	DES ID SEL			0: Device ID is from ID[x] 1: Register I <sup>2</sup> C Device ID overrides ID[x]
1	Reset	7:3	RESERVED		0x00'h	Reserved
		2	REM_WAKEUP	RW	0	Remote Wake-up Select 1: Enable Generate remote wakeup signal automatically wake-up the Serializer in Standby mode 0: Disable Puts the Serializer in Standby mode
		1	DIGITALRESET0	RW	0 self clear	1: Resets the device to default register values. Does not affect device I <sup>2</sup> C Bus or Device ID
		0	DIGITALRESET1	RW	0 self clear	1: Digital Reset, retains all register values

**Table 2. DS90UB904Q Control Registers (continued)**

Addr (Hex)	Name	Bits	Field	R/W	Default	Description
2	RESERVED	7:6	RESERVED		00'b	Reserved
	Auto Clock	5	AUTO_CLOCK	RW	0	1: Output PCLK or Internal 25 MHz Oscillator clock 0: Only PCLK when valid PCLK present
	OSS Select	4	OSS_SEL	RW	0	Output Sleep State Select 0: Outputs = TRI-STATE, when LOCK = L 1: Outputs = LOW, when LOCK = L
	SSCG	3:0	SSCG		0000'b	SSCG Select 0000: Normal Operation, SSCG OFF (default) 0001: fmod (kHz) PCLK/2168, fdev ±0.50% 0010: fmod (kHz) PCLK/2168, fdev ±1.00% 0011: fmod (kHz) PCLK/2168, fdev ±1.50% 0100: fmod (kHz) PCLK/2168, fdev ±2.00% 0101: fmod (kHz) PCLK/1300, fdev ±0.50% 0110: fmod (kHz) PCLK/1300, fdev ±1.00% 0111: fmod (kHz) PCLK/1300, fdev ±1.50% 1000: fmod (kHz) PCLK/1300, fdev ±2.00% 1001: fmod (kHz) PCLK/868, fdev ±0.50% 1010: fmod (kHz) PCLK/868, fdev ±1.00% 1011: fmod (kHz) PCLK/868, fdev ±1.50% 1100: fmod (kHz) PCLK/868, fdev ±2.00% 1101: fmod (kHz) PCLK/650, fdev ±0.50% 1110: fmod (kHz) PCLK/650, fdev ±1.00% 1111: fmod (kHz) PCLK/650, fdev ±1.50%
3	RESERVED	7:6	RESERVED		11'b	Reserved
	VDDIO Control	5	VDDIO CONTROL	RW	1	Auto voltage control 0: Disable 1: Enable (auto detect mode)
	VDDIO Mode	4	VDDIO MODE	RW	0	VDDIO voltage set Only used when VDDIOCONTROL = 0 0: 1.8V 1: 3.3V
	I <sup>2</sup> C Pass-Through	3	I <sup>2</sup> C PASS-THROUGH	RW	1	I <sup>2</sup> C Pass-Through Mode 0: Disabled 1: Enabled
	Auto ACK	2	AUTO ACK	RW	0	0: Disable 1: Enable
	RESERVED	1	RESERVED		0	Reserved
	RRFB	0	RRFB	RW	1	Pixel Clock Edge Select 0: Parallel Interface Data is strobed on the Falling Clock Edge 1: Parallel Interface Data is strobed on the Rising Clock Edge.
4	EQ Control	7:0	EQ	RW	0x00'h	EQ Gain 00'h = ~0.0 dB 01'h = ~4.5 dB 03'h = ~6.5 dB 07'h = ~7.5 dB 0F'h = ~8.0 dB 1F'h = ~11.0 dB 3F'h = ~12.5 dB FF'h = ~14.0 dB
5	RESERVED	7:0	RESERVED		0x00'h	Reserved

**Table 2. DS90UB904Q Control Registers (continued)**

Addr (Hex)	Name	Bits	Field	R/W	Default	Description
6	RESERVED	7	RESERVED		0	Reserved
	SCL Prescale	6:4	SCL_PRESCALE	RW	000'b	Prescales the SCL clock line when reading data byte from a slave device (MODE = 0) 000 : ~100 kHz SCL (default) 001 : ~125 kHz SCL 101 : ~11 kHz SCL 110 : ~33 kHz SCL 111 : ~50 kHz SCL Other values are NOT supported.
	Remote NACK	3	REM_NACK_TIMER	RW	1	Remote NACK Timer Enable In slave mode (MODE = 1) if bit is set the I <sup>2</sup> C core will automatically timeout when no acknowledge condition was detected. 1: Enable 0: Disable
	Remote NACK	2:0	NACK_TIMEOUT	RW	111'b	Remote NACK Timeout. 000: 2.0 ms 001: 5.2 ms 010: 8.6 ms 011: 11.8 ms 100: 14.4 ms 101: 18.4 ms 110: 21.6 ms 111: 25.0 ms
7	SER ID	7:1	SER DEV ID	RW	0xB0'h	Serializer Device ID = 0x58'h (1011_000X'b) default
		0	RESERVED			Reserved
8	ID[0] Index	7:1	ID[0] INDEX	RW	0x00'h	Target slave Device ID slv_id0 [7:1]
		0	RESERVED			Reserved
9	ID[1] Index	7:1	ID[1] INDEX	RW	0x00'h	Target slave Device ID slv_id1 [7:1]
		0	RESERVED			Reserved
A	ID[2] Index	7:1	ID[2] INDEX	RW	0x00'h	Target slave Device ID slv_id2 [7:1]
		0	RESERVED			Reserved
B	ID[3] Index	7:1	ID[3] INDEX	RW	0x00'h	Target slave Device ID slv_id3 [7:1]
		0	RESERVED			Reserved
C	ID[4] Index	7:1	ID[4] INDEX	RW	0x00'h	Target slave Device ID slv_id4 [7:1]
		0	RESERVED			Reserved
D	ID[5] Index	7:1	ID[5] INDEX	RW	0x00'h	Target slave Device ID slv_id5 [7:1]
		0	RESERVED			Reserved
E	ID[6] Index	7:1	ID[6] INDEX	RW	0x00'h	Target slave Device ID slv_id6 [7:1]
		0	RESERVED			Reserved
F	ID[7] Index	7:1	ID[7] INDEX	RW	0x00'h	Target slave Device ID slv_id7 [7:1]
		0	RESERVED			Reserved
10	ID[0] Match	7:1	ID[0] MATCH	RW	0x00'h	Alias to match Device ID slv_id0 [7:1]
		0	RESERVED			Reserved
11	ID[1] Match	7:1	ID[1] MATCH	RW	0x00'h	Alias to match Device ID slv_id1 [7:1]
		0	RESERVED			Reserved
12	ID[2] Match	7:1	ID[2] MATCH	RW	0x00'h	Alias to match Device ID slv_id2 [7:1]
		0	RESERVED			Reserved
13	ID[3] Match	7:1	ID[3] MATCH	RW	0x00'h	Alias to match Device ID slv_id3 [7:1]
		0	RESERVED			Reserved
14	ID[4] Match	7:1	ID[4] MATCH	RW	0x00'h	Alias to match Device ID slv_id4 [7:1]
		0	RESERVED			Reserved

**Table 2. DS90UB904Q Control Registers (continued)**

Addr (Hex)	Name	Bits	Field	R/W	Default	Description
15	ID[5] Match	7:1	ID[5] MATCH	RW	0x00'h	Alias to match Device ID slv_id5 [7:1]
		0	RESERVED			Reserved
16	ID[6] Match	7:1	ID[6] MATCH	RW	0x00'h	Alias to match Device ID slv_id6 [7:1]
		0	RESERVED			Reserved
17	ID[7] Match	7:1	ID[7] MATCH	RW	0x00'h	Alias to match Device ID slv_id [7:1]
		0	RESERVED			Reserved
18	RESERVED	7:0	RESERVED		0x00'h	Reserved
19	RESERVED	7:0	RESERVED		0x01'h	Reserved
1A	RESERVED	7:0	RESERVED		0x00'h	Reserved
1B	RESERVED	7:0	RESERVED		0x00'h	Reserved
1C	RESERVED	7:3	RESERVED		0x00'h	Reserved
	RESERVED	2	RESERVED		0	Reserved
	Signal Detect Status	1		R	0	0: Active signal not detected 1: Active signal detected
	LOCK Pin Status	0		R	0	0: CDR/PLL Unlocked 1: CDR/PLL Locked
1D	Reserved	7:0	RESERVED		0x17'h	Reserved
1E	Reserved	7:0	RESERVED		0x07'h	Reserved
1F	Reserved	7:0	RESERVED		0x01'h	Reserved
20	Reserved	7:0	RESERVED		0x01'h	Reserved
21	Reserved	7:0	RESERVED		0x01'h	Reserved
22	Reserved	7:0	RESERVED		0x01'h	Reserved
23	General Purpose Control Reg	7:0	GPCR[7] GPCR[6] GPCR[5] GPCR[4] GPCR[3] GPCR[2] GPCR[1] GPCR[0]	RW	0x00'h	0: LOW 1: HIGH
24	BIST	0	BIST_EN	RW	0	BIST Enable 0: Normal operation 1: Bist Enable
25	BIST_ERR	7:0	BIST_ERR	R	0x00'h	Bist Error Counter
26	Remote Wake Enable	7:6	REM_WAKEUP_EN	RW	00'b	11: Enable remote wake up mode 00: Normal operation mode Other values are NOT supported
		5:0	RESERVED	RW	0	Reserved
27	BCC	7:6	BCC	RW	00'b	11: Normal operation mode
		5:0	RESERVED		0	Reserved
3F	CMLOUT Config	7:5	RESERVED		0	Reserved
		4	CMLOUT P/N Enable	RW	1	1: Disabled (Default) 0: Enabled
		3:0	RESERVED		0	Reserved

## FUNCTIONAL DESCRIPTION

The DS90UB903Q/904Q FPD-Link III chipset is intended for video display applications. The Serializer/Deserializer chipset operates from a 10 MHz to 43 MHz pixel clock frequency. The DS90UB903Q transforms a 21-bit wide parallel LVCMOS data bus along with a bidirectional control bus into a single high-speed differential pair. The high-speed serial bit stream contains an embedded clock and DC-balance information which enhances signal quality to support AC coupling. The DS90UB904Q receives the single serial data stream and converts it back into a 21-bit wide parallel data bus together with the bidirectional control channel data bus.

The control channel function of the DS90UB903Q/904Q provides bidirectional communication between the host processor and display. The integrated control channel transfers data simultaneously over the same differential pair used for video data interface. This interface offers advantages over other chipsets by eliminating the need for additional wires for programming and control. The control supports I<sup>2</sup>C port. The bidirectional control channel offers asymmetrical communication and is not dependent on video blanking intervals.

## DISPLAY APPLICATION

The DS90UB903Q/904Q chipset is intended for interface between a host (graphics processor) and a Display. It supports a 21 bit parallel video bus for 18-bit color depth (RGB666) display format. In a RGB666 configuration, 18 color bits (R[5:0], G[5:0], B[5:0]), Pixel Clock (PCLK) and three control bits (VS, HS and DE) are supported across the serial link.

The DS90UB903Q Serializer accepts a 21-bit parallel data bus along with a bidirectional control bus. The parallel data and bidirectional control channel information is converted into a single differential link. The integrated bidirectional control channel bus supports I2C compatible operation for controlling auxiliary data transport to and from host processor and display module. The DS90UB904Q Deserializer extracts the clock/control information from the incoming data stream and reconstructs the 21-bit data with control channel data.

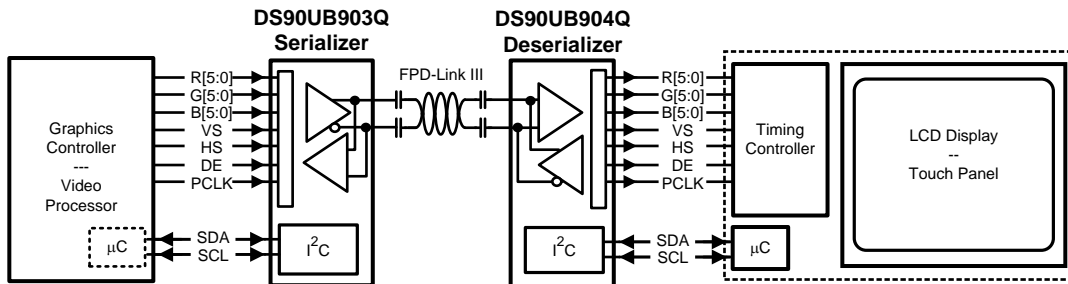

Figure 23. Typical Display System Diagram

## SERIAL FRAME FORMAT

The DS90UB903Q/904Q chipset will transmit and receive a pixel of data in the following format:

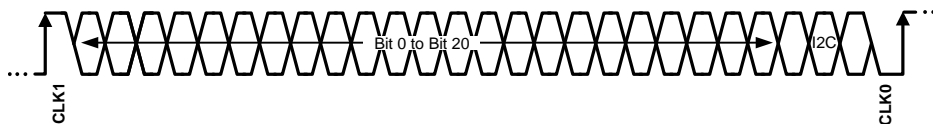

Figure 24. Serial Bitstream for 28-bit Symbol

The High Speed Forward Channel is a 28-bit symbol composed of 21 bits of data containing video data & control information transmitted from Serializer to Deserializer. CLK1 and CLK0 represent the embedded clock in the serial stream. CLK1 is always HIGH and CLK0 is always LOW. This data payload is optimized for signal transmission over an AC coupled link. Data is randomized, balanced and scrambled.

The bidirectional control channel data is transferred along with the high-speed forward data over the same serial link. This architecture provides a full duplex low speed forward channel across the serial link together with a high speed forward channel without the dependence of the video blanking phase.

## DESCRIPTION OF BIDIRECTIONAL CONTROL BUS AND I2C MODES

The I<sup>2</sup>C compatible interface allows programming of the DS90UB903Q, DS90UB904Q, or an external remote device (such as a display) through the bidirectional control channel. Register programming transactions to/from the DS90UB903Q/904Q chipset are employed through the clock (SCL) and data (SDA) lines. These two signals have open-drain I/Os and both lines must be pulled-up to VDDIO by external resistor. Figure 4 shows the timing relationships of the clock (SCL) and data (SDA) signals. Pull-up resistors or current sources are required on the SCL and SDA busses to pull them high when they are not being driven low. A logic zero is transmitted by driving the output low. A logic high is transmitted by releasing the output and allowing it to be pulled-up externally. The appropriate pull-up resistor values will depend upon the total bus capacitance and operating speed. The DS90UB903Q/904Q I<sup>2</sup>C bus data rate supports up to 100 kbps according to I<sup>2</sup>C specification.

To start any data transfer, the DS90UB903Q/904Q must be configured in the proper I<sup>2</sup>C mode. Each device can function as an I<sup>2</sup>C slave proxy or master proxy depending on the mode determined by MODE pin. The Ser/Des interface acts as a virtual bridge between Master Controller Unit (MCU) and the remote device. When the MODE pin is set to High, the device is treated as a slave proxy; acts as a slave on behalf of the remote slave. When addressing a remote peripheral or Serializer/Deserializer (not wired directly to the MCU), the slave proxy will forward any byte transactions sent by the Master controller to the target device. When MODE pin is set to Low, the device will function as a master proxy device; acts as a master on behalf of the I<sup>2</sup>C master controller. Note that the devices must have complementary settings for the MODE configuration. For example, if the Serializer MODE pin is set to High then the Deserializer MODE pin must be set to Low and vice-versa.

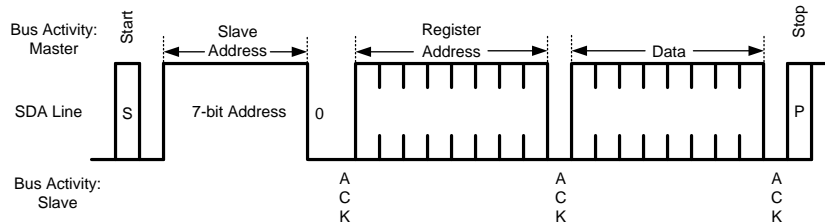

Figure 25. Write Byte

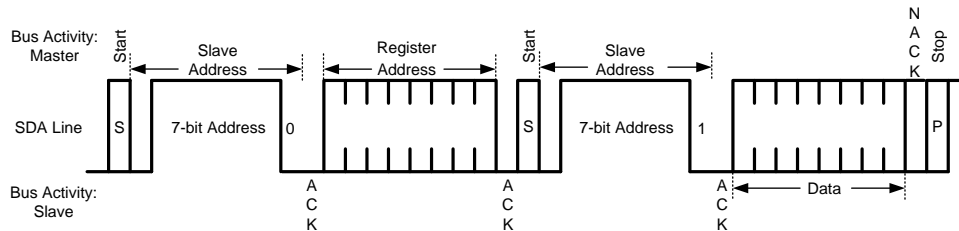

Figure 26. Read Byte

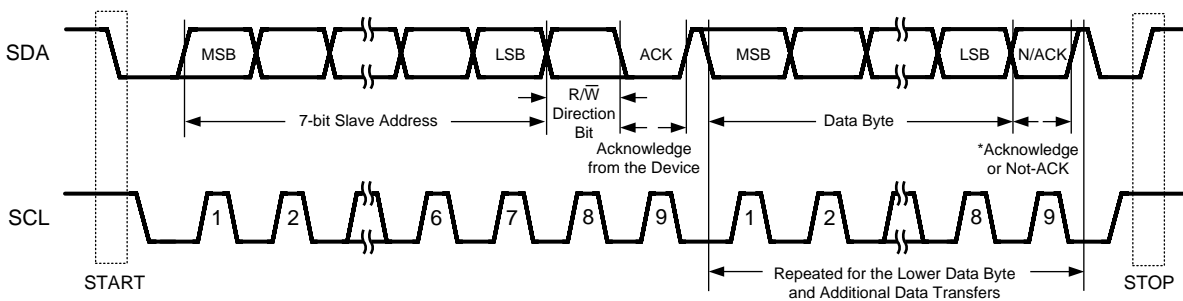
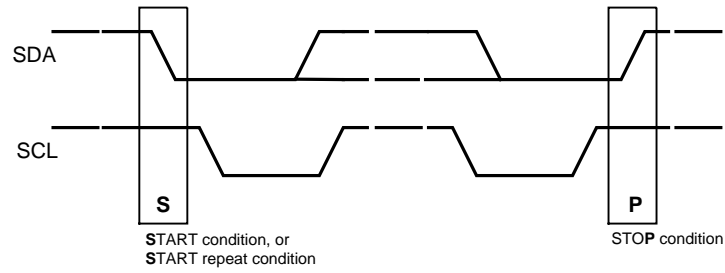

Figure 27. Basic Operation





**Figure 28. START and STOP Conditions**

### SLAVE CLOCK STRETCHING

In order to communicate and synchronize with remote devices on the I<sup>2</sup>C bus through the bidirectional control channel, slave clock stretching must be supported by the I<sup>2</sup>C master controller/MCU. The chipset utilizes bus clock stretching (holding the SCL line low) during data transmission; where the I<sup>2</sup>C slave pulls the SCL line low prior to the 9th clock of every I<sup>2</sup>C data transfer (before the ACK signal). The slave device will not control the clock and only stretches it until the remote peripheral has responded.

Any remote access involves the clock stretching period following the transmitted byte, prior to completion of the acknowledge bit. Since each byte transferred to the I<sup>2</sup>C slave must be acknowledged separately, the clock stretching will be done for each byte sent by the host controller. For remote accesses, the “Response Delay” shown is on the order of 12 μs (typical). See Application Note AN-2173 (SNLA131) for more details.

### ID[X] ADDRESS DECODER

The ID[x] pin is used to decode and set the physical slave address of the Serializer/Deserializer (I<sup>2</sup>C only) to allow up to six devices on the bus using only a single pin. The pin sets one of six possible addresses for each Serializer/Deserializer device. The pin must be pulled to VDD (1.8V, NOT VDDIO)) with a 10 kΩ resistor and a pull down resistor (RID) of the recommended value to set the physical device address. The recommended maximum resistor tolerance is 0.1% worst case (0.2% total tolerance).

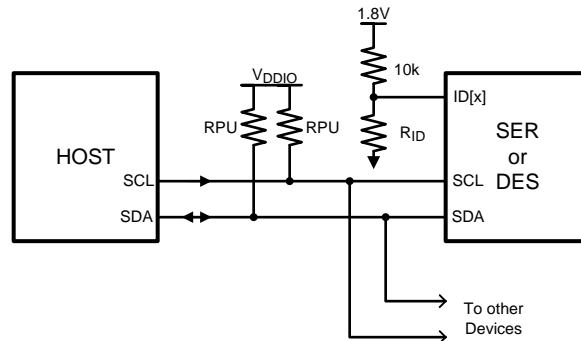

Figure 29. Bidirectional Control Bus Connection

Table 3. ID[x] Resistor Value – DS90UB903Q

ID[x] Resistor Value - DS90UB903Q Ser		
Resistor RID Ω (±0.1%)	Address 7'b <sup>(1)</sup>	Address 8'b 0 appended (WRITE)
0, GND	7b' 101 1000 (h'58)	8b' 1011 0000 (h'B0)
2.0k	7b' 101 1001 (h'59)	8b' 1011 0010 (h'B2)
4.7k	7b' 101 1010 (h'5A)	8b' 1011 0100 (h'B4)
8.2k	7b' 101 1011 (h'5B)	8b' 1011 0110 (h'B6)
12.1k	7b' 101 1100 (h'5C)	8b' 1011 1000 (h'B8)
39.0k	7b' 101 1110 (h'5E)	8b' 1011 1100 (h'BC)

(1) Specification is ensured by design.

**Table 4. ID[x] Resistor Value – DS90UB904Q**

ID[x] Resistor Value - DS90UB904Q Des		
Resistor RID $\Omega$ ( $\pm 0.1\%$ )	Address 7'b <sup>(1)</sup>	Address 8'b 0 appended (WRITE)
0, GND	7b' 110 0000 (h'60)	8b' 1100 0000 (h'C0)
2.0k	7b' 110 0001 (h'61)	8b' 1100 0010 (h'C2)
4.7k	7b' 110 0010 (h'62)	8b' 1100 0100 (h'C4)
8.2k	7b' 110 0011 (h'63)	8b' 1101 0110 (h'C6)
12.1k	7b' 110 0100 (h'64)	8b' 1101 1000 (h'C8)
39.0k	7b' 110 0110 (h'66)	8b' 1100 1100 (h'CC)

(1) Specification is ensured by design.

## CAMERA MODE OPERATION

In Camera mode, I<sup>2</sup>C transactions originate from the Deserializer from the Master controller (Figure 30). The I<sup>2</sup>C slave core in the Deserializer will detect if a transaction is intended for the Serializer or a slave at the Serializer. Commands are sent over the bidirectional control channel to initiate the transactions. The Serializer will receive the command and generate an I<sup>2</sup>C transaction on its local I<sup>2</sup>C bus. At the same time, the Serializer will capture the response on the I<sup>2</sup>C bus and return the response as a command on the forward channel link. The Deserializer parses the response and passes the appropriate response to the Deserializer I<sup>2</sup>C bus.

To configure the devices for camera mode operation, set the Serializer MODE pin to Low and the Deserializer MODE pin to High. Before initiating any I<sup>2</sup>C commands, the Deserializer needs to be programmed with the target slave device addresses and Serializer device address. SER\_DEV\_ID Register 0x07h sets the Serializer device address and SLAVE\_x\_MATCH/SLAVE\_x\_INDEX registers 0x08h~0x17h set the remote target slave addresses. The slave address match registers must also be set. In slave mode the address register is compared with the address byte sent by the I<sup>2</sup>C master. If the addresses are equal to any of registers values, the I<sup>2</sup>C slave will acknowledge the transaction to the I<sup>2</sup>C master allowing reads or writes to target device.

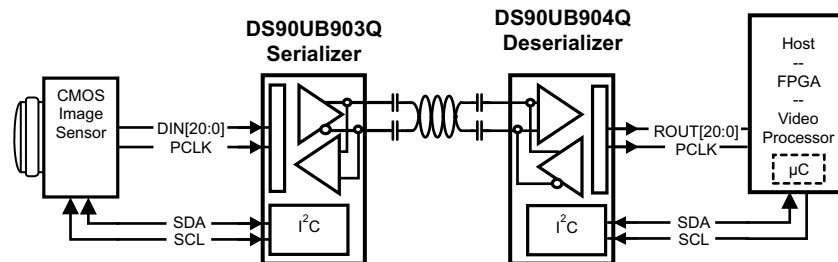

**Figure 30. Typical Camera System Diagram**

## DISPLAY MODE OPERATION

In Display mode, I<sup>2</sup>C transactions originate from the controller attached to the Serializer. The I<sup>2</sup>C slave core in the Serializer will detect if a transaction targets (local) registers within the Serializer or the (remote) registers within the Deserializer or a remote slave connected to the I<sup>2</sup>C master interface of the Deserializer. Commands are sent over the forward channel link to initiate the transactions. The Deserializer will receive the command and generate an I<sup>2</sup>C transaction on its local I<sup>2</sup>C bus. At the same time, the Deserializer will capture the response on the I<sup>2</sup>C bus and return the response as a command on the bidirectional control channel. The Serializer parses the response and passes the appropriate response to the Serializer I<sup>2</sup>C bus.

The physical device ID of the I<sup>2</sup>C slave in the Serializer is determined by the analog voltage on the ID[x] input. It can be reprogrammed by using the SER\_DEV\_ID register and setting the bit . The device ID of the logical I<sup>2</sup>C slave in the Deserializer is determined by programming the DES ID in the Serializer. The state of the ID[x] input on the Deserializer is used to set the device ID. The I<sup>2</sup>C transactions between Ser/Des will be bridged between the host to the remote slave.

To configure the devices for display mode operation, set the Serializer MODE pin to High and the Deserializer MODE pin to Low. Before initiating any I<sup>2</sup>C commands, the Serializer needs to be programmed with the target slave device address and Serializer device address. DES\_DEV\_ID Register 0x06h sets the Deserializer device address and SLAVE\_DEV\_ID register 0x7h sets the remote target slave address. If the I<sup>2</sup>C slave address matches any of registers values, the I<sup>2</sup>C slave will acknowledge the transaction allowing read or write to target device. Note: In Display mode operation, registers 0x08h~0x17h on Deserializer must be reset to 0x00.

### PROGRAMMABLE CONTROLLER

An integrated I<sup>2</sup>C slave controller is embedded in each of the DS90UB903Q Serializer and DS90UB904Q Deserializer. It must be used to access and program the extra features embedded within the configuration registers. Refer to Table 1 and Table 2 for details of control registers.

### I<sup>2</sup>C PASS THROUGH

I<sup>2</sup>C pass-through provides an alternative means to independently address slave devices. The mode enables or disables I<sup>2</sup>C bidirectional control channel communication to the remote I<sup>2</sup>C bus. This option is used to determine whether or not an I<sup>2</sup>C instruction is to be transferred over to the remote I<sup>2</sup>C device. When enabled, the I<sup>2</sup>C bus traffic will continue to pass through and will be received by I<sup>2</sup>C devices downstream. If disabled, I<sup>2</sup>C commands will be excluded to the remote I<sup>2</sup>C device. The pass through function also provides access and communication to only specific devices on the remote bus. The feature is effective for both Camera mode and Display mode.

### SYNCHRONIZING MULTIPLE LINKS

For applications requiring synchronization across multiple links, it is recommended to utilize the General Purpose Input/Output (GPI/GPO) pins to transmit control signals to synchronize slave peripherals together. To synchronize the peripherals properly, the system controller needs to provide a sync signal output. Note this form of synchronization timing relationship has a non-deterministic latency. After the control data is reconstructed from the bidirectional control channel, there will be a time variation of the GPI/GPO signals arriving at the different target devices (between the parallel links). The maximum latency delta (t<sub>1</sub>) of the GPI/GPO data transmitted across multiple links is 25 us.

Note: The user must verify that the timing variations between the different links are within their system and timing specifications.

The maximum time (t<sub>1</sub>) between the rising edge of GPI/GPO (i.e. sync signal) arriving at SER A and SER B is 25 us.

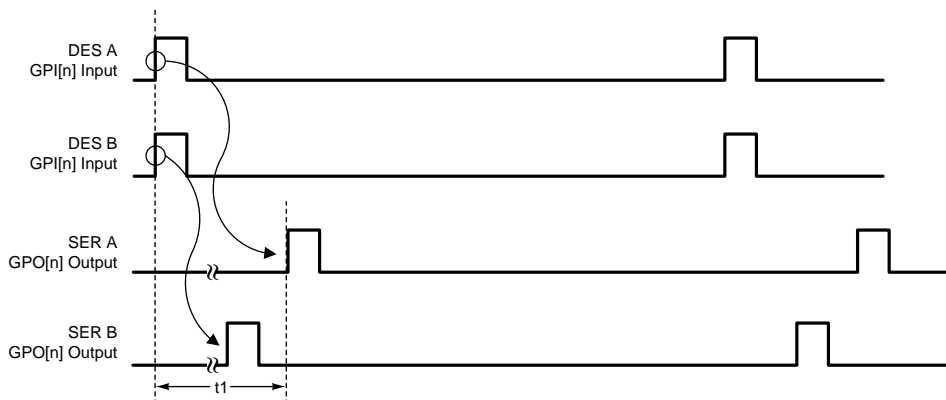

Figure 31. GPI/GPO Delta Latency

### GENERAL PURPOSE I/O (GPI/GPO)

The DS90UB903Q/904Q has up to 4 GPO and 4 GPI on the Serializer and Deserializer respectively. The GPI/GPO maximum switching rate is up to 66 kHz for communication between Deserializer GPI to Serializer GPO.

**AT-SPEED BIST (BISTEN, PASS)**

An optional AT SPEED Built in Self Test (BIST) feature supports at speed testing of the high-speed serial and the bidirectional control channel link. Control pins at the Deserializer are used to enable the BIST test mode and allow the system to initiate the test and set the duration. A HIGH on PASS pin indicates that all payloads received during the test were error free during the BIST duration test. A LOW on this pin at the conclusion of the test indicates that one or more payloads were detected with errors.

The BIST duration is defined by the width of BISTEN. BIST starts when Deserializer LOCK goes HIGH and BISTEN is set HIGH. BIST ends when BISTEN goes LOW. Any errors detected after the BIST Duration are not included in PASS logic.

Note: AT-SPEED BIST is only available in the Camera mode and not the Display mode

The following diagram shows how to perform system AT SPEED BIST:

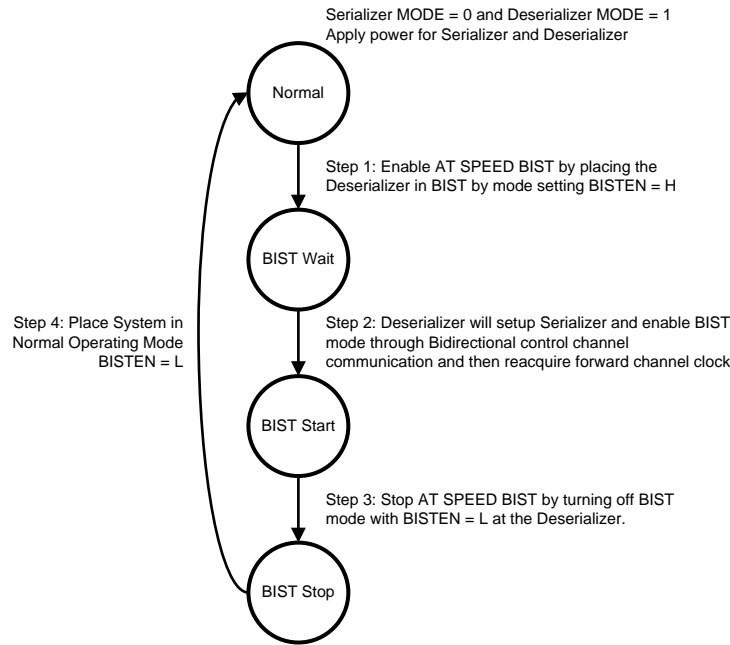

**Figure 32. AT-SPEED BIST System Flow Diagram**

*Step 1: Place the Deserializer in BIST Mode.*

Serializer and Deserializer power supply must be supplied. Enable the AT SPEED BIST mode on the Deserializer by setting the BISTEN pin High. The 904 GPI[1:0] pins are used to select the PCLK frequency of the on-chip oscillator for the BIST test on high speed data path.

**Table 5. BIST Oscillator Frequency Select**

Des GPI[1:0]	Oscillator Source	min (MHz)	typ (MHz)	max (MHz)
00	External PCLK	10		43
01	Internal		50	
10	Internal		25	
11	Internal		12.5	

The Deserializer GPI[1:0] set to 00 will bypass the on-chip oscillator and an external oscillator to Serializer PCLK input is required. This allows the user to operate BIST under different frequencies other than the predefined ranges.

*Step 2: Enable AT SPEED BIST by placing the Serializer into BIST mode.*

Deserializer will communicate through the bidirectional control channel to configure Serializer into BIST mode. Once the BIST mode is set, the Serializer will initiate BIST transmission to the Deserializer.

Wait 10 ms for Deserializer to acquire lock and then monitor the LOCK pin transition from LOW to HIGH. At this point, AT SPEED BIST is operational and the BIST process has begun. The Serializer will start transfer of an internally generated PRBS data pattern through the high speed serial link. This pattern traverses across the interconnecting link to the Deserializer. Check the status of the PASS pin; a HIGH indicates a pass, a LOW indicates a fail. A fail will stay LOW for 1/2 a clock cycle. If two or more bits in the serial frame fail, the PASS pin will toggle 1/2 clock cycle HIGH and 1/2 clock cycle low. The user can use the PASS pin to count the number of fails on the high speed link. In addition, there is a defined SER and DES register that will keep track of the accumulated error count. The Serializer 903 GPO[0] pin will be assigned as a PASS flag error indicator for the bidirectional control channel link.

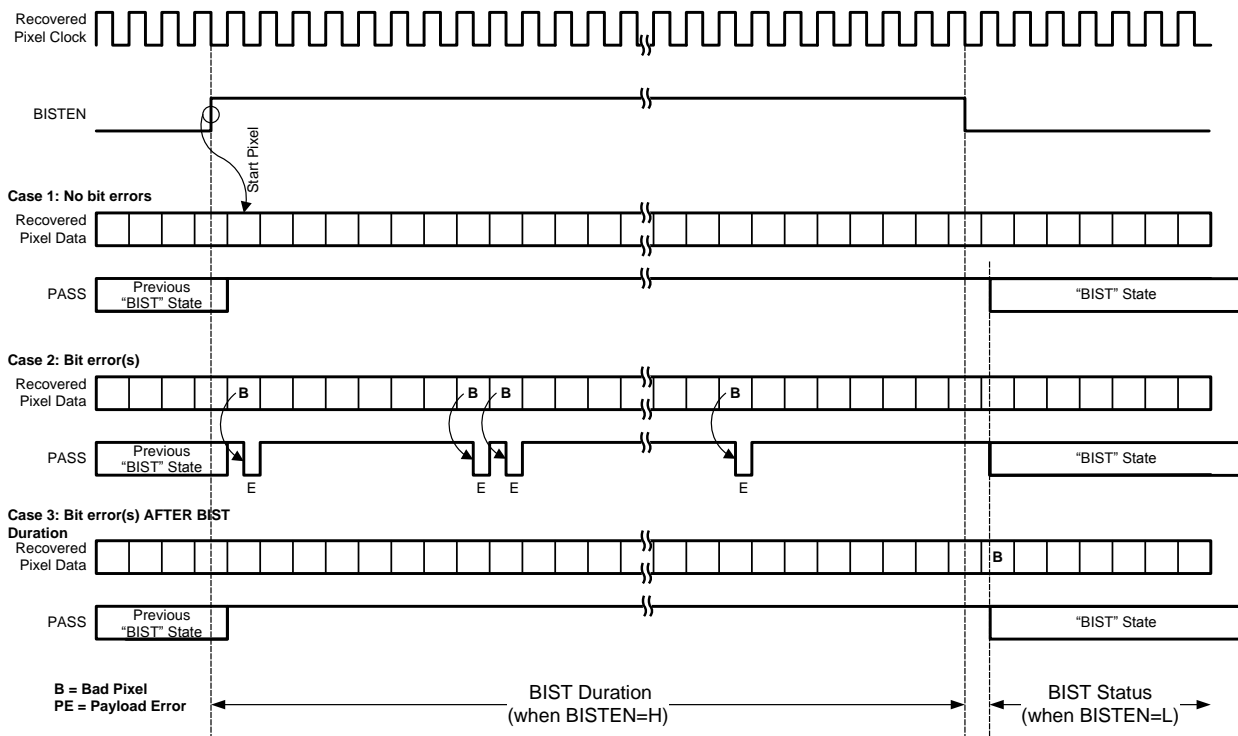

**Figure 33. BIST Timing Diagram**

*Step 3: Stop at SPEED BIST by turning off BIST mode in the Deserializer to determine Pass/Fail.*

To end BIST, the system must pull BISTEN pin of the Deserializer LOW. The BIST duration is fully defined by the BISTEN width and Deserializer LOCK is HIGH; thus the Bit Error Rate is determined by how long the system holds BISTEN HIGH.

$$\frac{\text{BIST Duration (s)}}{1 \text{ Pixel period (ns)} \times \text{Total Bits}} = \text{BIST Duration (s)} \times \frac{f_{\text{pixel}} \text{ (MHz)}}{\text{Pixel}} \times \text{Total Pixels Transmitted} = \text{Total Bits Transmitted}$$

$$\begin{aligned} \bullet \bullet \quad \text{Bit (Pixel) Error Rate} &= [\text{Total Bits Transmitted}]^{-1} \\ &\text{(for passing BIST)} \\ &= [\text{Total Bits Transmitted} \times \text{Bits/Pixel}]^{-1} \end{aligned}$$

**Figure 34. BIST BER Calculation**

*Step 4: Place system in Normal Operating Mode by disabling BIST at the Serializer.*

Once Step 3 is complete, AT SPEED BIST is over and the Deserializer is out of BIST mode. To fully return to Normal mode, apply Normal input data into the Serializer.

Any PASS result will remain unless it is changed by a new BIST session or cleared by asserting and releasing PDB. The default state of PASS after a PDB toggle is HIGH.

It is important to note that AT SPEED BIST will only determine if there is an issue on the link that is not related to the clock and data recovery of the link (whose status is flagged with LOCK pin).

### LVC MOS VDDIO OPTION

1.8V or 3.3V SER Inputs and DES Outputs are user selectable to provide compatibility with 1.8V and 3.3V system interfaces.

### REMOTE WAKE UP (Camera Mode)

After initial power up, the Serializer is in a low-power Standby mode. The Deserializer (controlled by ECU/MCU) 'Remote Wake-up' register allows the Deserializer side to generate a signal across the link to remotely wake-up the Serializer. Once the Serializer detects the wake-up signal Serializer switches from Standby mode to active mode. In active mode, the Serializer locks onto PCLK input (if present), otherwise the on-chip oscillator is used as the input clock source. Note the MCU controller should monitor the Deserializer LOCK pin and confirm LOCK = H before performing any I<sup>2</sup>C communication across the link.

For Remote Wake-up to function properly:

- The chipset needs to be configured in Camera mode: Serializer MODE = 0 and Deserializer MODE = 1
- Serializer expects remote wake-up by default at power on.
- Configure the control channel driver of the Deserializer to be in remote wake-up mode by setting Deserializer Register 0x26h = 0xC0h
- Perform remote wake-up on Serializer by setting Deserializer Register 0x01 b[2] = 1
- Return the control channel driver of the Deserializer to the normal operation mode by setting Deserializer Register 0x26h = 0x00h
- Configure the control channel driver of the Deserializer to be in normal operation mode by setting Deserializer Register 0x27h = 0xC0h.

Serializer can also be put into standby mode by programming the Deserializer remote wake-up control register 0x01 b[2] REM\_WAKEUP to 0.

### POWERDOWN

The SER has a PDB input pin to ENABLE or Powerdown the device. The modes can be controlled by the host and is used to disable the Link to save power when the remote device is not operational. An auto mode is also available. In this mode, the PDB pin is tied High and the SER switches over to an internal oscillator when the PCLK stops or not present. When a PCLK starts again, the SER will then lock to the valid input PCLK and transmits the data to the DES. In powerdown mode, the high-speed driver outputs are static (High).

The DES has a PDB input pin to ENABLE or Powerdown the device. This pin can be controlled by the system and is used to disable the DES to save power. An auto mode is also available. In this mode, the PDB pin is tied High and the DES will enter powerdown when the serial stream stops. When the serial stream starts up again, the DES will lock to the input stream and assert the LOCK pin and output valid data. In powerdown mode, the Data and PCLK outputs are set by the OSS\_SEL control register.

## POWER UP REQUIREMENTS AND PDB PIN

It is required to delay and release the PDB input signal after VDD (VDDn and VDDIO) power supplies have settled to the recommended operating voltages. A external RC network can be connected to the PDB pin to ensure PDB arrives after all the VDD have stabilized.

## SIGNAL QUALITY ENHANCERS

### *Des - Receiver Input Equalization (EQ)*

The receiver inputs provided input equalization filter in order to compensate for loss from the media. The level of equalization is controlled via register setting. Note this function can be observed at the CMLOUTP/N test port enabled via the control registers.

## EMI REDUCTION

### *Des - Receiver Staggered Output*

The Receiver staggered outputs allows for outputs to switch in a random distribution of transitions within a defined window. Outputs transitions are distributed randomly. This minimizes the number of outputs switching simultaneously and helps to reduce supply noise. In addition it spreads the noise spectrum out reducing overall EMI.

### *Des Spread Spectrum Clocking*

The DS90UB904Q parallel data and clock outputs have programmable SSCG ranges from 9 kHz–66 kHz and  $\pm 0.5\%$ – $\pm 2\%$  from 20 MHz to 43 MHz. The modulation rate and modulation frequency variation of output spread is controlled through the SSC control registers.

## PIXEL CLOCK EDGE SELECT (TRFB/RRFB)

The TRFB/RRFB selects which edge of the Pixel Clock is used. For the SER, this register determines the edge that the data is latched on. If TRFB register is 1, data is latched on the Rising edge of the PCLK. If TRFB register is 0, data is latched on the Falling edge of the PCLK. For the DES, this register determines the edge that the data is strobed on. If RRFB register is 1, data is strobed on the Rising edge of the PCLK. If RRFB register is 0, data is strobed on the Falling edge of the PCLK.

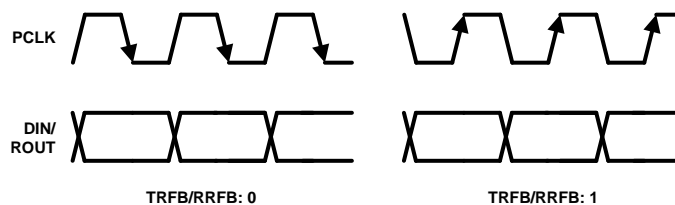

**Figure 35. Programmable PCLK Strobe Select**



## APPLICATIONS INFORMATION

### AC COUPLING

The SER/DES supports only AC-coupled interconnects through an integrated DC balanced decoding scheme. External AC coupling capacitors must be placed in series in the FPD-Link III signal path as illustrated in Figure 36.

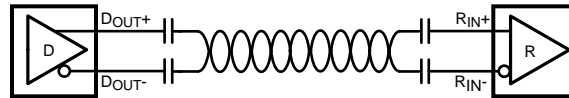

Figure 36. AC-Coupled Connection

For high-speed FPD-Link III transmissions, the smallest available package should be used for the AC coupling capacitor. This will help minimize degradation of signal quality due to package parasitics. The I/O's require a 100 nF AC coupling capacitors to the line.

### TYPICAL APPLICATION CONNECTION

Figure 37 shows a typical connection of the DS90UB903Q Serializer.

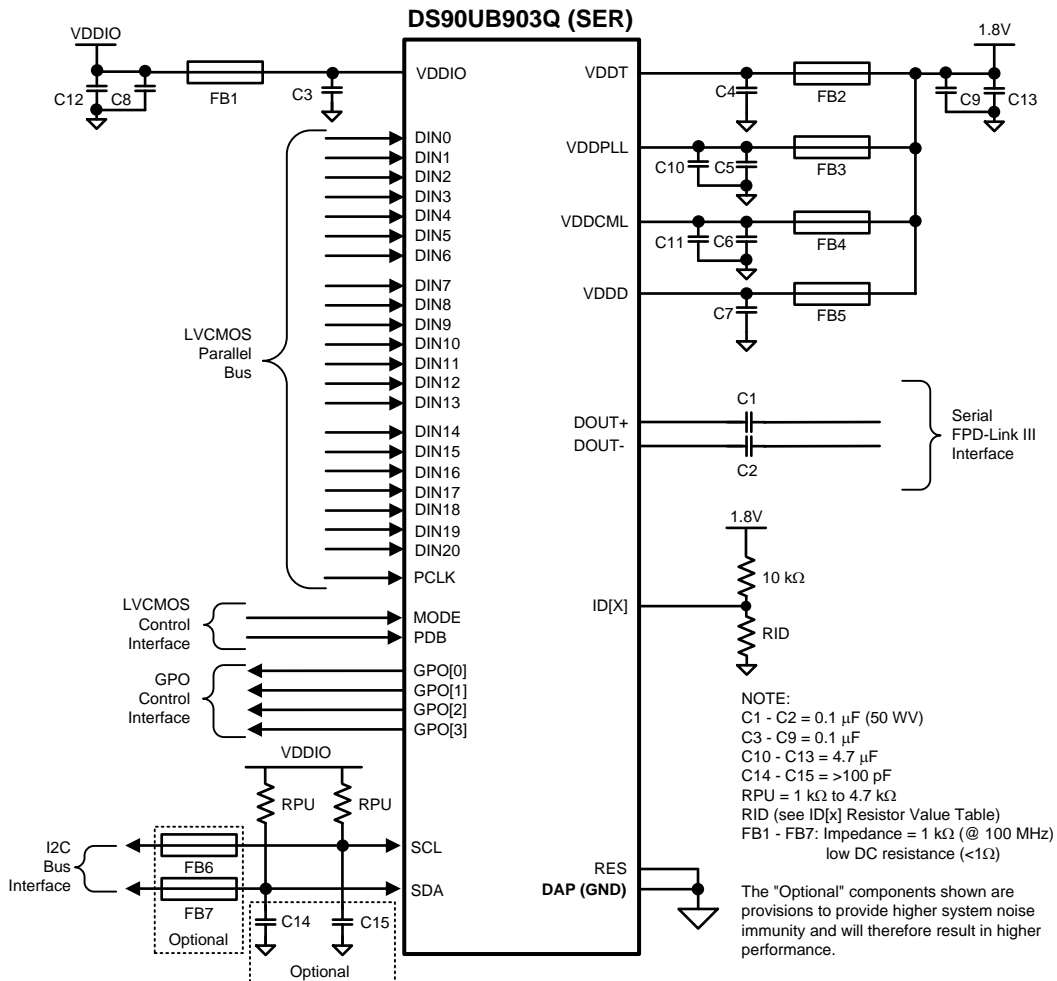

Figure 37. DS90UB903Q Typical Connection Diagram — Pin Control

Figure 38 shows a typical connection of the DS90UB904Q Deserializer.

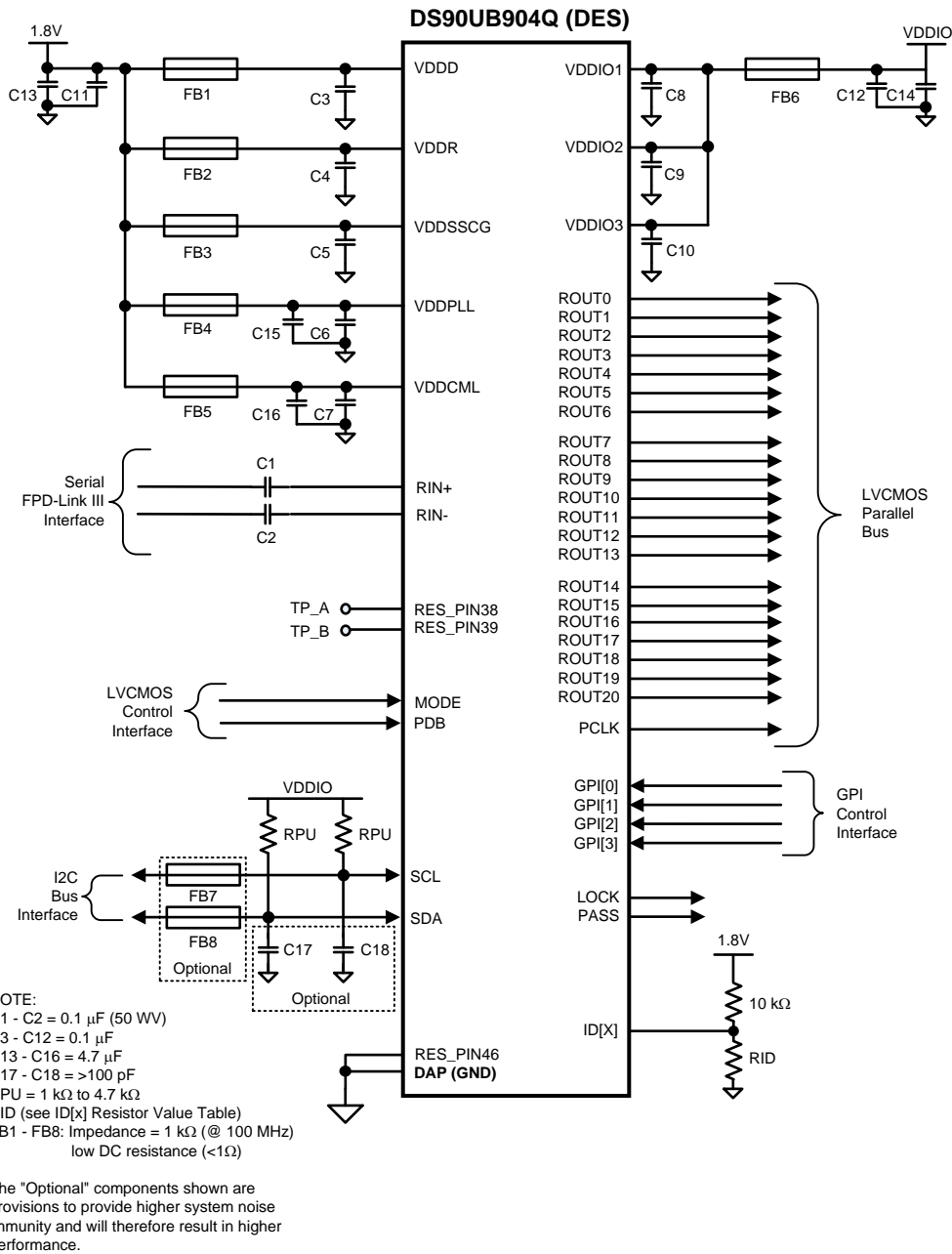

Figure 38. DS90UB904Q Typical Connection Diagram — Pin Control

## TRANSMISSION MEDIA

The Ser/Des chipset is intended to be used over a wide variety of balanced cables depending on distance and signal quality requirements. The Ser/Des employ internal termination providing a clean signaling environment. The interconnect for FPD-Link III interface should present a differential impedance of 100 Ohms. Use of cables and connectors that have matched differential impedance will minimize impedance discontinuities. Shielded or un-shielded cables may be used depending upon the noise environment and application requirements. The chipset's optimum cable drive performance is achieved at 43 MHz at 10 meters length. The maximum signaling

rate increases as the cable length decreases. Therefore, the chipset supports 50 MHz at shorter distances. Other cable parameters that may limit the cable's performance boundaries are: cable attenuation, near-end crosstalk and pair-to-pair skew. The maximum length of cable that can be used is dependant on the quality of the cable (gauge, impedance), connector, board (discontinuities, power plane), the electrical environment (e.g. power stability, ground noise, input clock jitter, PCLK frequency, etc.) and the application environment.

The resulting signal quality at the receiving end of the transmission media may be assessed by monitoring the differential eye opening of the CMLOUT P/N output. A differential probe should be used to measure across the termination resistor at the CMLOUT P/N pins.

For obtaining optimal performance, we recommend:

- Use Shielded Twisted Pair (STP) cable
- 100Ω differential impedance and 24 AWG (or lower AWG) cable
- Low skew, impedance matched
- Ground and/or terminate unused conductors

Figure 39 shows the Typical Performance Characteristics demonstrating various lengths and data rates using Rosenberger HSD and Leoni DACAR 538 Cable.

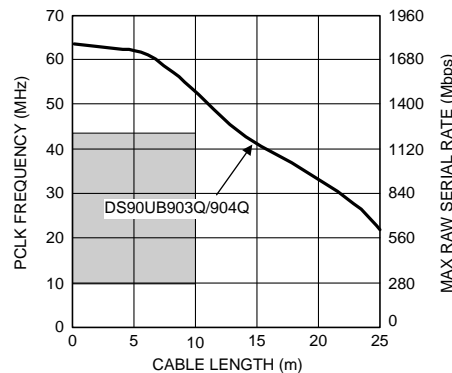

\*Note: Equalization is enabled for cable lengths greater than 7 meters

**Figure 39. Rosenberger HSD & Leoni DACAR 538 Cable Performance**

## PCB LAYOUT AND POWER SYSTEM CONSIDERATIONS

Circuit board layout and stack-up for the Ser/Des devices should be designed to provide low-noise power feed to the device. Good layout practice will also separate high frequency or high-level inputs and outputs to minimize unwanted stray noise pickup, feedback and interference. Power system performance may be greatly improved by using thin dielectrics (2 to 4 mils) for power / ground sandwiches. This arrangement provides plane capacitance for the PCB power system with low-inductance parasitics, which has proven especially effective at high frequencies, and makes the value and placement of external bypass capacitors less critical. External bypass capacitors should include both RF ceramic and tantalum electrolytic types. RF capacitors may use values in the range of 0.01 uF to 0.1 uF. Tantalum capacitors may be in the 2.2 uF to 10 uF range. Voltage rating of the tantalum capacitors should be at least 5X the power supply voltage being used.

Surface mount capacitors are recommended due to their smaller parasitics. When using multiple capacitors per supply pin, locate the smaller value closer to the pin. A large bulk capacitor is recommend at the point of power entry. This is typically in the 50uF to 100uF range and will smooth low frequency switching noise. It is recommended to connect power and ground pins directly to the power and ground planes with bypass capacitors connected to the plane with via on both ends of the capacitor. Connecting power or ground pins to an external bypass capacitor will increase the inductance of the path.

A small body size X7R chip capacitor, such as 0603, is recommended for external bypass. Its small body size reduces the parasitic inductance of the capacitor. The user must pay attention to the resonance frequency of these external bypass capacitors, usually in the range of 20-30 MHz. To provide effective bypassing, multiple capacitors are often used to achieve low impedance between the supply rails over the frequency of interest. At high frequency, it is also a common practice to use two vias from power and ground pins to the planes, reducing the impedance at high frequency.

Some devices provide separate power for different portions of the circuit. This is done to isolate switching noise effects between different sections of the circuit. Separate planes on the PCB are typically not required. Pin Description tables typically provide guidance on which circuit blocks are connected to which power pin pairs. In some cases, an external filter may be used to provide clean power to sensitive circuits such as PLLs.

Use at least a four layer board with a power and ground plane. Locate LVCMOS signals away from the differential lines to prevent coupling from the LVCMOS lines to the differential lines. Closely-coupled differential lines of 100 Ohms are typically recommended for differential interconnect. The closely coupled lines help to ensure that coupled noise will appear as common-mode and thus is rejected by the receivers. The tightly coupled lines will also radiate less.

Information on the WQFN style package is provided in Application Note: AN-1187 “*Leadless Leadframe Package (LLP) Application Report*” (literature number [SNOA401](#)).

## INTERCONNECT GUIDELINES

See AN-1108 ([SNLA008](#)) and AN-905 ([SNLA035](#)) for full details.

- Use 100Ω coupled differential pairs
- Use the S/2S/3S rule in spacings
  - S = space between the pair
  - 2S = space between pairs
  - 3S = space to LVCMOS signal
- Minimize the number of Vias
- Use differential connectors when operating above 500Mbps line speed
- Maintain balance of the traces
- Minimize skew within the pair

Additional general guidance can be found in the LVDS Owner's Manual - available in PDF format from the Texas Instruments web site at: [www.ti.com/lvds](http://www.ti.com/lvds)

## Revision History

### 04/16/2012

- Added CMLOUT P/N in DS90UB904Q Deserializer Pin Descriptions
- Added ESD CDM and ESD MM values
- Added 3.3V I/O VOH conditions: IOH = -4 mA
- Corrected 3.3V I/O VOL conditions: IOL = +4 mA
- Changed NSID DS90UB903/904QSQX to qty 2500
- Added “Only used when VDDIOCONTROL = 0” note for UB904 Register 0x03 bit[4] description
- Added Register 0x27 BCC in UB904 Register table
- Added Register 0x3F CML Output in UB904 Register table
- Updated SLAVE CLOCK STRETCHING in Functional Description section
- Updated REMOTE WAKE UP (Camera Mode) procedure in Functional Description section
- Updated Des - Receiver Input Equalization (EQ) in Functional Description section
- Updated TRANSMISSION MEDIA in Applications Information section

### 04/16/2013

- Changed layout of National Data Sheet to TI format.

**PACKAGING INFORMATION**

Orderable Device	Status (1)	Package Type	Package Drawing	Pins	Package Qty	Eco Plan (2)	Lead finish/ Ball material (6)	MSL Peak Temp (3)	Op Temp (°C)	Device Marking (4/5)	Samples
DS90UB903QSQ/NOPB	ACTIVE	WQFN	RTA	40	1000	RoHS & Green	SN	Level-3-260C-168 HR	-40 to 105	UB903QSQ	<a href="#">Samples</a>
DS90UB903QSQE/NOPB	ACTIVE	WQFN	RTA	40	250	RoHS & Green	SN	Level-3-260C-168 HR	-40 to 105	UB903QSQ	<a href="#">Samples</a>
DS90UB903QSQX/NOPB	ACTIVE	WQFN	RTA	40	2500	RoHS & Green	SN	Level-3-260C-168 HR	-40 to 105	UB903QSQ	<a href="#">Samples</a>
DS90UB904QSQ/NOPB	ACTIVE	WQFN	RHS	48	1000	RoHS & Green	SN	Level-3-260C-168 HR	-40 to 105	UB904QSQ	<a href="#">Samples</a>
DS90UB904QSQE/NOPB	ACTIVE	WQFN	RHS	48	250	RoHS & Green	SN	Level-3-260C-168 HR	-40 to 105	UB904QSQ	<a href="#">Samples</a>
DS90UB904QSQX/NOPB	ACTIVE	WQFN	RHS	48	2500	RoHS & Green	SN	Level-3-260C-168 HR	-40 to 105	UB904QSQ	<a href="#">Samples</a>

(1) The marketing status values are defined as follows:

**ACTIVE:** Product device recommended for new designs.

**LIFEBUY:** TI has announced that the device will be discontinued, and a lifetime-buy period is in effect.

**NRND:** Not recommended for new designs. Device is in production to support existing customers, but TI does not recommend using this part in a new design.

**PREVIEW:** Device has been announced but is not in production. Samples may or may not be available.

**OBSOLETE:** TI has discontinued the production of the device.

(2) **RoHS:** TI defines "RoHS" to mean semiconductor products that are compliant with the current EU RoHS requirements for all 10 RoHS substances, including the requirement that RoHS substance do not exceed 0.1% by weight in homogeneous materials. Where designed to be soldered at high temperatures, "RoHS" products are suitable for use in specified lead-free processes. TI may reference these types of products as "Pb-Free".

**RoHS Exempt:** TI defines "RoHS Exempt" to mean products that contain lead but are compliant with EU RoHS pursuant to a specific EU RoHS exemption.

**Green:** TI defines "Green" to mean the content of Chlorine (Cl) and Bromine (Br) based flame retardants meet JS709B low halogen requirements of <=1000ppm threshold. Antimony trioxide based flame retardants must also meet the <=1000ppm threshold requirement.

(3) MSL, Peak Temp. - The Moisture Sensitivity Level rating according to the JEDEC industry standard classifications, and peak solder temperature.

(4) There may be additional marking, which relates to the logo, the lot trace code information, or the environmental category on the device.

(5) Multiple Device Markings will be inside parentheses. Only one Device Marking contained in parentheses and separated by a "~" will appear on a device. If a line is indented then it is a continuation of the previous line and the two combined represent the entire Device Marking for that device.

(6) Lead finish/Ball material - Orderable Devices may have multiple material finish options. Finish options are separated by a vertical ruled line. Lead finish/Ball material values may wrap to two lines if the finish value exceeds the maximum column width.

**Important Information and Disclaimer:** The information provided on this page represents TI's knowledge and belief as of the date that it is provided. TI bases its knowledge and belief on information provided by third parties, and makes no representation or warranty as to the accuracy of such information. Efforts are underway to better integrate information from third parties. TI has taken and continues to take reasonable steps to provide representative and accurate information but may not have conducted destructive testing or chemical analysis on incoming materials and chemicals. TI and TI suppliers consider certain information to be proprietary, and thus CAS numbers and other limited information may not be available for release.

In no event shall TI's liability arising out of such information exceed the total purchase price of the TI part(s) at issue in this document sold by TI to Customer on an annual basis.

**TAPE AND REEL INFORMATION**

**QUADRANT ASSIGNMENTS FOR PIN 1 ORIENTATION IN TAPE**

\*All dimensions are nominal

Device	Package Type	Package Drawing	Pins	SPQ	Reel Diameter (mm)	Reel Width W1 (mm)	A0 (mm)	B0 (mm)	K0 (mm)	P1 (mm)	W (mm)	Pin1 Quadrant
DS90UB903QSQ/NOPB	WQFN	RTA	40	1000	330.0	16.4	6.3	6.3	1.5	12.0	16.0	Q1
DS90UB903QSQE/NOPB	WQFN	RTA	40	250	178.0	16.4	6.3	6.3	1.5	12.0	16.0	Q1
DS90UB903QSQX/NOPB	WQFN	RTA	40	2500	330.0	16.4	6.3	6.3	1.5	12.0	16.0	Q1
DS90UB904QSQ/NOPB	WQFN	RHS	48	1000	330.0	16.4	7.3	7.3	1.3	12.0	16.0	Q1
DS90UB904QSQE/NOPB	WQFN	RHS	48	250	178.0	16.4	7.3	7.3	1.3	12.0	16.0	Q1
DS90UB904QSQX/NOPB	WQFN	RHS	48	2500	330.0	16.4	7.3	7.3	1.3	12.0	16.0	Q1



**TAPE AND REEL BOX DIMENSIONS**

\*All dimensions are nominal

Device	Package Type	Package Drawing	Pins	SPQ	Length (mm)	Width (mm)	Height (mm)
DS90UB903QSQ/NOPB	WQFN	RTA	40	1000	356.0	356.0	35.0
DS90UB903QSQE/NOPB	WQFN	RTA	40	250	208.0	191.0	35.0
DS90UB903QSQX/NOPB	WQFN	RTA	40	2500	356.0	356.0	35.0
DS90UB904QSQ/NOPB	WQFN	RHS	48	1000	356.0	356.0	35.0
DS90UB904QSQE/NOPB	WQFN	RHS	48	250	208.0	191.0	35.0
DS90UB904QSQX/NOPB	WQFN	RHS	48	2500	356.0	356.0	35.0

RTA0040A

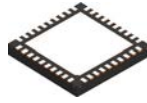

PACKAGE OUTLINE

WQFN - 0.8 mm max height

PLASTIC QUAD FLATPACK - NO LEAD

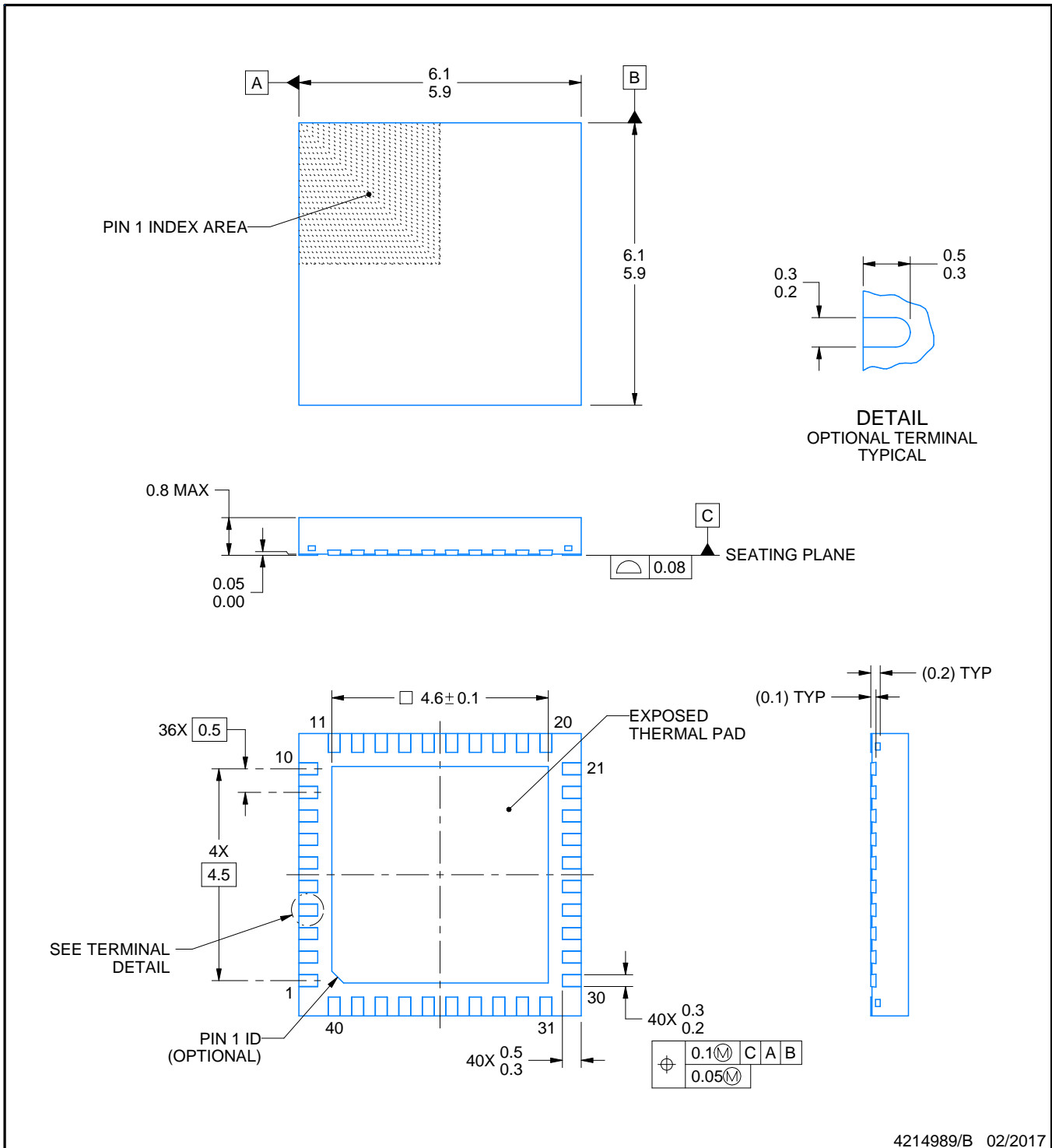

4214989/B 02/2017

NOTES:

1. All linear dimensions are in millimeters. Any dimensions in parenthesis are for reference only. Dimensioning and tolerancing per ASME Y14.5M.
2. This drawing is subject to change without notice.
3. The package thermal pad must be soldered to the printed circuit board for thermal and mechanical performance.

# EXAMPLE BOARD LAYOUT

RTA0040A

WQFN - 0.8 mm max height

PLASTIC QUAD FLATPACK - NO LEAD

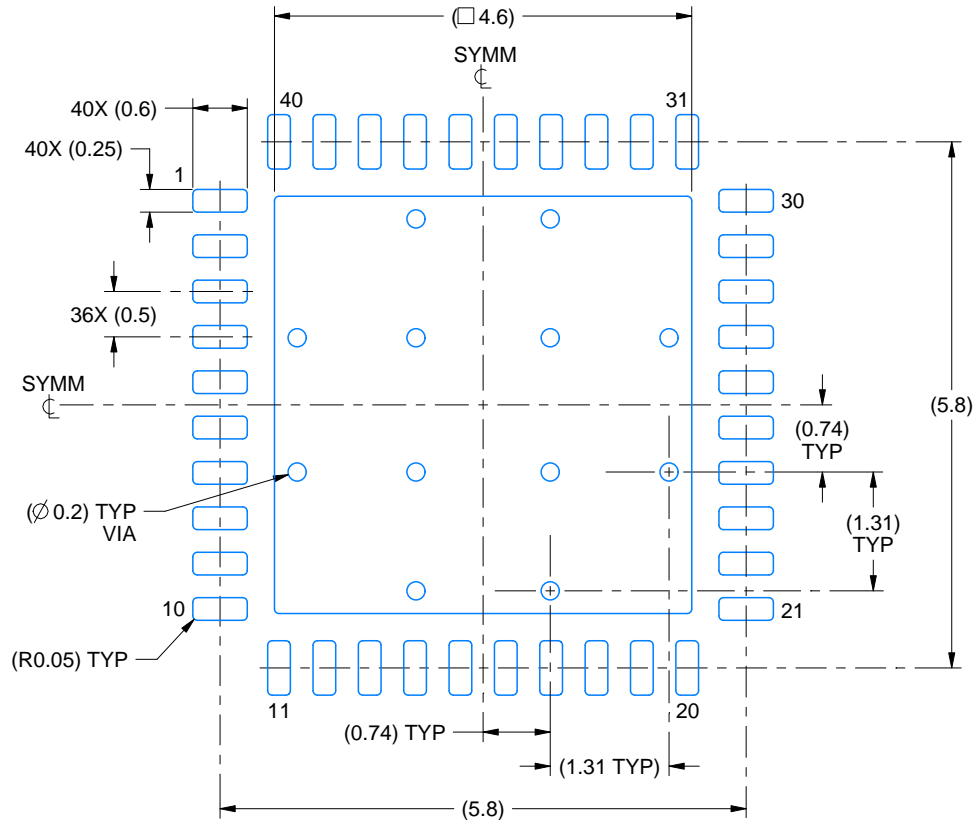

LAND PATTERN EXAMPLE  
EXPOSED METAL SHOWN  
SCALE:12X

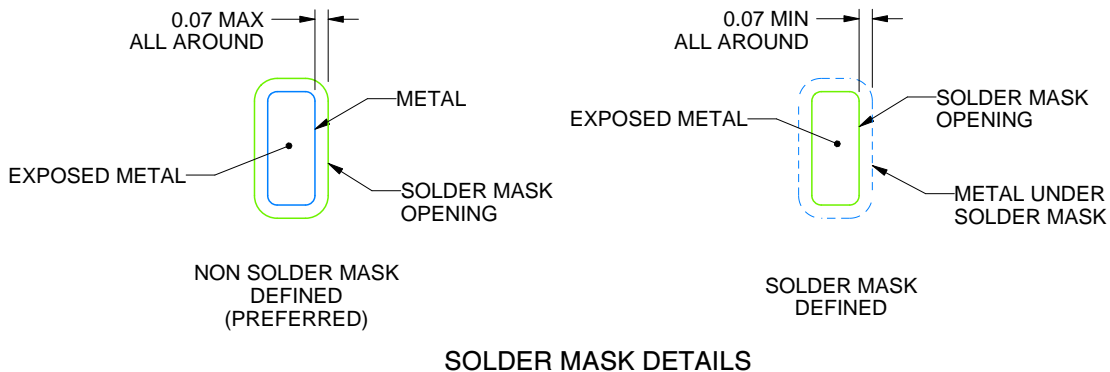

SOLDER MASK DETAILS

4214989/B 02/2017

NOTES: (continued)

- This package is designed to be soldered to a thermal pad on the board. For more information, see Texas Instruments literature number SLUA271 ([www.ti.com/lit/slua271](http://www.ti.com/lit/slua271)).
- Vias are optional depending on application, refer to device data sheet. If any vias are implemented, refer to their locations shown on this view. It is recommended that vias under paste be filled, plugged or tented.

# EXAMPLE STENCIL DESIGN

RTA0040A

WQFN - 0.8 mm max height

PLASTIC QUAD FLATPACK - NO LEAD

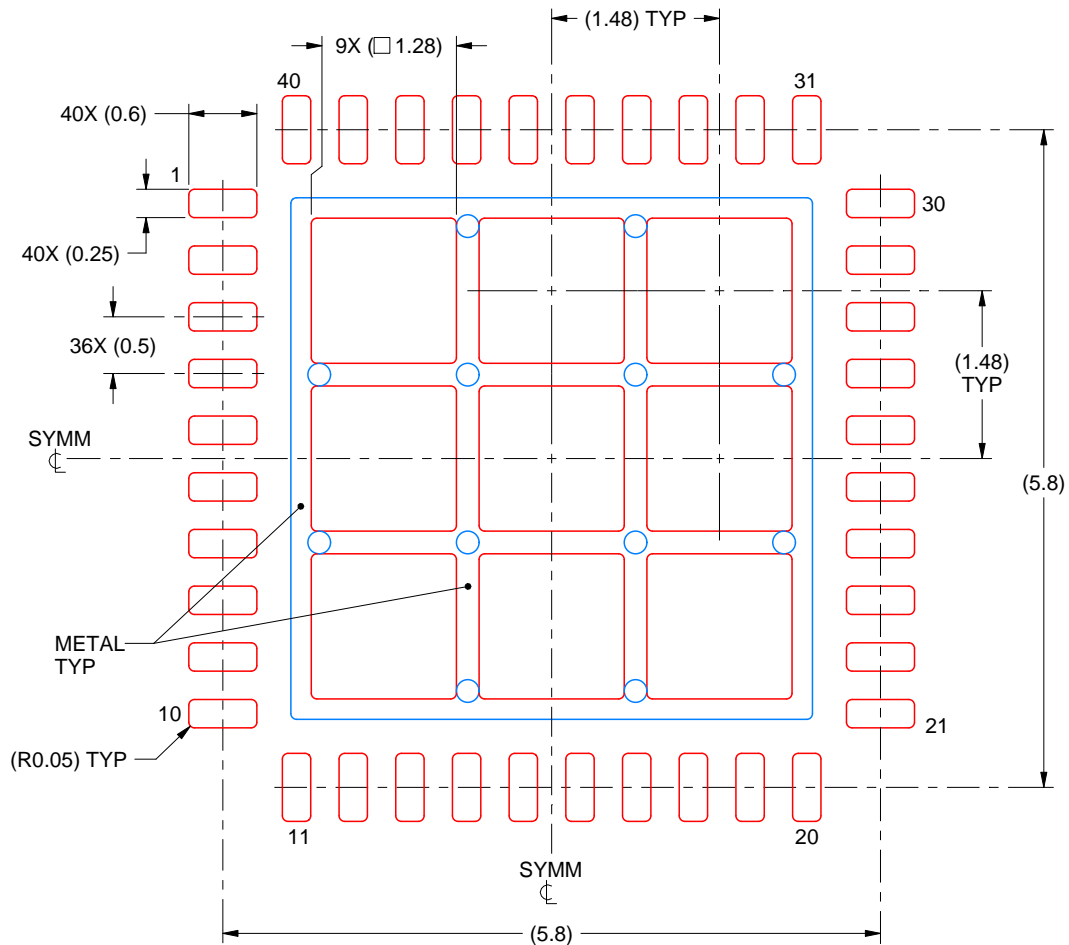

**SOLDER PASTE EXAMPLE**  
BASED ON 0.125 mm THICK STENCIL

EXPOSED PAD  
70% PRINTED SOLDER COVERAGE BY AREA  
SCALE:15X

4214989/B 02/2017

NOTES: (continued)

6. Laser cutting apertures with trapezoidal walls and rounded corners may offer better paste release. IPC-7525 may have alternate design recommendations.

## GENERIC PACKAGE VIEW

**RHS 48**

**WQFN - 0.8 mm max height**

7 x 7 mm, 0.5 mm pitch

PLASTIC QUAD FLATPACK - NO LEAD

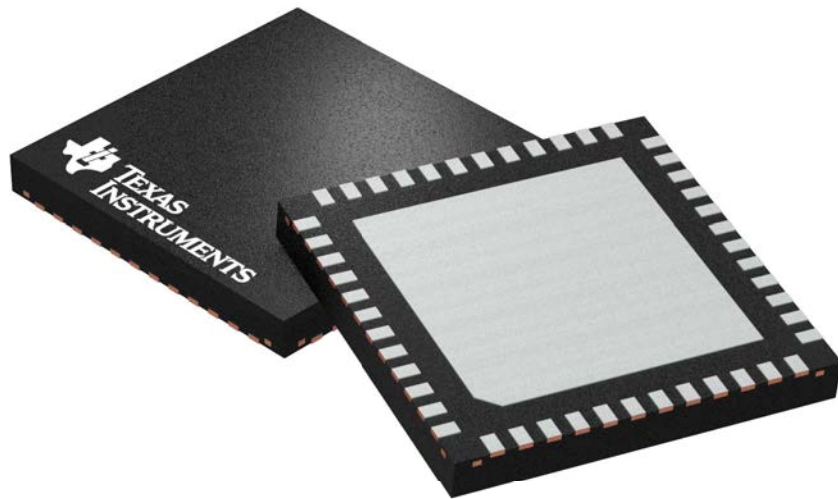

Images above are just a representation of the package family, actual package may vary.  
Refer to the product data sheet for package details.

4205855/C

## 重要声明和免责声明

TI“按原样”提供技术和可靠性数据（包括数据表）、设计资源（包括参考设计）、应用或其他设计建议、网络工具、安全信息和其他资源，不保证没有瑕疵且不做任何明示或暗示的担保，包括但不限于对适销性、某特定用途方面的适用性或不侵犯任何第三方知识产权的暗示担保。

这些资源可供使用 TI 产品进行设计的熟练开发人员使用。您将自行承担以下全部责任：(1) 针对您的应用选择合适的 TI 产品，(2) 设计、验证并测试您的应用，(3) 确保您的应用满足相应标准以及任何其他功能安全、信息安全、监管或其他要求。

这些资源如有变更，恕不另行通知。TI 授权您仅可将这些资源用于研发本资源所述的 TI 产品的应用。严禁对这些资源进行其他复制或展示。您无权使用任何其他 TI 知识产权或任何第三方知识产权。您应全额赔偿因在这些资源的使用中对 TI 及其代表造成的任何索赔、损害、成本、损失和债务，TI 对此概不负责。

TI 提供的产品受 [TI 的销售条款](#) 或 [ti.com](#) 上其他适用条款/TI 产品随附的其他适用条款的约束。TI 提供这些资源并不会扩展或以其他方式更改 TI 针对 TI 产品发布的适用的担保或担保免责声明。

TI 反对并拒绝您可能提出的任何其他或不同的条款。

邮寄地址：Texas Instruments, Post Office Box 655303, Dallas, Texas 75265

Copyright © 2022，德州仪器 (TI) 公司