

采用 SC70 封装、具有内部增益和滤波器的 3 V 视频放大器

查询样品: [OPA361-Q1](#)

特性

- 符合汽车应用要求
 - 出色的视频性能
 - 内部增益: **5.2V/V**
 - 支持电视检测
 - 与 **OMAP242x** 及达芬奇 (**DAVINCI™**) 处理器兼容
 - **2** 极重建滤波器
 - 输入范围包括接地
 - **DC** 耦合输入
 - 集成型电平转换器
 - **DC** 耦合输出⁽¹⁾
 - 无需输出电容器
 - 轨至轨输出
 - 低静态电流: **5.3mA**
 - 关断电流: **1.5μA**
 - 单电源: **2.5 V 至 3.3 V**
 - **SC70-6** 封装: **2.0 毫米 × 2.1 毫米**
 - 符合 **RoHS** 标准
- (1) 内部电路系统可避免输出饱和, 即便是输入视频信号提供 0 V 同步脉冲幅度也是如此。

说明

OPA361-Q1 高速放大器针对 3 V 便携式视频应用进行了优化。它经过精心设计, 与德州仪器 (TI) OMAP2420 及达芬奇处理器或支持 $0.5 V_{PP}$ 视频输出的其它应用处理器中嵌入的视频编码器兼容。输入共模范围涵盖 GND, 这使视频数模转换器 (DAC) 能够与 OPA361-Q1 实现 DC 耦合。电视检测特性可通过协助实现视频传输的自动启动 / 停止来大幅简化最终用户接口。

5mV 内的 GND 输出摆幅, 250mV v+ 支持标准反向端接负载 (150Ω)。内部电平转换可防止输出出现 0V 输出饱和, 从而可在通用视频电路中防止同步脉冲削波。因此, OPA361-Q1 是 DC 耦合视频负载的理想选择。

OPA361-Q1 高度集成内部增益设置电阻器 ($G = 5.2V/V$) 与 2 极视频 DAC 重建滤波器, 针对空间狭小的应用进行了优化。

在关断模式下, 静态电流可降至 $1.5\mu A$ 以下, 从而可显著降低功耗, 延长电池使用寿命。

OPA361-Q1 采用微小型 2 毫米 × 2.1 毫米 SC70-6 封装。

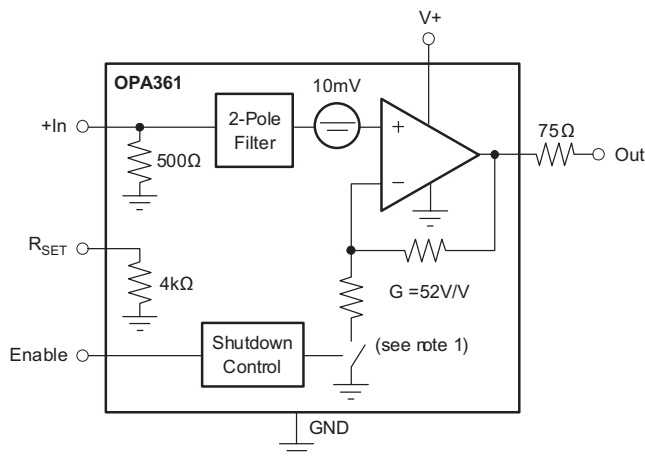

(1) 在正常工作下启动时关闭; 关断时打开。



Please be aware that an important notice concerning availability, standard warranty, and use in critical applications of Texas Instruments semiconductor products and disclaimers thereto appears at the end of this data sheet.

OPA361-Q1

ZHCS081–3 月 2011 年

www.ti.com.cn

These devices have limited built-in ESD protection. The leads should be shorted together or the device placed in conductive foam during storage or handling to prevent electrostatic damage to the MOS gates.

ORDERING INFORMATION⁽¹⁾

| PRODUCT | PACKAGE | PACKAGE DESIGNATOR | PACKAGE MARKING |
|-----------|---------|--------------------|-----------------|
| OPA361-Q1 | SC70-6 | DCK | QXP |

- (1) For the most current package and ordering information, see the Package Option Addendum at the end of this datasheet, or see the TI website at www.ti.com.

PIN CONFIGURATION

DCK PACKAGE
(TOP VIEW)

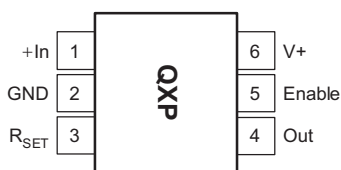

The location of pin 1 on the OPA361-Q1 is determined by orienting the package marking as shown in the diagram above.

ABSOLUTE MAXIMUM RATINGS⁽¹⁾

| | VALUE | UNIT |
|--|------------------------|--------------------|
| Supply voltage, V+ to V– | +3.6 | V |
| Signal input terminals | Voltage ⁽²⁾ | –0.5 to (V+) + 0.5 |
| | Current ⁽²⁾ | ±10 |
| Output short-circuit through 75Ω to GND ⁽³⁾ | Continuous | |
| Operating temperature | –40 to +125 | °C |
| Storage temperature | –65 to +150 | °C |
| Junction temperature | +160 | °C |

- (1) Stresses above these ratings may cause permanent damage. Exposure to absolute maximum conditions for extended periods may degrade device reliability. These are stress ratings only, and functional operation of the device at these or any other conditions beyond those specified is not implied.
- (2) Input terminals are diode-clamped to the power-supply rails. Input signals that can swing more than 0.5V beyond the supply rails should be current-limited to 10mA or less.
- (3) Short-circuit to ground.

ELECTRICAL CHARACTERISTICS: $V_S = +2.5V$ to $+3.3V$
Boldface limits apply over the temperature range, $T_A = -40^{\circ}C$ to $+125^{\circ}C$.

At $T_A = +25^{\circ}C$, $R_L = 150\Omega$ connected to GND, unless otherwise noted.

| PARAMETER | | TEST CONDITIONS | MIN | TYP | MAX | UNIT |
|---|---|---|------|-----------|----------|---------------|
| OFFSET LEVEL-SHIFT VOLTAGE | | | | | | |
| V_{OLS} | Output Level-Shift Voltage ⁽¹⁾ | $V_S = +2.8V$, $V_{IN} = GND$ | -3 | 11 | 55 | mV |
| Over Temperature | | | | 20 | | mV |
| PSRR | vs Power Supply | $V_S = +2.5V$ to $+3.3V$ | | ± 80 | | $\mu V/V$ |
| INPUT VOLTAGE RANGE | | | | | | |
| V_{CM} | Input Voltage Range ⁽²⁾ | $V_S = 2.5V$ | GND | | 0.42 | V |
| | | $V_S = 2.8V$ | GND | | 0.48 | V |
| | | $V_S = 3.3V$ | GND | | 0.55 | V |
| R_{IN} | Input Resistance (+In) | | 450 | 510 | 550 | Ω |
| R_{SET} | R_{SET} Resistance | | 3600 | 4070 | 4400 | Ω |
| Matching of R_{IN} and R_{SET} | | | 2% | 0.5% | | |
| VOLTAGE GAIN | | | | | | |
| | | $\Delta V_{OUT}/\Delta V_{IN}$, $V_S = +2.5V$, $V_{INMIN} = 0V$, $V_{INMAX} = 0.42V$ | 5.06 | 5.17 | 5.28 | V/V |
| | | $\Delta V_{OUT}/\Delta V_{IN}$, $V_S = +2.8V$, $V_{INMIN} = 0V$, $V_{INMAX} = 0.48V$ | 5.06 | 5.17 | 5.28 | V/V |
| | | $\Delta V_{OUT}/\Delta V_{IN}$, $V_S = +3.3V$, $V_{INMIN} = 0V$, $V_{INMAX} = 0.55V$ | 5.06 | 5.17 | 5.28 | V/V |
| FREQUENCY RESPONSE | | | | | | |
| Filter Response | | | | | | |
| f-3dB | Cutoff Frequency | | | 9 | | MHz |
| Normalized Gain: | $f_{IN} = 4.5MHz$ | $V_O = 2V_{PP}$ | | -0.1 | | dB |
| | $f_{IN} = 27MHz$ | $V_O = 2V_{PP}$ | | -18 | | dB |
| | $f_{IN} = 54MHz$ | $V_O = 2V_{PP}$ | | -23 | | dB |
| Differential Gain Error | | $R_L = 150\Omega$ | | 1.2% | | |
| Differential Phase Error | | $R_L = 150\Omega$ | | 1.6 | | degrees |
| Group Delay Variation | | 100kHz, 4.5MHz | | 26 | | ns |
| SNR | Signal-to-Noise Ratio | 100% White Signal | | 65 | | dB |
| OUTPUT | | | | | | |
| Positive Voltage Output Swing from Rail | | $V_S = +2.8V$, $V_{IN} = 0.7V$, Ω to GND | | 130 | 250 | mV |
| Negative Voltage Output Swing from Rail | | $V_S = +2.8V$, $V_{IN} = -0.05V$, $R_L = 150\Omega$ to GND | | 0.15 | 5 | mV |
| Positive Voltage Output Swing from Rail | | $V_S = +2.8V$, $V_{IN} = 0.7V$, $R_L = 75\Omega$ to GND | | 260 | | mV |
| Negative Voltage Output Swing from Rail | | $V_S = +2.8V$, $V_{IN} = -0.05V$, $R_L = 75\Omega$ to GND | | 2 | | mV |
| Output Leakage | | $V_S = +2.8V$, Disabled, $V_O = 2V$ | | 0.3 | 100 | nA |
| I_O | Output Current ⁽³⁾ | $V_S = +2.8V$ | | ± 80 | | mA |
| POWER SUPPLY | | | | | | |
| V_S | Specified Voltage Range | | 2.5 | | 3.3 | V |
| I_Q | Quiescent Current | $V_S = +2.8V$, Enabled, $I_O = 0$, $V_{OUT} = 1.4V$ | | 5.3 | 7.5 | mA |
| Over Temperature | | Specified Temperature Range | | | 9 | mA |
| ENABLE/SHUTDOWN FUNCTION | | | | | | |
| Disabled (logic-LOW threshold) | | | 0 | | 0.35 | V |
| Enabled (logic-HIGH threshold) | | | 1.3 | | V_S | V |
| Enable Time | | | | 1.5 | | μs |
| Disable Time | | | | 50 | | ns |
| Shutdown Current | | $V_S = +2.8V$, Disabled | | 1.5 | 3 | μA |
| TEMPERATURE RANGE | | | | | | |
| Specified/Operating Range | | | -40 | | +125 | $^{\circ}C$ |
| Storage Range | | | -65 | | +150 | $^{\circ}C$ |
| θ_{JA} | Thermal Resistance | | | | | |
| SC70 | | | | 250 | | $^{\circ}C/W$ |

(1) Output referred.

(2) Limited by output swing and internal $G = 5.2V/V$.

(3) See typical characteristics *Output Voltage Swing vs Output Current*.

TYPICAL CHARACTERISTICS: $V_S = 2.8\text{ V}$

At $T_A = +25^\circ\text{C}$ and $R_L = 150$, unless otherwise noted.

**R_{IN}
vs
TEMPERATURE**

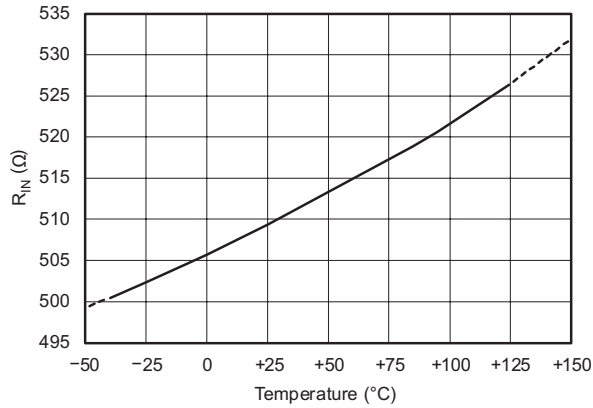

**R_{SET}
vs
TEMPERATURE**

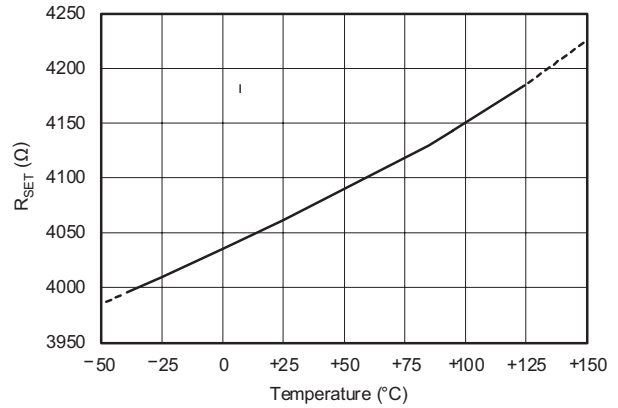

**R_{SET}/R_{IN} RATIO
vs
TEMPERATURE**

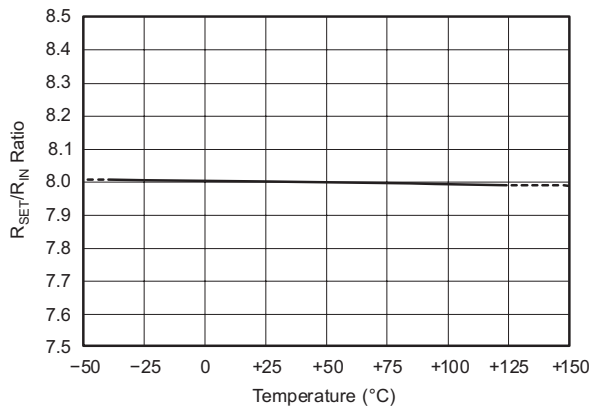

**GAIN
vs
TEMPERATURE**

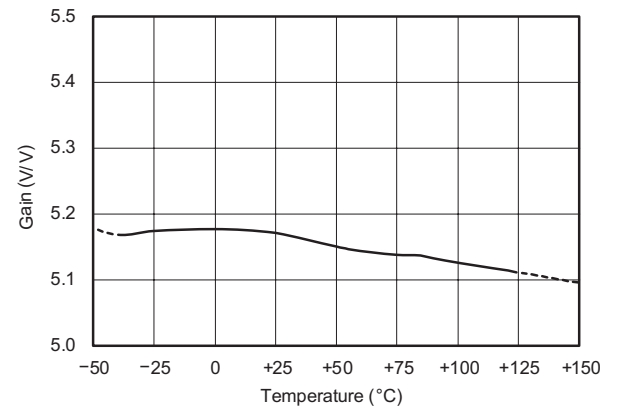

**OUTPUT VOLTAGE
vs
TEMPERATURE**

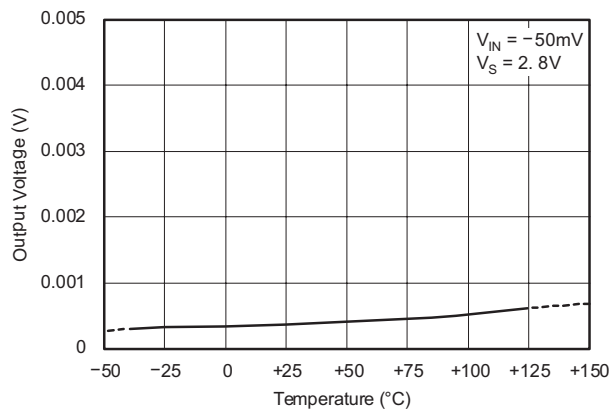

**OUTPUT VOLTAGE
vs
TEMPERATURE**

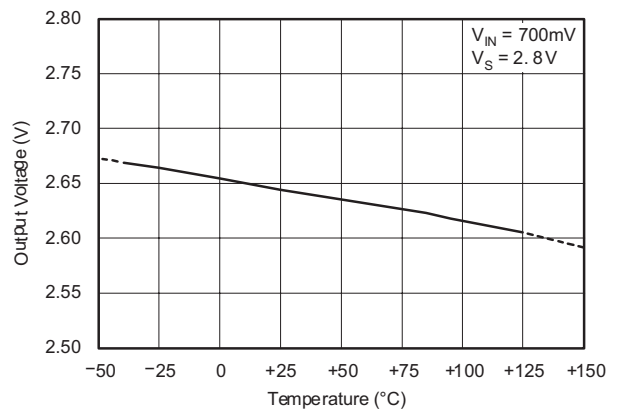

TYPICAL CHARACTERISTICS: $V_S = 2.8\text{ V}$ (continued)

At $T_A = +25^\circ\text{C}$ and $R_L = 150$, unless otherwise noted.

**V_{OUT} LEVEL SHIFT
vs
TEMPERATURE**

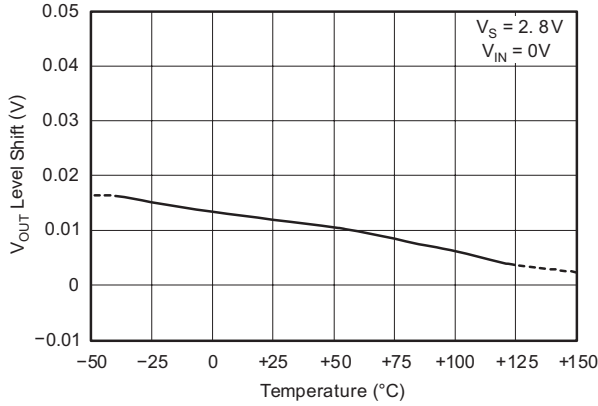

**QUIESCENT CURRENT
vs
TEMPERATURE**

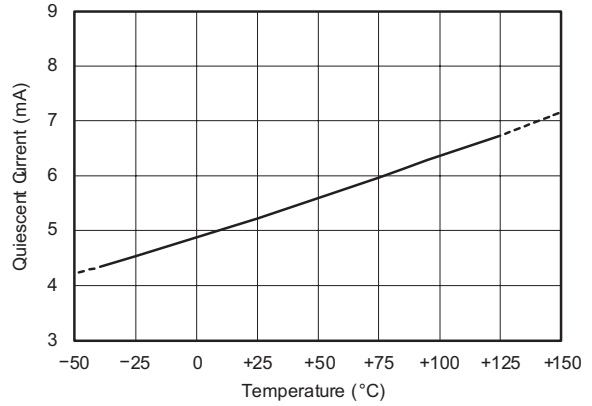

**OUTPUT LEAKAGE CURRENT
vs
TEMPERATURE**

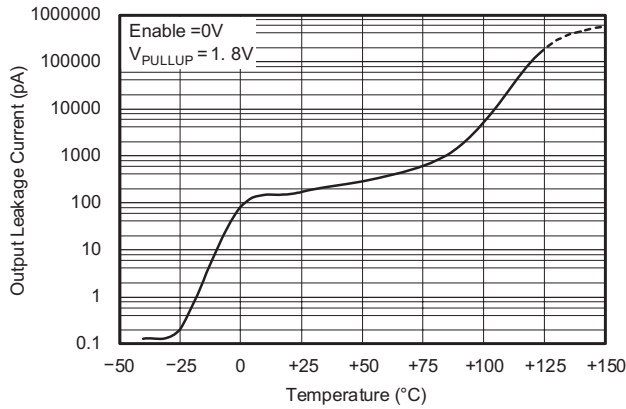

**OUTPUT LEAKAGE
vs
IN SHUTDOWN**

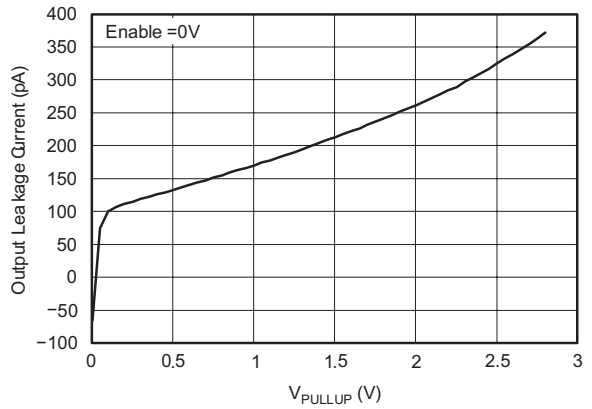

**SHUTDOWN QUIESCENT CURRENT HYSTERESIS
vs
TEMPERATURE**

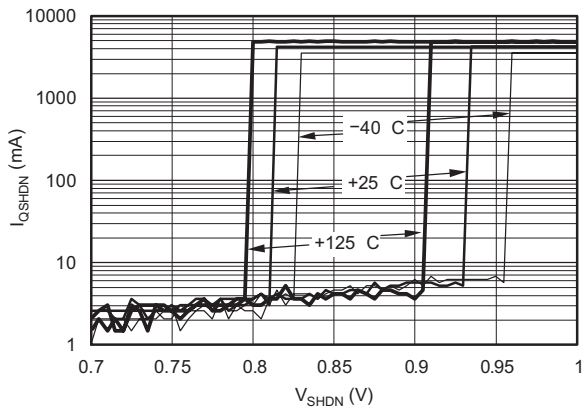

**AC RESPONSE
vs
AT VARIOUS TEMPERATURES**

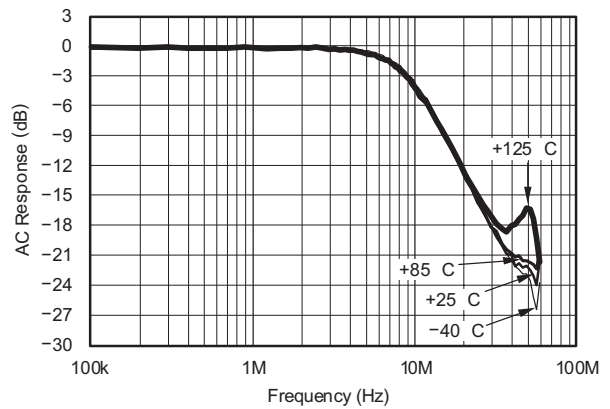

OPA361-Q1

ZHCS081-3月2011年

www.ti.com.cn

TYPICAL CHARACTERISTICS: $V_S = 2.8\text{ V}$ (continued)

At $T_A = +25^\circ\text{C}$ and $R_L = 150$, unless otherwise noted.

TURN-ON TIME

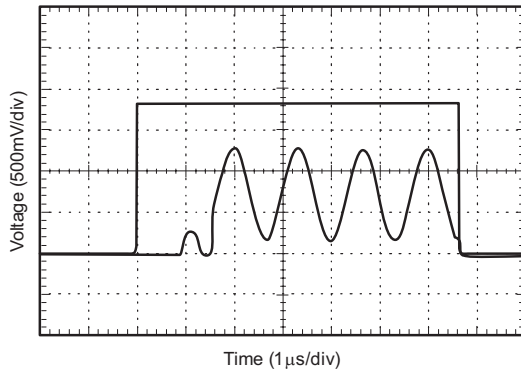

TURN-OFF TIME

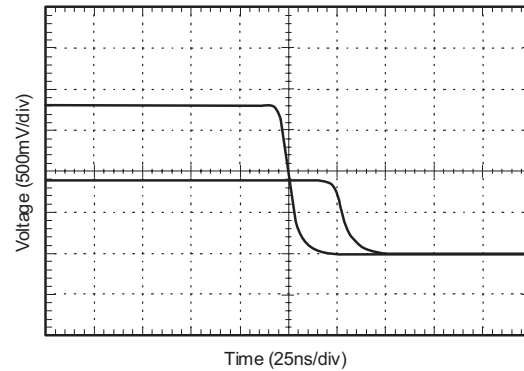

**OUTPUT VOLTAGE
vs
OUTPUT CURRENT**

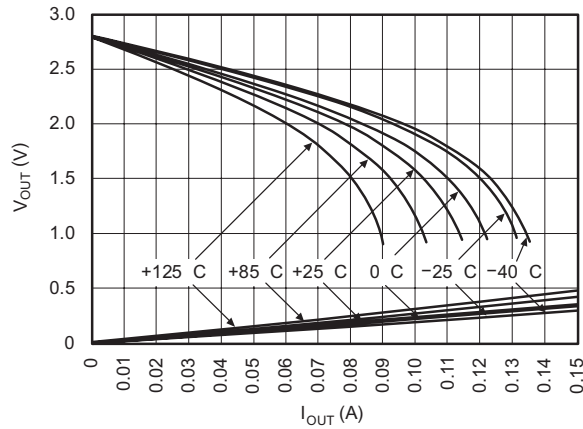

**GROUP DELAY
vs
FREQUENCY**

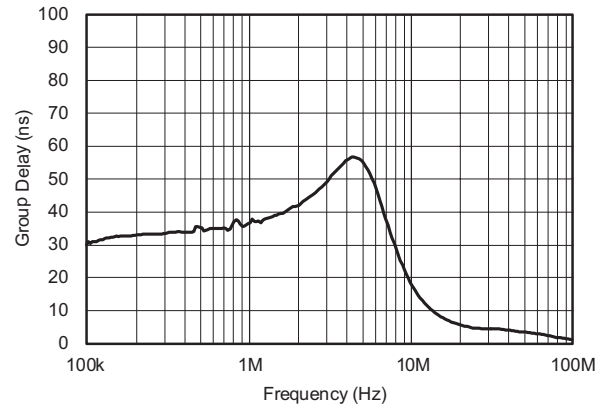

DIFFERENTIAL GAIN

| | | | | | | | | | |
|-------|-------|----|------|--------|-----|---------|-----|--------|-----|
| INP = | A | - | C | SYNC = | INT | MTIME = | 10s | LINE = | 330 |
| DG1 | -0.6 | %1 | | | | | | | |
| DG2 | -1.0 | % | | | | | | | |
| DG3 | -1.1 | % | | | | | | | |
| DG4 | -1.2 | % | | | | | | | |
| DG5 | -0.8 | %5 | | | | | | | |
| | STEPS | | ZOOM | MODE | | | | | |
| | 4 | 5 | 0 | 1 | 2 | 1 | | | |

DIFFERENTIAL PHASE

| | | | | | | | | | |
|--------|-------|-----|------|--------|-----|---------|-----|--------|-----|
| IN P = | A | - | C | SYNC = | INT | MTIME = | 10s | LINE = | 330 |
| DP1 | 1.1 | dg1 | | | | | | | |
| DP2 | 1.6 | dg | | | | | | | |
| DP3 | 1.6 | dg | | | | | | | |
| DP4 | 1.5 | dg | | | | | | | |
| DP5 | 1.1 | dg5 | | | | | | | |
| | STEPS | | ZOOM | MODE | | | | | |
| | 4 | 5 | 0 | 1 | 2 | 1 | | | |

APPLICATION INFORMATION

The OPA361-Q1 video amplifier has been optimized to fit seamlessly with Texas Instruments' OMAP242x Multimedia processor. The following features have been integrated to provide excellent video performance.

- Internal gain setting resistors ($G = 5.2V/V$) reduce the number of external components needed in the video circuit.
- Integration of the 500Ω video encoder load resistor and $4k\Omega$ RSET resistor used by the OMAP242x helps minimize the number of external components and also ensures excellent ratio and temperature tracking. This feature helps to keep the overall gain accurate and stable over temperature.
- TV-detection support in connection with an OMAP242x multimedia processor. This feature helps to automate start/stop operation of the TV-out function and minimizes power consumption.
- A 2-pole filter is incorporated for DAC signal reconstruction.
- The OPA361-Q1 employs an internal level shift circuit that avoids sync pulse clipping and allows DC-coupled output.
- A shutdown feature reduces quiescent current to less than $1.5\mu A$ —crucial for portable applications

Although OPA361-Q1 is optimized for the OMAP242x processor, it is also suitable to interface with any digital media processor that outputs a video signal on the order of $0.4V_{PP}$ to $0.5V_{PP}$.

Figure 1 shows a typical application drawing with the OMAP242x processor and the TWL92230 Energy Management Chip.

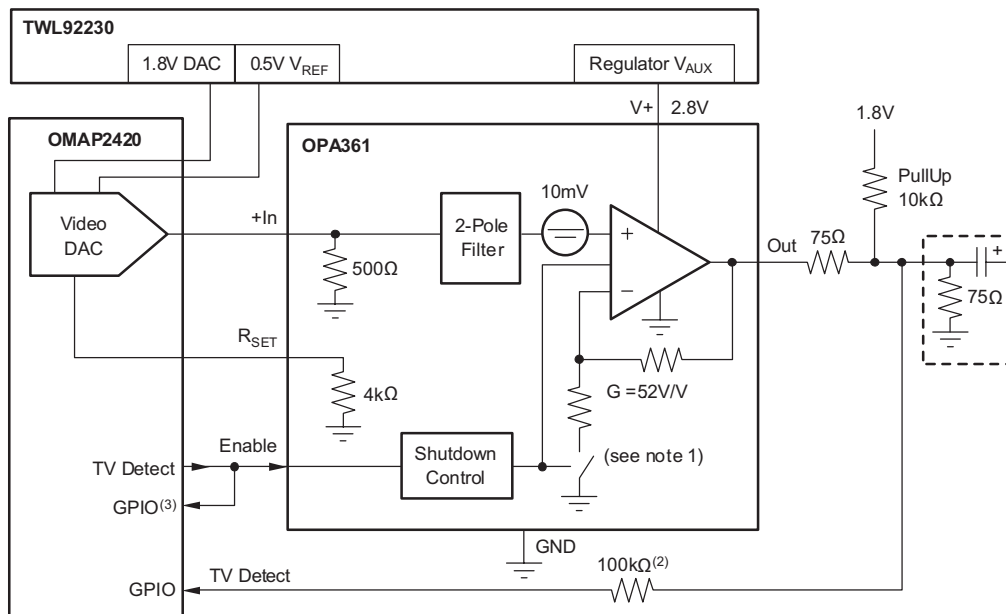

Figure 1. Typical Application using the OMAP242x and the TWL92230

OPERATING VOLTAGE

The OPA361-Q1 is fully specified from 2.5V to 3.3V over a temperature range of -40°C to $+125^{\circ}\text{C}$. Parameters that vary significantly with operating voltages or temperature are shown in the Typical Characteristics. Power-supply pins should be bypassed with 100nF ceramic capacitors.

INPUT VOLTAGE

The input common-mode range of the OPA361-Q1 series extends from GND to 0.55V on a 3.3V supply. The input range is limited by the internal gain in conjunction with the maximum output swing capability and the power-supply voltage.

INPUT OVERVOLTAGE PROTECTION

All OPA361-Q1 pins are static-protected with internal ESD protection diodes connected to the supplies. These diodes will provide input overdrive protection if the current is externally limited to 10mA.

ENABLE/SHUTDOWN

The OPA361-Q1 has a shutdown feature that disables the output and reduces the quiescent current to less than $1.5\mu\text{A}$. This feature is especially useful for portable video applications, where the device is infrequently connected to a television (TV) or other video device.

The Enable logic input voltage is referenced to the OPA361-Q1 GND pin. A logic level HIGH applied to the enable pin enables the op amp. The logic levels are compatible with 1.8V CMOS logic levels. A valid logic HIGH is defined as $> 1.3\text{V}$ above GND. A valid logic LOW is defined as $< 0.35\text{V}$ above GND. If the Enable pin is not connected, internal pull-up circuitry will enable the amplifier.

When disabling the OPA361-Q1, internal circuitry also disconnects the internal gain setting feedback. This feature is in support of the TV-detection function. See the *TV-Detect Function* section for more detailed information.

INTERNAL 2-POLE FILTER

The OPA361-Q1 filter is a Sallen-Key topology with a 9MHz cutoff frequency. [Figure 2](#) shows a detailed drawing of the filter components. This filter allows video signals to pass without any visible distortion, as shown in [Figure 3](#) through [Figure 6](#). The video encoder embedded in the OMAP242x processor typically samples at 54MHz. At this frequency, the attenuation is typically 23dB, which effectively attenuates the sampling aliases.

The internal 500Ω resistor on the input to GND converts the output current of the OMAP2420 internal video DAC into a voltage. It is also part of the Sallen-Key filter. Using an external resistor to adjust the input voltage range will also alter the filter characteristics.

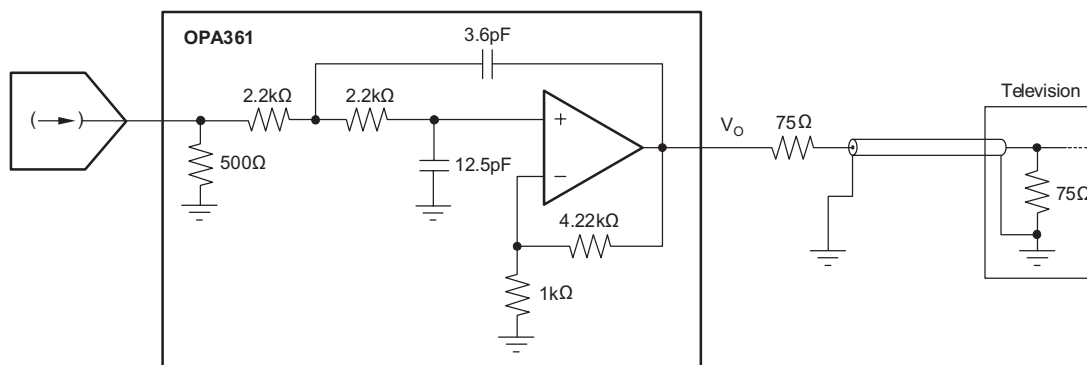

Figure 2. Filter Structure of the OPA361-Q1

Video Performance

The color bar signal in [Figure 3](#) shows excellent amplitude characteristics and no attenuation of colors with respect to the luminance signal.

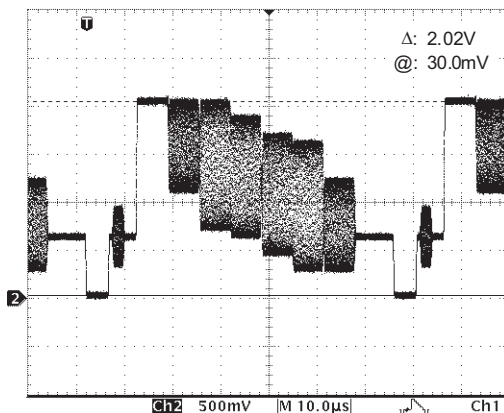

Figure 3. 100/75 Color Bar Signal at Output of OPA361-Q1

The CCIR330/5 test pattern requires one of the greatest dynamic ranges, and therefore tests the OPA361-Q1 output voltage swing capability. The scope plot shown in [Figure 4](#) has been taken with a 2.8V supply and shows no clipping on the top side of the signal.

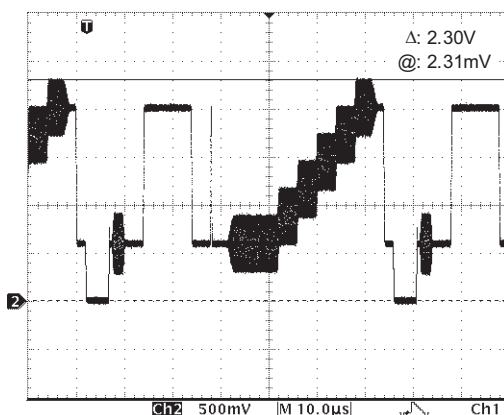

Figure 4. CCIR330/5: No Clipping, Even On 2.8V Supply

The multiburst test patterns have different sine-wave burst sections with the following frequencies: 0.5MHz, 1MHz, 2MHz, 4MHz, 4.8MHz and 5.8MHz with 420mVPP. There is no visible attenuation even at the highest frequencies, which indicates a very flat frequency response of the OPA361-Q1. As shown in [Figure 5](#) and [Figure 6](#), the top line illustrates the full signal and the bottom line is a more detailed view of the last three sine wave bursts.

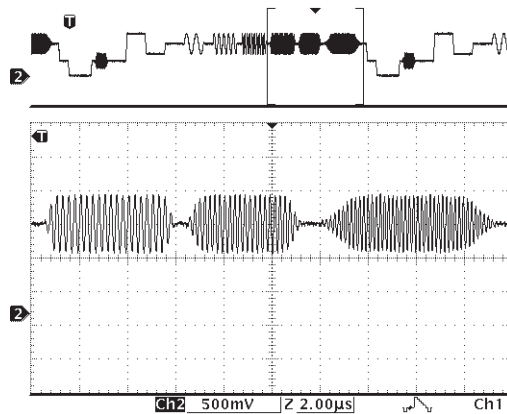

Figure 5. Multiburst Signal (CCIR 18/1) Shows Very Flat Frequency Response

The CCIR17 test pattern contains a 2T and a 20T pulse, as shown in [Figure 6](#). The 2T pulse is used to check for pulse distortion and reflection, and the 20T pulse is used to check for amplitude and group delay between chrominance and luminance. Neither pulse exhibits any distortion or group delay artifacts.

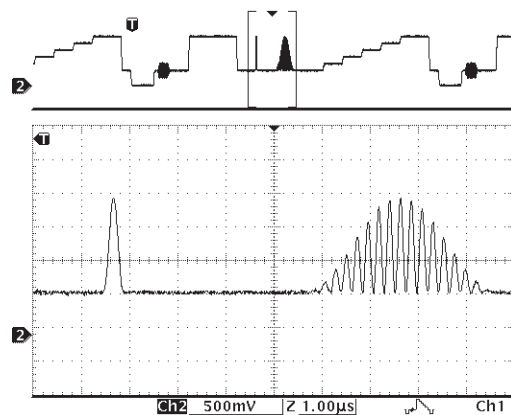

Figure 6. CCIR 17 2T and 20T Pulses Show No Visible Distortion

INTERNAL LEVEL SHIFT

Many common video DACs embedded in digital media processors, like the new OMAP242x processors, operate on a single supply (no negative supply). Typically, the lowest point of the sync pulse output by these video DACs is close to 0V. With a 0V input, the output of a common single-supply op amp saturates at a voltage > 0V. This effect would clip the sync pulse, and therefore degrade the video signal integrity. The OPA361-Q1 employs an internal level shift circuit to avoid clipping. The input signal is typically shifted by approximately 11mV. This shift is well within the linear output voltage range of the OPA361-Q1 with a standard 150Ω video load.

Output Swing Capability

[Figure 7](#) shows the true output swing capability of the OPA361-Q1 by taking the tip of the input sync pulse to a slightly negative voltage. Even when the output sync tip is at 3mV, the output after the 75Ω series termination still shows no clipping of the sync pulse.

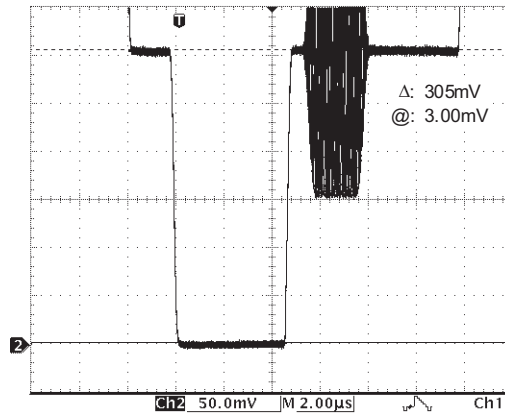

Figure 7. No Clipping of the Sync Pulse

TV-Detect Function

The TV-detection feature of the OPA361-Q1 works in conjunction with the OMAP242x (or other processors) to detect if a television is connected to the video output of the device. In order to detect a TV load, the OPA361-Q1 is briefly turned off, ideally during the first vertical sync pulse. For the detection, a simple pull-up resistor to the processor logic supply is used on the output of the OPA361-Q1. The voltage level is pulled LOW if the TV (or other video equipment) is connected, or HIGH if nothing is connected. A GPIO in the processor can be used to read this logic level and decide if a video load is connected. Figure 8 shows a scope plot with the TV disconnected and Figure 9 shows a scope plot with the TV connected; the upper line in both figures is the disable pulse. Figure 10 shows a circuit drawing using the TV-detect signal to disable or enable the OPA361-Q1.

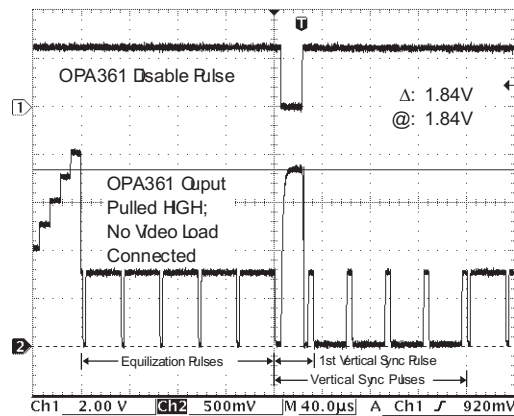

Figure 8. Output of OPA361-Q1 Pulled Up To 1.8V During Disable: TV Disconnected

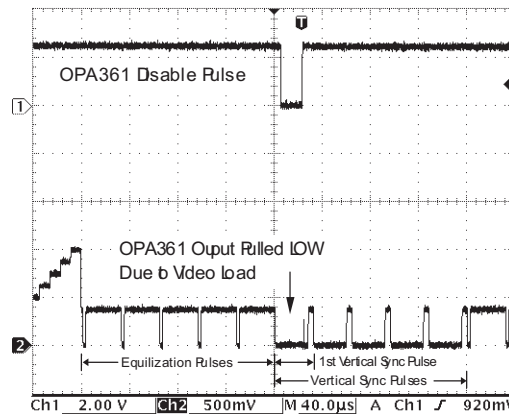

Figure 9. Output of OPA361-Q1 Pulled Down: TV Connected.

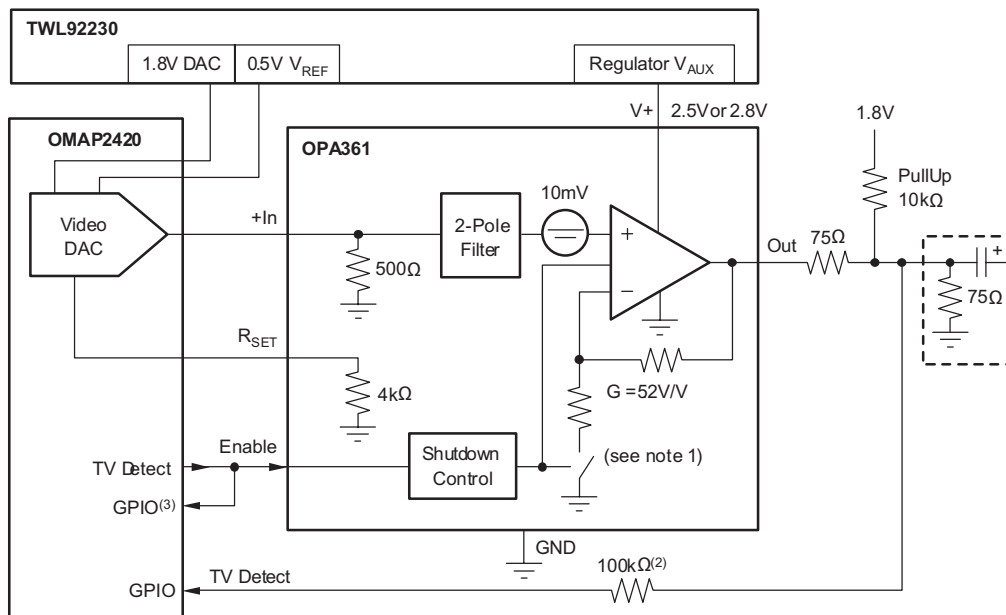

Figure 10. Using TV-Detect Signal to Disable/Enable the OPA361-Q1

Disabling the OPA361-Q1 also disconnects the internal feedback resistors' path to GND, and therefore there is no current flowing from the logic supply through the pull-up resistor to GND if no video load is connected; this helps to conserve battery life. The typical leakage when the output is pulled high and OPA361-Q1 is disabled is only about 300pA.

The following functionality can be achieved by implementing TV-detection:

- Automatic video start by polling the video line periodically.
- Automatic video stop if the TV (or other equipment) is disconnected.

Proper implementation allows to significantly simplify the user interface.

For more information, see Application Report SBOA109, *OPA361-Q1 and TV Detection*, available for download at www.ti.com.

重要声明

德州仪器 (TI) 及其下属子公司有权在不事先通知的情况下, 随时对所提供的产品和服务进行更正、修改、增强、改进或其它更改, 并有权随时中止提供任何产品和服务。客户在下订单前应获取最新的相关信息, 并验证这些信息是否完整且是最新的。所有产品的销售都遵循在订单确认时所提供的 TI 销售条款与条件。

TI 保证其所销售的硬件产品的性能符合 TI 标准保修的适用规范。仅在 TI 保修的范围内, 且 TI 认为有必要时才会使用测试或其它质量控制技术。除非政府做出了硬性规定, 否则没有必要对每种产品的所有参数进行测试。

TI 对应用帮助或客户产品设计不承担任何义务。客户应对其使用 TI 组件的产品和应用自行负责。为尽量减小与客户产品和应用相关的风险, 客户应提供充分的设计与操作安全措施。

TI 不对任何 TI 专利权、版权、屏蔽作品权或其它与使用了 TI 产品或服务的组合设备、机器、流程相关的 TI 知识产权中授予的直接或隐含权限作出任何保证或解释。TI 所发布的与第三方产品或服务有关的信息, 不能构成从 TI 获得使用这些产品或服务的许可、授权、或认可。使用此类信息可能需要获得第三方的专利权或其它知识产权方面的许可, 或是 TI 的专利权或其它知识产权方面的许可。

对于 TI 的数据手册或数据表, 仅在没有对内容进行任何篡改且带有相关授权、条件、限制和声明的情况下才允许进行复制。在复制信息的过程中对内容的篡改属于非法的、欺诈性商业行为。TI 对此类篡改过的文件不承担任何责任。

在转售 TI 产品或服务时, 如果存在对产品或服务参数的虚假陈述, 则会失去相关 TI 产品或服务的明示或暗示授权, 且这是非法的、欺诈性商业行为。TI 对此类虚假陈述不承担任何责任。

可访问以下 URL 地址以获取有关其它 TI 产品和应用解决方案的信息:

产品

| | |
|-------|---|
| 放大器 | http://www.ti.com.cn/amplifiers |
| 数据转换器 | http://www.ti.com.cn/dataconverters |
| DSP | http://www.ti.com.cn/dsp |
| 接口 | http://www.ti.com.cn/interface |
| 逻辑 | http://www.ti.com.cn/logic |
| 电源管理 | http://www.ti.com.cn/power |
| 微控制器 | http://www.ti.com.cn/microcontrollers |

应用

| | |
|-------|---|
| 音频 | http://www.ti.com.cn/audio |
| 汽车 | http://www.ti.com.cn/automotive |
| 宽带 | http://www.ti.com.cn/broadband |
| 数字控制 | http://www.ti.com.cn/control |
| 光纤网络 | http://www.ti.com.cn/opticalnetwork |
| 安全 | http://www.ti.com.cn/security |
| 电话 | http://www.ti.com.cn/telecom |
| 视频与成像 | http://www.ti.com.cn/video |
| 无线 | http://www.ti.com.cn/wireless |

邮寄地址: Texas Instruments, Post Office Box 655303, Dallas, Texas 75265
Copyright © 2006, Texas Instruments Incorporated

PACKAGING INFORMATION

| Orderable Device | Status (1) | Package Type | Package Drawing | Pins | Package Qty | Eco Plan (2) | Lead finish/ Ball material (6) | MSL Peak Temp (3) | Op Temp (°C) | Device Marking (4/5) | Samples |
|------------------|---------------|--------------|--------------------|------|----------------|-----------------|--------------------------------------|----------------------|--------------|-------------------------|---------|
| OPA361AQDCKRQ1 | ACTIVE | SC70 | DCK | 6 | 3000 | RoHS & Green | NIPDAU | Level-2-260C-1 YEAR | -40 to 125 | QXP | Samples |

(1) The marketing status values are defined as follows:

ACTIVE: Product device recommended for new designs.

LIFEBUY: TI has announced that the device will be discontinued, and a lifetime-buy period is in effect.

NRND: Not recommended for new designs. Device is in production to support existing customers, but TI does not recommend using this part in a new design.

PREVIEW: Device has been announced but is not in production. Samples may or may not be available.

OBSOLETE: TI has discontinued the production of the device.

(2) **RoHS:** TI defines "RoHS" to mean semiconductor products that are compliant with the current EU RoHS requirements for all 10 RoHS substances, including the requirement that RoHS substance do not exceed 0.1% by weight in homogeneous materials. Where designed to be soldered at high temperatures, "RoHS" products are suitable for use in specified lead-free processes. TI may reference these types of products as "Pb-Free".

RoHS Exempt: TI defines "RoHS Exempt" to mean products that contain lead but are compliant with EU RoHS pursuant to a specific EU RoHS exemption.

Green: TI defines "Green" to mean the content of Chlorine (Cl) and Bromine (Br) based flame retardants meet JS709B low halogen requirements of <=1000ppm threshold. Antimony trioxide based flame retardants must also meet the <=1000ppm threshold requirement.

(3) MSL, Peak Temp. - The Moisture Sensitivity Level rating according to the JEDEC industry standard classifications, and peak solder temperature.

(4) There may be additional marking, which relates to the logo, the lot trace code information, or the environmental category on the device.

(5) Multiple Device Markings will be inside parentheses. Only one Device Marking contained in parentheses and separated by a "-" will appear on a device. If a line is indented then it is a continuation of the previous line and the two combined represent the entire Device Marking for that device.

(6) Lead finish/Ball material - Orderable Devices may have multiple material finish options. Finish options are separated by a vertical ruled line. Lead finish/Ball material values may wrap to two lines if the finish value exceeds the maximum column width.

Important Information and Disclaimer: The information provided on this page represents TI's knowledge and belief as of the date that it is provided. TI bases its knowledge and belief on information provided by third parties, and makes no representation or warranty as to the accuracy of such information. Efforts are underway to better integrate information from third parties. TI has taken and continues to take reasonable steps to provide representative and accurate information but may not have conducted destructive testing or chemical analysis on incoming materials and chemicals. TI and TI suppliers consider certain information to be proprietary, and thus CAS numbers and other limited information may not be available for release.

In no event shall TI's liability arising out of such information exceed the total purchase price of the TI part(s) at issue in this document sold by TI to Customer on an annual basis.

DCK (R-PDSO-G6)

PLASTIC SMALL-OUTLINE PACKAGE

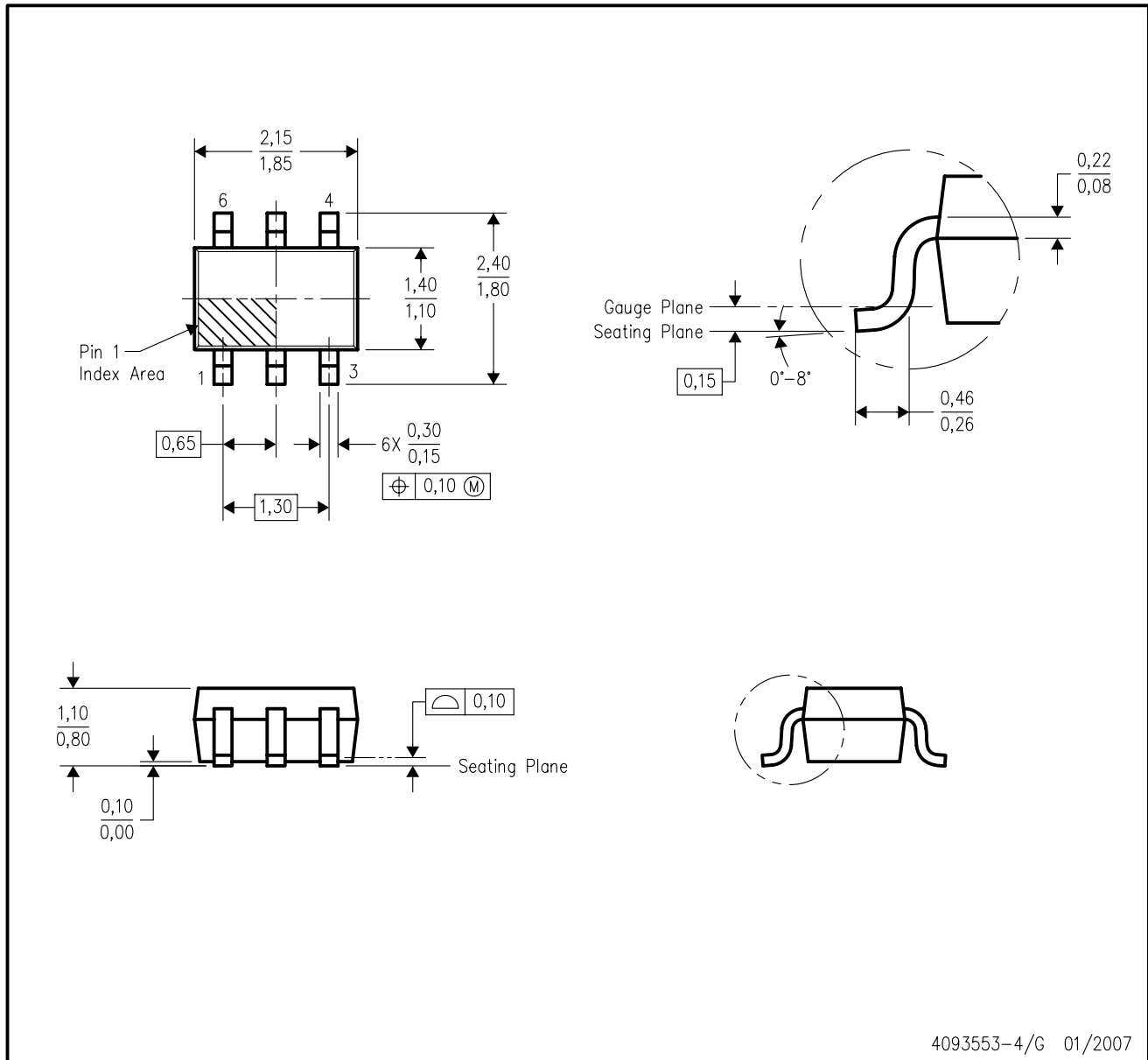

- NOTES:
- A. All linear dimensions are in millimeters.
 - B. This drawing is subject to change without notice.
 - C. Body dimensions do not include mold flash or protrusion. Mold flash and protrusion shall not exceed 0.15 per side.
 - D. Falls within JEDEC MO-203 variation AB.

DCK (R-PDSO-G6)

PLASTIC SMALL OUTLINE

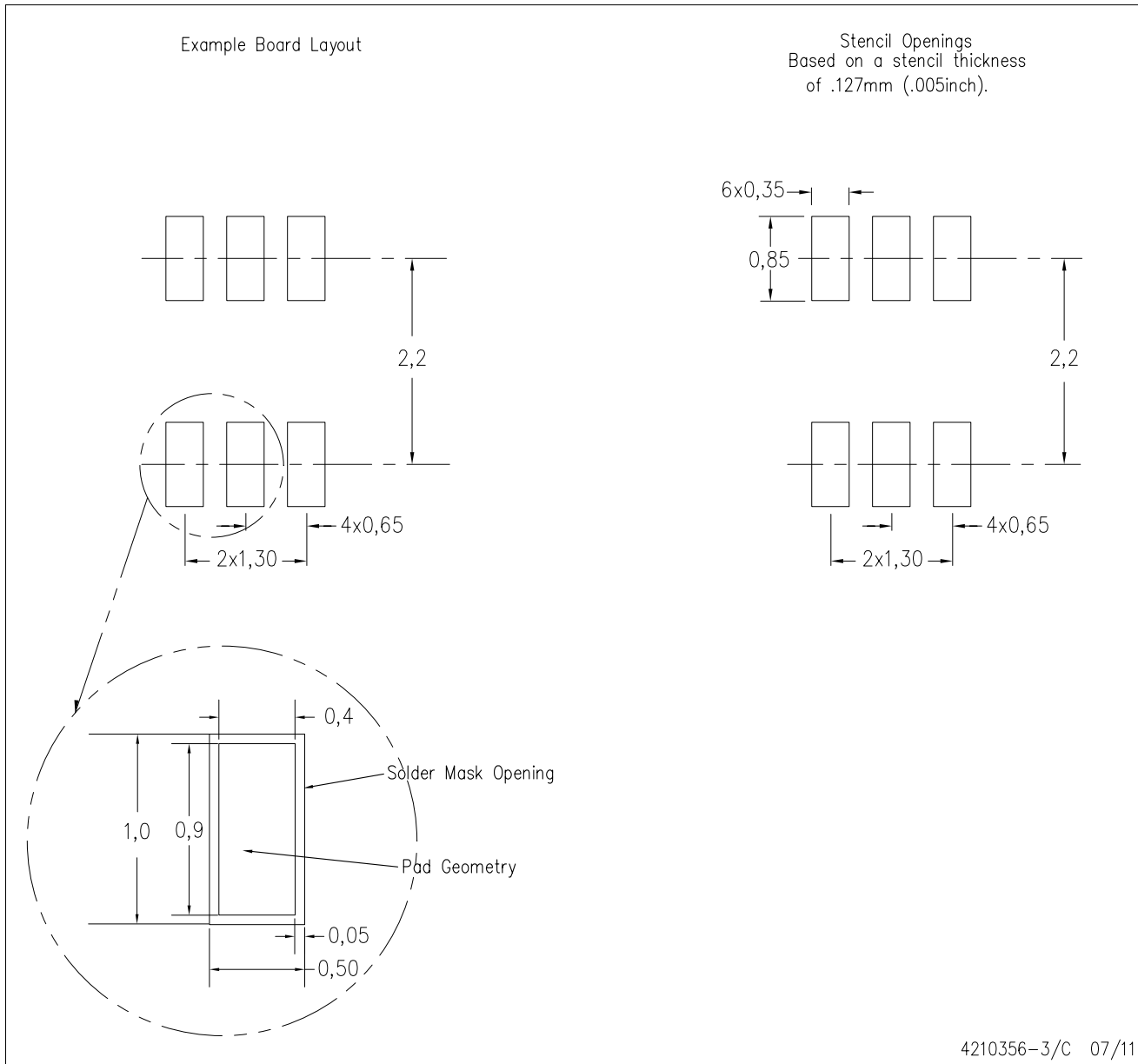

- NOTES:
- A. All linear dimensions are in millimeters.
 - B. This drawing is subject to change without notice.
 - C. Customers should place a note on the circuit board fabrication drawing not to alter the center solder mask defined pad.
 - D. Publication IPC-7351 is recommended for alternate designs.
 - E. Laser cutting apertures with trapezoidal walls and also rounding corners will offer better paste release. Customers should contact their board assembly site for stencil design recommendations. Example stencil design based on a 50% volumetric metal load solder paste. Refer to IPC-7525 for other stencil recommendations.

重要声明和免责声明

TI 均以“原样”提供技术性 & 可靠性数据（包括数据表）、设计资源（包括参考设计）、应用或其他设计建议、网络工具、安全信息和其他资源，不保证其中不含任何瑕疵，且不做任何明示或暗示的担保，包括但不限于对适销性、适合某特定用途或不侵犯任何第三方知识产权的暗示担保。

所述资源可供专业开发人员应用 TI 产品进行设计使用。您将对以下行为独自承担全部责任：(1) 针对您的应用选择合适的 TI 产品；(2) 设计、验证并测试您的应用；(3) 确保您的应用满足相应标准以及任何其他安全、安保或其他要求。所述资源如有变更，恕不另行通知。TI 对您使用所述资源的授权仅限于开发资源所涉及 TI 产品的相关应用。除此之外不得复制或展示所述资源，也不提供其它 TI 或任何第三方的知识产权授权许可。如因使用所述资源而产生任何索赔、赔偿、成本、损失及债务等，TI 对此概不负责，并且您须赔偿由此对 TI 及其代表造成的损害。

TI 所提供产品均受 TI 的销售条款 (<http://www.ti.com.cn/zh-cn/legal/termsofsale.html>) 以及 [ti.com.cn](http://www.ti.com.cn) 上或随附 TI 产品提供的其他可适用条款的约束。TI 提供所述资源并不扩展或以其他方式更改 TI 针对 TI 产品所发布的可适用的担保范围或担保免责声明。

邮寄地址：上海市浦东新区世纪大道 1568 号中建大厦 32 楼，邮政编码：200122
Copyright © 2020 德州仪器半导体技术（上海）有限公司