

300MHz 至 4GHz 正交调制器

 查询样品: [TRF37T05](#)

特性

- 高度线性:
 - 输出 IP3: 1850MHz 时为 30dBm
- 低输出噪声底: -160dBm/Hz
- 通道功率为 -10dBm 时 78dBc 单载波宽带码分多址 (WCDMA) 邻信道功率比 (ACPR)
- 未调节的载波抑制: -40dBm
- 未调节的边频带抑制: -45dBc
- 单电源: 3.3V 运行
- 1 位增益步长控制
- 快速加电/断电

应用范围

- 蜂窝基站发射器
- **CDMA: IS95, UMTS, CDMA2000, TD-SCDMA**
- **LTE (长期演进), TD-LTE**
- **TDMA: GSM, EDGE/UWC-136**
- 多载波 **GSM (MC-GSM)**
- 无线 (城域网) 宽带转发器

说明

TRF37T05 是一款低噪声直接正交调制器, 此调制器具有出色的时分双工 (TDD) 性能。它能够将复杂已调制信号从基带或中频 (IF) 直接转换为射频 (RF)。

TRF37T05 是一款高性能、出色线性器件, 此器件非常适合于向上变频为 300MHz 的 RF 频率。⁽¹⁾ 至 4GHz 范围内的最佳性能。此调制器被执行为一个双平衡混频器。

RF 输出块包含一个差分至单端转换器, 此转换器能够驱动一个单端 50Ω 负载。TRF37T05 需要一个 0.25V 共模电压以实现最佳的线性性能。TRF37T05 还提供一个快速断电引脚, 此引脚可被用来减少功率耗散, 而同时在 TDD 应用中保持已优化的已调载波馈通性能。

TRF37T05 采用 RGE-24 超薄四方扁平无引线 (VQFN) 封装。

(1) 需要合适的匹配网络以实现 300MHz

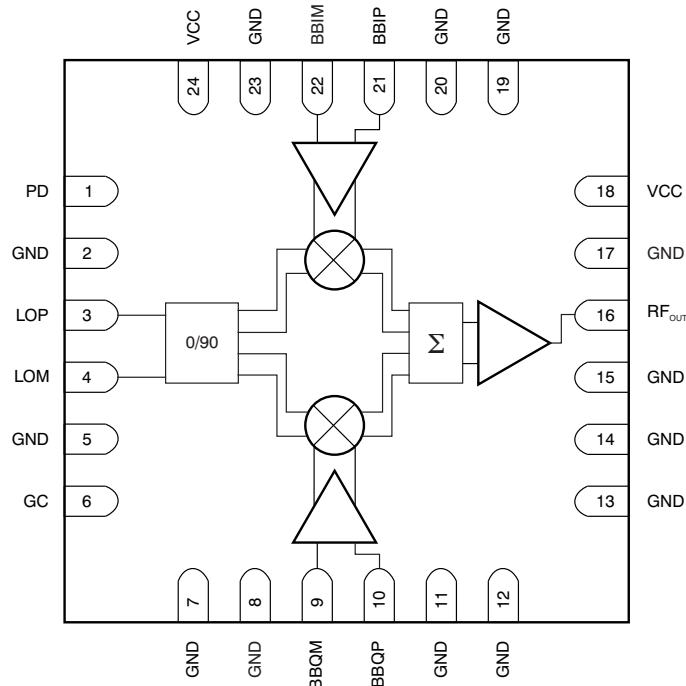

Please be aware that an important notice concerning availability, standard warranty, and use in critical applications of Texas Instruments semiconductor products and disclaimers thereto appears at the end of this data sheet.

PowerPAD is a trademark of Texas Instruments.

All other trademarks are the property of their respective owners.

PRODUCTION DATA information is current as of publication date. Products conform to specifications per the terms of the Texas Instruments standard warranty. Production processing does not necessarily include testing of all parameters.



This integrated circuit can be damaged by ESD. Texas Instruments recommends that all integrated circuits be handled with appropriate precautions. Failure to observe proper handling and installation procedures can cause damage.

ESD damage can range from subtle performance degradation to complete device failure. Precision integrated circuits may be more susceptible to damage because very small parametric changes could cause the device not to meet its published specifications.

For the most current package and ordering information, see the Package Option Addendum at the end of this document, or see the device product folder at www.ti.com

ABSOLUTE MAXIMUM RATINGS⁽¹⁾

Over operating free-air temperature range (unless otherwise noted).

	MIN	MAX	UNIT
Supply voltage range ⁽²⁾	-0.3	6	V
Digital I/O voltage range	-0.3	V _{CC} +0.5	V
Operating virtual junction temperature range, T _J	-40	150	°C
Operating ambient temperature range, T _A	-40	85	°C
Storage temperature range, T _{stg}	-65	150	°C
ESD ratings	Human body model, HBM	4000	V
	Charged device model, CDM	250	V
	Machine model, MM	200	V

(1) Stresses beyond those listed under *absolute maximum ratings* may cause permanent damage to the device. These are stress ratings only, and functional operation of the device at these or any other conditions beyond those indicated under *recommended operating conditions* is not implied. Exposure to absolute-maximum-rated conditions for extended periods may affect device reliability.

(2) All voltage values are with respect to network ground terminal.

RECOMMENDED OPERATING CONDITIONS

Over operating free-air temperature range (unless otherwise noted).

	MIN	NOM	MAX	UNIT
V _{CC} Power-supply voltage	3.15	3.3	3.6	V

THERMAL INFORMATION

THERMAL METRIC		TRF37T05	UNITS
		RGE (VQFN)	
		24 PINS	
θ _{JA}	Junction-to-ambient thermal resistance	38.4	°C/W
θ _{JCtop}	Junction-to-case (top) thermal resistance	42.5	
θ _{JB}	Junction-to-board thermal resistance	16.6	
ψ _{JT}	Junction-to-top characterization parameter	0.9	
ψ _{JB}	Junction-to-board characterization parameter	16.6	
θ _{JCbot}	Junction-to-case (bottom) thermal resistance	6.6	

ELECTRICAL CHARACTERISTICS: GENERAL

 Over recommended operating conditions; at power supply = 3.3 V and $T_A = 25^\circ\text{C}$, unless otherwise noted.

PARAMETERS		TEST CONDITIONS	MIN	TYP	MAX	UNIT
DC PARAMETERS						
I_{CC}	Total supply current	$T_A = 25^\circ\text{C}$, device on (PD = low)		306		mA
		$T_A = 25^\circ\text{C}$, device off (PD = high)		146		mA
LO INPUT						
f_{LO}	LO low frequency			300		MHz
	LO high frequency			4000		MHz
	LO input power		-10	0	+15	dBm
BASEBAND INPUTS						
V_{CM}	I and Q input dc common-mode voltage			0.25	0.5	V
BW	1-dB input frequency bandwidth			1000		MHz
Z_I	Input impedance	Resistance		8		k Ω
		Parallel capacitance		4.6		pF
POWER ON/OFF						
	Turn on time	PD = low to 90% final output power		0.2		μs
	Turn off time	PD = high to initial output power -30 dB		0.2		μs
DIGITAL INTERFACE						
V_{IH}	PD high-level input voltage		2			V
V_{IL}	PD low-level input voltage				0.8	V

ELECTRICAL CHARACTERISTICS

Over recommended operating conditions; at power supply = 3.3 V, $T_A = 25^\circ\text{C}$, $V_{CM} = 0.25\text{ V}$; LO Power = 0 dBm, single-ended (LOP); GC set low, $V_{IN\ BB} = 1\text{ V}_{PP}$ (diff) in quadrature, and $f_{BB} = 5.5\text{ MHz}$, standard broadband output matching circuit, unless otherwise noted.

PARAMETERS		TEST CONDITIONS	MIN	TYP	MAX	UNIT
$f_{LO} = 400\text{ MHz}$						
G	Voltage gain	Output RMS voltage over input I (or Q) RMS voltage, GC set low		-4.7		dB
		Output RMS voltage over input I (or Q) RMS voltage, GC set high		-1.9		dB
P _{OUT}	Output power	GC set low		-0.7		dBm
		GC set high		2.1		dBm
P1dB	Output compression point	GC set low		8.5		dBm
		GC set high		9.1		dBm
IP3	Output IP3	$f_{BB1} = 4.5\text{ MHz}$; $f_{BB2} = 5.5\text{ MHz}$; GC set low		26		dBm
		$f_{BB1} = 4.5\text{ MHz}$; $f_{BB2} = 5.5\text{ MHz}$; GC set high		25.4		dBm
IP2	Output IP2	Measured at $f_{LO} + (f_{BB1} \pm f_{BB2})$, GC set low		60.2		dBm
		Measured at $f_{LO} + (f_{BB1} \pm f_{BB2})$, GC set high		61.9		dBm
SBS	Unadjusted sideband suppression			-57.4		dBc
CF	Unadjusted carrier feedthrough	Measured at LO frequency		-51.6		dBm
		Measured at 2 x LO		-50		dBm
		Measured at 3 x LO		-49		dBm
	Output noise floor	DC only to BB inputs; 10-MHz offset from LO		-166.7		dBm/Hz
HD2 _{BB}	Baseband harmonics	Measured with $\pm 1\text{-MHz}$ tone at 0.5 V_{PP} each at $f_{LO} \pm (2 \times f_{BB})$		-67		dBc
HD3 _{BB}	Baseband harmonics	Measured with $\pm 1\text{-MHz}$ tone at 0.5 V_{PP} each at $f_{LO} \pm (3 \times f_{BB})$		-64		dBc
$f_{LO} = 750\text{ MHz}$						
G	Voltage gain	Output RMS voltage over input I (or Q) RMS voltage, GC set low		0.2		dB
		Output RMS voltage over input I (or Q) RMS voltage, GC set high		3		dB
P _{OUT}	Output power	GC set low		4.2		dBm
		GC set high		7		dBm
P1dB	Output compression point	GC set low		13.3		dBm
		GC set high		13.9		dBm
IP3	Output IP3	$f_{BB1} = 4.5\text{ MHz}$; $f_{BB2} = 5.5\text{ MHz}$; GC set low		31.5		dBm
		$f_{BB1} = 4.5\text{ MHz}$; $f_{BB2} = 5.5\text{ MHz}$; GC set high		30.8		dBm
IP2	Output IP2	Measured at $f_{LO} + (f_{BB1} \pm f_{BB2})$, GC set low		73.6		dBm
		Measured at $f_{LO} + (f_{BB1} \pm f_{BB2})$, GC set high		80.5		dBm
SBS	Unadjusted sideband suppression			-45.2		dBc
CF	Unadjusted carrier feedthrough	Measured at LO frequency		-45.7		dBm
		Measured at 2 x LO		-46		dBm
		Measured at 3 x LO		-53.5		dBm
	Output noise floor	DC only to BB inputs; 10-MHz offset from LO		-159.9		dBm/Hz
HD2 _{BB}	Baseband harmonics	Measured with $\pm 1\text{-MHz}$ tone at 0.5 V_{PP} each at $f_{LO} \pm (2 \times f_{BB})$		-70		dBc
HD3 _{BB}	Baseband harmonics	Measured with $\pm 1\text{-MHz}$ tone at 0.5 V_{PP} each at $f_{LO} \pm (3 \times f_{BB})$		-66		dBc

ELECTRICAL CHARACTERISTICS (continued)

Over recommended operating conditions; at power supply = 3.3 V, $T_A = 25^\circ\text{C}$, $V_{CM} = 0.25\text{ V}$; LO Power = 0 dBm, single-ended (LOP); GC set low, $V_{IN\ BB} = 1\text{ V}_{PP}$ (diff) in quadrature, and $f_{BB} = 5.5\text{ MHz}$, standard broadband output matching circuit, unless otherwise noted.

PARAMETERS		TEST CONDITIONS	MIN	TYP	MAX	UNIT
$f_{LO} = 900\text{ MHz}$						
G	Voltage gain	Output RMS voltage over input I (or Q) RMS voltage, GC set low		0.3		dB
		Output RMS voltage over input I (or Q) RMS voltage, GC set high		3.1		dB
P _{OUT}	Output power	GC set low		4.3		dBm
		GC set high		7.1		dBm
P1dB	Output compression point	GC set low		13.2		dBm
		GC set high		13.7		dBm
IP3	Output IP3	$f_{BB1} = 4.5\text{ MHz}$; $f_{BB2} = 5.5\text{ MHz}$; GC set low		31.7		dBm
		$f_{BB1} = 4.5\text{ MHz}$; $f_{BB2} = 5.5\text{ MHz}$; GC set high		30.9		dBm
IP2	Output IP2	Measured at $f_{LO} + (f_{BB1} \pm f_{BB2})$, GC set low		71.5		dBm
		Measured at $f_{LO} + (f_{BB1} \pm f_{BB2})$, GC set high		75.3		dBm
SBS	Unadjusted sideband suppression			-43.8		dBc
CF	Unadjusted carrier feedthrough	Measured at LO frequency		-48.5		dBm
		Measured at 2 x LO		-53		dBm
		Measured at 3 x LO		-50		dBm
	Output noise floor	DC only to BB inputs; 10-MHz offset from LO		-157.9		dBm/Hz
HD2 _{BB}	Baseband harmonics	Measured with $\pm 1\text{-MHz}$ tone at 0.5 V_{PP} each at $f_{LO} \pm (2 \times f_{BB})$		-80		dBc
HD3 _{BB}	Baseband harmonics	Measured with $\pm 1\text{-MHz}$ tone at 0.5 V_{PP} each at $f_{LO} \pm (3 \times f_{BB})$		-65		dBc
$f_{LO} = 1840\text{ MHz}$						
G	Voltage gain	Output RMS voltage over input I (or Q) RMS voltage, GC set low		-0.1		dB
		Output RMS voltage over input I (or Q) RMS voltage, GC set high		2.5		dB
P _{OUT}	Output power	GC set low		3.9		dBm
		GC set high		6.5		dBm
P1dB	Output compression point	GC set low		13.2		dBm
		GC set high		13.6		dBm
IP3	Output IP3	$f_{BB1} = 4.5\text{ MHz}$; $f_{BB2} = 5.5\text{ MHz}$; GC set low		32.1		dBm
		$f_{BB1} = 4.5\text{ MHz}$; $f_{BB2} = 5.5\text{ MHz}$; GC set high		30.3		dBm
IP2	Output IP2	Measured at $f_{LO} + (f_{BB1} \pm f_{BB2})$, GC set low		60.8		dBm
		Measured at $f_{LO} + (f_{BB1} \pm f_{BB2})$, GC set high		62		dBm
SBS	Unadjusted sideband suppression			-43.4		dBc
CF	Unadjusted carrier feedthrough	Measured at LO frequency		-42.4		dBm
		Measured at 2 x LO		-41		dBm
		Measured at 3 x LO		-53		dBm
	Output noise floor	DC only to BB inputs; 10-MHz offset from LO		-158.8		dBm/Hz
HD2 _{BB}	Baseband harmonics	Measured with $\pm 1\text{-MHz}$ tone at 0.5 V_{PP} each at $f_{LO} \pm (2 \times f_{BB})$		-69		dBc
HD3 _{BB}	Baseband harmonics	Measured with $\pm 1\text{-MHz}$ tone at 0.5 V_{PP} each at $f_{LO} \pm (3 \times f_{BB})$		-80		dBc

ELECTRICAL CHARACTERISTICS (continued)

Over recommended operating conditions; at power supply = 3.3 V, $T_A = 25^\circ\text{C}$, $V_{CM} = 0.25\text{ V}$; LO Power = 0 dBm, single-ended (LOP); GC set low, $V_{IN\ BB} = 1\text{ V}_{PP}$ (diff) in quadrature, and $f_{BB} = 5.5\text{ MHz}$, standard broadband output matching circuit, unless otherwise noted.

PARAMETERS		TEST CONDITIONS	MIN	TYP	MAX	UNIT
$f_{LO} = 2140\text{ MHz}$						
G	Voltage gain	Output RMS voltage over input I (or Q) RMS voltage, GC set low		0.1		dB
		Output RMS voltage over input I (or Q) RMS voltage, GC set high		2.9		dB
P_{OUT}	Output power	GC set low		4.1		dBm
		GC set high		6.9		dBm
P1dB	Output compression point	GC set low		13.1		dBm
		GC set high		13.5		dBm
IP3	Output IP3	$f_{BB1} = 4.5\text{ MHz}$; $f_{BB2} = 5.5\text{ MHz}$; GC set low		28.6		dBm
		$f_{BB1} = 4.5\text{ MHz}$; $f_{BB2} = 5.5\text{ MHz}$; GC set high		27.6		dBm
IP2	Output IP2	Measured at $f_{LO} + (f_{BB1} \pm f_{BB2})$, GC set low		65.5		dBm
		Measured at $f_{LO} + (f_{BB1} \pm f_{BB2})$, GC set high		68.2		dBm
SBS	Unadjusted sideband suppression			-45.6		dBc
CF	Unadjusted carrier feedthrough	Measured at LO frequency		-39.3		dBm
		Measured at 2 x LO		-37		dBm
		Measured at 3 x LO		-46		dBm
	Output noise floor	DC only to BB inputs; 10-MHz offset from LO		-160.0		dBm/Hz
HD2 _{BB}	Baseband harmonics	Measured with $\pm 1\text{-MHz}$ tone at 0.5 V_{PP} each at $f_{LO} \pm (2 \times f_{BB})$		-61		dBc
HD3 _{BB}	Baseband harmonics	Measured with $\pm 1\text{-MHz}$ tone at 0.5 V_{PP} each at $f_{LO} \pm (3 \times f_{BB})$		-60		dBc
$f_{LO} = 2600\text{ MHz}$						
G	Voltage gain	Output RMS voltage over input I (or Q) RMS voltage, GC set low		-0.8		dB
		Output RMS voltage over input I (or Q) RMS voltage, GC set high		2		dB
P_{OUT}	Output power	GC set low		3.2		dBm
		GC set high		5.6		dBm
P1dB	Output compression point	GC set low		12.5		dBm
		GC set high		12.8		dBm
IP3	Output IP3	$f_{BB1} = 4.5\text{ MHz}$; $f_{BB2} = 5.5\text{ MHz}$; GC set low		28		dBm
		$f_{BB1} = 4.5\text{ MHz}$; $f_{BB2} = 5.5\text{ MHz}$; GC set high		27.2		dBm
IP2	Output IP2	Measured at $f_{LO} + (f_{BB1} \pm f_{BB2})$, GC set low		67.9		dBm
		Measured at $f_{LO} + (f_{BB1} \pm f_{BB2})$, GC set high		66.4		dBm
SBS	Unadjusted sideband suppression			-52.9		dBm
CF	Unadjusted carrier feedthrough	Measured at LO frequency		-37.8		dBm
		Measured at 2 x LO		-41		dBm
		Measured at 3 x LO		-42		dBm
	Output noise floor	DC only to BB inputs; 10-MHz offset from LO		-160.6		dBm/Hz
HD2 _{BB}	Baseband harmonics	Measured with $\pm 1\text{-MHz}$ tone at 0.5 V_{PP} each at $f_{LO} \pm (2 \times f_{BB})$		-67		dBc
HD3 _{BB}	Baseband harmonics	Measured with $\pm 1\text{-MHz}$ tone at 0.5 V_{PP} each at $f_{LO} \pm (3 \times f_{BB})$		-59		dBc

ELECTRICAL CHARACTERISTICS (continued)

Over recommended operating conditions; at power supply = 3.3 V, $T_A = 25^\circ\text{C}$, $V_{CM} = 0.25\text{ V}$; LO Power = 0 dBm, single-ended (LOP); GC set low, $V_{IN\ BB} = 1\text{ V}_{PP}$ (diff) in quadrature, and $f_{BB} = 5.5\text{ MHz}$, standard broadband output matching circuit, unless otherwise noted.

PARAMETERS		TEST CONDITIONS	MIN	TYP	MAX	UNIT
$f_{LO} = 3500\text{ MHz}$						
G	Voltage gain	Output RMS voltage over input I (or Q) RMS voltage, GC set low		-1		dB
		Output RMS voltage over input I (or Q) RMS voltage, GC set high		1.8		dB
P _{OUT}	Output power	GC set low		3		dBm
		GC set high		5.8		dBm
P1dB	Output compression point	GC set low		12.1		dBm
		GC set high		12.3		dBm
IP3	Output IP3	$f_{BB1} = 4.5\text{ MHz}$; $f_{BB2} = 5.5\text{ MHz}$; GC set low		23.8		dBm
		$f_{BB1} = 4.5\text{ MHz}$; $f_{BB2} = 5.5\text{ MHz}$; GC set high		25.3		dBm
IP2	Output IP2	Measured at $f_{LO} + (f_{BB1} \pm f_{BB2})$, GC set low		47.8		dBm
		Measured at $f_{LO} + (f_{BB1} \pm f_{BB2})$, GC set high		48.6		dBm
SBS	Unadjusted sideband suppression			-45.2		dBm
CF	Unadjusted carrier feedthrough	Measured at LO frequency		-31.6		dBm
		Measured at 2 x LO		-30		dBm
		Measured at 3 x LO		-53		dBm
	Output noise floor	DC only to BB inputs; 10-MHz offset from LO		-160.6		dBm/Hz
HD2 _{BB}	Baseband harmonics	Measured with $\pm 1\text{-MHz}$ tone at 0.5 V_{PP} each at $f_{LO} \pm (2 \times f_{BB})$		-54		dBc
HD3 _{BB}	Baseband harmonics	Measured with $\pm 1\text{-MHz}$ tone at 0.5 V_{PP} each at $f_{LO} \pm (3 \times f_{BB})$		-50		dBc

DEVICE INFORMATION

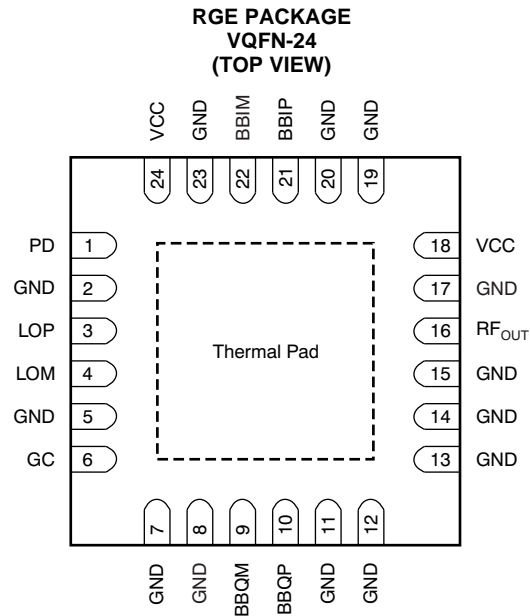

PIN FUNCTIONS

PIN		I/O	DESCRIPTION
NO.	NAME		
1	PD	I	Power-down digital input (high = device off)
2	GND	I	Ground
3	LOP	I	Local oscillator input
4	LOM	I	Local oscillator input
5	GND	I	Ground
6	GC	I	Gain control digital input (high = high gain)
7	GND	—	Ground or leave unconnected
8	GND	I	Ground
9	BBQM	I	In-quadrature input
10	BBQP	I	In-quadrature input
11	GND	I	Ground
12	GND	I	Ground
13	GND	I	Ground
14	GND	I	Ground
15	GND	I	Ground
16	RF _{OUT}	O	RF output
17	GND	I	Ground
18	VCC	I	Power supply
19	GND	I	Ground
20	GND	I	Ground
21	BBIP	I	In-phase input
22	BBIM	I	In-phase input
23	GND	I	Ground
24	VCC	I	Power supply

TYPICAL CHARACTERISTICS: Single-Tone Baseband

$V_{CC} = 3.3\text{ V}$; $T_A = 25^\circ\text{C}$; LO = 0 dBm, single-ended drive (LOP); I/Q frequency (f_{BB}) = 5.5 MHz; baseband I/Q amplitude = 1- V_{PP} differential sine waves in quadrature with $V_{CM} = 0.25\text{ V}$; and broadband output match, unless otherwise noted.

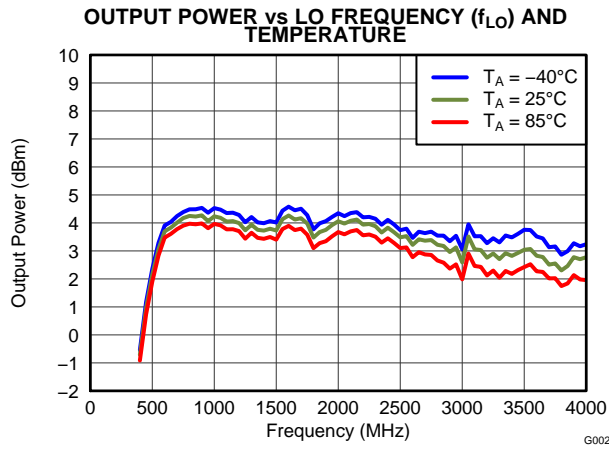

Figure 1.

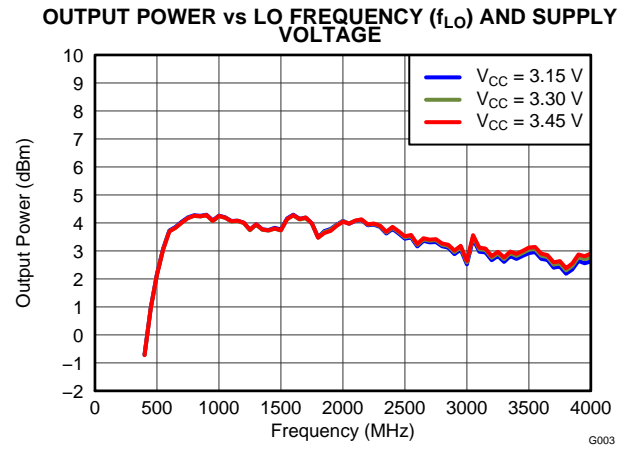

Figure 2.

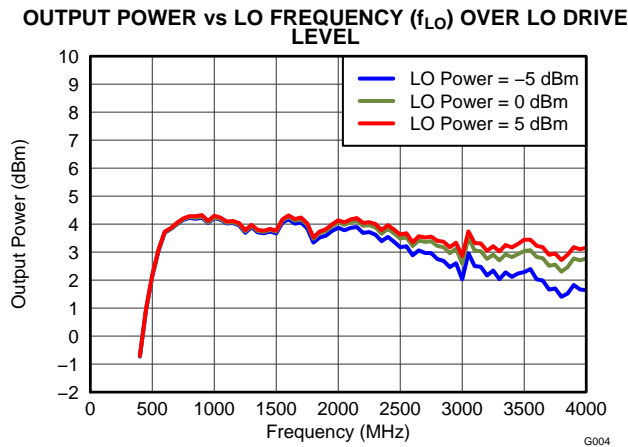

Figure 3.

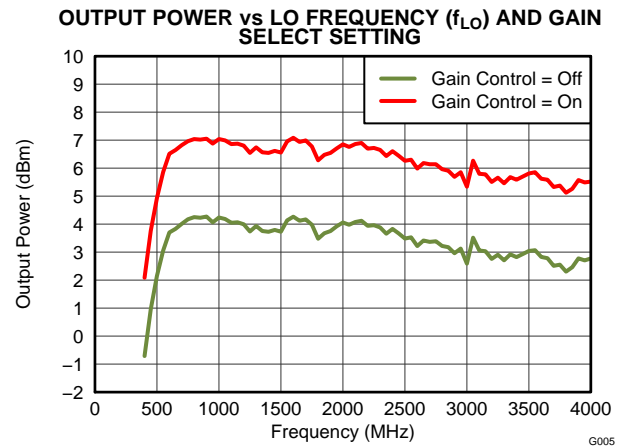

Figure 4.

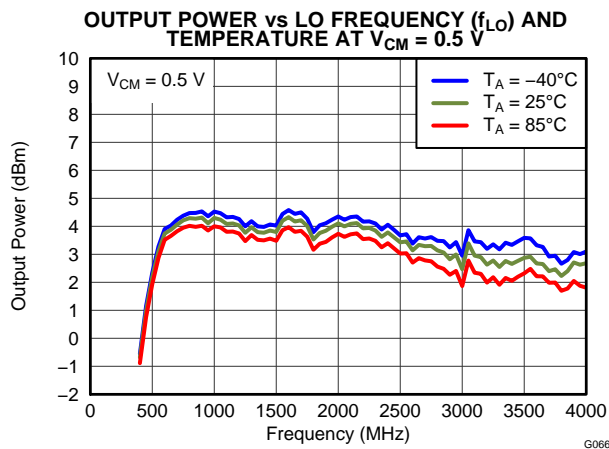

Figure 5.

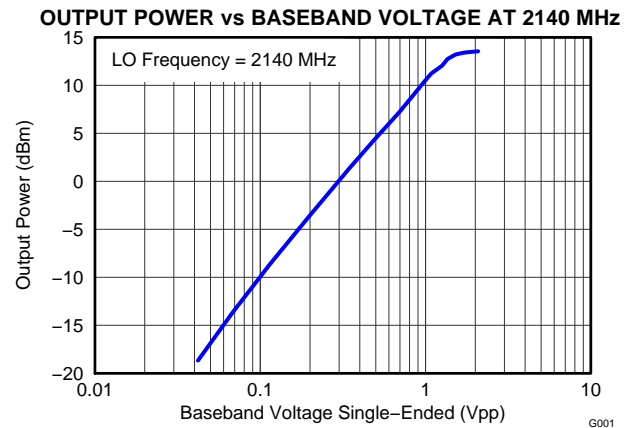

Figure 6.

TYPICAL CHARACTERISTICS: Single-Tone Baseband (continued)

$V_{CC} = 3.3\text{ V}$; $T_A = 25^\circ\text{C}$; LO = 0 dBm, single-ended drive (LOP); I/Q frequency (f_{BB}) = 5.5 MHz; baseband I/Q amplitude = $1 - V_{PP}$ differential sine waves in quadrature with $V_{CM} = 0.25\text{ V}$; and broadband output match, unless otherwise noted.

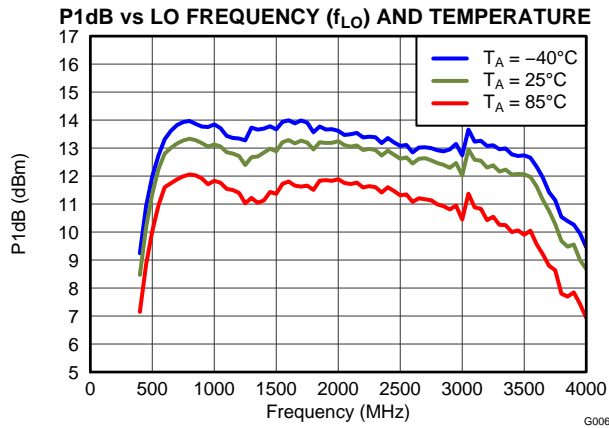

Figure 7.

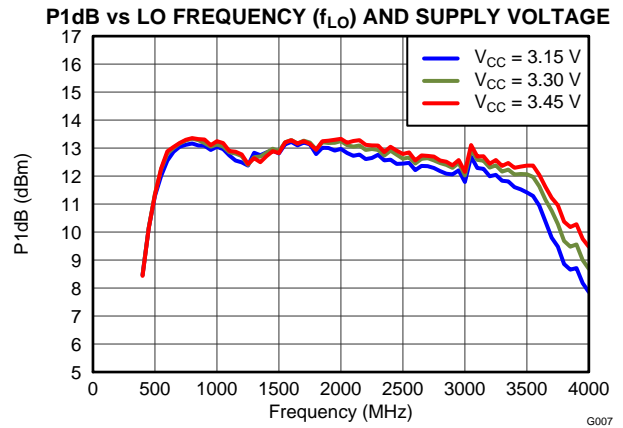

Figure 8.

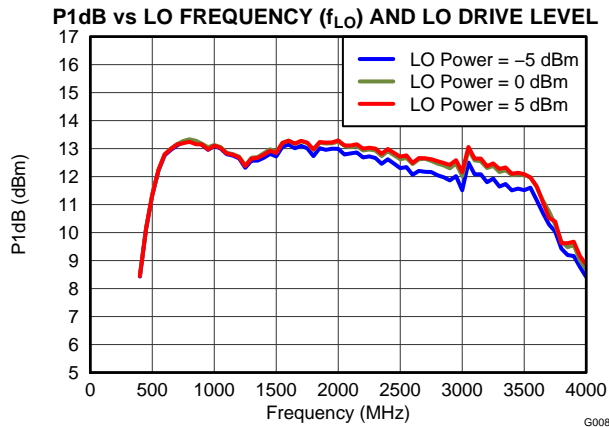

Figure 9.

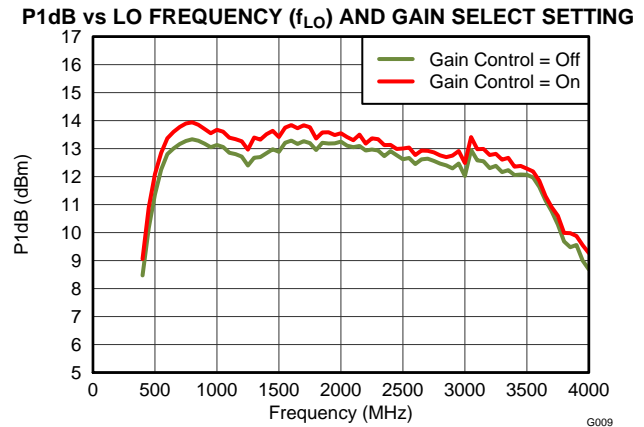

Figure 10.

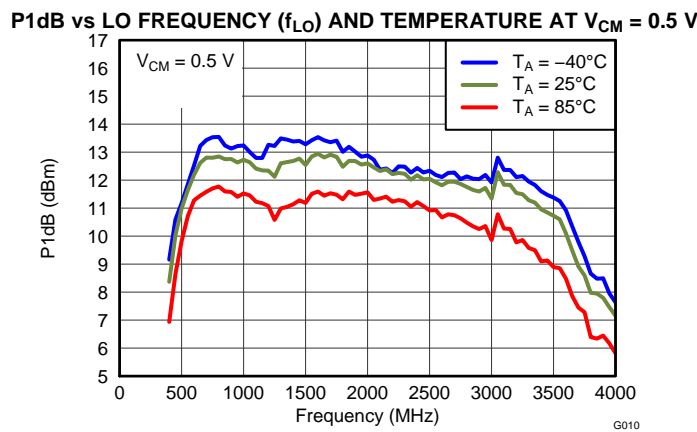

Figure 11.

TYPICAL CHARACTERISTICS: Two-Tone Baseband

$V_{CC} = 3.3\text{ V}$; $T_A = +25^\circ\text{C}$; LO = 0 dBm, single-ended drive (LOP); I/Q frequency (f_{BB}) = 4.5 MHz, 5.5 MHz; baseband I/Q amplitude = $0.5 \cdot V_{PP}$ /tone differential sine waves in quadrature with $V_{CM} = 0.25\text{ V}$; and broadband output match, unless otherwise noted.

TYPICAL CHARACTERISTICS: Two-Tone Baseband (continued)

$V_{CC} = 3.3\text{ V}$; $T_A = +25^\circ\text{C}$; LO = 0 dBm, single-ended drive (LOP); I/Q frequency (f_{BB}) = 4.5 MHz, 5.5 MHz; baseband I/Q amplitude = $0.5 \cdot V_{PP}$ /tone differential sine waves in quadrature with $V_{CM} = 0.25\text{ V}$; and broadband output match, unless otherwise noted.

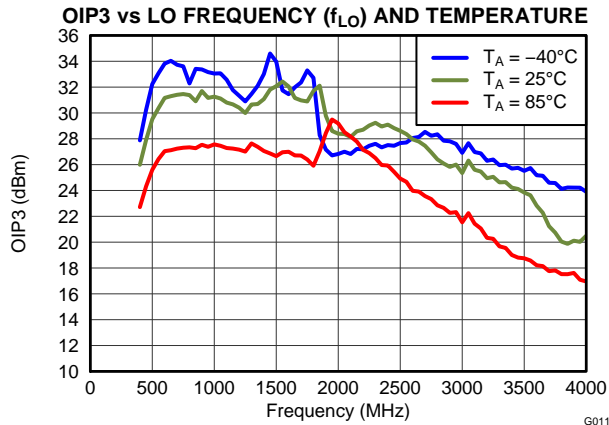

Figure 12.

G011

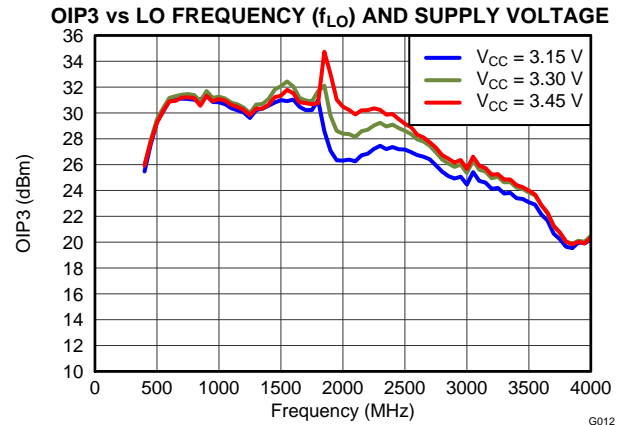

Figure 13.

G012

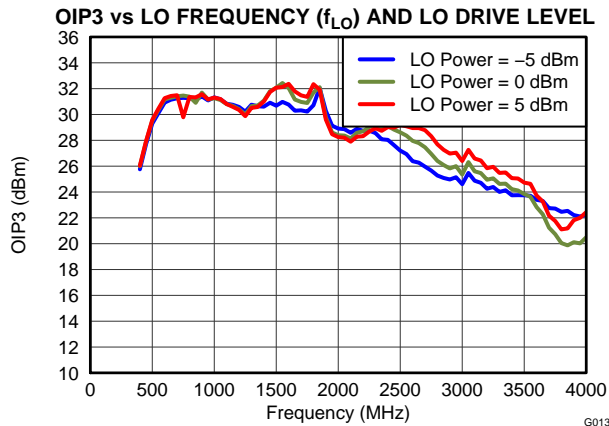

Figure 14.

G013

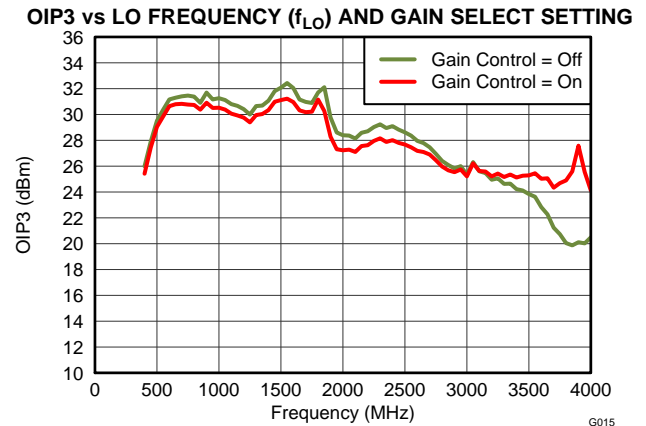

Figure 15.

G015

OIP3 vs LO FREQUENCY (f_{LO}) AND TEMPERATURE AT $V_{CM} = 0.5\text{ V}$

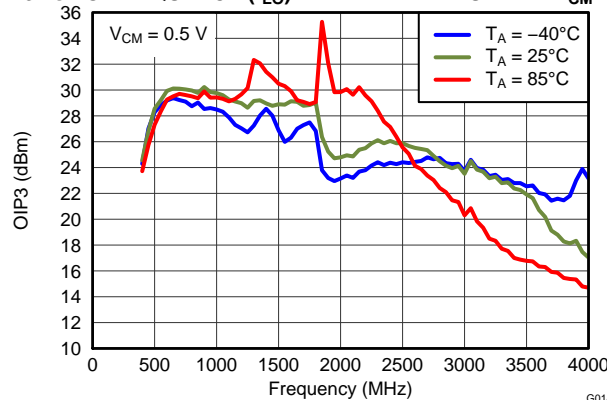

Figure 16.

G014

TYPICAL CHARACTERISTICS: Two-Tone Baseband (continued)

$V_{CC} = 3.3\text{ V}$; $T_A = +25^\circ\text{C}$; LO = 0 dBm, single-ended drive (LOP); I/Q frequency (f_{BB}) = 4.5 MHz, 5.5 MHz; baseband I/Q amplitude = $0.5 \cdot V_{PP}$ /tone differential sine waves in quadrature with $V_{CM} = 0.25\text{ V}$; and broadband output match, unless otherwise noted.

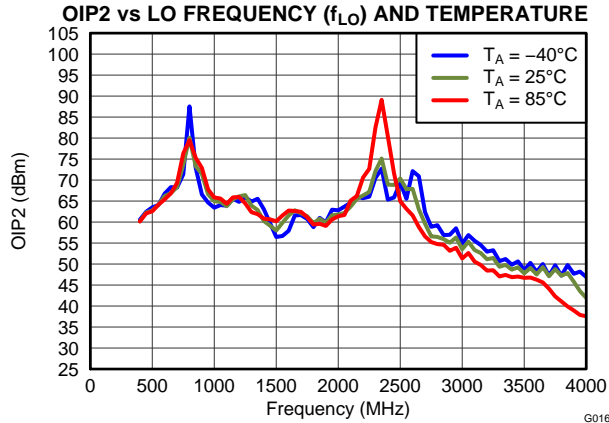

Figure 17.

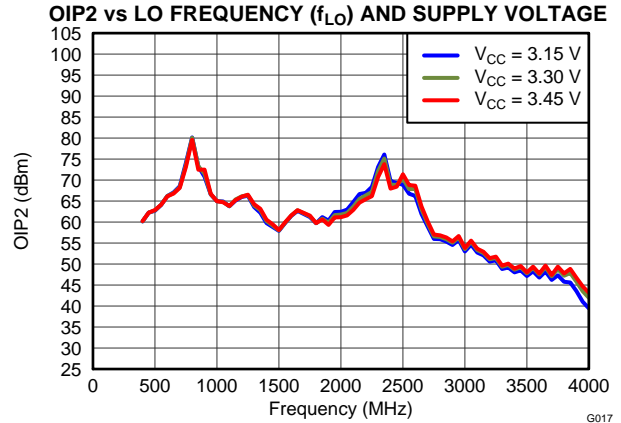

Figure 18.

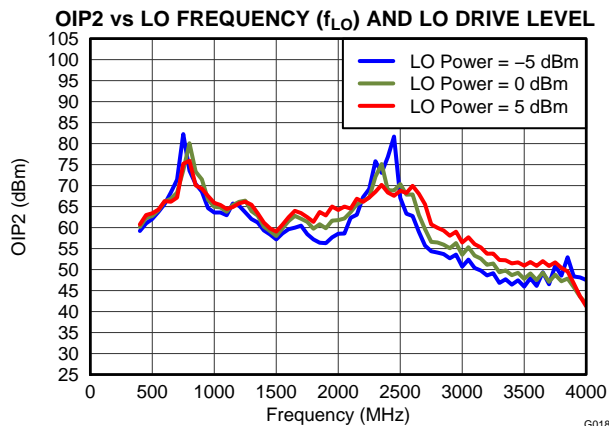

Figure 19.

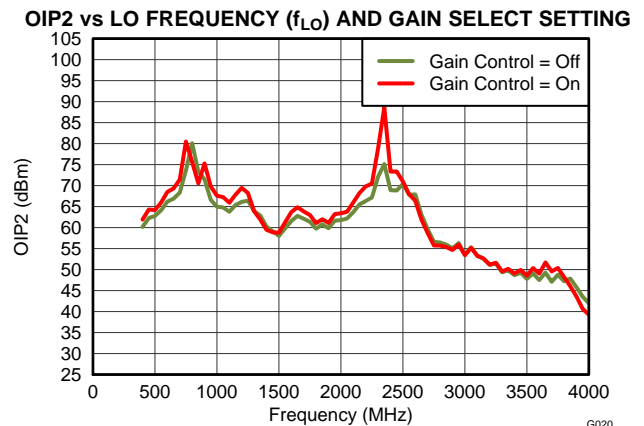

Figure 20.

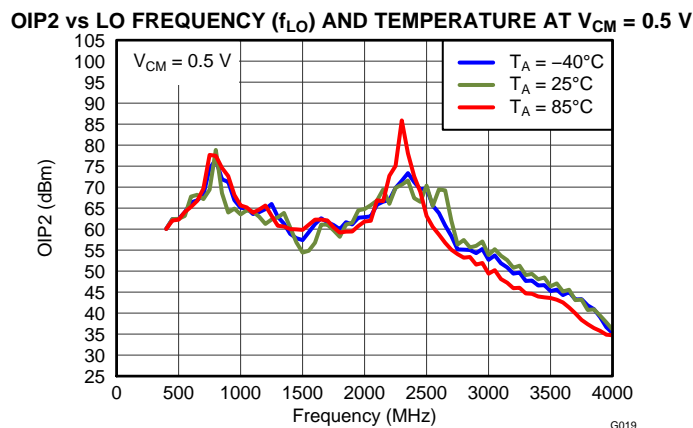

Figure 21.

TYPICAL CHARACTERISTICS: Two-Tone Baseband (continued)

$V_{CC} = 3.3\text{ V}$; $T_A = +25^\circ\text{C}$; LO = 0 dBm, single-ended drive (LOP); I/Q frequency (f_{BB}) = 4.5 MHz, 5.5 MHz; baseband I/Q amplitude = $0.5 \cdot V_{PP}$ /tone differential sine waves in quadrature with $V_{CM} = 0.25\text{ V}$; and broadband output match, unless otherwise noted.

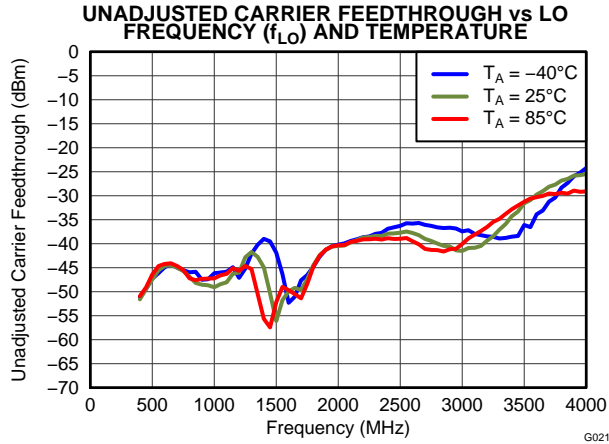

Figure 22.

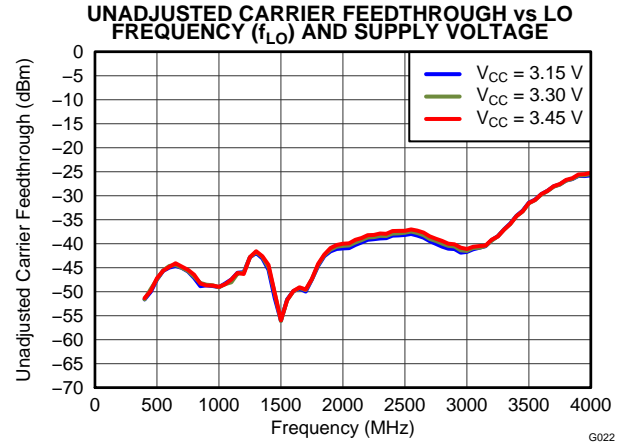

Figure 23.

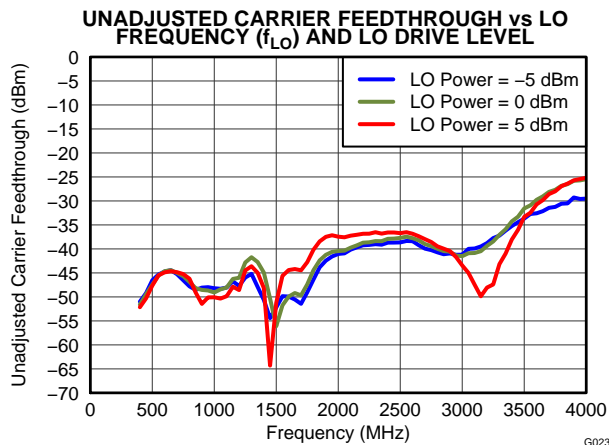

Figure 24.

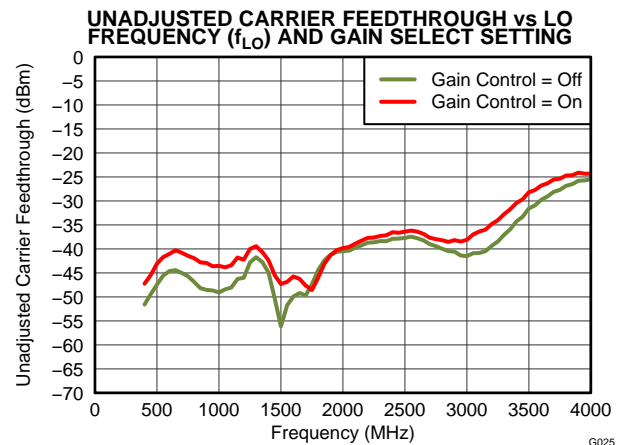

Figure 25.

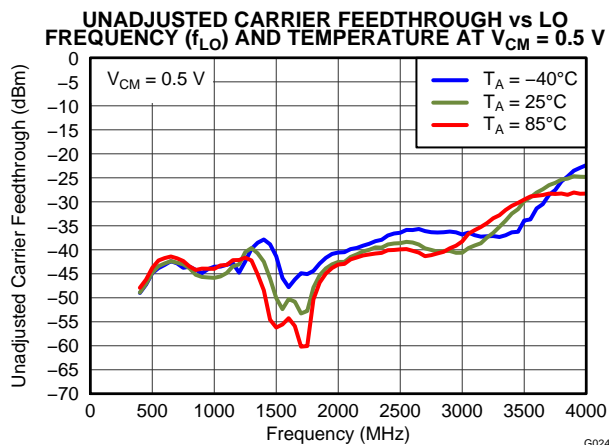

Figure 26.

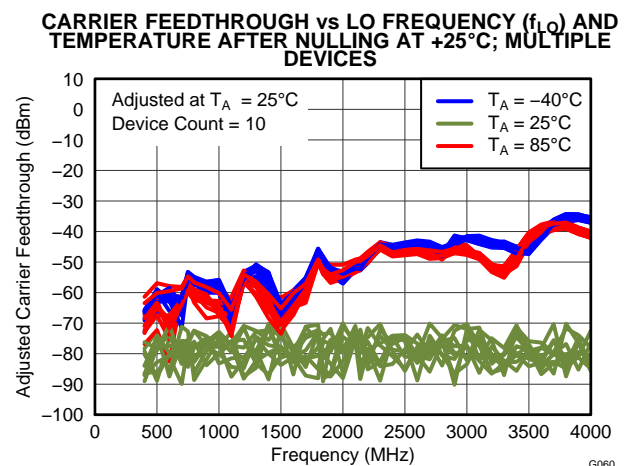

Figure 27.

TYPICAL CHARACTERISTICS: Two-Tone Baseband (continued)

$V_{CC} = 3.3\text{ V}$; $T_A = +25^\circ\text{C}$; LO = 0 dBm, single-ended drive (LOP); I/Q frequency (f_{BB}) = 4.5 MHz, 5.5 MHz; baseband I/Q amplitude = $0.5 \cdot V_{PP}$ /tone differential sine waves in quadrature with $V_{CM} = 0.25\text{ V}$; and broadband output match, unless otherwise noted.

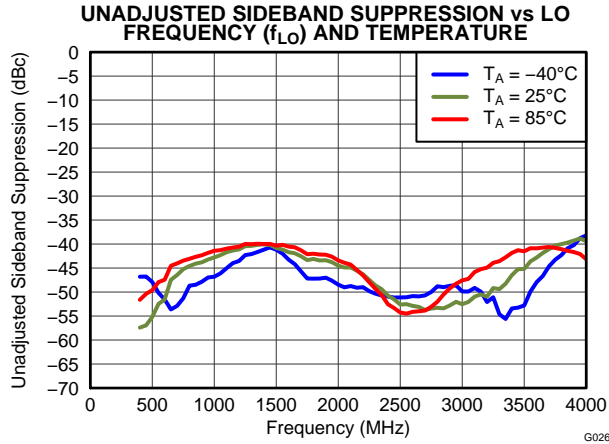

Figure 28.

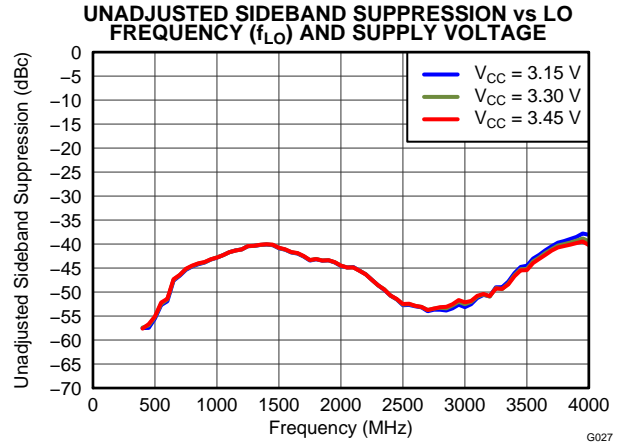

Figure 29.

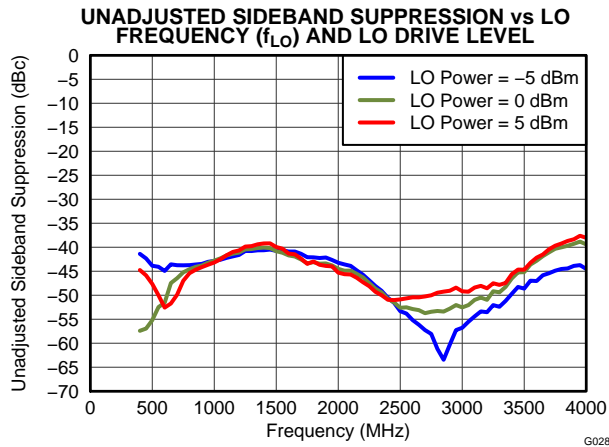

Figure 30.

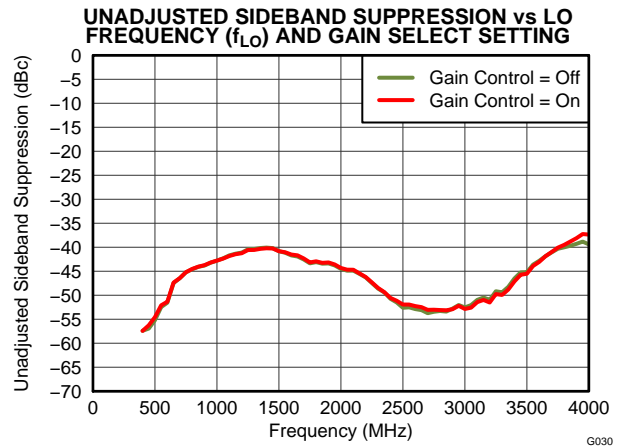

Figure 31.

UNADJUSTED SIDEBAND SUPPRESSION vs LO FREQUENCY (f_{LO}) AND TEMPERATURE AT $V_{CM} = 0.5\text{ V}$

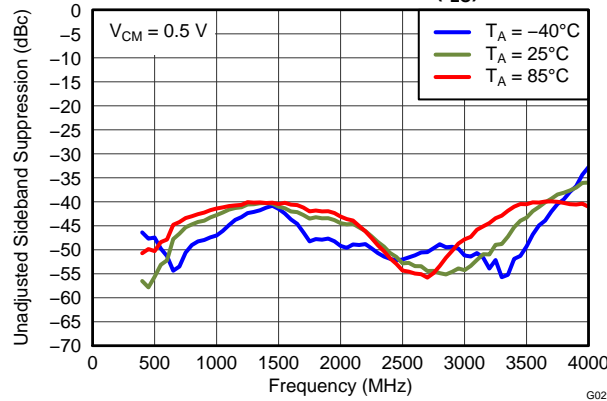

Figure 32.

TYPICAL CHARACTERISTICS: Two-Tone Baseband, Mid-Band Calibration

$V_{CC} = 3.3\text{ V}$; $T_A = +25^\circ\text{C}$; LO = 0 dBm, single-ended drive (LOP); I/Q frequency (f_{BB}) = 4.5 MHz, 5.5 MHz; baseband I/Q amplitude = $0.5 \cdot V_{pp}$ /tone differential sine waves in quadrature with $V_{CM} = 0.25\text{ V}$; and broadband output match, unless otherwise noted. Single point adjustment mid-band.

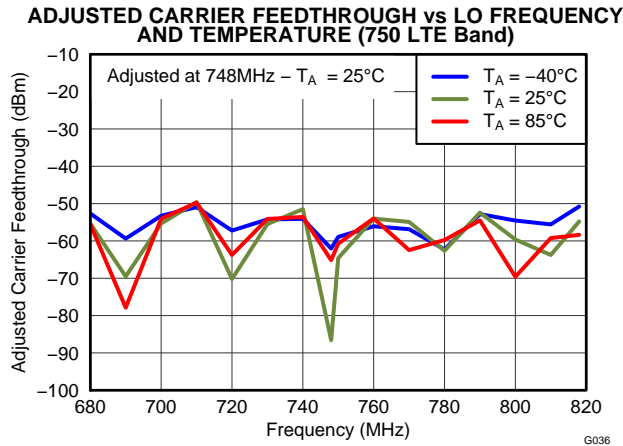

Figure 33.

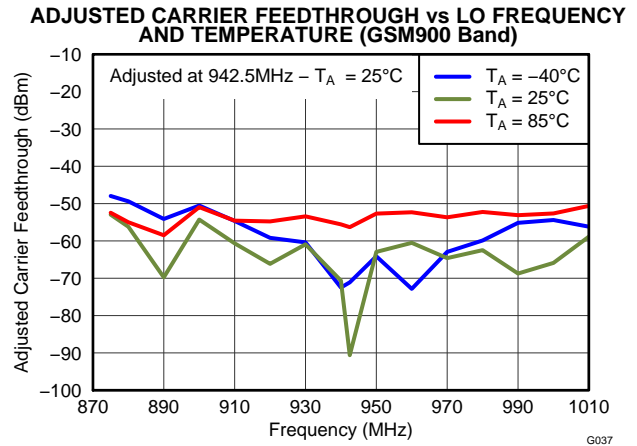

Figure 34.

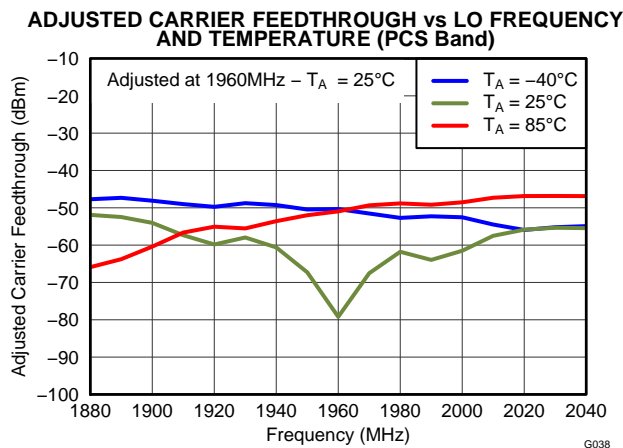

Figure 35.

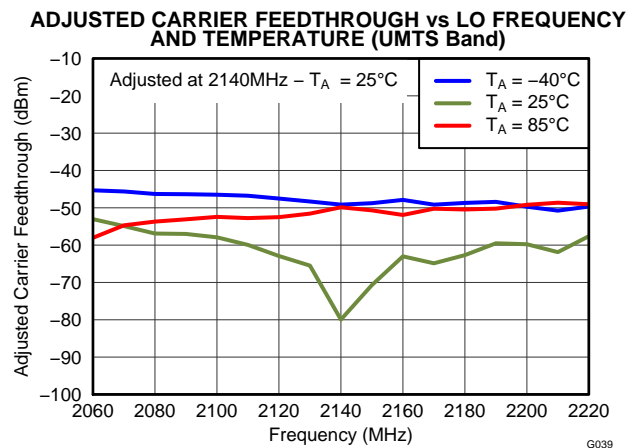

Figure 36.

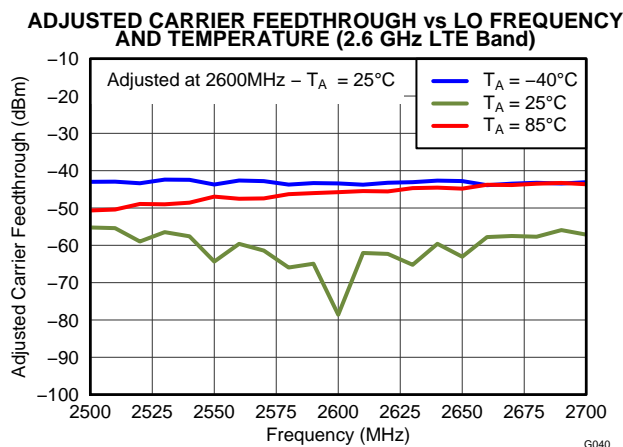

Figure 37.

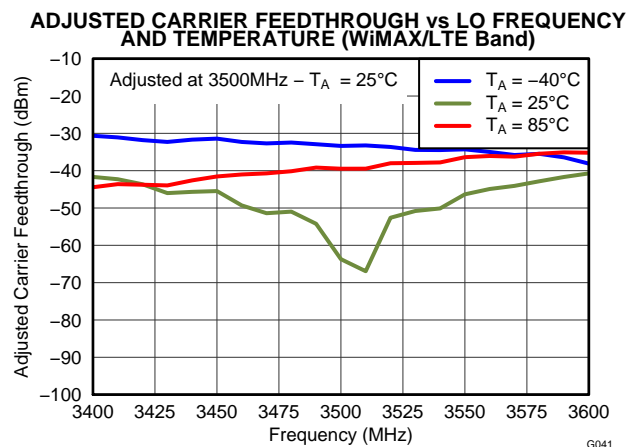

Figure 38.

TYPICAL CHARACTERISTICS: Two-Tone Baseband, Mid-Band Calibration (continued)

$V_{CC} = 3.3\text{ V}$; $T_A = +25^\circ\text{C}$; LO = 0 dBm, single-ended drive (LOP); I/Q frequency (f_{BB}) = 4.5 MHz, 5.5 MHz; baseband I/Q amplitude = $0.5 \cdot V_{PP}$ /tone differential sine waves in quadrature with $V_{CM} = 0.25\text{ V}$; and broadband output match, unless otherwise noted. Single point adjustment mid-band.

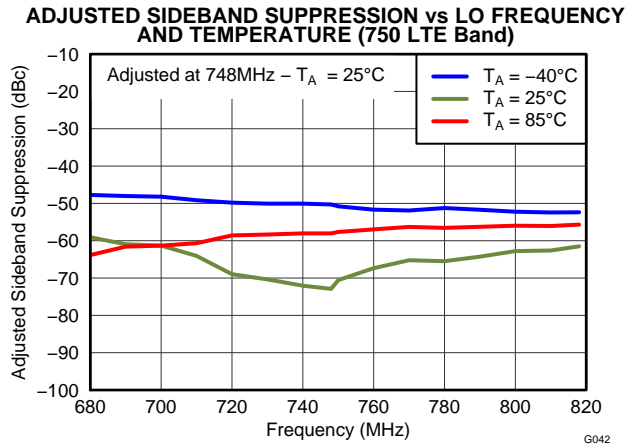

Figure 39.

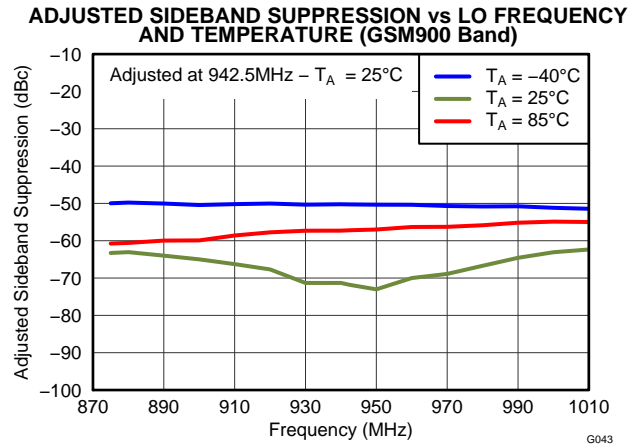

Figure 40.

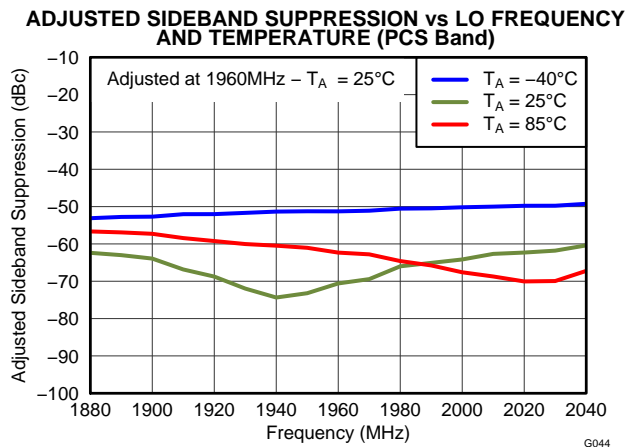

Figure 41.

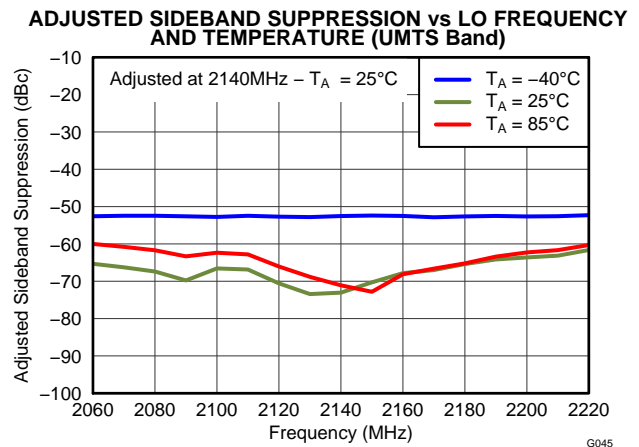

Figure 42.

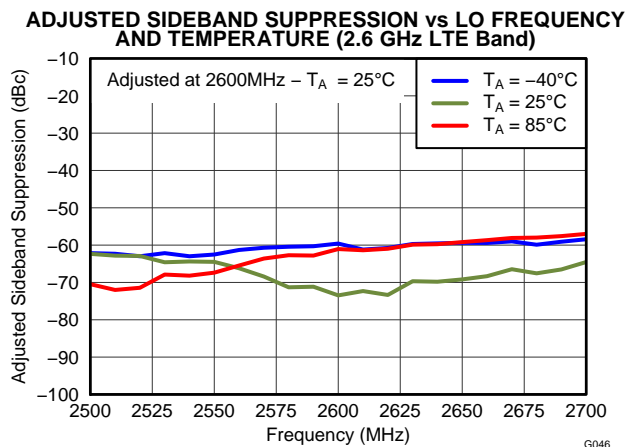

Figure 43.

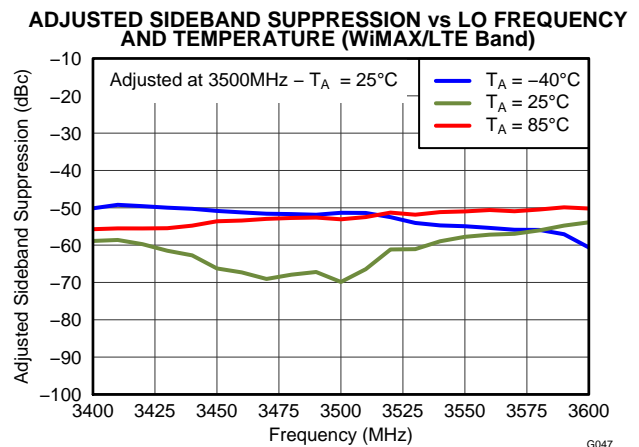

Figure 44.

TYPICAL CHARACTERISTICS: No Baseband

$V_{CC} = 3.3\text{ V}$; $T_A = +25^\circ\text{C}$; LO = 0 dBm, single-ended drive (LOP); and input baseband ports terminated in 50 Ω , unless otherwise noted.

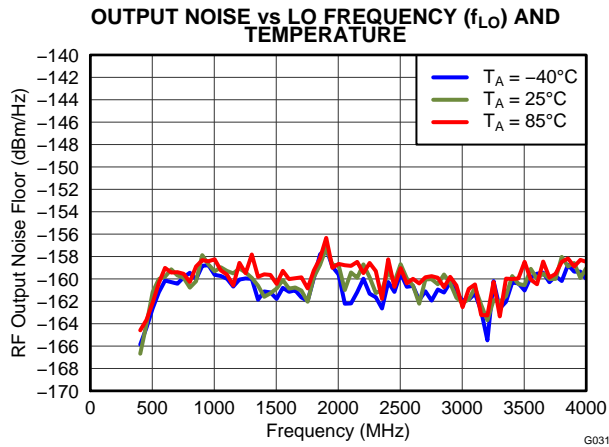

Figure 45.

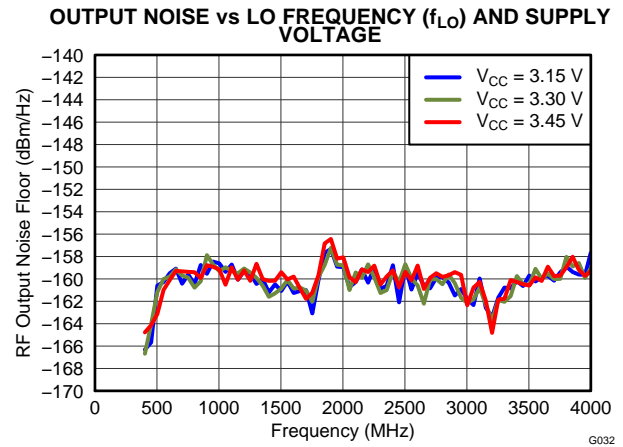

Figure 46.

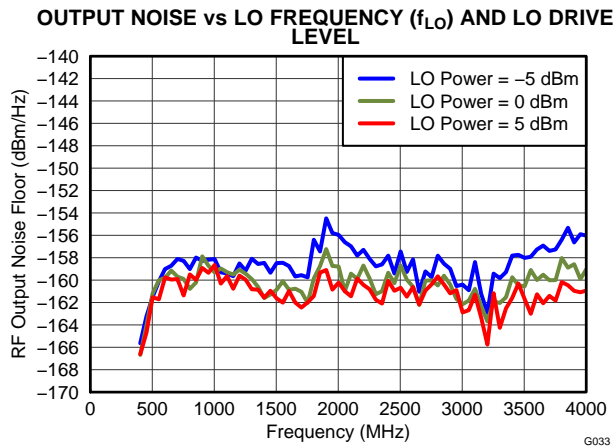

Figure 47.

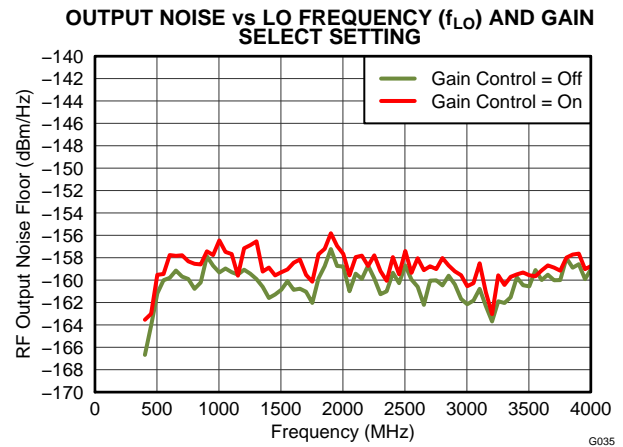

Figure 48.

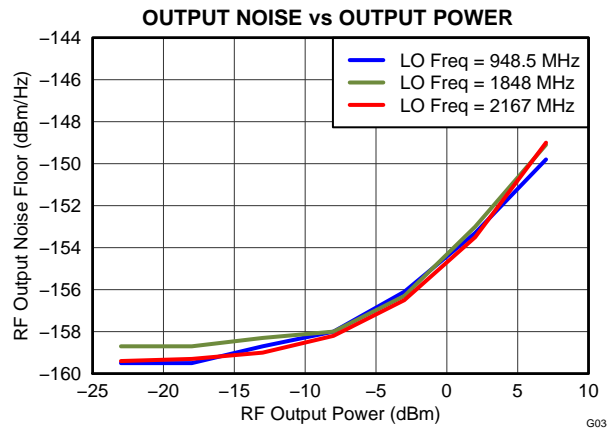

Figure 49.

TYPICAL CHARACTERISTICS: Two-Tone Baseband

$V_{CC} = 3.3\text{ V}$; $T_A = +25^\circ\text{C}$; LO = 0 dBm, single-ended drive (LOP); I/Q frequency (f_{BB}) = 4.5 MHz, 5.5 MHz; baseband I/Q amplitude = $0.5 \cdot V_{pp}$ /tone differential sine waves in quadrature with $V_{CM} = 0.25\text{ V}$; and broadband output match, unless otherwise noted.

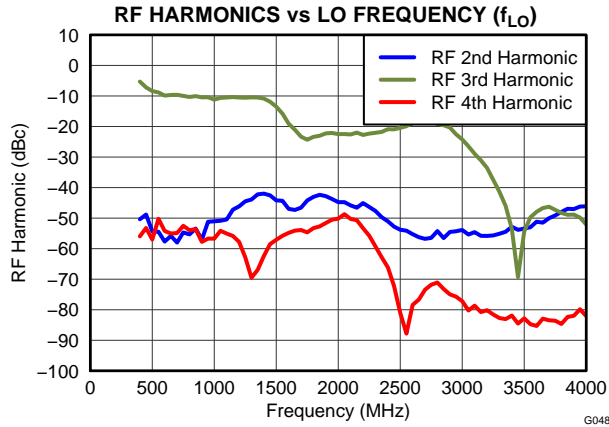

Figure 50.

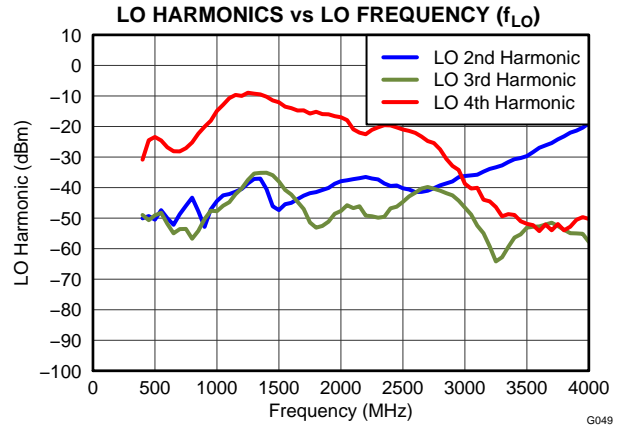

Figure 51.

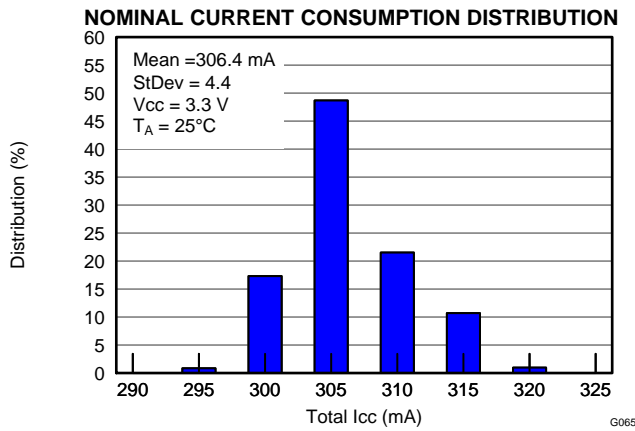

Figure 52.

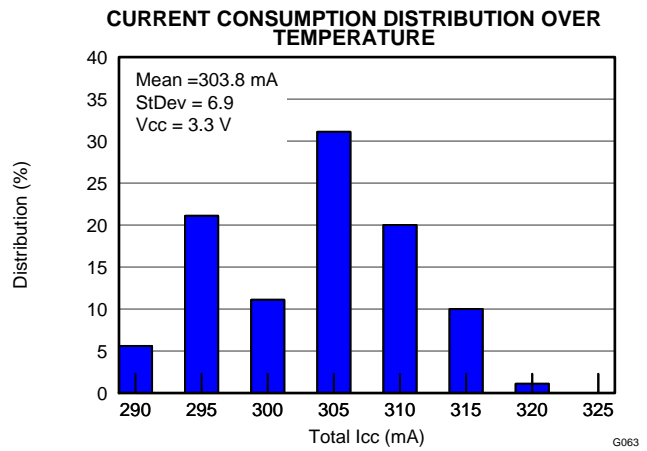

Figure 53.

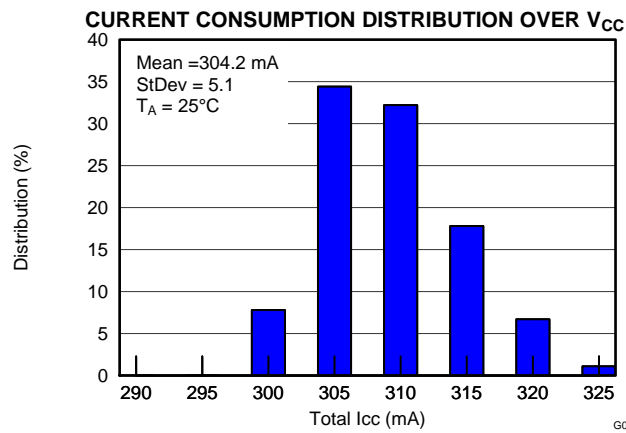

Figure 54.

TYPICAL CHARACTERISTICS: Two-Tone Baseband (continued)

$V_{CC} = 3.3\text{ V}$; $T_A = +25^\circ\text{C}$; LO = 0 dBm, single-ended drive (LOP); I/Q frequency (f_{BB}) = 4.5 MHz, 5.5 MHz; baseband I/Q amplitude = $0.5 \cdot V_{PP}$ /tone differential sine waves in quadrature with $V_{CM} = 0.25\text{ V}$; and broadband output match, unless otherwise noted.

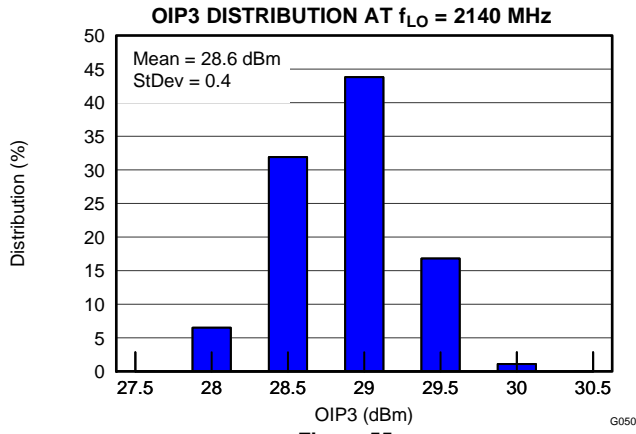

Figure 55.

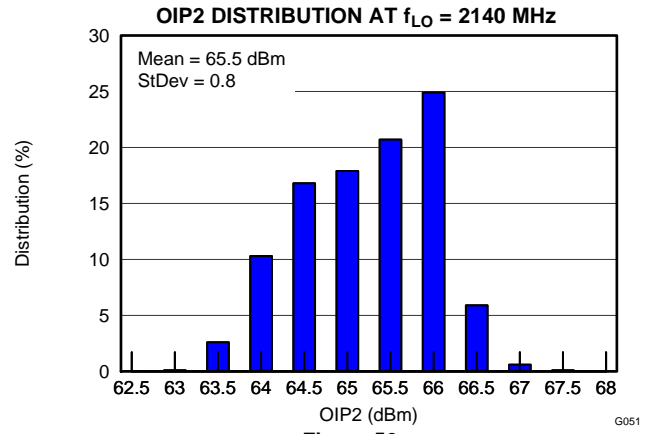

Figure 56.

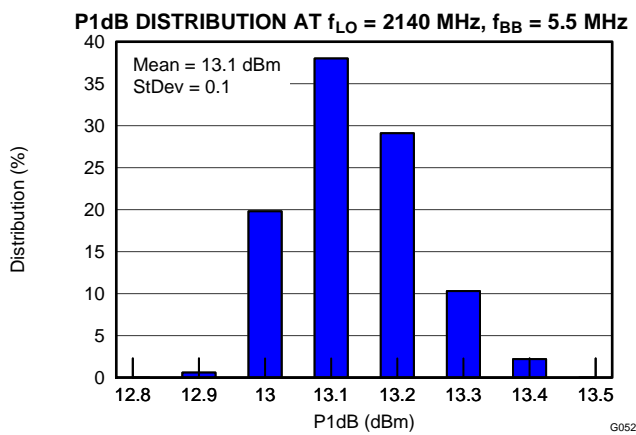

Figure 57.

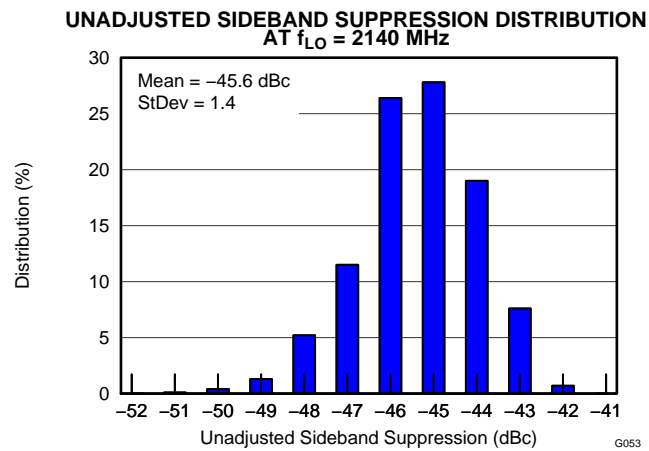

Figure 58.

UNADJUSTED CARRIER FEEDTHROUGH DISTRIBUTION AT $f_{LO} = 2140\text{ MHz}$

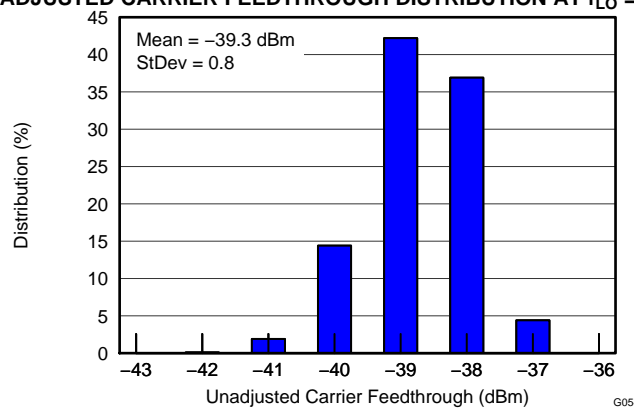
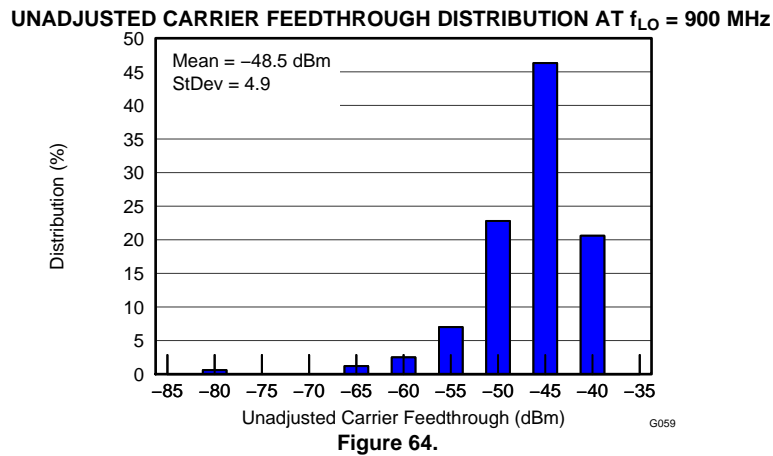
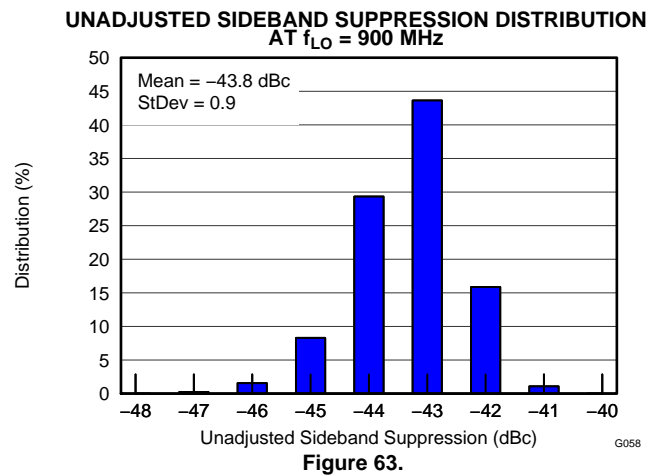
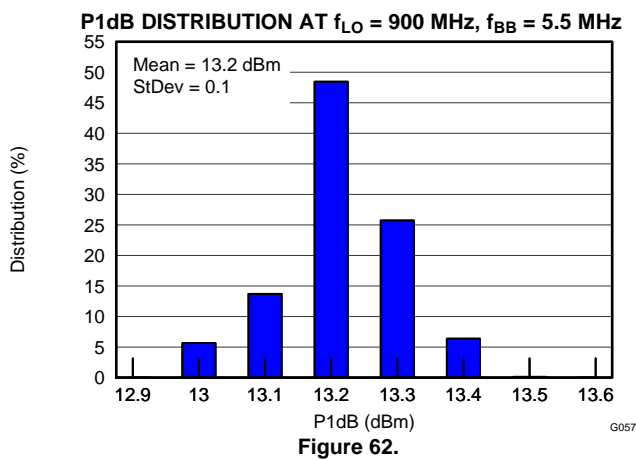
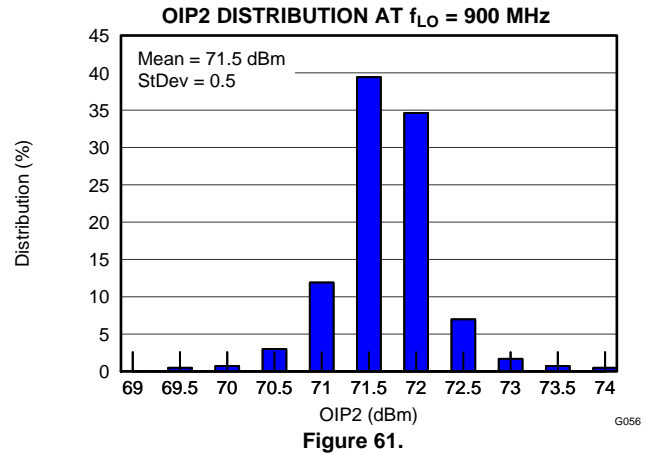
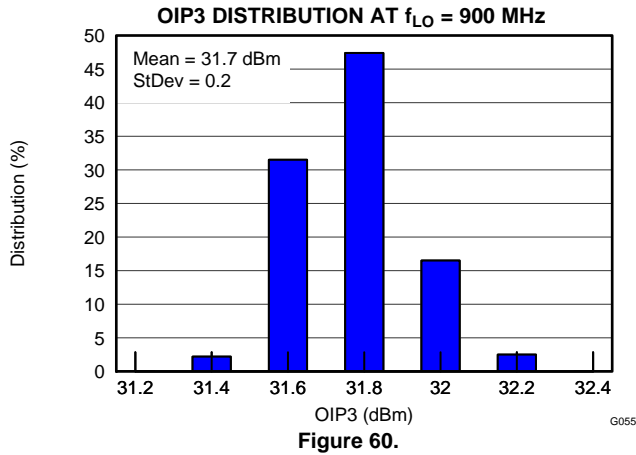

Figure 59.

TYPICAL CHARACTERISTICS: Two-Tone Baseband (continued)

$V_{CC} = 3.3\text{ V}$; $T_A = +25^\circ\text{C}$; $LO = 0\text{ dBm}$, single-ended drive (LOP); I/Q frequency (f_{BB}) = 4.5 MHz, 5.5 MHz; baseband I/Q amplitude = $0.5 \cdot V_{PP}$ /tone differential sine waves in quadrature with $V_{CM} = 0.25\text{ V}$; and broadband output match, unless otherwise noted.



APPLICATION INFORMATION

Application Schematic

Figure 65 shows a typical TRF37T05 application schematic.

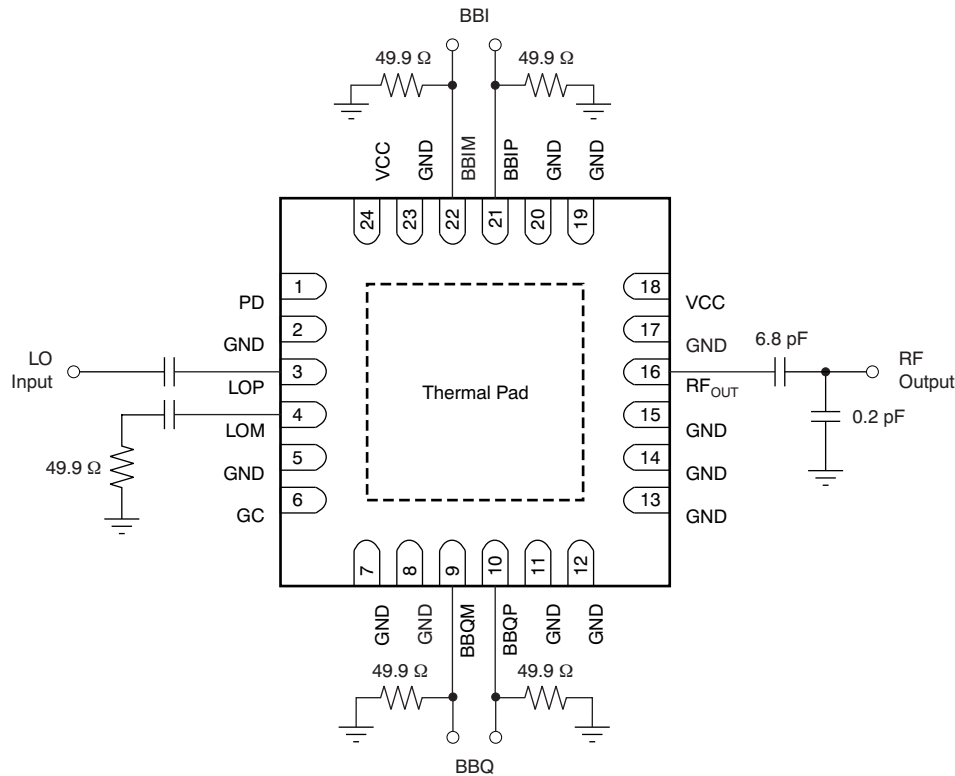

(1) Pin 1 (PD) and Pin 6 (GC) are internally pulled down.

Figure 65. Typical Application Circuit

Power Supply and Grounding

The TRF37T05 is powered by supplying a nominal 3.3 V to pins 18 and 24. These supplies can be tied together and sourced from a single clean supply. Proper RF bypassing should be placed close to each power supply pin.

Ground pin connections should have at least one ground via close to each ground pin to minimize ground inductance. The PowerPAD™ must be tied to ground, preferably with the recommended ground via pattern to provide a good thermal conduction path to the alternate side of the board and to provide a good RF ground for the device. (Refer to [PCB Design Guidelines](#) for additional information.)

Baseband Inputs

The baseband inputs consist of the in-phase signal (I) and the Quadrature-phase signal (Q). The I and Q lines are differential lines that are driven in quadrature. The nominal drive level is $1-V_{PP}$ differential on each branch.

The baseband lines are nominally biased at $0.25-V_{CM}$ common-mode voltage (V_{CM}); however, the device can operate with a V_{CM} in the range of 0 V to 0.5 V. The baseband input lines are normally terminated in 50Ω , though it is possible to modify this value if necessary to match to an external filter load impedance requirement.

LO Input

The LO inputs can be driven either single-ended or differentially. There is no significant performance difference between either option with the exception of the sideband suppression. If driven single-ended, either input can be used, but LOP (pin 3) is recommended for best broadband performance of sideband suppression. When driving in single-ended configuration, simply ac-couple the unused port and terminate in 50 Ω . The comparison of the sideband suppression performance is shown in Figure 66 for driving the LO single-ended from either pin and for driving the LO input differentially.

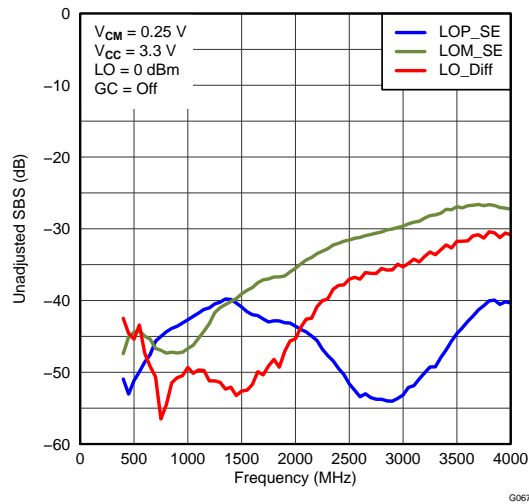

Figure 66. Unadjusted Sideband Suppression (SBS) vs LO Drive Options

RF Output

The RF output must be ac-coupled and can drive a 50- Ω load. The suggested output match provides the best broadband performance across the frequency range of the device. It is possible to modify the output match to optimize performance within a selected band if needed. The optimized matching circuits are to match the RF output impedances to 50 Ω .

Figure 67 shows a slightly better OIP3 performance at the frequency above 1850 MHz with an 0.2-pF matching capacitor.

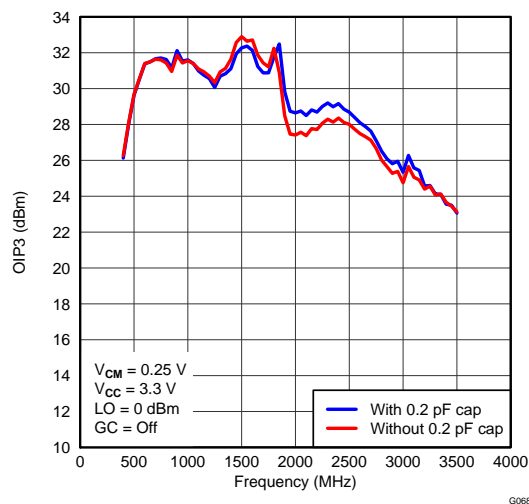

Figure 67. OIP3 with and without a Shunt 0.2-pF Matching Capacitor at the RF Port

350-MHz Operation

A different matching circuit, as shown in Figure 68, could also be applied to improve the performance for the frequency from 300 MHz to 400 MHz.

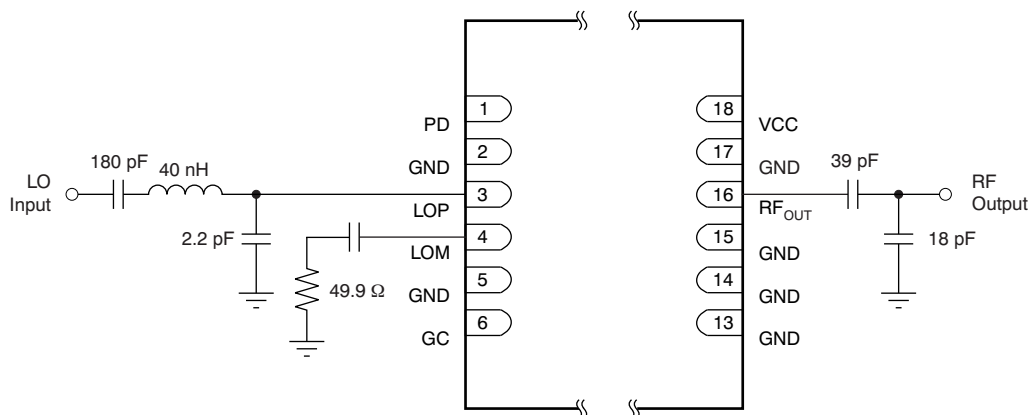

Figure 68. Matching Components for Operation Centered at 350 MHz

Figure 69 and Figure 70 show a slight improvement in OIP3 performance at 350 MHz with an 0.2-pF matching capacitor.

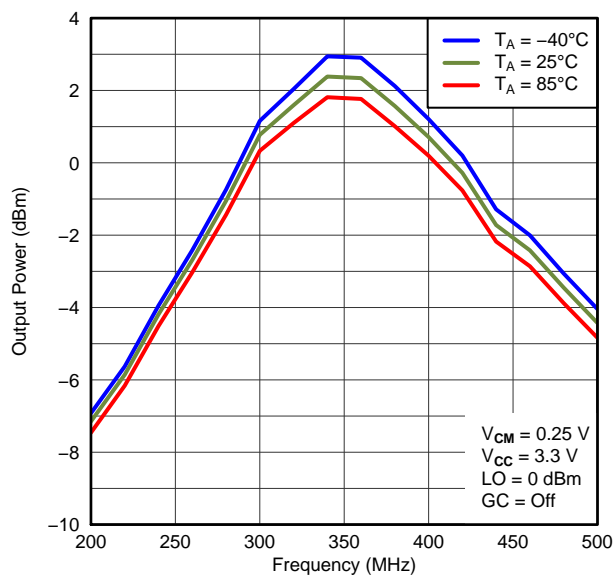

Figure 69. Output Power with 350-MHz Matching Circuit

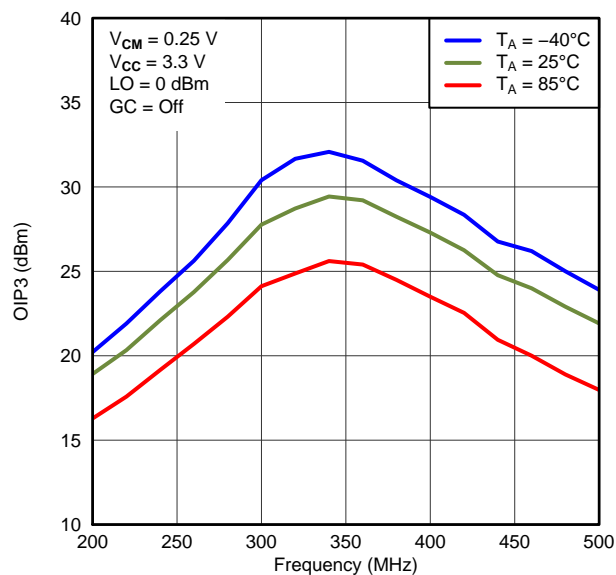

Figure 70. OIP3 with 350-MHz Matching Circuit

DAC to Modulator Interface Network

For optimum linearity and dynamic range, a digital-to-analog converter (DAC) can interface directly with the TRF37T05 modulator. It is imperative that the common-mode voltage of the DAC and the modulator baseband inputs be properly maintained. With the proper interface network, the common-mode voltage of the DAC can be translated to the proper common-mode voltage of the modulator. The TRF37T05 common-mode voltage is typically 0.25 V, and is ideally suited to interface with the [DAC3482/3484](#) (DAC348x) family because the common-mode voltages of both devices are the same; there is no translation network required. The interface network is shown in [Figure 71](#).

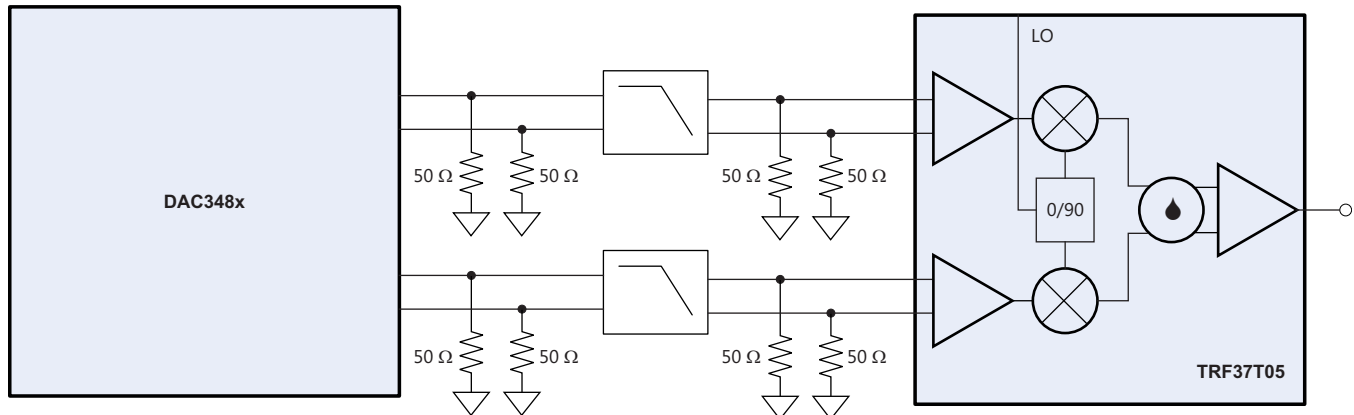

Figure 71. DAC348x Interface with the TRF37T05 Modulator

The DAC348x requires a load resistor of 25 Ω per branch to maintain its optimum voltage swing of $1-V_{PP}$ differential with a 20-mA max current setting. The load of the DAC is separated into two parallel 50- Ω resistors placed on the input and output side of the low-pass filter. This configuration provides the proper resistive load to the DAC while also providing a convenient 50- Ω source and load termination for the filter.

DAC348x with TRF37T05 Modulator Performance

The combination of the DAC348x driving the TRF37T05 modulator yields excellent system parameters suitable for high-performance applications. As an example, the following sections illustrate the typical modulated adjacent channel power ratio (ACPR) for common telecom standards and bands. These measurements were taken on the [DAC348x evaluation board](#).

WCDMA

The adjacent channel power ratio (ACPR) performance using a single-carrier WCDMA signal in the UMTS band is shown in [Figure 72](#).

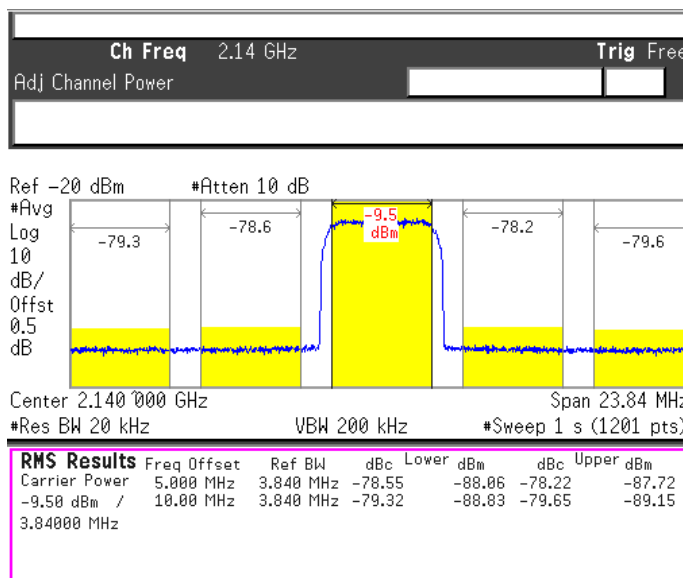

Figure 72. Single-Carrier WCDMA ACPR, IF = 30 MHz, LO Frequency = 2110 MHz

A marginal improvement in OIP3 and output noise performance can be observed by increasing the LO drive power, resulting in slightly improved ACPR performance. The ACPR performance versus LO drive level is plotted in [Figure 73](#) across common frequencies to illustrate the amount of improvement that is possible.

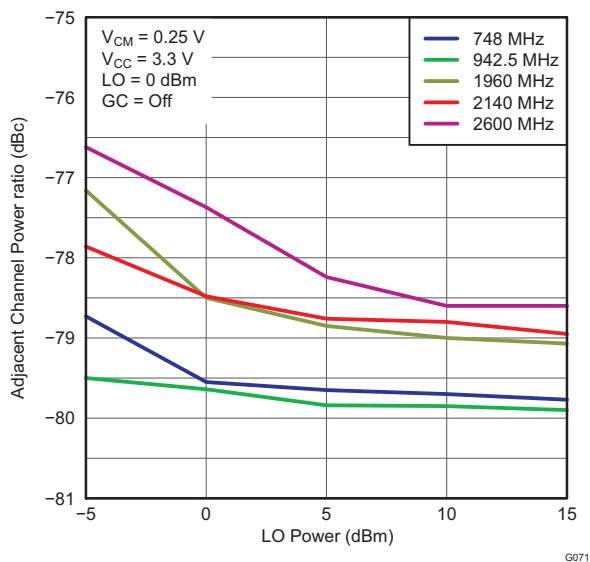

Figure 73. Single-Carrier WCDMA ACPR Performance vs LO Power

LTE

ACPR performance using a 10 MHz LTE signal in the 700-MHz band is shown in [Figure 74](#).

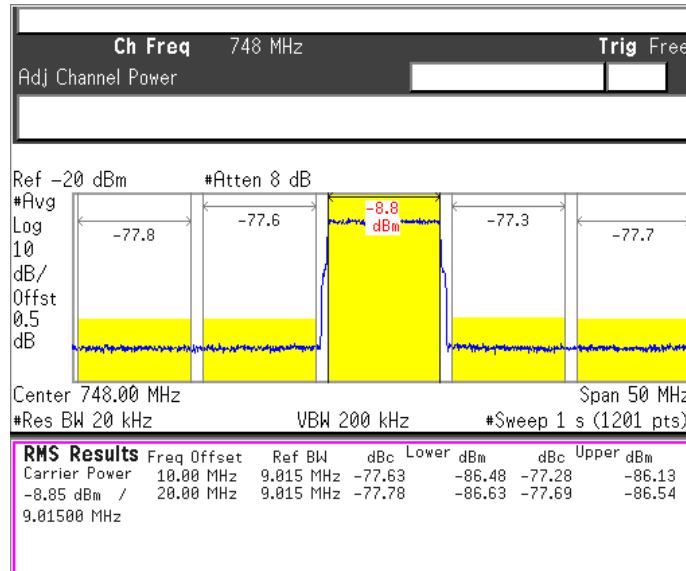

Figure 74. 10 MHz LTE ACPR, IF = 30 MHz, LO Frequency = 718 MHz

MC-GSM

ACPR performance using a four-carrier MC-GSM signal in the 1800-MHz band is shown in [Figure 75](#).

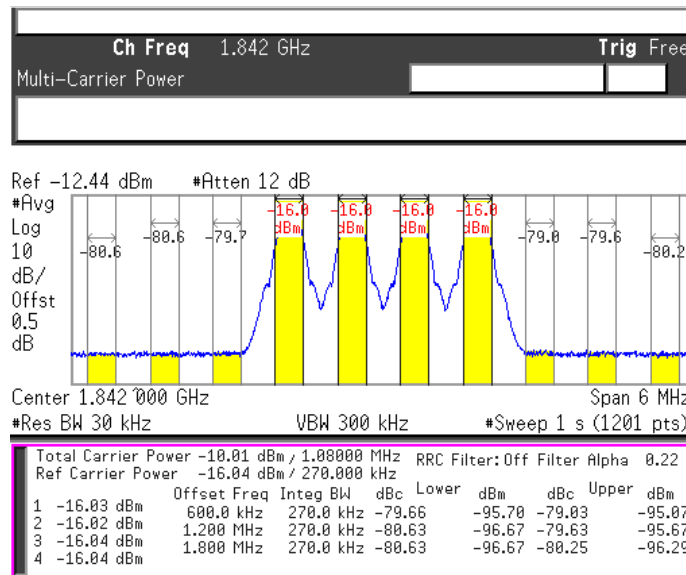

Figure 75. Four-Carrier MC-GSM, IF = 30 MHz ACPR, LO Frequency = 1812 MHz

DEFINITION OF SPECIFICATIONS

Carrier Feedthrough

This specification measures the power of the local oscillator component that is present at the output spectrum of the modulator. The performance depends on the dc offset balance within the baseband input lines. Ideally, if all of the baseband lines were perfectly matched, the carrier (that is, the LO) would be naturally suppressed; however, small dc offset imbalances within the device allow some of the LO component to feed through to the output. This parameter is expressed as an absolute power in dBm, and is independent of the RF output power and the injected LO input power.

It is possible to adjust the baseband dc offset balance to suppress the output carrier component. Devices such as the DAC348x DAC family have dc offset adjustment capabilities specifically for this function. The Adjusted Carrier Feedthrough graphs (see [Figure 33](#) through [Figure 38](#)) optimize the performance at the center of the band at room temperature. Then, with the adjusted dc offset values held constant, the parameter is measured over the frequency band and across the temperature extremes. The typical performance plots provide an indication of how well the adjusted carrier suppression can be maintained over frequency and temperature with only one calibration point.

Sideband Suppression

This specification measures the suppression of the undesired sideband at the output of the modulator relative to the desired sideband. If the amplitude and phase within the I and Q branch of the modulator were perfectly matched, the undesired sideband (or image) would be naturally suppressed. Amplitude and phase imbalance in the I and Q branches result in the increase of the undesired sideband. This parameter is measured in dBc relative to the desired sideband.

It is possible to adjust the relative amplitude and phase balance within the baseband lines to suppress the unwanted sideband. Devices such as the DAC348x DAC family have amplitude and phase adjustment control specifically for this function. The Adjusted Sideband Suppression graphs (refer to [Figure 39](#) through [Figure 44](#)) optimize the performance at the center of the band at room temperature. Then, with the adjusted amplitude and phase values held constant, the parameter is measured over the frequency band and across the temperature extremes. The performance plots provide an indication of how well the adjusted sideband suppression can be maintained over frequency and temperature with only one calibration point.

Output Noise

The output noise specifies the absolute noise power density that is output from the RF_{OUT} pin (pin 16). This parameter is expressed in dBm/Hz. This parameter, in conjunction with the OIP3 specification, indicates the dynamic range of the device. In general, at high output signal levels the performance is limited by the linearity of the device; at low output levels, on the other hand, the performance is limited by noise. As a result of the higher gain and output power of the TRF37T05 compared to earlier devices, it is expected that the noise density is slightly higher as well. With its increased gain and high OIP3 performance, the overall dynamic range of the TRF37T05 is maintained at exceptional levels.

Definition of Terms

A simulated output spectrum with two tones is shown in [Figure 76](#), with definitions of various terms used in this data sheet.

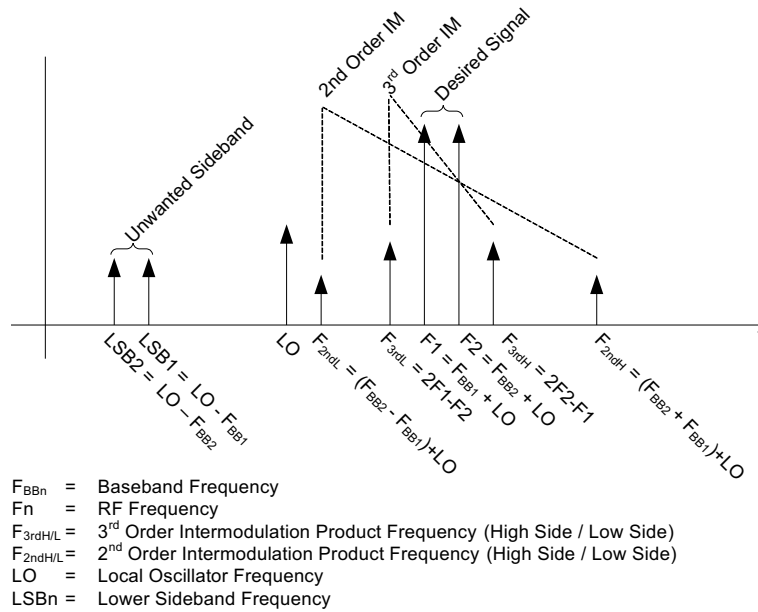

Figure 76. Graphical Illustration of Common Terms

EVALUATION BOARD

Populated RoHS-compliant evaluation boards are available for testing the TRF37T05 as a stand-alone device. Contact your local TI representative for information on ordering these evaluation modules, or see the [TRF37T05 product folder](#) on the TI website. In addition, the TRF37T05 can be evaluated with the DAC348x (quad/dual 16-bit, 1.25GSPS) EVM driving the baseband inputs through a seamless interface at 0.25V common-mode voltage.

PCB Design Guidelines

The TRF37T05 device is fitted with a ground slug on the back of the package that must be soldered to the printed circuit board (PCB) ground with adequate ground vias to ensure a good thermal and electrical connection. The recommended via pattern and ground pad dimensions are shown in [Figure 77](#). The recommended via diameter is 10 mils (0.10 in or 0.25 mm). The ground pins of the device can be directly tied to the ground slug pad for a low-inductance path to ground. Additional ground vias may be added if space allows.

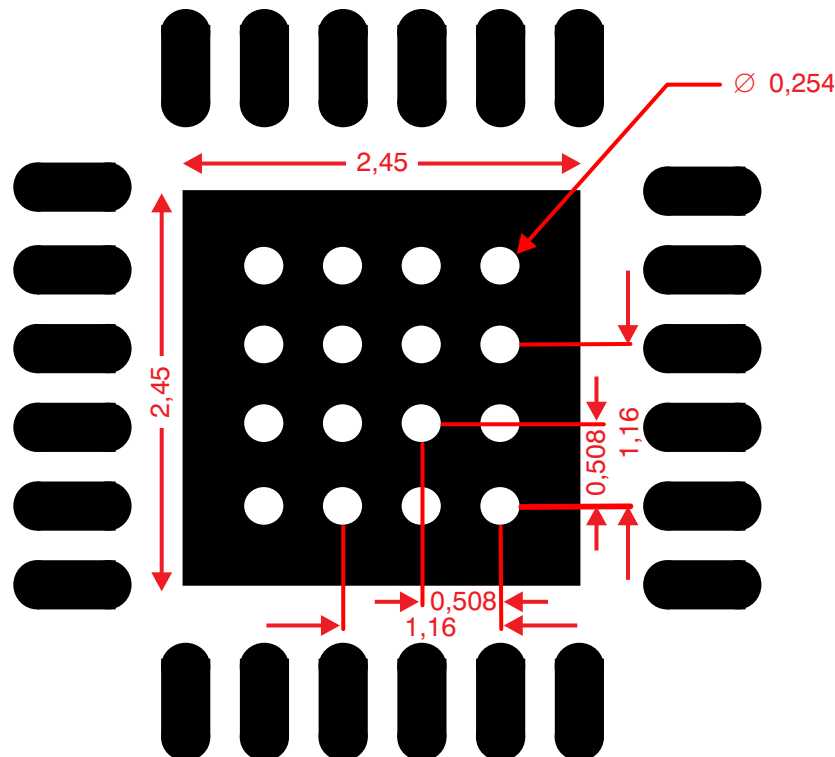



Note: Dimensions are in millimeters (mm).

Figure 77. PCB Ground Via Layout Guide

Decoupling capacitors at each of the supply pins are strongly recommended. The value of these capacitors should be chosen to provide a low-impedance RF path to ground at the frequency of operation. Typically, the value of these capacitors is approximately 10 pF or lower.

The device exhibits symmetry with respect to the quadrature input paths. It is recommended that the PCB layout maintain this symmetry in order to ensure that the quadrature balance of the device is not impaired. The I/Q input traces should be routed as differential pairs and the respective lengths all kept equal to each other. On the RF traces, maintain proper trace widths to keep the characteristic impedance of the RF traces at a nominal 50 Ω .

PACKAGING INFORMATION

Orderable Device	Status (1)	Package Type	Package Drawing	Pins	Package Qty	Eco Plan (2)	Lead finish/ Ball material (6)	MSL Peak Temp (3)	Op Temp (°C)	Device Marking (4/5)	Samples
TRF37T05IRGER	ACTIVE	VQFN	RGE	24	3000	RoHS & Green	NIPDAU	Level-2-260C-1 YEAR	-40 to 85	TR37T05 IRGE	
TRF37T05IRGET	ACTIVE	VQFN	RGE	24	250	RoHS & Green	NIPDAU	Level-2-260C-1 YEAR	-40 to 85	TR37T05 IRGE	

(1) The marketing status values are defined as follows:

ACTIVE: Product device recommended for new designs.

LIFEBUY: TI has announced that the device will be discontinued, and a lifetime-buy period is in effect.

NRND: Not recommended for new designs. Device is in production to support existing customers, but TI does not recommend using this part in a new design.

PREVIEW: Device has been announced but is not in production. Samples may or may not be available.

OBSOLETE: TI has discontinued the production of the device.

(2) **RoHS:** TI defines "RoHS" to mean semiconductor products that are compliant with the current EU RoHS requirements for all 10 RoHS substances, including the requirement that RoHS substance do not exceed 0.1% by weight in homogeneous materials. Where designed to be soldered at high temperatures, "RoHS" products are suitable for use in specified lead-free processes. TI may reference these types of products as "Pb-Free".

RoHS Exempt: TI defines "RoHS Exempt" to mean products that contain lead but are compliant with EU RoHS pursuant to a specific EU RoHS exemption.

Green: TI defines "Green" to mean the content of Chlorine (Cl) and Bromine (Br) based flame retardants meet JS709B low halogen requirements of <=1000ppm threshold. Antimony trioxide based flame retardants must also meet the <=1000ppm threshold requirement.

(3) MSL, Peak Temp. - The Moisture Sensitivity Level rating according to the JEDEC industry standard classifications, and peak solder temperature.

(4) There may be additional marking, which relates to the logo, the lot trace code information, or the environmental category on the device.

(5) Multiple Device Markings will be inside parentheses. Only one Device Marking contained in parentheses and separated by a "~" will appear on a device. If a line is indented then it is a continuation of the previous line and the two combined represent the entire Device Marking for that device.

(6) Lead finish/Ball material - Orderable Devices may have multiple material finish options. Finish options are separated by a vertical ruled line. Lead finish/Ball material values may wrap to two lines if the finish value exceeds the maximum column width.

Important Information and Disclaimer: The information provided on this page represents TI's knowledge and belief as of the date that it is provided. TI bases its knowledge and belief on information provided by third parties, and makes no representation or warranty as to the accuracy of such information. Efforts are underway to better integrate information from third parties. TI has taken and continues to take reasonable steps to provide representative and accurate information but may not have conducted destructive testing or chemical analysis on incoming materials and chemicals. TI and TI suppliers consider certain information to be proprietary, and thus CAS numbers and other limited information may not be available for release.

In no event shall TI's liability arising out of such information exceed the total purchase price of the TI part(s) at issue in this document sold by TI to Customer on an annual basis.

RGE 24

GENERIC PACKAGE VIEW

VQFN - 1 mm max height

PLASTIC QUAD FLATPACK - NO LEAD



Images above are just a representation of the package family, actual package may vary.
Refer to the product data sheet for package details.

4204104/H

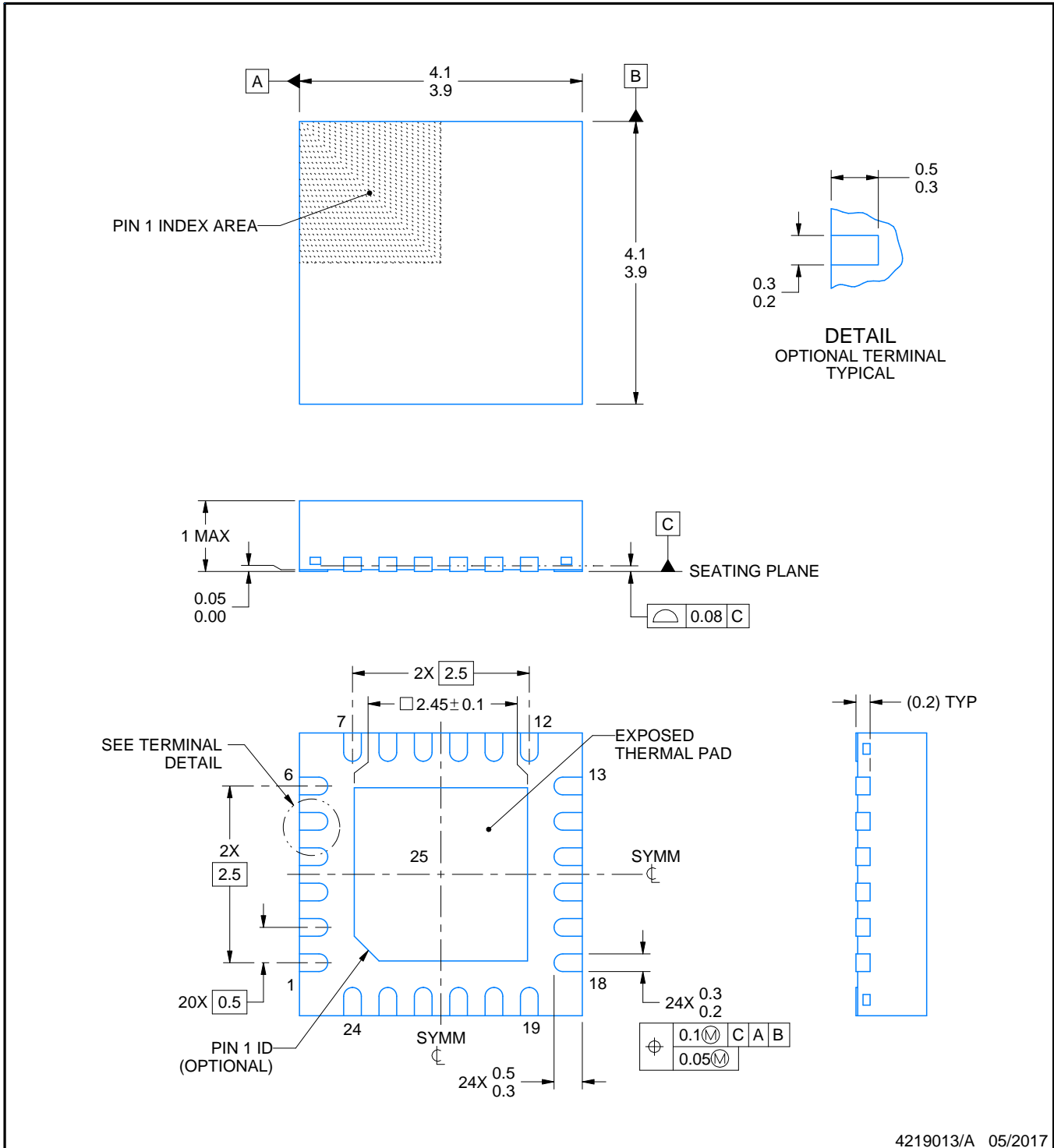
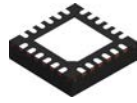

4219013/A 05/2017

NOTES:

1. All linear dimensions are in millimeters. Any dimensions in parenthesis are for reference only. Dimensioning and tolerancing per ASME Y14.5M.
2. This drawing is subject to change without notice.
3. The package thermal pad must be soldered to the printed circuit board for thermal and mechanical performance.

EXAMPLE BOARD LAYOUT

RGE0024B

VQFN - 1 mm max height

PLASTIC QUAD FLATPACK - NO LEAD

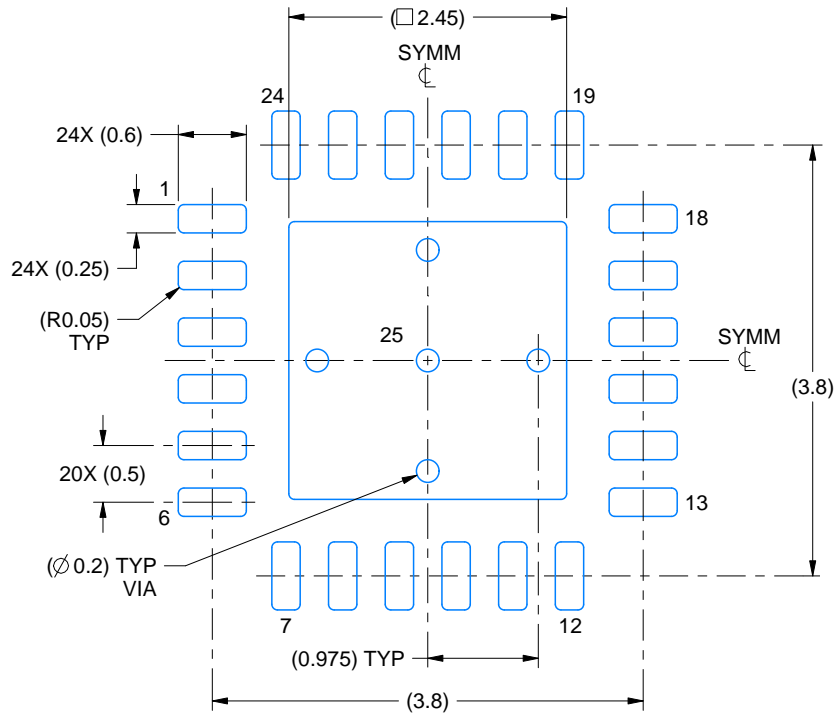

LAND PATTERN EXAMPLE
EXPOSED METAL SHOWN
SCALE:15X

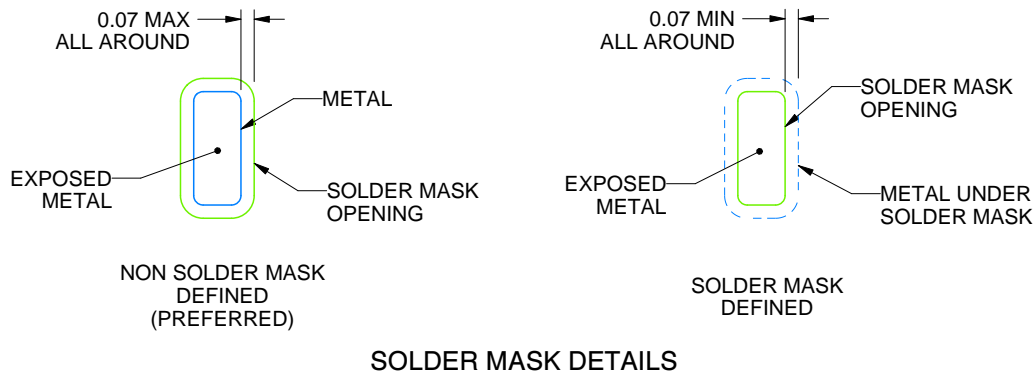

SOLDER MASK DETAILS

4219013/A 05/2017

NOTES: (continued)

4. This package is designed to be soldered to a thermal pad on the board. For more information, see Texas Instruments literature number SLUA271 (www.ti.com/lit/sl原因271).
5. Vias are optional depending on application, refer to device data sheet. If any vias are implemented, refer to their locations shown on this view. It is recommended that vias under paste be filled, plugged or tented.

EXAMPLE STENCIL DESIGN

RGE0024B

VQFN - 1 mm max height

PLASTIC QUAD FLATPACK - NO LEAD

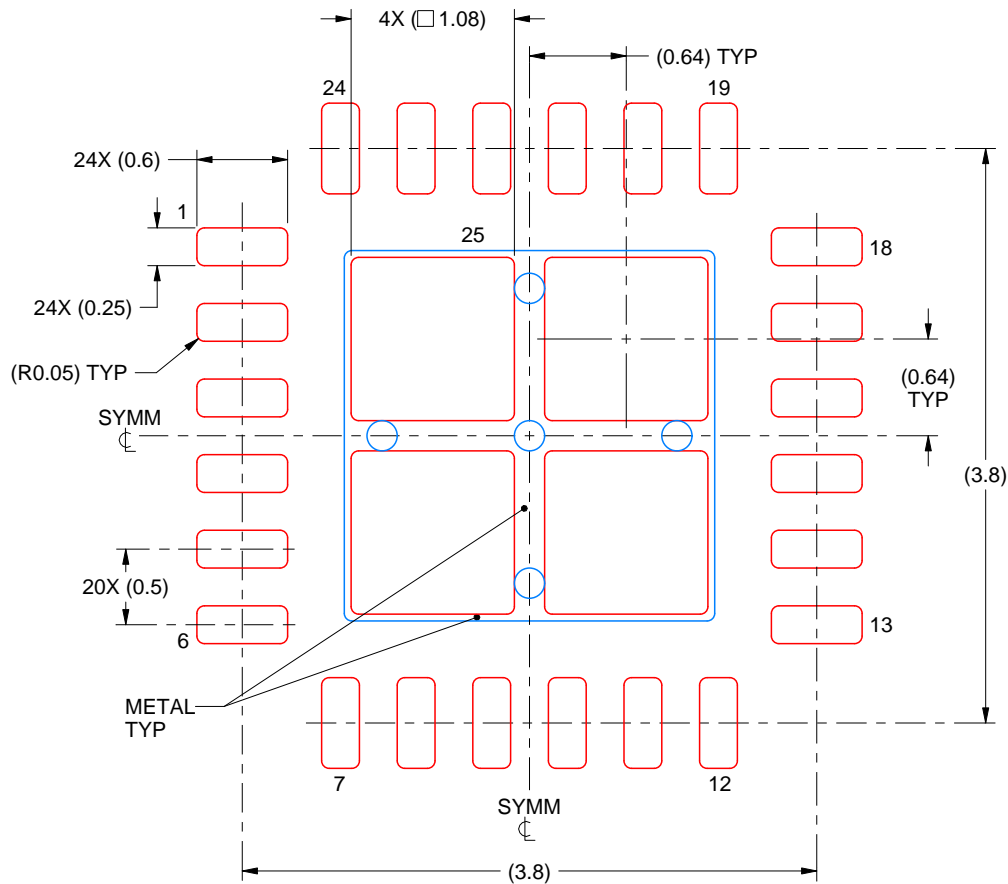

SOLDER PASTE EXAMPLE
BASED ON 0.125 mm THICK STENCIL

EXPOSED PAD 25
78% PRINTED SOLDER COVERAGE BY AREA UNDER PACKAGE
SCALE:20X

4219013/A 05/2017

NOTES: (continued)

6. Laser cutting apertures with trapezoidal walls and rounded corners may offer better paste release. IPC-7525 may have alternate design recommendations.

重要声明和免责声明

TI 均以“原样”提供技术性 & 可靠性数据（包括数据表）、设计资源（包括参考设计）、应用或其他设计建议、网络工具、安全信息和其他资源，不保证其中不含任何瑕疵，且不做任何明示或暗示的担保，包括但不限于对适销性、适合某特定用途或不侵犯任何第三方知识产权的暗示担保。

所述资源可供专业开发人员应用 TI 产品进行设计使用。您将对以下行为独自承担全部责任：(1) 针对您的应用选择合适的 TI 产品；(2) 设计、验证并测试您的应用；(3) 确保您的应用满足相应标准以及任何其他安全、安保或其他要求。所述资源如有变更，恕不另行通知。TI 对您使用所述资源的授权仅限于开发资源所涉及 TI 产品的相关应用。除此之外不得复制或展示所述资源，也不提供其它 TI 或任何第三方的知识产权授权许可。如因使用所述资源而产生任何索赔、赔偿、成本、损失及债务等，TI 对此概不负责，并且您须赔偿由此对 TI 及其代表造成的损害。

TI 所提供产品均受 TI 的销售条款 (<http://www.ti.com.cn/zh-cn/legal/termsofsale.html>) 以及 [ti.com.cn](http://www.ti.com.cn) 上或随附 TI 产品提供的其他可适用条款的约束。TI 提供所述资源并不扩展或以其他方式更改 TI 针对 TI 产品所发布的可适用的担保范围或担保免责声明。

邮寄地址：上海市浦东新区世纪大道 1568 号中建大厦 32 楼，邮政编码：200122
Copyright © 2020 德州仪器半导体技术（上海）有限公司