

# TPS54116-Q1 2.95V 至 6V 输入、4A 降压转换器和 1A 拉/灌电流 DDR 终端稳压器

## 1 特性

- 具有符合 AEC-Q100 标准的下列结果：
  - 器件温度 1 级：-40°C 至 +125°C 的环境运行温度范围
  - 器件人体模型 (HBM) 静电放电 (ESD) 分类等级 2
  - 器件组件充电模式 (CDM) ESD 分类等级 C6
- 单片 DDR2、DDR3 和 DDR3L 存储器电源解决方案
- 4A 同步降压转换器
  - 集成了 33mΩ 高侧和 25mΩ 低侧金属氧化物半导体场效应晶体管 (MOSFET)
  - 固定频率电流模式控制
  - 可调频率范围：100kHz 至 2.5MHz
  - 与一个外部时钟同步
  - 整个温度范围内的电压基准为  $0.6V \pm 1\%$
  - 可调逐周期峰值电流限制
  - 针对预偏置输出的单调性启动
- 直流精度为  $\pm 20mV$  的 1A 拉/灌电流终端低压降 (LDO) 稳压器
  - 与  $2 \times 10\mu F$  多层陶瓷电容 (MLCC) 电容一起工作时保持稳定
  - 10mA 拉/灌电流缓冲参考输出稳定在 VDDQ 的 49% 至 51% 之间
- 独立使能引脚，欠压闭锁 (UVLO) 和迟滞均可调
- 热关断
- 运行温度 ( $T_J$ ) 范围：-40°C 至 150°C
- 24 引脚 4mm x 4mm 超薄四方扁平无引线 (WSON) 封装

## 2 应用

- 嵌入式计算系统中的 DDR2、DDR3、DDR3L 和 DDR4 存储器电源
- SSTL\_18、SSTL\_15、SSTL\_135、SSTL\_12 和 HSTL 终端
- 信息娱乐和仪表板
- 先进的驾驶员辅助系统 (ADAS)

## 3 说明

TPS54116-Q1 器件是一款功能全面的 6V、4A 同步降压转换器，其配有两个集成型 MOSFET 以及带 VTTREF 缓冲参考输出的 1A 拉/灌电流双倍数据速率 (DDR) VTT 终端稳压器。

TPS54116-Q1 降压稳压器通过集成 MOSFET 和减小电感尺寸来最大限度减小解决方案尺寸，开关频率最高达 2.5MHz。开关频率可设置在中波频段以上以满足噪声敏感型应用的需求，而且能够与外部时钟同步。同步整流使频率在整个输出负载范围内保持为固定值。效率通过集成 25mΩ 低侧 MOSFET 和 33mΩ 高侧 MOSFET 得到了最大限度的提升。逐周期峰值电流限制在过流状态下保护器件，并且可通过 ILIM 引脚上的电阻进行调整，从而针对小尺寸电感进行优化。

VTT 终端稳压器仅利用  $2 \times 10\mu F$  的陶瓷输出电容即可保持快速瞬态响应，从而减少外部组件数量。

TPS54116-Q1 使用 VTT 进行远程感测，从而实现最佳的稳压效果。

该器件可利用使能引脚进入关断模式，从而使电源电流降至  $1\mu A$ 。欠压闭锁阈值可通过任一使能引脚上的电阻网络进行设置。VTT 和 VTTREF 输出被 ENLDO 禁用时会进行放电。

该器件具备全集成特性，并且采用小尺寸的 4mm x 4mm 耐热增强型 WQFN 封装，最大限度地减小了 IC 尺寸。

器件信息(1)

器件型号	封装	封装尺寸 (标称值)
TPS54116-Q1	WQFN (24)	4.00mm x 4.00mm

(1) 如需了解所有可用封装，请见数据表末尾的可订购产品附录。

简化电路原理图

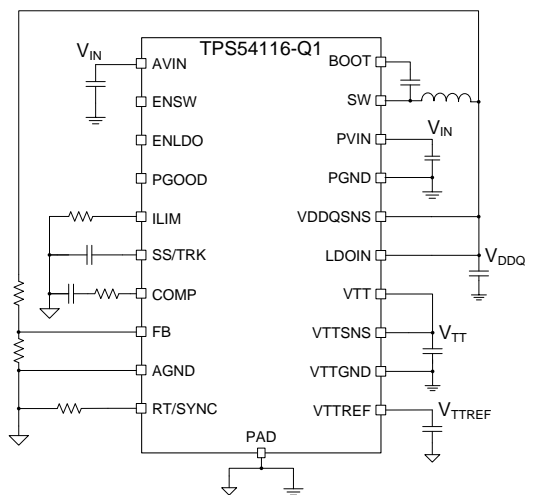

Copyright © 2016, Texas Instruments Incorporated



## 目录

1	特性 .....	1	7.4	Device Functional Modes.....	23
2	应用 .....	1	<b>8</b>	<b>Application and Implementation .....</b>	<b>24</b>
3	说明 .....	1	8.1	Application Information.....	24
4	修订历史记录 .....	2	8.2	Typical Application .....	25
<b>5</b>	<b>Pin Configuration and Functions .....</b>	<b>3</b>	<b>9</b>	<b>Power Supply Recommendations .....</b>	<b>34</b>
<b>6</b>	<b>Specifications.....</b>	<b>4</b>	<b>10</b>	<b>Layout.....</b>	<b>34</b>
6.1	Absolute Maximum Ratings .....	4	10.1	Layout Guidelines .....	34
6.2	ESD Ratings .....	4	10.2	Layout Example .....	35
6.3	Recommended Operating Conditions.....	5	<b>11</b>	<b>器件和文档支持 .....</b>	<b>36</b>
6.4	Thermal Information .....	5	11.1	接收文档更新通知 .....	36
6.5	Electrical Characteristics.....	5	11.2	社区资源 .....	36
6.6	Typical Characteristics .....	8	11.3	商标 .....	36
<b>7</b>	<b>Detailed Description .....</b>	<b>15</b>	11.4	静电放电警告.....	36
7.1	Overview .....	15	11.5	Glossary .....	36
7.2	Functional Block Diagram .....	16	<b>12</b>	<b>机械、封装和可订购信息.....</b>	<b>36</b>
7.3	Feature Description.....	17			

## 4 修订历史记录

### Changes from Original (August 2016) to Revision A

**Page**

•	Changed pin 18 From: RT/CLK To: RT/SYNC in the <i>Pin Functions</i> table .....	4
•	Changed $R_{(RT/CLK)}$ To: $R_{(RT/SYNC)}$ in <a href="#">图 16</a> 和 <a href="#">图 17</a> .....	9
•	Changed "The RT/CLK is typically 0.5 V.." To: "The RT/SYNC is typically 0.5 V.." in <a href="#">Constant Switching Frequency and Timing Resistor (RT/SYNC)</a> .....	20

## 5 Pin Configuration and Functions

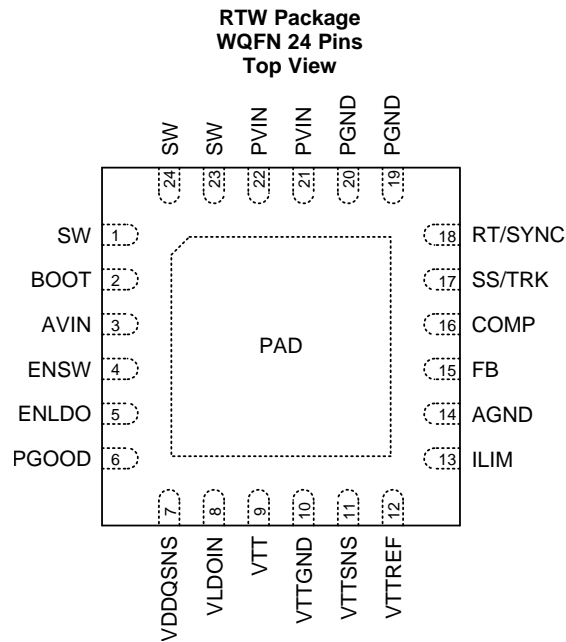

### Pin Functions

PIN		I/O	DESCRIPTION
NAME	NO.		
SW	1, 23, 24	O	Switching node of the buck converter.
BOOT	2	I	Bootstrap capacitor node for high-side MOSFET gate driver of the buck converter. Connect the bootstrap capacitor from this pin to the SW pin.
AVIN	3	I	The input supply pin to the IC, powering the control circuits of both the buck converter and DDR termination regulator. Connect AVIN to a supply voltage between 2.95 V and 6 V.
ENSW	4	I	Buck converter enable pin with internal pull-up current source. Floating this pin will enable the IC. Pull below 1.17 V to enter low current standby mode. Pull below 0.4 V to enter shutdown mode. The ENSW pin can be used to implement adjustable under-voltage lockout (UVLO) using two resistors.
ENLDO	5	I	VTT LDO enable pin with internal pull-up current source. Floating this pin will enable the IC. Pull below 1.17 V to enter low current standby mode. Pull below 0.4 V to enter shutdown mode. The ENLDO pin can be used to implement adjustable under-voltage lockout (UVLO) using two resistors.
PGOOD	6	O	Power good indicator for the buck regulator. This pin is an open-drain output. A 10-k $\Omega$ pull-up resistor is recommended between PGOOD and AVIN or an external logic supply pin.
VDDQSNS	7	I	VDDQ sense input to generate VDDQ/2 reference for VTTREF.
LDOIN	8	I	Power supply input for VTT LDO. Connected VDDQ in typical application. Alternatively this pin can be used for split-rail configuration to reduce power dissipation when sourcing current to the VTT output by powering the VTT LDO with a lower voltage.
VTT	9	O	1-A LDO output. Connect 2 x 10- $\mu$ F ceramic capacitors to VTTGND for stability.
VTTGND	10	I	Power ground for VTT LDO.
VTTSNS	11	I	VTT LDO voltage feedback.
VTTREF	12	O	Buffered low-noise VTT reference output. Connect to a 0.22 $\mu$ F or larger ceramic capacitor to AGND for stability.
ILIM	13	I	Programmable current limit pin. An internal amplifier holds this pin at a fixed voltage then sets the high-side MOSFET peak current limit based on the value of an external resistor to AGND.
AGND	14	I	Analog signal ground of the IC. AGND should be connected to PGND via a single point on the PCB, typically to the thermal pad.

**Pin Functions (continued)**

PIN		I/O	DESCRIPTION
NAME	NO.		
FB	15	I	Error amplifier inverting input and feedback pin for voltage regulation of the buck converter. Connect this pin to the center of a resistor divider to set the output voltage of the buck converter. The resistor divider should go from the regulated output voltage to AGND.
COMP	16	I	Output of the internal transconductance error amplifier for the buck converter. The feedback loop compensation network is connected from this pin to AGND.
SS/TRK	17	I	Soft-start programming pin. A capacitor between the SS/TRK pin and AGND pin sets soft-start time. The voltage on this pin overrides the internal reference allowing it to be used for tracking and sequencing.
RT/SYNC	18	I	Resistor Timing and External Clock. An internal amplifier holds this pin at a fixed voltage when using an external resistor to AGND to set the switching frequency. If the pin is pulled above the upper threshold, a mode change occurs and the pin becomes a synchronization input. The internal amplifier is disabled and the pin is a high impedance clock input. If clocking edges stop, the internal amplifier is re-enabled and the operating mode returns to resistor frequency programming.
PGND	19, 20	I	Power ground of the buck regulator. PGND should be connected to AGND via a single point on PCB board, typically to the thermal pad.
PVIN	21, 22	I	The input supply pin for power MOSFETs. Connect PVIN to a supply voltage between 2.95 V and 6 V.
PAD		–	The exposed thermal pad must be electrically connected to AGND and PGND on the printed circuit board for proper operation. Connect to the largest possible copper area for best thermal performance.

## 6 Specifications

### 6.1 Absolute Maximum Ratings

 over operating free-air temperature range (unless otherwise noted) <sup>(1)</sup>

		MIN	MAX	UNIT
Voltage Range	PVIN, AVIN, ENSW, ENLDO, PGOOD	-0.3	7	V
	FB, COMP, SS/TRK, ILIM	-0.3	3	V
	RT/SYNC	-0.3	6	V
	BOOT with respect to SW	-0.3	7	V
	LDOIN, VTTSNS, VDDQSNS	-0.3	3.6	V
	SW	-0.6	7	V
	SW, 10-ns transient	-4	10	V
	VTT, VTTREF	-0.3	3.6	V
Current Range	RT/SYNC	-100	100	μA
	PGOOD	-5	5	mA
Operating junction temperature		-40	150	°C
Storage temperature, T <sub>stg</sub>		-65	150	°C

(1) Stresses beyond those listed under *Absolute Maximum Ratings* may cause permanent damage to the device. These are stress ratings only, which do not imply functional operation of the device at these or any other conditions beyond those indicated under *Recommended Operating Conditions*. Exposure to absolute-maximum-rated conditions for extended periods may affect device reliability.

### 6.2 ESD Ratings

			VALUE	UNIT
V <sub>(ESD)</sub>	Electrostatic discharge	Human body model (HBM), per ANSI/ESDA/JEDEC JS-001, all pins <sup>(1)</sup>	±2000	V
		Charged device model (CDM), per JEDEC specification JESD22-C101, all pins <sup>(2)</sup>	±1000	

(1) JEDEC document JEP155 states that 500-V HBM allows safe manufacturing with a standard ESD control process.

(2) JEDEC document JEP157 states that 250-V CDM allows safe manufacturing with a standard ESD control process.

### 6.3 Recommended Operating Conditions

over operating free-air temperature range (unless otherwise noted)

		MIN	MAX	UNIT
$V_{(AVIN)}, V_{(PVIN)}$	Input voltage	2.95	6	V
$V_{OUT}$	Buck output voltage	0.6	4.5	V
$I_{OUT}$	Buck output current	0	4	A
$V_{(VDDQSNS)}$	VDDQSNS input voltage	1	3.5	V
$V_{(LDOIN)}$	LDOIN input voltage	VTT + VDO	3.5	V
$V_{(VTT)}, V_{(VTTREF)}$	VTT and VTTREF output voltage	0.5	3.5	V

### 6.4 Thermal Information

THERMAL METRIC <sup>(1)</sup>		TPS54116-Q1	UNIT
		RTW (WQFN)	
		24 PINS	
$R_{\theta JA}$	Junction-to-ambient thermal resistance	36.2	°C/W
$R_{\theta JC(top)}$	Junction-to-case (top) thermal resistance	35.0	
$R_{\theta JB}$	Junction-to-board thermal resistance	14.3	
$\psi_{JT}$	Junction-to-top characterization parameter	0.4	
$\psi_{JB}$	Junction-to-board characterization parameter	14.4	
$R_{\theta JC(bot)}$	Junction-to-case (bottom) thermal resistance	4.6	

(1) For more information about traditional and new thermal metrics, see the [IC Package Thermal Metrics](#) application report.

### 6.5 Electrical Characteristics

TJ = -40°C to 150°C, AVIN = PVIN = 2.95 V to 6 V, VLDOIN = VDDQSNS (unless otherwise noted)

PARAMETER	TEST CONDITIONS	MIN	TYP	MAX	UNIT
<b>SUPPLY VOLTAGE (AVIN and PVIN PINS)</b>					
AVIN and PVIN operating		2.95		6	V
AVIN internal UVLO threshold	AVIN rising		2.7	2.8	V
AVIN internal UVLO hysteresis			0.05	0.12	V
Iq shutdown	$V_{(ENSW)} = V_{(ENLDO)} = 0\text{ V}$ , $V_{(VDDQSNS)} = 1.8\text{ V}$ , TJ = 25°C		1	3.5	µA
Iq operating — LDO and buck enabled	$V_{(ENSW)} = V_{(ENLDO)} = V_{(AVIN)} = 5\text{ V}$ , $V_{(FB)} = 0.7\text{ V}$ , $V_{(VDDQSNS)} = 1.8\text{ V}$ , TJ = 25°C		650	800	µA
Iq operating — LDO enabled, buck disabled	$V_{(ENLDO)} = V_{(AVIN)} = 5\text{ V}$ , $V_{(ENSW)} = 0\text{ V}$ , $V_{(VDDQSNS)} = 1.8\text{ V}$ , TJ = 25°C		190	300	µA
Iq operating — LDO disabled, buck enabled	$V_{(ENSW)} = V_{(AVIN)} = 5\text{ V}$ , $V_{(ENLDO)} = 0\text{ V}$ , $V_{(FB)} = 0.7\text{ V}$ , $V_{(VDDQSNS)} = 1.8\text{ V}$ , TJ = 25°C		570	700	µA
<b>ENABLE (ENSW and ENLDO PINS)</b>					
$V_{ENRISING}$	ENLDO rising threshold	ENLDO voltage ramping up		1.20	V
$V_{ENFALLING}$	ENLDO falling threshold	ENLDO voltage ramping down		1.17	
	ENLDO input current above voltage threshold	$V_{(ENLDO)} = \text{Enable threshold} + 50\text{ mV}$		-4.4	µA
$I_p$	ENLDO input current below voltage threshold	$V_{(ENLDO)} = \text{Enable threshold} - 50\text{ mV}$		-1.7	
$I_h$	ENLDO hysteresis current			-2.7	
$V_{ENRISING}$	ENSW rising threshold	ENSW voltage ramping up		1.20	V
$V_{ENFALLING}$	ENSW falling threshold	ENSW voltage ramping down		1.17	
	ENSW input current above voltage threshold	$V_{(ENSW)} = \text{Enable threshold} + 50\text{ mV}$		-4.4	µA
$I_p$	ENSW input current below voltage threshold	$V_{(ENSW)} = \text{Enable threshold} - 50\text{ mV}$		-1.7	
$I_h$	ENSW hysteresis current			-2.7	
	Input current above voltage threshold with ENLDO and ENSW connected	$V_{(ENLDO)} = V_{(ENSW)} = \text{Enable threshold} + 50\text{ mV}$		-8.5	µA

**Electrical Characteristics (continued)**

TJ = -40°C to 150°C, AVIN = PVIN = 2.95 V to 6 V, VLDOIN = VDDQSNS (unless otherwise noted)

PARAMETER	TEST CONDITIONS	MIN	TYP	MAX	UNIT
Input current below voltage threshold with ENLDO and ENSW connected	$V_{(ENLDO)} = V_{(ENSW)} = \text{Enable threshold} - 50 \text{ mV}$		-3.4		$\mu\text{A}$
Hysteresis current with ENLDO and ENSW connected			-5.1		$\mu\text{A}$
<b>VOLTAGE REFERENCE AND ERROR AMPLIFIER (FB AND COMP PINS)</b>					
$V_{REF}$ Voltage Reference		0.594	0.6	0.606	V
FB pin input current			7		nA
$g_{mEA}$ Error Amp transconductance (gm)	$-2 \mu\text{A} < I_{(COMP)} < 2 \mu\text{A}, V_{(COMP)} = 1 \text{ V}$		260	360	$\mu\text{S}$
Error Amp source/sink	$V_{(COMP)} = 1 \text{ V}, V_{(FB)} = 100 \text{ mV overdrive}$		22		$\mu\text{A}$
<b>MOSFETS AND POWER STAGE (SW AND BOOT PINS)</b>					
High side switch resistance	$V_{(BOOT-SW)} = 5 \text{ V}$		33	66	m $\Omega$
	$V_{(BOOT-SW)} = 3.3 \text{ V}$		42	84	
Low side switch resistance	$V_{(PVIN)} = 5 \text{ V}$		25	50	m $\Omega$
	$V_{(PVIN)} = 3.3 \text{ V}$		30	60	
BOOT-SW UVLO	$V_{(PVIN)} = 2.95 \text{ V}$		2.2		V
High-side FET current limit	$V_{(PVIN)} = 6 \text{ V}, R_{(ILIM)} = 100\text{k}$	5.2	6.6	8.2	A
High-side FET current limit	$V_{(PVIN)} = 6 \text{ V}, R_{(ILIM)} = 200\text{k}$	1.5	3	3.8	A
Low-side FET reverse current limit		2	4.5		A
$g_{mPS}$ $V_{(COMP)}$ to $I_{(SW)}$ peak transconductance	$R_{(ILIM)} = 100\text{k}$		16		A/V
Minimum pulse width	Measured at 50% points on $V_{(SW)}$ , $I_{OUT} = 2 \text{ A}$		60		ns
Minimum pulse width	Measured at 50% points $V_{(SW)}$ , $V_{(PVIN)} = 5 \text{ V}$ , $I_{OUT} = 0 \text{ A}$ , TJ = -40°C to 125°C		100	125	ns
Minimum off-time	Prior to skipping off pulses, $I_{OUT} = 2 \text{ A}$		60		ns
<b>TIMING RESISTOR AND EXTERNAL CLOCK (RT/SYNC PIN)</b>					
Switching frequency range using RT mode		100		2500	kHz
Switching frequency	$R_{(RT/SYNC)} = 150 \text{ k}\Omega$	370	400	430	kHz
	$R_{(RT/SYNC)} = 27 \text{ k}\Omega$	1910	2070	2230	kHz
	$V_{(RT/SYNC)} > 2.2 \text{ V}$ or $V_{(RT/SYNC)} < 0.35 \text{ V}$	340	420	480	kHz
Switching frequency range using SYNC mode		100		2500	kHz
Minimum SYNC input pulse width		10			ns
RT/SYNC high threshold			1.5	2.2	V
RT/SYNC low threshold		0.35	0.4		V
RT/SYNC rising edge to SW rising edge delay	$f_{SW} = 500 \text{ kHz}$	30	45	80	ns
RT to SYNC lock in time	$R_{(RT/SYNC)} = 150 \text{ k}\Omega$		55		$\mu\text{s}$
SYNC to RT lock in time			60		$\mu\text{s}$
Internal RT to SYNC lock in time	Logic high or logic low at RT/SYNC to SYNC signal		55		$\mu\text{s}$
SYNC to internal RT lock in time	SYNC signal to logic high or logic low at RT/SYNC		60		$\mu\text{s}$
<b>SOFT START AND TRACKING (SS/TRK PIN)</b>					
$V_{SSTHR}$ SS voltage threshold			0.15		V
$I_{SS}$ Charge Current	$V_{(SS/TRK)} < V_{SSTHR}$		47		$\mu\text{A}$
	$V_{(SS/TRK)} > V_{SSTHR}$	1.5	2.4	3.2	$\mu\text{A}$
SS/TRK to FB matching	$V_{(SS/TRK)} = 0.3 \text{ V}$		60		mV
SS/TRK to reference crossover	98% normal		0.85	1	V
SS/TRK discharge voltage (overload)	$V_{(FB)} = 0 \text{ V}$		120		mV
SS/TRK discharge voltage (fault)	$V_{(FB)} = 0 \text{ V}$		5		mV
SS/TRK discharge current (overload)	$V_{(FB)} = 0 \text{ V}, V_{(SS/TRK)} = 0.4 \text{ V}$		160		$\mu\text{A}$

**Electrical Characteristics (continued)**

T<sub>J</sub> = -40°C to 150°C, AVIN = PVIN = 2.95 V to 6 V, VLDOIN = VDDQSNS (unless otherwise noted)

PARAMETER	TEST CONDITIONS	MIN	TYP	MAX	UNIT
SS/TRK discharge current (AVIN UVLO, ENSW low, thermal fault)	V <sub>(AVIN)</sub> = 5 V, V <sub>(SS/TRK)</sub> = 0.4 V		760		μA
<b>POWER GOOD (PGOOD PIN)</b>					
Threshold	V <sub>(FB)</sub> falling (fault)		91	95	% V <sub>REF</sub>
	V <sub>(FB)</sub> rising (good)		94		
	V <sub>(FB)</sub> rising (fault)	105	109		
	V <sub>(FB)</sub> falling (good)		106		
Hysteresis	V <sub>(FB)</sub> falling and rising		3		
Output high leakage	V <sub>(FB)</sub> = V <sub>REF</sub> , V <sub>(PGOOD)</sub> = 5.5 V		5	125	nA
On resistance	V <sub>(AVIN)</sub> = 2.95 V		85	170	Ω
Minimum V <sub>(AVIN)</sub> for valid output	V <sub>(PGOOD)</sub> < 0.5 V, I <sub>(PGOOD)</sub> = 100 μA		1.3	1.7	V
<b>TERMINATION REGULATOR INPUTS (VLDOIN AND VDDQSNS PINS)</b>					
V <sub>(LDOIN)</sub> Operating				3.5	V
V <sub>DO</sub> DC V <sub>(LDOIN)</sub> – V <sub>(VTT)</sub> dropout	1.2 V < V <sub>(VDDQSNS)</sub> < 2.5 V, I <sub>(VTT)</sub> = 0.5 A, V <sub>(VTT)</sub> = V <sub>(VTTREF)</sub> - 40 mV			0.15	V
V <sub>DO</sub> DC V <sub>(LDOIN)</sub> – V <sub>(VTT)</sub> dropout	1.2 V < V <sub>(VDDQSNS)</sub> < 2.5 V, I <sub>(VTT)</sub> = 1.5 A, V <sub>(VTT)</sub> = V <sub>(VTTREF)</sub> - 40 mV			0.45	V
VLDOIN supply current	V <sub>(LDOIN)</sub> = 1.8 V, T <sub>J</sub> = 25°C			1	μA
VDDQSNS input current	V <sub>(VDDQSNS)</sub> = 1.8 V		39	46	μA
<b>VTTREF OUTPUT (VTTREF PIN)</b>					
V <sub>(VTTREF)</sub> VTTREF output voltage			V <sub>(VDDQSNS)/2</sub>		V
V <sub>(VTTREF)TOL</sub> VTTREF output voltage difference from V <sub>(VDDQSNS)/2</sub>	I <sub>(VTTREF)</sub>   < 10 mA, V <sub>(VDDQSNS)</sub> = 1.8 V	-18		18	mV
	I <sub>(VTTREF)</sub>   < 10 mA, V <sub>(VDDQSNS)</sub> = 1.5 V	-15		15	
	I <sub>(VTTREF)</sub>   < 10 mA, V <sub>(VDDQSNS)</sub> = 1.2 V	-15		15	
	I <sub>(VTTREF)</sub>   < 5 mA, V <sub>(VDDQSNS)</sub> = 1.2 V	-12		12	
I <sub>(VTTREF)SRC</sub> VTTREF source current limit	V <sub>(VDDQSNS)</sub> = 1.8 V, V <sub>(VTTREF)</sub> = 0 V	10	18		mA
I <sub>(VTTREF)SNK</sub> VTTREF sink current limit	V <sub>(VDDQSNS)</sub> = 0 V, V <sub>(VTTREF)</sub> = 1.8 V	10	19		mA
I <sub>(VTTREF)DIS</sub> VTTREF discharge current	T <sub>J</sub> = 25°C, V <sub>(VTTREF)</sub> = 0.5V, V <sub>(ENLDO)</sub> = 0 V	0.9	1.1		mA
<b>VTT OUTPUT (VTT PIN)</b>					
V <sub>(VTT)</sub> VTT output voltage			V <sub>(VTTREF)</sub>		V
V <sub>(VTT)TOL</sub> VTT output voltage tolerance to VTTREF	I <sub>(VTT)</sub>   ≤ 10 mA, 1.2 V ≤ V <sub>(VDDQSNS)</sub> ≤ 1.8 V	-20		20	mV
	I <sub>(VTT)</sub>   ≤ 1 A, 1.2 V ≤ V <sub>(VDDQSNS)</sub> ≤ 1.8 V	-30		30	
	I <sub>(VTT)</sub>   ≤ 1.5 A, 1.2 V ≤ V <sub>(VDDQSNS)</sub> ≤ 1.8 V	-40		40	
I <sub>(VTT)SRC</sub> VTT source current limit	V <sub>(VDDQSNS)</sub> = 1.8 V, V <sub>(VTT)</sub> = V <sub>(VTTSENS)</sub> = 0.7 V	1.5	2.5		A
I <sub>(VTT)SNK</sub> VTT sink current limit	V <sub>(VDDQSNS)</sub> = 1.8 V, V <sub>(VTT)</sub> = V <sub>(VTTSENS)</sub> = 1.1 V	1.5	2.5		A
I <sub>(VTTSENS)BIAS</sub> VTTSENS input bias current		-0.1		0.1	μA
I <sub>(VTT)DIS</sub> VTT discharge current	T <sub>J</sub> = 25°C, V <sub>(VTT)</sub> = 0.5 V, V <sub>(ENLDO)</sub> = 0 V	4.8	6		mA
<b>THERMAL SHUTDOWN</b>					
Thermal shutdown temperature			175		°C
Thermal shutdown hysteresis			16		°C

## 6.6 Typical Characteristics

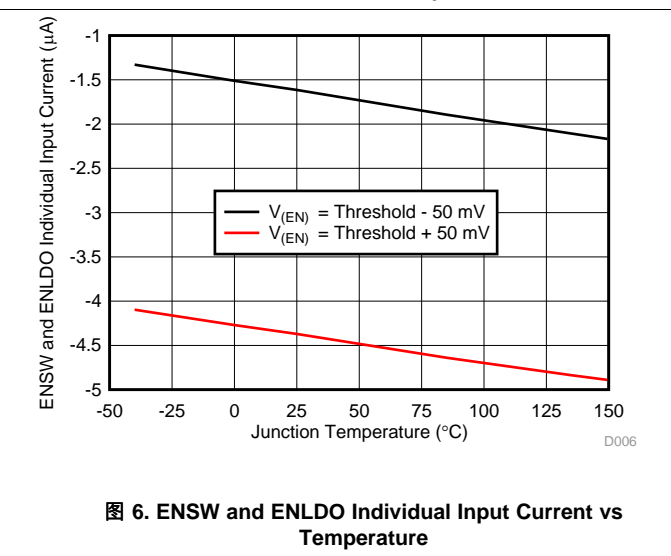
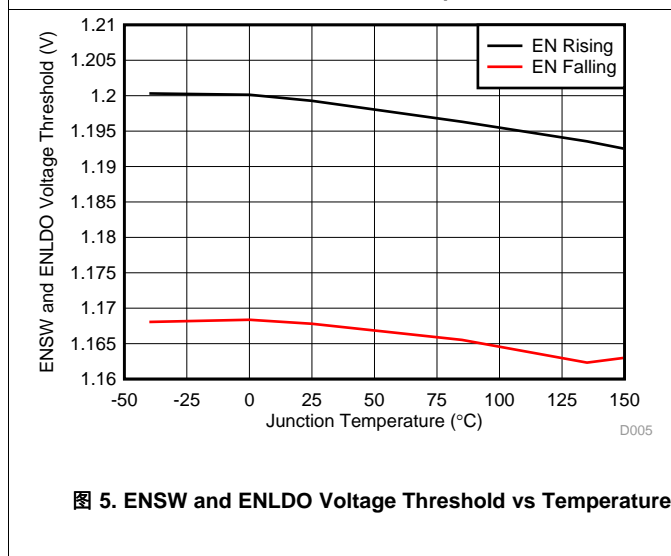
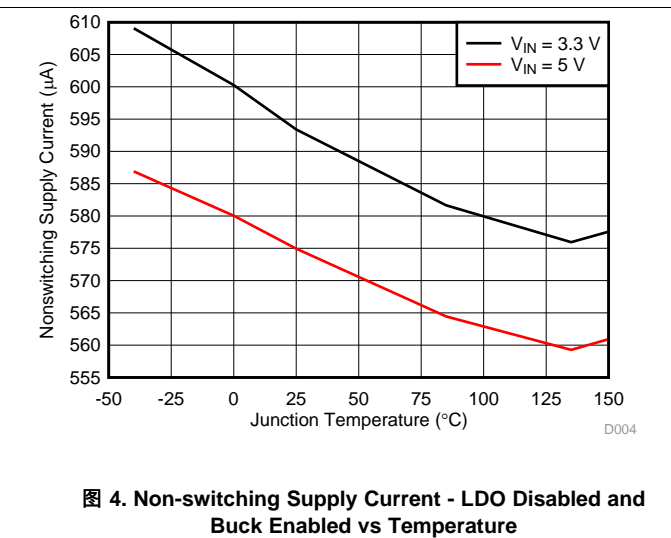
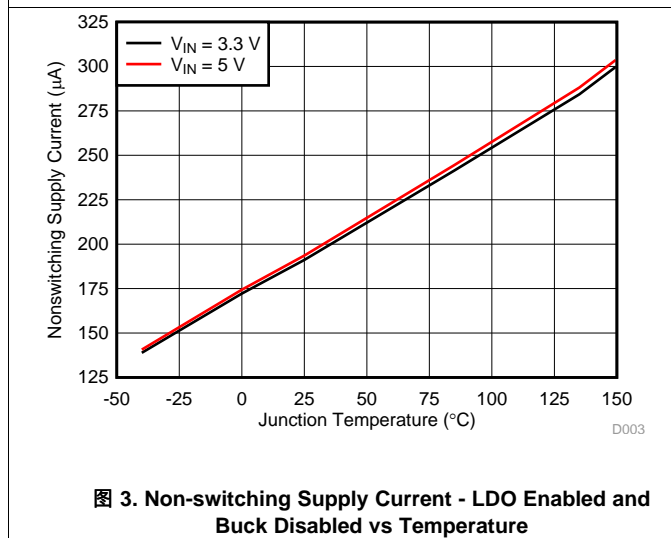
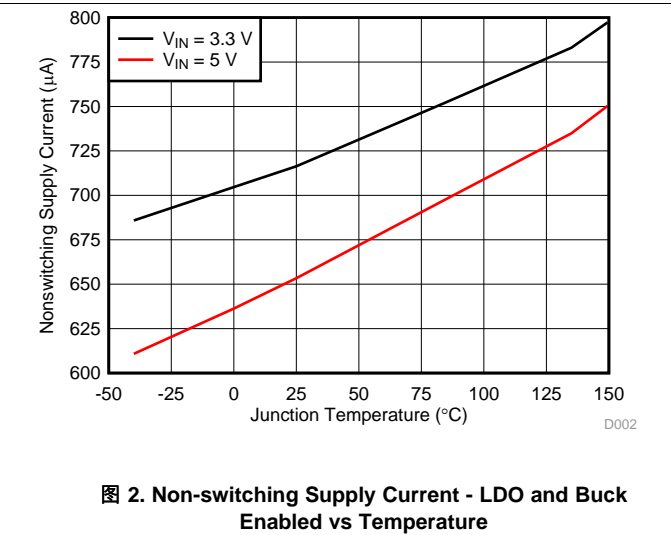
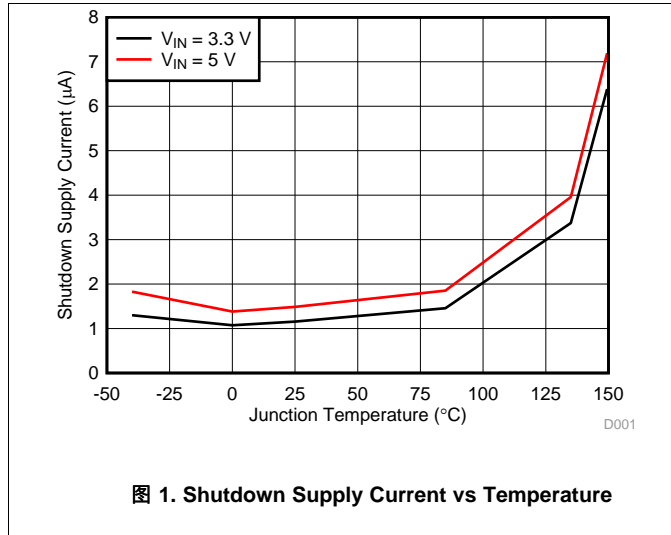



Typical Characteristics (接下页)



图 7. ENSW and ENLDO Parallel Input Current vs Temperature



图 8. Voltage Reference vs Temperature

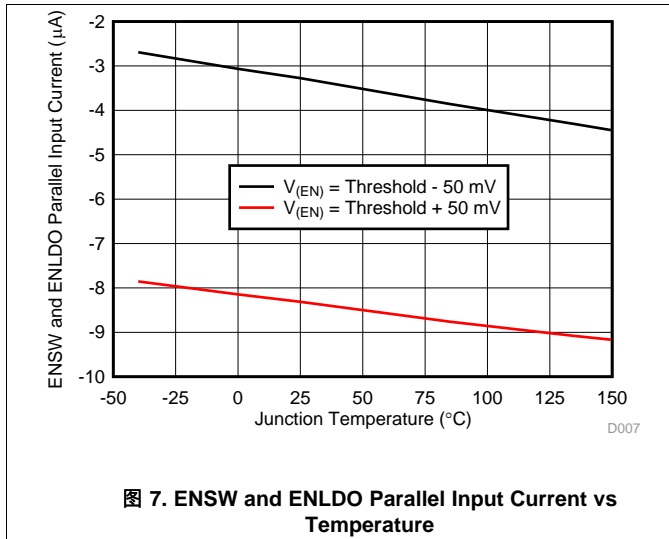

图 9. Error Amplifier Transconductance vs Temperature

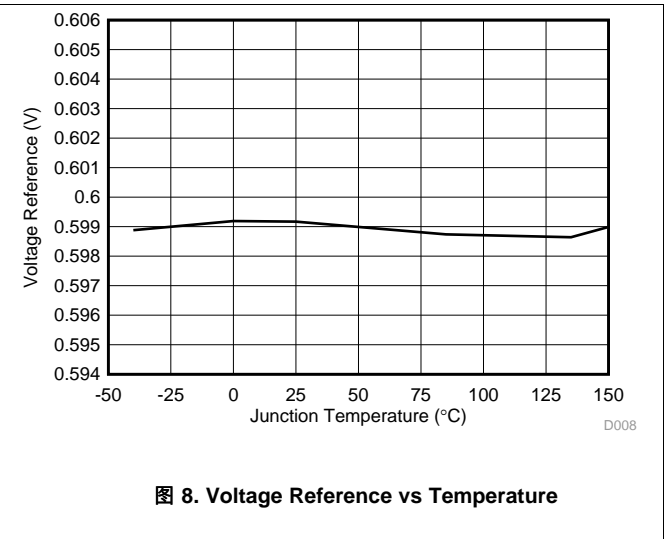

图 10. MOSFET  $R_{ds(on)}$  vs Temperature

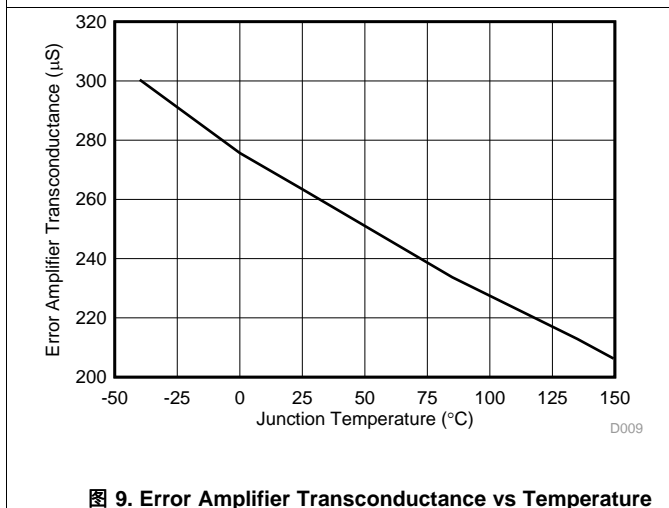

图 11. High-side Current Limit vs Temperature

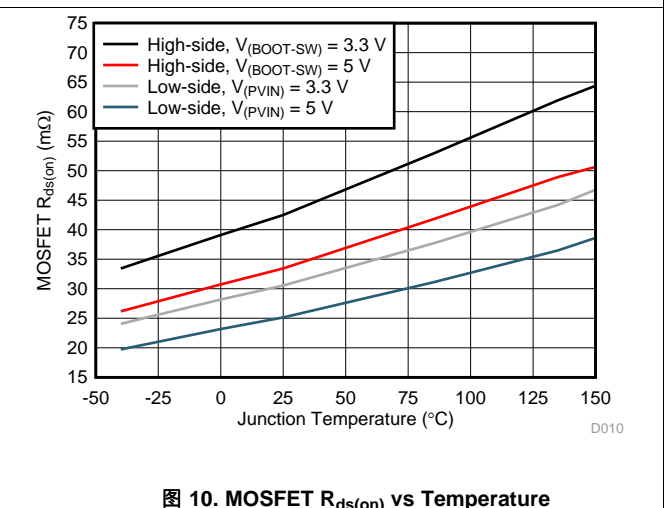

图 12. High-side Current Limit vs  $R_{ILIM}$

Typical Characteristics (接下页)

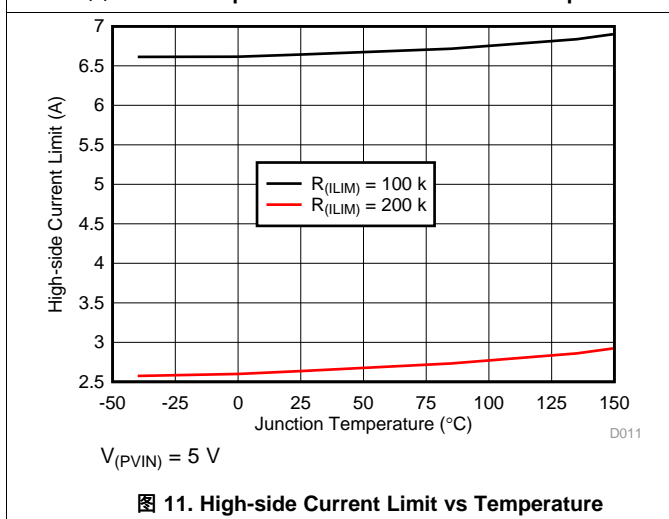

图 13.  $V_{COMP}$  to  $I_{SW}$  Transconductance vs Temperature

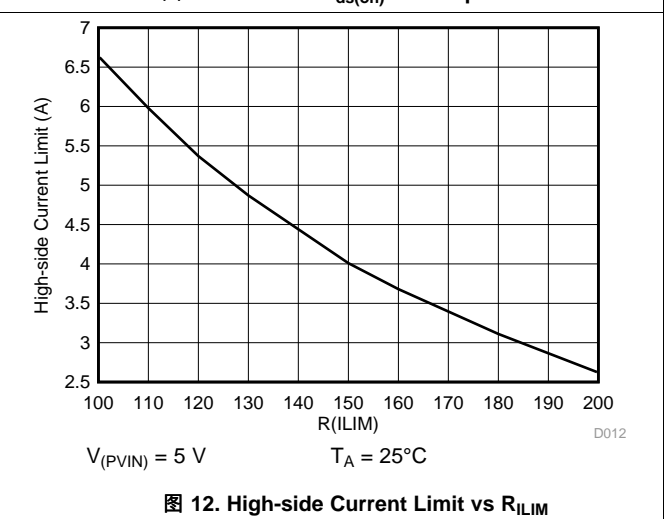

图 14. Minimum Pulse-width vs Temperature

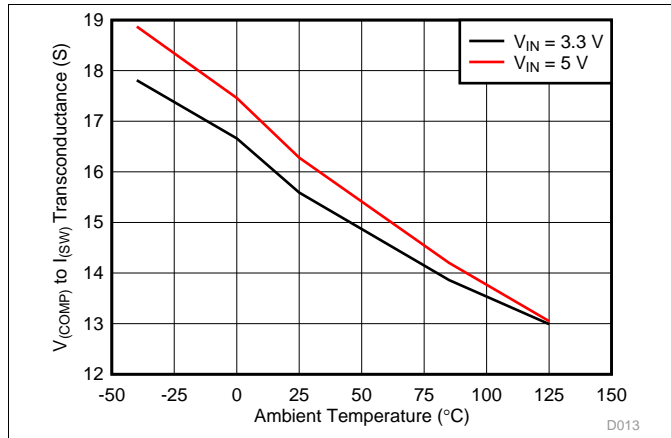

图 15. Minimum pulse-width vs Load Current

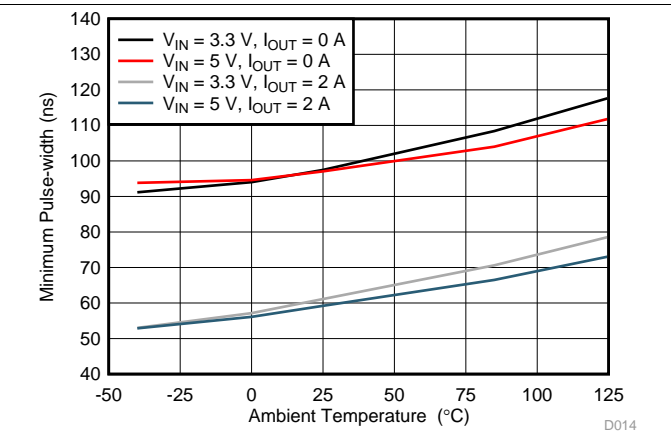

图 16. Switching Frequency vs  $R_{RT/SYNC}$  Low Range

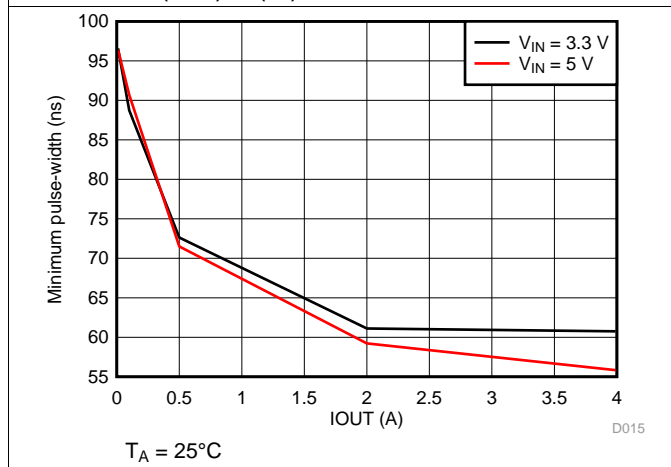

图 17. Switching Frequency vs  $R_{RT/SYNC}$  High Range

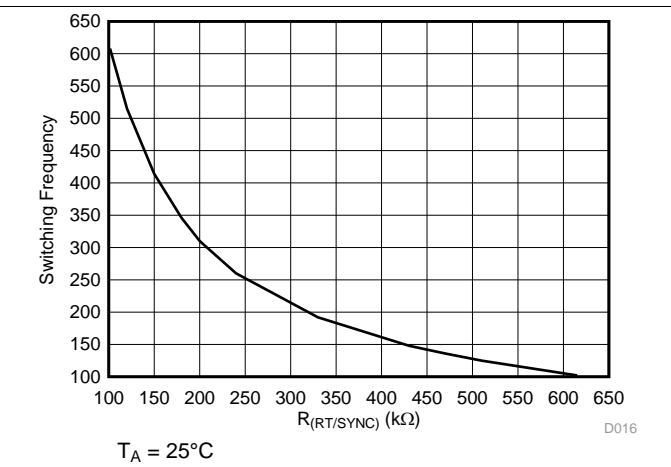

图 18. Switching Frequency vs Temperature

Typical Characteristics (接下页)

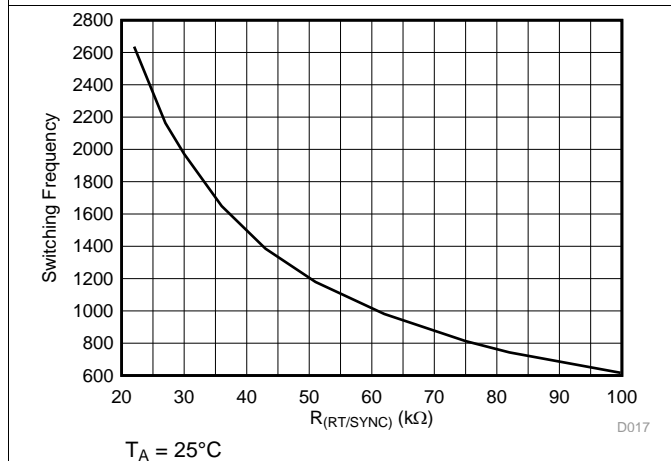

$R_{(RT/SYNC)} = 27 \text{ k}\Omega$

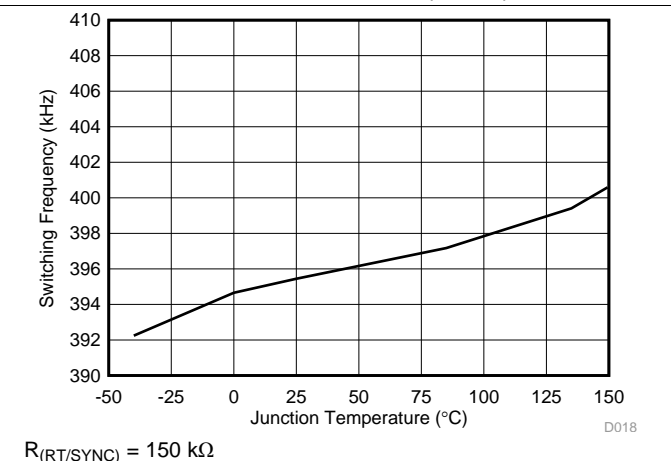
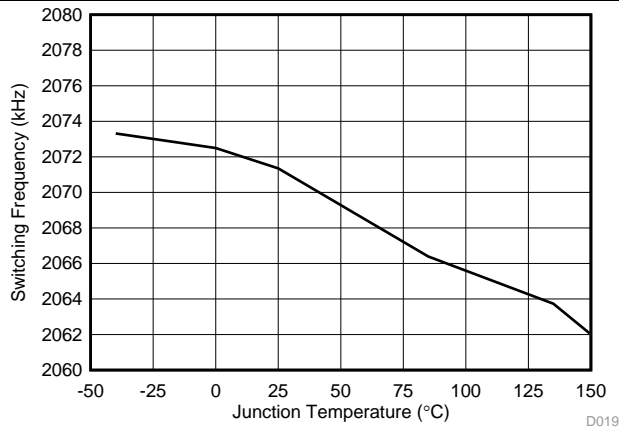
图 19. Switching Frequency vs Temperature

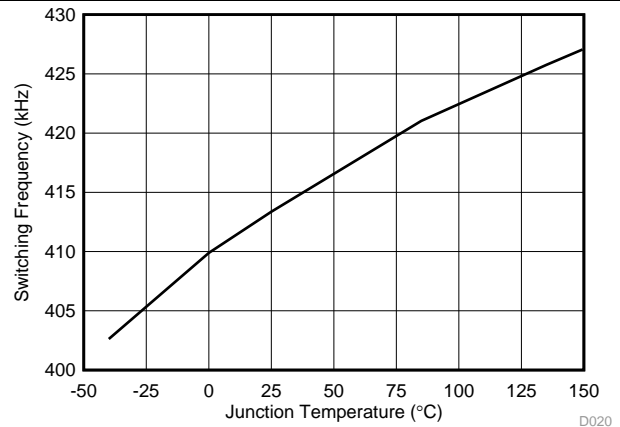

Internal RT

图 20. Switching Frequency vs Temperature

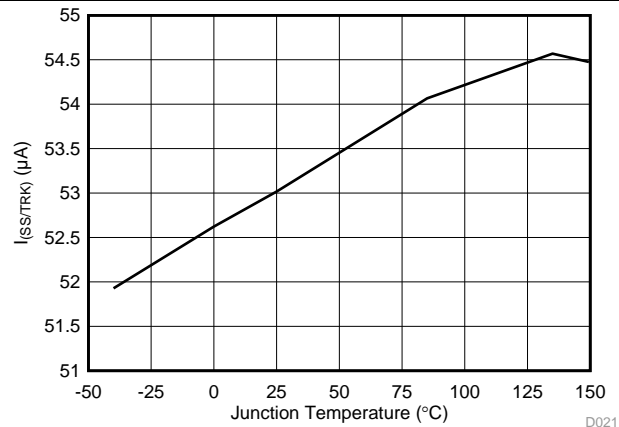

$V_{(SS/TRK)} < V_{SS(THR)}$

图 21.  $I_{(SS/TRK)}$  vs Temperature

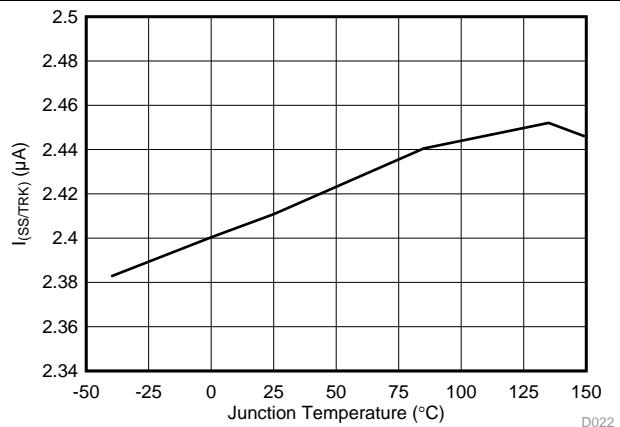

$V_{(SS/TRK)} > V_{SS(THR)}$

图 22.  $I_{(SS/TRK)}$  vs Temperature

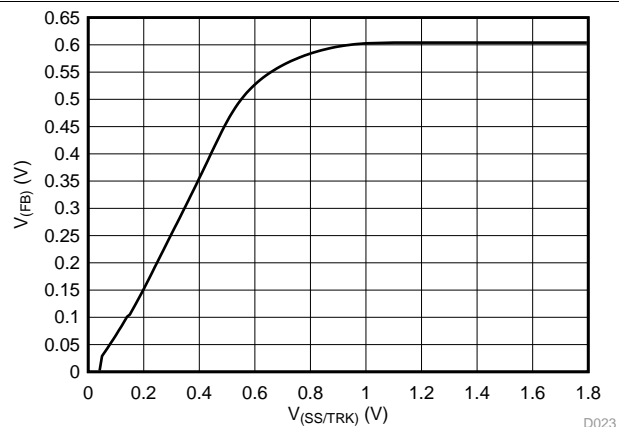

$T_A = 25^\circ\text{C}$

图 23.  $V_{(FB)}$  vs  $V_{(SS/TRK)}$



图 24. PGOOD Thresholds vs Temperature

Typical Characteristics (接下页)



图 25. VTTREF Regulation to VDDQSNS/2 vs I(VTTREF)

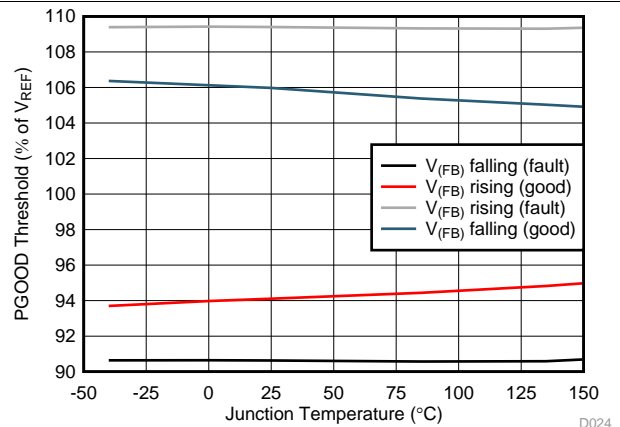

图 26. VTTREF Regulation to VDDQSNS/2 vs I(VTTREF)

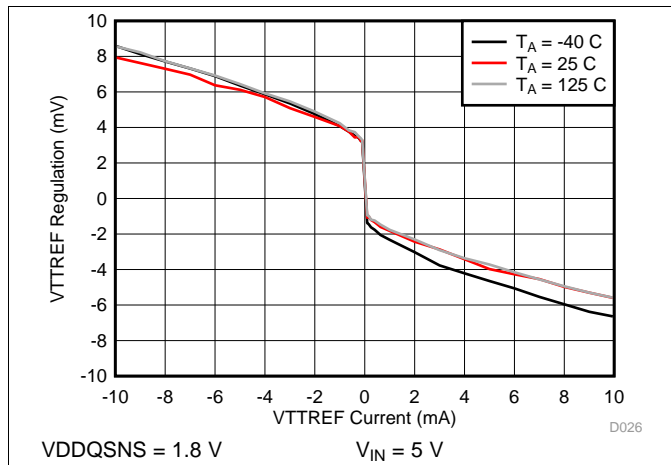

图 27. VTTREF Regulation to VDDQSNS/2 vs I(VTTREF)

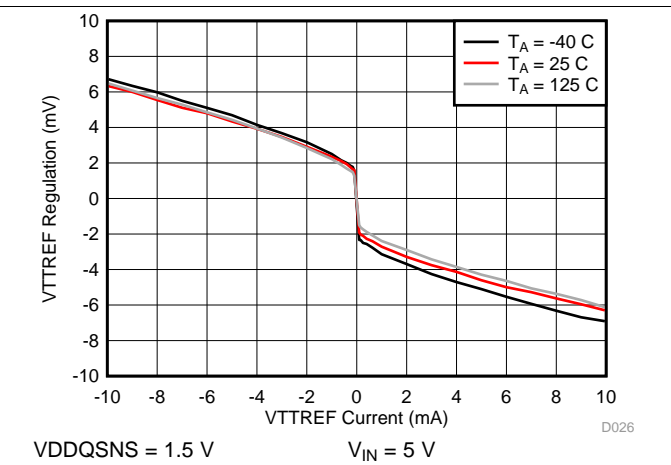

图 28. VTTREF Regulation to VDDQSNS/2 vs I(VTTREF)

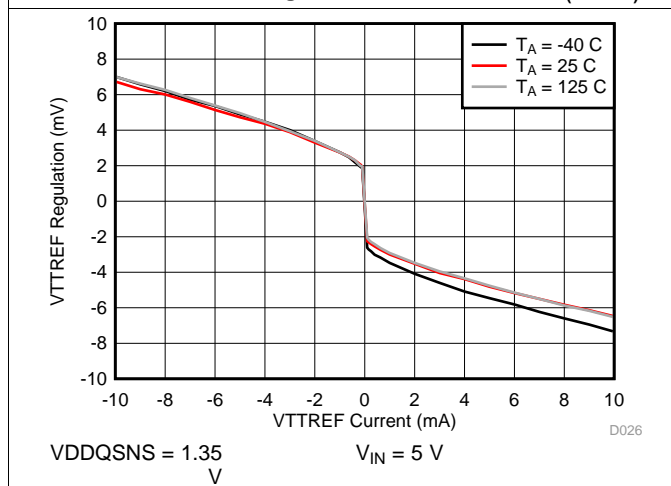

图 29. VTT Regulation to VTTREF vs I(VTT)

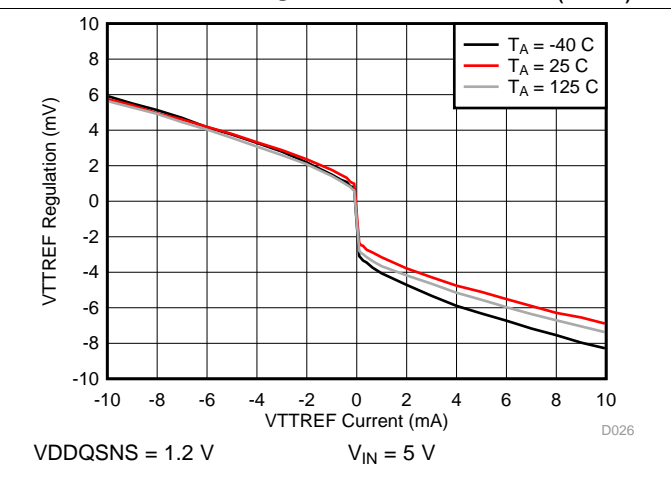

图 30. VTT Regulation to VTTREF vs I(VTT)

Typical Characteristics (接下页)

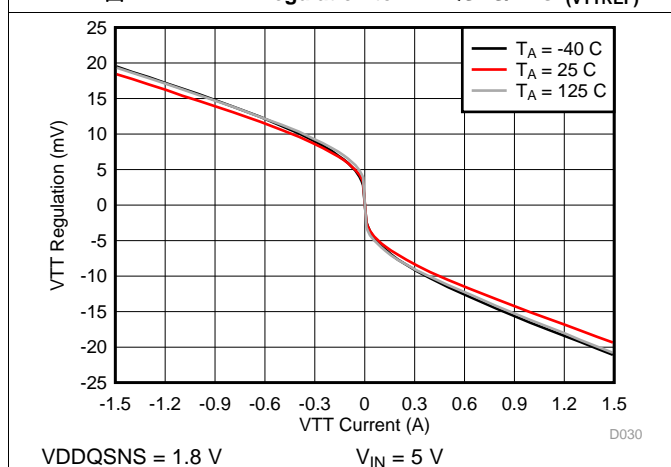

图 31. VTT Regulation to VTTREF vs I(VTT)

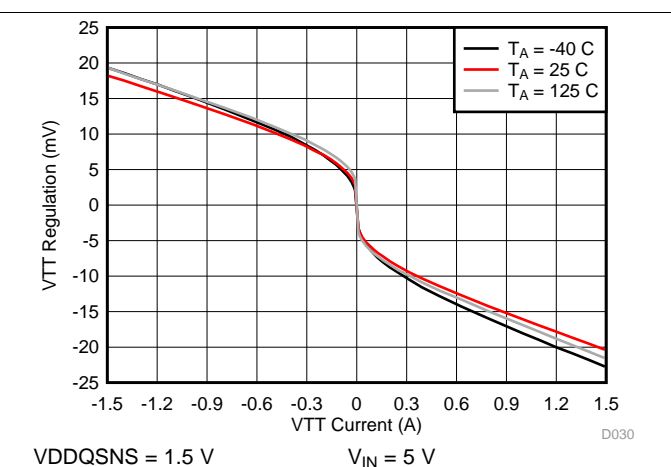

图 32. VTT Regulation to VTTREF vs I(VTT)

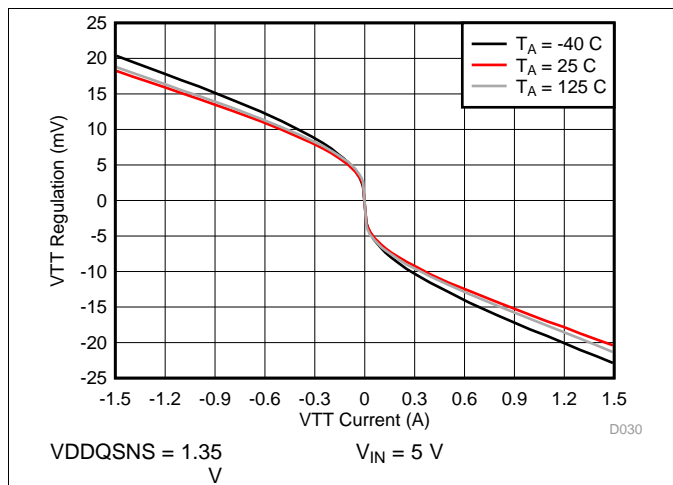

图 33. VTT Dropout

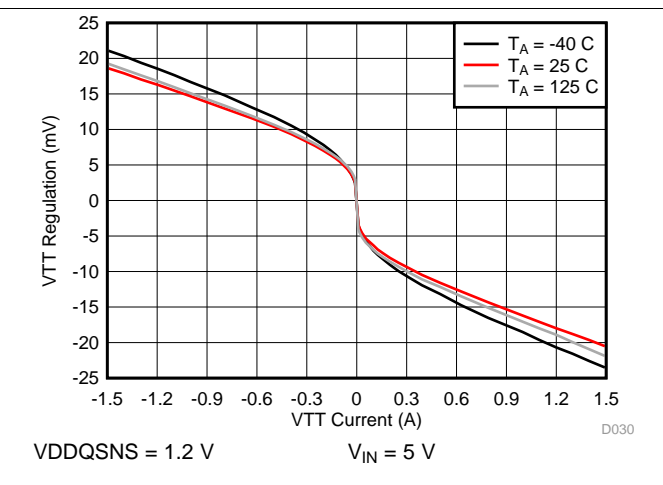

图 34. VTT Sourcing Frequency Response

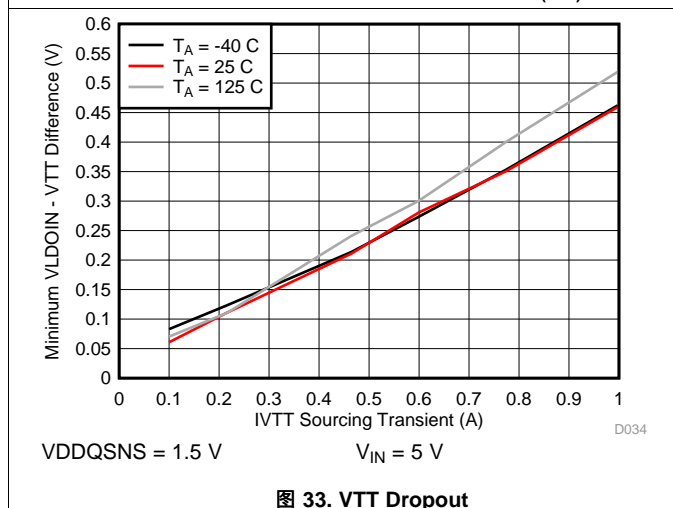

图 35. VTT Sinking Frequency Response

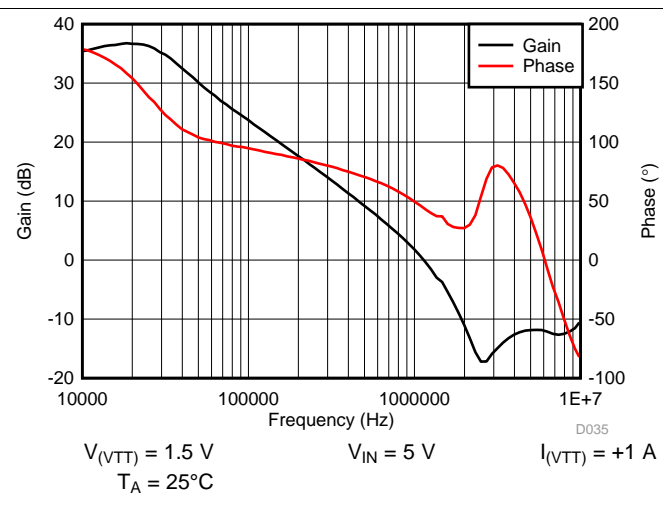

图 36. Efficiency

Typical Characteristics (接下页)

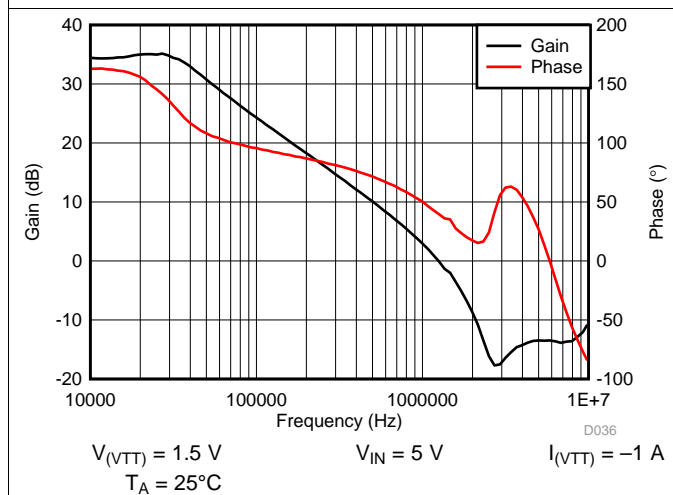

## 7 Detailed Description

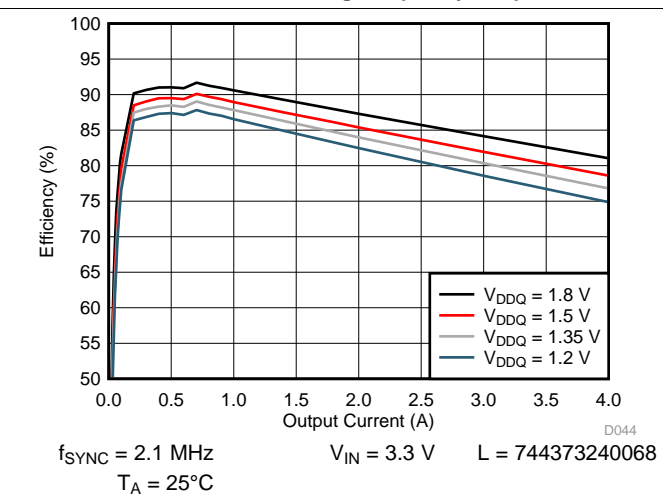
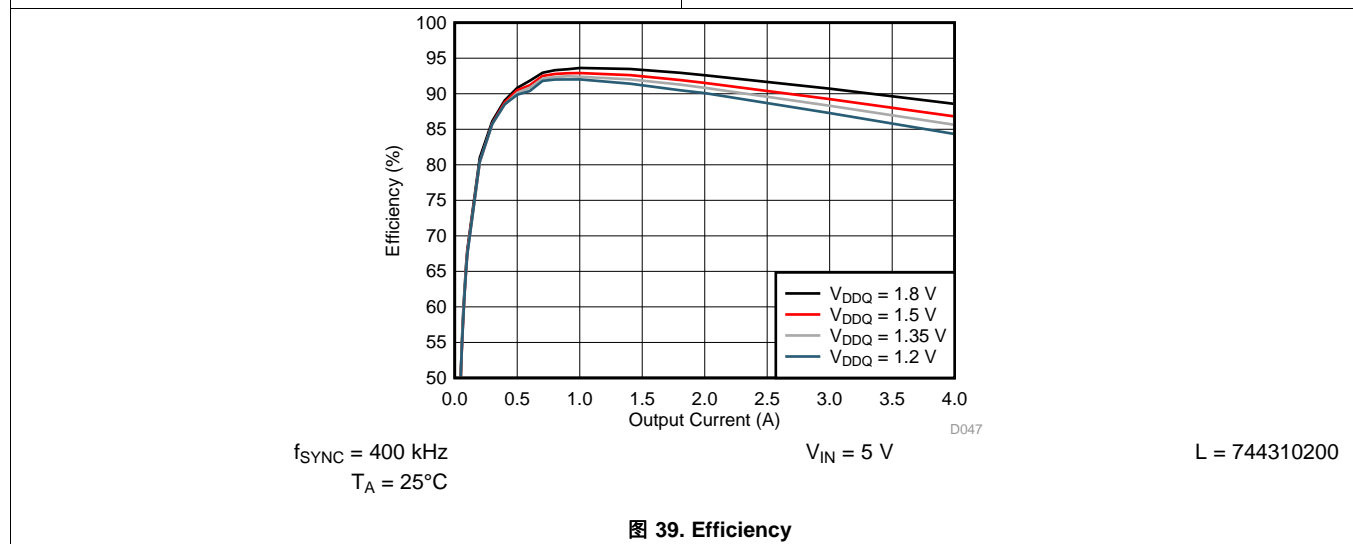
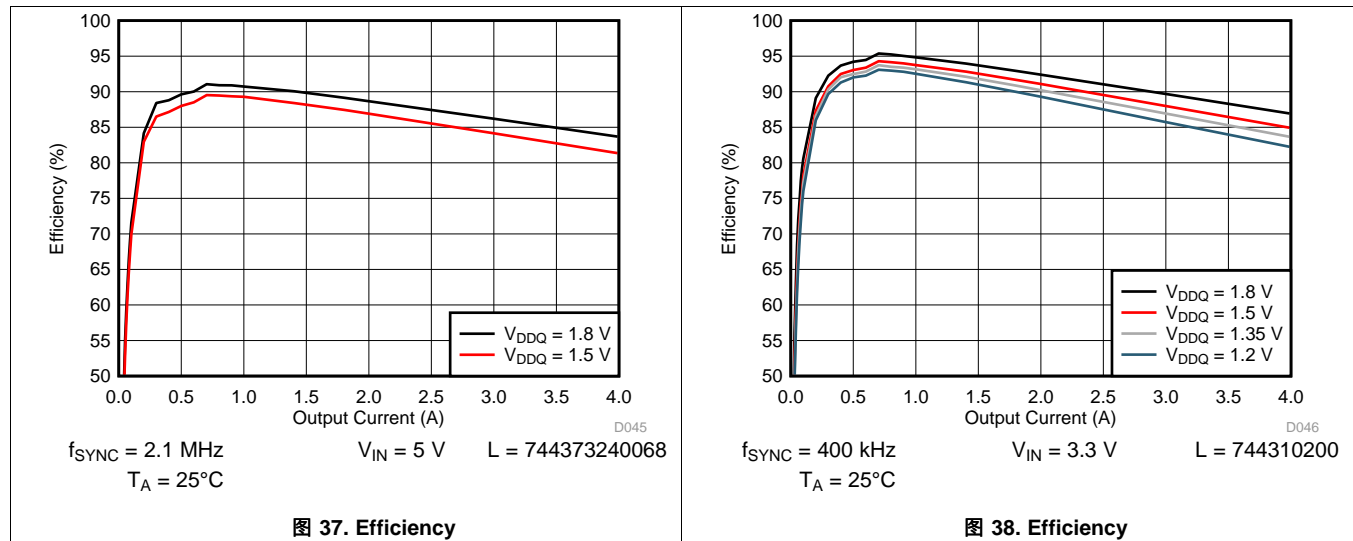
### 7.1 Overview

The TPS54116-Q1 is a 6-V, 4-A, synchronous step-down (buck) converter with two integrated N-channel MOSFETs and integrated 1-A sink/source double data rate (DDR) VTT termination regulator with a VTTREF buffered reference output.

To improve the performance during line and load transients the buck converter implements a constant frequency, peak current mode control which reduces output capacitance and simplifies external frequency compensation design. The wide switching frequency range of 100 kHz to 2500 kHz allows for efficiency and size optimization when selecting the output filter components. The switching frequency is adjusted using a resistor to ground on the RT/SYNC pin. The RT/SYNC pin can also be used to synchronize the power switch turn on to the rising edge of an external clock. The switching frequency can be set using an internal resistor by pulling the RT/SYNC below the low threshold or above the high threshold.

The TPS54116-Q1 has a typical default start-up voltage of 2.7 V. The ENSW pin can be used to enable the buck converter and the ENLDO pin can be used to enable VTT and VTTREF. The ENSW and ENLDO pins have internal pullup current sources that can be used to adjust the input voltage under voltage lockout (UVLO) with two external resistors. In addition, the pullup current provides a default condition when the ENSW or ENLDO pin is floating for the device to operate. The total operating current for the TPS54116-Q1 is typically 650  $\mu$ A when not switching and under no load. When the device is disabled, the supply current is less than 3.5  $\mu$ A.

The integrated 33-m $\Omega$  and 25-m $\Omega$  MOSFETs allow for high-efficiency power supply designs with continuous output currents up to 4 amperes. The TPS54116-Q1 reduces the external component count by integrating the boot recharge diode. The bias voltage for the integrated high-side MOSFET is supplied by a capacitor between the BOOT and SW pins. The boot capacitor voltage is monitored by an UVLO circuit and turns off the high-side MOSFET when the voltage falls below the BOOT-SW UVLO threshold. This BOOT circuit allows the TPS54116-Q1 to operate approaching 100% duty cycle. The output voltage can be stepped down to as low as the 0.60-V reference.

The TPS54116-Q1 features monotonic start-up under prebias conditions. The low-side FET turns on for a short time period every cycle before the output voltage reaches the prebiased voltage. This ensures the boot capacitor has enough charge to turn on the top FET when the output voltage reaches the prebiased voltage.

The TPS54116-Q1 has a power good comparator (PGOOD) with 3% hysteresis. Excessive output overvoltage transients are minimized by taking advantage of the overvoltage power good comparator. When the regulated output voltage (as sensed by the FB voltage) is greater than 109% of the nominal voltage, the overvoltage comparator is activated, and the high-side MOSFET is turned off and masked from turning on until the output voltage is lower than 106%.

The SS/TRK (soft-start or tracking) pin is used to minimize inrush currents or provide power supply sequencing during power up. A small value capacitor should be coupled to the pin for soft-start. The SS/TRK pin is discharged before the output power up to ensure a repeatable restart after an over temperature fault, UVLO fault or disabled condition. To optimize the output startup waveform, two levels of SS/TRK output current are implemented.

The TPS54116-Q1 limits the peak inductor current by sensing the current through the high-side MOSFET with cycle-by-cycle protection. The peak current limit is adjusted using a resistor to ground on the ILIM pin. The reverse current through the low-side MOSFET is also limited.

The 10-mA VTTREF buffered reference uses an internal resistor divider to regulate its output within 49% to 51% of VDDQSNS. The 1-A VTT termination regulates to VTTREF and maintains fast transient response with only 2  $\times$  10- $\mu$ F ceramic output capacitance. Remote sensing of VTT is used for best regulation. The VTT and VTTREF outputs are discharged when disabled with the AVIN UVLO or with ENLDO.

## 7.2 Functional Block Diagram

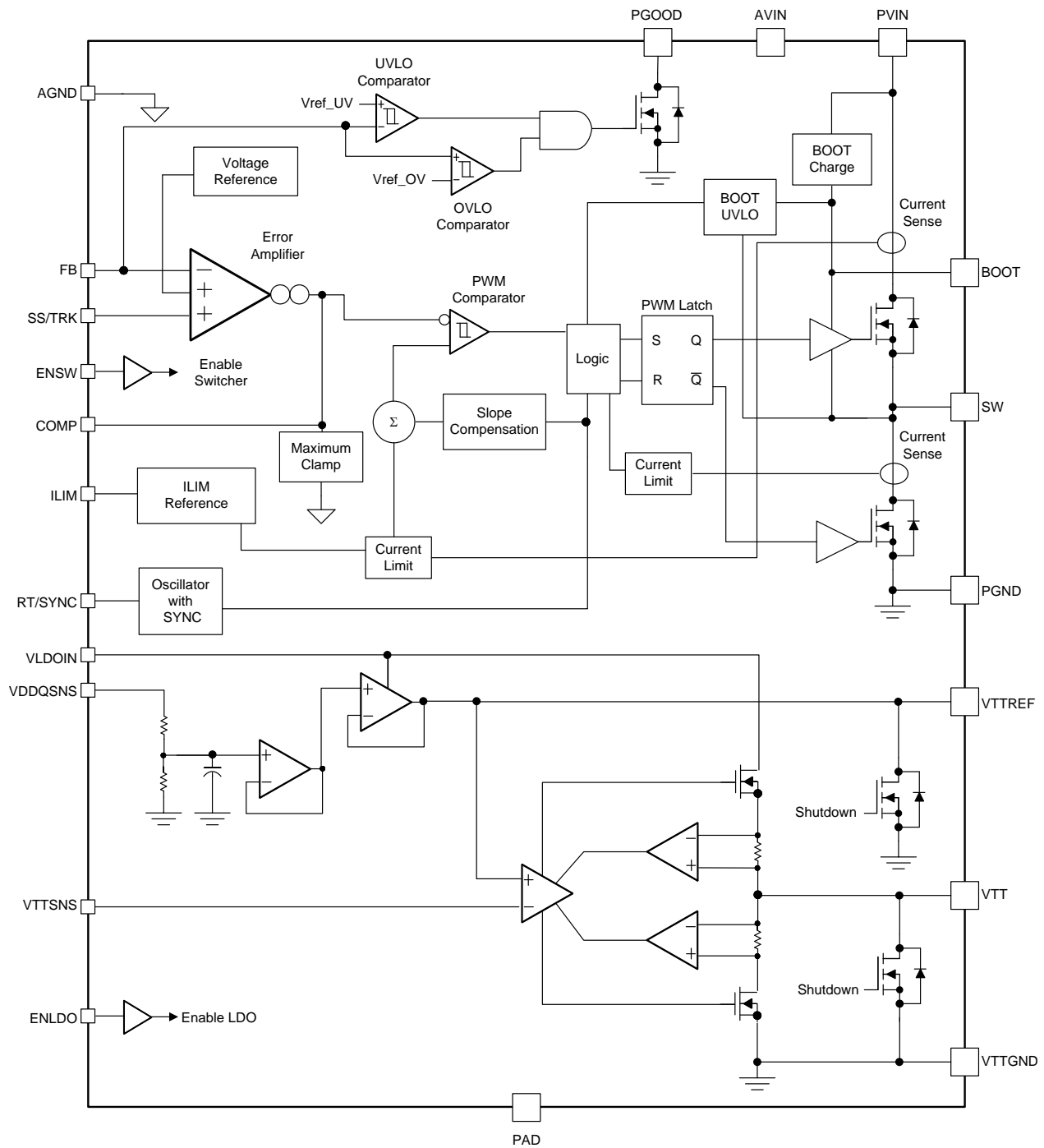

Copyright © 2016, Texas Instruments Incorporated



## 7.3 Feature Description

### 7.3.1 Fixed Frequency PWM Control

The TPS54116-Q1 uses an adjustable fixed frequency, peak current mode control. The output voltage is compared through external resistors on the FB pin to an internal voltage reference by an error amplifier which drives the COMP pin. An internal oscillator initiates the turn on of the high-side power switch. The error amplifier output is compared to the high-side power switch current. When the power switch current reaches the COMP signal level the high-side power switch is turned off and the low-side power switch is turned on. The COMP pin voltage will increase and decrease as the output current increases and decreases. The device implements a current limit by clamping the internal COMP signal.

An internal ramp is used to provide slope compensation to prevent sub-harmonic oscillations. The peak inductor current limit is constant over the full duty cycle range.

### 7.3.2 Bootstrap Voltage (BOOT) and Low Dropout Operation

The TPS54116-Q1 has an integrated boot regulator and requires a small ceramic capacitor between the BOOT and SW pins to provide the gate drive voltage for the high-side MOSFET. The value of the ceramic capacitor should be 0.1  $\mu$ F. A ceramic capacitor with an X7R or X5R grade dielectric is recommended because of the stable characteristics over temperature and voltage.

To improve dropout, the TPS54116-Q1 is designed to operate at 100% duty cycle as long as the BOOT-SW voltage is greater than 2.2 V. The high-side MOSFET is turned off using an UVLO circuit, allowing for the low-side MOSFET to conduct, when the BOOT-SW voltage drops below 2.2 V. Because the supply current sourced from the BOOT pin is low, the high-side MOSFET can remain on for more switching cycles than are required to refresh the capacitor, thus the effective duty of the switching regulator is high.

### 7.3.3 Error Amplifier

The TPS54116-Q1 has a transconductance amplifier for the error amplifier. The error amplifier compares the FB voltage to the lower of the SS/TRK pin voltage or the internal 0.6-V voltage reference. The transconductance ( $g_{mEA}$ ) of the error amplifier is 260  $\mu$ A/V during normal operation. During soft-start, the  $g_{mEA}$  is reduced to 90  $\mu$ A/V. The frequency compensation components are added to the COMP pin to ground.

When operating at current limit the COMP pin voltage is clamped to a maximum level to improve response when the load current decreases. When FB is greater than the internal voltage reference or SS/TRK the COMP pin voltage is clamped to a minimum level and the devices enters a high-side skip mode.

### 7.3.4 Voltage Reference and Adjusting the Output Voltage

The voltage reference system produces a precise  $\pm 1\%$  voltage reference over temperature by scaling the output of a temperature stable bandgap circuit. The FB voltage is regulated to the voltage reference. The output voltage is set with a resistor divider from the output node to the FB pin. It is recommended to use divider resistors with 1% tolerance or better. Start with a 10.0 k $\Omega$  for the bottom resistor  $R_{FBB}$  and use the [公式 1](#) to calculate  $R_{FBT}$ . The maximum recommend resistance value for the bottom resistor is 100 k $\Omega$ .

$$R_{FBT} = R_{FBB} \times \left( \frac{V_{OUT}}{V_{REF}} - 1 \right) \quad (1)$$

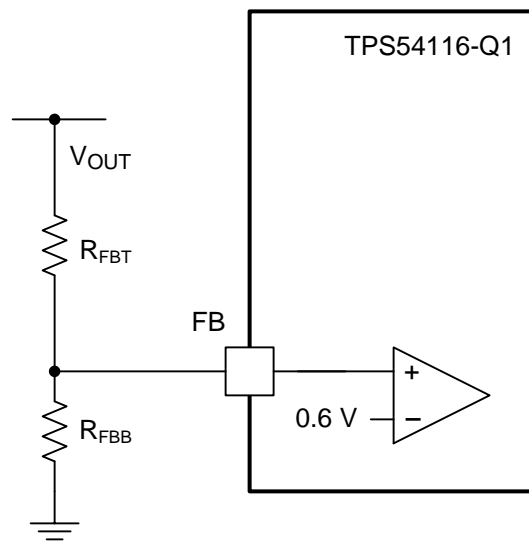
**Feature Description (接下页)**

**图 40. Voltage Divider Circuit**
**7.3.5 Enable and Adjusting Undervoltage Lockout**

The TPS54116-Q1 is enabled when the AVIN pin voltage exceeds 2.7 V and is disabled when it falls below 2.65 V. If an application requires a higher under-voltage lockout (UVLO) or more hysteresis, use the ENSW or ENLDO pins as shown in 图 41 to adjust the input voltage UVLO by using two external resistors. The EN pin has an internal pull-up current source ( $I_p$ ) of 1.7  $\mu\text{A}$  that provides the default condition of the TPS54116-Q1 operating when the EN pin floats. Once the EN pin voltage exceeds 1.2 V, an additional 2.7  $\mu\text{A}$  hysteresis current ( $I_h$ ) is added. When the EN pin is pulled below 1.17 V, the 2.7  $\mu\text{A}$  is removed. This additional current facilitates input voltage hysteresis. It is recommended to use the EN resistors to set the UVLO falling threshold ( $V_{STOP}$ ) at 2.65V or higher. The rising threshold ( $V_{START}$ ) should be set to provide enough hysteresis to allow for any input supply variations. 公式 2 can be used to calculate the top resistor in the EN divider and 公式 3 is used to calculate the bottom resistor.

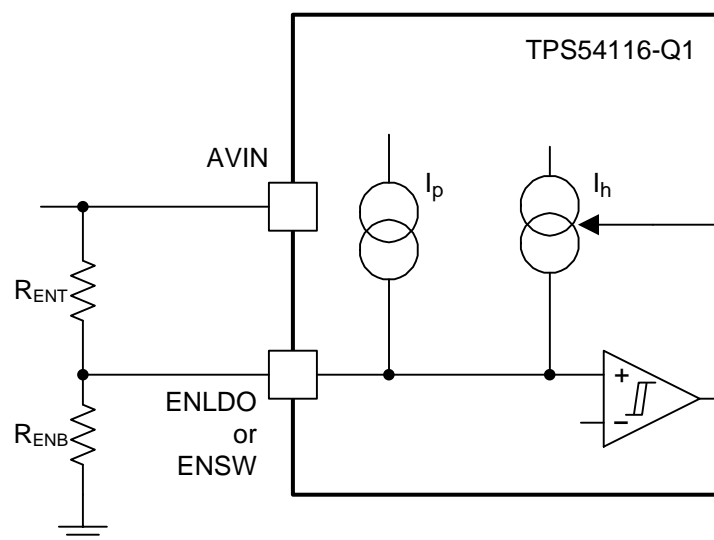
The ENSW and ENLDO can also be tied in parallel. Calculations can be done the same but with the increased EN current of  $I_p = 3.4 \mu\text{A}$  and  $I_h = 5.1 \mu\text{A}$ .

**图 41. Adjustable Under Voltage Lock Out**

## Feature Description (接下页)

$$R_{ENT} = \frac{V_{START} \times \left( \frac{V_{ENFALLING}}{V_{ENRISING}} \right) - V_{STOP}}{I_p \times \left( 1 - \frac{V_{ENFALLING}}{V_{ENRISING}} \right) + I_h} \quad (2)$$

$$R_{ENB} = \frac{R_{ENT} \times V_{ENFALLING}}{V_{STOP} - V_{ENFALLING} + R_{ENT} \times (I_p + I_h)} \quad (3)$$

Where:

- $I_h = 2.7 \mu A$
- $I_p = 1.7 \mu A$
- $V_{ENRISING} = 1.2 V$
- $V_{ENFALLING} = 1.17 V$

### 7.3.6 Soft Start and Tracking

The TPS54116-Q1 regulates to the lower of the SS/TRK pin and the internal reference voltage. A capacitor on the SS/TRK pin to ground implements a soft start time. Before the SS pin reaches the voltage threshold  $V_{SSTHR}$  of 0.15 V, the charge current is about 47  $\mu A$ . The TPS54116-Q1 internal pull-up current source of 2.4  $\mu A$  charges the external soft start capacitor after the SS pin voltage exceeds  $V_{SSTHR}$ . 公式 4 calculates the required soft start capacitor value where  $t_{SS}$  is the desired soft start time for the output voltage to reach 90% its final value in ms and  $C_{SS}$  is the required capacitance in nF.

$$C_{SS} (nF) = 5.3 \times t_{SS} (ms) \quad (4)$$

If during normal operation, AVIN goes below the UVLO, ENSW pin pulled below 1.17 V, or a thermal shutdown event occurs, the TPS54116-Q1 stops switching. When the AVIN goes above UVLO, ENSW is released or pulled high, or a thermal shutdown is exited, then SS/TRK is discharged to below 5 mV before reinitiating a powering up sequence. The FB voltage will follow the SS/TRK pin voltage with a 60 mV offset up to 90% of the internal voltage reference. When the SS/TRK voltage is greater than 90% of the internal reference voltage the offset increases as the effective system reference transitions from the SS/TRK voltage to the internal voltage reference.

When the COMP pin voltage is clamped by the maximum COMP clamp in an overload condition the soft-start pin is discharged to near the FB voltage. When the overload condition is removed, the soft-start circuit controls the recovery from the fault output level to the nominal regulation voltage. At the beginning of recovery a spike in the output voltage may occur as the COMP voltage transitions to the value determined by the loop.

### 7.3.7 Start-up into Pre-Biased Output

The TPS54116-Q1 features monotonic startup into pre-biased output. The low-side MOSFET turns on for a very short time period every cycle before the output voltage reaches the pre-biased voltage. This ensures the BOOT-SW cap has enough charge to turn on the high-side MOSFET when the output voltage reaches the pre-biased voltage. The low-side MOSFET reverse current protection provides another layer of protection but it should not be reached due to the implemented prebias function.

### 7.3.8 Power Good

The PGOOD pin is an open-drain output requiring an external pullup resistor to output a high signal. Once the FB pin is between 94% and 106% of the internal voltage reference, the PGOOD pin is de-asserted and the pin floats. A pull up resistor between the values of 10 k $\Omega$  and 100 k $\Omega$  to a voltage source that is 6 V or less is recommended. The PGOOD is in a defined state once the AVIN input voltage is greater than 1.3 V but with reduced current sinking capability.

The PGOOD pin is pulled low when the FB is lower than 91% or greater than 109% of the nominal internal reference voltage. The PGOOD is also pulled low if AVIN falls below its UVLO, ENSW pin is pulled low or the TPS54116-Q1 enters thermal shutdown.

## Feature Description (接下页)

### 7.3.9 Sequencing

Many of the common power supply sequencing methods can be implemented using the SS/TRK, ENSW and PGOOD pins. The sequential method can be implemented using an open-drain or collector output of a power on reset pin of another device. An example sequential method is shown in 图 42. PGOOD is connected to the EN pin on the next power supply, which will enable the second power supply once the first supply reaches regulation.



图 42. Sequential Startup Example

### 7.3.10 Constant Switching Frequency and Timing Resistor (RT/SYNC)

The switching frequency of the TPS54116-Q1 is adjustable over a wide range from 100 kHz to 2500 kHz by placing a maximum of 620 kΩ and minimum of 22 kΩ, respectively, on the RT/SYNC pin. Alternatively the RT/SYNC pin can be tied above the high threshold or below the low threshold to use an internal RT resistor to set the switching frequency to 420 kHz. The RT/SYNC is typically 0.5 V and the current through the resistor sets the switching frequency. To determine the timing resistance for a given switching frequency, refer to the curve in 图 16 and 图 17 or use 公式 5. For a given RT resistor the nominal switching frequency can be calculated with 公式 6. To reduce the solution size one would typically set the switching frequency as high as possible, but tradeoffs of the supply efficiency, maximum input voltage and minimum controllable on time should be considered. The minimum controllable on time is typically 60 ns at 2-A load current and 100 ns at no load, and will limit the maximum operating input voltage or minimum output voltage.

$$R_T (\text{k}\Omega) = \frac{72540}{f_{\text{SW}} (\text{kHz})^{1.033}} \quad (5)$$

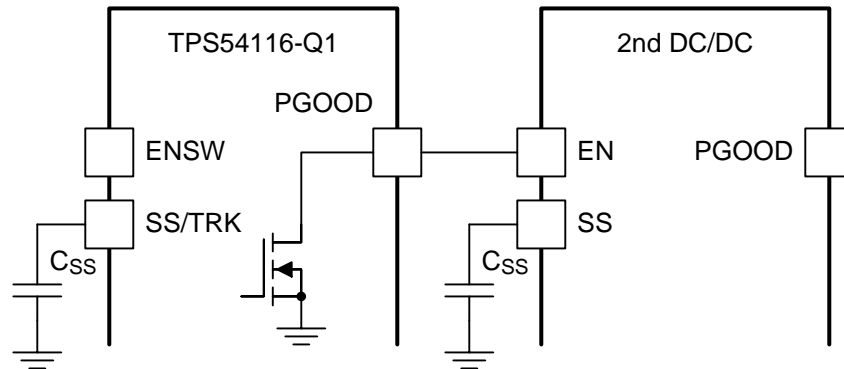
$$f_{\text{SW}} (\text{kHz}) = \frac{50740}{R_T (\text{k}\Omega)^{0.968}} \quad (6)$$

The RT/SYNC pin can also be used to synchronize the converter to an external system clock. When using the internal RT resistor, the TPS54116-Q1 cannot be synchronized to an external clock. The synchronization frequency range is 100 kHz to 2500 kHz. The rising edge of SW will be synchronized to the rising edge of RT/SYNC. To implement the synchronization feature in a system connect a square wave to the RT/SYNC pin with on-time at least 10 ns. The square wave amplitude at this pin must transition lower than 0.35 V and higher than 2.2 V.

See 图 43 for synchronizing to a high impedance system clock. See 图 44 and 图 45 for synchronizing to a low impedance system clock. A tri-state buffer with its output directly connected to the RT/SYNC pin is the recommended method to accommodate a wide range of external clock frequencies and duty cycles. Alternatively an AC blocking capacitor circuit can be used when synchronizing to frequencies greater than 800 kHz and with clock signals with duty cycle near 50%. When using an AC coupling capacitor to interface with an external clock, RT/SYNC is not actively pulled low by the external clock. As a result the TPS54116-Q1 begins its transition back to RT mode while the external clock is low. When connecting the RT/SYNC pin to the external clock source, it is important to minimize routing connected to the RT/SYNC pin as much as possible to minimize noise sensitivity when operating in RT mode.

Feature Description (接下页)



图 43. Synchronizing to a High Impedance System Clock



图 44. Interfacing to the RT/SYNC Pin with Buffer

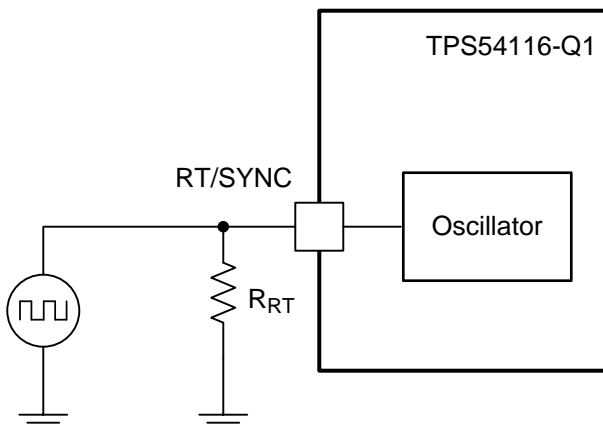

图 45. Interfacing to the RT/SYNC Pin with RC

## Feature Description (接下页)

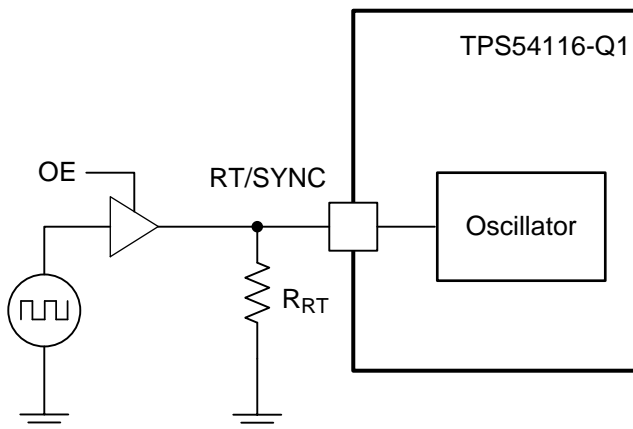
### 7.3.11 Buck Overcurrent Protection

The TPS54116-Q1 implements current mode control which uses the COMP pin voltage to turn off the high-side MOSFET and turn on the low-side MOSFET on a cycle-by-cycle basis. Each cycle the switch current and the COMP pin voltage are compared, when the peak switch current intersects the COMP voltage the high-side switch is turned off. During overcurrent conditions that pull the output voltage low, the error amplifier will respond by driving the COMP pin high, increasing the switch current. The error amplifier output is clamped internally. This clamp functions as a high-side switch current limit.

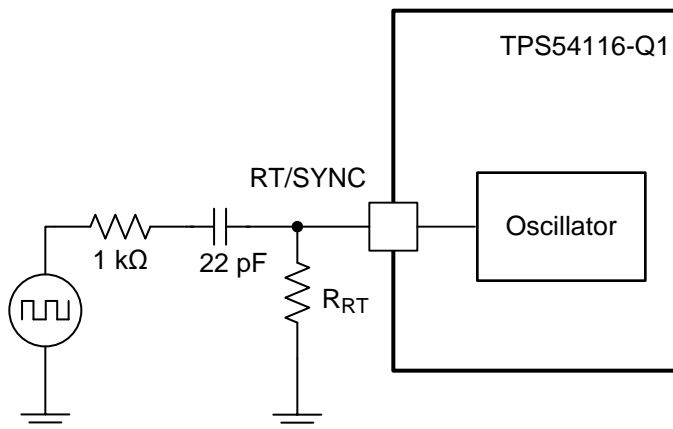
A resistor placed from ILIM to AGND sets the peak current limit of the buck converter in the TPS54116-Q1. A 100 kΩ resistor sets it to the maximum value and a 200 kΩ resistor sets it to the minimum value. Any resistor within this range can be used. 图 12 shows the relationship between peak current limit and ILIM resistor. To determine the resistor value for a target current limit use 公式 7.

$$R_{ILIM} = 420 \times I_{limit}^{-0.75} \quad (7)$$

The TPS54116-Q1 also implements low-side current protection by detecting the voltage over the low-side MOSFET. When the converter sinks current through the low-side MOSFET is more than 4.5 A, the control circuit will turn the low-side MOSFET off immediately for the rest of the clock cycle. Under this condition, both the high-side and low-side are off until the start of the next cycle.

### 7.3.12 Overvoltage Transient Protection

The TPS54116-Q1 incorporates an overvoltage transient protection (OVTP) circuit to minimize voltage overshoot when recovering from output fault conditions or strong unload transients. The OVTP feature minimizes the output overshoot by implementing a circuit to compare the FB pin voltage to OVTP threshold which is 109% of the internal voltage reference. If the FB pin voltage is greater than the OVTP threshold, the high-side MOSFET is disabled preventing current from flowing to the output and minimizing output overshoot. The output voltage can overshoot the 109% threshold as the current in the inductor discharges to 0 A. When the FB voltage drops lower than the OVTP threshold the high-side MOSFET is allowed to turn on the next clock cycle.

### 7.3.13 VTT Sink and Source Regulator

The TPS54116-Q1 integrates a high-performance, low-dropout (LDO) linear regulator (VTT) that has ultimate fast response to track  $\frac{1}{2}$  VDDQSNS within 40 mV at all conditions, and its current capability is 1.5 A peak current for both sink and source directions. Two 10-μF (or greater) ceramic capacitor(s) need to be attached close to the VTT pin for stable operation. X5R grade or better is recommended. To achieve tight regulation with minimum effect of trace resistance, the remote sensing terminal, VTTSNS, should be connected to the positive terminal of the output capacitor(s) as a separate trace from the high current path from the VTT pin.

The device has a dedicated pin, VLDOIN, for VTT power supply to minimize the LDO power dissipation on user application. The minimum VLDOIN voltage is 0.45 V above the  $\frac{1}{2}$  VDDQSNS voltage.

### 7.3.14 VTTREF

The VTTREF pin has a 10 mA sink and source current capability, and regulates to within 49% to 51% of VDDQSNS. A 0.22-μF ceramic capacitor needs to be attached close to the VTTREF terminal for stable operation. X5R grade or better is recommended.

### 7.3.15 Thermal Shutdown

The device implements an internal thermal shutdown to protect itself if the junction temperature exceeds 175°C. The thermal shutdown has a hysteresis of 16°C. When the junction temperature exceeds thermal trip threshold, thermal shutdown forces the device to stop switching and discharges both VTT and VTTREF. When the die temperature decreases below 159°C, the device reinitiates the power-up sequence by discharging the SS/TRK pin.

## 7.4 Device Functional Modes

The enable pins and an AVIN UVLO are used to control turn on and turn off of the TPS54116-Q1. The device becomes active when  $V_{(AVIN)}$  exceeds the 2.7 V typical UVLO and when either  $V_{(ENSW)}$  or  $V_{(ENLDO)}$  exceeds 1.20 V typical. The ENSW pin is used to control the turn on and turn off of the buck converter. The ENLDO pin is used to control the turn on and turn off of the VTTREF and VTT outputs of the termination regulator. The ENSW and ENLDO pins both have an internal current source to enable their respective outputs when left floating. Both ENSW and ENLDO need to be pulled low to put the device into a low quiescent current state.

## 8 Application and Implementation

### 注

Information in the following applications sections is not part of the TI component specification, and TI does not warrant its accuracy or completeness. TI's customers are responsible for determining suitability of components for their purposes. Customers should validate and test their design implementation to confirm system functionality.

### 8.1 Application Information

The TPS54116-Q1 is a fully integrated power solution for DDR2, DDR3 and DDR3L memory supplying VDDQ, VTTREF and VTT as shown in 图 46. It can also be used to power LPDDR2, LPDDR3 and DDR4 memory but an additional power supply is required for VDD1 or VPP as shown in 图 47. The TPS54116-Q1 can supply 4 A for VDDQ and 1 A for VTT. The sourcing current for VTT comes from VDDQ and must be included as part of the total VDDQ load current. Use the following design procedure to select component values for the TPS54116-Q1. This procedure illustrates the design of a high-frequency switching regulator using ceramic output capacitors. Alternatively the WEBENCH® software can be used to generate a complete design. The WEBENCH® software uses an interactive design procedure and accesses a comprehensive database of components when generating a design. This section presents a simplified discussion of the design process.

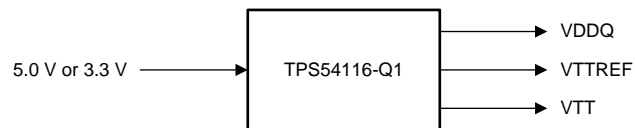

Copyright © 2016, Texas Instruments Incorporated

图 46. DDR2, DDR3 and DDR3L Application Block Diagram

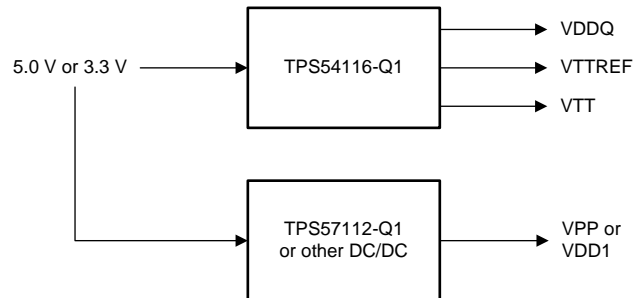

Copyright © 2016, Texas Instruments Incorporated

图 47. LPDDR2, LPDDR3 and DDR4 Application Block Diagram



## 8.2 Typical Application



图 48. 3.3-V or 5-V Input, 2.1 MHz fsw, DDR3 Schematic

### 8.2.1 Design Requirements

表 1. Design Parameters

DESIGN PARAMETERS	EXAMPLE VALUES
Input Voltage	5 V nominal, 2.95 V to 5.25 V
Output Voltage	1.5 V
Maximum Output Current (VDDQ)	4 A
Maximum Output Current (VTT)	1 A
Output Voltage Ripple (VDDQ)	0.5% of $V_{OUT}$
Transient Response 1 A to 3 A load step	$\Delta V_{OUT} = 4\%$
Start Input Voltage (rising $V_{IN}$ )	2.9 V
Stop Input Voltage (falling $V_{IN}$ )	2.6 V

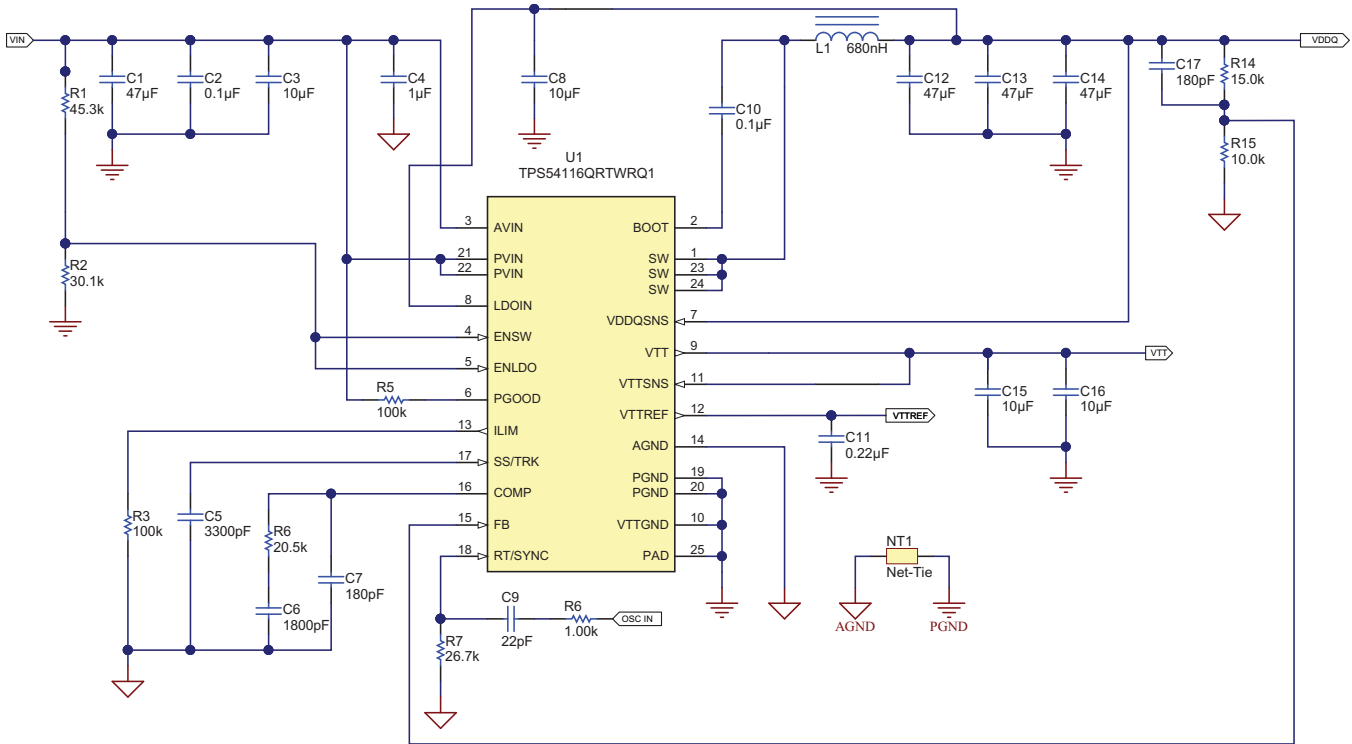
### 8.2.2 Detailed Design Procedure

#### 8.2.2.1 Switching Frequency

The first step is to decide on a switching frequency for the regulator. The buck converter is capable of running from 100 kHz to 2.5 MHz. Typically the highest switching frequency possible is desired because it will produce the smallest solution size. A high switching frequency allows for lower valued inductors and smaller output capacitors compared to a power supply that switches at a lower frequency. Additionally in applications with EMI requirements, such as automotive, choosing a switching frequency of 2.1 MHz is desired to keep the switching noise above the medium wave band or AM band. The main trade off made with selecting a higher switching frequency is extra switching power loss, which hurt the converter's efficiency.

The maximum switching frequency for a given application is limited by the minimum on-time of the converter and is estimated with 公式 8. For this application with the maximum minimum on-time of 125 ns at no load and 5.25 V maximum input voltage the maximum switching frequency is 2.28 MHz. A switching frequency of 2.1 MHz is selected to stay above the AM band. 公式 9 calculates R<sub>T</sub> to be 26.8 kΩ. A standard 1% 26.7 kΩ value was chosen in the design.

$$f_{\text{SW}}(\text{max}) = \frac{1}{t_{\text{onmin}}} \times \frac{V_{\text{OUT}}}{V_{\text{IN}}(\text{max})} \quad (8)$$

$$R_{\text{T}}(\text{k}\Omega) = \frac{72540}{f_{\text{SW}}(\text{kHz})^{1.033}} \quad (9)$$

### 8.2.2.2 Output Inductor Selection

To calculate the value of the output inductor, use 公式 10. K<sub>IND</sub> is a ratio that represents the amount of inductor ripple current relative to the maximum output current. The inductor ripple current is filtered by the output capacitor. Therefore, choosing high inductor ripple currents impacts the selection of the output capacitor since the output capacitor must have a ripple current rating equal to or greater than the inductor ripple current. Additionally the inductor current ripple is used as part of the PWM control system. Choosing small inductor ripple currents can degrade the transient response performance or introduce jitter in the duty cycle. In general, the inductor ripple value is at the discretion of the designer; however, K<sub>IND</sub> is normally from 0.1 to 0.3 for the majority of applications giving a peak to peak ripple current range of 0.4 A to 1.2 A. It is recommended to always keep the peak to peak ripple current above 0.4 A because with a current mode control the inductor current ramp is used in the PWM control system.

For this design example, K<sub>IND</sub> = 0.3 is used and the inductor value is calculated to be 0.43 μH. The next standard value 0.68 μH is selected. It is important that the RMS current and saturation current ratings of the inductor not be exceeded. The RMS and peak inductor current can be found from 公式 12 and 公式 13. For this design, the RMS inductor current is 4.0 A and the peak inductor current is 4.4 A. The chosen inductor is a WE 744373240068. It has a saturation current rating of 10.0 A (20% inductance loss) and a RMS current rating of 5.5 A (40 °C. temperature rise). The series resistance is 16.0 mΩ typical.

The current flowing through the inductor is the inductor ripple current plus the output current. During power up, faults or transient load conditions, the inductor current can increase above the calculated peak inductor current level calculated above. In transient conditions, the inductor current can increase up to the switch current limit of the device. For this reason, the most conservative approach is to specify an inductor with a saturation current rating equal to or greater than the switch current limit rather than the steady-state peak inductor current. Additionally if a hard short on the output occurs in a fault condition the peak inductor current can exceed the current limit and may reach up to 10 A. The peak current limit in this scenario is only limited by the minimum on-time of the TPS54116-Q1 and the parasitic DC voltage drops in the circuit. The peak current during a hard short will vary with the switching frequency and only exceeds the current limit when using the TPS54116-Q1 with higher switching frequencies like 2.1 MHz. To protect the inductor in a hard output short the inductor should be rated for this current.

$$L1 = \frac{V_{\text{inmax}} - V_{\text{out}}}{I_{\text{o}} \times K_{\text{IND}}} \times \frac{V_{\text{out}}}{V_{\text{inmax}} \times f_{\text{sw}}} \quad (10)$$

$$I_{\text{ripple}} = \frac{V_{\text{inmax}} - V_{\text{out}}}{L1} \times \frac{V_{\text{out}}}{V_{\text{inmax}} \times f_{\text{sw}}} \quad (11)$$

$$I_{\text{Lrms}} = \sqrt{I_{\text{o}}^2 + \frac{1}{12} \times \left( \frac{V_{\text{o}} \times (V_{\text{inmax}} - V_{\text{o}})}{V_{\text{inmax}} \times L1 \times f_{\text{sw}}} \right)^2} \quad (12)$$

$$I_{\text{Lpeak}} = I_{\text{out}} + \frac{I_{\text{ripple}}}{2} \quad (13)$$

### 8.2.2.3 Output Capacitor

There are three primary considerations for selecting the value of the output capacitor. The output capacitor determines the modulator pole, the output voltage ripple, and how the regulator responds to a large change in load current. The output capacitance needs to be selected based on the more stringent of these three criteria.

The desired response to a large change in the load current is the first criteria and is often the most stringent. The output capacitor needs to supply the increased load current until the regulator responds to the load step. The regulator does not respond immediately to a large, fast increase in the load current such as transitioning from no load to a full load. The regulator usually needs two or more clock cycles for the control loop to sense the change in output voltage and adjust the peak switch current in response to the higher load. The output capacitance must be large enough to supply the difference in current for 2 clock cycles to maintain the output voltage within the specified range. At higher switching frequencies the fastest response time is about 4  $\mu$ s. [公式 14](#) shows the minimum output capacitance necessary, where  $\Delta I_{OUT}$  is the change in output current,  $t_{response}$  is the regulators response time and  $\Delta V_{OUT}$  is the allowable change in the output voltage. The minimum of  $2/f_{sw}$  or 4  $\mu$ s should be used for the response time in the output capacitance calculation. It is important to realize the response to a transient load also depends on the loop compensation and slew rate of the transient load. This calculation assumes the loop compensation is designed for the output filter with the equations later on in this procedure.

For this example, the transient load response is specified as a 4% change in  $V_{OUT}$  for a load step of 2 A. Therefore,  $\Delta I_{OUT}$  is 2 A and  $\Delta V_{OUT} = 0.04 \times 1.5 = 60$  mV. Using these numbers with a 4  $\mu$ s response time gives a minimum capacitance of 133  $\mu$ F. This value does not take the ESR of the output capacitor into account in the output voltage change. For ceramic capacitors, the ESR is usually small enough to be ignored. Aluminum electrolytic and tantalum capacitors have higher ESR that must be considered for load step response.

[公式 15](#) calculates the minimum output capacitance needed to meet the output voltage ripple specification. Where  $f_{sw}$  is the switching frequency,  $V_{ripple}$  is the maximum allowable output voltage ripple, and  $I_{ripple}$  is the inductor ripple current. In this case, the maximum output voltage ripple is 7.5 mV. Under this requirement, [公式 15](#) yields 6.3  $\mu$ F.

$$C_o > t_{response} \times \frac{\Delta I_{out}}{\Delta V_{out}} \quad (14)$$

$$C_o > \frac{1}{8 \times f_{sw}} \times \frac{1}{\frac{V_{ripple}}{I_{ripple}}}$$

Where:

- $\Delta I_{OUT}$  is the change in output current
- $f_{sw}$  is the regulators switching frequency
- $\Delta V_{OUT}$  is the allowable change in the output voltage

(15)

[公式 16](#) calculates the maximum combined ESR the output capacitors can have to meet the output voltage ripple specification and this shows the ESR should be less than 10 m $\Omega$ . In this case ceramic capacitors will be used and the combined ESR of the ceramic capacitors in parallel is much less than 10 m $\Omega$ . Capacitors also generally have limits to the amount of ripple current they can handle without failing or producing excess heat. An output capacitor that can support the inductor ripple current must be specified. Some capacitor data sheets specify the RMS (Root Mean Square) value of the maximum ripple current. [公式 17](#) can be used to calculate the RMS ripple current the output capacitor needs to support. For this application, [公式 17](#) yields 220 mA. Ceramic capacitors used in this design will have a ripple current rating much higher than 220 mA.

$$Resr < \frac{V_{ripple}}{I_{ripple}} \quad (16)$$

$$I_{corms} = \frac{V_{out} \times (V_{inmax} - V_{out})}{\sqrt{12} \times V_{inmax} \times L1 \times f_{sw}} \quad (17)$$

The value of a ceramic capacitor varies significantly over temperature and the amount of DC bias applied to the capacitor. The capacitance variations due to temperature can be minimized by selecting a dielectric material that is stable over temperature. X5R and X7R ceramic dielectrics are usually selected for power regulator capacitors because they have a high capacitance to volume ratio and are fairly stable over temperature. The output capacitor must also be selected with the DC bias taken into account. The capacitance value of a capacitor decreases as the DC bias across a capacitor increases. For this application example, three 47  $\mu\text{F}$  10 V 1210 X7R ceramic capacitors each with 8 m $\Omega$  of ESR at the fsw are used. The estimated capacitance after derating shown on the capacitor manufacturer's website with 1.5 V DC bias is 51.4  $\mu\text{F}$  each. With 3 parallel capacitors the total output capacitance is 154  $\mu\text{F}$  and the ESR is 2.7 m $\Omega$ .

#### 8.2.2.4 Input Capacitor

The TPS54116-Q1 requires a high quality ceramic, type X5R or X7R, input decoupling capacitor of at least 10  $\mu\text{F}$  of effective capacitance placed across the PVIN and PGND pins and in some applications a bulk capacitance. The effective capacitance includes any DC bias effects. The voltage rating of the input capacitor must be greater than the maximum input voltage. The capacitor must also have a ripple current rating greater than the maximum RMS input current of the TPS54116-Q1. The RMS input current can be calculated using 公式 18. An input decoupling capacitor of 1  $\mu\text{F}$  must also be placed at the AVIN pin to ensure a stable input voltage to the internal control circuits.

For this example design, a ceramic capacitor with at least a 10 V voltage rating is required to support the maximum input voltage. For this example, one 47  $\mu\text{F}$  1210 X7R, one 10  $\mu\text{F}$  0603 X7R and one 0.1  $\mu\text{F}$  0603 X7R 10 V capacitors in parallel have been selected for the PVIN to PGND pins. Additionally one 1  $\mu\text{F}$  0603 X5R 10 V capacitor is selected for the AVIN pin. The 0.1  $\mu\text{F}$  at the PVIN pin is used to better bypass the higher frequency content when the high-side MOSFET switches on and off. Based on the capacitor manufacturer's website, the total input capacitance derates to 34  $\mu\text{F}$  at the nominal input voltage of 5 V. The input capacitance value determines the input ripple voltage of the regulator. The input voltage ripple can be calculated using 公式 19. Using the design example values, Ioutmax = 4 A, Cin = 34  $\mu\text{F}$ , fsw = 2.1 MHz, yields an input voltage ripple of 14 mV and a rms input ripple current of 1.9 A.

$$I_{c\text{rms}} = I_{\text{out}} \times \sqrt{\frac{V_{\text{out}}}{V_{\text{inmin}}} \times \frac{(V_{\text{inmin}} - V_{\text{out}})}{V_{\text{inmin}}}} \quad (18)$$

$$\Delta V_{\text{in}} = \frac{I_{\text{outmax}} \times 0.25}{C_{\text{in}} \times f_{\text{sw}}} \quad (19)$$

#### 8.2.2.5 Soft Start Capacitor

The soft-start capacitor determines the minimum amount of time it takes for the output voltage to reach its nominal programmed value during power up. This is useful if a load requires a controlled voltage slew rate. This is also used if the output capacitance is very large and would require large amounts of current to quickly charge the capacitor to the output voltage level. The large currents necessary to charge the capacitor may make the TPS54116-Q1 reach the current limit or excessive current draw from the input power supply may cause the input voltage rail to sag. Limiting the output voltage slew rate solves both of these problems.

The soft-start capacitor value can be calculated using 公式 20. For the example circuit, the soft-start time is not too critical since the output capacitor value of 3 x 47  $\mu\text{F}$  does not require much current to charge to 1.5 V. With the higher switching frequency used in this example a faster start-up time improves the start up behavior. Near the beginning of the start up time when the output voltage is low the minimum on-time of the converter is too large to regulate the output causing additional ripple on the output. A faster start-up time will reduce the time the converter spends in this region. The example circuit is designed for a soft-start time of 0.6 ms which requires a 3300 pF capacitor.

$$C_{\text{SS}} (\text{nF}) = 5.3 \times t_{\text{SS}} (\text{ms}) \quad (20)$$

### 8.2.2.6 Undervoltage Lock Out Set Point

The Undervoltage Lock Out (UVLO) can be adjusted using an external voltage divider on the ENSW and ENLDO pin of the TPS54116. Each pin can have its own resistor divider if different thresholds are needed for the VTT LDO and the buck converter. If only one threshold is needed only one resistor divider is needed and the pins can be connected in parallel. If connected in parallel the pull up current and hysteresis current should be increased to 3.4  $\mu$ A and 5.1  $\mu$ A respectively as shown in the electrical specifications. The UVLO has two thresholds, one for power-up when the input voltage is rising, and one for power-down or brown outs when the input voltage is falling.

For the example design, the supply should turn on and start switching once the input voltage increases above 2.9 V (enabled). After the regulator starts switching, it should continue to do so until the input voltage falls below 2.6 V (UVLO stop). The EN pins are also connected in parallel so the higher pull up current and hysteresis current is used. 公式 2 through 公式 3 can be used to calculate the resistance values necessary. A 45.3 k $\Omega$  between PVIN and the EN pins (R1) and a 30.1 k $\Omega$  between the EN pins and ground (R2) are used producing a start voltage of 2.85 V and stop voltage of 2.47 V. The 2.47 V stop voltage is below the 2.65 V AVIN UVLO so with this application example the TPS54116-Q1 will turn off due to the AVIN UVLO.

### 8.2.2.7 Bootstrap Capacitor

A 0.1  $\mu$ F ceramic capacitor must be connected between the BOOT and SW pins for proper operation. It is recommended to use a ceramic capacitor with X5R or better grade dielectric. The capacitor should have 10 V or higher voltage rating.

### 8.2.2.8 Power Good Pullup

A 100 k $\Omega$  resistor is used to pull up the power good signal to VIN when FB conditions are met.

### 8.2.2.9 ILIM Resistor

The recommended peak current limit is calculated with 公式 21 using ILpeak from 公式 13. This calculation includes 10% margin for load transients and an additional 1.5 A for the tolerance of the peak current limit. In this application a 100 k $\Omega$  resistor is placed from ILIM to AGND to set the peak current limit to its maximum value. For applications requiring a different peak current limit 公式 7 is used to calculate the ILIM resistor.

$$I_{\text{limit}} = I_{\text{Lpeak}} \times 1.1 + 1.5\text{A} \quad (21)$$

### 8.2.2.10 Output Voltage and Feedback Resistors Selection

For the example design, 10.0 k $\Omega$  was selected for R7. Using 公式 22, R5 is calculated as 15.0 k $\Omega$  which is a standard 1% resistor.

$$R_{\text{FBT}} = R_{\text{FBB}} \times \left( \frac{V_{\text{OUT}}}{V_{\text{REF}}} - 1 \right) \quad (22)$$

### 8.2.2.11 Compensation

There are several methods used to compensate DC - DC regulators. The method presented here is easy to calculate and ignores the effects of the slope compensation that is internal to the device. Because the slope compensation is ignored, the actual cross-over frequency will usually be lower than the cross-over frequency used in the calculations. This method assumes the cross-over frequency is between the modulator pole and the ESR zero and the ESR zero is at least 10 times greater the modulator pole. This is the case when using low ESR output capacitors. Use the WEBENCH software for more accurate loop compensation. These tools include a more comprehensive model of the control loop.

To get started, the modulator pole,  $f_{p\text{mod}}$ , and the ESR zero,  $f_{z1}$  must be calculated using 公式 23 and 公式 24. For  $C_{out}$ , use a derated value of 154  $\mu\text{F}$ . Use equations 公式 25 and 公式 26, to estimate a starting point for the crossover frequency,  $f_{co}$ , to design the compensation. For the example design,  $f_{p\text{mod}}$  is 2.8 kHz and  $f_{z\text{mod}}$  is 388 kHz. 公式 25 is the geometric mean of the modulator pole and the esr zero and 公式 26 is the mean of modulator pole and one half the switching frequency or 250 kHz, whichever is larger. For the 2.1 MHz switching frequency application 250 kHz is used so 公式 25 yields 33 kHz and 公式 26 gives 52 kHz. Use the lower value of 公式 25 or 公式 26 for an initial crossover frequency. Next, the compensation components are calculated. A resistor-in-series with a capacitor is used to create a compensating zero. A capacitor in parallel to these two components forms the compensating pole.

$$f_{p\text{mod}} = \frac{I_{out\text{max}}}{2 \times \pi \times V_{out} \times C_{out}} \quad (23)$$

$$f_{z\text{mod}} = \frac{1}{2 \times \pi \times R_{esr} \times C_{out}} \quad (24)$$

$$f_{co} = \sqrt{f_{p\text{mod}} \times f_{z\text{mod}}} \quad (25)$$

$$f_{co} = \sqrt{f_{p\text{mod}} \times \frac{f_{sw}}{2}} \quad (26)$$

To determine the compensation resistor,  $R_6$ , use 公式 27. Assume the power stage transconductance,  $g_{mps}$ , is 16 A/V. The output voltage,  $V_o$ , reference voltage,  $V_{REF}$ , and amplifier transconductance,  $g_{mea}$ , are 1.5 V, 0.6 V and 260  $\mu\text{A/V}$ , respectively.  $R_6$  is calculated to be 19 k $\Omega$  and the closest standard value 19.1 k $\Omega$ . Use 公式 28 to set the compensation zero to the modulator pole frequency. 公式 28 yields 3020 pF for compensating capacitor  $C_6$  and the closest standard value is 3300 pF.

$$R_{COMP} = \left( \frac{2 \times \pi \times f_{CO} \times C_{OUT}}{g_{mPS}} \right) \times \left( \frac{V_{OUT}}{V_{REF} \times g_{mEA}} \right) \quad (27)$$

$$C_{COMP} = \frac{1}{2 \times \pi \times R_{COMP} \times f_{P\text{MOD}}} \quad (28)$$

A compensation pole is implemented using an additional capacitor  $C_7$  in parallel with the series combination of  $R_6$  and  $C_6$ . This capacitor is recommended to help filter any noise that may couple to the COMP voltage signal. Use the larger value of 公式 29 and 公式 30 to calculate the  $C_7$ , to set the compensation pole.  $C_7$  is calculated to 21 pF or 8 pF and the closest standard value is 22 pF.

$$C_{HF} = \frac{C_{OUT} \times R_{ESR}}{R_{COMP}} \quad (29)$$

$$C_{HF} = \frac{1}{\pi \times R_{COMP} \times f_{SW}} \quad (30)$$

Type III compensation is used by adding the feed forward capacitor ( $C_{17}$ ) in parallel with the upper feedback resistor. This increases the crossover and adds phase boost above what is normally possible from Type II compensation. It places an additional zero/pole pair. This zero and pole pair is not independent. Once the zero location is chosen, the pole is fixed as well. The zero is placed at the intended crossover frequency by calculating the value of  $C_{17}$  with 公式 31. The calculated value is 216 pF and the closest standard value is 220 pF.

$$C_{FF} = \frac{1}{3 \times \pi \times R_{F\text{BT}} \times f_{CO}} \quad (31)$$

The initial compensation based on these calculations is  $R_6 = 19.1$  k $\Omega$ ,  $C_6 = 3300$  pF,  $C_7 = 22$  pF and  $C_{17} = 220$  pF. These values yield a stable design but after testing the real circuit these values were changed to optimize performance. The final values used in the schematic are  $R_6 = 20.5$  k $\Omega$ ,  $C_6 = 1800$  pF,  $C_7 = 180$  pF and  $C_{17} = 180$  pF.

### 8.2.2.12 LDOIN Capacitor

Depending on the trace impedance between the LDOIN bulk power supply to the device, a transient increase of source current is supplied mostly by the charge from the LDOIN input capacitor. Use a 10- $\mu\text{F}$  (or greater) and X5R grade (or better) ceramic capacitor to supply this transient charge.

### 8.2.2.13 VTTREF Capacitor

Add a ceramic capacitor, with a value 0.22  $\mu\text{F}$  and X5R grade (or better), placed close to the VTTREF terminal for stable operation.

### 8.2.2.14 VTT Capacitor

For stable operation, two 10- $\mu\text{F}$  (or greater) and X5R (or better) grade ceramic capacitor(s) need to be attached close to the VTT terminal. This capacitor is recommended to minimize any additional equivalent series resistance (ESR) and/or equivalent series inductance (ESL) of ground trace between the PGND terminal and the VTT capacitor(s).

## 8.2.3 Application Curves



图 49. V<sub>DD</sub> Output Efficiency



图 50. V<sub>DD</sub> Output Load Regulation, V<sub>IN</sub> = 5 V

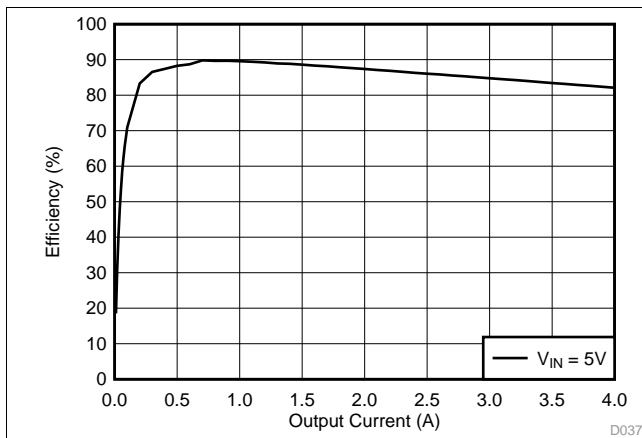

图 51. V<sub>DD</sub> Output Line Regulation, I<sub>OUT</sub> = 2 A

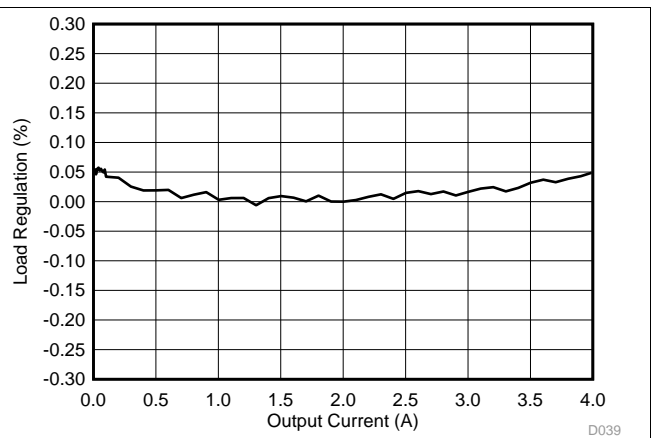

图 52. V<sub>DD</sub> Output Loop Response



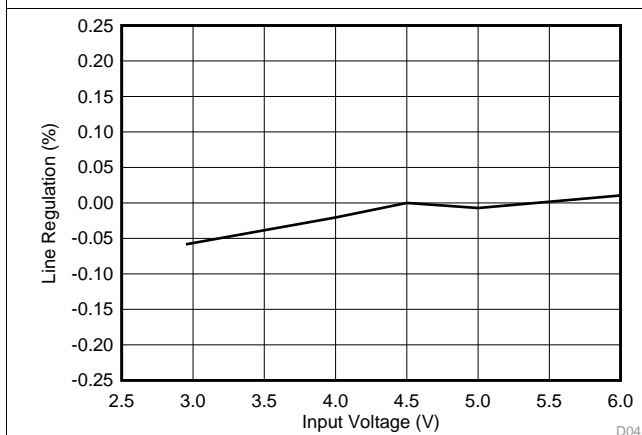

图 53.  $V_{DD}$  Start-Up Relative to Enable

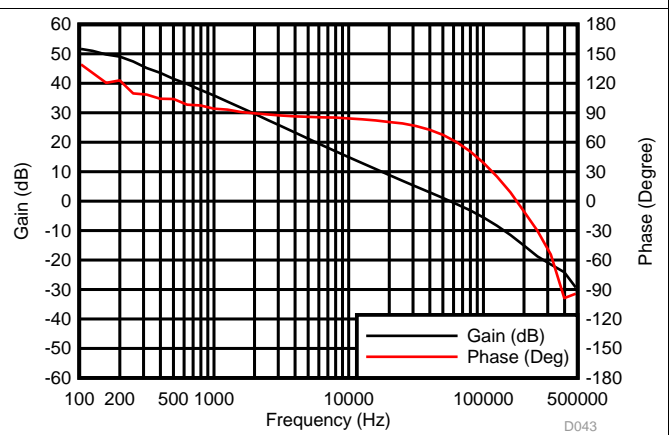

图 54.  $V_{TT}$  and  $V_{DD}$  Start-Up Relative to Enable

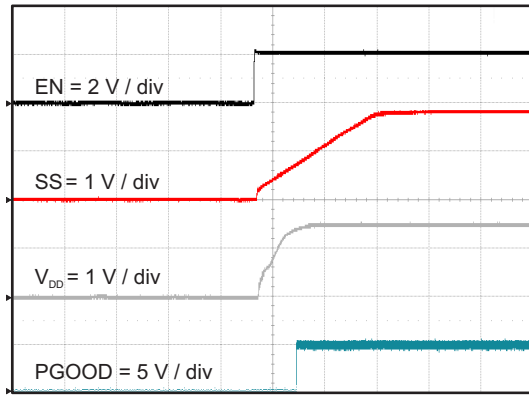

图 55.  $V_{DD}$  Start-Up Relative to  $V_{IN}$

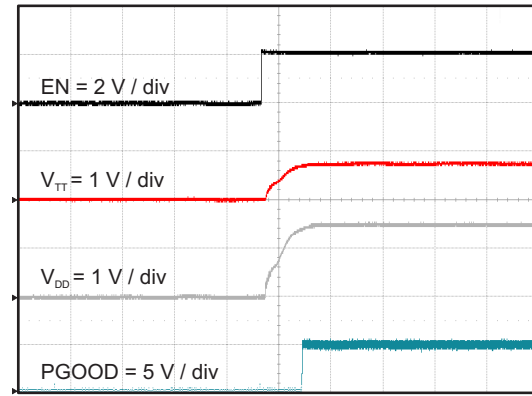

图 56.  $V_{DD}$  Shutdown Relative to Enable

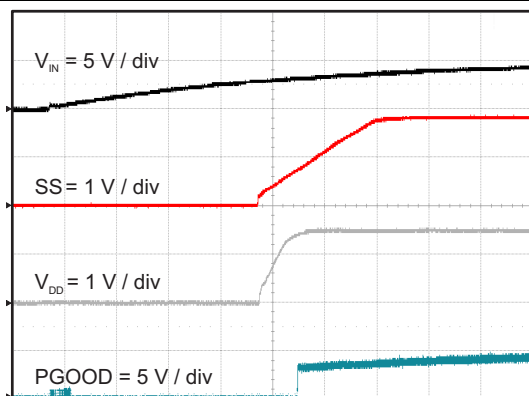

图 57.  $V_{TT}$  and  $V_{DD}$  Shutdown Relative to Enable

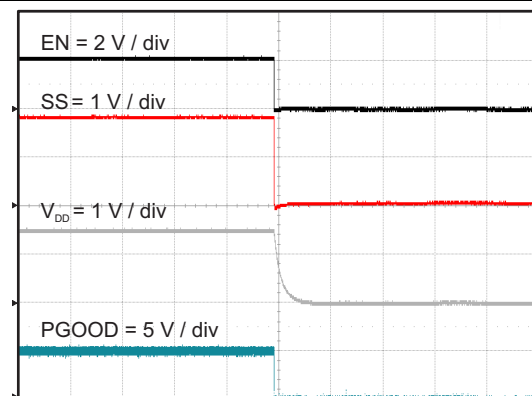

图 58.  $V_{DD}$  Shutdown Relative to  $V_{IN}$



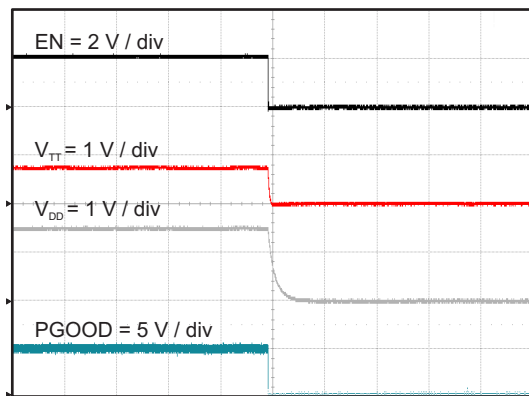

Time = 500 nsec / div  
图 59. V<sub>DD</sub> Output Ripple

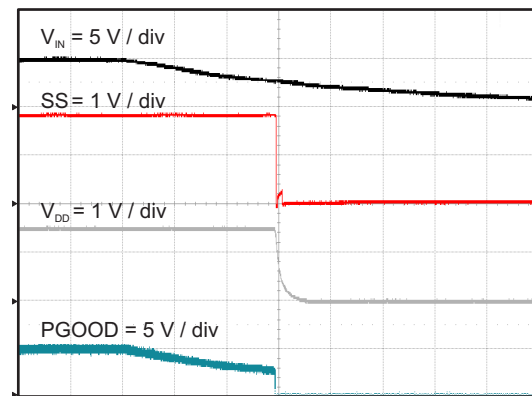
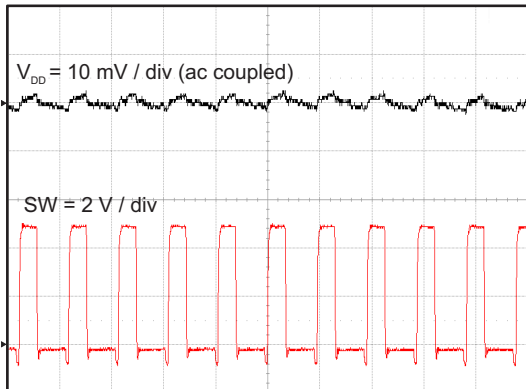
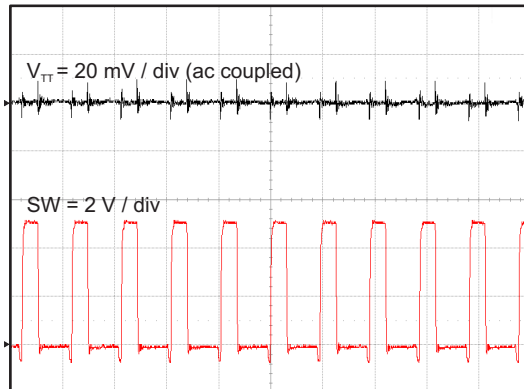

Time = 500 nsec / div  
图 60. V<sub>TT</sub> Output Ripple

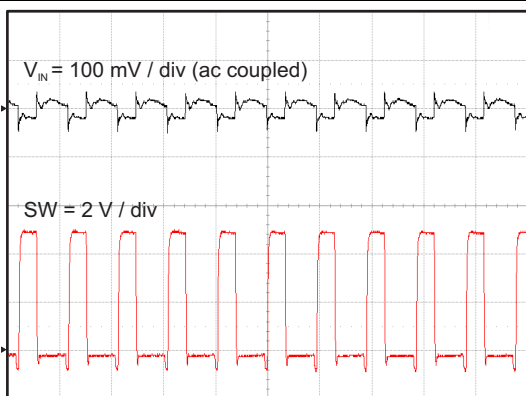

Time = 500 nsec / div  
图 61. Input Ripple

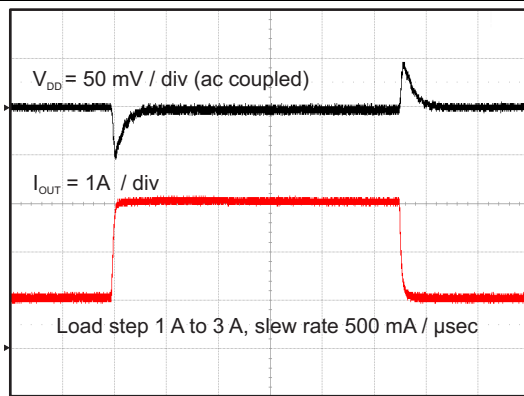

Time = 200 μsec / div  
图 62. V<sub>DD</sub> Output Transient Response

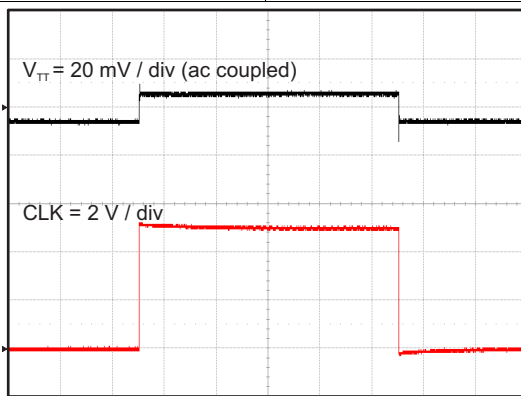

Time = 100 μsec / div  
图 63. V<sub>TT</sub> Output Transient Response

## 9 Power Supply Recommendations

The TPS54116-Q1 is designed to be powered by a well regulated dc voltage between 2.95 and 6 V. The TPS54116-Q1 is a buck converter so the input supply voltage must be greater than the desired output voltage to regulate the output voltage to the desired value. If the input supply voltage is not high enough the output voltage will begin to drop. Input supply current must be appropriate for the desired output current.

## 10 Layout

### 10.1 Layout Guidelines

Layout is a critical portion of good power supply design. There are several signal paths that conduct fast changing currents or voltages that can interact with stray inductance or parasitic capacitance to generate noise or degrade the power supplies performance. Guidelines are as follows. See [Figure 64](#) for a PCB layout example.

- The input bypass capacitor for PVIN to PGND should be placed as close as possible to the TPS54116-Q1 with short and wide connections to minimize parasitic inductance.
- The input bypass capacitor for AVIN should be placed as close as possible to the TPS54116-Q1 with a short return to the AGND pin. This capacitor and pin should also be tied to the input voltage before the PVIN bypass capacitors to limit the switching noise from PVIN.
- The output capacitor for VTT to VTTGND should be placed as close as possible to the TPS54116-Q1 with short and wide connections to minimize parasitic inductance and resistance. Too much parasitic inductance and resistance can affect the stability of the high performance VTT LDO.
- The VTTSENS pin should be connected to the VTT output capacitors as a separate trace from the high current VTT power trace. If sensing the voltage at the point of the load is required, it is recommended to also attach the output capacitors at that point while still minimizing parasitic inductance and resistance.
- The input bypass capacitor for LDOIN to VTTGND should be placed as close as possible to the TPS54116-Q1 with short and wide connections to minimize parasitic inductance. This capacitor is used to supply the transient current to the VTT output.
- The VDDQSNS pin should be routed as a separate trace from the high current VDDQ trace and connect near the point of regulation for VDDQ.
- The top of the FB resistor divider should be routed as a separate trace from the high current VDDQ trace and connect near the the point of regulation for VDDQ.
- The analog control circuits should have a return path to the quiet AGND and not overlap with the noisy PGND. Sensitive pins containing analog control circuits are RT/SYNC, SS/TRK, COMP, FB, ILIM, and VTTREF. It is important to minimize the length of the traces connected to the RT/SYNC, COMP, FB and ILIM pins.
- The PGND pins, AGND and VTTGND pin should be tied directly to the power pad under the IC to provide a low impedance connection between the pins.
- The BOOT capacitor should connect directly between the BOOT and SW pins.
- The SW pin should be routed to the output inductor with a short and wide trace to minimize capacitive coupling.
- The thermal pad should be connected to any internal PCB ground planes using multiple vias directly under the IC. For operation at full rated load, the top side ground area and bottom side ground area along with any additional internal ground planes must provide adequate heat dissipating area. For best thermal performance minimize cuts in the bottom side ground copper.
- Additional vias can be used to connect the top side ground area to the internal planes near the input and output capacitors for the buck converter and VTT LDO.

The additional external components can be placed approximately as shown. It may be possible to obtain acceptable performance with alternate PCB layouts, however this layout has been shown to produce good results and is meant as a guideline.

## 10.2 Layout Example



图 64. PCB Layout Example

## 11 器件和文档支持

### 11.1 接收文档更新通知

如需接收文档更新通知，请访问 [www.ti.com.cn](http://www.ti.com.cn) 网站上的器件产品文件夹。点击右上角的提醒我 (Alert me) 注册后，即可每周定期收到已更改的产品信息。有关更改的详细信息，请查阅已修订文档中包含的修订历史记录。

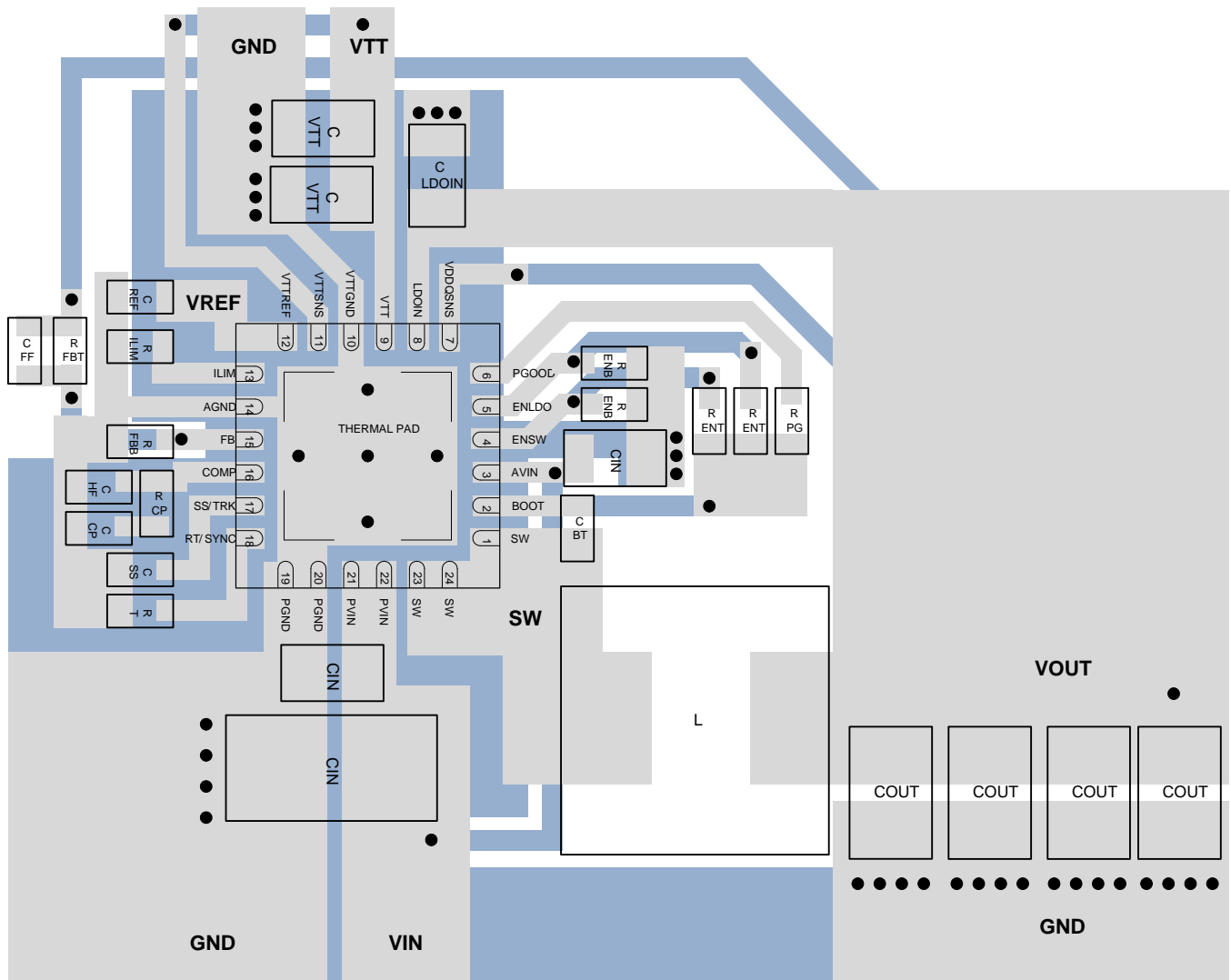
### 11.2 社区资源

The following links connect to TI community resources. Linked contents are provided "AS IS" by the respective contributors. They do not constitute TI specifications and do not necessarily reflect TI's views; see TI's [Terms of Use](#).

**TI E2E™ Online Community** *TI's Engineer-to-Engineer (E2E) Community*. Created to foster collaboration among engineers. At [e2e.ti.com](http://e2e.ti.com), you can ask questions, share knowledge, explore ideas and help solve problems with fellow engineers.

**Design Support** *TI's Design Support* Quickly find helpful E2E forums along with design support tools and contact information for technical support.

### 11.3 商标

E2E is a trademark of Texas Instruments.  
All other trademarks are the property of their respective owners.

### 11.4 静电放电警告



这些装置包含有限的内置 ESD 保护。存储或装卸时，应将导线一起截短或将装置放置于导电泡棉中，以防止 MOS 门极遭受静电损伤。

### 11.5 Glossary

[SLYZ022](#) — *TI Glossary*.

This glossary lists and explains terms, acronyms, and definitions.

## 12 机械、封装和可订购信息

以下页中包括机械、封装和可订购信息。这些信息是针对指定器件可提供的最新数据。这些数据会在无通知且不对本文档进行修订的情况下发生改变。欲获得该数据表的浏览器版本，请查阅左侧的导航栏

## 重要声明

德州仪器(TI)及其下属子公司有权根据 JESD46 最新标准,对所提供的产品和服务进行更正、修改、增强、改进或其它更改,并有权根据 JESD48 最新标准中止提供任何产品和服务。客户在下订单前应获取最新的相关信息,并验证这些信息是否完整且是最新的。所有产品的销售都遵循在订单确认时所提供的TI 销售条款与条件。

TI 保证其所销售的组件的性能符合产品销售时 TI 半导体产品销售条件与条款的适用规范。仅在 TI 保证的范围内,且 TI 认为有必要时才会使用测试或其它质量控制技术。除非适用法律做出了硬性规定,否则没有必要对每种组件的所有参数进行测试。

TI 对应用帮助或客户产品设计不承担任何义务。客户应对其使用 TI 组件的产品和应用自行负责。为尽量减小与客户产品和应用相关的风险,客户应提供充分的设计与操作安全措施。

TI 不对任何 TI 专利权、版权、屏蔽作品权或其它与使用了 TI 组件或服务的组合设备、机器或流程相关的 TI 知识产权中授予的直接或隐含权限作出任何保证或解释。TI 所发布的与第三方产品或服务有关的信息,不能构成从 TI 获得使用这些产品或服务的许可、授权、或认可。使用此类信息可能需要获得第三方的专利权或其它知识产权方面的许可,或是 TI 的专利权或其它知识产权方面的许可。

对于 TI 的产品手册或数据表中 TI 信息的重要部分,仅在没有对内容进行任何篡改且带有相关授权、条件、限制和声明的情况下才允许进行复制。TI 对此类篡改过的文件不承担任何责任或义务。复制第三方的信息可能需要服从额外的限制条件。

在转售 TI 组件或服务时,如果对该组件或服务参数的陈述与 TI 标明的参数相比存在差异或虚假成分,则会失去相关 TI 组件或服务的所有明示或暗示授权,且这是不正当的、欺诈性商业行为。TI 对任何此类虚假陈述均不承担任何责任或义务。

客户认可并同意,尽管任何应用相关信息或支持仍可能由 TI 提供,但他们将独立负责满足与其产品及其在应用中使用的 TI 产品相关的所有法律、法规和安全相关要求。客户声明并同意,他们具备制定与实施安全措施所需的全部专业技术和知识,可预见故障的危险后果、监测故障及其后果、降低有可能造成人身伤害的故障的发生机率并采取适当的补救措施。客户将全额赔偿因在此类安全关键应用中使用任何 TI 组件而对 TI 及其代理造成的任何损失。

在某些场合中,为了推进安全相关应用有可能对 TI 组件进行特别的促销。TI 的目标是利用此类组件帮助客户设计和创立其特有的可满足适用的功能安全性标准和要求的终端产品解决方案。尽管如此,此类组件仍然服从这些条款。

TI 组件未获得用于 FDA Class III (或类似的生命攸关医疗设备)的授权许可,除非各方授权官员已经达成了专门管控此类使用的特别协议。



只有那些 TI 特别注明属于军用等级或“增强型塑料”的 TI 组件才是设计或专门用于军事/航空应用或环境的。购买者认可并同意,对并非指定面向军事或航空航天用途的 TI 组件进行军事或航空航天方面的应用,其风险由客户单独承担,并且由客户独立负责满足与此类使用相关的所有法律和法规要求。

TI 已明确指定符合 ISO/TS16949 要求的产品,这些产品主要用于汽车。在任何情况下,因使用非指定产品而无法达到 ISO/TS16949 要求, TI 不承担任何责任。

	产品		应用
数字音频	<a href="http://www.ti.com.cn/audio">www.ti.com.cn/audio</a>	通信与电信	<a href="http://www.ti.com.cn/telecom">www.ti.com.cn/telecom</a>
放大器和线性器件	<a href="http://www.ti.com.cn/amplifiers">www.ti.com.cn/amplifiers</a>	计算机及周边	<a href="http://www.ti.com.cn/computer">www.ti.com.cn/computer</a>
数据转换器	<a href="http://www.ti.com.cn/dataconverters">www.ti.com.cn/dataconverters</a>	消费电子	<a href="http://www.ti.com.cn/consumer-apps">www.ti.com.cn/consumer-apps</a>
DLP® 产品	<a href="http://www.dlp.com">www.dlp.com</a>	能源	<a href="http://www.ti.com.cn/energy">www.ti.com.cn/energy</a>
DSP - 数字信号处理器	<a href="http://www.ti.com.cn/dsp">www.ti.com.cn/dsp</a>	工业应用	<a href="http://www.ti.com.cn/industrial">www.ti.com.cn/industrial</a>
时钟和计时器	<a href="http://www.ti.com.cn/clockandtimers">www.ti.com.cn/clockandtimers</a>	医疗电子	<a href="http://www.ti.com.cn/medical">www.ti.com.cn/medical</a>
接口	<a href="http://www.ti.com.cn/interface">www.ti.com.cn/interface</a>	安防应用	<a href="http://www.ti.com.cn/security">www.ti.com.cn/security</a>
逻辑	<a href="http://www.ti.com.cn/logic">www.ti.com.cn/logic</a>	汽车电子	<a href="http://www.ti.com.cn/automotive">www.ti.com.cn/automotive</a>
电源管理	<a href="http://www.ti.com.cn/power">www.ti.com.cn/power</a>	视频和影像	<a href="http://www.ti.com.cn/video">www.ti.com.cn/video</a>
微控制器 (MCU)	<a href="http://www.ti.com.cn/microcontrollers">www.ti.com.cn/microcontrollers</a>		
RFID 系统	<a href="http://www.ti.com.cn/rfidsys">www.ti.com.cn/rfidsys</a>		
OMAP应用处理器	<a href="http://www.ti.com/omap">www.ti.com/omap</a>		
无线连通性	<a href="http://www.ti.com.cn/wirelessconnectivity">www.ti.com.cn/wirelessconnectivity</a>	德州仪器在线技术支持社区	<a href="http://www.deyisupport.com">www.deyisupport.com</a>

邮寄地址: 上海市浦东新区世纪大道1568号, 中建大厦32楼邮政编码: 200122  
Copyright © 2016, 德州仪器半导体技术(上海)有限公司

**PACKAGING INFORMATION**

Orderable Device	Status (1)	Package Type	Package Drawing	Pins	Package Qty	Eco Plan (2)	Lead finish/ Ball material (6)	MSL Peak Temp (3)	Op Temp (°C)	Device Marking (4/5)	Samples
TPS54116QRTWRQ1	ACTIVE	WQFN	RTW	24	3000	RoHS & Green	NIPDAU	Level-2-260C-1 YEAR	-40 to 125	54116Q A2	
TPS54116QRTWTQ1	ACTIVE	WQFN	RTW	24	250	RoHS & Green	NIPDAU	Level-2-260C-1 YEAR	-40 to 125	54116Q A2	

(1) The marketing status values are defined as follows:

**ACTIVE:** Product device recommended for new designs.

**LIFEBUY:** TI has announced that the device will be discontinued, and a lifetime-buy period is in effect.

**NRND:** Not recommended for new designs. Device is in production to support existing customers, but TI does not recommend using this part in a new design.

**PREVIEW:** Device has been announced but is not in production. Samples may or may not be available.

**OBSOLETE:** TI has discontinued the production of the device.

(2) **RoHS:** TI defines "RoHS" to mean semiconductor products that are compliant with the current EU RoHS requirements for all 10 RoHS substances, including the requirement that RoHS substance do not exceed 0.1% by weight in homogeneous materials. Where designed to be soldered at high temperatures, "RoHS" products are suitable for use in specified lead-free processes. TI may reference these types of products as "Pb-Free".

**RoHS Exempt:** TI defines "RoHS Exempt" to mean products that contain lead but are compliant with EU RoHS pursuant to a specific EU RoHS exemption.

**Green:** TI defines "Green" to mean the content of Chlorine (Cl) and Bromine (Br) based flame retardants meet JS709B low halogen requirements of <=1000ppm threshold. Antimony trioxide based flame retardants must also meet the <=1000ppm threshold requirement.

(3) MSL, Peak Temp. - The Moisture Sensitivity Level rating according to the JEDEC industry standard classifications, and peak solder temperature.

(4) There may be additional marking, which relates to the logo, the lot trace code information, or the environmental category on the device.

(5) Multiple Device Markings will be inside parentheses. Only one Device Marking contained in parentheses and separated by a "~" will appear on a device. If a line is indented then it is a continuation of the previous line and the two combined represent the entire Device Marking for that device.

(6) Lead finish/Ball material - Orderable Devices may have multiple material finish options. Finish options are separated by a vertical ruled line. Lead finish/Ball material values may wrap to two lines if the finish value exceeds the maximum column width.

**Important Information and Disclaimer:**The information provided on this page represents TI's knowledge and belief as of the date that it is provided. TI bases its knowledge and belief on information provided by third parties, and makes no representation or warranty as to the accuracy of such information. Efforts are underway to better integrate information from third parties. TI has taken and continues to take reasonable steps to provide representative and accurate information but may not have conducted destructive testing or chemical analysis on incoming materials and chemicals. TI and TI suppliers consider certain information to be proprietary, and thus CAS numbers and other limited information may not be available for release.

In no event shall TI's liability arising out of such information exceed the total purchase price of the TI part(s) at issue in this document sold by TI to Customer on an annual basis.



## TAPE AND REEL INFORMATION



### QUADRANT ASSIGNMENTS FOR PIN 1 ORIENTATION IN TAPE



\*All dimensions are nominal

Device	Package Type	Package Drawing	Pins	SPQ	Reel Diameter (mm)	Reel Width W1 (mm)	A0 (mm)	B0 (mm)	K0 (mm)	P1 (mm)	W (mm)	Pin1 Quadrant
TPS54116QRTWRQ1	WQFN	RTW	24	3000	330.0	12.4	4.25	4.25	1.15	8.0	12.0	Q2
TPS54116QRTWTQ1	WQFN	RTW	24	250	180.0	12.4	4.25	4.25	1.15	8.0	12.0	Q2



**TAPE AND REEL BOX DIMENSIONS**

\*All dimensions are nominal

Device	Package Type	Package Drawing	Pins	SPQ	Length (mm)	Width (mm)	Height (mm)
TPS54116QRTWRQ1	WQFN	RTW	24	3000	367.0	367.0	35.0
TPS54116QRTWTQ1	WQFN	RTW	24	250	210.0	185.0	35.0

## 重要声明和免责声明

TI 均以“原样”提供技术性及其可靠性数据（包括数据表）、设计资源（包括参考设计）、应用或其他设计建议、网络工具、安全信息和其他资源，不保证其中不含任何瑕疵，且不做任何明示或暗示的担保，包括但不限于对适销性、适合某特定用途或不侵犯任何第三方知识产权的暗示担保。

所述资源可供专业开发人员应用TI 产品进行设计使用。您将对以下行为独自承担全部责任：(1) 针对您的应用选择合适的TI 产品；(2) 设计、验证并测试您的应用；(3) 确保您的应用满足相应标准以及任何其他安全、安保或其他要求。所述资源如有变更，恕不另行通知。TI 对您使用所述资源的授权仅限于开发资源所涉及TI 产品的相关应用。除此之外不得复制或展示所述资源，也不提供其它TI 或任何第三方的知识产权授权许可。如因使用所述资源而产生任何索赔、赔偿、成本、损失及债务等，TI 对此概不负责，并且您须赔偿由此对TI 及其代表造成的损害。

TI 所提供产品均受TI 的销售条款 (<http://www.ti.com.cn/zh-cn/legal/termsofsale.html>) 以及ti.com.cn上或随附TI产品提供的其他可适用条款的约束。TI提供所述资源并不扩展或以其他方式更改TI 针对TI 产品所发布的可适用的担保范围或担保免责声明。

邮寄地址：上海市浦东新区世纪大道 1568 号中建大厦 32 楼，邮政编码：200122

Copyright © 2020 德州仪器半导体技术（上海）有限公司