

# ADC322x

## 双通道 12 位 25MSPS 至 125MSPS 模数转换器

### 1 特性

- 双通道
- 12 位分辨率
- 单电源：1.8V
- 串行 LVDS 接口 (SLVDS)
- 支持 1 分频、2 分频和 4 分频的灵活输入时钟缓冲器
- $f_{IN} = 70\text{MHz}$  时， $\text{SNR} = 70.2\text{dBFS}$ ， $\text{SFDR} = 87\text{dBc}$
- 超低功耗：
  - 125MSPS 时为每通道 116mW
- 通道隔离：105dB
- 内部抖动和斩波
- 支持多芯片同步
- 与 14 位版本之间具有引脚到引脚兼容性
- 封装：VQFN-48 (7mm × 7mm)

### 2 应用

- [多载波多模式蜂窝基站](#)
- [雷达和智能天线阵列](#)
- [军需品指导](#)
- [电机控制反馈](#)
- [网络和矢量分析器](#)
- [通信测试设备](#)
- [无损检测](#)
- [微波接收器](#)
- [软件定义的无线电 \(SDR\)](#)
- [正交和多样性无线电接收器](#)
- [手持式无线电和仪表](#)

### 3 说明

ADC322x 属于高线性度、超低功耗、双通道、12 位、25MSPS 至 125MSPS 模数转换器 (ADC) 系列。此类器件专门设计用于支持具有宽动态范围需求且要求苛刻的高输入频率信号。当 SYSREF 输入实现整个系统同步时，时钟输入分频器将给予系统时钟架构设计更高的灵活性。ADC322x 系列支持串行低压差分信号 (LVDS)，从而减少接口线路的数量，实现高系统集成度。串行 LVDS 接口为双线制，每种 ADC 数据采用串行形式并通过两个 LVDS 对输出。此外，还提供单线制串行 LVDS 接口。内部锁相环 (PLL) 会将传入的 ADC 采样时钟加倍，以获得串行输出各通道的 12 位输出数据时所使用的位时钟。除了串行数据流之外，数据帧和位时钟也作为 LVDS 输出进行传送。

#### 封装信息

器件型号	封装 <sup>(1)</sup>	封装尺寸 (标称值)
ADC322x	VQFN (48)	7.00mm × 7.00mm

(1) 如需了解所有可用封装，请参阅数据表末尾的可订购产品附录。

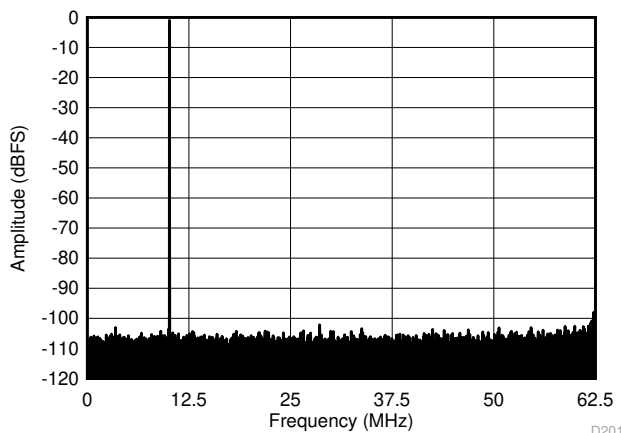

$f_S = 125\text{MSPS}$  且  $f_{IN} = 10\text{MHz}$  时的性能  
(  $\text{SNR} = 70.6\text{dBFS}$  ,  $\text{SFDR} = 100\text{dBc}$  )



## Table of Contents

1 特性.....	1	6.19 Typical Characteristics: Common.....	42
2 应用.....	1	6.20 Typical Characteristics: Contour.....	43
3 说明.....	1	<b>7 Parameter Measurement Information.....</b>	<b>44</b>
<b>4 Revision History.....</b>	<b>2</b>	7.1 Timing Diagrams.....	44
<b>5 Pin Configuration and Functions.....</b>	<b>4</b>	<b>8 Detailed Description.....</b>	<b>46</b>
<b>6 Specifications.....</b>	<b>6</b>	8.1 Overview.....	46
6.1 Absolute Maximum Ratings.....	6	8.2 Functional Block Diagram.....	46
6.2 ESD Ratings.....	6	8.3 Feature Description.....	47
6.3 Recommended Operating Conditions <sup>(2)</sup> .....	6	8.4 Device Functional Modes.....	52
6.4 Thermal Information.....	7	8.5 Programming.....	53
6.5 Electrical Characteristics: General.....	7	8.6 Register Maps.....	57
6.6 Electrical Characteristics: ADC3221, ADC3222.....	8	<b>9 Applications and Implementation.....</b>	<b>68</b>
6.7 Electrical Characteristics: ADC3223, ADC3224.....	8	9.1 Application Information.....	68
6.8 AC Performance: ADC3221.....	9	9.2 Typical Applications.....	69
6.9 AC Performance: ADC3222.....	12	9.3 Power Supply Recommendations.....	71
6.10 AC Performance: ADC3223.....	15	9.4 Layout.....	72
6.11 AC Performance: ADC3224.....	17	<b>10 Device and Documentation Support.....</b>	<b>73</b>
6.12 Digital Characteristics.....	19	10.1 接收文档更新通知.....	73
6.13 Timing Requirements: General.....	19	10.2 支持资源.....	73
6.14 Timing Requirements: LVDS Output.....	20	10.3 Trademarks.....	73
6.15 Typical Characteristics: ADC3221.....	21	10.4 Electrostatic Discharge Caution.....	73
6.16 Typical Characteristics: ADC3222.....	26	10.5 术语表.....	73
6.17 Typical Characteristics: ADC3223.....	32	<b>11 Mechanical, Packaging, and Orderable Information.....</b>	<b>73</b>
6.18 Typical Characteristics: ADC3224.....	37		

## 4 Revision History

Changes from Revision D (August 2019) to Revision E (June 2022)	Page
• Changed the device number from: ADC3241 to: ADC3221 and ADC3242 to: ADC3222 in <i>Electrical Characteristics: ADC3221, ADC3222</i> .....	8
• Changed the device number from: ADC3243 to: ADC3223 and ADC3244 to: ADC3224 in <i>Electrical Characteristics: ADC3223, ADC3224</i> .....	8
Changes from Revision C (July 2019) to Revision D (August 2019)	Page
• Deleted Graphs: Histogram, Integral Nonlinearity, and Differential Nonlinearity .....	21
• Deleted Graphs: Histogram, Integral Nonlinearity, and Differential Nonlinearity .....	26
• Deleted Graphs: Histogram, Integral Nonlinearity, and Differential Nonlinearity .....	32
• Deleted Graphs: Histogram, Integral Nonlinearity, and Differential Nonlinearity .....	37
Changes from Revision B (March 2016) to Revision C (July 2019)	Page
• 在说明中添加了文本：此外，还提供单线制串行 LVDS 接口。.....	1
• Changed the description of pin AVDD, DVDD, GND, and PDN pins in the <i>Pin Functions</i> table .....	4
• Changed the condition statement for <i>Electrical Characteristics: General</i> .....	7
• Moved the location of <i>Electrical Characteristics: General</i> .....	7
• Changed the parameter description of $E_{G(REF)}$ in <i>Electrical Characteristics: General</i> .....	7
• Deleted $E_{G(CHAN)}$ from <i>Electrical Characteristics: General</i> .....	7
• Changed the parameter description of $\alpha_{(EGCHAN)}$ in <i>Electrical Characteristics: General</i> .....	7
• Changed the condition statement for <i>Electrical Characteristics: ADC3221, ADC3222</i> .....	8
• Changed ADC clock frequency (ADC3241) From: MAX = 125 MSPS To: MAX = 25 MSPS in <i>Electrical Characteristics: ADC3221, ADC3222</i> .....	8

• Changed ADC clock frequency (ADC3242) From: MAX = 125 MSPS To: MAX = 50 MSPS in <i>Electrical Characteristics: ADC3221, ADC3222</i> .....	8
• Changed the condition statement for <i>Electrical Characteristics: ADC3223, ADC3224</i> .....	8
• Changed the condition statement for <i>Electrical Characteristics: ADC3221</i> .....	9
• Changed the condition statement for <i>Electrical Characteristics: ADC3222</i> .....	12
• Changed the condition statement for <i>Electrical Characteristics: ADC3223</i> .....	15
• Changed the condition statement for <i>Electrical Characteristics: ADC3224</i> .....	17
• Added Differential swing to <i>DIGITAL INPUTS (SYSREFP, SYSREFM)</i> .....	19
• Deleted $V_{IH}$ and $V_{IL}$ from <i>DIGITAL INPUTS (SYSREFP, SYSREFM)</i> .....	19
• added table note: SYSREF is internally biased to 0.9 V.to <i>Digital Characteristics</i> .....	19
• Added Graphs: Histogram, Integral Nonlinearity, and Differential Nonlinearity .....	21
• Added Graphs: Histogram, Integral Nonlinearity, and Differential Nonlinearity .....	26
• Added Graphs: Histogram, Integral Nonlinearity, and Differential Nonlinearity .....	32
• Added Graphs: Histogram, Integral Nonlinearity, and Differential Nonlinearity .....	37
• Changed the <i>Overview</i> section.....	46
• Added <i>Using the SYSREF Input</i> section.....	49
• Changed the <i>Register Initialization through SPI</i> section.....	56
• Changed the <i>Detailed Design Procedure</i> section.....	69

---

**Changes from Revision A (March 2015) to Revision B (March 2016) Page**

• Added <i>Digital Inputs</i> section to Digital Characteristics table.....	19
• Updated <a href="#">图 6-19</a> , <a href="#">图 6-20</a> , <a href="#">图 6-23</a> , <a href="#">图 6-24</a> , <a href="#">图 6-25</a> and, <a href="#">图 6-26</a> .....	21
• Updated <a href="#">图 6-50</a> , <a href="#">图 6-53</a> , <a href="#">图 6-54</a> , <a href="#">图 6-55</a> , and <a href="#">图 6-56</a> .....	26
• Updated <a href="#">图 6-79</a> , <a href="#">图 6-80</a> , <a href="#">图 6-83</a> , <a href="#">图 6-84</a> , <a href="#">图 6-85</a> , and <a href="#">图 6-86</a> .....	32
• Updated <a href="#">图 6-109</a> , <a href="#">图 6-110</a> , <a href="#">图 6-113</a> , <a href="#">图 6-114</a> , <a href="#">图 6-115</a> , and <a href="#">图 6-116</a> .....	37
• Changed conditions of <a href="#">图 6-122</a> and <a href="#">图 6-124</a> .....	42
• Changed <a href="#">图 7-2</a> .....	44
• Changed <i>SNR and Clock Jitter</i> section: changed typical thermal noise value in description of and changed <a href="#">图 8-7</a> to reflect updated thermal noise value .....	49
• Changed <a href="#">表 8-1</a> .....	50
• Changed <i>Lane</i> to <i>Wire</i> in <a href="#">图 8-8</a> .....	51
• Changed <i>Register Map Summary</i> table: changed <i>FLIP BITS</i> to <i>FLIP WIRE</i> in register 04h, changed bit 7 in register 70Ah, and added register 13h.....	57
• Changed <i>Summary of Special Mode Registers</i> section: changed title, moved section to correct location.....	58
• Changed <i>lane</i> to <i>wire</i> in register 03h description .....	58
• Changed register 04h: changed <i>FLIP BITS</i> to <i>FLIP WIRE</i> and changed description of bit 0.....	59
• Changed register 0Ah and 0Bh descriptions.....	61
• Added register 13h.....	62
• Changed register 70Ah to include the DIS CLK FILT register bit.....	67

---

**Changes from Revision \* (July 2014) to Revision A (March 2015) Page**

• 已发布为“量产数据” .....	1
--------------------	---

## Device Comparison Table

INTERFACE	RESOLUTION (Bits)	25 MSPS	50 MSPS	80 MSPS	125 MSPS	160 MSPS
Serial LVDS	12	ADC3221	ADC3222	ADC3223	ADC3224	—
	14	ADC3241	ADC3242	ADC3243	ADC3244	—
JESD204B	12	—	ADC32J22	ADC32J23	ADC32J24	ADC32J2x5
	14	—	ADC32J42	ADC32J43	ADC32J44	ADC32J45

## 5 Pin Configuration and Functions

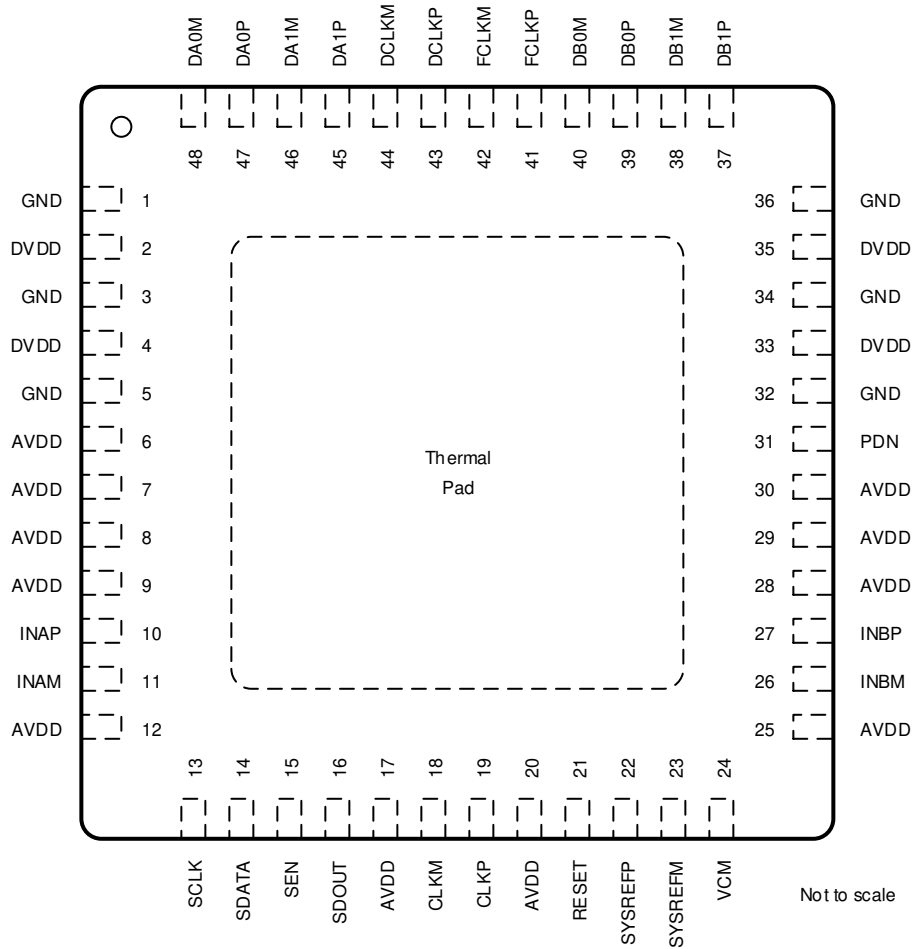

**5-1. RGZ Package, 48-Pin VQFN (Top View)**

**表 5-1. Pin Functions**

PIN		I/O	DESCRIPTION
NAME	NO.		
AVDD	6, 7, 8, 9, 12, 17, 20, 25, 28, 29, 30	I	Analog 1.8-V power supply, decoupled with capacitors.
CLKM	18	I	Negative differential clock input for the ADC
CLKP	19	I	Positive differential clock input for the ADC
DA0M	48	O	Negative serial LVDS output for channel A0
DA0P	47	O	Positive serial LVDS output for channel A0

**表 5-1. Pin Functions (continued)**

PIN		I/O	DESCRIPTION
NAME	NO.		
DA1M	46	O	Negative serial LVDS output for channel A1
DA1P	45	O	Positive serial LVDS output for channel A1
DB0M	40	O	Negative serial LVDS output for channel B0
DB0P	39	O	Positive serial LVDS output for channel B0
DB1M	38	O	Negative serial LVDS output for channel B1
DB1P	37	O	Positive serial LVDS output for channel B1
DCLKM	44	O	Negative bit clock output
DCLKP	43	O	Positive bit clock output
DVDD	2, 4, 33, 35	I	Digital 1.8-V power supply, decoupled with capacitors.
FCLKM	42	O	Negative frame clock output
FCLKP	41	O	Positive frame clock output
GND	1, 3, 5, 32, 34, 36	I	Ground, 0 V. Connect to the printed circuit board (PCB) ground plane. PowerPAD™
INAM	11	I	Negative differential analog input for channel A
INAP	10	I	Positive differential analog input for channel A
INBM	26	I	Negative differential analog input for channel B
INBP	27	I	Positive differential analog input for channel B
PDN	31	I	Power-down control; active high. This pin may be configured through the SPI. This pin has an internal 150-k $\Omega$ pull-down resistor.
RESET	21	I	Hardware reset; active high. This pin has an internal 150-k $\Omega$ pull-down resistor.
SCLK	13	I	Serial interface clock input. This pin has an internal 150-k $\Omega$ pull-down resistor.
SDATA	14	I	Serial interface data input. This pin has an internal 150-k $\Omega$ pull-down resistor.
SDOUT	16	O	Serial interface data output
SEN	15	I	Serial interface enable; active low. This pin has an internal 150-k $\Omega$ pull-up resistor to AVDD.
SYSREFM	23	I	Negative external SYSREF input
SYSREFP	22	I	Positive external SYSREF input
VCM	24	O	Common-mode voltage for analog inputs

## 6 Specifications

### 6.1 Absolute Maximum Ratings

over operating free-air temperature range (unless otherwise noted)<sup>(1)</sup>

		MIN	MAX	UNIT
Analog supply voltage range, AVDD		- 0.3	2.1	V
Digital supply voltage range, DVDD		- 0.3	2.1	V
Voltage applied to input pins	INAP, INBP, INAM, INBM	- 0.3	min (1.9, AVDD + 0.3)	V
	CLKP, CLKM	- 0.3	AVDD + 0.3	
	SYSREFP, SYSREFM	- 0.3	AVDD + 0.3	
	SCLK, SEN, SDATA, RESET, PDN	- 0.3	3.9	
Temperature	Operating free-air, T <sub>A</sub>	- 40	85	°C
	Operating junction, T <sub>J</sub>		125	
	Storage, T <sub>stg</sub>	- 65	150	

- (1) Stresses beyond those listed under *Absolute Maximum Ratings* may cause permanent damage to the device. These are stress ratings only, which do not imply functional operation of the device at these or any other conditions beyond those indicated under *Recommended Operating Conditions*. Exposure to absolute-maximum-rated conditions for extended periods may affect device reliability.

### 6.2 ESD Ratings

			VALUE	UNIT
V <sub>(ESD)</sub>	Electrostatic discharge	Human body model (HBM), per ANSI/ESDA/JEDEC JS-001 <sup>(1)</sup>	±2000	V

- (1) JEDEC document JEP155 states that 500-V HBM allows safe manufacturing with a standard ESD control process.

### 6.3 Recommended Operating Conditions<sup>(2)</sup>

over operating free-air temperature range (unless otherwise noted)

		MIN	NOM	MAX	UNIT
<b>SUPPLIES</b>					
AVDD	Analog supply voltage range	1.7	1.8	1.9	V
DVDD	Digital supply voltage range	1.7	1.8	1.9	V
<b>ANALOG INPUT</b>					
V <sub>ID</sub>	Differential input voltage	For input frequencies < 450 MHz		2	V <sub>PP</sub>
		For input frequencies < 600 MHz		1	
V <sub>IC</sub>	Input common-mode voltage	VCM ± 0.025			V
<b>CLOCK INPUT</b>					
Input clock frequency		Sampling clock frequency		15 <sup>(3)</sup>	125 <sup>(1)</sup>
Input clock amplitude (differential)	Sine wave, ac-coupled		0.2	1.5	V <sub>PP</sub>
	LVPECL, ac-coupled		1.6		
	LVDS, ac-coupled		0.7		
Input clock duty cycle		35%	50%	65%	
Input clock common-mode voltage		0.95			V
<b>DIGITAL OUTPUTS</b>					
C <sub>LOAD</sub>	Maximum external load capacitance from each output pin to GND		3.3		pF
R <sub>LOAD</sub>	Differential load resistance placed externally		100		Ω

- (1) With the clock divider enabled by default for divide-by-1. Maximum sampling clock frequency for the divide-by-4 option is 500 MSPS.  
 (2) To reset the device for the first time after power-up, only use the RESET pin; see the [§ 8.5.1.1](#) section.  
 (3) See [表 8-1](#) for details.

## 6.4 Thermal Information

THERMAL METRIC <sup>(1)</sup>		ADC322x	UNIT
		RGZ (VQFN)	
		48 PINS	
$R_{\theta JA}$	Junction-to-ambient thermal resistance	25.7	°C/W
$R_{\theta JC(top)}$	Junction-to-case (top) thermal resistance	18.9	°C/W
$R_{\theta JB}$	Junction-to-board thermal resistance	3.0	°C/W
$\psi_{JT}$	Junction-to-top characterization parameter	0.2	°C/W
$\psi_{JB}$	Junction-to-board characterization parameter	3	°C/W
$R_{\theta JC(bot)}$	Junction-to-case (bottom) thermal resistance	0.5	°C/W

(1) For more information about traditional and new thermal metrics, see the [Semiconductor and IC Package Thermal Metrics](#) application report.

## 6.5 Electrical Characteristics: General

At maximum sampling rate, 50% clock duty cycle, AVDD = DVDD = 1.8 V, and -1-dBFS differential input. Typical values are specified at an ambient temperature of 25°C. Minimum and maximum values are specified over an ambient temperature range of -40°C to +85°C (unless otherwise noted).

PARAMETER	TEST CONDITIONS	MIN	TYP	MAX	UNIT
<b>RESOLUTION</b>					
Resolution		12			Bits
<b>ANALOG INPUT</b>					
Differential input full-scale			2.0		V <sub>PP</sub>
R <sub>IN</sub>	Input resistance	Differential at dc	6.6		kΩ
C <sub>IN</sub>	Input capacitance	Differential at dc	3.7		pF
V <sub>OC(VCM)</sub>	VCM common-mode voltage output	0.8	0.95	1.1	V
	VCM output current capability		10		mA
	Input common-mode current	Per analog input pin	1.5		μA/MSPS
	Analog input bandwidth (3 dB)	50-Ω differential source driving 50-Ω termination across INP and INM	540		MHz
<b>DC ACCURACY</b>					
E <sub>O</sub>	Offset error	-25		25	mV
<sup>α</sup> E <sub>O</sub>	Temperature coefficient of offset error		±0.024		mV/°C
E <sub>G(REF)</sub>	E_G Overall dc gain error of a channel	-2%		2%	
<sup>α</sup> (E <sub>GCHAN</sub> )	Temperature coefficient of overall gain error		±0.008		Δ%FS/°C
<b>CHANNEL-TO-CHANNEL ISOLATION</b>					
Crosstalk <sup>(1)</sup>	f <sub>IN</sub> = 10 MHz		105		dB
	f <sub>IN</sub> = 100 MHz		105		
	f <sub>IN</sub> = 200 MHz		105		
	f <sub>IN</sub> = 230 MHz		105		
	f <sub>IN</sub> = 300 MHz		105		

(1) Crosstalk is measured with a -1-dBFS input signal on one channel and no input on the other channel.

### 6.6 Electrical Characteristics: ADC3221, ADC3222

At maximum sampling rate, 50% clock duty cycle, AVDD = DVDD = 1.8 V, and -1-dBFS differential input. Typical values are specified at an ambient temperature of 25°C. Minimum and maximum values are specified over an ambient temperature range of -40°C to +85°C (unless otherwise noted).

PARAMETER	ADC3221			ADC3222			UNIT
	MIN	TYP	MAX	MIN	TYP	MAX	
ADC clock frequency			25			50	MSPS
1.8-V analog supply current		31	71		39	81	mA
1.8-V digital supply current		35	65		43	75	mA
Total power dissipation		118	205		147	245	mW
Global power-down dissipation		5	17		5	17	mW
Standby power-down dissipation		78	103		78	103	mW

### 6.7 Electrical Characteristics: ADC3223, ADC3224

At maximum sampling rate, 50% clock duty cycle, AVDD = DVDD = 1.8 V, and -1-dBFS differential input. Typical values are specified at an ambient temperature of 25°C. Minimum and maximum values are specified over an ambient temperature range of -40°C to +85°C (unless otherwise noted).

PARAMETER	ADC3223			ADC3224			UNIT
	MIN	TYP	MAX	MIN	TYP	MAX	
ADC clock frequency			80			125	MSPS
1.8-V analog supply current		50	91		65	106	mA
1.8-V digital supply current		52	85		64	95	mA
Total power dissipation		183	285		233	325	mW
Global power-down dissipation		5	17		5	17	mW
Standby power-down dissipation		72	103		78	103	mW



## 6.8 AC Performance: ADC3221

At maximum sampling rate, 50% clock duty cycle, AVDD = DVDD = 1.8 V, and -1-dBFS differential input. Typical values are specified at an ambient temperature of 25°C. Minimum and maximum values are specified over an ambient temperature range of -40°C to +85°C (unless otherwise noted).

PARAMETER		TEST CONDITIONS	ADC3221 (f <sub>S</sub> = 25 MSPS)						UNIT
			DITHER ON			DITHER OFF			
			MIN	TYP	MAX	MIN	TYP	MAX	
<b>DYNAMIC AC CHARACTERISTICS</b>									
SNR	Signal-to-noise ratio (from 1-MHz offset)	f <sub>IN</sub> = 10 MHz	70.9			71.2			dBFS
		f <sub>IN</sub> = 20 MHz	68.5	70.8		71.1			
		f <sub>IN</sub> = 70 MHz	70.6			70.9			
		f <sub>IN</sub> = 100 MHz	70.3			70.6			
		f <sub>IN</sub> = 170 MHz	69.7			69.9			
		f <sub>IN</sub> = 230 MHz	68.8			69			
	Signal-to-noise ratio (full Nyquist band)	f <sub>IN</sub> = 10 MHz	70.2			70.6			dBFS
		f <sub>IN</sub> = 20 MHz	70.2			70.5			
		f <sub>IN</sub> = 70 MHz	69.9			70.2			
		f <sub>IN</sub> = 100 MHz	69.6			69.9			
		f <sub>IN</sub> = 170 MHz	69.2			69.3			
		f <sub>IN</sub> = 230 MHz	68.2			68.4			
NSD <sup>(1)</sup>	Noise spectral density (averaged across Nyquist zone)	f <sub>IN</sub> = 10 MHz	141.9			142.2			dBFS/Hz
		f <sub>IN</sub> = 20 MHz	141.8	139.5		142.1			
		f <sub>IN</sub> = 70 MHz	141.6			141.9			
		f <sub>IN</sub> = 100 MHz	141.3			141.6			
		f <sub>IN</sub> = 170 MHz	140.7			140.9			
		f <sub>IN</sub> = 230 MHz	139.8			140.0			
SINAD <sup>(1)</sup>	Signal-to-noise and distortion ratio	f <sub>IN</sub> = 10 MHz	70.9			71.1			dBFS
		f <sub>IN</sub> = 20 MHz	68.1	70.8		71			
		f <sub>IN</sub> = 70 MHz	70.6			70.7			
		f <sub>IN</sub> = 100 MHz	70.2			70.3			
		f <sub>IN</sub> = 170 MHz	69.6			69.6			
		f <sub>IN</sub> = 230 MHz	68.5			68.5			
ENOB <sup>(1)</sup>	Effective number of bits	f <sub>IN</sub> = 10 MHz	11.5			11.5			Bits
		f <sub>IN</sub> = 20 MHz	11	11.5		11.5			
		f <sub>IN</sub> = 70 MHz	11.4			11.5			
		f <sub>IN</sub> = 100 MHz	11.4			11.4			
		f <sub>IN</sub> = 170 MHz	11.3			11.3			
		f <sub>IN</sub> = 230 MHz	11.1			11.1			

### 6.8 AC Performance: ADC3221 (continued)

At maximum sampling rate, 50% clock duty cycle, AVDD = DVDD = 1.8 V, and -1-dBFS differential input. Typical values are specified at an ambient temperature of 25°C. Minimum and maximum values are specified over an ambient temperature range of -40°C to +85°C (unless otherwise noted).

PARAMETER	TEST CONDITIONS	ADC3221 (f <sub>S</sub> = 25 MSPS)						UNIT
		DITHER ON			DITHER OFF			
		MIN	TYP	MAX	MIN	TYP	MAX	
SFDR Spurious-free dynamic range	f <sub>IN</sub> = 10 MHz		96			88	dBc	
	f <sub>IN</sub> = 20 MHz	82	93			89		
	f <sub>IN</sub> = 70 MHz		93			87		
	f <sub>IN</sub> = 100 MHz		85			82		
	f <sub>IN</sub> = 170 MHz		86			83		
	f <sub>IN</sub> = 230 MHz		81			80		

## 6.8 AC Performance: ADC3221 (continued)

At maximum sampling rate, 50% clock duty cycle, AVDD = DVDD = 1.8 V, and -1-dBFS differential input. Typical values are specified at an ambient temperature of 25°C. Minimum and maximum values are specified over an ambient temperature range of -40°C to +85°C (unless otherwise noted).

PARAMETER	TEST CONDITIONS	ADC3221 (f <sub>S</sub> = 25 MSPS)						UNIT
		DITHER ON			DITHER OFF			
		MIN	TYP	MAX	MIN	TYP	MAX	
HD2 Second-order harmonic distortion	f <sub>IN</sub> = 10 MHz		106			97	dBc	
	f <sub>IN</sub> = 20 MHz	82	102			95		
	f <sub>IN</sub> = 70 MHz		101			95		
	f <sub>IN</sub> = 100 MHz		95			93		
	f <sub>IN</sub> = 170 MHz		88			87		
	f <sub>IN</sub> = 230 MHz		81			81		
HD3 Third-order harmonic distortion	f <sub>IN</sub> = 10 MHz		96			88	dBc	
	f <sub>IN</sub> = 20 MHz	82	93			92		
	f <sub>IN</sub> = 70 MHz		93			87		
	f <sub>IN</sub> = 100 MHz		85			82		
	f <sub>IN</sub> = 170 MHz		87			83		
	f <sub>IN</sub> = 230 MHz		82			80		
Non HD2, HD3 Spurious-free dynamic range (excluding HD2, HD3)	f <sub>IN</sub> = 10 MHz		99			92	dBc	
	f <sub>IN</sub> = 20 MHz	87	101			91		
	f <sub>IN</sub> = 70 MHz		99			93		
	f <sub>IN</sub> = 100 MHz		98			92		
	f <sub>IN</sub> = 170 MHz		99			92		
	f <sub>IN</sub> = 230 MHz		97			93		
THD Total harmonic distortion	f <sub>IN</sub> = 10 MHz		94			85	dBc	
	f <sub>IN</sub> = 20 MHz	80	92			85		
	f <sub>IN</sub> = 70 MHz		91			85		
	f <sub>IN</sub> = 100 MHz		86			82		
	f <sub>IN</sub> = 170 MHz		84			81		
	f <sub>IN</sub> = 230 MHz		78			77		
IMD3 Two-tone, third-order intermodulation distortion	f <sub>IN1</sub> = 45 MHz, f <sub>IN2</sub> = 50 MHz		-95			-94	dBFS	
	f <sub>IN1</sub> = 185 MHz, f <sub>IN2</sub> = 190 MHz		-90			-89		

(1) Reported from a 1-MHz offset.

## 6.9 AC Performance: ADC3222

At maximum sampling rate, 50% clock duty cycle, AVDD = DVDD = 1.8 V, and -1-dBFS differential input. Typical values are specified at an ambient temperature of 25°C. Minimum and maximum values are specified over an ambient temperature range of -40°C to +85°C (unless otherwise noted).

PARAMETER		TEST CONDITIONS	ADC3222 (f <sub>S</sub> = 50 MSPS)						UNIT
			DITHER ON			DITHER OFF			
			MIN	TYP	MAX	MIN	TYP	MAX	
<b>DYNAMIC AC CHARACTERISTICS</b>									
SNR	Signal-to-noise ratio (from 1-MHz offset)	f <sub>IN</sub> = 10 MHz	70.9			71.1			dBFS
		f <sub>IN</sub> = 20 MHz	68.5	70.9		71.1			
		f <sub>IN</sub> = 70 MHz	70.7			70.9			
		f <sub>IN</sub> = 100 MHz	70.5			70.7			
		f <sub>IN</sub> = 170 MHz	70			70.1			
		f <sub>IN</sub> = 230 MHz	69.3			69.6			
	Signal-to-noise ratio (full Nyquist band)	f <sub>IN</sub> = 10 MHz	70.3			70.5			
		f <sub>IN</sub> = 20 MHz	70.1			70.3			
		f <sub>IN</sub> = 70 MHz	70.1			70.3			
		f <sub>IN</sub> = 100 MHz	69.9			70.2			
		f <sub>IN</sub> = 170 MHz	69.5			69.5			
		f <sub>IN</sub> = 230 MHz	68.7			69			
NSD <sup>(1)</sup>	Noise spectral density (averaged across Nyquist zone)	f <sub>IN</sub> = 10 MHz	144.9			145.1			dBFS/Hz
		f <sub>IN</sub> = 20 MHz	144.9	142.5		145.1			
		f <sub>IN</sub> = 70 MHz	144.7			144.9			
		f <sub>IN</sub> = 100 MHz	144.5			144.7			
		f <sub>IN</sub> = 170 MHz	144.0			144.1			
		f <sub>IN</sub> = 230 MHz	143.3			143.6			
SINAD <sup>(1)</sup>	Signal-to-noise and distortion ratio	f <sub>IN</sub> = 10 MHz	70.8			71			dBFS
		f <sub>IN</sub> = 20 MHz	68	70.8		71			
		f <sub>IN</sub> = 70 MHz	70.6			70.8			
		f <sub>IN</sub> = 100 MHz	70.4			70.6			
		f <sub>IN</sub> = 170 MHz	69.8			69.9			
		f <sub>IN</sub> = 230 MHz	69			69.1			
ENOB <sup>(1)</sup>	Effective number of bits	f <sub>IN</sub> = 10 MHz	11.5			11.5			Bits
		f <sub>IN</sub> = 20 MHz	11	11.5		11.5			
		f <sub>IN</sub> = 70 MHz	11.4			11.5			
		f <sub>IN</sub> = 100 MHz	11.4			11.4			
		f <sub>IN</sub> = 170 MHz	11.3			11.3			
		f <sub>IN</sub> = 230 MHz	11.2			11.2			

## 6.9 AC Performance: ADC3222 (continued)

At maximum sampling rate, 50% clock duty cycle, AVDD = DVDD = 1.8 V, and -1-dBFS differential input. Typical values are specified at an ambient temperature of 25°C. Minimum and maximum values are specified over an ambient temperature range of -40°C to +85°C (unless otherwise noted).

PARAMETER	TEST CONDITIONS	ADC3222 ( $f_S = 50$ MSPS)						UNIT	
		DITHER ON			DITHER OFF				
		MIN	TYP	MAX	MIN	TYP	MAX		
SFDR	Spurious-free dynamic range	$f_{IN} = 10$ MHz	89			95			dBc
		$f_{IN} = 20$ MHz	82	95		91			
		$f_{IN} = 70$ MHz	95			93			
		$f_{IN} = 100$ MHz	88			86			
		$f_{IN} = 170$ MHz	85			83			
		$f_{IN} = 230$ MHz	82			81			

### 6.9 AC Performance: ADC3222 (continued)

At maximum sampling rate, 50% clock duty cycle, AVDD = DVDD = 1.8 V, and -1-dBFS differential input. Typical values are specified at an ambient temperature of 25°C. Minimum and maximum values are specified over an ambient temperature range of -40°C to +85°C (unless otherwise noted).

PARAMETER	TEST CONDITIONS	ADC3222 (f <sub>S</sub> = 50 MSPS)						UNIT
		DITHER ON			DITHER OFF			
		MIN	TYP	MAX	MIN	TYP	MAX	
HD2 Second-order harmonic distortion	f <sub>IN</sub> = 10 MHz		103			97	dBc	
	f <sub>IN</sub> = 20 MHz	82	100			94		
	f <sub>IN</sub> = 70 MHz		97			94		
	f <sub>IN</sub> = 100 MHz		94			93		
	f <sub>IN</sub> = 170 MHz		89			89		
	f <sub>IN</sub> = 230 MHz		83			83		
HD3 Third-order harmonic distortion	f <sub>IN</sub> = 10 MHz		89			96	dBc	
	f <sub>IN</sub> = 20 MHz	82	94			95		
	f <sub>IN</sub> = 70 MHz		95			93		
	f <sub>IN</sub> = 100 MHz		88			86		
	f <sub>IN</sub> = 170 MHz		85			83		
	f <sub>IN</sub> = 230 MHz		83			81		
Non HD2, HD3 Spurious-free dynamic range (excluding HD2, HD3)	f <sub>IN</sub> = 10 MHz		99			95	dBc	
	f <sub>IN</sub> = 20 MHz	87	101			93		
	f <sub>IN</sub> = 70 MHz		99			94		
	f <sub>IN</sub> = 100 MHz		100			94		
	f <sub>IN</sub> = 170 MHz		99			93		
	f <sub>IN</sub> = 230 MHz		97			93		
THD Total harmonic distortion	f <sub>IN</sub> = 10 MHz		89			89	dBc	
	f <sub>IN</sub> = 20 MHz	80	93			87		
	f <sub>IN</sub> = 70 MHz		92			88		
	f <sub>IN</sub> = 100 MHz		90			86		
	f <sub>IN</sub> = 170 MHz		83			81		
	f <sub>IN</sub> = 230 MHz		80			78		
IMD3 Two-tone, third-order intermodulation distortion	f <sub>IN1</sub> = 45 MHz, f <sub>IN2</sub> = 50 MHz		-95			-92	dBFS	
	f <sub>IN1</sub> = 185 MHz, f <sub>IN2</sub> = 190 MHz		-92			-92		

(1) Reported from a 1-MHz offset.

## 6.10 AC Performance: ADC3223

At maximum sampling rate, 50% clock duty cycle, AVDD = DVDD = 1.8 V, and -1-dBFS differential input. Typical values are specified at an ambient temperature of 25°C. Minimum and maximum values are specified over an ambient temperature range of -40°C to +85°C (unless otherwise noted).

PARAMETER		TEST CONDITIONS	ADC3223 (f <sub>S</sub> = 80 MSPS)						UNIT
			DITHER ON			DITHER OFF			
			MIN	TYP	MAX	MIN	TYP	MAX	
<b>DYNAMIC AC CHARACTERISTICS</b>									
SNR	Signal-to-noise ratio (from 1-MHz offset)	f <sub>IN</sub> = 10 MHz	70.7			70.9			dBFS
		f <sub>IN</sub> = 70 MHz	68.5	70.6		70.8			
		f <sub>IN</sub> = 100 MHz	70.5			70.7			
		f <sub>IN</sub> = 170 MHz	70.1			70.3			
		f <sub>IN</sub> = 230 MHz	69.7			69.9			
	Signal-to-noise ratio (full Nyquist band)	f <sub>IN</sub> = 10 MHz	70.3			70.5			
		f <sub>IN</sub> = 70 MHz	70.2			70.5			
		f <sub>IN</sub> = 100 MHz	70.1			70.4			
		f <sub>IN</sub> = 170 MHz	69.7			69.9			
		f <sub>IN</sub> = 230 MHz	69.4			69.6			
NSD <sup>(1)</sup>	Noise spectral density (averaged across Nyquist zone)	f <sub>IN</sub> = 10 MHz	-			-			dBFS/Hz
		f <sub>IN</sub> = 70 MHz	146.6	-	144.5	-			
		f <sub>IN</sub> = 100 MHz	146.5			146.7			
		f <sub>IN</sub> = 170 MHz	146.1			146.3			
		f <sub>IN</sub> = 230 MHz	145.7			145.9			
SINAD <sup>(1)</sup>	Signal-to-noise and distortion ratio	f <sub>IN</sub> = 10 MHz	70.7			70.9			dBFS
		f <sub>IN</sub> = 70 MHz	68.1	70.6		70.8			
		f <sub>IN</sub> = 100 MHz	70.5			70.6			
		f <sub>IN</sub> = 170 MHz	70			70.2			
		f <sub>IN</sub> = 230 MHz	69.5			69.6			
ENOB <sup>(1)</sup>	Effective number of bits	f <sub>IN</sub> = 10 MHz	11.4			11.5			Bits
		f <sub>IN</sub> = 70 MHz	11.02	11.4		11.5			
		f <sub>IN</sub> = 100 MHz	11.4			11.4			
		f <sub>IN</sub> = 170 MHz	11.3			11.4			
		f <sub>IN</sub> = 230 MHz	11.3			11.3			
SFDR	Spurious-free dynamic range	f <sub>IN</sub> = 10 MHz	88			95			dBc
		f <sub>IN</sub> = 70 MHz	82	94		93			
		f <sub>IN</sub> = 100 MHz	93			92			
		f <sub>IN</sub> = 170 MHz	88			87			
		f <sub>IN</sub> = 230 MHz	85			84			

### 6.10 AC Performance: ADC3223 (continued)

At maximum sampling rate, 50% clock duty cycle, AVDD = DVDD = 1.8 V, and -1-dBFS differential input. Typical values are specified at an ambient temperature of 25°C. Minimum and maximum values are specified over an ambient temperature range of -40°C to +85°C (unless otherwise noted).

PARAMETER	TEST CONDITIONS	ADC3223 (f <sub>S</sub> = 80 MSPS)						UNIT
		DITHER ON			DITHER OFF			
		MIN	TYP	MAX	MIN	TYP	MAX	
HD2	Second-order harmonic distortion	f <sub>IN</sub> = 10 MHz		104			99	dBc
		f <sub>IN</sub> = 70 MHz	82	95		94		
		f <sub>IN</sub> = 100 MHz		95		93		
		f <sub>IN</sub> = 170 MHz		88		87		
		f <sub>IN</sub> = 230 MHz		85		85		
HD3	Third-order harmonic distortion	f <sub>IN</sub> = 10 MHz		89		95	dBc	
		f <sub>IN</sub> = 70 MHz	82	94		94		
		f <sub>IN</sub> = 100 MHz		95		96		
		f <sub>IN</sub> = 170 MHz		93		90		
		f <sub>IN</sub> = 230 MHz		89		85		
Non HD2, HD3	Spurious-free dynamic range (excluding HD2, HD3)	f <sub>IN</sub> = 10 MHz		94		93	dBc	
		f <sub>IN</sub> = 70 MHz	87	100		95		
		f <sub>IN</sub> = 100 MHz		99		96		
		f <sub>IN</sub> = 170 MHz		99		95		
		f <sub>IN</sub> = 230 MHz		98		95		
THD	Total harmonic distortion	f <sub>IN</sub> = 10 MHz		88		91	dBc	
		f <sub>IN</sub> = 70 MHz	79.5	91		89		
		f <sub>IN</sub> = 100 MHz		91		88		
		f <sub>IN</sub> = 170 MHz		86		84		
		f <sub>IN</sub> = 230 MHz		83		81		
IMD3	Two-tone, third-order intermodulation distortion	f <sub>IN1</sub> = 45 MHz, f <sub>IN2</sub> = 50 MHz		-94		-94	dBFS	
		f <sub>IN1</sub> = 185 MHz, f <sub>IN2</sub> = 190 MHz		-92		-90		

(1) Reported from a 1-MHz offset.



## 6.11 AC Performance: ADC3224

At maximum sampling rate, 50% clock duty cycle, AVDD = DVDD = 1.8 V, and -1-dBFS differential input. Typical values are specified at an ambient temperature of 25°C. Minimum and maximum values are specified over an ambient temperature range of -40°C to +85°C (unless otherwise noted).

PARAMETER		TEST CONDITIONS	ADC3224 (f <sub>S</sub> = 125 MSPS)						UNIT
			DITHER ON			DITHER OFF			
			MIN	TYP	MAX	MIN	TYP	MAX	
<b>DYNAMIC AC CHARACTERISTICS</b>									
SNR	Signal-to-noise ratio (from 1-MHz offset)	f <sub>IN</sub> = 10 MHz	70.5			70.8			dBFS
		f <sub>IN</sub> = 70 MHz	68.5	70.4		70.7			
		f <sub>IN</sub> = 100 MHz	70.3			70.6			
		f <sub>IN</sub> = 170 MHz	69.9			70.2			
		f <sub>IN</sub> = 230 MHz	69.4			69.8			
	Signal-to-noise ratio (full Nyquist band)	f <sub>IN</sub> = 10 MHz	70.3			70.6			
		f <sub>IN</sub> = 70 MHz	70.2			70.5			
		f <sub>IN</sub> = 100 MHz	70.2			70.4			
		f <sub>IN</sub> = 170 MHz	69.7			70.0			
		f <sub>IN</sub> = 230 MHz	69.2			69.6			
NSD <sup>(1)</sup>	Noise spectral density (averaged across Nyquist zone)	f <sub>IN</sub> = 10 MHz	-			-			dBFS/Hz
		f <sub>IN</sub> = 70 MHz	148.4	-	146.5	-			
		f <sub>IN</sub> = 100 MHz	148.3			148.6			
		f <sub>IN</sub> = 170 MHz	147.9			148.2			
		f <sub>IN</sub> = 230 MHz	147.4			147.8			
SINAD <sup>(1)</sup>	Signal-to-noise and distortion ratio	f <sub>IN</sub> = 10 MHz	70.5			70.6			dBFS
		f <sub>IN</sub> = 70 MHz	68	70.4		70.6			
		f <sub>IN</sub> = 100 MHz	70.2			70.3			
		f <sub>IN</sub> = 170 MHz	69.7			69.9			
		f <sub>IN</sub> = 230 MHz	69.2			69.5			
ENOB <sup>(1)</sup>	Effective number of bits	f <sub>IN</sub> = 10 MHz	11.4			11.4			Bits
		f <sub>IN</sub> = 70 MHz	11	11.4		11.4			
		f <sub>IN</sub> = 100 MHz	11.4			11.4			
		f <sub>IN</sub> = 170 MHz	11.3			11.3			
		f <sub>IN</sub> = 230 MHz	11.2			11.2			
SFDR	Spurious-free dynamic range	f <sub>IN</sub> = 10 MHz	93			87			dBc
		f <sub>IN</sub> = 70 MHz	82	95		89			
		f <sub>IN</sub> = 100 MHz	89			86			
		f <sub>IN</sub> = 170 MHz	86			85			
		f <sub>IN</sub> = 230 MHz	83			83			

### 6.11 AC Performance: ADC3224 (continued)

At maximum sampling rate, 50% clock duty cycle, AVDD = DVDD = 1.8 V, and -1-dBFS differential input. Typical values are specified at an ambient temperature of 25°C. Minimum and maximum values are specified over an ambient temperature range of -40°C to +85°C (unless otherwise noted).

PARAMETER	TEST CONDITIONS	ADC3224 (f <sub>s</sub> = 125 MSPS)						UNIT
		DITHER ON			DITHER OFF			
		MIN	TYP	MAX	MIN	TYP	MAX	
HD2	Second-order harmonic distortion	f <sub>IN</sub> = 10 MHz		96			96	dBc
		f <sub>IN</sub> = 70 MHz	84	96			96	
		f <sub>IN</sub> = 100 MHz		91			91	
		f <sub>IN</sub> = 170 MHz		86			85	
		f <sub>IN</sub> = 230 MHz		83			83	
HD3	Third-order harmonic distortion	f <sub>IN</sub> = 10 MHz		94			87	dBc
		f <sub>IN</sub> = 70 MHz	82	95			89	
		f <sub>IN</sub> = 100 MHz		91			86	
		f <sub>IN</sub> = 170 MHz		96			89	
		f <sub>IN</sub> = 230 MHz		88			85	
Non HD2, HD3	Spurious-free dynamic range (excluding HD2, HD3)	f <sub>IN</sub> = 10 MHz		99			96	dBc
		f <sub>IN</sub> = 70 MHz	87	99			95	
		f <sub>IN</sub> = 100 MHz		99			95	
		f <sub>IN</sub> = 170 MHz		99			92	
		f <sub>IN</sub> = 230 MHz		97			92	
THD	Total harmonic distortion	f <sub>IN</sub> = 10 MHz		91			85	dBc
		f <sub>IN</sub> = 70 MHz	80	91			86	
		f <sub>IN</sub> = 100 MHz		87			83	
		f <sub>IN</sub> = 170 MHz		85			82	
		f <sub>IN</sub> = 230 MHz		82			80	
IMD3	Two-tone, third-order intermodulation distortion	f <sub>IN1</sub> = 45 MHz, f <sub>IN2</sub> = 50 MHz		-96			-95	dBFS
		f <sub>IN1</sub> = 185 MHz, f <sub>IN2</sub> = 190 MHz		-92			-88	

(1) Reported from a 1-MHz offset.

## 6.12 Digital Characteristics

the dc specifications refer to the condition where the digital outputs are not switching, but are permanently at a valid logic level 0 or 1; AVDD = DVDD = 1.8 V, and -1-dBFS differential input (unless otherwise noted)

PARAMETER		TEST CONDITIONS	MIN	TYP	MAX	UNIT
<b>DIGITAL INPUTS (RESET, SCLK, SDATA, SEN, PDN)</b>						
V <sub>IH</sub>	High-level input voltage	All digital inputs support 1.8-V and 3.3-V CMOS logic levels	1.3			V
V <sub>IL</sub>	Low-level input voltage	All digital inputs support 1.8-V and 3.3-V CMOS logic levels			0.4	V
I <sub>IH</sub>	High-level input current	RESET, SDATA, SCLK, PDN	V <sub>HIGH</sub> = 1.8 V	10		μA
		SEN <sup>(1)</sup>	V <sub>HIGH</sub> = 1.8 V	0		
I <sub>IL</sub>	Low-level input current	RESET, SDATA, SCLK, PDN	V <sub>LOW</sub> = 0 V	0		μA
		SEN	V <sub>LOW</sub> = 0 V	10		
<b>DIGITAL INPUTS (SYSREFP, SYSREFM)</b>						
	Differential swing		0.2	0.8	1	V
	Common-mode voltage for SYSREF <sup>(2)</sup>			0.9		V
<b>DIGITAL OUTPUTS, CMOS INTERFACE (SDOUT)</b>						
V <sub>OH</sub>	High-level output voltage		DVDD - 0.1	DVDD		V
V <sub>OL</sub>	Low-level output voltage			0	0.1	V
<b>DIGITAL OUTPUTS, LVDS INTERFACE</b>						
V <sub>ODH</sub>	High-level output differential voltage	With an external 100-Ω termination	280	350	460	mV
V <sub>ODL</sub>	Low-level output differential voltage	With an external 100-Ω termination	-460	-350	-280	mV
V <sub>OCM</sub>	Output common-mode voltage			1.05		V

- (1) SEN has an internal 150-kΩ pull-up resistor to AVDD. SPI pins (SEN, SCLK, SDATA) can be driven by 1.8-V or 3.3-V CMOS buffers.  
(2) SYSREF is internally biased to 0.9 V.

## 6.13 Timing Requirements: General

typical values are at T<sub>A</sub> = 25°C, AVDD = DVDD = 1.8 V, and -1-dBFS differential input (unless otherwise noted); minimum and maximum values are across the full temperature range: T<sub>MIN</sub> = -40°C to T<sub>MAX</sub> = 85°C

			MIN	TYP	MAX	UNIT
t <sub>A</sub>	Aperture delay		1.24	1.44	1.64	ns
	Aperture delay matching between two channels of the same device			±70		
	Aperture delay variation between two devices at same temperature and supply voltage			±150		
t <sub>J</sub>	Aperture jitter			130		f <sub>S</sub> rms
Wake-up time	Time to valid data after exiting standby power-down mode			35	65	μs
	Time to valid data after exiting global power-down mode (in this mode, both channels power down)			85	140	
ADC latency <sup>(1)</sup>	2-wire mode (default)			9		Clock cycles
	1-wire mode			8		
t <sub>SU_SYSREF</sub>	SYSREF reference time	Setup time for SYSREF referenced to input clock rising edge	1000			ps
t <sub>H_SYSREF</sub>		Hold time for SYSREF referenced to input clock rising edge	100			

- (1) Overall latency = ADC latency + t<sub>PDI</sub> (see [Figure 7-4](#))

## 6.14 Timing Requirements: LVDS Output

typical values are at  $T_A = 25^\circ\text{C}$ ,  $AVDD = DVDD = 1.8\text{ V}$ , and - 1-dBFS differential input, 6x serialization (2-wire mode),  $C_{LOAD} = 3.3\text{ pF}$ <sup>(2)</sup>, and  $R_{LOAD} = 100\ \Omega$ <sup>(3)</sup> (unless otherwise noted); minimum and maximum values are across the full temperature range:  $T_{MIN} = -40^\circ\text{C}$  to  $T_{MAX} = 85^\circ\text{C}$ <sup>(4)</sup> (1)

		MIN	TYP	MAX	UNIT	
$t_{SU}$	Data setup time: data valid to zero-crossing of differential output clock (CLKOUTP - CLKOUTM) <sup>(5)</sup>	0.43	0.5		ns	
$t_{HO}$	Data hold time: zero-crossing of differential output clock (CLKOUTP - CLKOUTM) to data becoming invalid <sup>(5)</sup>	0.48	0.58		ns	
$t_{PDI}$	Clock propagation delay: input clock falling edge cross-over to frame clock rising edge cross-over (15 MSPS < sampling frequency < 125 MSPS)	1-wire mode	2.7	4.5	6.5	ns
		2-wire mode	$0.44 \times t_S + t_{DELAY}$			
$t_{DELAY}$	Delay time	3	4.5	5.9	ns	
	LVDS bit clock duty cycle: duty cycle of differential clock (CLKOUTP - CLKOUTM)	49%				
$t_{FALL}$ , $t_{RISE}$	Data fall time, data rise time: rise time measured from - 100 mV to 100 mV, 15 MSPS ≤ Sampling frequency ≤ 125 MSPS	0.11			ns	
$t_{CLKRISE}$ , $t_{CLKFALL}$	Output clock rise time, output clock fall time: rise time measured from - 100 mV to 100 mV, 10 MSPS ≤ Sampling frequency ≤ 125 MSPS	0.11			ns	

- (1) Timing parameters are specified by design and characterization and are not tested in production.
- (2)  $C_{LOAD}$  is the effective external single-ended load capacitance between each output pin and ground.
- (3)  $R_{LOAD}$  is the differential load resistance between the LVDS output pair.
- (4) Measurements are done with a transmission line of a 100- $\Omega$  characteristic impedance between the device and load. Setup and hold time specifications take into account the effect of jitter on the output data and clock.
- (5) Data valid refers to a logic high of 100 mV and a logic low of - 100 mV.

**表 6-1. LVDS Timing at Lower Sampling Frequencies: 6X Serialization (2-Wire Mode)**

SAMPLING FREQUENCY (MSPS)	SETUP TIME ( $t_{SU}$ , ns)			HOLD TIME ( $t_{HO}$ , ns)		
	MIN	TYP	MAX	MIN	TYP	MAX
25	2.61	3.06		2.75	3.12	
40	1.69	1.9		1.8	1.98	
60	1.11	1.23		1.18	1.31	
80	0.81	0.89		0.88	0.97	
100	0.6	0.68		0.68	0.77	

**表 6-2. LVDS Timings at Lower Sampling Frequencies: 12X Serialization (1-Wire Mode)**

SAMPLING FREQUENCY (MSPS)	SETUP TIME ( $t_{SU}$ , ns)			HOLD TIME ( $t_{HO}$ , ns)		
	MIN	TYP	MAX	MIN	TYP	MAX
25	1.3	1.48		1.32	1.57	
40	0.76	0.88		0.79	0.97	
50	0.57	0.68		0.61	0.77	
60	0.42	0.55		0.45	0.62	
70	0.35	0.44		0.4	0.51	
80	0.26	0.35		0.35	0.43	

## 6.15 Typical Characteristics: ADC3221

Typical values are at  $T_A = 25^\circ\text{C}$ , ADC sampling rate = 25 MSPS, 50% clock duty cycle, AVDD = 1.8 V, DVDD = 1.8 V, -1-dBFS differential input,  $2\text{-}V_{PP}$  full-scale, 32k-point FFT, chopper disabled, and SNR reported with a 1-MHz offset from dc when chopper is disabled and from  $f_S / 2$  when chopper is enabled (unless otherwise noted).

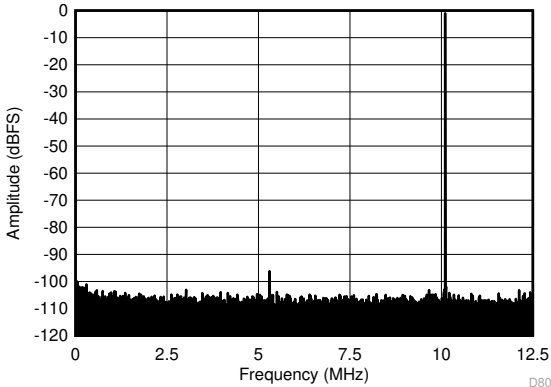

SFDR = 95.2 dBc, SNR = 71.2 dBFS, SINAD = 71.2 dBFS,  
THD = 94.1 dBc, HD2 = 106.0 dBc, HD3 = 95.2 dBc

图 6-1. FFT for 10-MHz Input Signal (Dither On)

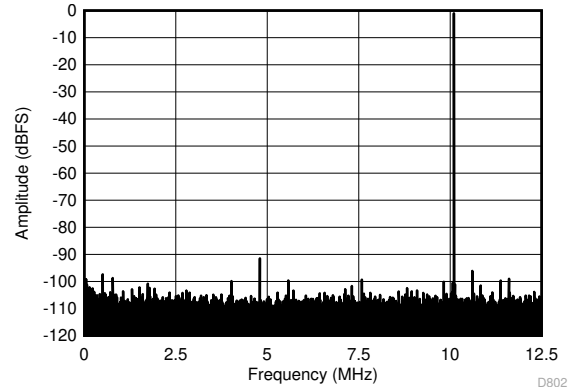

SFDR = 90.4 dBc, SNR = 71.6 dBFS, SINAD = 71.5 dBFS,  
THD = 88.6 dBc, HD2 = 90.4 dBc, HD3 = 105.5 dBc

图 6-2. FFT for 10-MHz Input Signal (Dither Off)

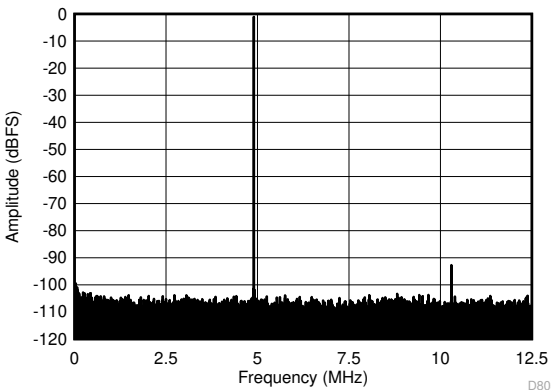

SFDR = 91.6 dBc, SNR = 71.1 dBFS, SINAD = 71.1 dBFS,  
THD = 91 dBc, HD2 = 105.3 dBc, HD3 = 91.6 dBc

图 6-3. FFT for 70-MHz Input Signal (Dither On)

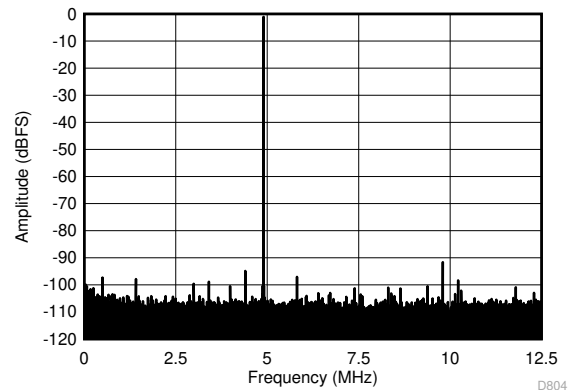

SFDR = 90.6 dBc, SNR = 71.4 dBFS, SINAD = 71.3 dBFS,  
THD = 88.4 dBc, HD2 = 90.6 dBc, HD3 = 101.1 dBc

图 6-4. FFT for 70-MHz Input Signal (Dither Off)

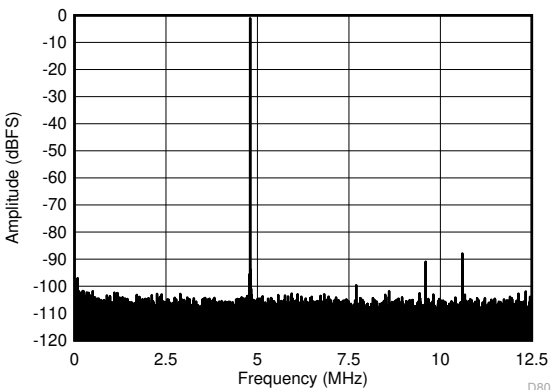

SFDR = 86.8 dBc, SNR = 70.2 dBFS, SINAD = 70.1 dBFS,  
THD = 84.8 dBc, HD2 = 89.9 dBc, HD3 = 86.8 dBc

图 6-5. FFT for 170-MHz Input Signal (Dither On)

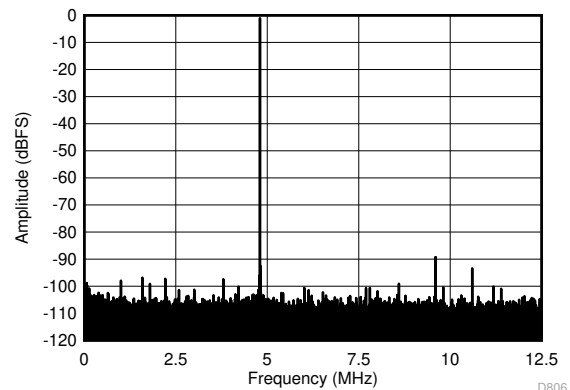

SFDR = 88.2 dBc, SNR = 70.5 dBFS, SINAD = 70.4 dBFS,  
THD = 85.7 dBc, HD2 = 88.2 dBc, HD3 = 92.3 dBc

图 6-6. FFT for 170-MHz Input Signal (Dither Off)

## 6.15 Typical Characteristics: ADC3221 (continued)

Typical values are at  $T_A = 25^\circ\text{C}$ , ADC sampling rate = 25 MSPS, 50% clock duty cycle, AVDD = 1.8 V, DVDD = 1.8 V, -1-dBFS differential input,  $2\text{-}V_{PP}$  full-scale, 32k-point FFT, chopper disabled, and SNR reported with a 1-MHz offset from dc when chopper is disabled and from  $f_S / 2$  when chopper is enabled (unless otherwise noted).

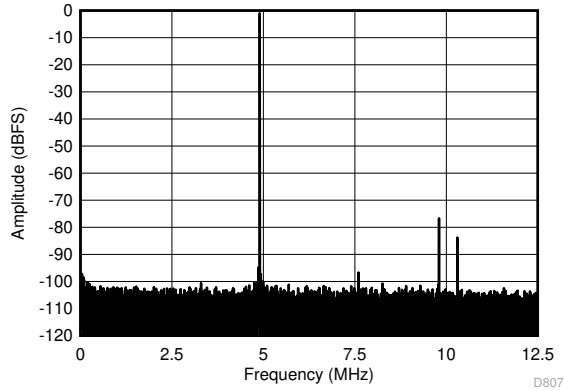

SFDR = 75.7 dBc, SNR = 68.8 dBFS, SINAD = 67.8 dBFS,  
 THD = 74.9 dBc, HD2 = 75.7 dBc, HD3 = 82.8 dBc

图 6-7. FFT for 270-MHz Input Signal (Dither On)

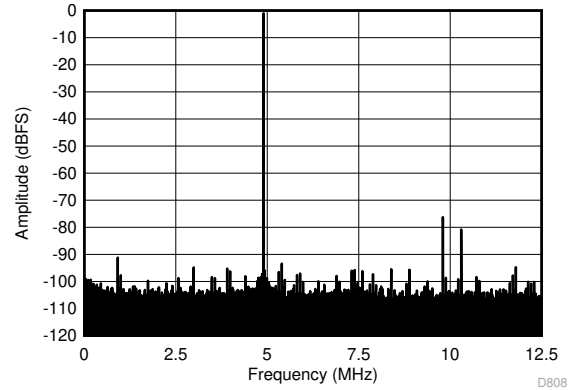

SFDR = 75.3 dBc, SNR = 68.7 dBFS, SINAD = 67.7 dBFS,  
 THD = 73.8 dBc, HD2 = 75.3 dBc, HD3 = 79.8 dBc

图 6-8. FFT for 270-MHz Input Signal (Dither Off)

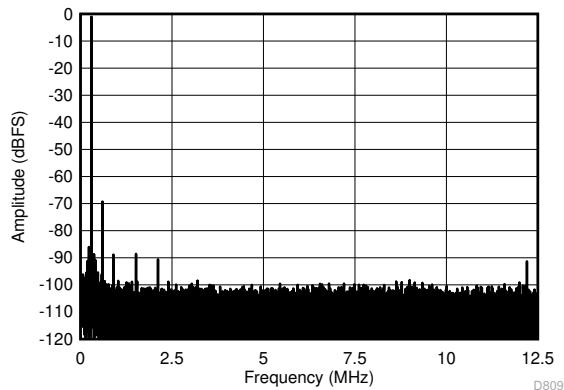

SFDR = 68.2 dBc, SNR = 66.6 dBFS, SINAD = 66.6 dBFS,  
 THD = 92.7 dBc, HD2 = 68.2 dBc, HD3 = 87.8 dBc

图 6-9. FFT for 450-MHz Input Signal (Dither On)

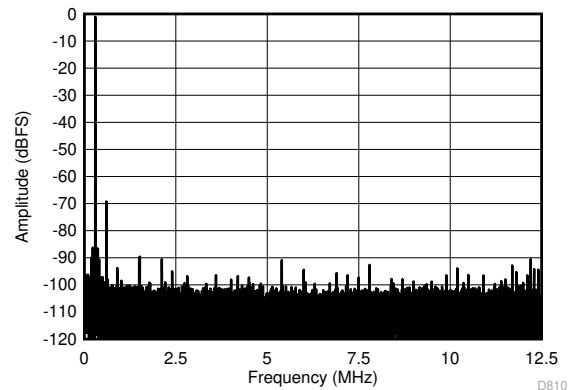

SFDR = 68.2 dBc, SNR = 66.5 dBFS, SINAD = 66.5 dBFS,  
 THD = 87.1 dBc, HD2 = 68.2 dBc, HD3 = 92.7 dBc

图 6-10. FFT for 450-MHz Input Signal (Dither Off)

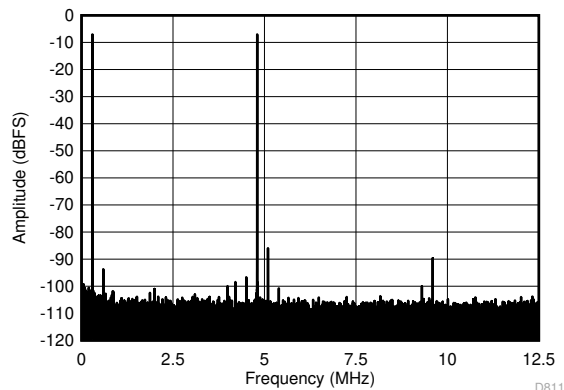

$f_{IN1} = 46\text{ MHz}$ ,  $f_{IN2} = 50\text{ MHz}$ , IMD3 = 84 dBFS, each tone at  
 -7 dBFS

图 6-11. FFT for Two-Tone Input Signal (-7 dBFS at 46 MHz and 50 MHz)

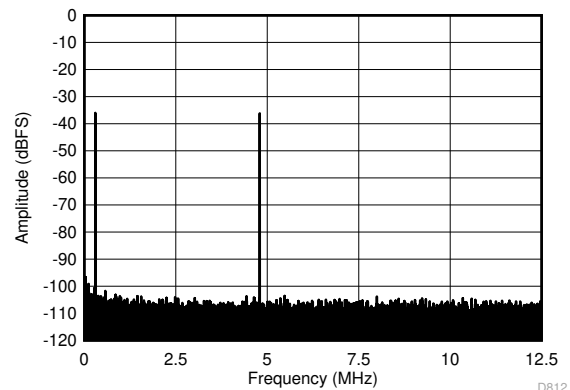

$f_{IN1} = 46\text{ MHz}$ ,  $f_{IN2} = 50\text{ MHz}$ , IMD3 = 105 dBFS, each tone at  
 -36 dBFS

图 6-12. FFT for Two-Tone Input Signal (-36 dBFS at 46 MHz and 50 MHz)

### 6.15 Typical Characteristics: ADC3221 (continued)

Typical values are at  $T_A = 25^\circ\text{C}$ , ADC sampling rate = 25 MSPS, 50% clock duty cycle, AVDD = 1.8 V, DVDD = 1.8 V, -1-dBFS differential input,  $2\text{-}V_{PP}$  full-scale, 32k-point FFT, chopper disabled, and SNR reported with a 1-MHz offset from dc when chopper is disabled and from  $f_S / 2$  when chopper is enabled (unless otherwise noted).

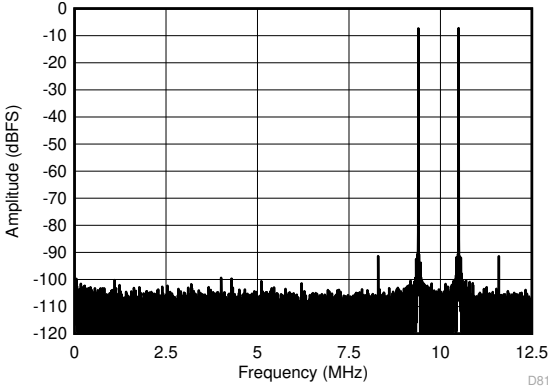

$f_{IN1} = 185 \text{ MHz}$ ,  $f_{IN2} = 190 \text{ MHz}$ ,  $\text{IMD3} = 91 \text{ dBFS}$ , each tone at  $-7 \text{ dBFS}$

图 6-13. FFT for Two-Tone Input Signal (-7 dBFS at 185 MHz and 190 MHz)

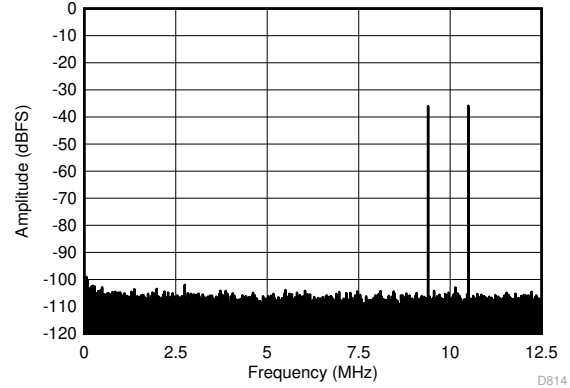

$f_{IN1} = 185 \text{ MHz}$ ,  $f_{IN2} = 190 \text{ MHz}$ ,  $\text{IMD3} = 105 \text{ dBFS}$ , each tone at  $-36 \text{ dBFS}$

图 6-14. FFT for Two-Tone Input Signal (-36 dBFS at 185 MHz and 190 MHz)



图 6-15. Intermodulation Distortion vs Input Amplitude (46 MHz and 50 MHz)



图 6-16. Intermodulation Distortion vs Input Amplitude (185 MHz and 190 MHz)

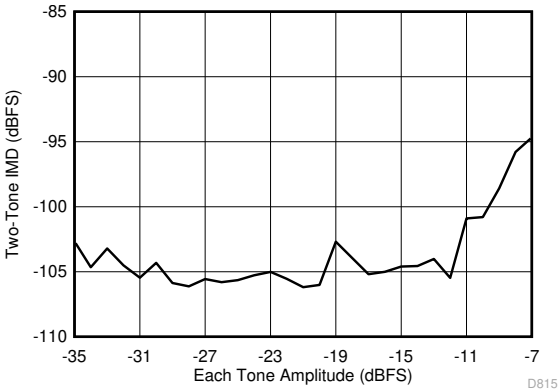

图 6-17. Signal-to-Noise Ratio vs Input Frequency

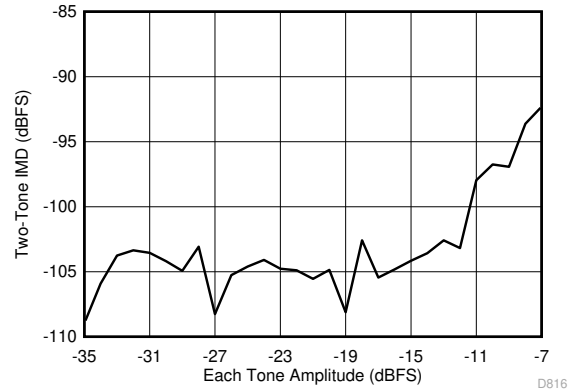

图 6-18. Spurious-Free Dynamic Range vs Input Frequency

## 6.15 Typical Characteristics: ADC3221 (continued)

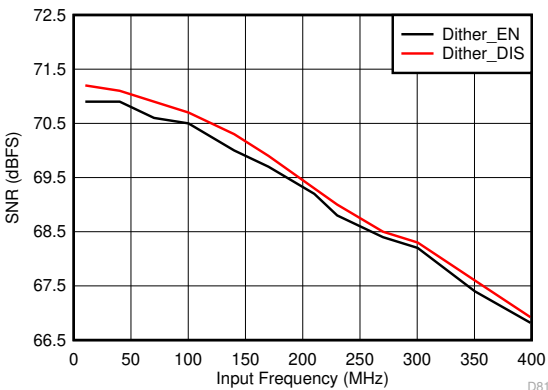
Typical values are at  $T_A = 25^\circ\text{C}$ , ADC sampling rate = 25 MSPS, 50% clock duty cycle, AVDD = 1.8 V, DVDD = 1.8 V, -1-dBFS differential input,  $2\text{-}V_{PP}$  full-scale, 32k-point FFT, chopper disabled, and SNR reported with a 1-MHz offset from dc when chopper is disabled and from  $f_S / 2$  when chopper is enabled (unless otherwise noted).



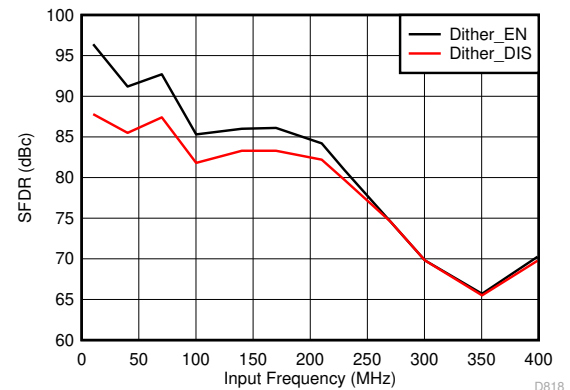
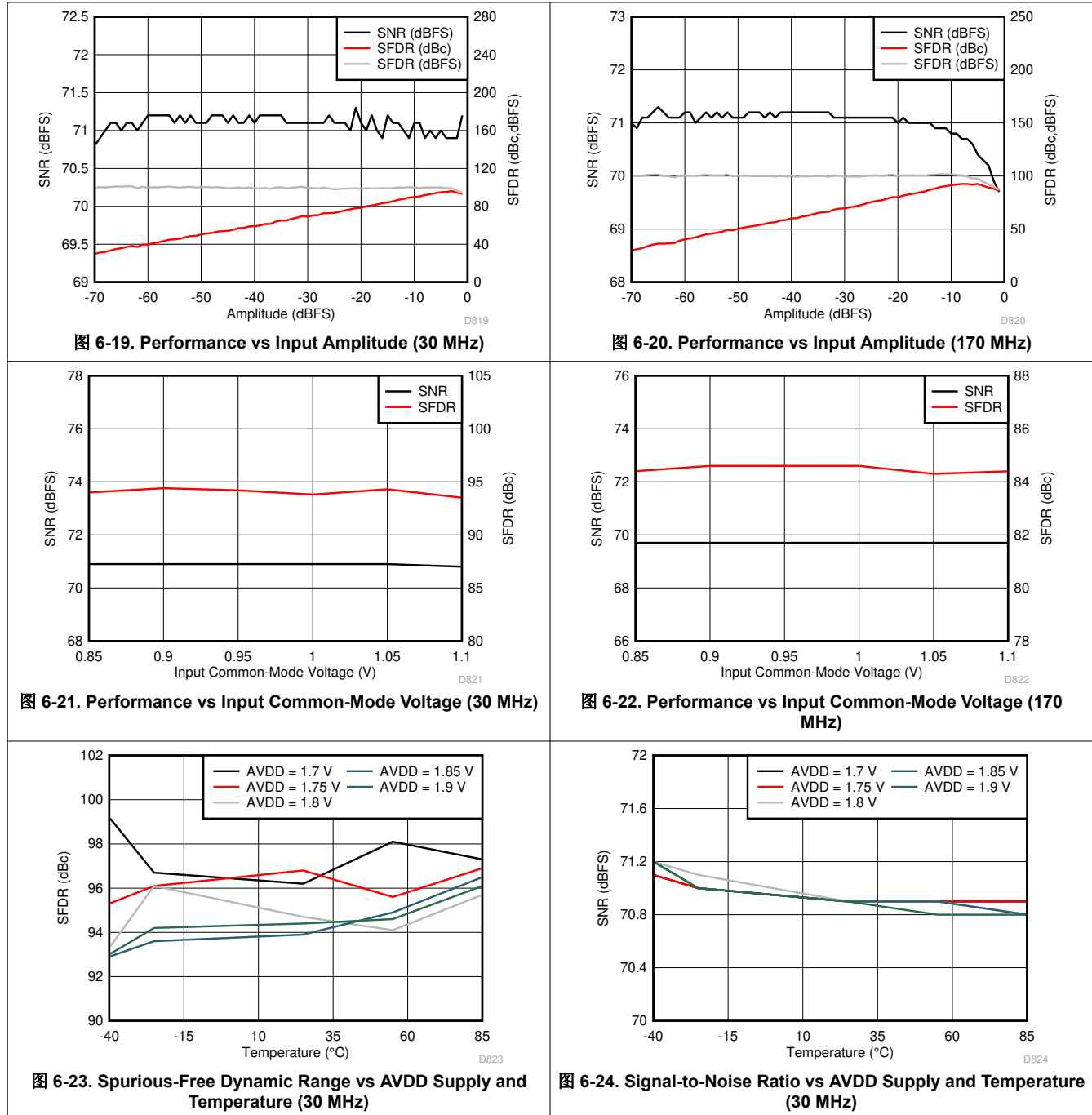

### 6.15 Typical Characteristics: ADC3221 (continued)

Typical values are at  $T_A = 25^\circ\text{C}$ , ADC sampling rate = 25 MSPS, 50% clock duty cycle, AVDD = 1.8 V, DVDD = 1.8 V, -1-dBFS differential input,  $2\text{-}V_{PP}$  full-scale, 32k-point FFT, chopper disabled, and SNR reported with a 1-MHz offset from dc when chopper is disabled and from  $f_S / 2$  when chopper is enabled (unless otherwise noted).



图 6-25. Spurious-Free Dynamic Range vs DVDD Supply and Temperature (30 MHz)



图 6-26. Signal-to-Noise Ratio vs DVDD Supply and Temperature (30 MHz)

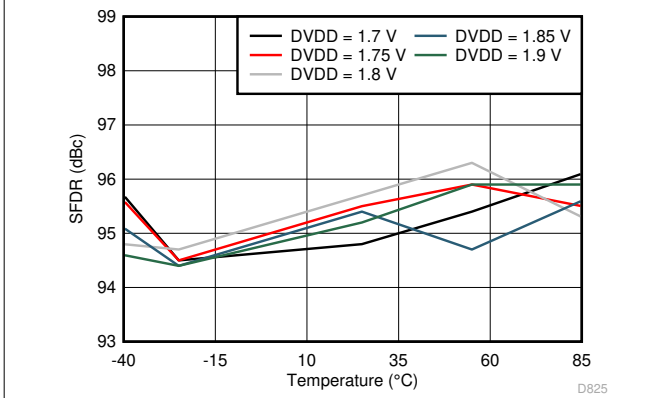

图 6-27. Performance vs Differential Clock Amplitude (40 MHz)

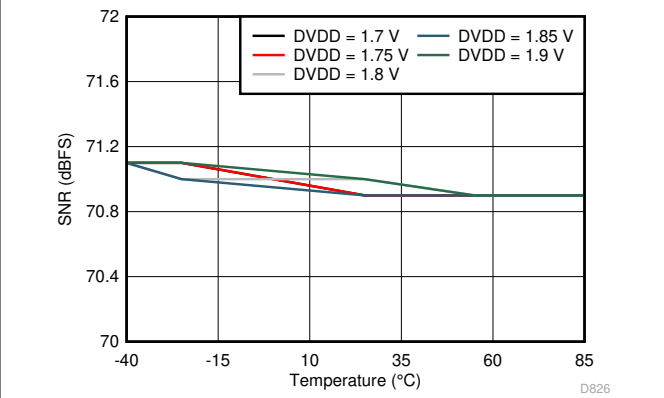

图 6-28. Performance vs Differential Clock Amplitude (150 MHz)

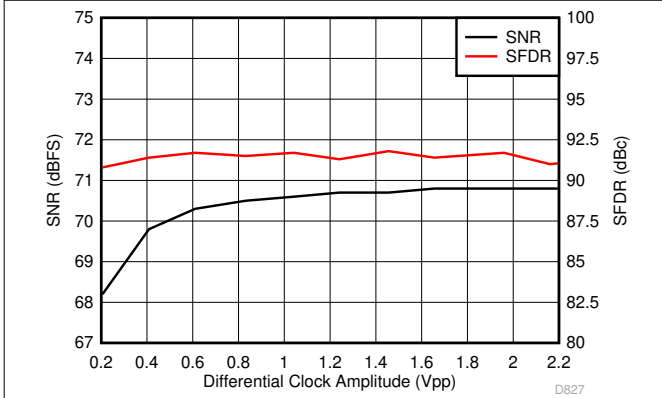

图 6-29. Performance vs Clock Duty Cycle (30 MHz)

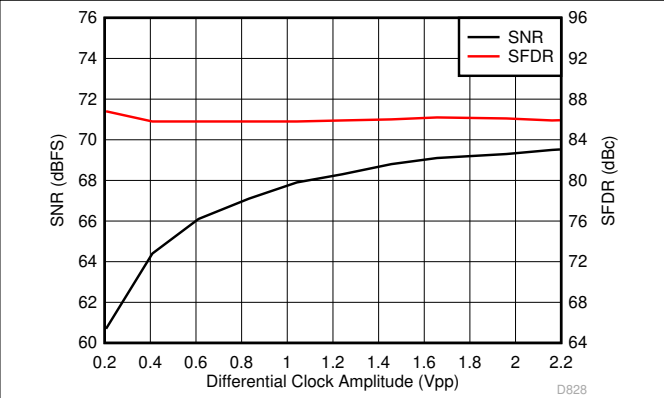

图 6-30. Performance vs Clock Duty Cycle (150 MHz)

## 6.16 Typical Characteristics: ADC3222

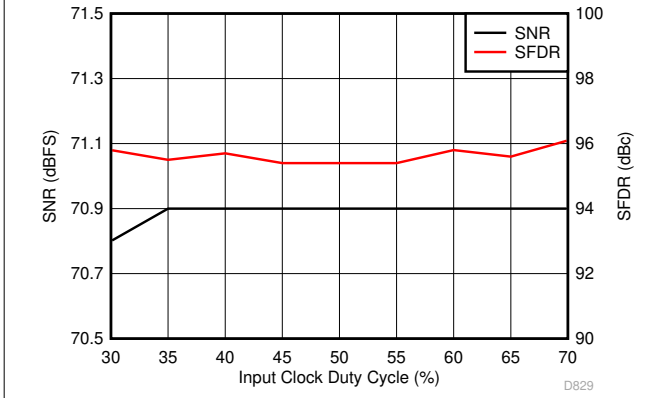
Typical values are at  $T_A = 25^\circ\text{C}$ , ADC sampling rate = 50 MSPS, 50% clock duty cycle,  $AV_{DD} = 1.8\text{ V}$ ,  $DV_{DD} = 1.8\text{ V}$ , -1-dBFS differential input,  $2-V_{PP}$  full-scale, 32k-point FFT, chopper disabled, and SNR reported with a 1-MHz offset from dc when chopper is disabled and from  $f_S / 2$  when chopper is enabled (unless otherwise noted).

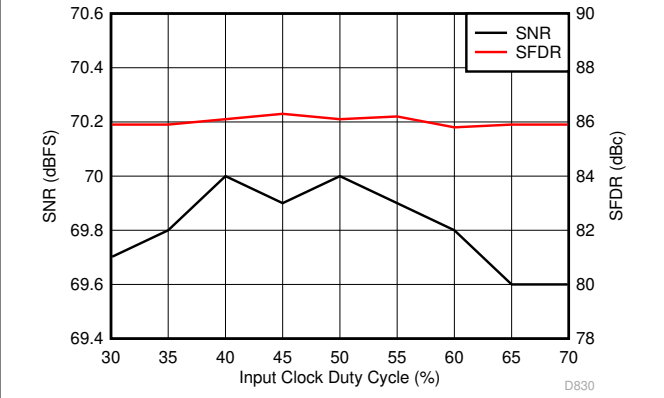
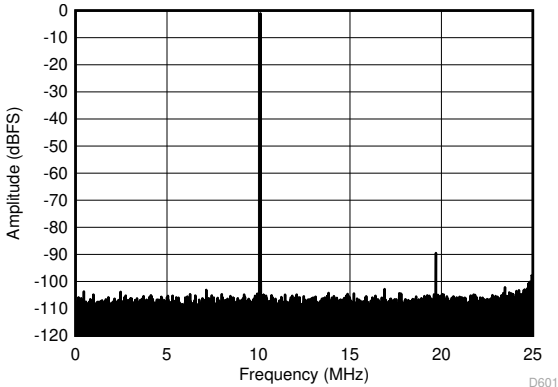

SFDR = 88.5 dBc, SFDR = 99.8 dBc (non 23), SNR = 71.1 dBFS, SINAD = 71 dBFS, THD = 88.1 dBc, HD2 = 109.9 dBc, HD3 = 88.5 dBc

图 6-31. FFT for 10-MHz Input Signal (Dither On)

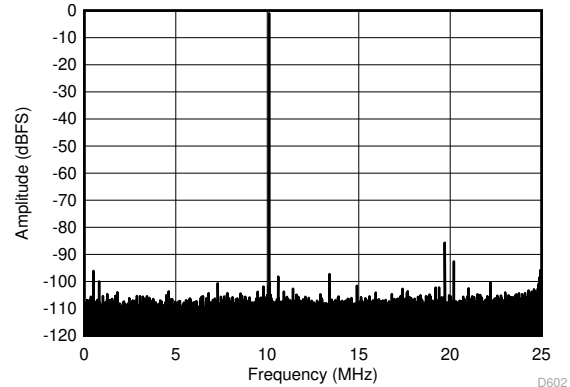

SFDR = 84.6 dBc, SFDR = 96.1 dBc (non 23), SNR = 71.4 dBFS, SINAD = 71.1 dBFS, THD = 83.2 dBc, HD2 = 91.6 dBc, HD3 = 84.6 dBc

图 6-32. FFT for 10-MHz Input Signal (Dither Off)

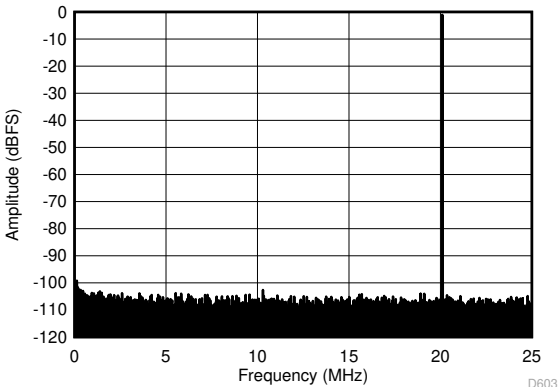

SFDR = 101.6 dBc, SFDR = 100.3 dBc (non 23), SNR = 70.9 dBFS, SINAD = 70.9 dBFS, THD = 98.1 dBc, HD2 = 106.6 dBc, HD3 = 101.6 dBc

图 6-33. FFT for 70-MHz Input Signal (Dither On)

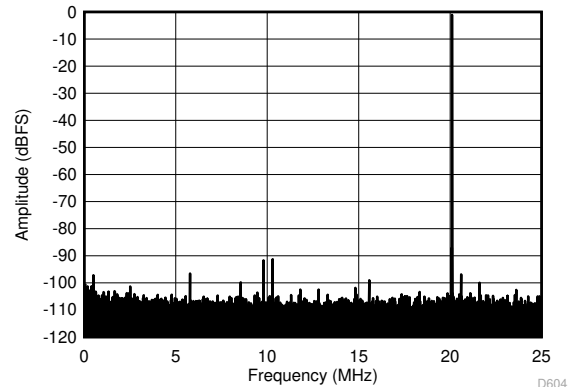

SFDR = 90.2 dBc, SFDR = 94.7 dBc (non 23), SNR = 71.2 dBFS, SINAD = 71.1 dBFS, THD = 86.7 dBc, HD2 = 90.6 dBc, HD3 = 90.2 dBc

图 6-34. FFT for 70-MHz Input Signal (Dither Off)

## 6.16 Typical Characteristics: ADC3222 (continued)

Typical values are at  $T_A = 25^\circ\text{C}$ , ADC sampling rate = 50 MSPS, 50% clock duty cycle, AVDD = 1.8 V, DVDD = 1.8 V, -1-dBFS differential input,  $2-V_{PP}$  full-scale, 32k-point FFT, chopper disabled, and SNR reported with a 1-MHz offset from dc when chopper is disabled and from  $f_S / 2$  when chopper is enabled (unless otherwise noted).

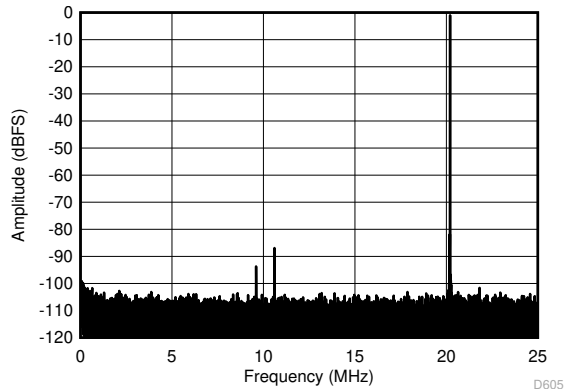

SFDR = 85.9 dBc, SFDR = 99.1 dBc (non 23), SNR = 70.4 dBFS, SINAD = 70.2 dBFS, THD = 84.8 dBc, HD2 = 92.7 dBc, HD3 = 85.9 dBc

图 6-35. FFT for 170-MHz Input Signal (Dither On)

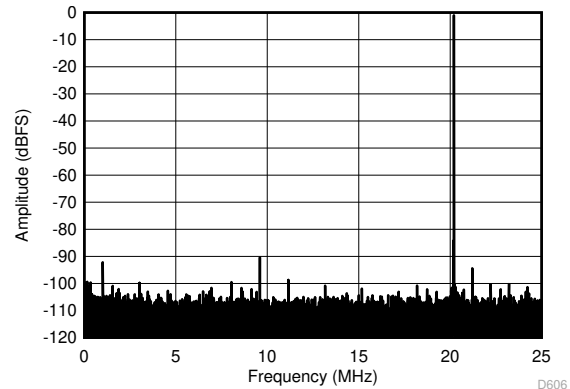

SFDR = 89.3 dBc, SFDR = 93 dBc (non 23), SNR = 70.7 dBFS, SINAD = 70.6 dBFS, THD = 85.8 dBc, HD2 = 89.3 dBc, HD3 = 111.9 dBc

图 6-36. FFT for 170-MHz Input Signal (Dither Off)

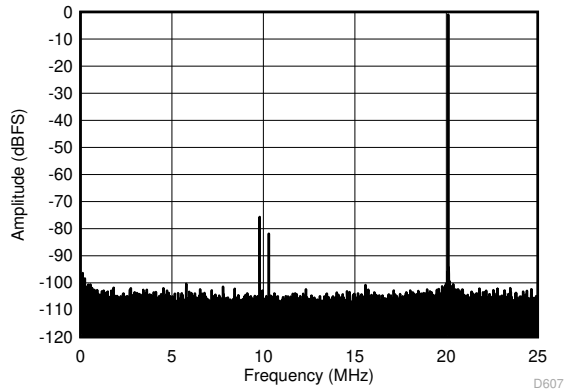

SFDR = 74.7 dBc, SFDR = 95.2 dBc (non 23), SNR = 69.2 dBFS, SINAD = 68.1 dBFS, THD = 73.7 dBc, HD2 = 74.7 dBc, HD3 = 80.9 dBc

图 6-37. FFT for 270-MHz Input Signal (Dither On)

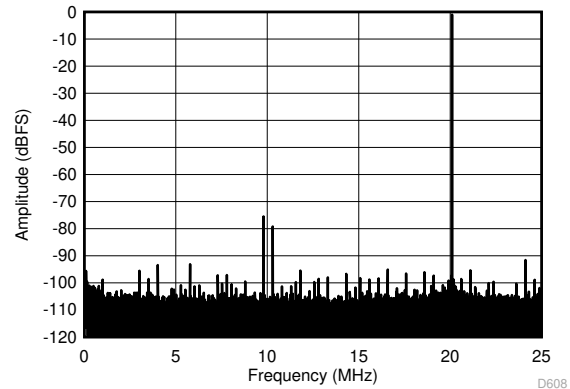

SFDR = 74.5 dBc, SFDR = 91.1 dBc (non 23), SNR = 69.4 dBFS, SINAD = 68.1 dBFS, THD = 72.9 dBc, HD2 = 74.5 dBc, HD3 = 78.2 dBc

图 6-38. FFT for 270-MHz Input Signal (Dither Off)

### 6.16 Typical Characteristics: ADC3222 (continued)

Typical values are at  $T_A = 25^\circ\text{C}$ , ADC sampling rate = 50 MSPS, 50% clock duty cycle,  $AV_{DD} = 1.8\text{ V}$ ,  $DV_{DD} = 1.8\text{ V}$ , -1-dBFS differential input,  $2-V_{PP}$  full-scale, 32k-point FFT, chopper disabled, and SNR reported with a 1-MHz offset from dc when chopper is disabled and from  $f_S / 2$  when chopper is enabled (unless otherwise noted).

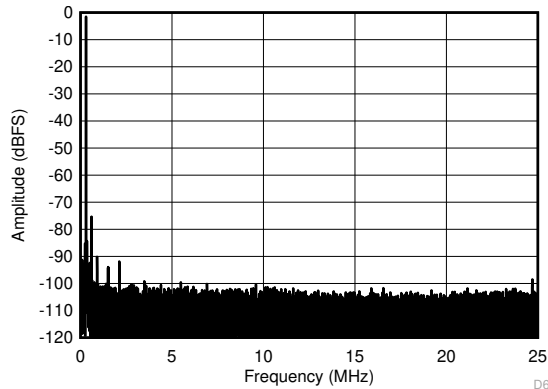

SFDR = 68.2 dBc, SNR = 67.4 dBFS, SINAD = 67.3 dBFS,  
THD = 86.4 dBc, HD2 = 68.2 dBc, HD3 = 87.3 dBc

图 6-39. FFT for 450-MHz Input Signal (Dither On)

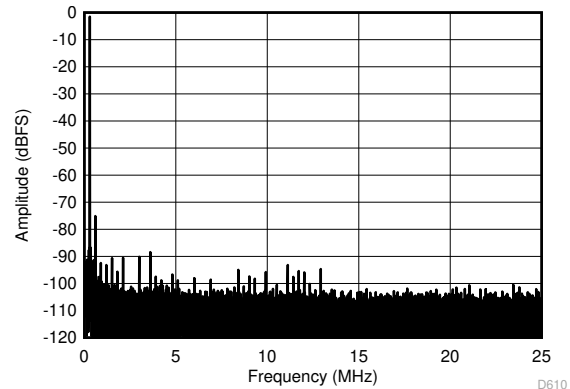

SFDR = 68.1 dBc, SNR = 67.7 dBFS, SINAD = 67.6 dBFS,  
THD = 86.6 dBc, HD2 = 68.1 dBc, HD3 = 87.3 dBc

图 6-40. FFT for 450-MHz Input Signal (Dither Off)

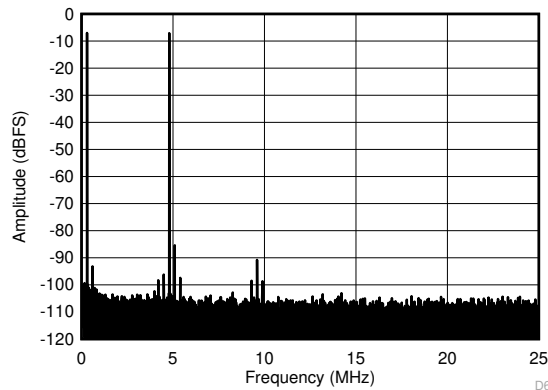

$f_{IN1} = 46\text{ MHz}$ ,  $f_{IN2} = 50\text{ MHz}$ , IMD3 = 85.4 dBFS, each tone at  
-7 dBFS

图 6-41. FFT for Two-Tone Input Signal (-7 dBFS at 46 MHz and 50 MHz)

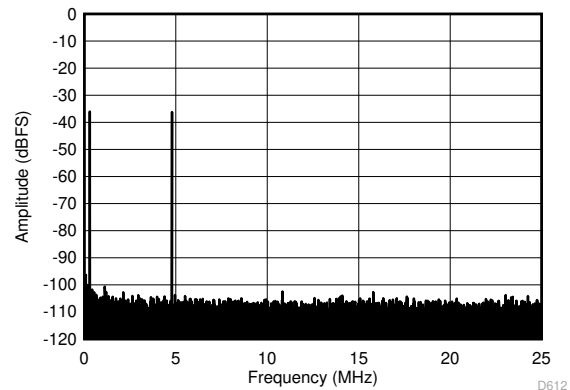

$f_{IN1} = 46\text{ MHz}$ ,  $f_{IN2} = 50\text{ MHz}$ , IMD3 = 103 dBFS, each tone at  
-36 dBFS

图 6-42. FFT for Two-Tone Input Signal (-36 dBFS at 46 MHz and 50 MHz)

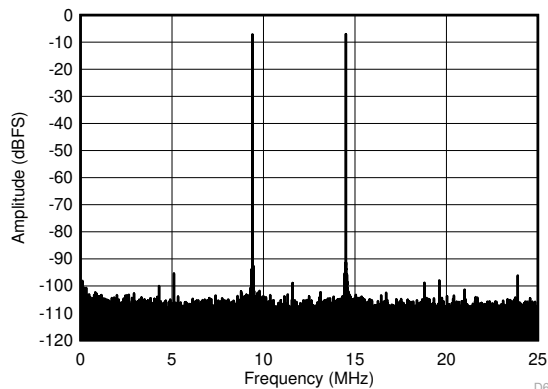

$f_{IN1} = 185\text{ MHz}$ ,  $f_{IN2} = 190\text{ MHz}$ , IMD3 = 95 dBFS, each tone at  
-7 dBFS

图 6-43. FFT for Two-Tone Input Signal (-7 dBFS at 185 MHz and 190 MHz)

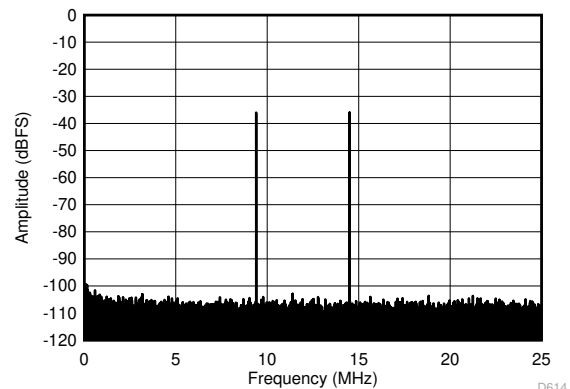

$f_{IN1} = 185\text{ MHz}$ ,  $f_{IN2} = 190\text{ MHz}$ , IMD3 = 105 dBFS, each tone at  
-36 dBFS

图 6-44. FFT for Two-Tone Input Signal (-36 dBFS at 185 MHz and 190 MHz)

### 6.16 Typical Characteristics: ADC3222 (continued)

Typical values are at  $T_A = 25^\circ\text{C}$ , ADC sampling rate = 50 MSPS, 50% clock duty cycle, AVDD = 1.8 V, DVDD = 1.8 V, -1-dBFS differential input,  $2\text{-}V_{PP}$  full-scale, 32k-point FFT, chopper disabled, and SNR reported with a 1-MHz offset from dc when chopper is disabled and from  $f_S / 2$  when chopper is enabled (unless otherwise noted).



图 6-45. Intermodulation Distortion vs Input Amplitude (46 MHz and 50 MHz)



图 6-46. Intermodulation Distortion vs Input Amplitude (185 MHz and 190 MHz)

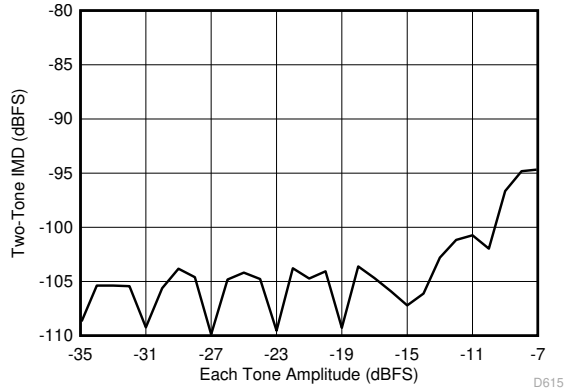

图 6-47. Signal-to-Noise Ratio vs Input Frequency

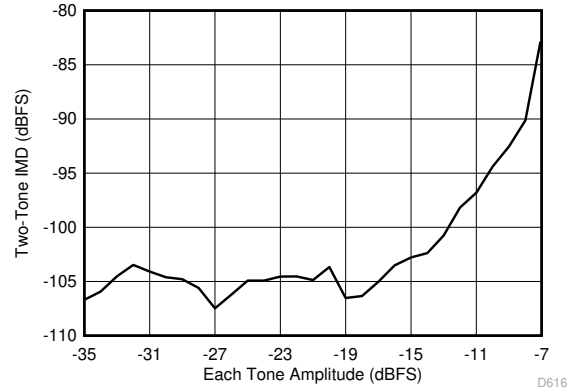

图 6-48. Spurious-Free Dynamic Range vs Input Frequency

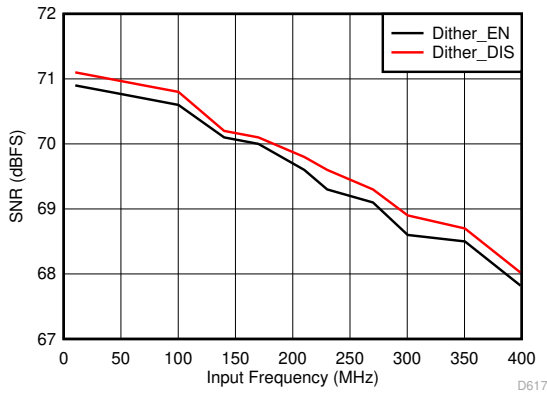

图 6-49. Performance vs Input Amplitude (30 MHz)

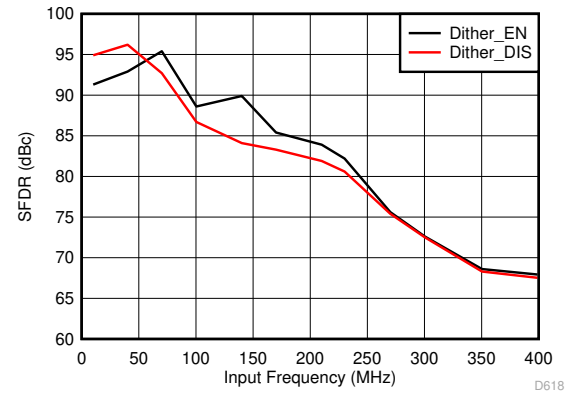

图 6-50. Performance vs Input Amplitude (170 MHz)

## 6.16 Typical Characteristics: ADC3222 (continued)

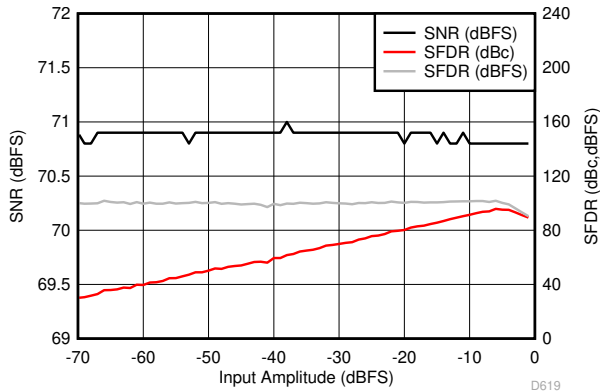
Typical values are at  $T_A = 25^\circ\text{C}$ , ADC sampling rate = 50 MSPS, 50% clock duty cycle, AVDD = 1.8 V, DVDD = 1.8 V, -1-dBFS differential input,  $2\text{-}V_{PP}$  full-scale, 32k-point FFT, chopper disabled, and SNR reported with a 1-MHz offset from dc when chopper is disabled and from  $f_S / 2$  when chopper is enabled (unless otherwise noted).

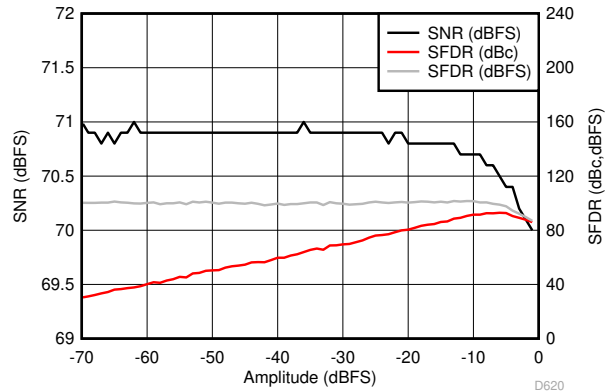

图 6-51. Performance vs Input Common-Mode Voltage (30 MHz)



图 6-52. Performance vs Input Common-Mode Voltage (170 MHz)

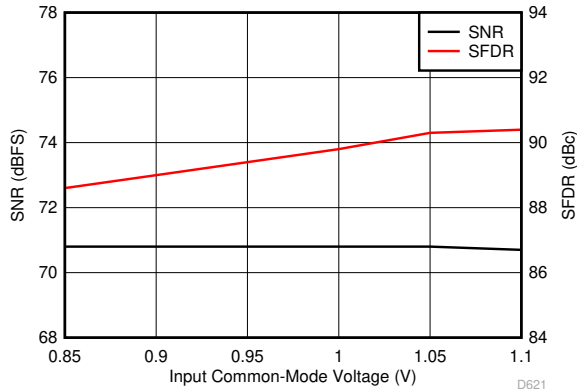

图 6-53. Spurious-Free Dynamic Range vs AVDD Supply and Temperature (30 MHz)

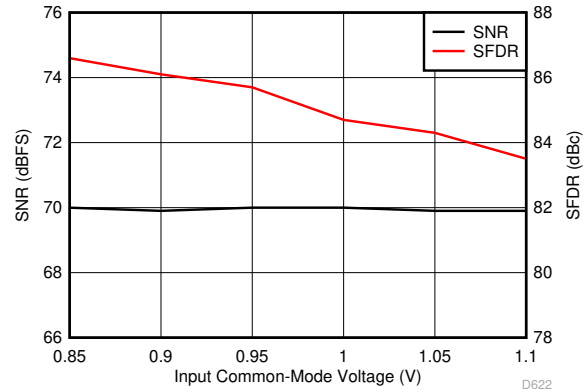

图 6-54. Signal-to-Noise Ratio vs AVDD Supply and Temperature (30 MHz)

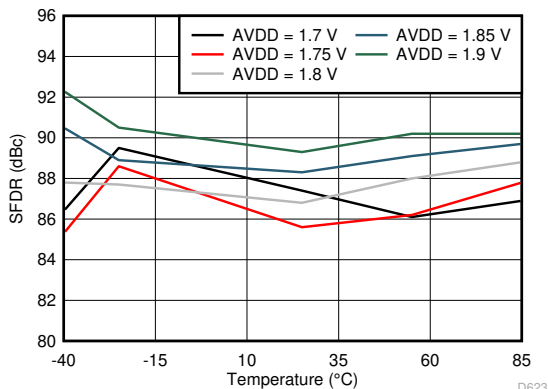

图 6-55. Spurious-Free Dynamic Range vs DVDD Supply and Temperature (30 MHz)

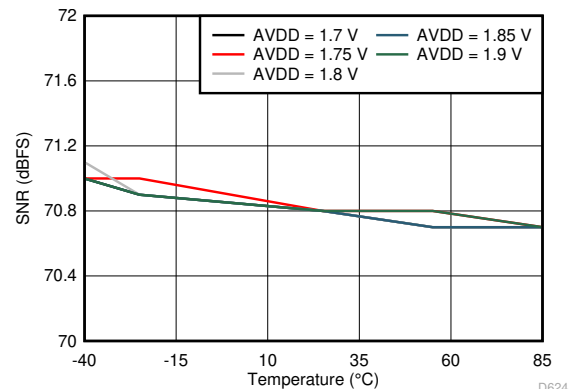

图 6-56. Signal-to-Noise Ratio vs DVDD Supply and Temperature (30 MHz)

### 6.16 Typical Characteristics: ADC3222 (continued)

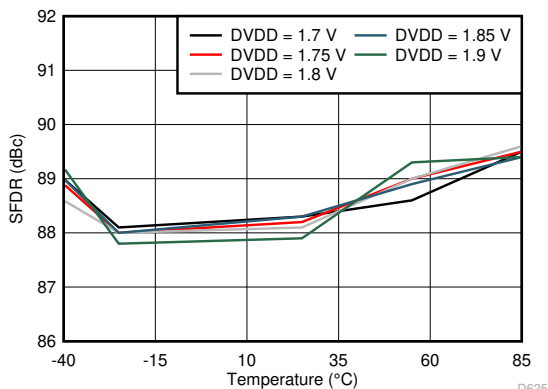
Typical values are at  $T_A = 25^\circ\text{C}$ , ADC sampling rate = 50 MSPS, 50% clock duty cycle, AVDD = 1.8 V, DVDD = 1.8 V, -1-dBFS differential input,  $2\text{-}V_{PP}$  full-scale, 32k-point FFT, chopper disabled, and SNR reported with a 1-MHz offset from dc when chopper is disabled and from  $f_S / 2$  when chopper is enabled (unless otherwise noted).

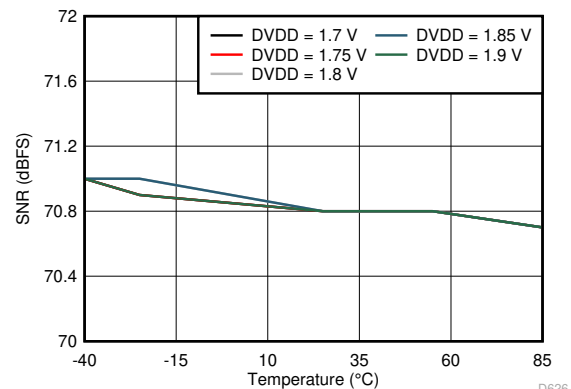

图 6-57. Performance vs Differential Clock Amplitude (40 MHz)



图 6-58. Performance vs Differential Clock Amplitude (150 MHz)

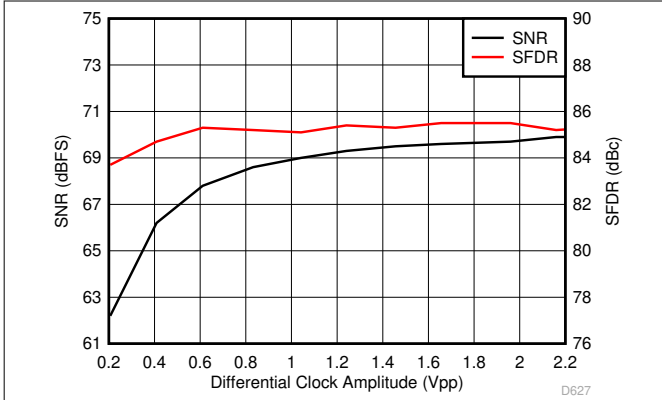

图 6-59. Performance vs Clock Duty Cycle (30 MHz)

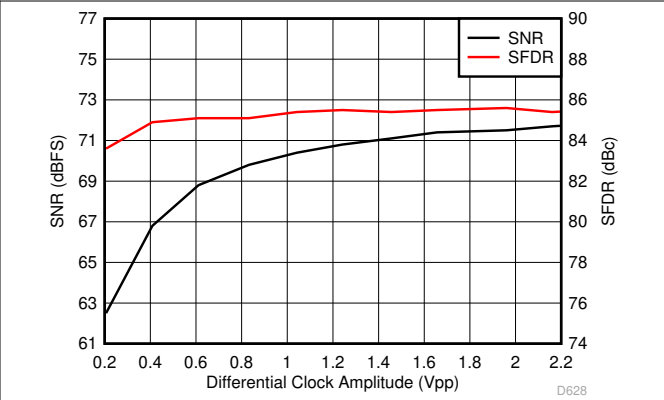

图 6-60. Performance vs Clock Duty Cycle (150 MHz)

## 6.17 Typical Characteristics: ADC3223

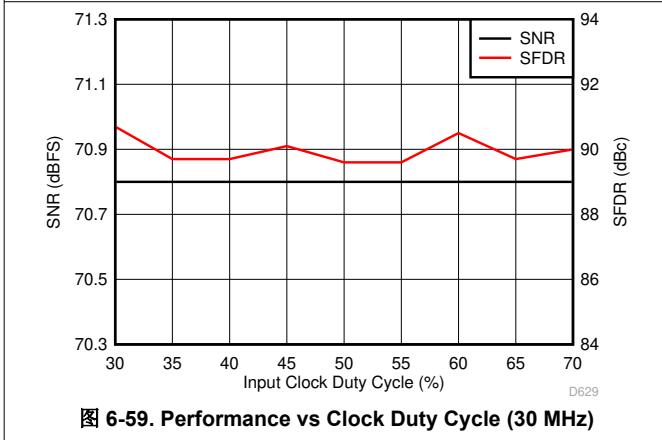
Typical values are at  $T_A = 25^\circ\text{C}$ , ADC sampling rate = 80 MSPS, 50% clock duty cycle,  $AV_{DD} = 1.8\text{ V}$ ,  $DV_{DD} = 1.8\text{ V}$ , -1-dBFS differential input,  $2-V_{PP}$  full-scale, 32k-point FFT, chopper disabled, and SNR reported with a 1-MHz offset from dc when chopper is disabled and from  $f_S / 2$  when chopper is enabled (unless otherwise noted).

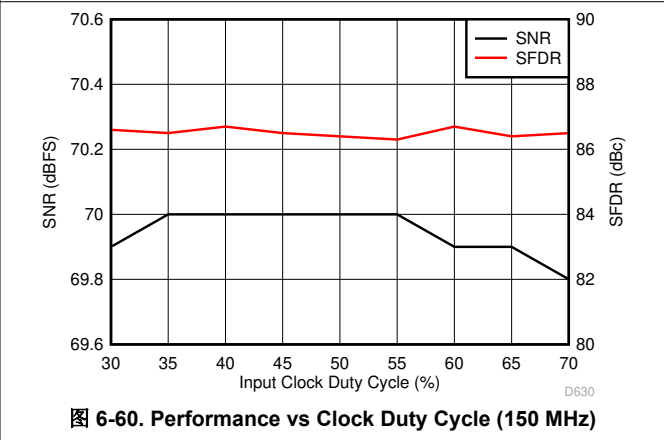
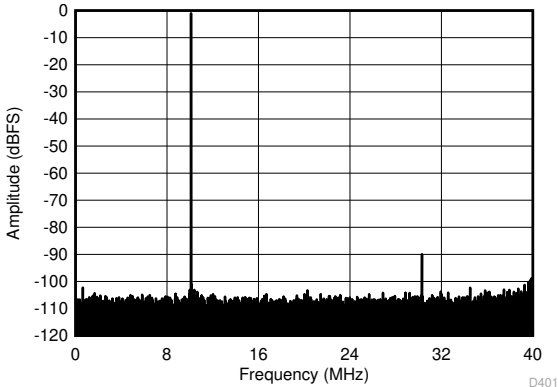

SFDR = 88.9 dBc, SNR = 70.9 dBFS, SINAD = 70.8 dBFS,  
 THD = 88.6 dBc, HD2 = 108.1 dBc, HD3 = 88.9 dBc

图 6-61. FFT for 10-MHz Input Signal (Dither On)

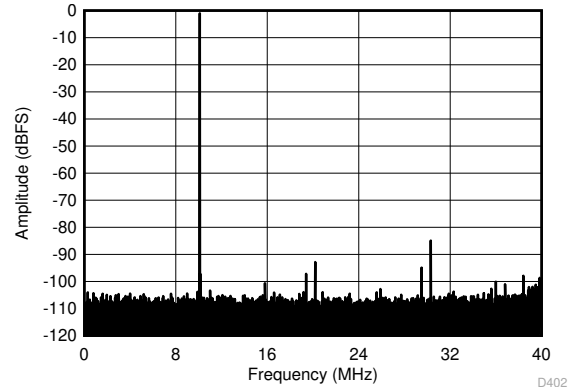

SFDR = 83.9 dBc, SNR = 71.1 dBFS, SINAD = 70.9 dBFS,  
 THD = 82.6 dBc, HD2 = 91.8 dBc, HD3 = 83.9 dBc

图 6-62. FFT for 10-MHz Input Signal (Dither Off)

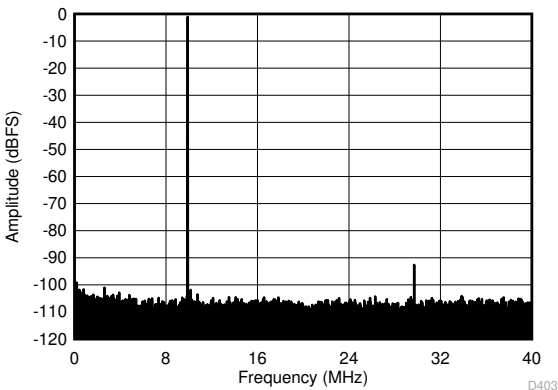

SFDR = 91.6 dBc, SNR = 70.8 dBFS, SINAD = 70.8 dBFS,  
 THD = 91 dBc, HD2 = 112.2 dBc, HD3 = 91.6 dBc

图 6-63. FFT for 70-MHz Input Signal (Dither On)

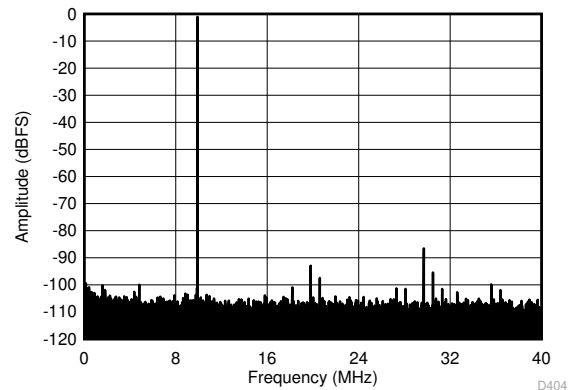

SFDR = 85.5 dBc, SNR = 71.1 dBFS, SINAD = 70.9 dBFS,  
 THD = 83.8 dBc, HD2 = 91.9 dBc, HD3 = 85.5 dBc

图 6-64. FFT for 70-MHz Input Signal (Dither Off)

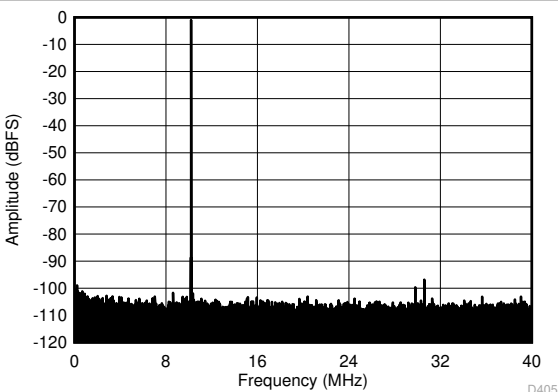

SFDR = 95.8 dBc, SNR = 70.4 dBFS, SINAD = 70.3 dBFS,  
 THD = 92.9 dBc, HD2 = 102.1 dBc, HD3 = 95.8 dBc

图 6-65. FFT for 170-MHz Input Signal (Dither On)

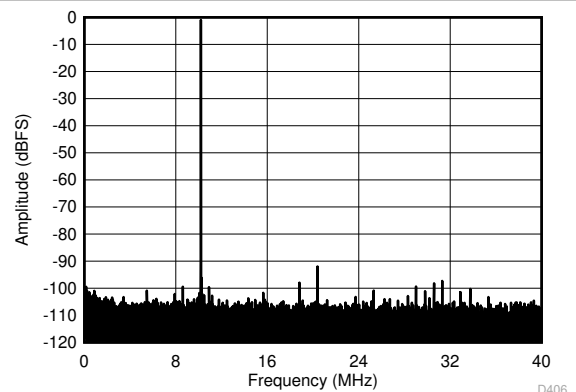

SFDR = 91.0 dBc, SNR = 70.7 dBFS, SINAD = 70.6 dBFS,  
 THD = 88 dBc, HD2 = 91.0 dBc, HD3 = 97.2 dBc

图 6-66. FFT for 170-MHz Input Signal (Dither Off)



### 6.17 Typical Characteristics: ADC3223 (continued)

Typical values are at  $T_A = 25^\circ\text{C}$ , ADC sampling rate = 80 MSPS, 50% clock duty cycle, AVDD = 1.8 V, DVDD = 1.8 V, -1-dBFS differential input,  $2\text{-}V_{PP}$  full-scale, 32k-point FFT, chopper disabled, and SNR reported with a 1-MHz offset from dc when chopper is disabled and from  $f_S / 2$  when chopper is enabled (unless otherwise noted).

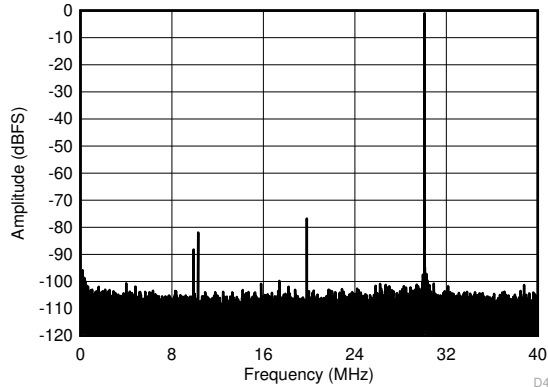

SFDR = 75.8 dBc, SNR = 69.4 dBFS, SINAD = 68.5 dBFS,  
THD = 74.6 dBc, HD2 = 75.8 dBc, HD3 = 80.9 dBc

图 6-67. FFT for 270-MHz Input Signal (Dither On)

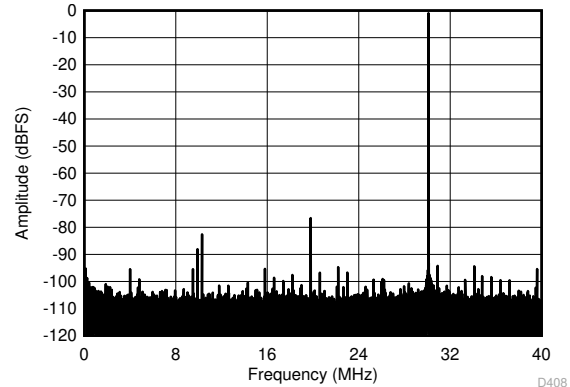

SFDR = 75.6 dBc, SNR = 69.7 dBFS, SINAD = 68.6 dBFS,  
THD = 74.5 dBc, HD2 = 75.6 dBc, HD3 = 81.6 dBc

图 6-68. FFT for 270-MHz Input Signal (Dither Off)

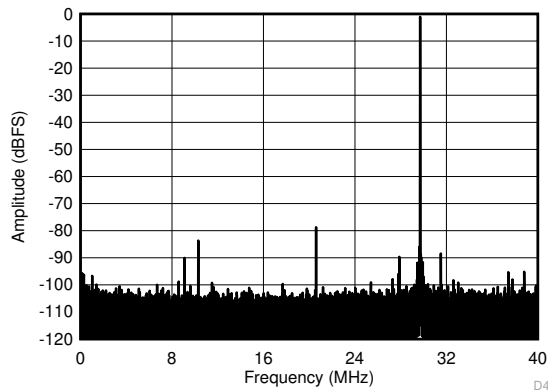

SFDR = 77.7 dBc, SNR = 67.7 dBFS, SINAD = 67.3 dBFS,  
THD = 77.2 dBc, HD2 = 77.7 dBc, HD3 = 89.0 dBc

图 6-69. FFT for 450-MHz Input Signal (Dither On)

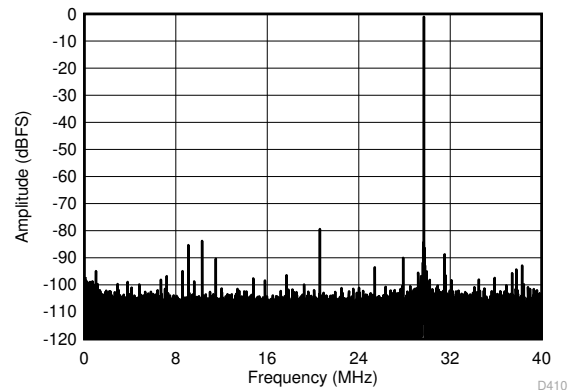

SFDR = 78.4 dBc, SNR = 67.9 dBFS, SINAD = 67.5 dBFS,  
THD = 77 dBc, HD2 = 78.4 dBc, HD3 = 84.3 dBc

图 6-70. FFT for 450-MHz Input Signal (Dither Off)

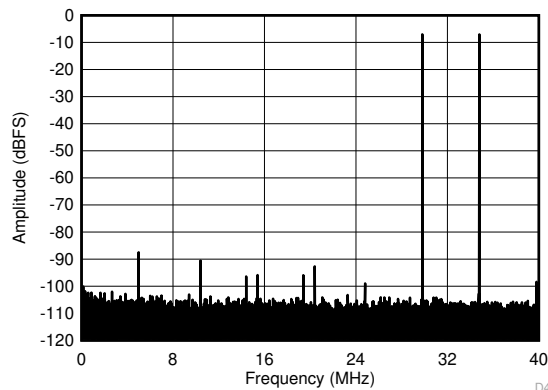

$f_{IN1} = 46\text{ MHz}$ ,  $f_{IN2} = 50\text{ MHz}$ , IMD3 = 87.5 dBFS, each tone at  
- 7 dBFS

图 6-71. FFT for Two-Tone Input Signal (- 7 dBFS at 46 MHz and 50 MHz)

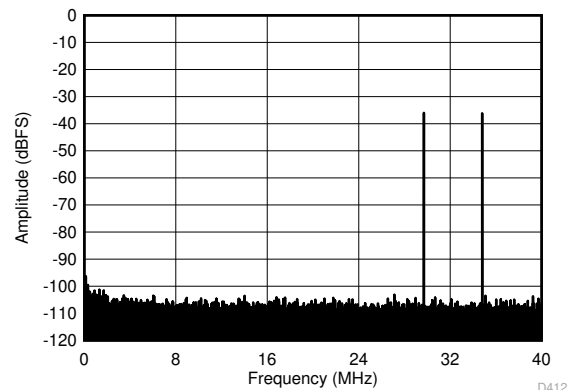

$f_{IN1} = 46\text{ MHz}$ ,  $f_{IN2} = 50\text{ MHz}$ , IMD3 = 105 dBFS, each tone at  
- 36 dBFS

图 6-72. FFT for Two-Tone Input Signal (- 36 dBFS at 46 MHz and 50 MHz)

### 6.17 Typical Characteristics: ADC3223 (continued)

Typical values are at  $T_A = 25^\circ\text{C}$ , ADC sampling rate = 80 MSPS, 50% clock duty cycle, AVDD = 1.8 V, DVDD = 1.8 V, -1-dBFS differential input,  $2\text{-}V_{PP}$  full-scale, 32k-point FFT, chopper disabled, and SNR reported with a 1-MHz offset from dc when chopper is disabled and from  $f_S / 2$  when chopper is enabled (unless otherwise noted).

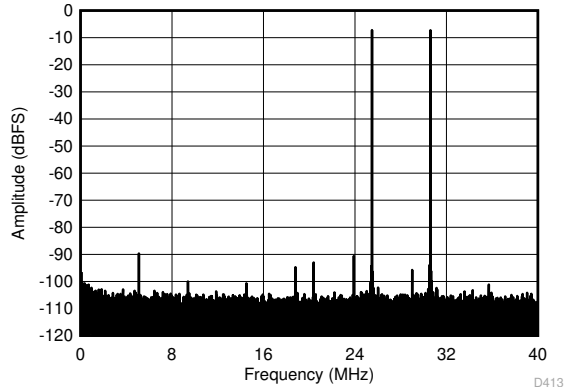

$f_{IN1} = 185 \text{ MHz}$ ,  $f_{IN2} = 190 \text{ MHz}$ , IMD3 = 89 dBFS, each tone at -7 dBFS

**图 6-73. FFT FOR Two-Tone Input Signal (-7 dBFS at 185 MHz and 190 MHz)**

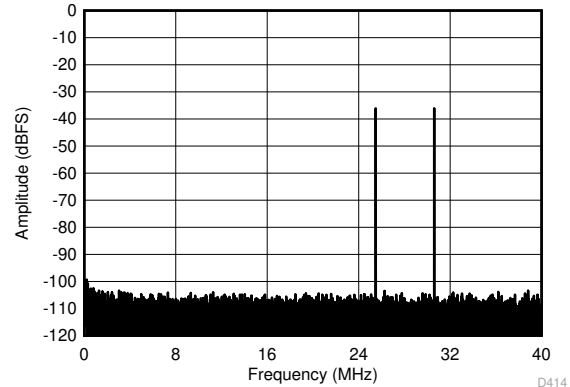

$f_{IN1} = 185 \text{ MHz}$ ,  $f_{IN2} = 190 \text{ MHz}$ , IMD3 = 105 dBFS, each tone at -36 dBFS

**图 6-74. FFT FOR Two-Tone Input Signal (-36 dBFS at 185 MHz and 190 MHz)**

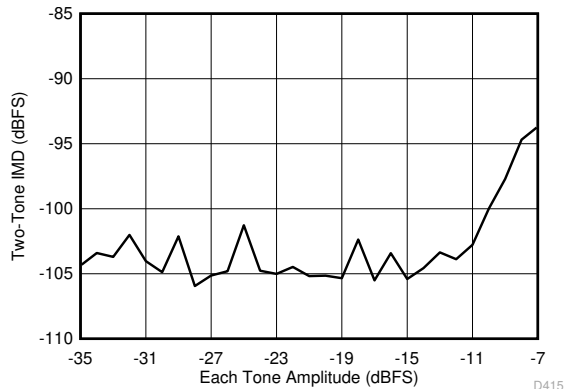

**图 6-75. Intermodulation Distortion vs Input Amplitude (46 MHz and 50 MHz)**

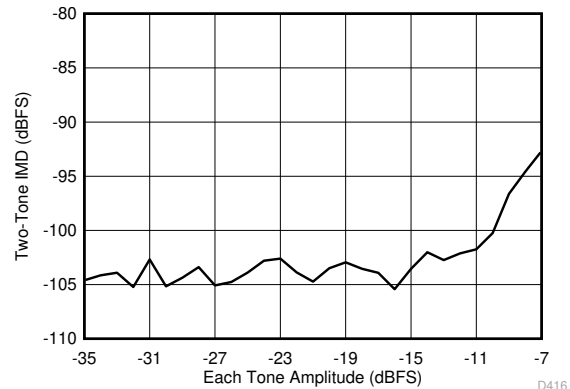

**图 6-76. Intermodulation Distortion vs Input Amplitude (185 MHz and 190 MHz)**

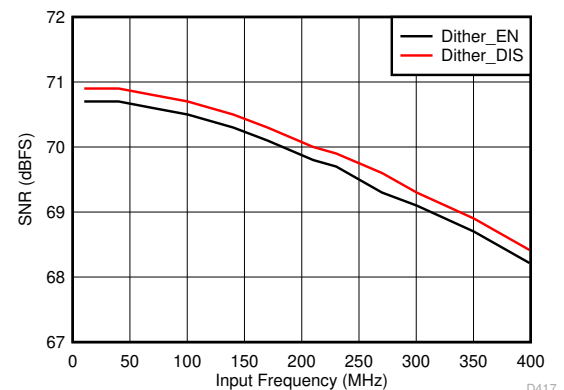

**图 6-77. Signal-to-Noise Ratio vs Input Frequency**

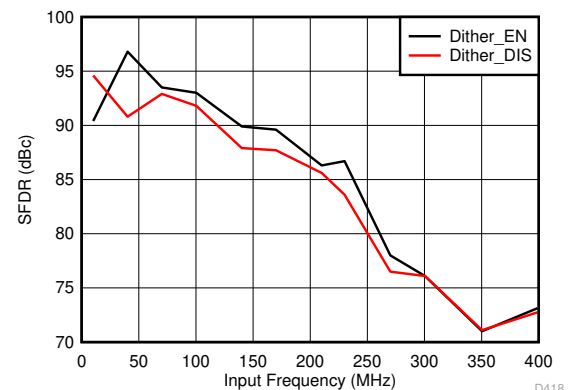

**图 6-78. Spurious-Free Dynamic Range vs Input Frequency**

### 6.17 Typical Characteristics: ADC3223 (continued)

Typical values are at  $T_A = 25^\circ\text{C}$ , ADC sampling rate = 80 MSPS, 50% clock duty cycle, AVDD = 1.8 V, DVDD = 1.8 V, -1-dBFS differential input,  $2\text{-}V_{PP}$  full-scale, 32k-point FFT, chopper disabled, and SNR reported with a 1-MHz offset from dc when chopper is disabled and from  $f_S / 2$  when chopper is enabled (unless otherwise noted).



图 6-79. Performance vs Input Amplitude (30 MHz)



图 6-80. Performance vs Input Amplitude (170 MHz)

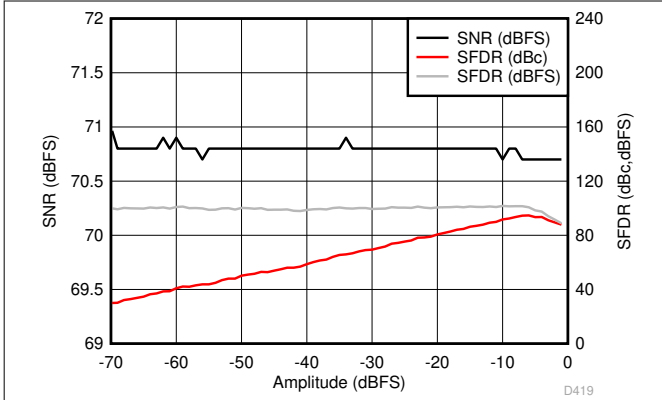

图 6-81. Performance vs Input Common-Mode Voltage (30 MHz)

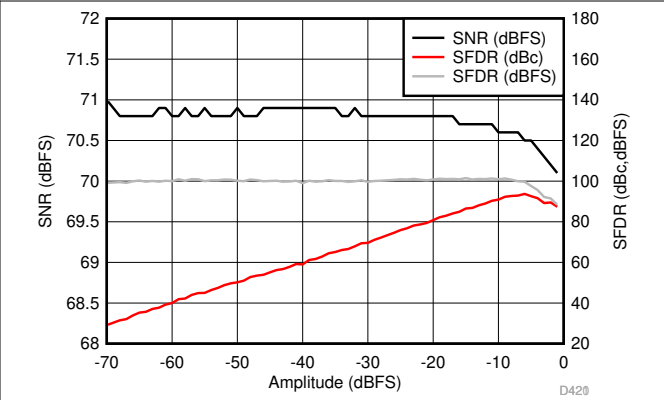

图 6-82. Performance vs Input Common-Mode Voltage (170 MHz)

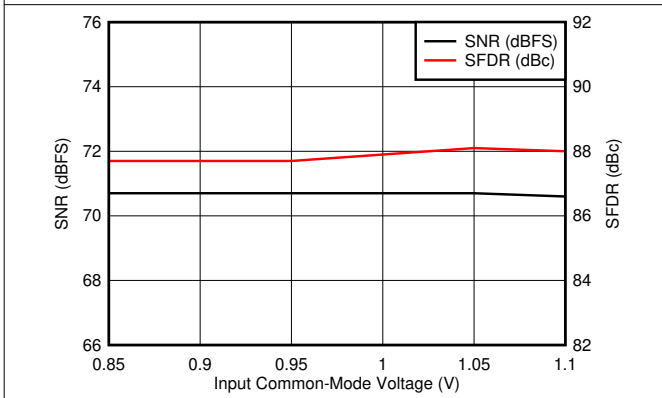

图 6-83. Spurious-Free Dynamic Range vs AVDD Supply and Temperature (170 MHz)

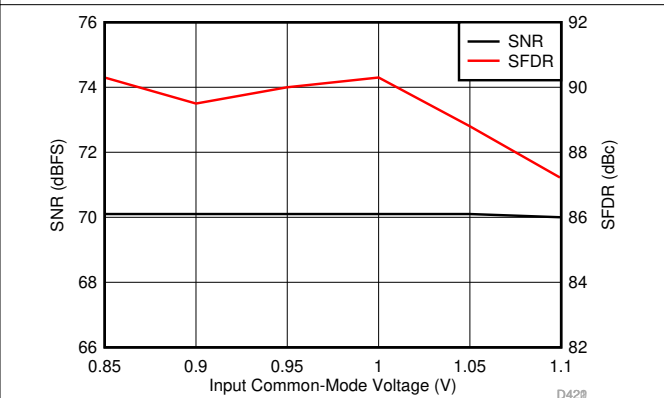

图 6-84. Signal-to-Noise Ratio vs AVDD Supply and Temperature (170 MHz)

### 6.17 Typical Characteristics: ADC3223 (continued)

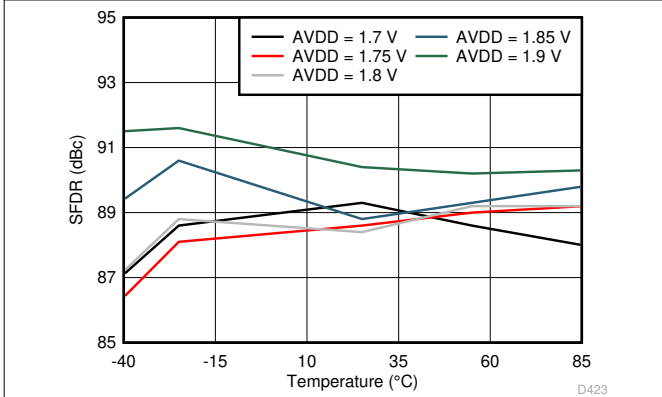
Typical values are at  $T_A = 25^\circ\text{C}$ , ADC sampling rate = 80 MSPS, 50% clock duty cycle, AVDD = 1.8 V, DVDD = 1.8 V, -1-dBFS differential input,  $2\text{-}V_{PP}$  full-scale, 32k-point FFT, chopper disabled, and SNR reported with a 1-MHz offset from dc when chopper is disabled and from  $f_S / 2$  when chopper is enabled (unless otherwise noted).

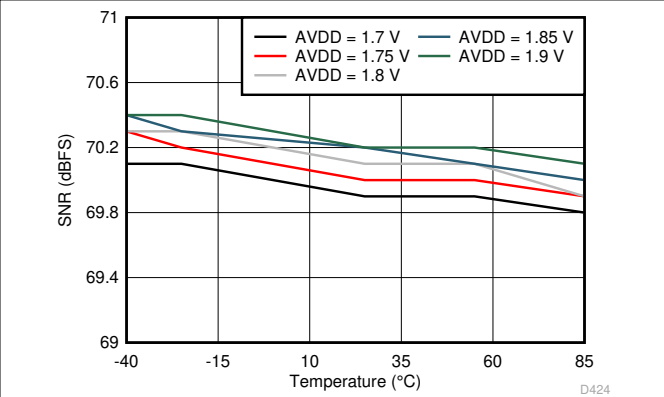

图 6-85. Spurious-Free Dynamic Range vs DVDD Supply and Temperature (170 MHz)



图 6-86. Signal-to-Noise Ratio vs DVDD Supply and Temperature (170 MHz)

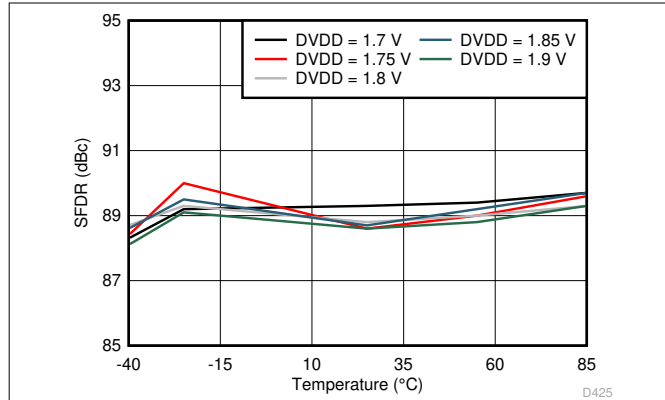

图 6-87. Performance vs Differential Clock Amplitude (40 MHz)

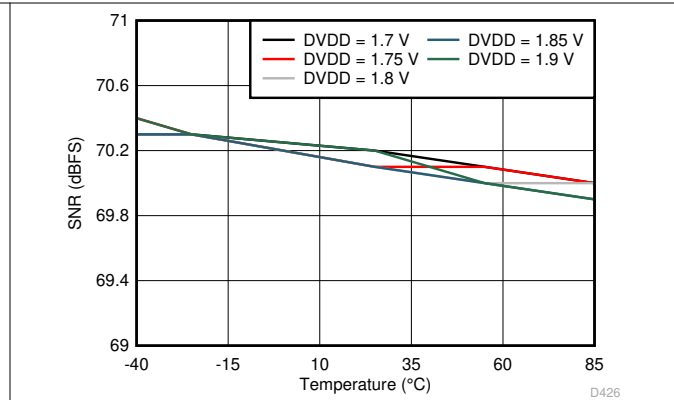

图 6-88. Performance vs Differential Clock Amplitude (150 MHz)

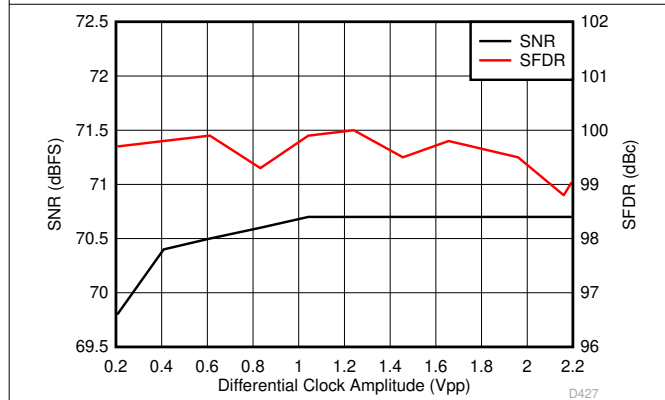

图 6-89. Performance vs Clock Duty Cycle (30 MHz)

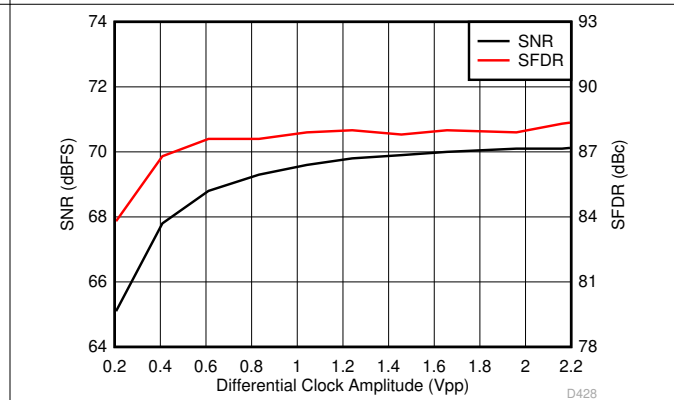

图 6-90. Performance vs Clock Duty Cycle (150 MHz)

## 6.18 Typical Characteristics: ADC3224

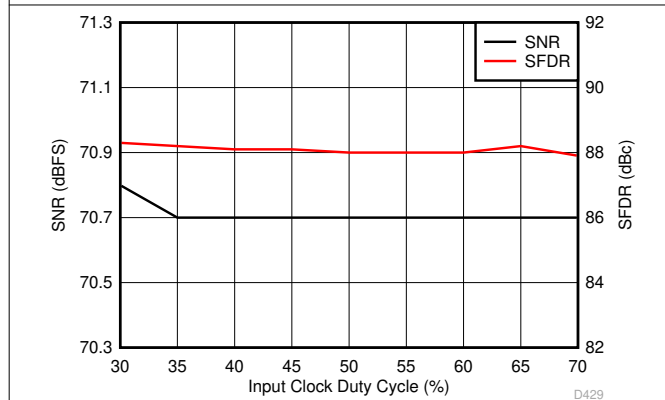
Typical values are at  $T_A = 25^\circ\text{C}$ , ADC sampling rate = 125 MSPS, 50% clock duty cycle,  $AV_{DD} = 1.8\text{ V}$ ,  $DV_{DD} = 1.8\text{ V}$ , -1-dBFS differential input,  $2-V_{PP}$  full-scale, 32k-point FFT, chopper disabled, and SNR reported with a 1-MHz offset from dc when chopper is disabled and from  $f_S / 2$  when chopper is enabled (unless otherwise noted).

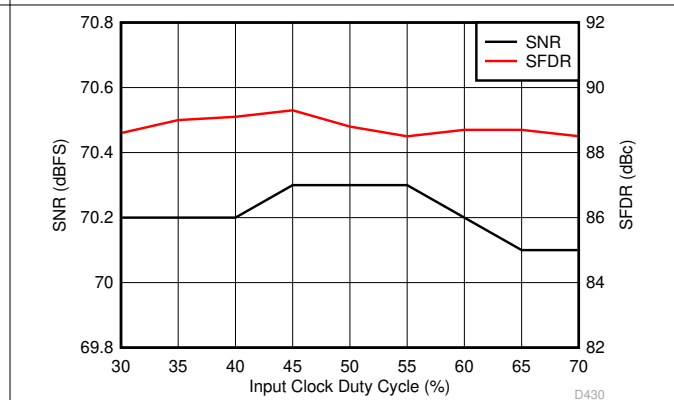
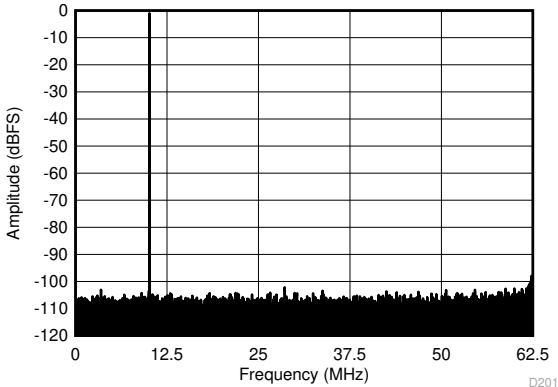

SFDR = 101.1 dBc, SNR = 70.6 dBFS, SINAD = 70.6 dBFS,  
 THD = 97.6 dBc, HD2 = 107.0 dBc, HD3 = 106.0 dBc

图 6-91. FFT for 10 MHz Input Signal (Chopper On, Dither On)

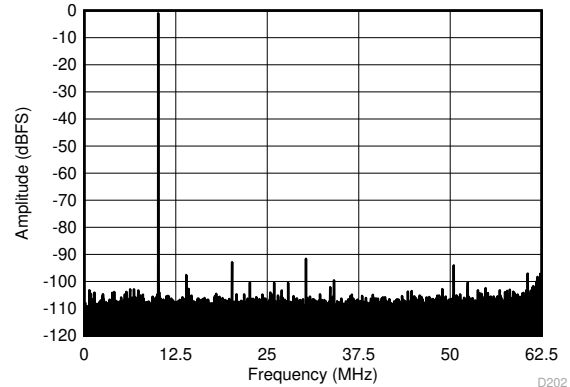

SFDR = 90.6 dBc, SNR = 70.9 dBFS, SINAD = 70.8 dBFS,  
 THD = 86 dBc, HD2 = 91.8 dBc, HD3 = 90.6 dBc

图 6-92. FFT for 10-MHz Input Signal (Chopper On, Dither Off)

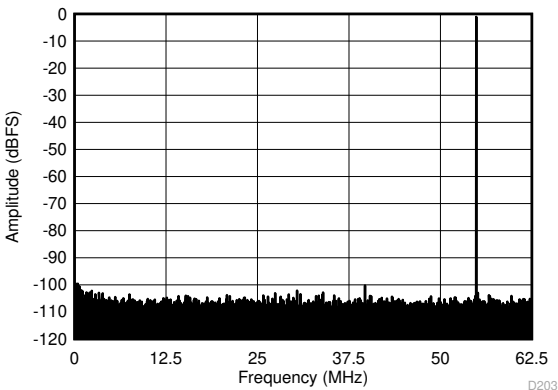

SFDR = 99.2 dBc, SNR = 70.5 dBFS, SINAD = 70.5 dBFS,  
 THD = 94.8 dBc, HD2 = 102.9 dBc, HD3 = 99.2 dBc

图 6-93. FFT for 70-MHz Input Signal (Dither On)

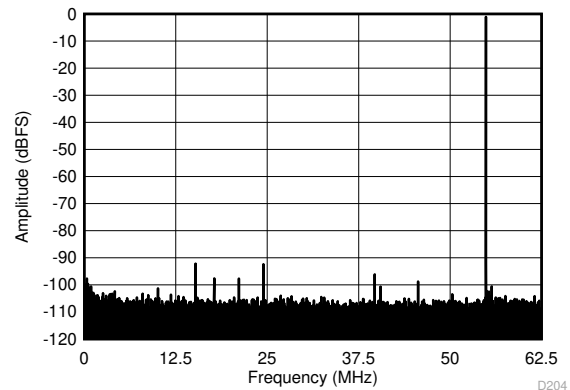

SFDR = 91.1 dBc, SNR = 70.8 dBFS, SINAD = 70.8 dBFS,  
 THD = 86.8 dBc, HD2 = 91.1 dBc, HD3 = 95.1 dBc

图 6-94. FFT for 70-MHz Input Signal (Dither Off)

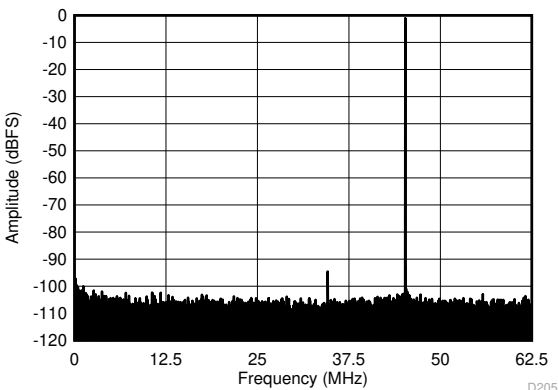

SFDR = 93.6 dBc, SNR = 70.0 dBFS, SINAD = 70.0 dBFS,  
 THD = 91.4 dBc, HD2 = 93.6 dBc, HD3 = 101.3 dBc

图 6-95. FFT for 170-MHz Input Signal (Dither On)

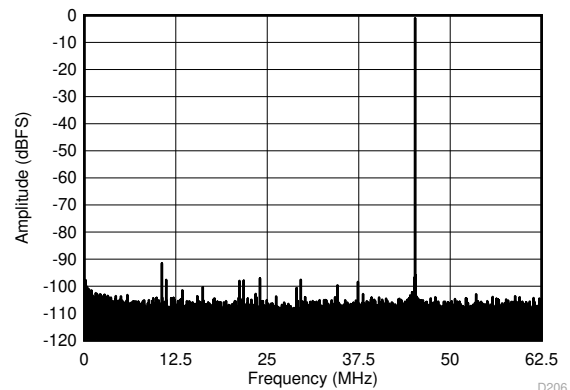

SFDR = 90.6 dBc, SNR = 70.5 dBFS, SINAD = 70.4 dBFS,  
 THD = 87.8 dBc, HD2 = 98.6 dBc, HD3 = 90.6 dBc

图 6-96. FFT for 170 MHz Input Signal (Dither Off)

## 6.18 Typical Characteristics: ADC3224 (continued)

Typical values are at  $T_A = 25^\circ\text{C}$ , ADC sampling rate = 125 MSPS, 50% clock duty cycle,  $AV_{DD} = 1.8\text{ V}$ ,  $DV_{DD} = 1.8\text{ V}$ , -1-dBFS differential input,  $2 \cdot V_{PP}$  full-scale, 32k-point FFT, chopper disabled, and SNR reported with a 1-MHz offset from dc when chopper is disabled and from  $f_S / 2$  when chopper is enabled (unless otherwise noted).

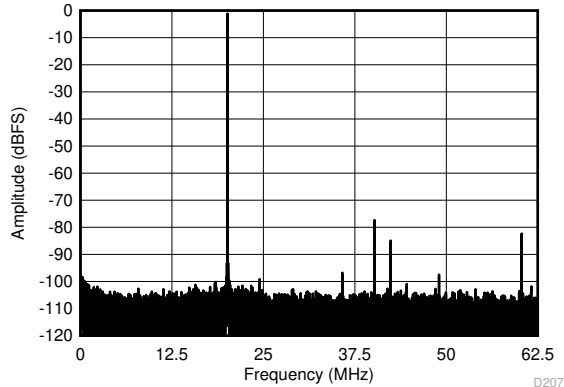

SFDR = 76.2 dBc, SNR = 69.4 dBFS, SINAD = 68.6 dBFS,  
 THD = 74.9 dBc, HD2 = 76.2 dBc, HD3 = 81.2 dBc

图 6-97. FFT for 270-MHz Input Signal (Dither On)

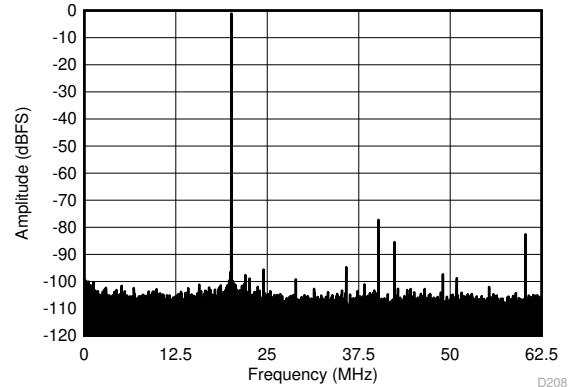

SFDR = 76.1 dBc, SNR = 69.7 dBFS, SINAD = 68.8 dBFS,  
 THD = 74.9 dBc, HD2 = 76.1 dBc, HD3 = 81.5 dBc

图 6-98. FFT for 270-MHz Input Signal (Dither Off)

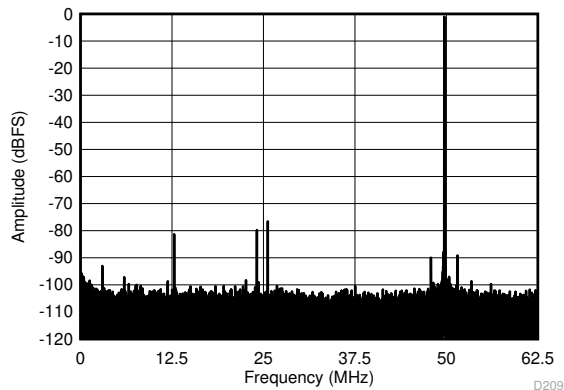

SFDR = 75.5 dBc, SNR = 67.4 dBFS, SINAD = 66.7 dBFS,  
 THD = 73.8 dBc, HD2 = 75.5 dBc, HD3 = 78.7 dBc

图 6-99. FFT for 450-MHz Input Signal (Dither On)

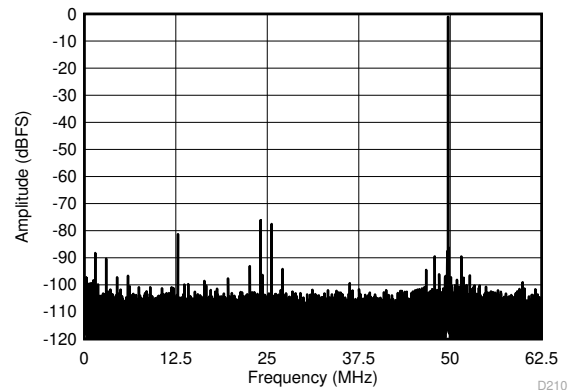

SFDR = 75.2 dBc, SNR = 68 dBFS, SINAD = 67.0 dBFS, THD  
 = 72.5 dBc, HD2 = 76.5 dBc, HD3 = 75.2 dBc

图 6-100. FFT for 450-MHz Input Signal (Dither Off)

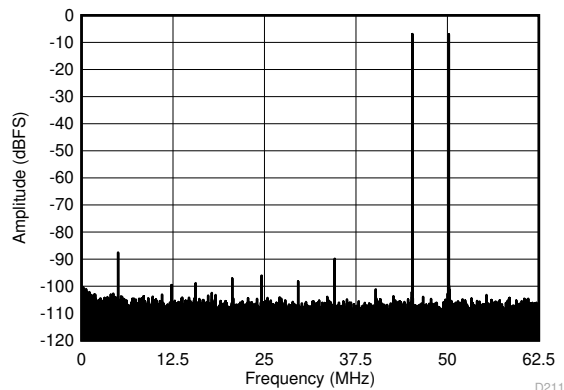

$f_{IN1} = 46\text{ MHz}$ ,  $f_{IN2} = 50\text{ MHz}$ , IMD3 = 88 dBFS, each tone at  
 -7 dBFS

图 6-101. FFT for Two-Tone Input Signal (-7 dBFS at 46 MHz and 50 MHz)

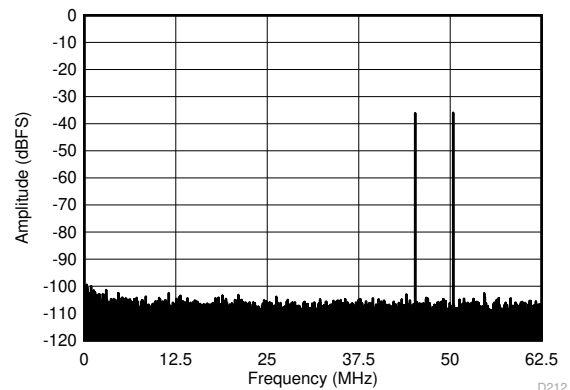

$f_{IN1} = 46\text{ MHz}$ ,  $f_{IN2} = 50\text{ MHz}$ , IMD3 = 105 dBFS, each tone at  
 -36 dBFS

图 6-102. FFT for Two-Tone Input Signal (-36 dBFS at 46 MHz and 50 MHz)

### 6.18 Typical Characteristics: ADC3224 (continued)

Typical values are at  $T_A = 25^\circ\text{C}$ , ADC sampling rate = 125 MSPS, 50% clock duty cycle,  $AV_{DD} = 1.8\text{ V}$ ,  $DV_{DD} = 1.8\text{ V}$ , -1-dBFS differential input,  $2\text{-}V_{PP}$  full-scale, 32k-point FFT, chopper disabled, and SNR reported with a 1-MHz offset from dc when chopper is disabled and from  $f_S / 2$  when chopper is enabled (unless otherwise noted).

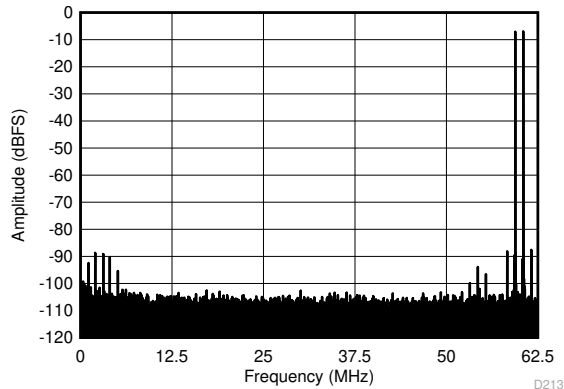

$f_{IN1} = 185\text{ MHz}$ ,  $f_{IN2} = 190\text{ MHz}$ ,  $\text{IMD3} = 87.5\text{ dBFS}$ , each tone at -7 dBFS

**图 6-103. FFT for Two-Tone Input Signal (-7 dBFS at 185 MHz and 190 MHz)**

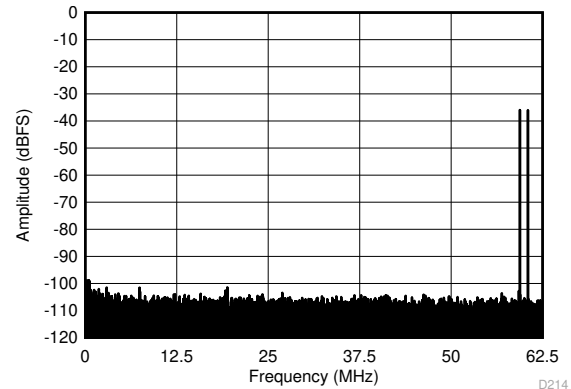

$f_{IN1} = 185\text{ MHz}$ ,  $f_{IN2} = 190\text{ MHz}$ ,  $\text{IMD3} = 96.5\text{ dBFS}$ , each tone at -36 dBFS

**图 6-104. FFT for Two-Tone Input Signal (-36 dBFS at 185 MHz and 190 MHz)**

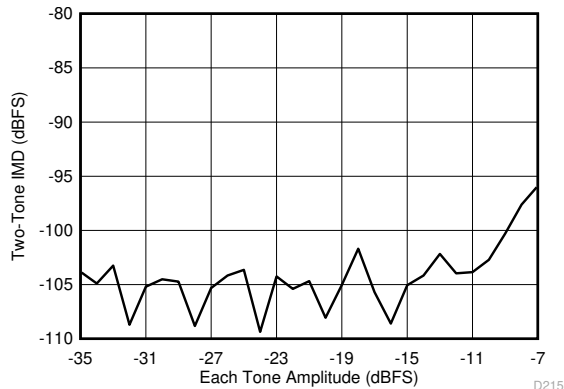

**图 6-105. Intermodulation Distortion vs Input Amplitude (46 MHz and 50 MHz)**

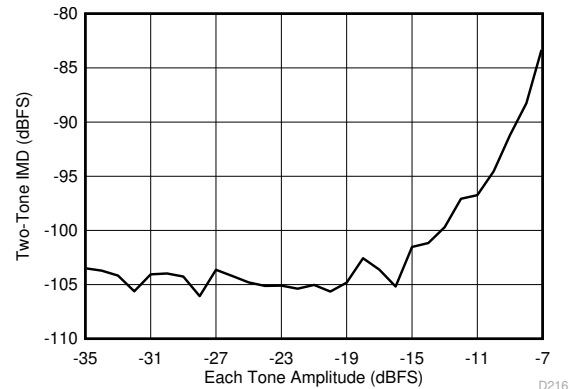

**图 6-106. Intermodulation Distortion vs Input Amplitude (185 MHz and 190 MHz)**

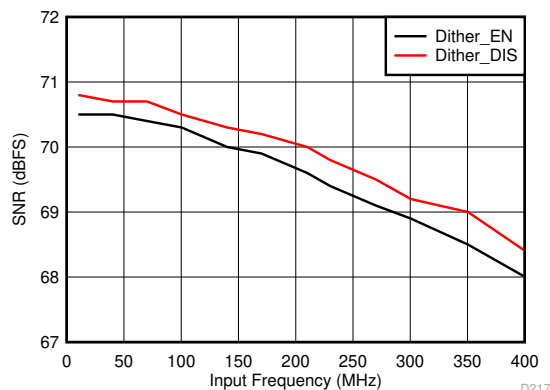

**图 6-107. Signal-to-Noise Ratio vs Input Frequency**

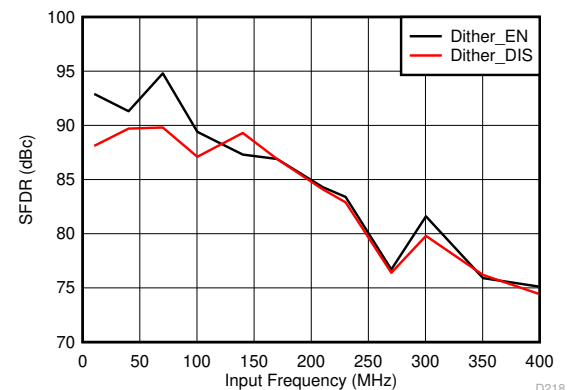

**图 6-108. Spurious-Free Dynamic Range vs Input Frequency**

### 6.18 Typical Characteristics: ADC3224 (continued)

Typical values are at  $T_A = 25^\circ\text{C}$ , ADC sampling rate = 125 MSPS, 50% clock duty cycle,  $AV_{DD} = 1.8\text{ V}$ ,  $DV_{DD} = 1.8\text{ V}$ , -1-dBFS differential input,  $2\text{-}V_{PP}$  full-scale, 32k-point FFT, chopper disabled, and SNR reported with a 1-MHz offset from dc when chopper is disabled and from  $f_S / 2$  when chopper is enabled (unless otherwise noted).



图 6-109. Performance vs Input Amplitude (30 MHz)



图 6-110. Performance vs Input Amplitude (170 MHz)

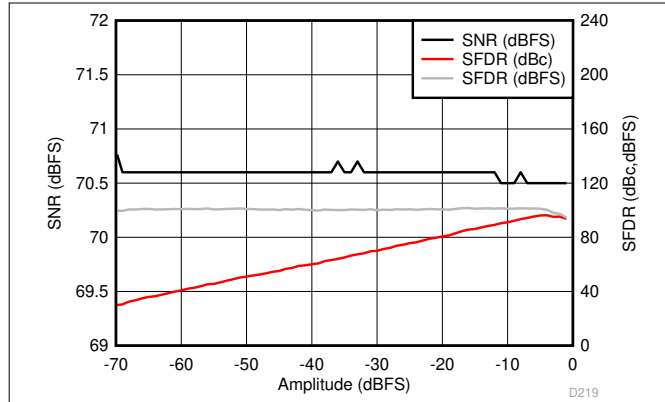

图 6-111. Performance vs Input Common-Mode Voltage (30 MHz)

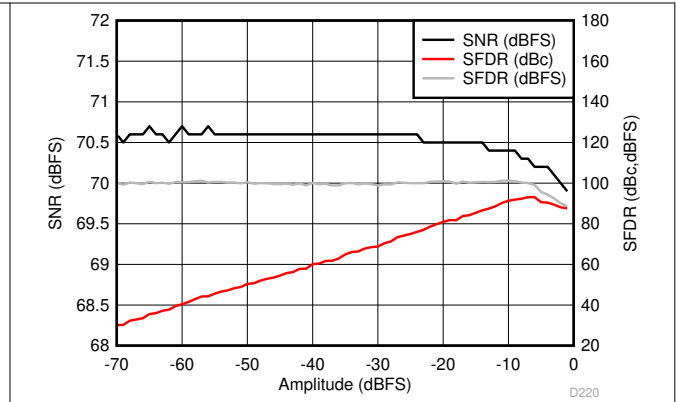

图 6-112. Performance vs Input Common-Mode Voltage (170 MHz)

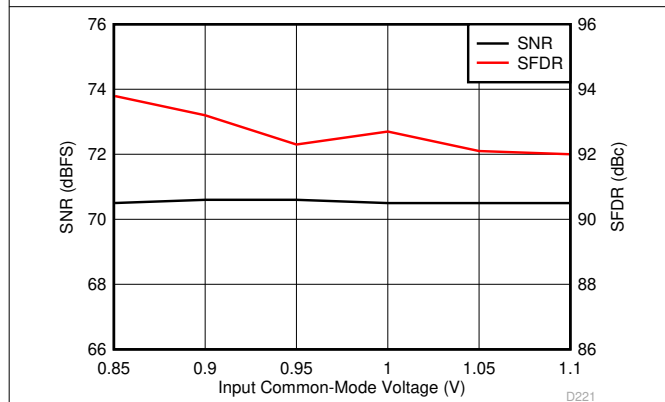

图 6-113. Spurious-Free Dynamic Range vs AVDD Supply and Temperature (170 MHz)

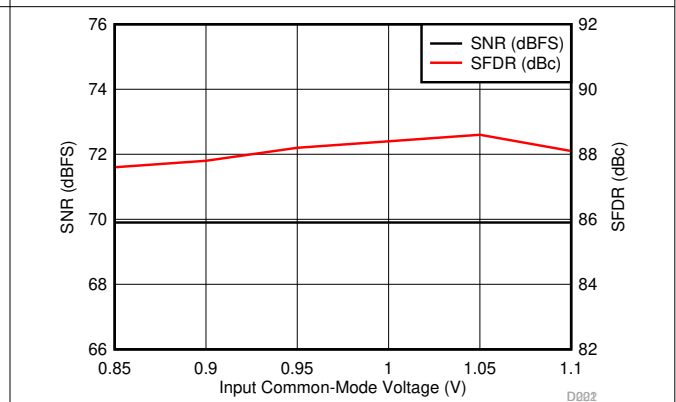

图 6-114. Signal-to-Noise Ratio vs AVDD Supply and Temperature (170 MHz)

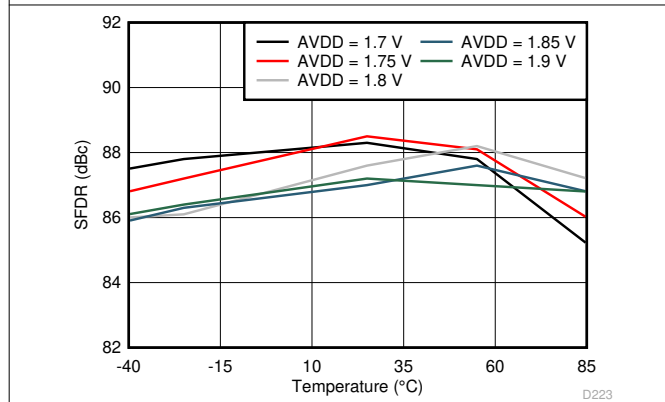

### 6.18 Typical Characteristics: ADC3224 (continued)

Typical values are at  $T_A = 25^\circ\text{C}$ , ADC sampling rate = 125 MSPS, 50% clock duty cycle, AVDD = 1.8 V, DVDD = 1.8 V, -1-dBFS differential input,  $2\text{-}V_{PP}$  full-scale, 32k-point FFT, chopper disabled, and SNR reported with a 1-MHz offset from dc when chopper is disabled and from  $f_S / 2$  when chopper is enabled (unless otherwise noted).

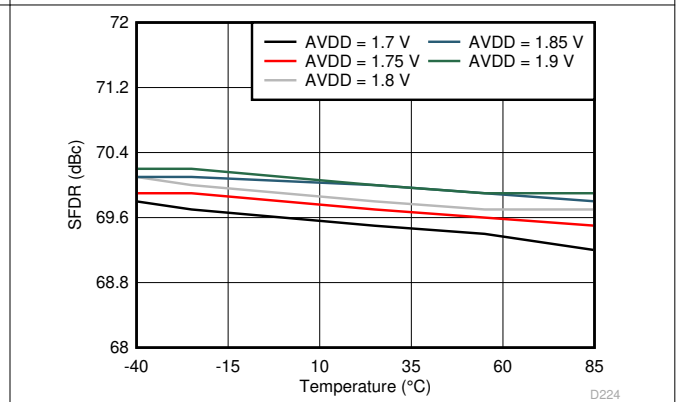

图 6-115. Spurious-Free Dynamic Range vs DVDD Supply and Temperature (170 MHz)



图 6-116. Signal-to-Noise Ratio vs DVDD Supply and Temperature (170 MHz)

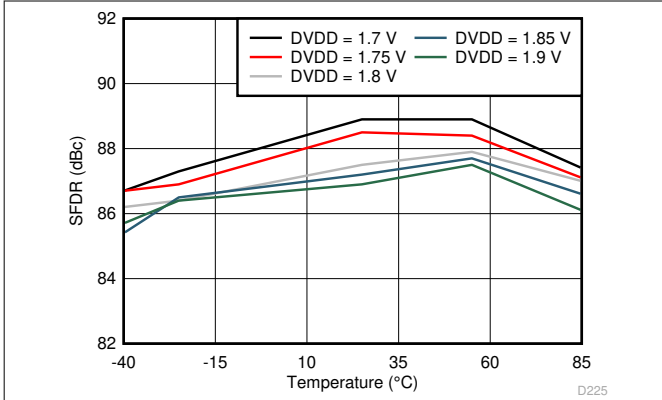

图 6-117. Performance vs Differential Clock Amplitude (40 MHz)

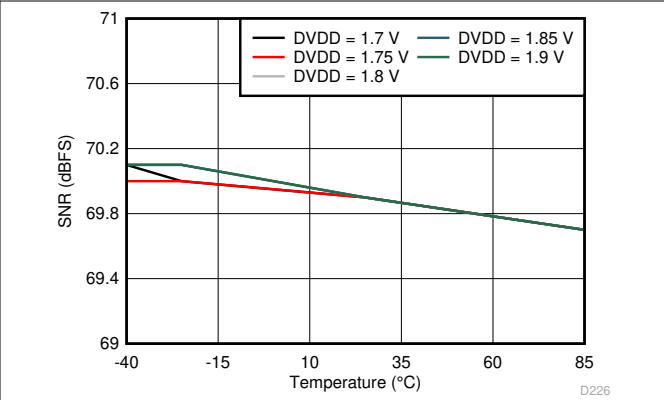

图 6-118. Performance vs Differential Clock Amplitude (150 MHz)

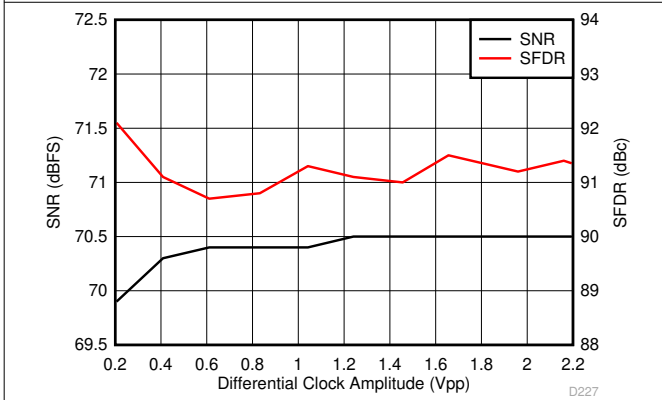

图 6-119. Performance vs Clock Duty Cycle (30 MHz)

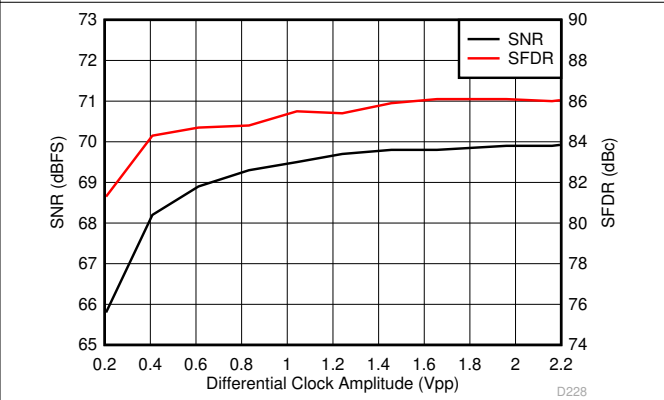

图 6-120. Performance vs Clock Duty Cycle (150 MHz)

## 6.19 Typical Characteristics: Common

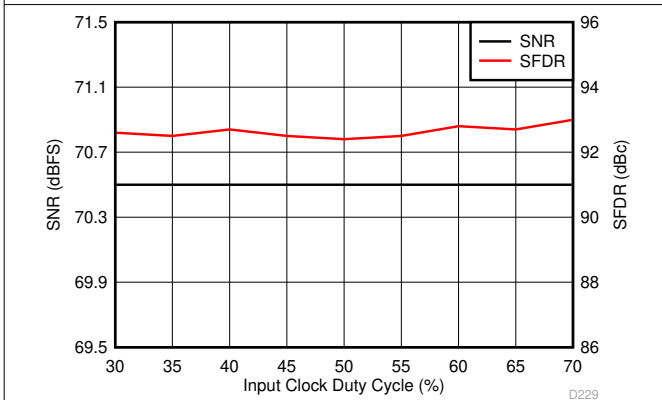
Typical values are at  $T_A = 25^\circ\text{C}$ , ADC sampling rate = 125 MSPS, 50% clock duty cycle,  $AV_{DD} = 1.8\text{ V}$ ,  $DV_{DD} = 1.8\text{ V}$ , -1-dBFS differential input,  $2 \cdot V_{PP}$  full-scale, 32k-point FFT, chopper disabled, and SNR reported with a 1-MHz offset from dc when chopper is disabled and from  $f_S / 2$  when chopper is enabled (unless otherwise noted).

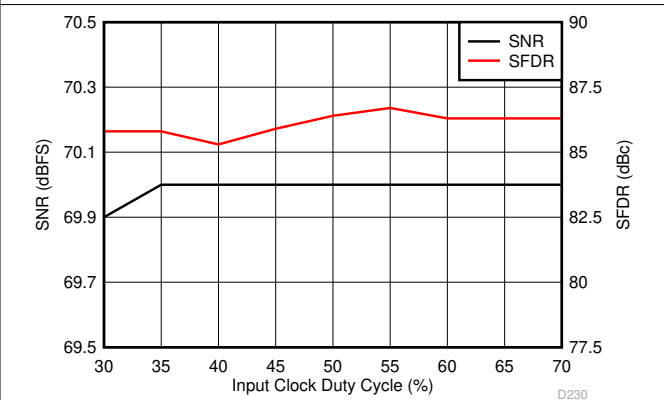
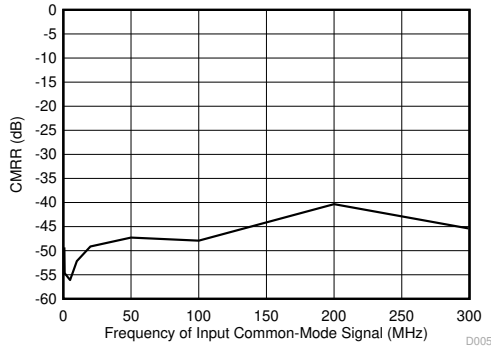

$f_{IN} = 30\text{ MHz}$ ,  $A_{IN} = -1\text{ dBFS}$ , common-mode signal amplitude =  $50\text{ mV}_{PP}$

图 6-121. Common-Mode Rejection Ratio vs Common-Mode Signal Frequency

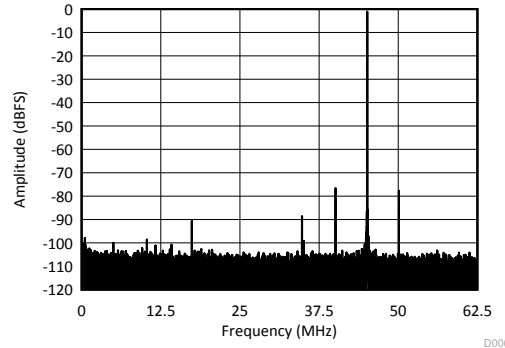

$f_{IN} = 170.1\text{ MHz}$ ,  $f_{CMRR} = 5\text{ MHz}$ ,  $A_{CMRR} = 50\text{ mV}_{PP}$ , SINAD = 69.66 dBFS, SFDR = 75.66 dBc

图 6-122. Common-Mode Rejection Ratio Spectrum

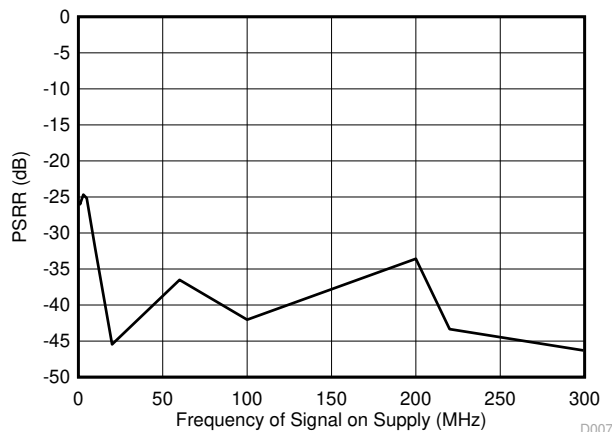

$f_{IN} = 30\text{ MHz}$ ,  $A_{IN} = -1\text{ dBFS}$ , test signal amplitude =  $50\text{ mV}_{PP}$

图 6-123. Power-Supply Rejection Ratio vs Power-Supply Signal Frequency

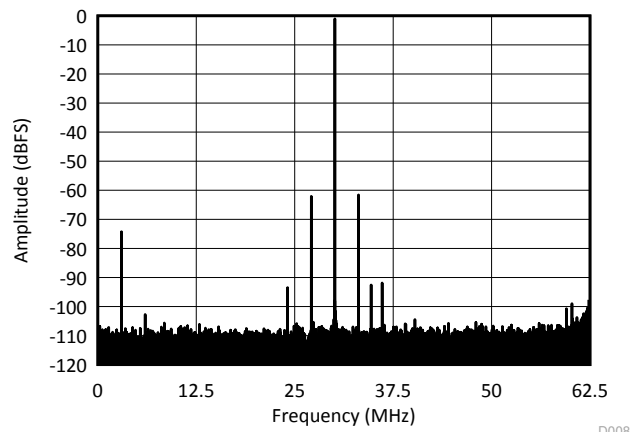

$f_{IN} = 30.1\text{ MHz}$ ,  $f_{PSRR} = 3\text{ MHz}$ ,  $A_{PSRR} = 50\text{ mV}_{PP}$ , SINAD = 58.51 dBFS, SFDR = 60.53 dBc

图 6-124. Power-Supply Rejection Ratio Spectrum



图 6-125. Power vs Sampling Speed (One-Wire Mode)

## 6.20 Typical Characteristics: Contour

Typical values are at  $T_A = 25^\circ\text{C}$ , ADC sampling rate = 125 MSPS, 50% clock duty cycle,  $AV_{DD} = 1.8\text{ V}$ ,  $DV_{DD} = 1.8\text{ V}$ , -1-dBFS differential input,  $2 \cdot V_{PP}$  full-scale, 32k-point FFT, chopper disabled, and SNR reported with a 1-MHz offset from dc when chopper is disabled and from  $f_S / 2$  when is chopper enabled (unless otherwise noted).

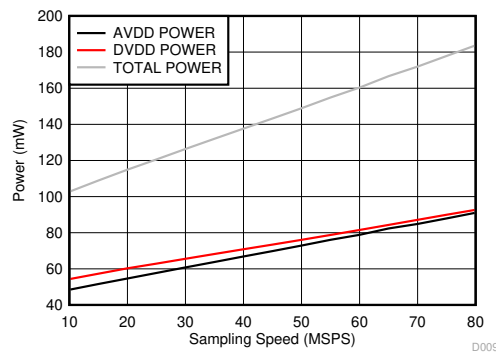

图 6-126. Spurious-Free Dynamic Range (SFDR)



图 6-127. Signal-to-Noise Ratio (SNR)

## 7 Parameter Measurement Information

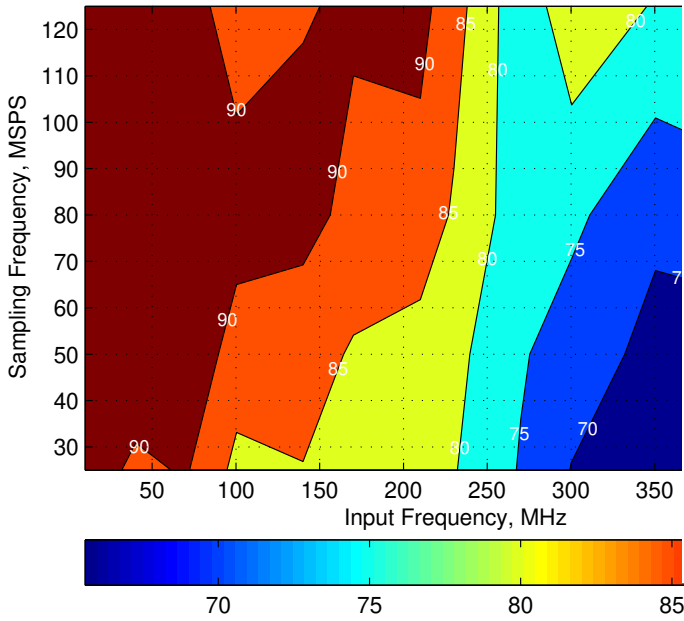
### 7.1 Timing Diagrams

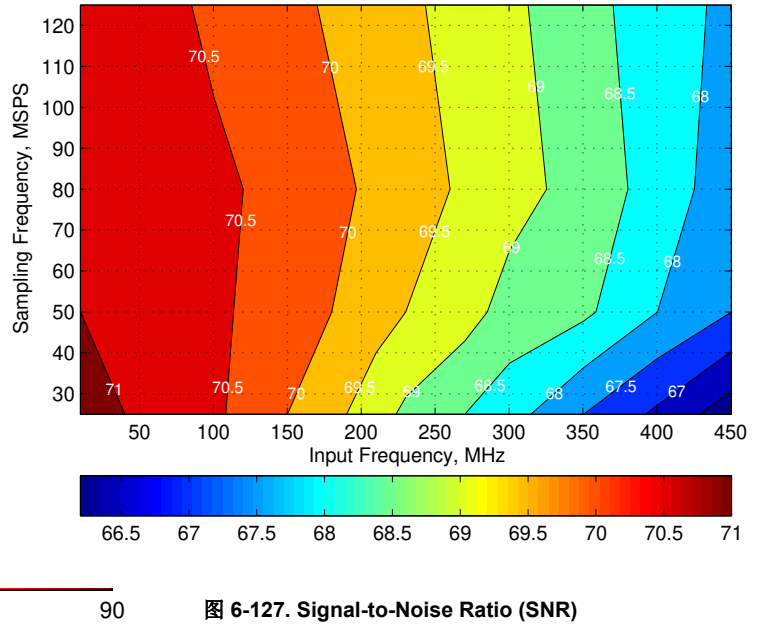
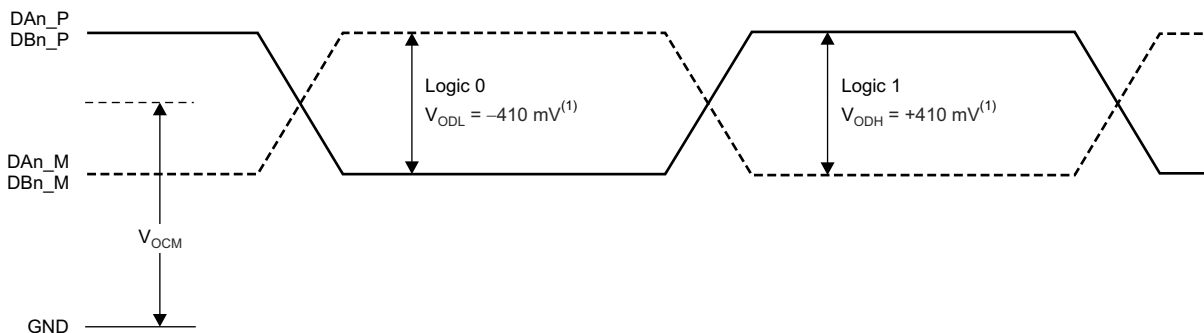

A. With an external 100-Ω termination.

图 7-1. Serial LVDS Output Voltage Levels



图 7-2. Output Timing Diagram



**图 7-3. Setup and Hold Time**

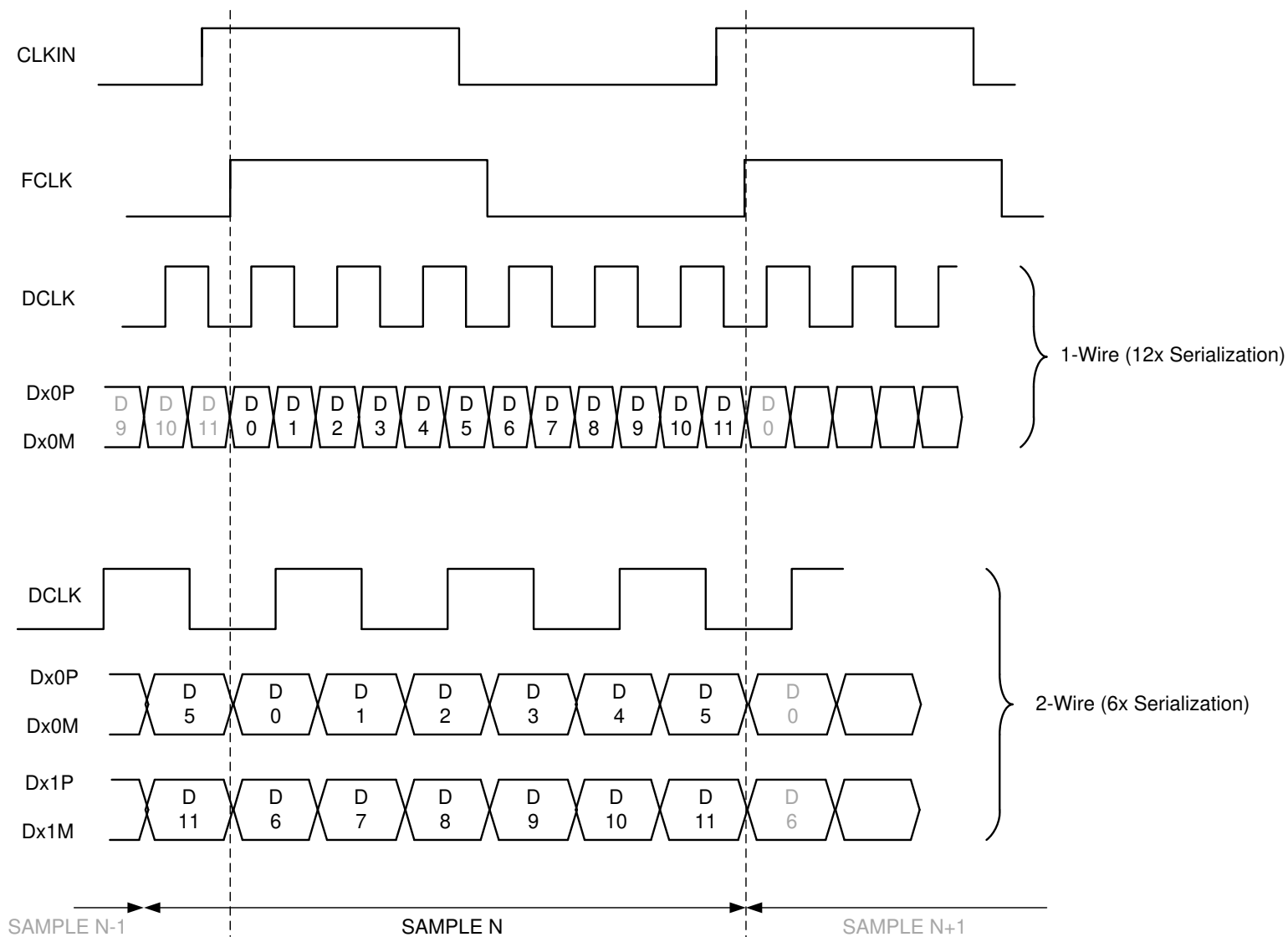
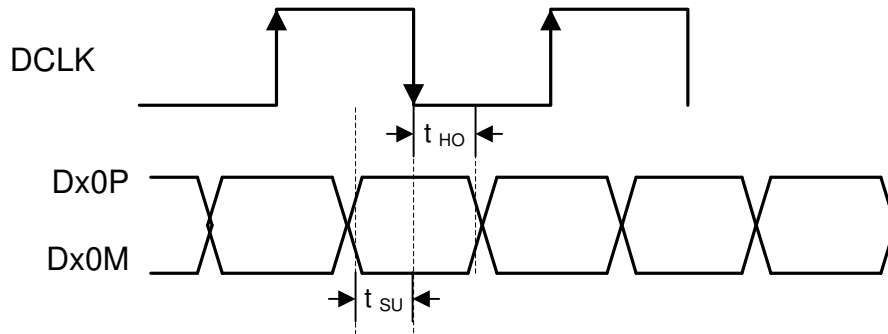
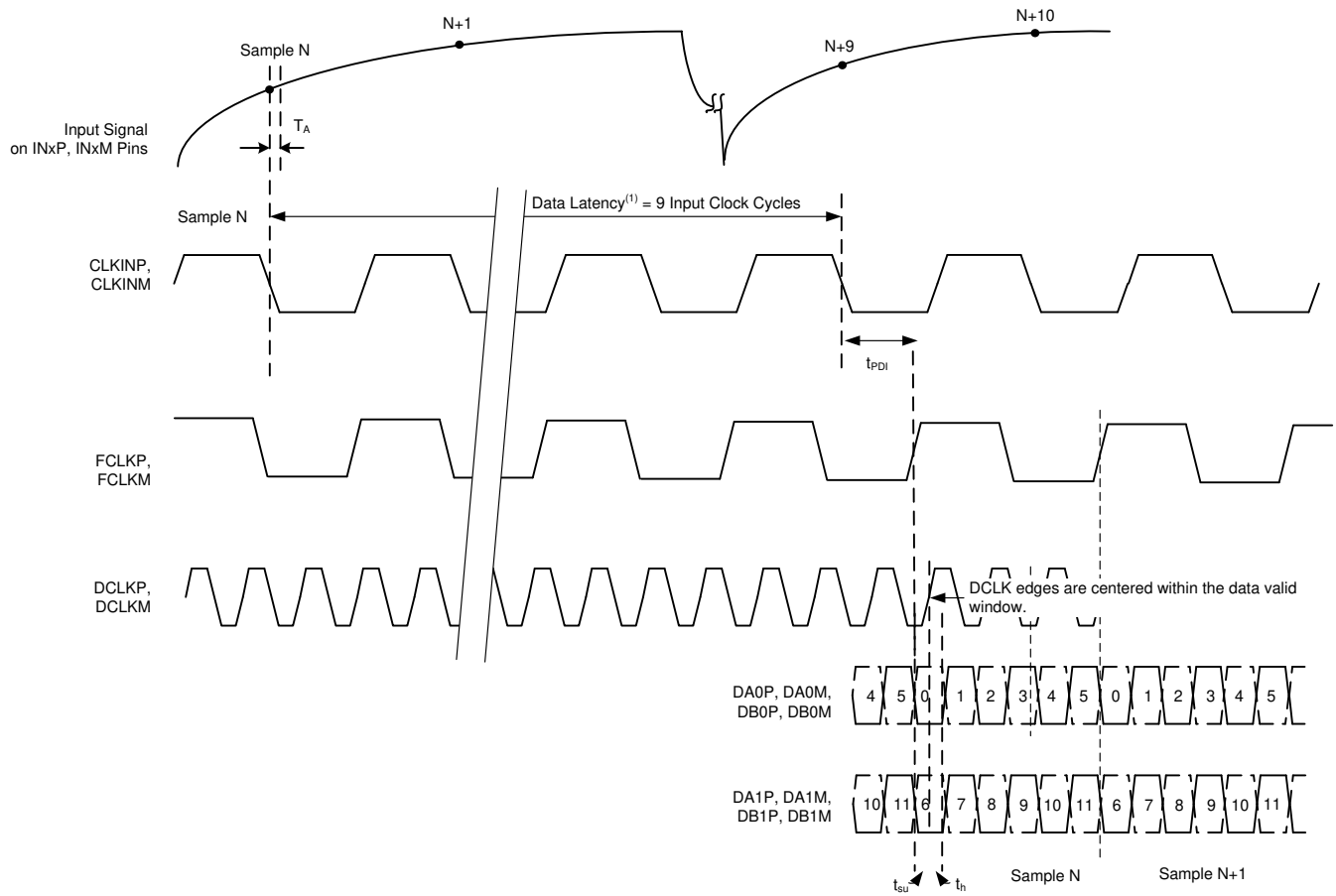

A. Overall latency = data latency +  $t_{PDI}$ .

**图 7-4. Latency Diagram**

## 8 Detailed Description

### 8.1 Overview

The devices are designed specifically to support demanding, high input frequency signals with large dynamic range requirements. An input clock divider allows more flexibility for system clock architecture design while the SYSREF input enables complete system synchronization by resetting the clock divider. The ADC322x family supports serial LVDS interface in order to reduce the number of interface lines, thus allowing for high system integration density. The serial LVDS interface is two-wire, where each ADC data are serialized and output over two LVDS pairs. An internal phase-locked loop (PLL) multiplies the incoming ADC sampling clock to derive the bit clock that is used to serialize the 14-bit output data from each channel. In addition to the serial data streams, the frame and bit clocks are also transmitted as LVDS outputs.

### 8.2 Functional Block Diagram

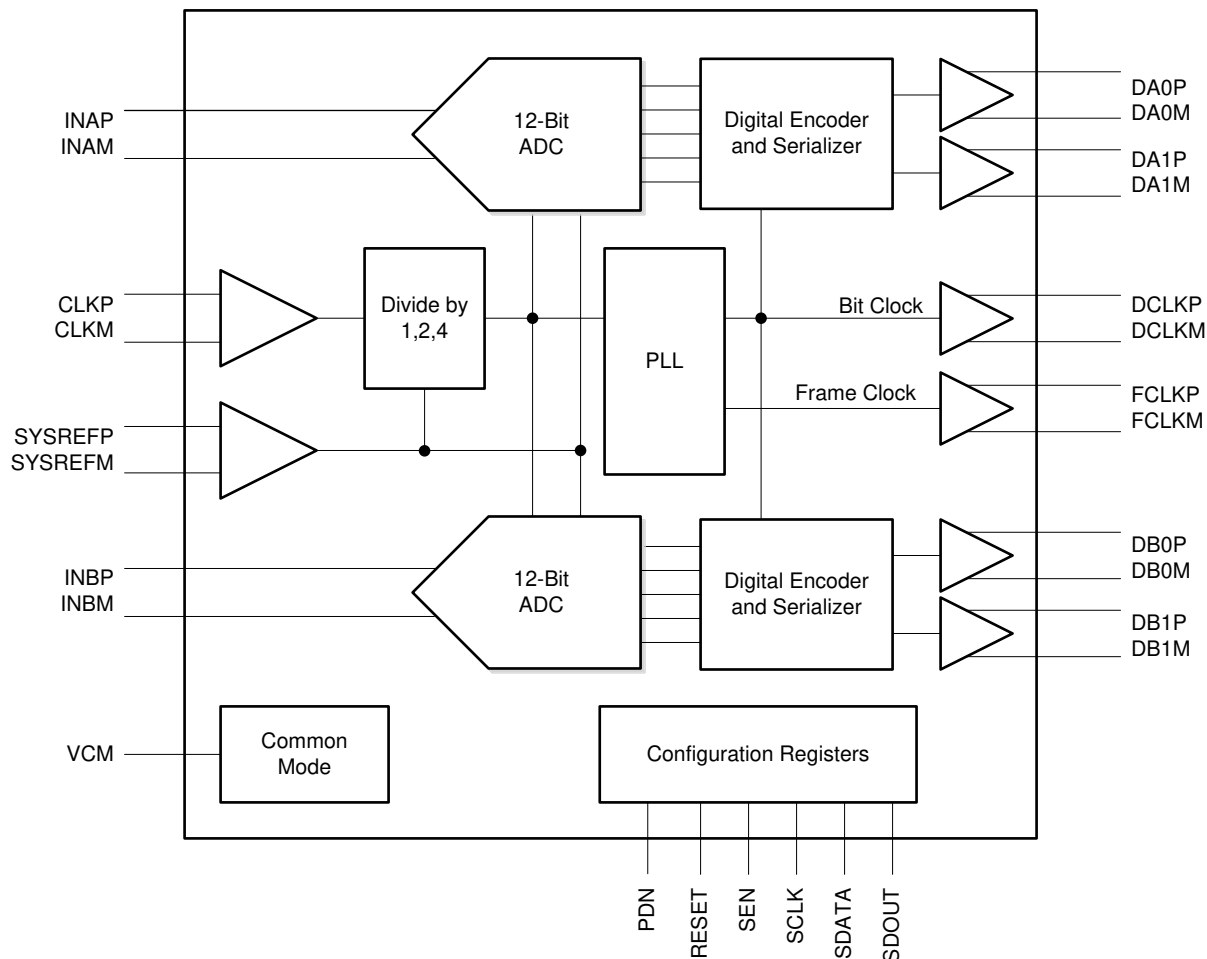

## 8.3 Feature Description

### 8.3.1 Analog Inputs

The ADC322x analog signal inputs are designed to be driven differentially. Each input pin (INP, INM) must swing symmetrically between  $(V_{CM} + 0.5\text{ V})$  and  $(V_{CM} - 0.5\text{ V})$ , resulting in a  $2\text{-}V_{PP}$  (default) differential input swing. The input sampling circuit has a 3-dB bandwidth that extends up to 540 MHz ( $50\text{-}\Omega$  source driving a  $50\text{-}\Omega$  termination between INP and INM).

### 8.3.2 Clock Input

The device clock inputs can be driven differentially (sine, LVPECL, or LVDS) or single-ended (LVCMOS), with little or no difference in performance between them. The common-mode voltage of the clock inputs is set to 0.95 V using internal  $5\text{-k}\Omega$  resistors. The self-bias clock inputs of the ADC322x can be driven by the transformer-coupled, sine-wave clock source or by the ac-coupled, LVPECL and LVDS clock sources, as shown in [图 8-1](#), [图 8-2](#), and [图 8-3](#). See [图 8-4](#) for details regarding the internal clock buffer.

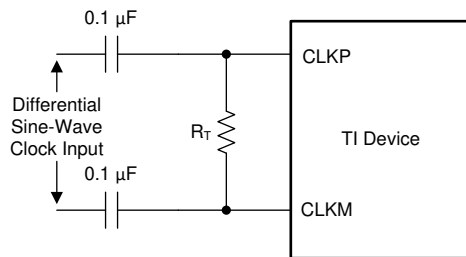

$R_T$  = termination resistor, if necessary.

**图 8-1. Differential Sine-Wave Clock Driving Circuit**

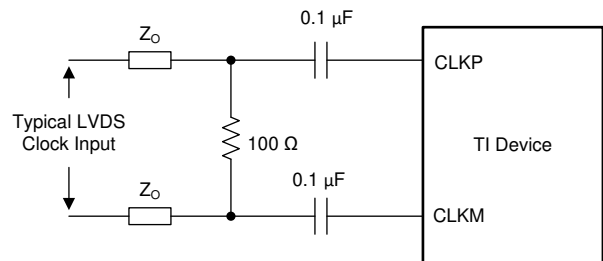

**图 8-2. LVDS Clock Driving Circuit**

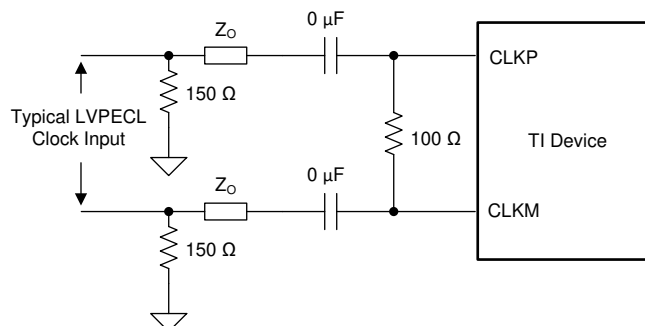

**图 8-3. LVPECL Clock Driving Circuit**

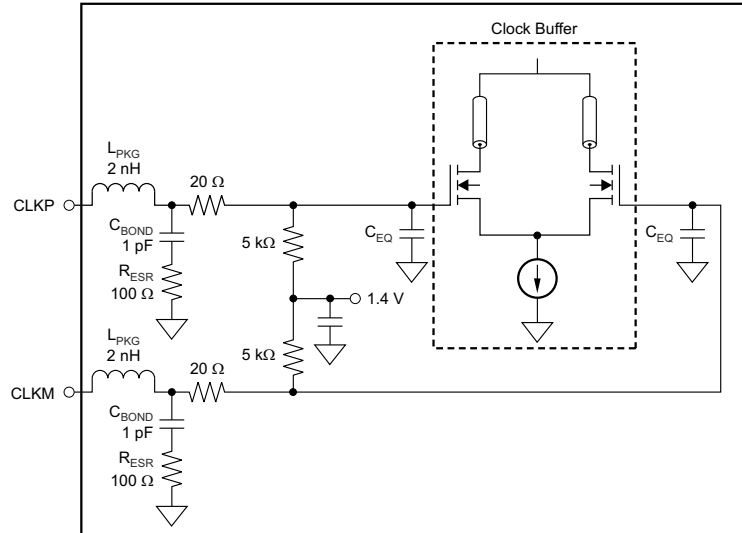

$C_{EQ}$  is 1 pF to 3 pF and is the equivalent input capacitance of the clock buffer.

**图 8-4. Internal Clock Buffer**

A single-ended CMOS clock can be ac-coupled to the CLKP input, with CLKM connected to ground with a 0.1- $\mu$ F capacitor, as shown in 图 8-5. However, for best performance the clock inputs must be driven differentially, thereby reducing susceptibility to common-mode noise. For high input frequency sampling, TI recommends using a clock source with very low jitter. Band-pass filtering of the clock source can help reduce the effects of jitter. There is no change in performance with a non-50% duty cycle clock input.

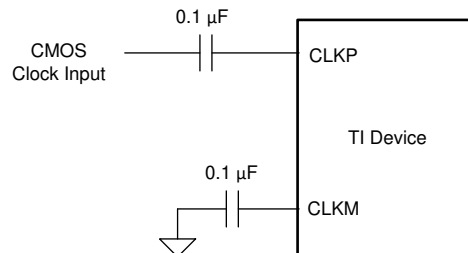

**图 8-5. Single-Ended Clock Driving Circuit**



### 8.3.2.1 Using the SYSREF Input

The ADC344x has a SYSREF input pin that can be used when the clock-divider feature is used. A logic low-to-high transition on the SYSREF pin aligns the falling edge of the divided clock with the next falling edge of the input clock, essentially resetting the phase of the divided clock, as shown in 图 8-6. When multiple ADC344x devices are onboard and the clock divider option is used, the phase of the divided clock among the devices may not be the same. The phase of the divided clock in each device can be synchronized to the common sampling clock by using the SYSREF pins. SYSREF can be applied as mono-shot or periodic waveform. When applied as periodic waveform, its period must be an integer multiple of the period of the divided clock. When not used, the SYSREFP and SYSREFM pins can be connected to AVDD and GND, respectively. Alternatively, the SYSREF buffer inside the device can be powered down using the PDN SYSREF register bit.



图 8-6. Using SYSREF for Synchronization

### 8.3.2.2 SNR and Clock Jitter

The signal-to-noise ratio of the ADC is limited by three different factors, as shown in 方程式 1. Quantization noise (typically 74 dB for a 12-bit ADC) and thermal noise limit SNR at low input frequencies, and clock jitter sets SNR for higher input frequencies.

$$\text{SNR}_{\text{ADC}}[\text{dBc}] = -20 \cdot \log \sqrt{\left(10^{\frac{\text{SNR}_{\text{Quantization\_Noise}}}{20}}\right)^2 + \left(10^{\frac{\text{SNR}_{\text{Thermal\_Noise}}}{20}}\right)^2 + \left(10^{\frac{\text{SNR}_{\text{Jitter}}}{20}}\right)^2} \quad (1)$$

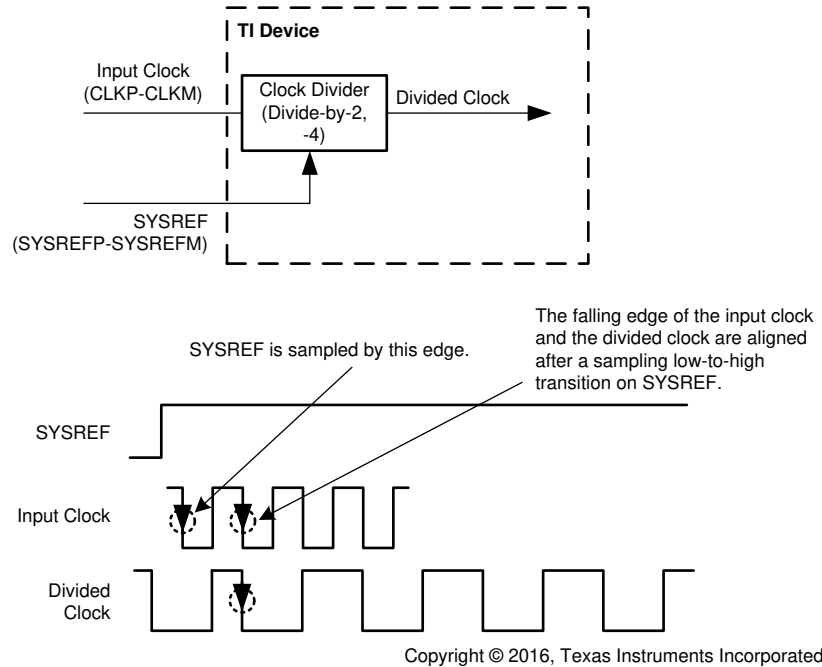
The SNR limitation resulting from sample clock jitter can be calculated with 方程式 2.

$$\text{SNR}_{\text{Jitter}}[\text{dBc}] = -20 \cdot \log(2\pi \cdot f_{\text{in}} \cdot t_{\text{Jitter}}) \quad (2)$$

The total clock jitter ( $T_{\text{Jitter}}$ ) has two components: the internal aperture jitter (130 fs for the device), which is set by the noise of the clock input buffer, and the external clock.  $T_{\text{Jitter}}$  can be calculated with 方程式 3.

$$t_{\text{Jitter}} = \sqrt{\left(t_{\text{Jitter,Ext.Clock\_Input}}\right)^2 + \left(t_{\text{Aperture\_ADC}}\right)^2} \quad (3)$$

External clock jitter can be minimized by using high-quality clock sources and jitter cleaners as well as band-pass filters at the clock input and a faster clock slew rate improves ADC aperture jitter. The devices have a typical thermal noise of 73.5 dBFS and an internal aperture jitter of 130 fs. The SNR, depending on the amount of external jitter for different input frequencies. 图 8-7 shows SNR (from 1 MHz offset leaving the 1/f flicker noise) for different jitter of clock driver.



图 8-7. SNR vs Frequency for Different Clock Jitter

### 8.3.3 Digital Output Interface

The devices offer two different output format options, thus making interfacing to a field-programmable gate array (FPGA) or an application-specific integrated circuit (ASIC) easy. Each option can be easily programmed using the serial interface, as shown in 表 8-1. The output interface options are:

- One-wire, 1X frame clock, 12X serialization with the DDR bit clock and
- Two-wire, 1X frame clock, 6X serialization with the DDR bit clock.

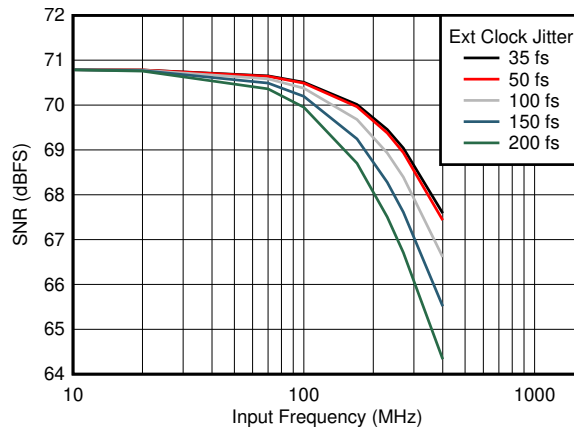
表 8-1. Interface Rates

INTERFACE OPTIONS	SERIALIZATION	MAXIMUM RECOMMENDED SAMPLING FREQUENCY (MSPS)		BIT CLOCK FREQUENCY (MHz)	FRAME CLOCK FREQUENCY (MHz)	SERIAL DATA RATE PER WIRE (Mbps)
		MIN	MAX			
One-wire	12X	15 <sup>(1)</sup>		90	15	180
			65	390	65	780
Two-wire	6X	20 <sup>(1)</sup>		60	20	120
			125	375	125	750

(1) Use the LOW SPEED ENABLE register bits for low speed operation; see 表 8-20.

#### 8.3.3.1 One-Wire Interface: 12X Serialization

In this interface option, the device outputs the data of each ADC serially on a single LVDS pair (one-wire). The data are available at the rising and falling edges of the bit clock (DDR bit clock). The ADC outputs a new word at the rising edge of every frame clock, starting with the MSB. The data rate is a 12X sample frequency (12X serialization).

### 8.3.3.2 Two-Wire Interface: 6X Serialization

The two-wire interface is recommended for sampling frequencies above 65 MSPS. The output data rate is a 6X sample frequency because six data bits are output every clock cycle on each differential pair. Each ADC sample is sent over the two wires with the six MSBs on Dx1P, Dx1M and the six LSBs on Dx0P, Dx0M, as shown in [Figure 8-8](#).

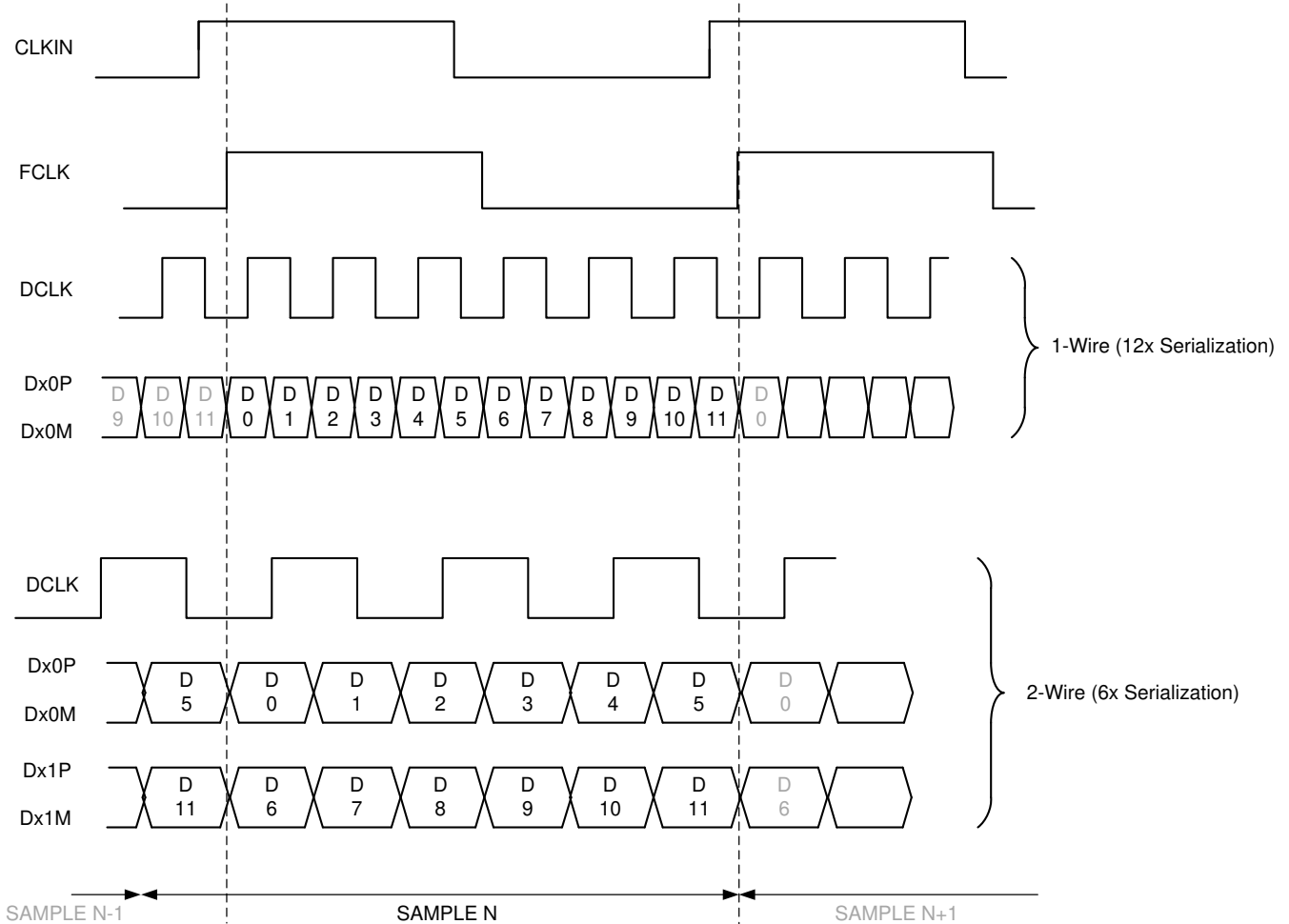

**图 8-8. Output Timing Diagram**

## 8.4 Device Functional Modes

### 8.4.1 Input Clock Divider

The devices are equipped with an internal divider on the clock input. The clock divider allows operation with a faster input clock, thus simplifying the system clock distribution design. The clock divider can be bypassed for operation with a 125-MHz clock; the divide-by-2 option supports a maximum input clock of 250 MHz and the divide-by-4 option provides a maximum input clock frequency of 500 MHz.

### 8.4.2 Chopper Functionality

The devices are equipped with an internal chopper front-end. Enabling the chopper function swaps the ADC noise spectrum by shifting the  $1/f$  noise from dc to  $f_S / 2$ . [图 8-9](#) shows the noise spectrum with the chopper off and [图 8-10](#) shows the noise spectrum with the chopper on. This function is especially useful in applications requiring good ac performance at low input frequencies or in dc-coupled applications. The chopper can be enabled via SPI register writes and is recommended for input frequencies below 30 MHz. The chopper function creates a spur at  $f_S / 2$  that must be filtered out digitally.

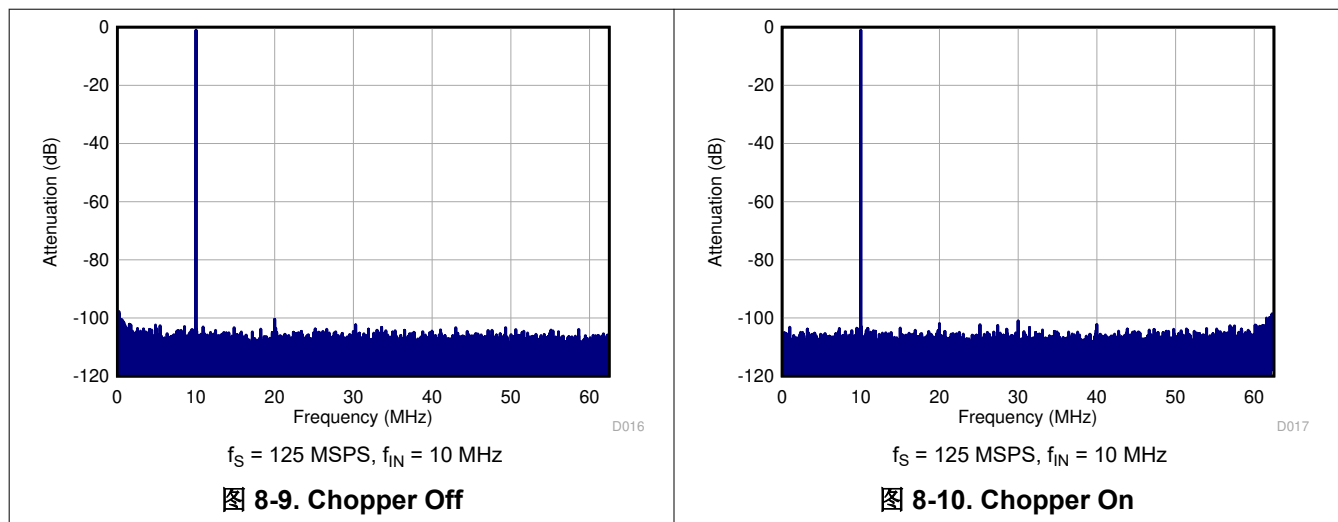

### 8.4.3 Power-Down Control

The power-down functions of the ADC322x can be controlled either through the parallel control pin (PDN) or through an SPI register setting (see [register 15h](#)). The PDN pin can also be configured via the SPI to a global power-down or standby functionality, as shown in [表 8-2](#).

**表 8-2. Power-Down Modes**

FUNCTION	POWER CONSUMPTION (mW)	WAKE-UP TIME ( $\mu$ s)
Global power-down	5	85
Standby	81	35

### 8.4.3.1 Improving Wake-Up Time From Global Power-Down

The device has an internal low-pass filter in the sampling clock path. This low-pass filter helps improve the aperture jitter of the device. However, in applications where input frequencies are < 200 MHz, noise from the aperture jitter does not dominate the overall SNR of the device. In such applications, the wake-up time from a global power-down can be reduced by bypassing the low-pass filter using the DIS CLK FILT register bit (write 80h to register address 70Ah). As shown in 表 8-3, setting the DIS CLK FILT bit improves the wake-up time from a global power-down from 85  $\mu$ s to 55  $\mu$ s.

表 8-3. Wake-Up Time From Global Power-Down

DIS CLK FILT REGISTER BIT	GLOBAL PDN REGISTER BIT	WAKE-UP TIME		
		TYP	MAX	UNIT
0	0→1→0	85	140	$\mu$ s
1	0→1→0	55	81	$\mu$ s

### 8.4.4 Internal Dither Algorithm

The ADC322x use an internal dither algorithm to achieve high SFDR and a clean spectrum. However, the dither algorithm marginally degrades SNR, creating a trade-off between SNR and SFDR. If desired, the dither algorithm can be turned off by using the DIS DITH CHx registers bits. 图 8-11 and 图 8-12 show the effect of using dither algorithms.

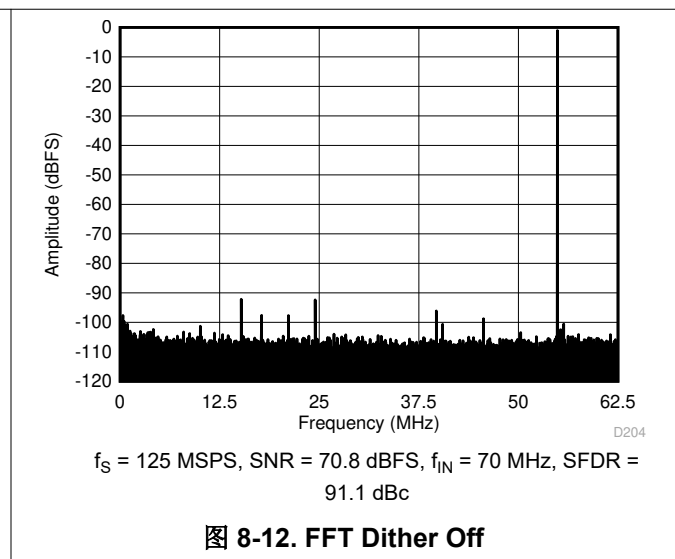
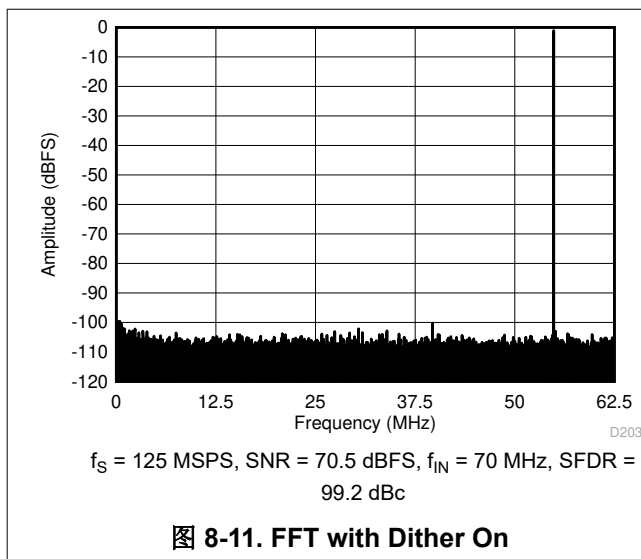

## 8.5 Programming

The ADC322x can be configured using a serial programming interface, as described in this section.

### 8.5.1 Serial Interface

The device has a set of internal registers that can be accessed by the serial interface formed by the SEN (serial interface enable), SCLK (serial interface clock), SDATA (serial interface data), and SDOOUT (serial interface data output) pins. Serially shifting bits into the device is enabled when SEN is low. Serial data SDATA are latched at every SCLK rising edge when SEN is active (low). The serial data are loaded into the register at every 24th SCLK rising edge when SEN is low. When the word length exceeds a multiple of 24 bits, the excess bits are ignored. Data can be loaded in multiples of 24-bit words within a single active SEN pulse. The interface can function with SCLK frequencies from 20 MHz down to very low speeds (of a few hertz) and also with a non-50% SCLK duty cycle.

### 8.5.1.1 Register Initialization

After power-up, the internal registers **must be** initialized to their default values through a hardware reset by applying a high pulse on the RESET pin (of durations greater than 10 ns), as shown in 图 8-13. If required, the serial interface registers can be cleared during operation either:

1. Through a hardware reset, or
2. By applying a software reset. When using the serial interface, set the RESET bit (D0 in register address 06h) high. This setting initializes the internal registers to the default values and then self-resets the RESET bit low. In this case, the RESET pin is kept low.

#### 8.5.1.1.1 Serial Register Write

The device internal register can be programmed with these steps:

1. Drive the SEN pin low,
2. Set the R/W bit to 0 (bit A15 of the 16-bit address),
3. Set bit A14 in the address field to 1,
4. Initiate a serial interface cycle by specifying the address of the register (A13 to A0) whose content must be written, and
5. Write the 8-bit data that are latched in on the SCLK rising edge.

图 8-13 and 表 8-4 show the timing requirements for the serial register write operation.



图 8-13. Serial Register Write Timing Diagram

表 8-4. Serial Interface Timing<sup>(1)</sup>

		MIN	TYP	MAX	UNIT
$f_{SCLK}$	SCLK frequency (equal to $1 / t_{SCLK}$ )	> dc		20	MHz
$t_{SLOADS}$	SEN to SCLK setup time	25			ns
$t_{SLOADH}$	SCLK to SEN hold time	25			ns
$t_{DSU}$	SDIO setup time	25			ns
$t_{DH}$	SDIO hold time	25			ns

(1) Typical values are at 25°C, full temperature range is from  $T_{MIN} = -40^{\circ}\text{C}$  to  $T_{MAX} = 85^{\circ}\text{C}$ , and  $AVDD = DVDD = 1.8\text{ V}$ , unless otherwise noted.

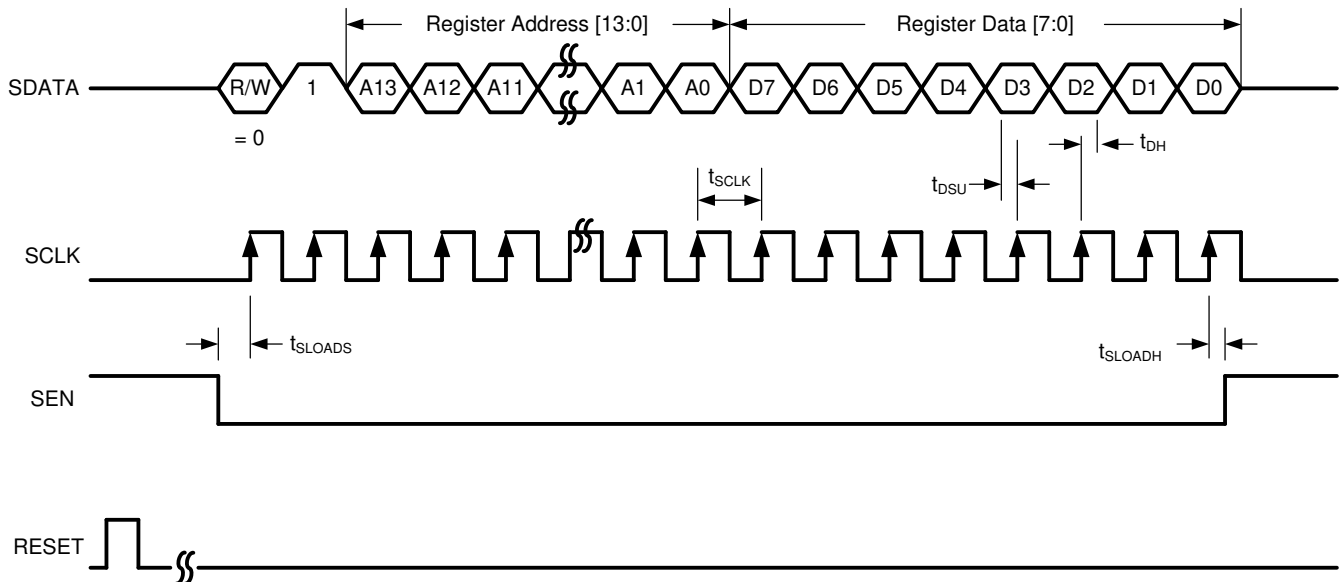
### 8.5.1.1.2 Serial Register Readout

The device includes a mode where the contents of the internal registers can be read back using the SDOUT pin. This readback mode can be useful as a diagnostic check to verify the serial interface communication between the external controller and the ADC. The procedure to read the contents of the serial registers is as follows:

1. Drive the SEN pin low.
2. Set the R/W bit (A15) to 1. This setting disables any further writes to the registers.
3. Set bit A14 in the address field to 1.
4. Initiate a serial interface cycle specifying the address of the register (A[13:0]) whose content must be read.
5. The device outputs the contents (D[7:0]) of the selected register on the SDOUT pin.
6. The external controller can latch the contents at the SCLK rising edge.
7. To enable register writes, reset the R/W register bit to 0.

When READOUT is disabled, the SDOUT pin is in a high-impedance mode. If serial readout is not used, the SDOUT pin must float. 图 8-14 shows a timing diagram of the serial register read operation. Data appear on the SDOUT pin at the SCLK falling edge with an approximate delay ( $t_{SD\_DELAY}$ ) of 20 ns, as shown in 图 8-15.



图 8-14. Serial Register Read Timing Diagram



图 8-15. SDOUT Timing Diagram

### 8.5.2 Register Initialization through SPI

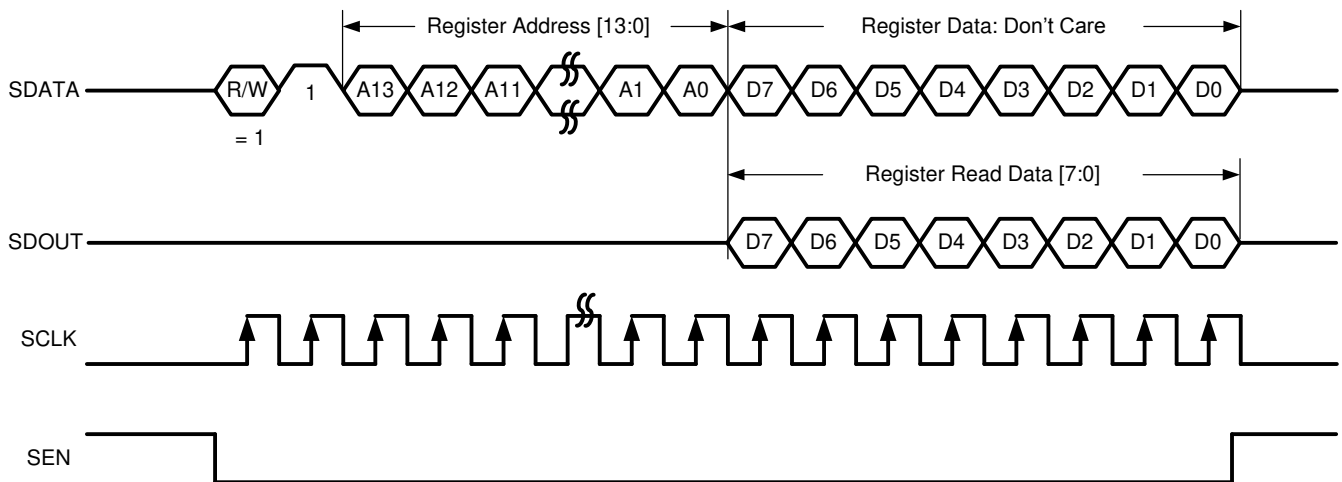
After power-up, the internal registers must be initialized to their default values through a hardware reset by applying a high pulse on the RESET pin, as shown in 图 8-16 and 表 8-5.

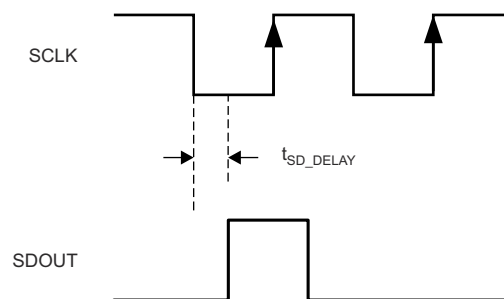

图 8-16. Initialization of Serial Registers after Power-Up

表 8-5. Power-Up Timing

		MIN	TYP	MAX	UNIT
$t_1$	Power-on delay from power up to active high RESET pulse	1			ms
$t_2$	Reset pulse duration: active high RESET pulse duration	10			ns
$t_3$	Register write delay from RESET disable to SEN active	100			ns

If required, the serial interface registers may be cleared during operation either:

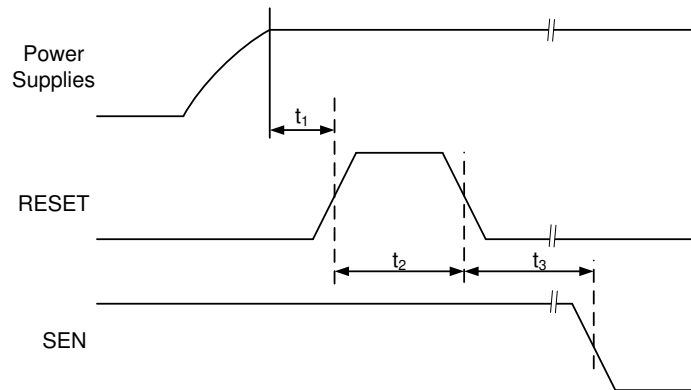
1. Through hardware reset, or
2. By applying a software reset. When using the serial interface, set the RESET bit (D0 in register address 06h) to high. This setting initializes the internal registers to the default values and then self-resets the RESET bit low. In this case, the RESET pin is kept low.



## 8.6 Register Maps

表 8-6. Register Map Summary

REGISTER ADDRESS	REGISTER DATA							
A[13:0] (Hex)	7	6	5	4	3	2	1	0
Register 01h	0	0	DIS DITH CHA		DIS DITH CHB		0	0
Register 03h	0	0	0	0	0	0	0	ODD EVEN
Register 04h	0	0	0	0	0	0	0	FLIP WIRE
Register 05h	0	0	0	0	0	0	0	1W-2W
Register 06h	0	0	0	0	0	0	TEST PATTERN EN	RESET
Register 07h	0	0	0	0	0	0	0	OVR ON LSB
Register 09h	0	0	0	0	0	0	ALIGN TEST PATTERN	DATA FORMAT
Register 0Ah	0	0	0	0	CHA TEST PATTERN			
Register 0Bh	CHB TEST PATTERN			0	0	0	0	0
Register 0Eh	CUSTOM PATTERN[11:4]							
Register 0Fh	CUSTOM PATTERN[3:0]				0	0	0	0
Register 13h	0	0	0	0	0	0	LOW SPEED ENABLE	
Register 15h	0	CHA PDN	CHB PDN	0	STANDBY	GLOBAL PDN	0	CONFIG PDN PIN
Register 25h	LVDS SWING							
Register 27h	CLK DIV		0	0	0	0	0	0
Register 41Dh	0	0	0	0	0	0	HIGH IF MODE0	0
Register 422h	0	0	0	0	0	0	DIS CHOP CHA	0
Register 434h	0	0	DIS DITH CHA	0	DIS DITH CHA	0	0	0
Register 439h	0	0	0	0	SP1 CHA	0	0	0
Register 51Dh	0	0	0	0	0	0	HIGH IF MODE1	0
Register 522h	0	0	0	0	0	0	DIS CHOP CHB	0
Register 534h	0	0	DIS DITH CHB	0	DIS DITH CHB	0	0	0
Register 539h	0	0	0	0	SP1 CHB	0	0	0
Register 608h	HIGH IF MODE[3:2]		0	0	0	0	0	0
Register 70Ah	DIS CLK FILT	0	0	0	0	0	0	PDN SYSREF

## 8.6.1 Summary of Special Mode Registers

表 8-7 lists the location, value, and functions of special mode registers in the device.

表 8-7. Special Modes Summary

MODE	REGISTER SETTINGS	DESCRIPTION
Special modes	Registers 439h (bit 3) and 539h (bit 3)	Always set these bits high for best performance
Disable dither	Registers 1h (bits 5-2), 434h (bits 5 and 3), and 534h (bits 5 and 3)	Disable dither to improve SNR
Disable chopper	Registers 422h (bit 1) and 522h (bit 1)	Disable chopper to shift 1/f noise floor at dc
High IF modes	Registers 41Dh (bit 1), 51Dh (bit 1), and 608h (bits 7-6)	Improves HD3 for IF > 100 MHz

## 8.6.2 Serial Register Description

### 8.6.2.1 Register 01h

图 8-17. Register 01h

7	6	5	4	3	2	1	0
0	0	DIS DITH CHA		DIS DITH CHB		0	0
W-0h	W-0h	R/W-0h		R/W-0h		W-0h	W-0h

LEGEND: R/W = Read/Write; R = Read only; W = Write only; -n = value after reset

表 8-8. Register 01h Description

Bit	Field	Type	Reset	Description
7-6	0	W	0h	Must write 0
5-4	DIS DITH CHA	R/W	0h	These bits enable or disable the on-chip dither. Control this bit with bits 5 and 3 of register 434h. 00 = Default 11 = Dither is disabled for channel A. In this mode, SNR typically improves by 0.2 dB at 70 MHz.
3-2	DIS DITH CHB	R/W	0h	These bits enable or disable the on-chip dither. Control this bit with bits 5 and 3 of register 434h. 00 = Default 11 = Dither is disabled for channel B. In this mode, SNR typically improves by 0.2 dB at 70 MHz.
1-0	0	W	0h	Must write 0

### 8.6.2.2 Register 03h

图 8-18. Register 03h

7	6	5	4	3	2	1	0
0	0	0	0	0	0	0	ODD EVEN
W-0h	W-0h	W-0h	W-0h	W-0h	W-0h	W-0h	R/W-0h

LEGEND: R/W = Read/Write; R = Read only; W = Write only; -n = value after reset

表 8-9. Register 03h Description

Bit	Field	Type	Reset	Description
7-1	0	W	0h	Must write 0
0	ODD EVEN	R/W	0h	This bit selects the bit sequence on the output wires (in 2-wire mode only). 0 = Bits 0, 1, and 2 appear on wire 0; bits 7, 8, and 9 appear on wire 1 1 = Bits 0, 2, and 4 appear on wire 0; bits 1, 3, and 5 appear on wire 1

### 8.6.2.3 Register 04h

图 8-19. Register 04h

7	6	5	4	3	2	1	0
0	0	0	0	0	0	0	FLIP WIRE
W-0h	W-0h	W-0h	W-0h	W-0h	W-0h	W-0h	R/W-0h

LEGEND: R/W = Read/Write; R = Read only; W = Write only; -n = value after reset

表 8-10. Register 04h Description

Bit	Field	Type	Reset	Description
7-1	0	W	0h	Must write 0
0	FLIP WIRE	R/W	0h	This bit flips the data on the output wires. Valid only in two wire configuration. 0 = Default 1 = Data on output wires is flipped. Pin D0x becomes D1x, and vice versa.

### 8.6.2.4 Register 05h

图 8-20. Register 05h

7	6	5	4	3	2	1	0
0	0	0	0	0	0	0	1W-2W
W-0h	W-0h	W-0h	W-0h	W-0h	W-0h	W-0h	R/W-0h

LEGEND: R/W = Read/Write; R = Read only; W = Write only; -n = value after reset

表 8-11. Register 05h Description

Bit	Field	Type	Reset	Description
7-1	0	W	0h	Must write 0
0	1W-2W	R/W	0h	This bit transmits output data on either one or two wires. 0 = Output data are transmitted on two wires (Dx0P, Dx0M and Dx1P, Dx1M) 1 = Output data are transmitted on one wire (Dx0P, Dx0M). In this mode, the recommended $f_S$ is less than 62.5 MSPS.

### 8.6.2.5 Register 06h

图 8-21. Register 06h

7	6	5	4	3	2	1	0
0	0	0	0	0	0	TEST PATTERN EN	RESET
W-0h	W-0h	W-0h	W-0h	W-0h	W-0h	R/W-0h	W-0h

LEGEND: R/W = Read/Write; R = Read only; W = Write only; -n = value after reset

表 8-12. Register 06h Description

Bit	Field	Type	Reset	Description
7-2	0	W	0h	Must write 0
1	TEST PATTERN EN	R/W	0h	This bit enables test pattern selection for the digital outputs. 0 = Normal output 1 = Test pattern output enabled
0	RESET	W	0h	This bit applies a software reset. This bit resets all internal registers to the default values and self-clears to 0.

### 8.6.2.6 Register 07h

图 8-22. Register 07h

7	6	5	4	3	2	1	0
0	0	0	0	0	0	0	OVR ON LSB
W-0h	W-0h	W-0h	W-0h	W-0h	W-0h	W-0h	R/W-0h

LEGEND: R/W = Read/Write; R = Read only; W = Write only; -n = value after reset

表 8-13. Register 07h Description

Bit	Field	Type	Reset	Description
7-1	0	W	0h	Must write 0
0	OVR ON LSB	R/W	0h	This bit provides the overrange (OVR) information on the LSB bits. 0 = Output data bit 0 functions as the LSB of the 12-bit data 1 = Output data bit 0 carries the OVR information.

### 8.6.2.7 Register 09h

图 8-23. Register 09h

7	6	5	4	3	2	1	0
0	0	0	0	0	0	ALIGN TEST PATTERN	DATA FORMAT
W-0h	W-0h	W-0h	W-0h	W-0h	W-0h	R/W-0h	R/W-0h

LEGEND: R/W = Read/Write; R = Read only; W = Write only; -n = value after reset

表 8-14. Register 09h Description

Bit	Field	Type	Reset	Description
7-2	0	W	0h	Must write 0
1	ALIGN TEST PATTERN	R/W	0h	This bit aligns the test patterns across the outputs of both channels. 0 = Test patterns of both channels are free running 1 = Test patterns of both channels are aligned
0	DATA FORMAT	R/W	0h	This bit programs the digital output data format. 0 = Twos complement 1 = Offset binary

### 8.6.2.8 Register 0Ah

图 8-24. Register 0Ah

7	6	5	4	3	2	1	0
0	0	0	0	CHA TEST PATTERN			
W-0h	W-0h	W-0h	W-0h	R/W-0h			

LEGEND: R/W = Read/Write; R = Read only; W = Write only; -n = value after reset

表 8-15. Register 0Ah Description

Bit	Field	Type	Reset	Description
7-4	0	W	0h	Must write 0
3-0	CHA TEST PATTERN	R/W	0h	These bits control the test pattern for channel A after the TEST PATTERN EN bit is set. 0000 = Normal operation 0001 = All 0's 0010 = All 1's 0011 = Toggle pattern: data alternate between 101010101010 and 010101010101 0100 = Digital ramp: data increment by 1 LSB every clock cycle from code 0 to 4095 0101 = Custom pattern: output data are the same as programmed by the CUSTOM PATTERN register bits 0110 = Deskew pattern: data are AAAh 1000 = PRBS pattern: data are a sequence of pseudo random numbers 1001 = 8-point sine-wave: data are a repetitive sequence of the following eight numbers that form a sine-wave: 0, 599, 2048, 3496, 4095, 3496, 2048, and 599 Others = Do not use

### 8.6.2.9 Register 0Bh

图 8-25. Register 0Bh

7	6	5	4	3	2	1	0
CHB TEST PATTERN				0	0	0	0
R/W-0h				W-0h	W-0h	W-0h	W-0h

LEGEND: R/W = Read/Write; R = Read only; W = Write only; -n = value after reset

表 8-16. Register 0Bh Description

Bit	Field	Type	Reset	Description
7-4	CHB TEST PATTERN	R/W	0h	These bits control the test pattern for channel B after the TEST PATTERN EN bit is set. 0000 = Normal operation 0001 = All 0's 0010 = All 1's 0011 = Toggle pattern: data alternate between 101010101010 and 010101010101 0100 = Digital ramp: data increment by 1 LSB every clock cycle from code 0 to 4095 0101 = Custom pattern: output data are the same as programmed by the CUSTOM PATTERN register bits 0110 = Deskew pattern: data are AAAh 1000 = PRBS pattern: data are a sequence of pseudo random numbers 1001 = 8-point sine-wave: data are a repetitive sequence of the following eight numbers that form a sine-wave: 0, 599, 2048, 3496, 4095, 3496, 2048, and 599 Others = Do not use

**表 8-16. Register 0Bh Description (continued)**

Bit	Field	Type	Reset	Description
3-0	0	W	0h	Must write 0

### 8.6.2.10 Register 0Eh

**图 8-26. Register 0Eh**

7	6	5	4	3	2	1	0
CUSTOM PATTERN[11:4]							
R/W-0h							

LEGEND: R/W = Read/Write; R = Read only; -n = value after reset

**表 8-17. Register 0Eh Description**

Bit	Field	Type	Reset	Description
7-0	CUSTOM PATTERN[11:4]	R/W	0h	These bits set the 12-bit custom pattern (bits 11-4) for all channels.

### 8.6.2.11 Register 0Fh

**图 8-27. Register 0Fh**

7	6	5	4	3	2	1	0
CUSTOM PATTERN[3:0]				0	0	0	0
R/W-0h				W-0h	W-0h	W-0h	W-0h

LEGEND: R/W = Read/Write; R = Read only; W = Write only; -n = value after reset

**表 8-18. Register 0Fh Description**

Bit	Field	Type	Reset	Description
7-4	CUSTOM PATTERN[3:0]	R/W	0h	These bits set the 12-bit custom pattern (bits 3-0) for all channels.
3-0	0	W	0h	Must write 0

### 8.6.2.12 Register 13h

**图 8-28. Register 13h**

7	6	5	4	3	2	1	0
0	0	0	0	0	0	LOW SPEED ENABLE	
W-0h	R/W-0h	R/W-0h	W-0h	R/W-0h	R/W-0h	W-0h	R/W-0h

LEGEND: R/W = Read/Write; R = Read only; W = Write only; -n = value after reset

**表 8-19. Register 13h Description**

Bit	Field	Type	Reset	Description
7-2	0	W	0h	Must write 0
1-0	LOW SPEED ENABLE	R/W	0h	Enables low speed operation in 1-wire and 2-wire mode. Depending upon sampling frequency, write this bit as per 表 8-20.

**表 8-20. LOW SPEED ENABLE Register Bit Settings Across  $f_s$**

$f_s$ (MSPS)		REGISTER BIT LOW SPEED ENABLE	
MIN	MAX	1-WIRE MODE	2-WIRE MODE
25	125	00	00
20	25	10	11
15	20	10	Not supported

### 8.6.2.13 Register 15h

图 8-29. Register 15h

7	6	5	4	3	2	1	0
0	CHA PDN	CHB PDN	0	STANDBY	GLOBAL PDN	0	CONFIG PDN PIN
W-0h	R/W-0h	R/W-0h	W-0h	R/W-0h	R/W-0h	W-0h	R/W-0h

LEGEND: R/W = Read/Write; R = Read only; W = Write only; -n = value after reset

表 8-21. Register 15h Description

Bit	Field	Type	Reset	Description
7	0	W	0h	Must write 0
6	CHA PDN	R/W	0h	0 = Normal operation 1 = Power-down channel A
5	CHB PDN	R/W	0h	0 = Normal operation 1 = Power-down channel B
4	0	W	0h	Must write 0
3	STANDBY	R/W	0h	The ADCs of both channels enter standby. 0 = Normal operation 1 = Standby
2	GLOBAL PDN	R/W	0h	0 = Normal operation 1 = Global power-down
1	0	W	0h	Must write 0
0	CONFIG PDN PIN	R/W	0h	This bit configures the PDN pin as either a global power-down or standby pin. 0 = Logic high voltage on the PDN pin sends the device into global power-down 1 = Logic high voltage on the PDN pin sends the device into standby

### 8.6.2.14 Register 25h

图 8-30. Register 25h

7	6	5	4	3	2	1	0
LVDS SWING							
R/W-0h							

LEGEND: R/W = Read/Write; R = Read only; -n = value after reset

表 8-22. Register 25h Description

Bit	Field	Type	Reset	Description
7-0	LVDS SWING	R/W	0h	These bits control the swing of the LVDS outputs (including the data output, bit clock, and frame clock). For details see 表 8-23.

表 8-23. LVDS Output Swing

BITS 7-4	BITS 3-0	LVDS OUTPUT SWING
0h	0h	Default ( $\pm 425$ mV)
Dh	9h	Swing reduces by 50 mV
Eh	Ah	Swing reduces by 100 mV
Fh	Dh	Swing reduces by 300 mV
Ch	Eh	Swing increases by 100 mV
Others	Others	Do not use

### 8.6.2.15 Register 27h

图 8-31. Register 27h

7	6	5	4	3	2	1	0
CLK DIV		0	0	0	0	0	0
R/W-0h		W-0h	W-0h	W-0h	W-0h	W-0h	W-0h

LEGEND: R/W = Read/Write; R = Read only; W = Write only; -n = value after reset

表 8-24. Register 27h Description

Bit	Field	Type	Reset	Description
7-6	CLK DIV	R/W	0h	These bits set the internal clock divider for the input sampling clock. 00 = Divide-by-1 01 = Divide-by-1 10 = Divide-by-2 11 = Divide-by-4
5-0	0	W	0h	Must write 0

### 8.6.2.16 Register 41Dh

图 8-32. Register 41Dh

7	6	5	4	3	2	1	0
0	0	0	0	0	0	HIGH IF MODE0	0
W-0h	W-0h	W-0h	W-0h	W-0h	W-0h	R/W-0h	W-0h

LEGEND: R/W = Read/Write; R = Read only; W = Write only; -n = value after reset

表 8-25. Register 41Dh Description

Bit	Field	Type	Reset	Description
7-2	0	W	0h	Must write 0
1	HIGH IF MODE0	R/W	0h	This bit improves HD3 for IF > 100 MHz. 0 = Normal operation For best HD3 at IF > 100 MHz, set HIGH IF MODE[3:0] to 1111.
0	0	W	0h	Must write 0

### 8.6.2.17 Register 422h

图 8-33. Register 422h

7	6	5	4	3	2	1	0
0	0	0	0	0	0	DIS CHOP CHA	0
W-0h	W-0h	W-0h	W-0h	W-0h	W-0h	R/W-0h	W-0h

LEGEND: R/W = Read/Write; R = Read only; W = Write only; -n = value after reset

表 8-26. Register 422h Description

Bit	Field	Type	Reset	Description
7-2	0	W	0h	Must write 0
1	DIS CHOP CHA	R/W	0h	Disable chopper. Set this bit to shift a 1/f noise floor at dc. 0 = 1/f noise floor is centered at $f_S / 2$ (default) 1 = Chopper mechanism is disabled; 1/f noise floor is centered at dc
0	0	W	0h	Must write 0



### 8.6.2.18 Register 434h

**图 8-34. Register 434h**

7	6	5	4	3	2	1	0
0	0	DIS DITH CHA	0	DIS DITH CHA	0	0	0
W-0h	W-0h	R/W-0h	W-0h	R/W-0h	W-0h	W-0h	W-0h

LEGEND: R/W = Read/Write; R = Read only; W = Write only; -n = value after reset

**表 8-27. Register 434h Description**

Bit	Field	Type	Reset	Description
7-6	0	W	0h	Must write 0
5	DIS DITH CHA	R/W	0h	Set this bit with bits 5 and 4 of register 01h. 00 = Default 11 = Dither is disabled for channel A. In this mode, SNR typically improves by 0.5 dB at 70 MHz.
4	0	W	0h	Must write 0
3	DIS DITH CHA	R/W	0h	Set this bit with bits 5 and 4 of register 01h. 00 = Default 11 = Dither is disabled for channel A. In this mode, SNR typically improves by 0.5 dB at 70 MHz.
2-0	0	W	0h	Must write 0

### 8.6.2.19 Register 439h

**图 8-35. Register 439h**

7	6	5	4	3	2	1	0
0	0	0	0	SP1 CHA	0	0	0
W-0h	W-0h	W-0h	W-0h	R/W-0h	W-0h	W-0h	W-0h

LEGEND: R/W = Read/Write; R = Read only; W = Write only; -n = value after reset

**表 8-28. Register 439h Description**

Bit	Field	Type	Reset	Description
7-4	0	W	0h	Must write 0
3	SP1 CHA	R/W	0h	Special mode for best performance on channel A. Always write 1 after reset.
2-0	0	W	0h	Must write 0

### 8.6.2.20 Register 51Dh

**图 8-36. Register 51Dh**

7	6	5	4	3	2	1	0
0	0	0	0	0	0	HIGH IF MODE1	0
W-0h	W-0h	W-0h	W-0h	W-0h	W-0h	R/W-0h	W-0h

LEGEND: R/W = Read/Write; R = Read only; W = Write only; -n = value after reset

**表 8-29. Register 51Dh Description**

Bit	Field	Type	Reset	Description
7-2	0	W	0h	Must write 0
1	HIGH IF MODE1	R/W	0h	This bit improves HD3 for IF > 100 MHz. 0 = Normal operation For best HD3 at IF > 100 MHz, set HIGH IF MODE[3:0] to 1111.

表 8-29. Register 51Dh Description (continued)

Bit	Field	Type	Reset	Description
0	0	W	0h	Must write 0

8.6.2.21 Register 522h

图 8-37. Register 522h

7	6	5	4	3	2	1	0
0	0	0	0	0	0	DIS CHOP CHB	0
W-0h	W-0h	W-0h	W-0h	W-0h	W-0h	R/W-0h	W-0h

LEGEND: R/W = Read/Write; R = Read only; W = Write only; -n = value after reset

表 8-30. Register 522h Description

Bit	Field	Type	Reset	Description
7-2	0	W	0h	Must write 0
1	DIS CHOP CHB	R/W	0h	Disable chopper. Set this bit to shift a 1/f noise floor at dc. 0 = 1/f noise floor is centered at $f_s / 2$ (default) 1 = Chopper mechanism is disabled; 1/f noise floor is centered at dc
0	0	W	0h	Must write 0

8.6.2.22 Register 534h

图 8-38. Register 534h

7	6	5	4	3	2	1	0
0	0	DIS DITH CHA	0	DIS DITH CHA	0	0	0
W-0h	W-0h	R/W-0h	W-0h	R/W-0h	W-0h	W-0h	W-0h

LEGEND: R/W = Read/Write; R = Read only; W = Write only; -n = value after reset

表 8-31. Register 534h Description

Bit	Field	Type	Reset	Description
7-6	0	W	0h	Must write 0
5	DIS DITH CHA	R/W	0h	Set this bit with bits 3 and 2 of register 01h. 00 = Default 11 = Dither is disabled for channel B. In this mode, SNR typically improves by 0.5 dB at 70 MHz.
4	0	W	0h	Must write 0
3	DIS DITH CHA	R/W	0h	Set this bit with bits 3 and 2 of register 01h. 00 = Default 11 = Dither is disabled for channel B. In this mode, SNR typically improves by 0.5 dB at 70 MHz.
2-0	0	W	0h	Must write 0

8.6.2.23 Register 539h

图 8-39. Register 539h

7	6	5	4	3	2	1	0
0	0	0	0	SP1 CHB	0	0	0
W-0h	W-0h	W-0h	W-0h	R/W-0h	W-0h	W-0h	W-0h

LEGEND: R/W = Read/Write; R = Read only; W = Write only; -n = value after reset

表 8-32. Register 539h Description

Bit	Field	Type	Reset	Description
7-4	0	W	0h	Must write 0
3	SP1 CHB	R/W	0h	Special mode for best performance on channel B. Always write 1 after reset.
0	0	W	0h	Must write 0

#### 8.6.2.24 Register 608h

图 8-40. Register 608h

7	6	5	4	3	2	1	0
HIGH IF MODE[3:2]	0	0	0	0	0	0	0
R/W-0h	W-0h	W-0h	W-0h	W-0h	W-0h	W-0h	W-0h

LEGEND: R/W = Read/Write; R = Read only; W = Write only; -n = value after reset

表 8-33. Register 608h Description

Bit	Field	Type	Reset	Description
7-6	HIGH IF MODE[3:2]	R/W	0h	This bit improves HD3 for IF > 100 MHz. 0 = Normal operation For best HD3 at IF > 100 MHz, set HIGH IF MODE[3:0] to 1111.
5-0	0	W	0h	Must write 0

#### 8.6.2.25 Register 70Ah

图 8-41. Register 70Ah

7	6	5	4	3	2	1	0
DIS CLK FILT	0	0	0	0	0	0	PDN SYSREF
R/W-0h	W-0h	W-0h	W-0h	W-0h	W-0h	W-0h	R/W-0h

LEGEND: R/W = Read/Write; R = Read only; W = Write only; -n = value after reset

表 8-34. Register 70Ah Description

Bit	Field	Type	Reset	Description
7	DIS CLK FILT	R/W	0h	Set this bit to improve wake-up time from global power-down mode; see the <a href="#">节 8.4.3.1</a> section for details.
6-1	0	W	0h	Must write 0
0	PDN SYSREF	R/W	0h	If the SYSREF pins are not used in the system, the SYSREF buffer must be powered down by setting this bit. 0 = Normal operation 1 = Powers down the SYSREF buffer

## 9 Applications and Implementation

### 备注

Information in the following applications sections is not part of the TI component specification, and TI does not warrant its accuracy or completeness. TI's customers are responsible for determining suitability of components for their purposes. Customers should validate and test their design implementation to confirm system functionality.

### 9.1 Application Information

Typical applications involving transformer-coupled circuits are discussed in this section. Transformers (such as ADT1-1WT or WBC1-1) can be used up to 250 MHz to achieve good phase and amplitude balances at the ADC inputs. When designing the dc-driving circuits, the ADC input impedance must be considered. 图 9-1 和 图 9-2 show the impedance ( $Z_{in} = R_{in} \parallel C_{in}$ ) across the ADC input pins.

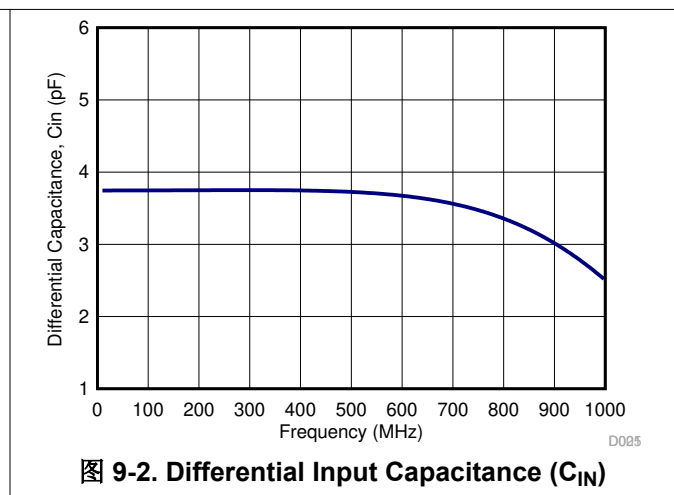
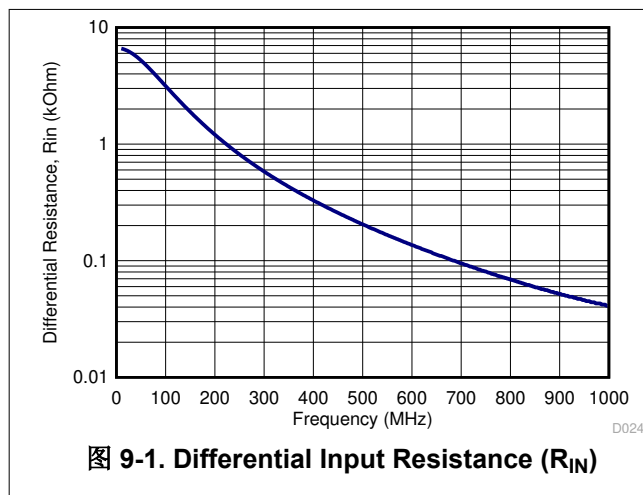

## 9.2 Typical Applications

### 9.2.1 Driving Circuit Design: Low Input Frequencies



图 9-3. Driving Circuit for Low Input Frequencies

#### 9.2.1.1 Design Requirements

For optimum performance, the analog inputs must be driven differentially. An optional 5-Ω to 15-Ω resistor in series with each input pin can be kept to damp out ringing caused by package parasitic. The drive circuit may have to be designed to minimize the affect of kick-back noise generated by sampling switches opening and closing inside the ADC, as well as ensuring low insertion loss over the desired frequency range and matched impedance to the source.

#### 9.2.1.2 Detailed Design Procedure

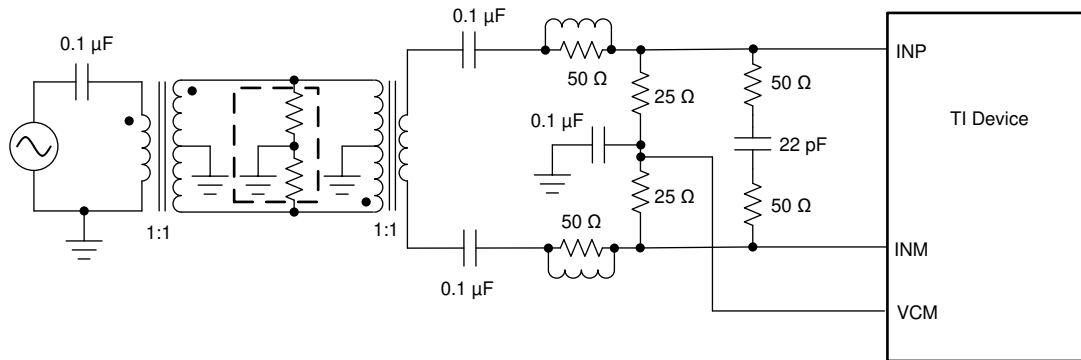
A typical application involving using two back-to-back coupled transformers is shown in 图 9-3. This circuit is optimized for low input frequencies. An external R-C-R filter using 50-Ω resistors and a 22-pF capacitor is used with the series inductor (39 nH); this combination helps absorb the sampling glitches.

To improve phase and amplitude balance of first transformer, the termination resistors can be split between two transformers. For example, 25-Ω to 25-Ω termination across the secondary winding of the second transformer can be changed to 50-Ω to 50-Ω termination and another 50-Ω to 50-Ω resistor can be placed inside the dashed box between the transformers in 图 9-3.

#### 9.2.1.3 Application Curve

图 9-4 shows the performance obtained by using the circuit shown in 图 9-3.

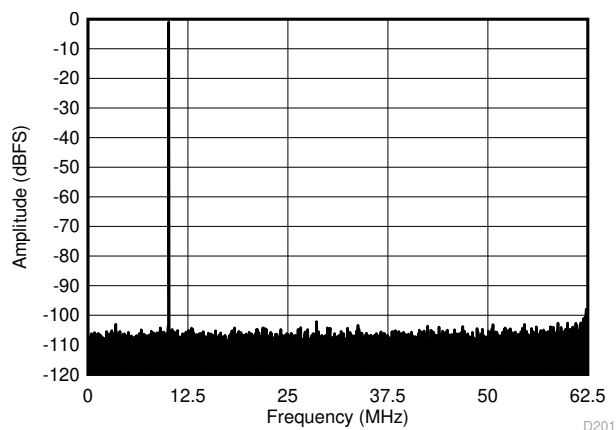

$f_S = 125$  MSPS, SNR = 70.6 dBFS,  $f_{IN} = 10$  MHz, SFDR = 101.1 dBc

图 9-4. Performance FFT at 10 MHz (Low Input Frequency)

## 9.2.2 Driving Circuit Design: Input Frequencies Between 100 MHz to 230 MHz



图 9-5. Driving Circuit for Mid-Range Input Frequencies ( $100 \text{ MHz} < f_{\text{IN}} < 230 \text{ MHz}$ )

### 9.2.2.1 Design Requirements

See the 节 9.2.1.1 section for further details.

### 9.2.2.2 Detailed Design Procedure

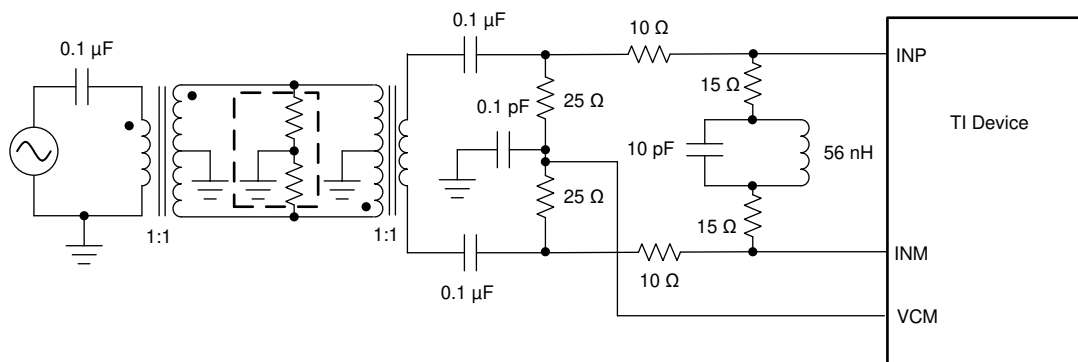
When input frequencies are between 100 MHz to 230 MHz, an R-LC-R circuit can be used to optimize performance, as shown in 图 9-5.

### 9.2.2.3 Application Curve

图 9-6 shows the performance obtained by using the circuit shown in 图 9-5.

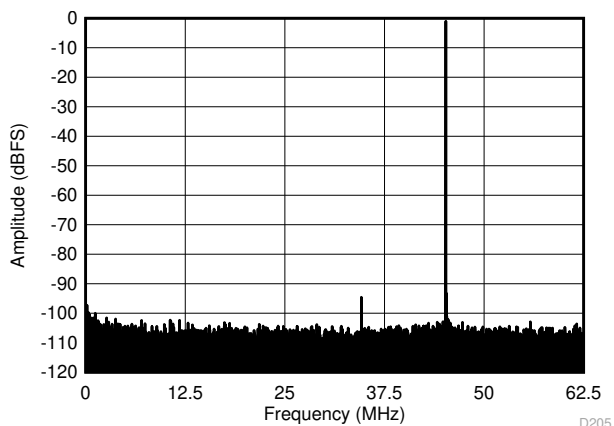

$f_s = 125 \text{ MSPS}$ ,  $\text{SNR} = 70 \text{ dBFS}$ ,  $f_{\text{IN}} = 170 \text{ MHz}$ ,  $\text{SFDR} = 93.6 \text{ dBc}$

图 9-6. Performance FFT at 170 MHz (Mid Input Frequency)

### 9.2.3 Driving Circuit Design: Input Frequencies Greater than 230 MHz



图 9-7. Driving Circuit for High Input Frequencies ( $f_{IN} > 230$  MHz)

#### 9.2.3.1 Design Requirements

See the 节 9.2.1.1 section for further details.

#### 9.2.3.2 Detailed Design Procedure

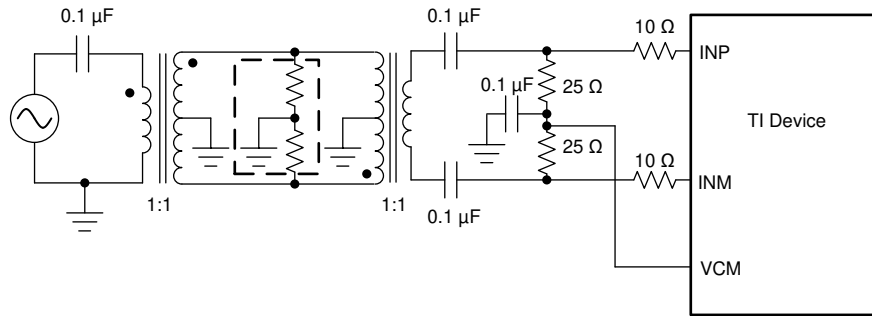
For high input frequencies ( $> 230$  MHz), using the R-C-R or R-LC-R circuit does not show significant improvement in performance. However, a series resistance of  $10 \Omega$  can be used as shown in 图 9-7.

#### 9.2.3.3 Application Curve

图 9-8 shows the performance obtained by using the circuit shown in 图 9-7.

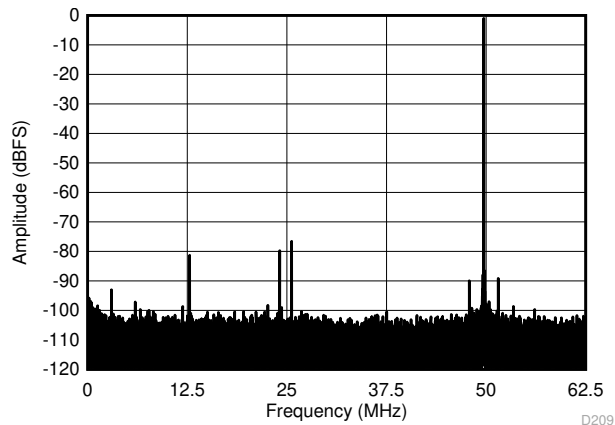

$f_S = 125$  MSPS, SNR = 67.4 dBFS,  $f_{IN} = 450$  MHz, SFDR = 75.5 dBc

图 9-8. Performance FFT at 450 MHz (High Input Frequency)

## 9.3 Power Supply Recommendations

The device requires a 1.8-V nominal supply for AVDD and DVDD. There are no specific sequence power-supply requirements during device power-up. AVDD and DVDD can power up in any order.

## 9.4 Layout

### 9.4.1 Layout Guidelines

The ADC322x EVM layout can be used as a reference layout to obtain the best performance. A layout diagram of the EVM top layer is provided in 图 9-9. Some important points to remember during laying out the board are:

1. Analog inputs are located on opposite sides of the device pin out to make sure minimum crosstalk on the package level. To minimize crosstalk onboard, the analog inputs must exit the pin out in opposite directions, as shown in the reference layout of 图 9-9 as much as possible.
2. In the device pin out, the sampling clock is located on a side perpendicular to the analog inputs in order to minimize coupling between them. This configuration is also maintained on the reference layout of 图 9-9 as much as possible.
3. Keep digital outputs away from analog inputs. When these digital outputs exit the pin out, the digital output traces must not be kept parallel to the analog input traces because this configuration can result in coupling from digital outputs to analog inputs and degrade performance. All digital output traces to the receiver (such as an FPGA or an ASIC) must be matched in length to avoid skew among outputs.
4. At each power-supply pin (AVDD and DVDD), a 0.1- $\mu$ F decoupling capacitor must be kept close to the device. A separate decoupling capacitor group consisting of a parallel combination of 10- $\mu$ F, 1- $\mu$ F, and 0.1- $\mu$ F capacitors can be kept close to the supply source.

### 9.4.2 Layout Example

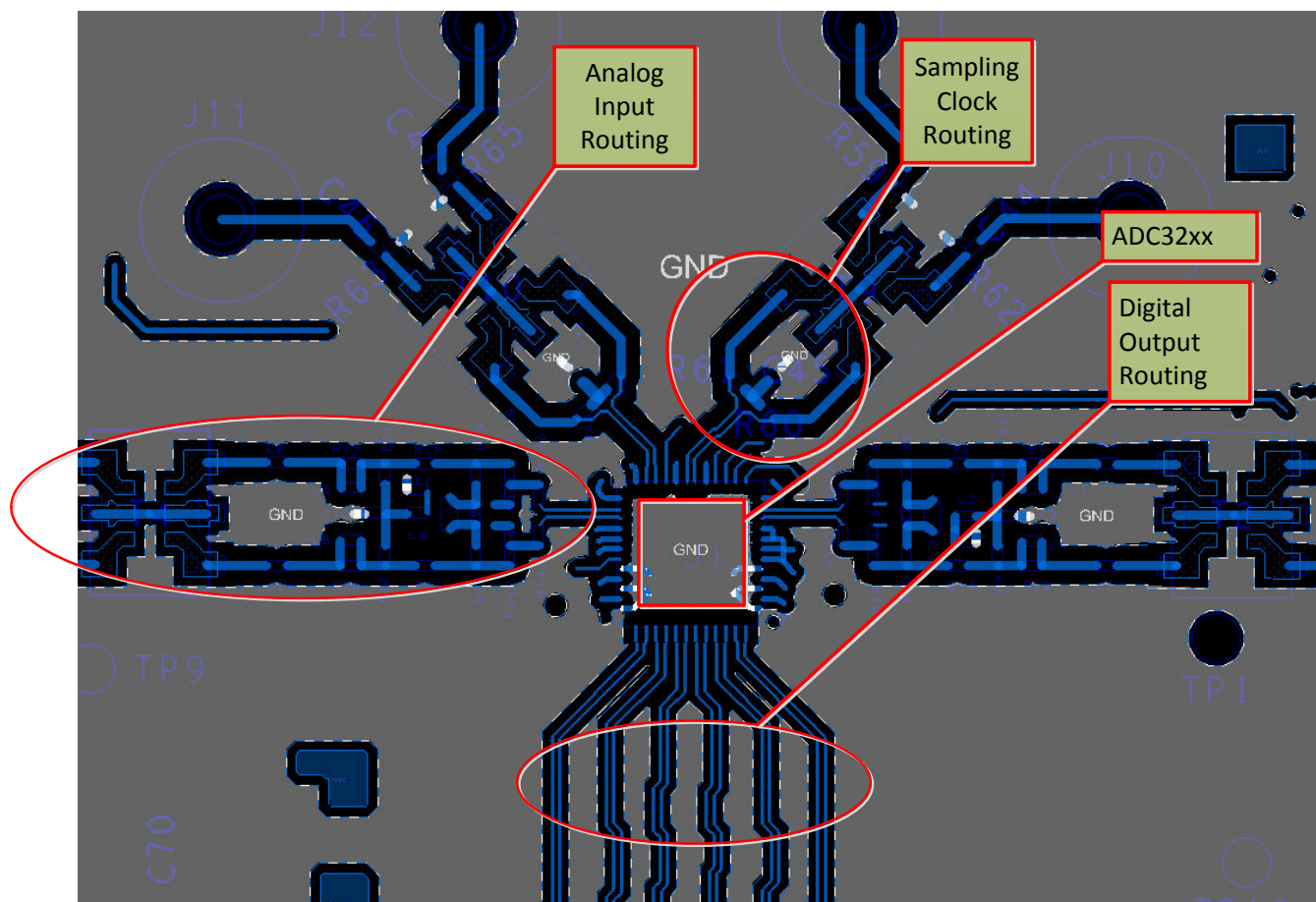



## 10 Device and Documentation Support

### 10.1 接收文档更新通知

要接收文档更新通知，请导航至 [ti.com](http://ti.com) 上的器件产品文件夹。点击 [订阅更新](#) 进行注册，即可每周接收产品信息更改摘要。有关更改的详细信息，请查看任何已修订文档中包含的修订历史记录。

### 10.2 支持资源

[TI E2E™ 支持论坛](#) 是工程师的重要参考资料，可直接从专家获得快速、经过验证的解答和设计帮助。搜索现有解答或提出自己的问题可获得所需的快速设计帮助。

链接的内容由各个贡献者“按原样”提供。这些内容并不构成 TI 技术规范，并且不一定反映 TI 的观点；请参阅 TI 的《[使用条款](#)》。

### 10.3 Trademarks

PowerPAD™ is a trademark of Texas Instruments, Inc.

TI E2E™ is a trademark of Texas Instruments.

所有商标均为其各自所有者的财产。

### 10.4 Electrostatic Discharge Caution



This integrated circuit can be damaged by ESD. Texas Instruments recommends that all integrated circuits be handled with appropriate precautions. Failure to observe proper handling and installation procedures can cause damage.

ESD damage can range from subtle performance degradation to complete device failure. Precision integrated circuits may be more susceptible to damage because very small parametric changes could cause the device not to meet its published specifications.

### 10.5 术语表

[TI 术语表](#) 本术语表列出并解释了术语、首字母缩略词和定义。

## 11 Mechanical, Packaging, and Orderable Information

The following pages include mechanical, packaging, and orderable information. This information is the most current data available for the designated devices. This data is subject to change without notice and revision of this document. For browser-based versions of this data sheet, refer to the left-hand navigation.

**PACKAGING INFORMATION**

Orderable Device	Status (1)	Package Type	Package Drawing	Pins	Package Qty	Eco Plan (2)	Lead finish/ Ball material (6)	MSL Peak Temp (3)	Op Temp (°C)	Device Marking (4/5)	Samples
ADC3221IRGZR	ACTIVE	VQFN	RGZ	48	2500	RoHS & Green	NIPDAUAG	Level-3-260C-168 HR	-40 to 85	AZ3221	<a href="#">Samples</a>
ADC3221IRGZT	ACTIVE	VQFN	RGZ	48	250	RoHS & Green	NIPDAUAG	Level-3-260C-168 HR	-40 to 85	AZ3221	<a href="#">Samples</a>
ADC3222IRGZR	ACTIVE	VQFN	RGZ	48	2500	RoHS & Green	NIPDAUAG	Level-3-260C-168 HR	-40 to 85	AZ3222	<a href="#">Samples</a>
ADC3222IRGZT	ACTIVE	VQFN	RGZ	48	250	RoHS & Green	NIPDAUAG	Level-3-260C-168 HR	-40 to 85	AZ3222	<a href="#">Samples</a>
ADC3223IRGZR	ACTIVE	VQFN	RGZ	48	2500	RoHS & Green	NIPDAUAG	Level-3-260C-168 HR	-40 to 85	AZ3223	<a href="#">Samples</a>
ADC3223IRGZT	ACTIVE	VQFN	RGZ	48	250	RoHS & Green	NIPDAUAG	Level-3-260C-168 HR	-40 to 85	AZ3223	<a href="#">Samples</a>
ADC3224IRGZR	ACTIVE	VQFN	RGZ	48	2500	RoHS & Green	NIPDAUAG	Level-3-260C-168 HR	-40 to 85	AZ3224	<a href="#">Samples</a>
ADC3224IRGZT	ACTIVE	VQFN	RGZ	48	250	RoHS & Green	NIPDAUAG	Level-3-260C-168 HR	-40 to 85	AZ3224	<a href="#">Samples</a>

(1) The marketing status values are defined as follows:

**ACTIVE:** Product device recommended for new designs.

**LIFEBUY:** TI has announced that the device will be discontinued, and a lifetime-buy period is in effect.

**NRND:** Not recommended for new designs. Device is in production to support existing customers, but TI does not recommend using this part in a new design.

**PREVIEW:** Device has been announced but is not in production. Samples may or may not be available.

**OBSOLETE:** TI has discontinued the production of the device.

(2) **RoHS:** TI defines "RoHS" to mean semiconductor products that are compliant with the current EU RoHS requirements for all 10 RoHS substances, including the requirement that RoHS substance do not exceed 0.1% by weight in homogeneous materials. Where designed to be soldered at high temperatures, "RoHS" products are suitable for use in specified lead-free processes. TI may reference these types of products as "Pb-Free".

**RoHS Exempt:** TI defines "RoHS Exempt" to mean products that contain lead but are compliant with EU RoHS pursuant to a specific EU RoHS exemption.

**Green:** TI defines "Green" to mean the content of Chlorine (Cl) and Bromine (Br) based flame retardants meet JS709B low halogen requirements of <=1000ppm threshold. Antimony trioxide based flame retardants must also meet the <=1000ppm threshold requirement.

(3) MSL, Peak Temp. - The Moisture Sensitivity Level rating according to the JEDEC industry standard classifications, and peak solder temperature.

(4) There may be additional marking, which relates to the logo, the lot trace code information, or the environmental category on the device.

(5) Multiple Device Markings will be inside parentheses. Only one Device Marking contained in parentheses and separated by a "~" will appear on a device. If a line is indented then it is a continuation of the previous line and the two combined represent the entire Device Marking for that device.

<sup>(6)</sup> Lead finish/Ball material - Orderable Devices may have multiple material finish options. Finish options are separated by a vertical ruled line. Lead finish/Ball material values may wrap to two lines if the finish value exceeds the maximum column width.

**Important Information and Disclaimer:**The information provided on this page represents TI's knowledge and belief as of the date that it is provided. TI bases its knowledge and belief on information provided by third parties, and makes no representation or warranty as to the accuracy of such information. Efforts are underway to better integrate information from third parties. TI has taken and continues to take reasonable steps to provide representative and accurate information but may not have conducted destructive testing or chemical analysis on incoming materials and chemicals. TI and TI suppliers consider certain information to be proprietary, and thus CAS numbers and other limited information may not be available for release.

In no event shall TI's liability arising out of such information exceed the total purchase price of the TI part(s) at issue in this document sold by TI to Customer on an annual basis.

**TAPE AND REEL INFORMATION**

**QUADRANT ASSIGNMENTS FOR PIN 1 ORIENTATION IN TAPE**

\*All dimensions are nominal

Device	Package Type	Package Drawing	Pins	SPQ	Reel Diameter (mm)	Reel Width W1 (mm)	A0 (mm)	B0 (mm)	K0 (mm)	P1 (mm)	W (mm)	Pin1 Quadrant
ADC3221IRGZR	VQFN	RGZ	48	2500	330.0	16.4	7.3	7.3	1.5	12.0	16.0	Q2
ADC3222IRGZR	VQFN	RGZ	48	2500	330.0	16.4	7.3	7.3	1.5	12.0	16.0	Q2
ADC3223IRGZR	VQFN	RGZ	48	2500	330.0	16.4	7.3	7.3	1.5	12.0	16.0	Q2
ADC3224IRGZR	VQFN	RGZ	48	2500	330.0	16.4	7.3	7.3	1.5	12.0	16.0	Q2

**TAPE AND REEL BOX DIMENSIONS**

\*All dimensions are nominal

Device	Package Type	Package Drawing	Pins	SPQ	Length (mm)	Width (mm)	Height (mm)
ADC3221IRGZR	VQFN	RGZ	48	2500	350.0	350.0	43.0
ADC3222IRGZR	VQFN	RGZ	48	2500	350.0	350.0	43.0
ADC3223IRGZR	VQFN	RGZ	48	2500	350.0	350.0	43.0
ADC3224IRGZR	VQFN	RGZ	48	2500	350.0	350.0	43.0

## GENERIC PACKAGE VIEW

**RGZ 48**

**VQFN - 1 mm max height**

7 x 7, 0.5 mm pitch

PLASTIC QUADFLAT PACK- NO LEAD

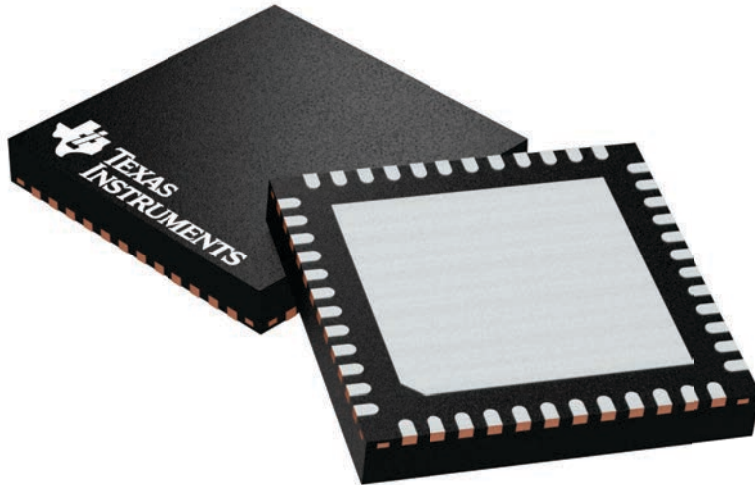

Images above are just a representation of the package family, actual package may vary.  
Refer to the product data sheet for package details.

4224671/A

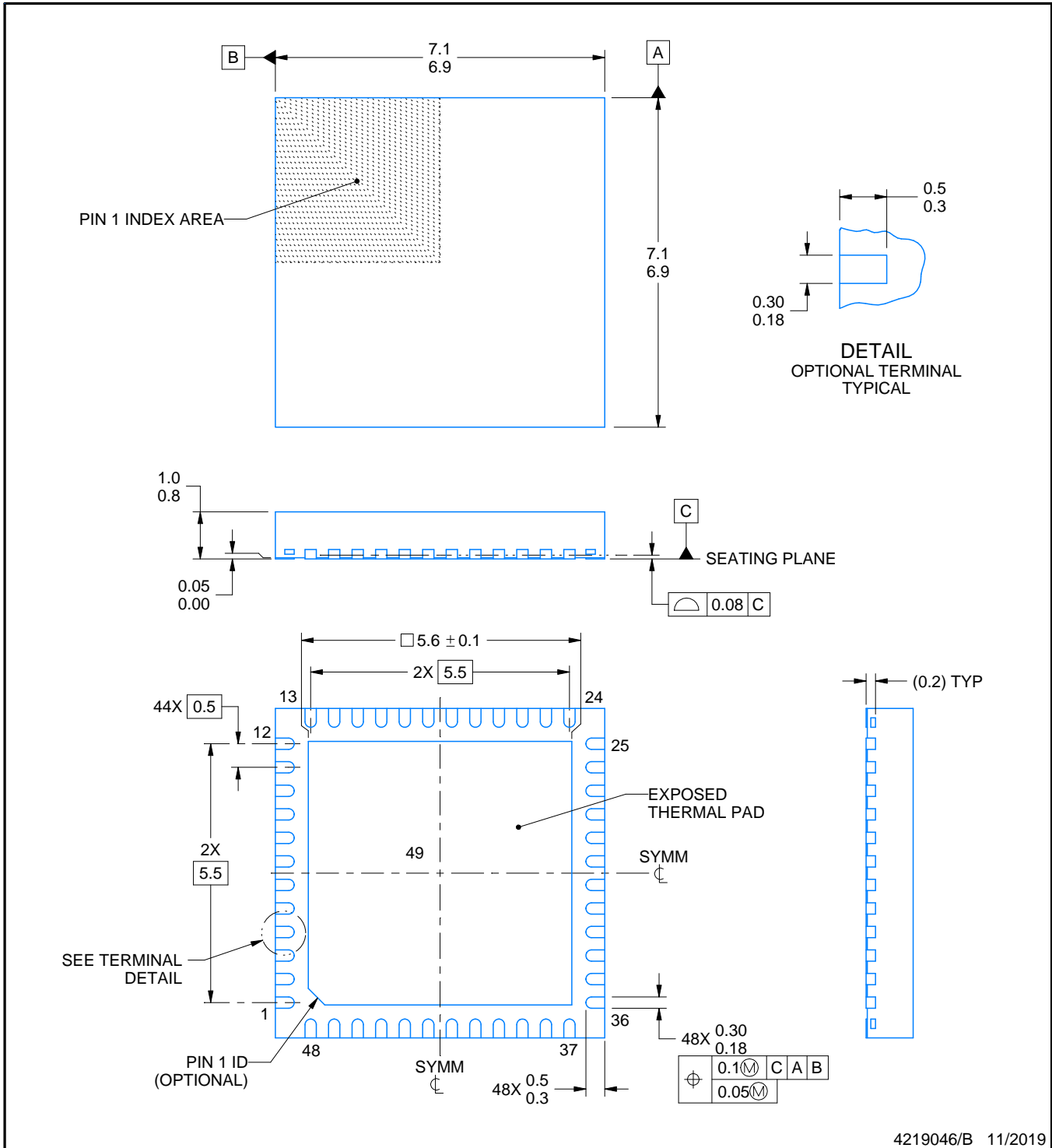
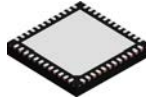

4219046/B 11/2019

NOTES:

1. All linear dimensions are in millimeters. Any dimensions in parenthesis are for reference only. Dimensioning and tolerancing per ASME Y14.5M.
2. This drawing is subject to change without notice.
3. The package thermal pad must be soldered to the printed circuit board for thermal and mechanical performance.

# EXAMPLE BOARD LAYOUT

RGZ0048D

VQFN - 1 mm max height

PLASTIC QUAD FLATPACK - NO LEAD

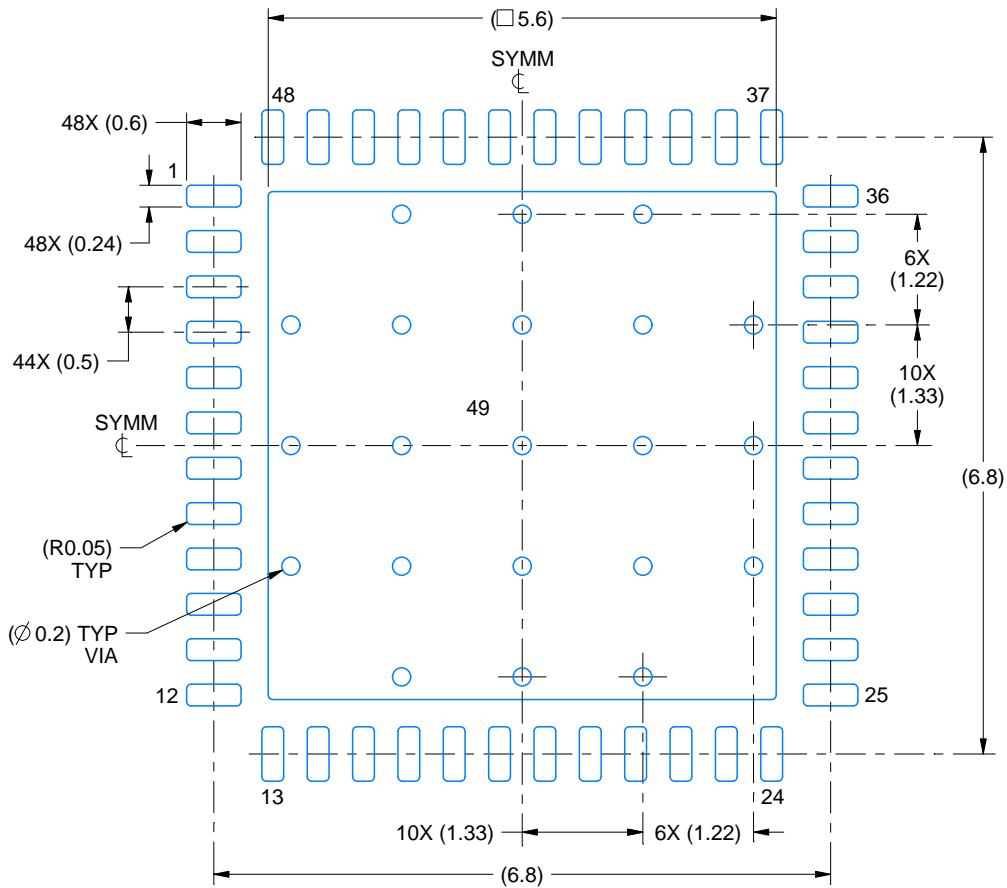

LAND PATTERN EXAMPLE  
EXPOSED METAL SHOWN  
SCALE:12X

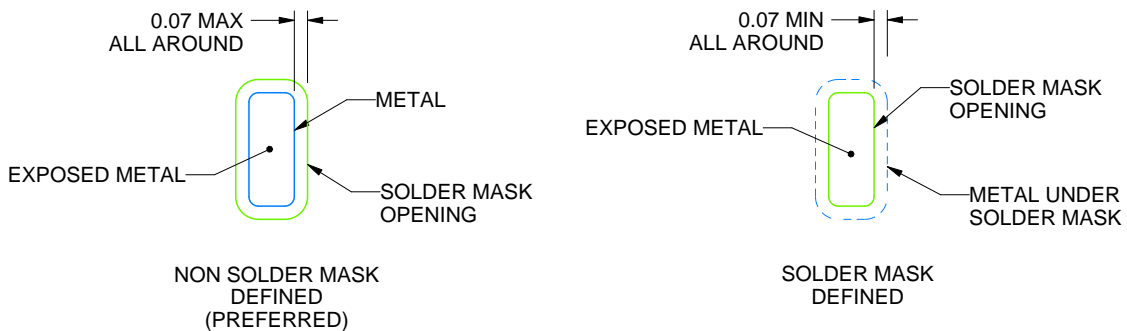

SOLDER MASK DETAILS

4219046/B 11/2019

NOTES: (continued)

4. This package is designed to be soldered to a thermal pad on the board. For more information, see Texas Instruments literature number SLUA271 ([www.ti.com/lit/sluea271](http://www.ti.com/lit/sluea271)).
5. Vias are optional depending on application, refer to device data sheet. If any vias are implemented, refer to their locations shown on this view. It is recommended that vias under paste be filled, plugged or tented.



# EXAMPLE STENCIL DESIGN

RGZ0048D

VQFN - 1 mm max height

PLASTIC QUAD FLATPACK - NO LEAD

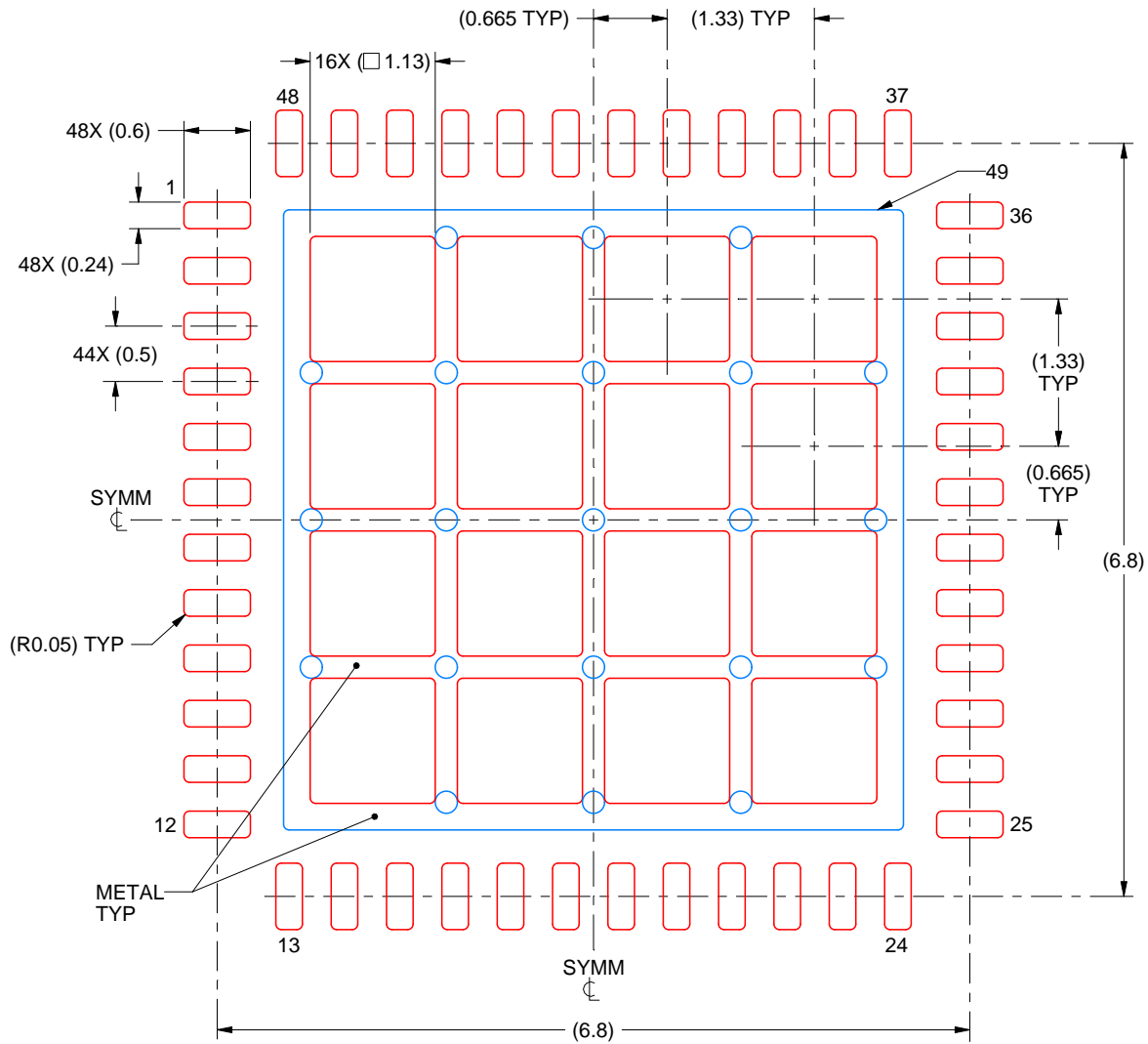

**SOLDER PASTE EXAMPLE**  
 BASED ON 0.125 mm THICK STENCIL

EXPOSED PAD 49  
 66% PRINTED SOLDER COVERAGE BY AREA UNDER PACKAGE  
 SCALE:15X

4219046/B 11/2019

NOTES: (continued)

- 6. Laser cutting apertures with trapezoidal walls and rounded corners may offer better paste release. IPC-7525 may have alternate design recommendations.

## 重要声明和免责声明

TI“按原样”提供技术和可靠性数据（包括数据表）、设计资源（包括参考设计）、应用或其他设计建议、网络工具、安全信息和其他资源，不保证没有瑕疵且不做任何明示或暗示的担保，包括但不限于对适销性、某特定用途方面的适用性或不侵犯任何第三方知识产权的暗示担保。

这些资源可供使用 TI 产品进行设计的熟练开发人员使用。您将自行承担以下全部责任：(1) 针对您的应用选择合适的 TI 产品，(2) 设计、验证并测试您的应用，(3) 确保您的应用满足相应标准以及任何其他功能安全、信息安全、监管或其他要求。

这些资源如有变更，恕不另行通知。TI 授权您仅可将这些资源用于研发本资源所述的 TI 产品的应用。严禁对这些资源进行其他复制或展示。您无权使用任何其他 TI 知识产权或任何第三方知识产权。您应全额赔偿因在这些资源的使用中对 TI 及其代表造成的任何索赔、损害、成本、损失和债务，TI 对此概不负责。

TI 提供的产品受 [TI 的销售条款](#) 或 [ti.com](#) 上其他适用条款/TI 产品随附的其他适用条款的约束。TI 提供这些资源并不会扩展或以其他方式更改 TI 针对 TI 产品发布的适用的担保或担保免责声明。

TI 反对并拒绝您可能提出的任何其他或不同的条款。

邮寄地址：Texas Instruments, Post Office Box 655303, Dallas, Texas 75265

Copyright © 2022，德州仪器 (TI) 公司