

具有电平位移缓冲器 5V 负载开关和静电放电 (ESD) 保护的高清多媒体接口 (HDMI) 伴随芯片

 查询样品: [TPD5S116](#)

特性

- 在无需外部组件的情况下, 符合 **HDMI 控制** 和 **5VOUT** 兼容性测试
- 支持 **HDMI1.3** 和 **HDMI1.4** 标准
- 借助单触发电路, 自动方向感测 **I2C** 电平位移器以驱动 **HDMI** 长电缆 (**750pF** 负载)
- 后驱动保护
- 具有短路保护的 **55mA** 负载开关
- 无铅且符合绿色环保 (**RoHs**) 标准 (与深绿色标准兼容)
- 具有下拉电阻器的热插拔检测模块
- 依据 **HDMI** 规范的集成上拉和下拉电阻
- **IEC61000-4-2 ±15kV** 接触放电额定值
- **IEC61000-4-2 ±15kV** 空气间隙放电额定值
- 针对以太网和音频回授的实用工具引脚 **ESD** 保护

应用范围

- 手机
- 电子书
- 便携式媒体播放器
- 平板电脑

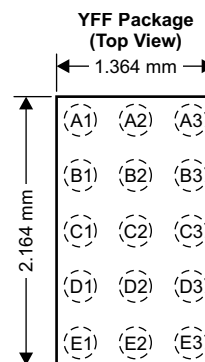

引脚映射 (顶视图)

	1	2	3
A	CEC_SYS	VCCA	CEC_CON
B	SCL_SYS	GND	SCL_CON
C	SDA_SYS	EN	SDA_CON
E	5V_SYS	GND	5V_CON
E	HPD_SYS	UTI_CON	HPD_CON

说明/订购信息

TPD5S116 是一款单芯片 HDMI 接口器件, 此器件具有自动方向感测 I2C 电压电平位移缓冲器, 5V HDMI 兼容限流负载开关, 热插拔检测和一个用于所有连接器侧引脚的集成型 ESD 保护钳位。此器件引脚映射可被路由至 HDMI 类型 D 或类型 C 连接器。内部 3.3V 节点可为 CEC 引脚供电, 从而无需板载 3.3V 电源。

TPD5S116 将所有外部端接电阻集成在 HPD, CEC, SCL 和 SDA 线路上。具有 3 个用于 SDA、SCL 和 CEC 线的同相双向转换电路。每个电路在系统侧上有一个电压范围为 1.1V 至 3.6V 的通用电源轨 (VCCA)。55mA 限流开关将来自 5V_SYS 的电流调节至 5V_CON。SCL 和 SDA 引脚符合 I2C 规范并可驱动高达 750pF 的电容性负载 (超过 HDMI1.4 规范)。HPD_CON 端口配备一个假信号过滤器, 可在插入 HDMI 连接器时避免由插座跳起引起的错误检测。

TPD5S116 在 5V_CON 引脚上提供反向电流阻断。在故障条件下, 例如当两个 HDMI 发送器被连接到同一条 HDMI 线路上, TPD5S116 可确保系统在由外部 HDMI 发送器供电时的安全性。

SCL_CON, SDA_CON, CEC_CON 引脚还特有反向电流阻断特性, 这样可确保在系统断电时, 如果连接了一个 HDMI 接收器, 系统不会产生泄漏电流。

EN 引脚启用热插拔检测和负载开关。在检测到一个有效的 HPD 信号后, 电平位移器被启用。



Please be aware that an important notice concerning availability, standard warranty, and use in critical applications of Texas Instruments semiconductor products and disclaimers thereto appears at the end of this data sheet.



This integrated circuit can be damaged by ESD. Texas Instruments recommends that all integrated circuits be handled with appropriate precautions. Failure to observe proper handling and installation procedures can cause damage.

ESD damage can range from subtle performance degradation to complete device failure. Precision integrated circuits may be more susceptible to damage because very small parametric changes could cause the device not to meet its published specifications.

ORDERING INFORMATION

T _A	PACKAGE ⁽¹⁾ (2)		ORDERABLE PART NUMBER	TOP-SIDE MARKING
-40°C to 85°C	YFF	Tape and reel	TPD5S116YFFR	RE116

(1) Package drawings, thermal data, and symbolization are available at www.ti.com/packaging.

(2) For the most current package and ordering information, see the Package Option Addendum at the end of this document, or see the TI website at www.ti.com.

CIRCUIT SCHEMATIC DIAGRAM

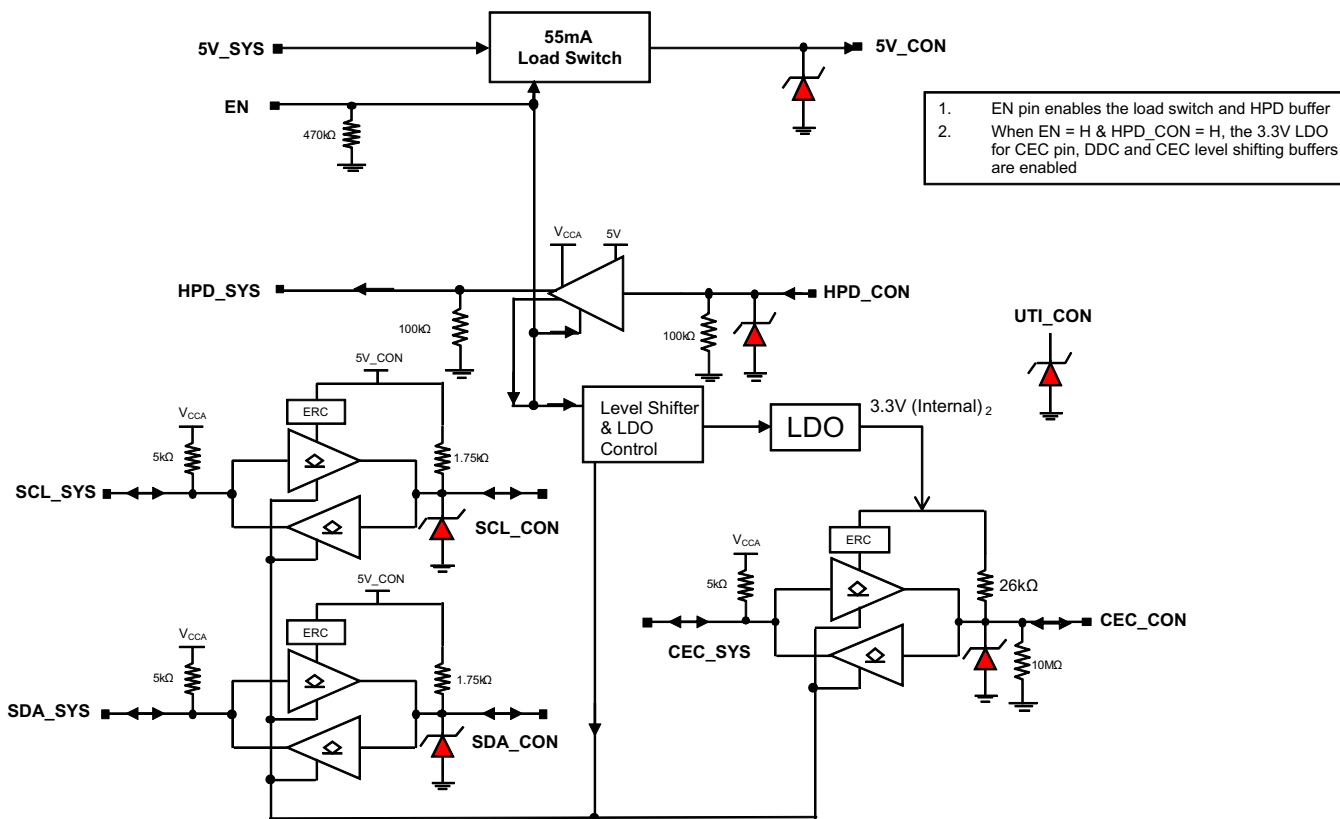

Figure 1. Circuit Schematics

APPLICATION INFORMATION

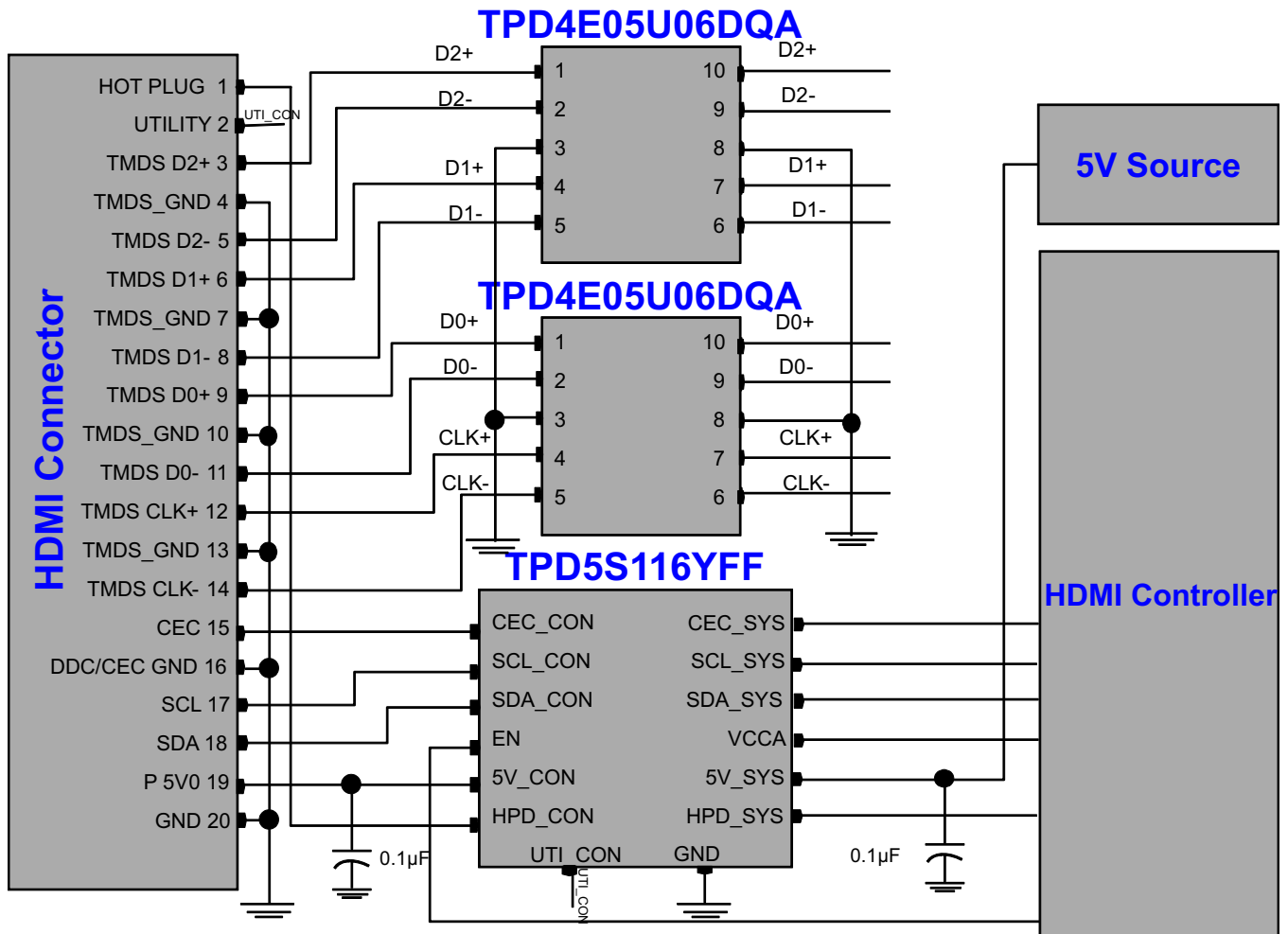

Figure 2. Application Schematics for HDMI Controllers with one GPIO for HDMI Interface Control

HDMI Driver Chip is controlling the TPD5S116 via only one control line (EN). The DDC and CEC level shifting buffers become active after HPD_CON receives a valid high signal and EN is high.

Table 1. FUNCTION TABLE – POWER SAVING OPTIONS

HPD_CON	EN	VCCA	5V_SYS	5V_CON	Dxx_SYS CEC_SYS Pull-ups	DCC_C ON Pull-ups	CEC_CON Pull-ups	CEC LDO	LOAD SW & HPD	DCC/CEC VLTs	ICCA Typ	ICC5V Typ	Comments
L	L	1.2V – 5.0V	5.0V	High-Z	Off	Off	Off	Off	Off	Off	1µA	2µA	Fully Disabled
L	H	1.2V – 5.0V	5.0V	5.0V	On	On	Off	Off	On	Off	1µA	30µA	Load Switch on
H	L	1.2V – 5.0V	5.0V	High-Z	Off	Off	Off	Off	Off	Off	1µA	2µA	Not Valid State
H	H	1.2V – 5.0V	5.0V	5.0V	On	On	On	On	On	On	24µA	125µA	Fully On
X	X	0V	0V	High-Z	High-Z	High-Z	High-Z	Off	Off	Off	0	0	Power Down
X	X	1.2V – 5.0V	0V	High-Z	High-Z	High-Z	High-Z	Off	Off	Off	1	0	Power Down
X	X	0V	5.0V	High-Z	High-Z	High-Z	High-Z	Off	Off	Off	0	1	Power Down

TERMINAL FUNCTIONS

PIN NAME	YFF	PIN TYPE	DESCRIPTION
HPD_SYS	E1	Output	HDMI system side: Hot plug detect Output referenced to VCCA. Connect to HDMI controller Hot plug detect input pin
HPD_CON	E3	Input	HDMI connector side: Hot plug detect Input. Connect directly to HDMI Connector Hot Plug Detect pin
CEC_SYS	A1	IO Port	HDMI system side CEC signal pin referenced to VCCA. Connect to HDMI controller.
CEC_CON	A3	IO Port	HDMI connector side CEC signal pin referenced to internal 3.3V supply. Connect to HDMI connector CEC pin.
SCL_SYS	B1	IO Port	HDMI system side SCL signal pin referenced to VCCA. Connect to HDMI controller.
SCL_CON	B3	IO Port	HDMI connector side SCL signal pin referenced to 5V_CON supply. Connect to HDMI connector SCL pin.
SDA_SYS	C1	IO Port	HDMI system side SDA signal pin referenced to VCCA. Connect to HDMI controller.
SDA_CON	C3	IO Port	HDMI connector side SDA signal pin referenced to 5V_CON supply. Connect to HDMI connector SDA pin.
EN	C2	Control Input	Disables the load switch and HPD when EN =L. The EN pin is referenced to VCCA
UTI_CON	E2	IO Port	Protects the HDMI connector's utility pin
5V_SYS	D1	Input Power	System side PCB 5V supply; input of load switch
VCCA	A2	Input Supply	Internal PCB Low Voltage Supply (Same as the HDMI Controller Chip Supply)
5V_CON	D3	Output Power	HDMI connector side external 5V Supply; output of load switch
GND	B2, D2	Ground	Connect to System Ground Plane

ABSOLUTE MAXIMUM RATINGS⁽¹⁾

over operating free-air temperature range (unless otherwise noted)

PARAMETER		MIN	MAX	UNIT	
V _{CCA}	Supply voltage range	-0.3	6.0	V	
5V_SYS	Supply voltage range	-0.3	6.0	V	
V _I	Input voltage range ⁽²⁾	SCL_SYS, SDA_SYS, CEC_SYS, EN	-0.3	6.0	V
		SCL_CON, SDA_CON, CEC_CON, HPD_CON	-0.3	6.0	
V _O	Voltage range applied to any output in the high-impedance or power-off state ⁽²⁾⁽³⁾	SCL_SYS, SDA_SYS, CEC_SYS, HPD_SYS	-0.3	6.0	V
		SCL_CON, SDA_CON, CEC_CON, HPD_CON	-0.3	6.0	
V _O	Voltage range applied to any output in the high or low state ⁽²⁾⁽³⁾	SCL_SYS, SDA_SYS, CEC_SYS, HPD_SYS	-0.3	V _{CCA} + 0.5	V
		SCL_CON, SDA_CON, CEC_CON	-0.3	5V_SYS + 0.5	
I _{IK}	Input clamp current	V _I < 0		-50	mA
I _{OK}	Output clamp current	V _O < 0		-50	mA
Continuous current through 5V_SYS, or GND				±100	mA
T _{stg}	Storage temperature range	-65	150	°C	

(1) Stresses above these ratings may cause permanent damage. Exposure to absolute maximum conditions for extended periods may degrade device reliability. These are stress ratings only, and functional operation of the device at these or any other conditions beyond those specified is not implied.

(2) The input and output voltage ratings may be exceeded if the input and output clamp-current ratings are observed.

(3) The package thermal impedance is calculated in accordance with JESD 51-7.

RECOMMENDED OPERATING CONDITIONS

over operating free-air temperature range (unless otherwise noted)

PARAMETER		TEST CONDITIONS	MIN	TYP	MAX	UNIT
V _{CCA}	Supply Voltage		1.1		5.5	V
5V _{SYS}	Supply Voltage		4.5		5.5	V
V _{IH}	High-level input voltage	SCL_SYS, SDA_SYS,	V _{CCA} = 1.1 V to 5.5 V	0.7 × V _{CCA}	V _{CCA}	V
		CEC_SYS,	V _{CCA} = 1.1 V to 5.5 V	0.7 × V _{CCA}	V _{CCA}	V
		EN	V _{CCA} = 1.1 V to 5.5 V	1.0	V _{CCA}	V
		SCL_CON, SDA_CON,	5V _{SYS} = 5.5 V	0.7 × 5V _{SYS}	5V _{SYS}	V
		CEC_CON	5V _{SYS} = 5.5 V	0.7 × V _{3P3}	V _{3P3}	
		HPD_CON	5V _{SYS} = 5.5 V	2.0	5V _{SYS}	
V _{IL}	Low-level input voltage	SCL_SYS, SDA_SYS,	V _{CCA} = 1.1 V to 5.5 V	−0.5	0.082 × V _{CCA}	V
		CEC_SYS,	V _{CCA} = 1.1 V to 5.5 V	−0.5	0.082 × V _{CCA}	V
		EN	V _{CCA} = 1.1 V to 5.5 V	−0.5	0.4	V
		SCL_CON, SDA_CON,	5V _{SYS} = 5.5 V	−0.5	0.3 × 5V _{SYS}	V
		CEC_CON	5V _{SYS} = 5.5 V	−0.5	0.3 × V _{3P3}	V
		HPD_CON	5V _{SYS} = 5.5 V	0	0.8	V
V _{ILC}	(contention) Low-level input voltage	SCL_SYS, SDA_SYS, CEC_SYS	V _{CCA} = 1.1 V to 5.5 V	−0.5	0.0524 × V _{CCA}	V
V _{OL} – V _{ILC}	Delta between VOL and VILC	SCL_SYS, SDA_SYS, CEC_SYS	V _{CCA} = 1.8 V	0.1 × V _{CCA}		mV
T _A	Operating free-air temperature		−40		85	°C

ESD TABLE

over operating free-air temperature range (unless otherwise noted)

PARAMETER	SIGNALS	TYP	UNIT
HBM ESD	SCL_SYS, SDA_SYS, CEC_SYS, HPD_SYS, 5V _{SYS} , V _{CCA} , EN	±2	kV
IEC 61000-4-2 Contact Discharge	SCL_CON, SDA_CON, CEC_CON, HPD_CON, 5V_CON, UTI_CON	±15	kV
IEC 61000-4-2 Air-gap ESD	SCL_CON, SDA_CON, CEC_CON, HPD_CON, 5V_CON, UTI_CON	±15	kV

ELECTRICAL CHARACTERISTICS

Max values measured across temp and VCCA=1.1V to 5.5V and 5V_SYS=5.5V. Typical values measured at VCCA=1.8V and 5V_SYS=5V (unless otherwise noted)

PARAMETER		TEST CONDITIONS	MIN	TYP	MAX	UNIT
Supply Current						
I _{CC5V}	Disabled	5V_SYS =5V, 5V_CON =Open EN = GND, HPD_CON=GND		2	10	μA
	Load Switch active	5V_SYS =5V, 5V_CON =Open EN = VCCA, HPD_CON=GND		30	50	μA
	Active	5V_SYS =5V, 5V_CON =Open EN = VCCA, HPD_CON=5V		125	200	μA
Load Switch						
V _{REV}	Reverse voltage comparator trip point	5V_SYS=4V, 5V_CON > 5V_SYS		100		mV
I _{OFF}	Leakage Current	5V_CON=0V, 5V_SYS=5V, EN=GND, HPD_CON=GND Measured at 5V_SYS pin.		1	5	μA
		5V_CON=0V, 5V_SYS=5V, EN=GND, HPD_CON=5V Measured at 5V_SYS pin		1	5	μA
		5V_CON =5V, 5V_SYS =0V, EN=GND, HPD_CON=GND Measured at 5V_CON pin.		1	5	μA
		5V_CON =5V, 5V_SYS =0V EN=GND, HPD_CON=5V Measured at 5V_CON pin.		1	5	μA
		5V_CON =5V, 5V_SYS =0V, EN=VCCA, HPD_CON=GND Measured at 5V_CON pin.		1	5	μA
		5V_CON =5V, 5V_SYS =0V, EN=VCCA, HPD_CON=5V Measured at 5V_CON pin.		1	5	μA
I _{SC}	Short circuit current at 5V_CON	5V_SYS=5V, 5V_CON = GND	110	140	170	mA
T _{DEGLITCH}	Deglintch time against false short	5V_SYS=5V, EN=VCCA, Short 5V_CON		3		μs
UVLO	Under voltage lockout rising	5V_SYS=0V to 5V, RL = 100 Ω, CL = 1μF		2.85		V
UVLO_HYS	Under voltage lockout falling hysteresis	5V_SYS=5V to 0V, RL = 100 Ω, CL = 1μF		200		mV
V _{DROP}	5V_OUT output voltage drop	5V_SYS =5V, I5V_OUT = 55 mA		38.5	55	mV
I _{RUSH}	Inrush Current	5V_SYS=5V, RL=100 Ω, Cin=10μF, C=1μF		140		mA
T _{ON}	Turn on Time, EN to 5V_CON	5V_SYS=5V, RL=100 Ω, Cin=10μF, C=1μF		92.3		μs
T _{OFF}	Turn off Time, EN to 5V_CON	5V_SYS=5V, RL=100 Ω, Cin=10μF, C=1μF		5		μs
T _{SHUT}	Thermal Shutdown	Shutdown threshold, TRIP ⁽¹⁾		166		°C
		HYST ⁽²⁾		23		

(1) The TPD5S116 turns off after the device temperature reaches the TRIP temperature.

(2) Once the thermal shut-down circuit turns off the load switch, the switch turns on again after the device junction temperature cools down to a temperature equals to or less than TRIP-HYST.

Voltage Level Shifter - SCL, SDA Lines

PARAMETER	TEST CONDITIONS		V _{CCA}	-40°C to 85°C			UNIT
				MIN	TYP	MAX	
V _{OH_SYS}	I _{OH} = -10 μA	V _I = V _{IH}		0.8 × V _{CCA}		V _{CCA} +0.02	V
V _{OL_SYS}	I _{OL} = 10 μA	V _I = V _{IL}				0.17 × V _{CCA}	V
V _{OH_CON}	I _{OH} = -10 μA	V _I = V _{IH}		0.8 × 5V _{SYS}		5V _{SYS} +0.02	V
V _{OL_CON}	I _{OH} = 3 mA	V _I = V _{IL}			0.3	0.4	V
ΔVT Hysteresis at the SDx_IN (VT+ - VT-)					40		mV
ΔVT Hysteresis at the SDx_OUT (VT+ - VT-)					400		mV
R _{PU} (Internal pull-up)	SCL_SYS, SDA_SYS	Pull-up connected to V _{CCA} rail			5		kΩ
	SCL_CON, SDA_CON	Pull-up connected to 5V rail			1.75		
I _{PULLUPAC} Transient Boosted Pull-up Current (rise-time accelerator)		SCL_CON, SDA_CON	Pull-up connected to 5V rail		13		mA
I _{off}	SYS Port	V _{CCA} = 0V, V _I or V _O = 0 to 3.6 V	0 V			±5	μA
	CON Port	5V _{CON} =0V, V _I or V _O = 0 to 5.5 V	0 V			±5	
I _{OZ}	SYS Port	V _I = V _{CCI} or GND				±5	

Voltage Level Shifter - CEC Line

PARAMETER	TEST CONDITIONS		V _{CCA}	-40°C to 85°C			UNIT
				MIN	TYP	MAX	
V _{OH_SYS}	I _{OH} = -10 μA	V _I = V _{IH}		0.8 × V _{CCA}		V _{CCA} +0.02	V
V _{OL_SYS}	I _{OL} = 10 μA	V _I = V _{IL}				0.17 × V _{CCA}	V
V _{OH_CON}	I _{OH} = -10 μA	V _I = V _{IH}		0.8 × V _{3P3}			V
V _{OL_CON}	I _{OH} = 3 mA	V _I = V _{IL}			0.3	0.4	V
ΔVT Hysteresis at the CEC_SYS (VT+ - VT-)					30		mV
ΔVT Hysteresis at the CEC_CON (VT+ - VT-)					283		mV
R _{PU} (Internal pull-up)	CEC_SYS	Pull-up connected to V _{CCA} rail			5		kΩ
	CEC_CON	Pull-up connected to 3.3V rail		22	26	30	
R _{PD} (Internal pull-down)		CEC_CON	Pull-down connected connector side		10		MΩ
I _{off}	SYS Port	V _{CCA} = 0V, V _I or V _O = 0 to 3.6 V	0 V			±5	μA
	CON Port	5V _{CON} =0V, V _I or V _O = 0 to 5.5 V	0 V			±1.8	
I _{OZ}	SYS Port	V _I = V _{CCI} or GND				±5	

Voltage Level Shifter - HPD Line

PARAMETER	TEST CONDITIONS		V _{CCA}	–40°C to 85°C			UNIT
				MIN	TYP	MAX	
V _{OH_SYS}	I _{OH} = 1 mA	V _I = V _{IH}	1.2 V to 5.0 V	V _{CCA} × 0.7			V
V _{OH_SYS_1P1}	I _{OH} = 100 μA	V _I = V _{IH}	1.1V	V _{CCA} × 0.7			V
V _{OL_SYS}	I _{OL} = 3 μA	V _I = V _{IL}	1.2 V to 5.0 V	0.4			V
V _{OL_SYS_1P1}	I _{OL} = 3 mA	V _I = V _{IL}	1.1 V	0.68			V
ΔVT Hysteresis at the CEC_CON (VT+ - VT-)			1.2 V to 5.0 V	500			mV
R _{PD_IN} (Input internal pull-down resistor)		Pull-down connected to GND		60	100	140	kΩ
R _{PD_OUT} (Output internal pull-down resistor)		Pull-down connected to GND		60	100	140	kΩ
TFILT	Glitch Filter Duration	HPD_CON = 5 V, EN = V _{CCA} , Short HPD_SYS		10			μs

EN

PARAMETER	TEST CONDITIONS	V _{CCA}	–40°C to 85°C			UNIT
			MIN	TYP	MAX	
R _{PD_EN} (Internal pull-down resistor)	Pull-down connected to GND	1.8 V		470		kΩ

UTILITY PIN

PARAMETER	DESCRIPTION	TEST CONDITIONS	MIN	TYP	MAX	UNIT
V _{RWM}	Reverse stand-off voltage				6	V
V _{CLAMP}	Clamp voltage with ESD strike	IPP = 1 A, tp = 8/20 μSec, from I/O to GND ⁽¹⁾		8		V
		IPP = 5 A, tp = 8/20 μSec, , from I/O to GND ⁽¹⁾		10		
R _{DYN}	Dynamic resistance	UTI pin to GND Pin ⁽²⁾		033		Ω
C _{UTI}	Line capacitance	V _{IO} =0V, f=1GHz, I/O to GND		5.5		pF
V _{BR}	Break-down voltage	I _{IO} = 1mA	7			V
I _{LEAK}	Leakage current	V _{IO} = 3V		1	10	nA

(1) Non-repetitive current pulse 8/20us exponentially decaying waveform according to IEC61000-4-5

(2) Extraction of RDYN using least squares fit of TLP characteristics between I=10A and I=20A

I/O Capacitances

PARAMETER		TEST CONDITONS	SUPPLY & EN SIGNAL	-40°C to 85°C			UNIT
				MIN	TYP	MAX	
C _I	EN	V _{BIAS} = V _{CCA} /2, f =1MHz, 30mV p-p ac signal		8	9	pF	
C _I	HPD_CON	V _{BIAS} = 0V- 5V, f =1MHz, 30mV p-p ac signal		7	7.5	pF	
C _{IO}	SYS port	V _{BIAS} = 1.8 V, f =1MHz, 30mV p-p ac signal		6.5	9.5	pF	
	CON port	V _{BIAS} = 2.5 V, f =1MHz, 30mV p-p ac signal		15	20	pF	
	SCL_CON, SDA_CON	V _{BIAS} = 2.5V, f =100KHz, 3.5V p-p ac signal	V _{CCA} = 3.6 V, 5V_SYS =5V, EN=HPD_CON=0 V	17		pF	
	CEC_CON	V _{BIAS} = 1.65 V, f =100KHz, 2.5V p-p ac signal	V _{CCA} = 3.6 V, 5V_SYS =5V, EN=HPD_CON=0 V	13		pF	
	CEC_CON	V _{BIAS} = 1.65 V, f =100KHz, 2.5V p-p ac signal	V _{CCA} = 0V 5V_SYS =0V EN=HPD_CON=0 V	12		pF	

Dynamic Load Characteristics

Propagation delays measured from 50% threshold to 50% threshold

Rise time measured from 30% to 70% threshold

Fall time measured from 70% to 30% threshold

PARAMETER	DESCRIPTION	TEST CONDITION	MIN	TYP	Max	UNIT
CL	Bus Load Capacitance (Connector Side)				750	pF
	Bus Load Capacitance (System Side)				30	

Dynamic Characteristics - SCL, SDA Lines

5V_CON=5V; VCCA = 1.2V

PARAMETER	DESCRIPTION	PINS	TEST CONDITIONS	MIN	TYP	MAX	UNIT
T _{PHL}	Propagation Delay	SYS to CON	DDC Channels Enabled		316		ns
		CON to SYS	DDC Channels Enabled		286		ns
T _{PLH}	Propagation Delay	SYS to CON	DDC Channels Enabled		489		ns
		CON to SYS	DDC Channels Enabled		199		ns
T _{FALL}	SYS Port Fall Time	SYS Port	DDC Channels Enabled		110		ns
T _{FALL}	CON Port Fall Time	CON Port	DDC Channels Enabled		82		ns
T _{RISE}	SYS Port Rise Time	SYS Port	DDC Channels Enabled		229		ns
T _{RISE}	CON Port Rise Time	CON Port	DDC Channels Enabled		86		ns
F _{MAX}	Maximum Switching Frequency		DDC Channels Enabled	400			kHz

Dynamic Characteristics - CEC Lines

5V_CON=5V; VCCA = 1.2V

PARAMETER	DESCRIPTION	PINS	TEST CONDITIONS	MIN	TYP	MAX	UNIT
T _{PHL}	Propagation Delay	SYS to CON	CEC Channels Enabled		436		ns
		CON to SYS	CEC Channels Enabled		97		ns
T _{PLH}	Propagation Delay	SYS to CON	CEC Channels Enabled		13.8		μs
		CON to SYS	CEC Channels Enabled		319		ns
T _{FALL}	SYS Port Fall Time	SYS Port	CEC Channels Enabled		37		ns
T _{FALL}	CON Port Fall Time	CON Port	CEC Channels Enabled		114		ns
T _{RISE}	SYS Port Rise Time	SYS Port	CEC Channels Enabled		234		ns
T _{RISE}	CON Port Rise Time	CON Port	CEC Channels Enabled		16.6		μs

Dynamic Characteristics - HPD Lines

5V_CON=5V; VCCA = 1.2V

PARAMETER	DESCRIPTION	PINS	TEST CONDITIONS	MIN	TYP	MAX	UNIT
T _{PHL}	Propagation Delay	CON to SYS	CEC Channels Enabled		10.1		μs
T _{PLH}	Propagation Delay	CON to SYS	CEC Channels Enabled		9.7		μs
T _{FALL}	SYS Port Fall Time	SYS Port	CEC Channels Enabled		14		ns
T _{RISE}	SYS Port Rise Time	SYS Port	CEC Channels Enabled		18		ns

Dynamic Characteristics - SCL, SDA Lines

5V_CON=5V; VCCA = 1.5V

PARAMETER	DESCRIPTION	PINS	TEST CONDITIONS	MIN	TYP	MAX	UNIT
T _{PHL}	Propagation Delay	A to B	DDC Channels Enabled		297		ns
		B to A	DDC Channels Enabled		224		ns
T _{PLH}	Propagation Delay	A to B	DDC Channels Enabled		473		ns
		B to A	DDC Channels Enabled		193		ns
T _{FALL}	A Port Fall Time	A-Port	DDC Channels Enabled		87		ns
T _{FALL}	B Port Fall Time	B-Port	DDC Channels Enabled		82		ns
T _{RISE}	A Port Rise Time	A-Port	DDC Channels Enabled		226		ns
T _{RISE}	B Port Rise Time	B-Port	DDC Channels Enabled		86		ns
F _{MAX}	Maximum Switching Frequency		DDC Channels Enabled	400			kHz

Dynamic Characteristics - CEC Lines

5V_CON=5V; VCCA = 1.5V

PARAMETER	DESCRIPTION	PINS	TEST CONDITIONS	MIN	TYP	MAX	UNIT
T _{PHL}	Propagation Delay	A to B	CEC Channels Enabled		419		ns
		B to A	CEC Channels Enabled		102		ns
T _{PLH}	Propagation Delay	A to B	CEC Channels Enabled		13.7		μs
		B to A	CEC Channels Enabled		314		ns
T _{FALL}	A Port Fall Time	A-Port	CEC Channels Enabled		39		ns
T _{FALL}	B Port Fall Time	B-Port	CEC Channels Enabled		115		ns
T _{RISE}	A Port Rise Time	A-Port	CEC Channels Enabled		230		ns
T _{RISE}	B Port Rise Time	B-Port	CEC Channels Enabled		16.6		μs

Dynamic Characteristics - HPD Lines

5V_CON=5V; VCCA = 1.5V

PARAMETER	DESCRIPTION	PINS	TEST CONDITIONS	MIN	TYP	MAX	UNIT
T _{PHL}	Propagation Delay	B to A	CEC Channels Enabled		10.1		μs
T _{PLH}	Propagation Delay	B to A	CEC Channels Enabled		9.7		μs
T _{FALL}	A Port Fall Time	A-Port	CEC Channels Enabled		8		ns
T _{RISE}	A Port Rise Time	A-Port	CEC Channels Enabled		9.5		ns

Dynamic Characteristics - SCL, SDA Lines

5V_CON=5V; VCCA = 1.8V

PARAMETER	DESCRIPTION	PINS	TEST CONDITIONS	MIN	TYP	MAX	UNIT
T _{PHL}	Propagation Delay	A to B	DDC Channels Enabled		292		ns
		B to A	DDC Channels Enabled		192		ns
T _{PLH}	Propagation Delay	A to B	DDC Channels Enabled		466		ns
		B to A	DDC Channels Enabled		190		ns
T _{FALL}	A Port Fall Time	A-Port	DDC Channels Enabled		75		ns
T _{FALL}	B Port Fall Time	B-Port	DDC Channels Enabled		82		ns
T _{RISE}	A Port Rise Time	A-Port	DDC Channels Enabled		224		ns
T _{RISE}	B Port Rise Time	B-Port	DDC Channels Enabled		86		ns
F _{MAX}	Maximum Switching Frequency		DDC Channels Enabled	400			kHz

Dynamic Characteristics - CEC Lines

5V_CON=5V; VCCA = 1.8V

PARAMETER	DESCRIPTION	PINS	TEST CONDITIONS	MIN	TYP	MAX	UNIT
T _{PHL}	Propagation Delay	A to B	CEC Channels Enabled		417		ns
		B to A	CEC Channels Enabled		108		ns
T _{PLH}	Propagation Delay	A to B	CEC Channels Enabled		13.7		μs
		B to A	CEC Channels Enabled		312		ns
T _{FALL}	A Port Fall Time	A-Port	CEC Channels Enabled		41		ns
T _{FALL}	B Port Fall Time	B-Port	CEC Channels Enabled		114		ns
T _{RISE}	A Port Rise Time	A-Port	CEC Channels Enabled		228		ns
T _{RISE}	B Port Rise Time	B-Port	CEC Channels Enabled		16.6		μs

Dynamic Characteristics - HPD Lines

5V_CON=5V; VCCA = 1.8V

PARAMETER	DESCRIPTION	PINS	TEST CONDITIONS	MIN	TYP	MAX	UNIT
T _{PHL}	Propagation Delay	B to A	CEC Channels Enabled		10.1		μs
T _{PLH}	Propagation Delay	B to A	CEC Channels Enabled		9.7		μs
T _{FALL}	A Port Fall Time	A-Port	CEC Channels Enabled		5.5		ns
T _{RISE}	A Port Rise Time	A-Port	CEC Channels Enabled		7		ns

Dynamic Characteristics - SCL, SDA Lines

5V_CON=5V; VCCA = 2.5V

PARAMETER	DESCRIPTION	PINS	TEST CONDITIONS	MIN	TYP	MAX	UNIT
T _{PHL}	Propagation Delay	A to B	DDC Channels Enabled		291		ns
		B to A	DDC Channels Enabled		154		ns
T _{PLH}	Propagation Delay	A to B	DDC Channels Enabled		455		ns
		B to A	DDC Channels Enabled		186		ns
T _{FALL}	A Port Fall Time	A-Port	DDC Channels Enabled		64		ns
T _{FALL}	B Port Fall Time	B-Port	DDC Channels Enabled		82		ns
T _{RISE}	A Port Rise Time	A-Port	DDC Channels Enabled		221		ns
T _{RISE}	B Port Rise Time	B-Port	DDC Channels Enabled		86		ns
F _{MAX}	Maximum Switching Frequency		DDC Channels Enabled	400			kHz

Dynamic Characteristics - CEC Lines

5V_CON=5V; VCCA = 2.5V

PARAMETER	DESCRIPTION	PINS	TEST CONDITIONS	MIN	TYP	MAX	UNIT
T _{PHL}	Propagation Delay	A to B	CEC Channels Enabled		421		ns
		B to A	CEC Channels Enabled		122		ns
T _{PLH}	Propagation Delay	A to B	CEC Channels Enabled		13.7		μs
		B to A	CEC Channels Enabled		311		ns
T _{FALL}	A Port Fall Time	A-Port	CEC Channels Enabled		49		ns
T _{FALL}	B Port Fall Time	B-Port	CEC Channels Enabled		114		ns
T _{RISE}	A Port Rise Time	A-Port	CEC Channels Enabled		225		ns
T _{RISE}	B Port Rise Time	B-Port	CEC Channels Enabled		16.6		μs

Dynamic Characteristics - HPD Lines

5V_CON=5V; VCCA = 2.5V

PARAMETER	DESCRIPTION	PINS	TEST CONDITIONS	MIN	TYP	MAX	UNIT
T _{PHL}	Propagation Delay	B to A	CEC Channels Enabled		10.1		μs
T _{PLH}	Propagation Delay	B to A	CEC Channels Enabled		9.7		μs
T _{FALL}	A Port Fall Time	A-Port	CEC Channels Enabled		4		ns
T _{RISE}	A Port Rise Time	A-Port	CEC Channels Enabled		5		ns

Dynamic Characteristics - SCL, SDA Lines

5V_CON=5V; VCCA = 3.3V

PARAMETER	DESCRIPTION	PINS	TEST CONDITIONS	MIN	TYP	MAX	UNIT
T _{PHL}	Propagation Delay	A to B	DDC Channels Enabled		292		ns
		B to A	DDC Channels Enabled		133		ns
T _{PLH}	Propagation Delay	A to B	DDC Channels Enabled		449		ns
		B to A	DDC Channels Enabled		184		ns
T _{FALL}	A Port Fall Time	A-Port	DDC Channels Enabled		57		ns
T _{FALL}	B Port Fall Time	B-Port	DDC Channels Enabled		82		ns
T _{RISE}	A Port Rise Time	A-Port	DDC Channels Enabled		218		ns
T _{RISE}	B Port Rise Time	B-Port	DDC Channels Enabled		86		ns
F _{MAX}	Maximum Switching Frequency		DDC Channels Enabled	400			kHz

Dynamic Characteristics - CEC Lines

5V_CON=5V; VCCA = 3.3V

PARAMETER	DESCRIPTION	PINS	TEST CONDITIONS	MIN	TYP	MAX	UNIT
T _{PHL}	Propagation Delay	A to B	CEC Channels Enabled		428		ns
		B to A	CEC Channels Enabled		138		ns
T _{PLH}	Propagation Delay	A to B	CEC Channels Enabled		13.7		μs
		B to A	CEC Channels Enabled		309		ns
T _{FALL}	A Port Fall Time	A-Port	CEC Channels Enabled		59		ns
T _{FALL}	B Port Fall Time	B-Port	CEC Channels Enabled		114		ns
T _{RISE}	A Port Rise Time	A-Port	CEC Channels Enabled		223		ns
T _{RISE}	B Port Rise Time	B-Port	CEC Channels Enabled		16.6		μs

Dynamic Characteristics - HPD Lines

5V_CON=5V; VCCA = 3.3V

PARAMETER	DESCRIPTION	PINS	TEST CONDITIONS	MIN	TYP	MAX	UNIT
T _{PHL}	Propagation Delay	B to A	CEC Channels Enabled		10.1		μs
T _{PLH}	Propagation Delay	B to A	CEC Channels Enabled		9.7		μs
T _{FALL}	A Port Fall Time	A-Port	CEC Channels Enabled		3		ns
T _{RISE}	A Port Rise Time	A-Port	CEC Channels Enabled		3.5		ns

Dynamic Characteristics - SCL, SDA Lines

5V_CON=5V; VCCA = 5V

PARAMETER	DESCRIPTION	PINS	TEST CONDITIONS	MIN	TYP	MAX	UNIT
T _{PHL}	Propagation Delay	A to B	DDC Channels Enabled		298		ns
		B to A	DDC Channels Enabled		113		ns
T _{PLH}	Propagation Delay	A to B	DDC Channels Enabled		442		ns
		B to A	DDC Channels Enabled		182		ns
T _{FALL}	A Port Fall Time	A-Port	DDC Channels Enabled		52		ns
T _{FALL}	B Port Fall Time	B-Port	DDC Channels Enabled		82		ns
T _{RISE}	A Port Rise Time	A-Port	DDC Channels Enabled		217		ns
T _{RISE}	B Port Rise Time	B-Port	DDC Channels Enabled		86		ns
F _{MAX}	Maximum Switching Frequency		DDC Channels Enabled	400			kHz

Dynamic Characteristics - CEC Lines

5V_CON=5V; VCCA = 5V

PARAMETER	DESCRIPTION	PINS	TEST CONDITIONS	MIN	TYP	MAX	UNIT
T _{PHL}	Propagation Delay	A to B	CEC Channels Enabled		446		ns
		B to A	CEC Channels Enabled		169		ns
T _{PLH}	Propagation Delay	A to B	CEC Channels Enabled		13.7		µs
		B to A	CEC Channels Enabled		306		ns
T _{FALL}	A Port Fall Time	A-Port	CEC Channels Enabled		82		ns
T _{FALL}	B Port Fall Time	B-Port	CEC Channels Enabled		114		ns
T _{RISE}	A Port Rise Time	A-Port	CEC Channels Enabled		221		ns
T _{RISE}	B Port Rise Time	B-Port	CEC Channels Enabled		16.6		µs

Dynamic Characteristics - HPD Lines

5V_CON=5V; VCCA = 5V

PARAMETER	DESCRIPTION	PINS	TEST CONDITIONS	MIN	TYP	MAX	UNIT
T _{PHL}	Propagation Delay	B to A	CEC Channels Enabled		10.1		µs
T _{PLH}	Propagation Delay	B to A	CEC Channels Enabled		9.7		µs
T _{FALL}	A Port Fall Time	A-Port	CEC Channels Enabled		2.5		ns
T _{RISE}	A Port Rise Time	A-Port	CEC Channels Enabled		2.5		ns

TYPICAL CHARACTERISTICS

Conditions TBD

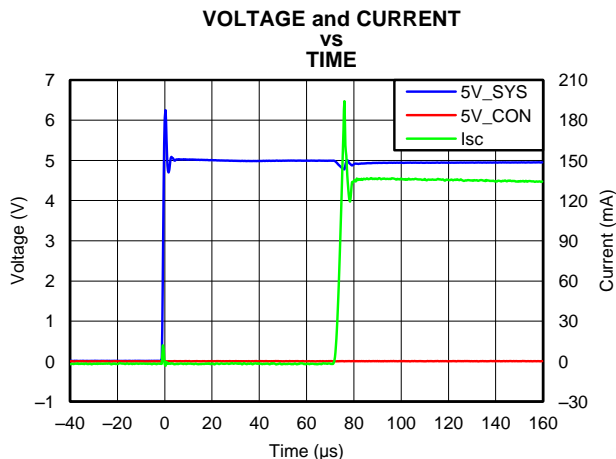

Figure 3. Powerup to Short Circuit

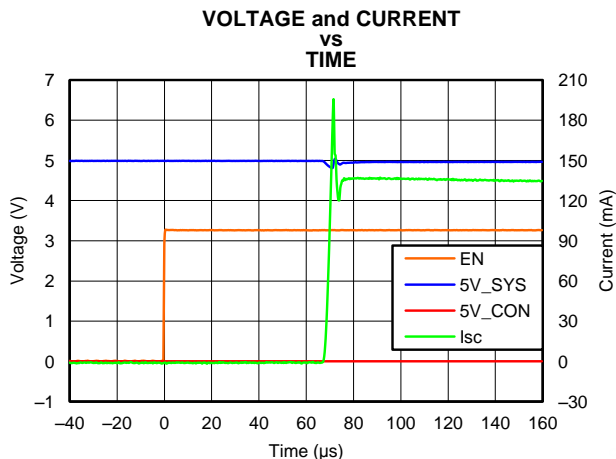

Figure 4. Enable to Short Circuit

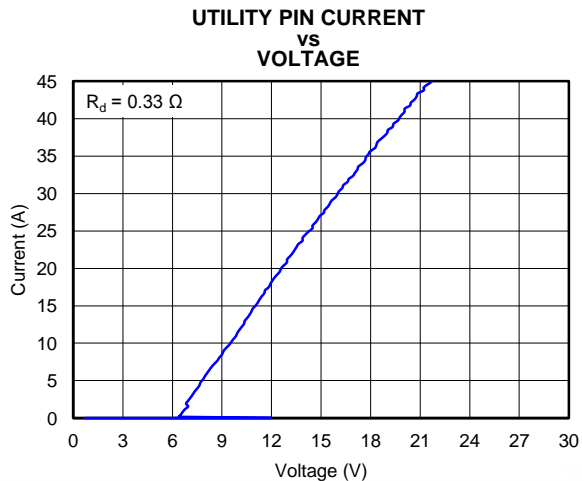

Figure 5. TLP Curve

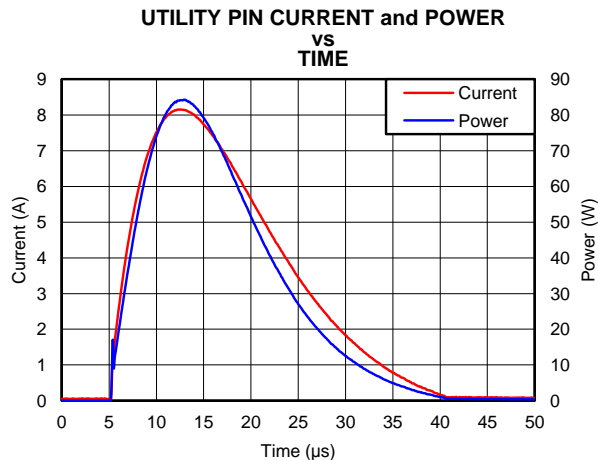

Figure 6. Surge Curves

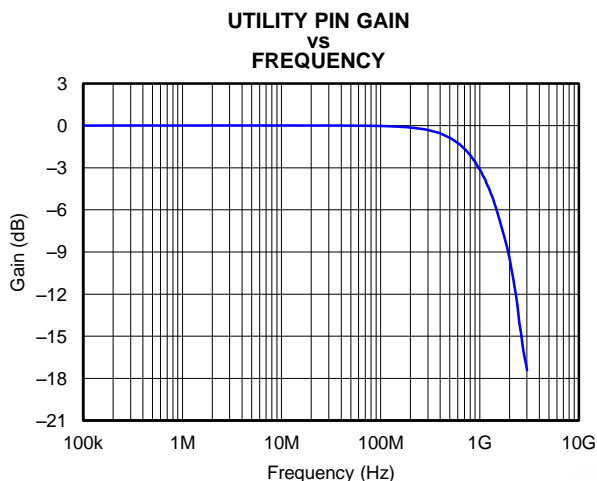

Figure 7. Insertion Loss Waveform Data

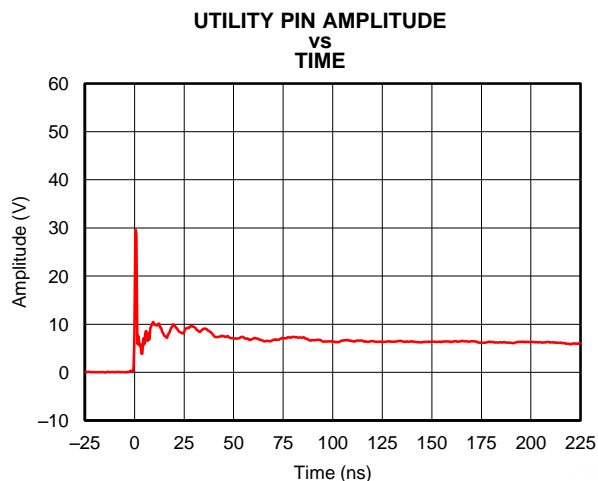

Figure 8. Keytek, +8kV IEC Voltage Clamp Waveform

TYPICAL CHARACTERISTICS (continued)

Conditions TBD

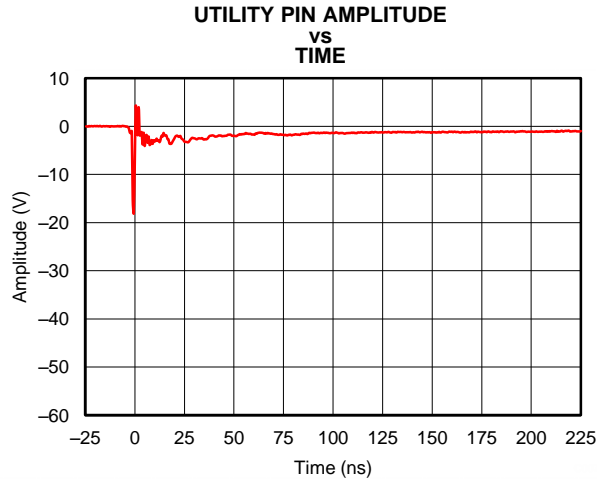

Figure 9. Keytek, -8kV IEC Voltage Clamp Waveform

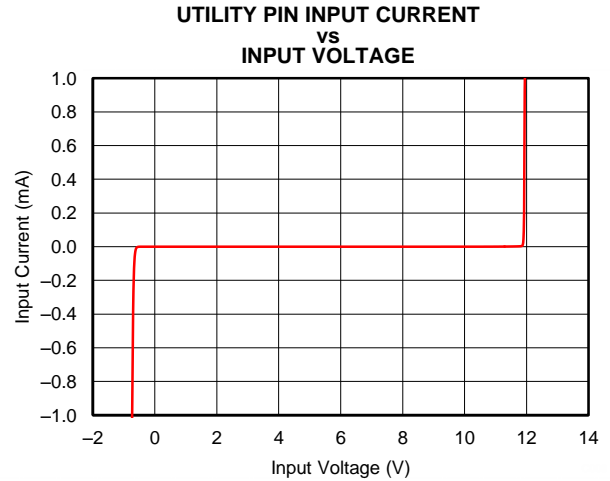

Figure 10. DC Curve Data

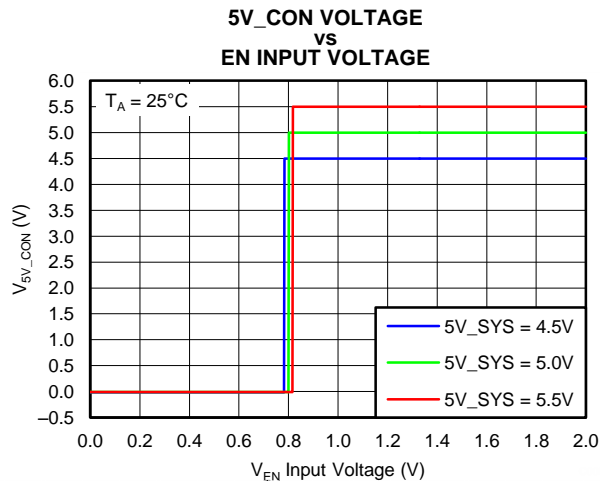

Figure 11. EN V_{TH}

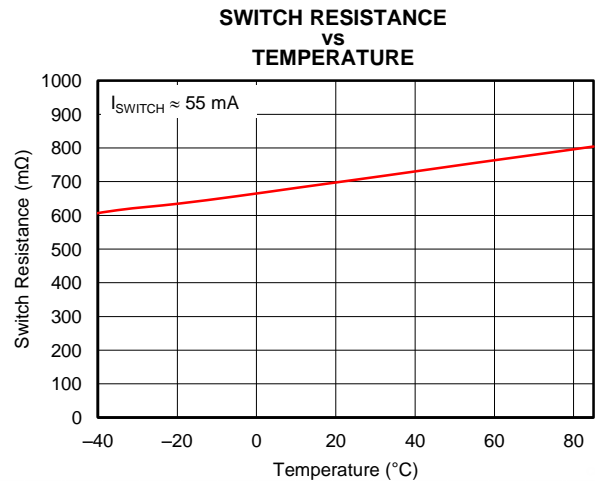

Figure 12. Rds Data

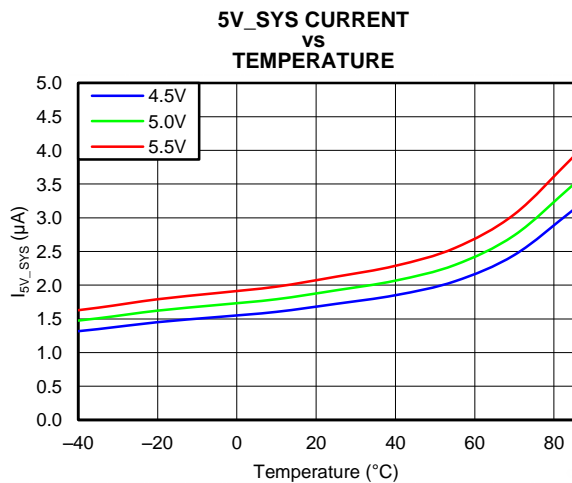

Figure 13. I_{5V_SYS} Data

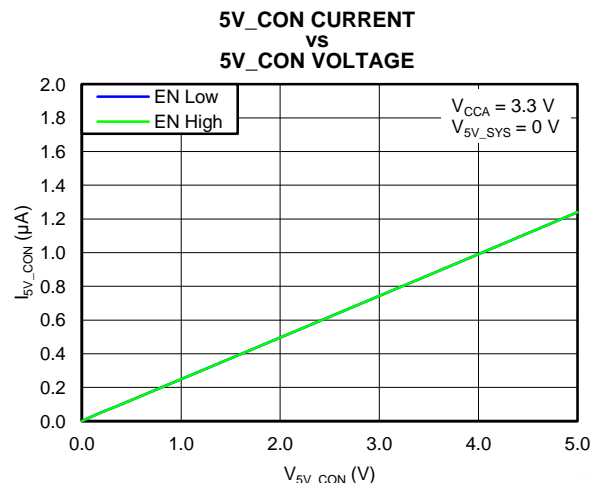
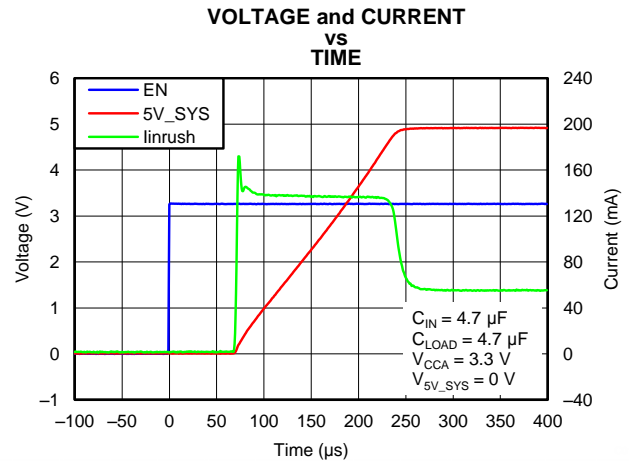
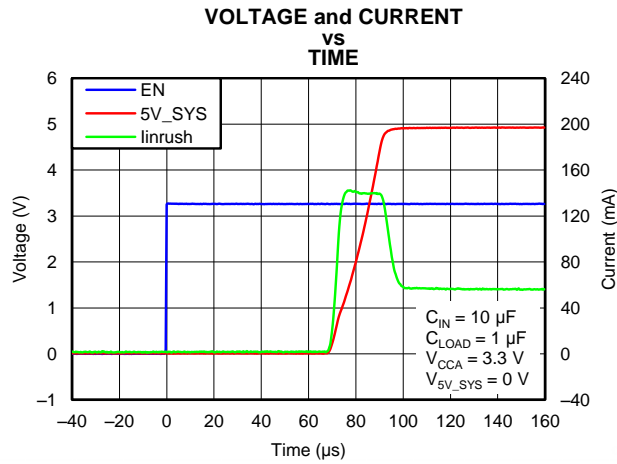

Figure 14. Reverse Switch Current Data

TYPICAL CHARACTERISTICS (continued)

Conditions TBD



APPLICATION INFORMATION

DDC/CEC LEVEL SHIFT Circuit Operation

The TPD5S116 enables DDC translation from VCCA (system side) voltage levels to 5V_CON (HDMI connector side) voltage levels without degradation of system performance. The TPD5S116 contains 2 bidirectional open-drain buffers specifically designed to support up-translation/down-translation between the low voltage, system side DDC-bus and the 5V connector side DDC-bus. The connector port I/Os are over-voltage tolerant to 5.5 V even when the device is un-powered. After power-up and with enable pin and HPD_CON pin HIGH, a LOW level on system port (below approximately $V_{ILC} = 0.08 \times V_{CCA} V$) turns the corresponding connector port driver (either SDA or SCL) on and drives it down to $V_{OL_CON} V$. When system port rises above approximately $0.10 \times V_{CCA} V$, the connector port pull-down driver is turned off and the internal pull-up resistor pulls the pin HIGH. When connector port falls first and goes below $0.3 \times 5V_CON$, a CMOS hysteresis input buffer detects the falling edge, turns on the system port driver, and pulls it down to approximately $V_{OLA} V$. The connector port pull-down is not enabled unless the system port voltage goes below V_{ILC} , in which case the connector port pull-down driver is enabled until system port rises above $(V_{ILC} + \Delta V_{T-HYSTA})$. If the connector port is not externally driven LOW, its voltage will continue to rise due to the internal pull-up resistor.

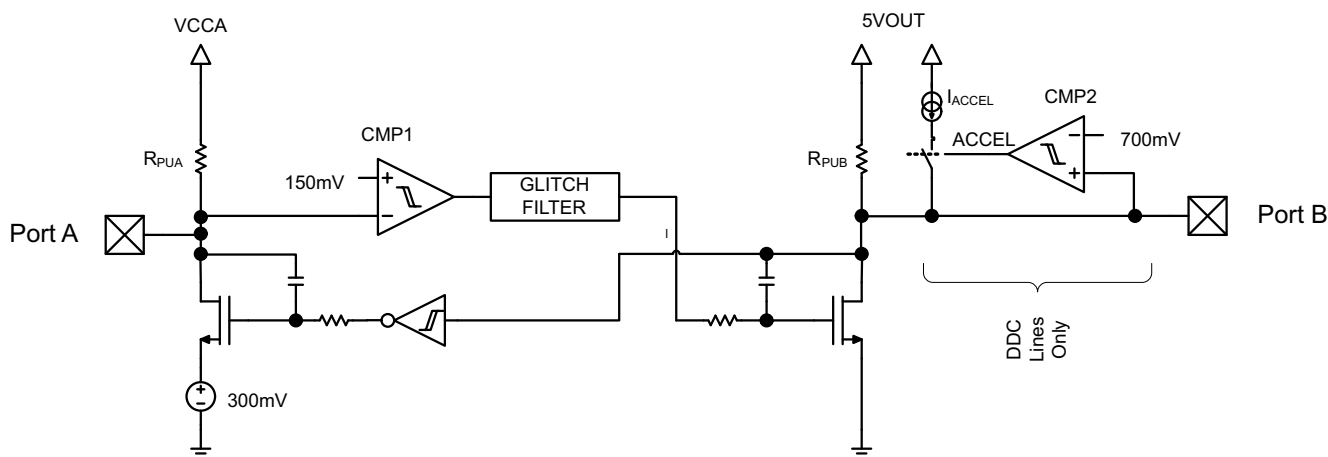

Figure 17. DDC/CEC Level Shifter Block Diagram

DDC/CEC Level Shifter Operational Notes for VCCA=1.8V

- The threshold of CMP1 is ~150mV +/- the 40mV of total hysteresis.
- The comparator will trip for a falling waveform at ~130mV
- The comparator will trip for a rising waveform at ~170mV
- To be recognized as a zero, the level at system port must first go below 130mV (V_{ILC} in spec) and then stay below 170mV (V_{IL_SYS} in spec)
- To be recognized as a one, the level at system port must first go above 170mV and then stay above 130mV
- V_{ILC} is set to 110mV in Electrical Characteristics Table to give some margin to the 130mV
- V_{IL_SYS} is set to 140mV in the Electrical Characteristics Table to give some margin to the 170mV
- V_{IH_SYS} is set to 70% of VCCA to be consistent with standard CMOS levels

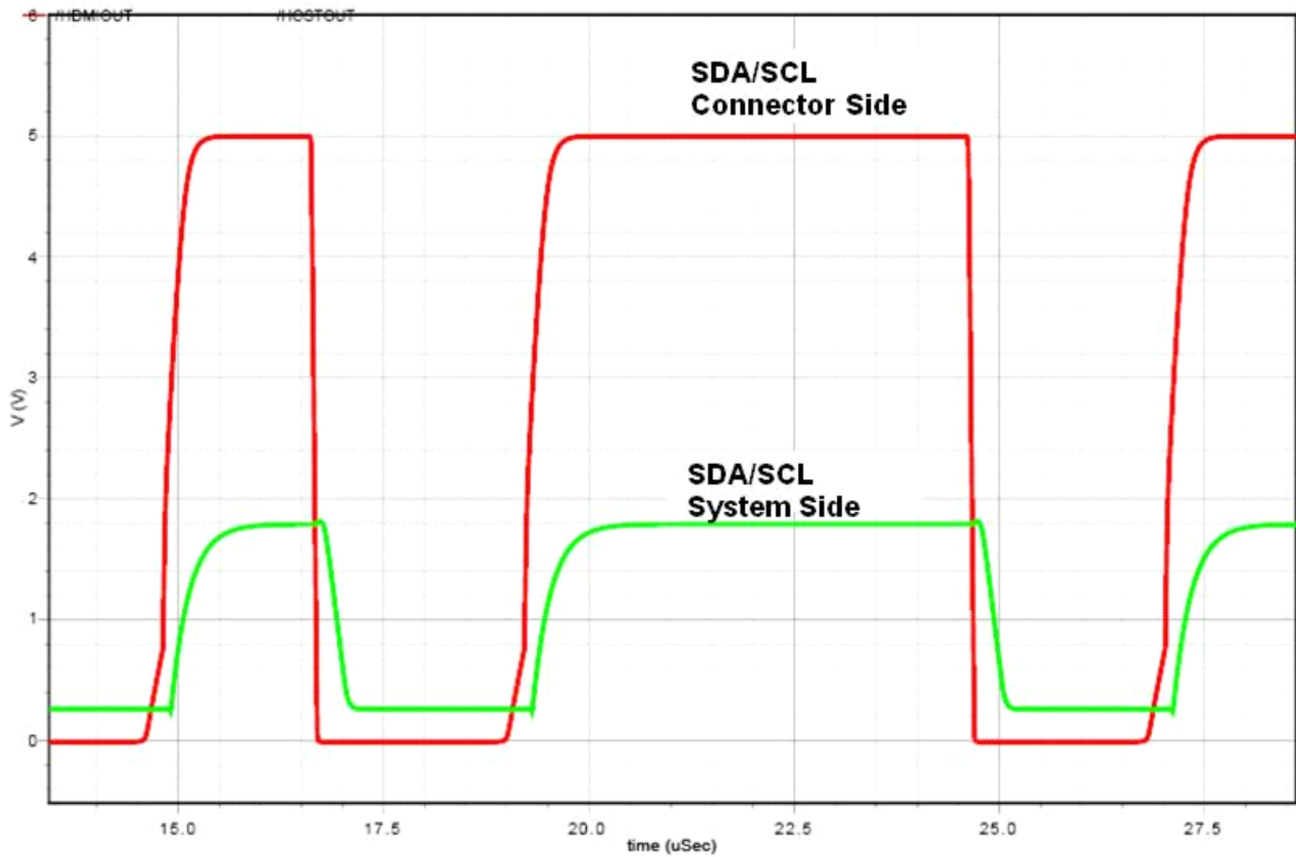

Figure 18. DDC Level Shifter Operation (Connector to System Direction)

Rise-Time Accelerators

The HDMI cable side of the DDC lines incorporates rise-time accelerators to support the high capacitive load on the HDMI cable side. The rise time accelerator boosts the cable side DDC signal independent of which side of the bus is releasing the signal.

Normal HDMI Transmit and Recieve Sequence

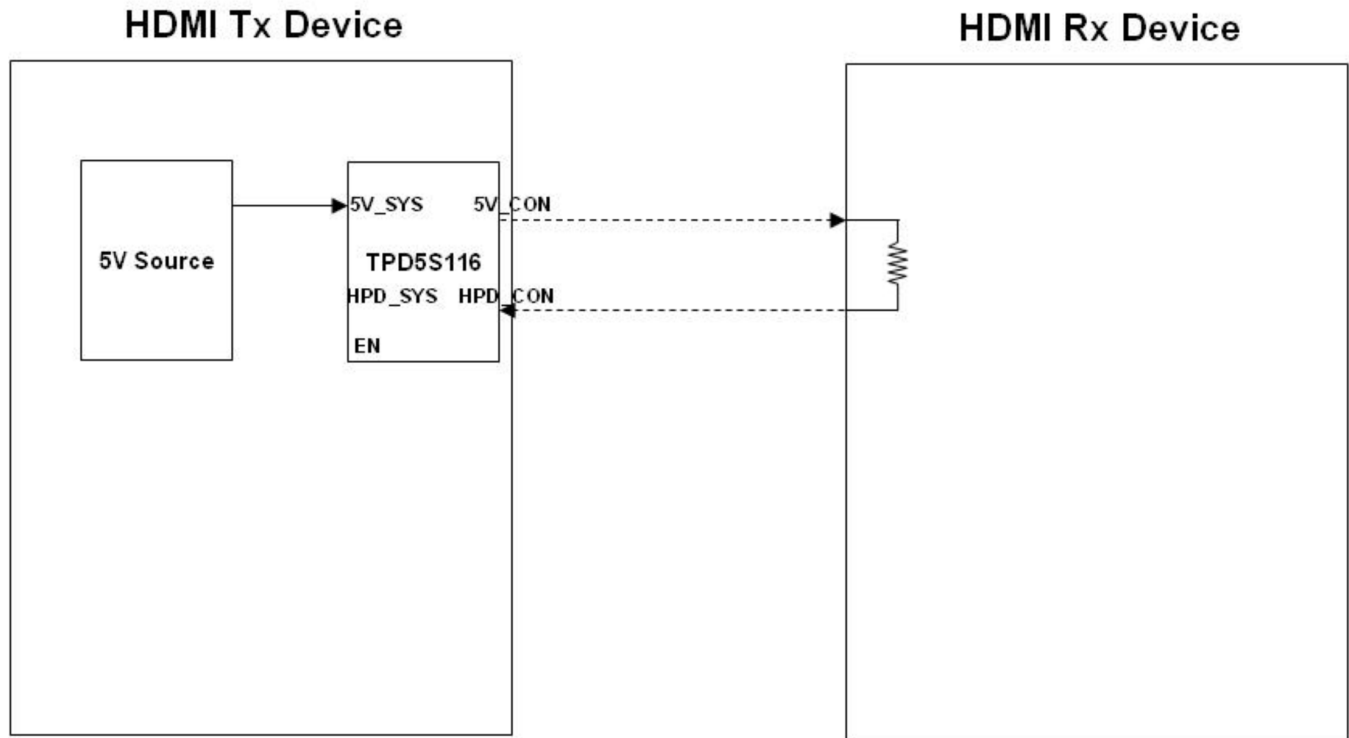

Figure 19. Tx Device Connecting with Rx Device

Hot Plug Detect

Once TPD5S116 is enabled and the system’s 5V source is on, TPD5S116 is ready for continual HDMI receiver detection. When a HDMI cable connects receiving and transmitting device together, the 5V on the load switch (5V_CON) flows through the receiving device’s internal resistor and into HPD’s input (HPD_CON). The HPD buffer’s output then goes high, indicating to the transmitter that a receiving device is connected. To save power, periodic detection can be done by turning on and off the TPD5S116 before a receiving device is connected.

Noise Considerations: Ground offset between the TPD5S116 ground and the ground of devices on system port of the TPD5S116 must be avoided. The reason for this cautionary remark is that a CMOS/NMOS open-drain capable of sinking 3 mA of current at 0.4 V will have an output resistance of 133Ω or less ($R = E / I$). Such a driver will share enough current with the system port output pull-down of the TPD5S116 to be seen as a LOW as long as the ground offset is zero. If the ground offset is greater than 0 V, then the driver resistance must be less. Since V_{ILC} can be as low as 90 mV at cold temperatures and the low end of the current distribution, the maximum ground offset should not exceed 50 mV. Bus repeaters that use an output offset are not interoperable with the system port of the TPD5S116 as their output LOW levels will not be recognized by the TPD5S116 as a LOW. If the TPD5S116 is placed in an application where the V_{IL_SYS} does not go below V_{ILC} , it will pull connector port LOW initially when system port input transitions LOW but the connector port will return HIGH, so it will not reproduce the system port input on connector port. Such applications should be avoided. Connector port is interoperable with all I2C-bus slaves, masters and repeaters.

Resistor Pull-Up Value Selection

The system is designed to work properly with no external pull-up resistors on the DDC, CEC, and HPD lines.

INPUT CAPACITOR (OPTIONAL)

To limit the voltage drop on the input supply caused by transient in-rush currents when the switch turns on into a discharged load capacitor or short-circuit, a capacitor needs to be placed between 5V_SYS and GND. A 10- μ F ceramic capacitor, C_{IN} , placed close to the pins, is usually sufficient. Higher values of C_{IN} can be used to further reduce the voltage drop during high-current application. When switching heavy loads, it is recommended to have an input capacitor about 10 times higher than the output capacitor to avoid excessive voltage drop.

OUTPUT CAPACITOR (OPTIONAL)

Due to the integrated body diode in the NMOS switch, a C_{IN} greater than C_{LOAD} is highly recommended. A C_{LOAD} greater than C_{IN} can cause 5V_CON to exceed 5V_SYS when the system supply is removed. A C_{IN} to C_{LOAD} ratio of 10 to 1 is recommended for minimizing 5V_SYS dip caused by inrush currents during startup.

HDMI Compliance

The TPD5S116 is designed to be fully compliant to HDMI 7-13 capacitance specification. Both power on and power off capacitance measurements are done on the CEC, SDA, and SCL connector side pins using a Hioki 3522-50 meter. In power on setup, connect TPD5S116's EN and HPD_CON pins low and 5V_SYS and VCCA pins high. Use the Hioki meter to measure the test fixture with and without the TPD5S116 and subtract to obtain capacitance. In power off setup, connect TPD5S116's EN, HPD_CON, 5V_SYS, and VCCA pins low and conduct same test with the Hioki meter. Read the Cp result from the Hioki meter.

- SCL_CON, SDA_CON Test
 - Measure large signal capacitance at SCL_CON & SDA_CON pins either power-up or power down conditions:
 - VBIAS = 2.5 V
 - f = 100KHz
 - 3.5V p-p ac signal
- CEC Test
 - Measure large signal capacitance of the CEC_CON pin at both power-up and power down conditions:
 - VBIAS = 1.65 V,
 - f = 100KHz
 - 2.5V p-p ac signal

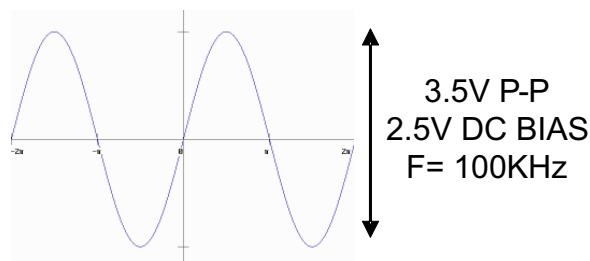

Figure 20. Hioki Meter Signal Set-up for SCL, SDA Cap Measurement

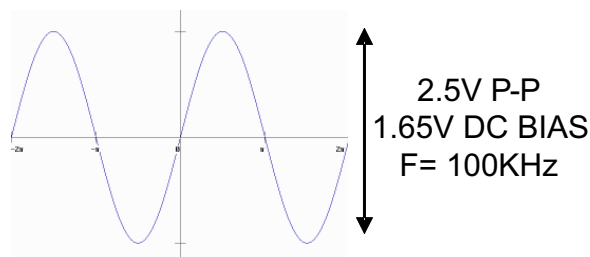

Figure 21. Hioki Meter Signal Set-up for CEC Cap Measurement

REVISION HISTORY

Changes from Original (December 2012) to Revision A

Page

PACKAGING INFORMATION

Orderable Device	Status (1)	Package Type	Package Drawing	Pins	Package Qty	Eco Plan (2)	Lead finish/ Ball material (6)	MSL Peak Temp (3)	Op Temp (°C)	Device Marking (4/5)	Samples
TPD5S116YFFR	ACTIVE	DSBGA	YFF	15	3000	RoHS & Green	SNAGCU	Level-1-260C-UNLIM	-40 to 85	RE116	Samples

(1) The marketing status values are defined as follows:

ACTIVE: Product device recommended for new designs.

LIFEBUY: TI has announced that the device will be discontinued, and a lifetime-buy period is in effect.

NRND: Not recommended for new designs. Device is in production to support existing customers, but TI does not recommend using this part in a new design.

PREVIEW: Device has been announced but is not in production. Samples may or may not be available.

OBSOLETE: TI has discontinued the production of the device.

(2) **RoHS:** TI defines "RoHS" to mean semiconductor products that are compliant with the current EU RoHS requirements for all 10 RoHS substances, including the requirement that RoHS substance do not exceed 0.1% by weight in homogeneous materials. Where designed to be soldered at high temperatures, "RoHS" products are suitable for use in specified lead-free processes. TI may reference these types of products as "Pb-Free".

RoHS Exempt: TI defines "RoHS Exempt" to mean products that contain lead but are compliant with EU RoHS pursuant to a specific EU RoHS exemption.

Green: TI defines "Green" to mean the content of Chlorine (Cl) and Bromine (Br) based flame retardants meet JS709B low halogen requirements of <=1000ppm threshold. Antimony trioxide based flame retardants must also meet the <=1000ppm threshold requirement.

(3) MSL, Peak Temp. - The Moisture Sensitivity Level rating according to the JEDEC industry standard classifications, and peak solder temperature.

(4) There may be additional marking, which relates to the logo, the lot trace code information, or the environmental category on the device.

(5) Multiple Device Markings will be inside parentheses. Only one Device Marking contained in parentheses and separated by a "-" will appear on a device. If a line is indented then it is a continuation of the previous line and the two combined represent the entire Device Marking for that device.

(6) Lead finish/Ball material - Orderable Devices may have multiple material finish options. Finish options are separated by a vertical ruled line. Lead finish/Ball material values may wrap to two lines if the finish value exceeds the maximum column width.

Important Information and Disclaimer:The information provided on this page represents TI's knowledge and belief as of the date that it is provided. TI bases its knowledge and belief on information provided by third parties, and makes no representation or warranty as to the accuracy of such information. Efforts are underway to better integrate information from third parties. TI has taken and continues to take reasonable steps to provide representative and accurate information but may not have conducted destructive testing or chemical analysis on incoming materials and chemicals. TI and TI suppliers consider certain information to be proprietary, and thus CAS numbers and other limited information may not be available for release.

In no event shall TI's liability arising out of such information exceed the total purchase price of the TI part(s) at issue in this document sold by TI to Customer on an annual basis.

TAPE AND REEL INFORMATION

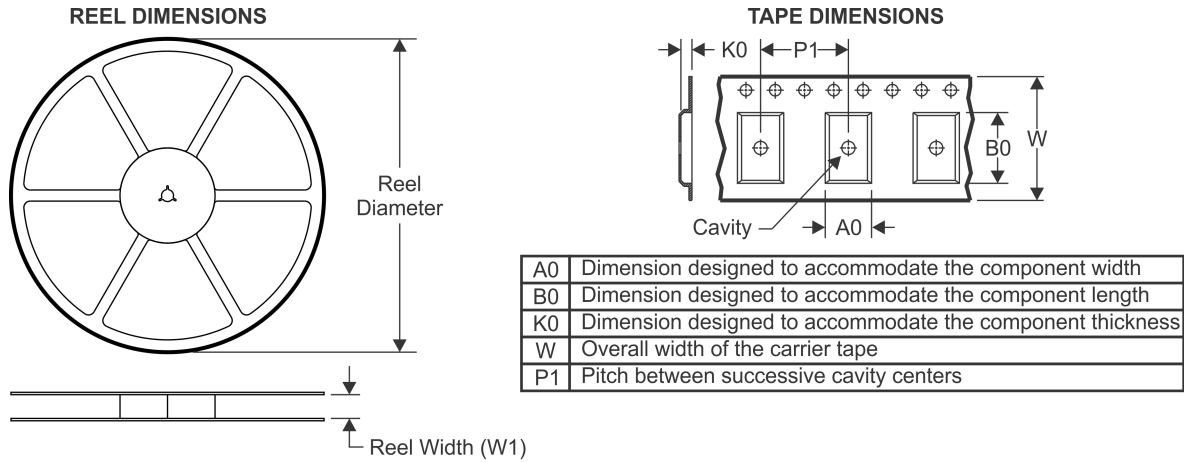

QUADRANT ASSIGNMENTS FOR PIN 1 ORIENTATION IN TAPE



*All dimensions are nominal

Device	Package Type	Package Drawing	Pins	SPQ	Reel Diameter (mm)	Reel Width W1 (mm)	A0 (mm)	B0 (mm)	K0 (mm)	P1 (mm)	W (mm)	Pin1 Quadrant
TPD5S116YFFR	DSBGA	YFF	15	3000	180.0	8.4	1.46	2.28	0.71	4.0	8.0	Q1

TAPE AND REEL BOX DIMENSIONS



*All dimensions are nominal

Device	Package Type	Package Drawing	Pins	SPQ	Length (mm)	Width (mm)	Height (mm)
TPD5S116YFFR	DSBGA	YFF	15	3000	182.0	182.0	20.0

EXAMPLE BOARD LAYOUT

YFF0015

DSBGA - 0.625 mm max height

DIE SIZE BALL GRID ARRAY

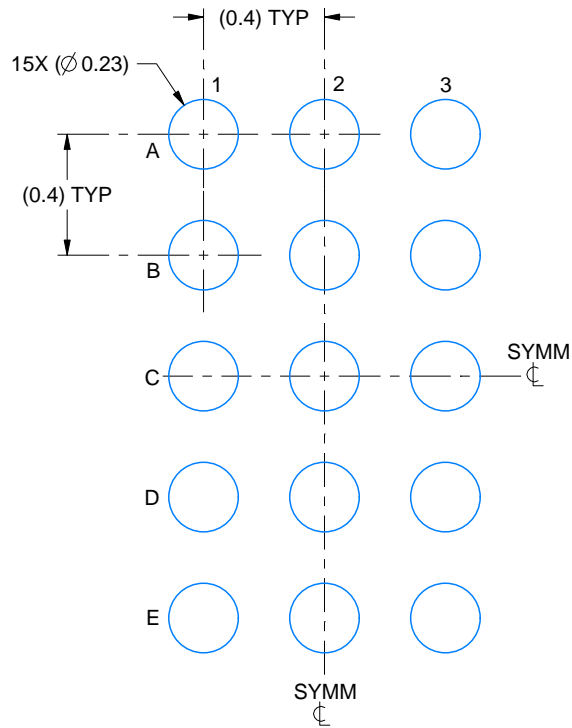

LAND PATTERN EXAMPLE
EXPOSED METAL SHOWN
SCALE:40X

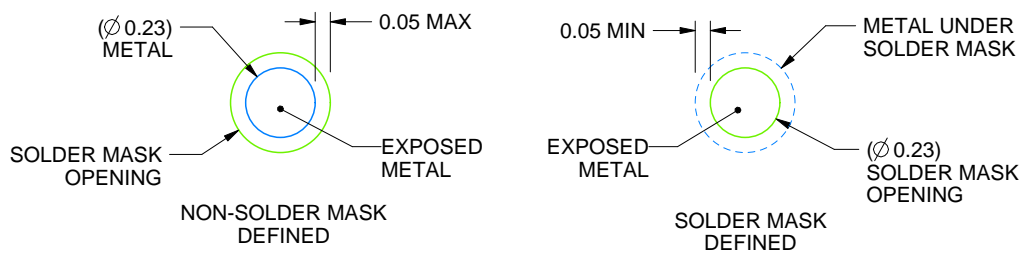

SOLDER MASK DETAILS
NOT TO SCALE

4219378/B 05/2020

NOTES: (continued)

3. Final dimensions may vary due to manufacturing tolerance considerations and also routing constraints. For more information, see Texas Instruments literature number SNVA009 (www.ti.com/lit/snva009).

EXAMPLE STENCIL DESIGN

YFF0015

DSBGA - 0.625 mm max height

DIE SIZE BALL GRID ARRAY

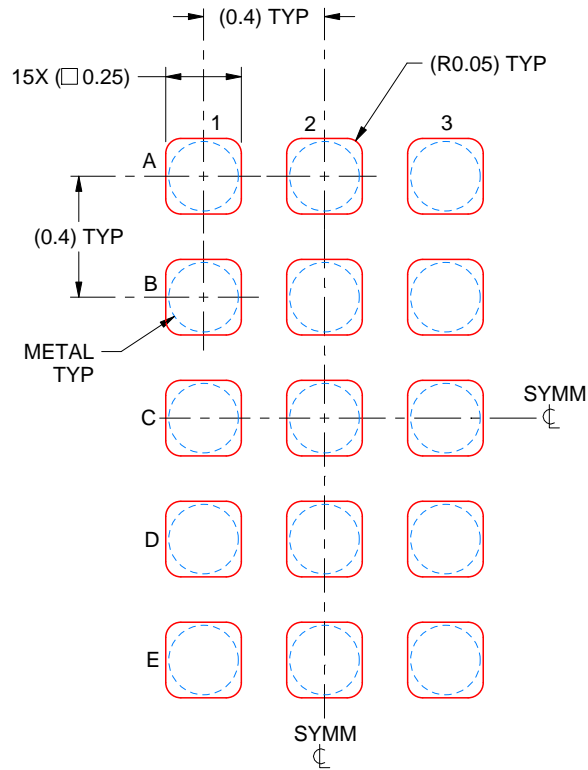

SOLDER PASTE EXAMPLE
BASED ON 0.1 mm THICK STENCIL
SCALE:40X

4219378/B 05/2020

NOTES: (continued)

4. Laser cutting apertures with trapezoidal walls and rounded corners may offer better paste release.

重要声明和免责声明

TI 均以“原样”提供技术性及其可靠性数据（包括数据表）、设计资源（包括参考设计）、应用或其他设计建议、网络工具、安全信息和其他资源，不保证其中不含任何瑕疵，且不做任何明示或暗示的担保，包括但不限于对适销性、适合某特定用途或不侵犯任何第三方知识产权的暗示担保。

所述资源可供专业开发人员应用TI 产品进行设计使用。您将对以下行为独自承担全部责任：(1) 针对您的应用选择合适的TI 产品；(2) 设计、验证并测试您的应用；(3) 确保您的应用满足相应标准以及任何其他安全、安保或其他要求。所述资源如有变更，恕不另行通知。TI 对您使用所述资源的授权仅限于开发资源所涉及TI 产品的相关应用。除此之外不得复制或展示所述资源，也不提供其它TI 或任何第三方的知识产权授权许可。如因使用所述资源而产生任何索赔、赔偿、成本、损失及债务等，TI 对此概不负责，并且您须赔偿由此对TI 及其代表造成的损害。

TI 所提供产品均受TI 的销售条款 (<http://www.ti.com.cn/zh-cn/legal/termsofsale.html>) 以及ti.com.cn上或随附TI产品提供的其他可适用条款的约束。TI提供所述资源并不扩展或以其他方式更改TI 针对TI 产品所发布的可适用的担保范围或担保免责声明。

邮寄地址：上海市浦东新区世纪大道 1568 号中建大厦 32 楼，邮政编码：200122

Copyright © 2020 德州仪器半导体技术（上海）有限公司