

# SN74LVC2G53 单极双投 (SPDT) 模拟开关

## 2:1 模拟多路复用器/多路解复用器

### 1 特性

- 采用德州仪器 (TI) 的 NanoFree™ 封装
- 1.65V 至 5.5V  $V_{CC}$  运行
- 高开关输出电压比
- 高度线性
- 高速, 典型值为 0.5ns (在  $V_{CC} = 3V$ 、 $C_L = 50pF$  时)
- 低导通电阻, 典型值为 6.5 $\Omega$  (在  $V_{CC} = 4.5V$  时)
- 锁断性能超过 100mA, 符合 JESD 78 II 类规范的要求

### 2 应用

- 无线设备
- 音频和视频信号路由
- 便携式计算
- 可穿戴设备
- 信号门控、斩波、调制或解调 (调制解调器)
- 适用于模数和数模转换系统的信号多路复用

逻辑图

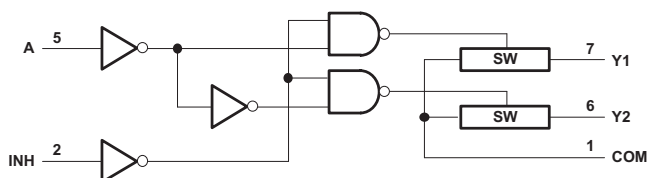

NOTE: 为简单起见, 测试条件如图 1 到图 4 和图 6 到图 10 所示, 专为多路解复用器配置而设计。信号可以从 COM 传递到 Y1 (Y2) 或从 Y1 (Y2) 传递到 COM。

### 3 说明

该单通道 2:1 模拟多路复用器/多路解复用器适用于 1.65V 至 5.5V  $V_{CC}$  运行环境。

SN74LVC2G53 器件可处理模拟信号和数字信号。该器件允许在任意方向传输振幅高达 5.5V (峰值) 的信号。

NanoFree 封装技术是 IC 封装概念的一项重大突破, 它将硅晶片用作封装。

应用 包括信号门控、斩波、调制或解调 (调制解调器) 以及适用于模数和数模转换系统的信号多路复用。

器件信息<sup>(1)</sup>

器件型号	封装	封装尺寸 (标称值)
SN74LVC2G53DCT	SM8 (8)	2.95mm x 2.80mm
SN74LVC2G53DCU	超薄小外形尺寸封装 (VSSOP)(8)	2.30mm x 2.00mm
SN74LVC2G53YZP	DSBGA (8)	1.91mm x 0.91mm

(1) 如需了解所有可用封装, 请参阅产品说明书末尾的可订购产品附录。

每次转换 (SW) 逻辑图

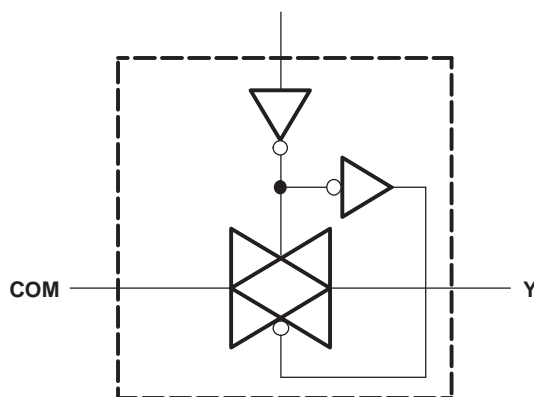

目录

1	特性 .....	1	8.2	Functional Block Diagram .....	15
2	应用 .....	1	8.3	Feature Description .....	15
3	说明 .....	1	8.4	Device Functional Modes .....	15
4	修订历史记录 .....	2	<b>9</b>	<b>Application and Implementation .....</b>	<b>16</b>
<b>5</b>	<b>Pin Configuration and Functions .....</b>	<b>3</b>	9.1	Application Information .....	16
<b>6</b>	<b>Specifications .....</b>	<b>4</b>	9.2	Typical Application .....	16
6.1	Absolute Maximum Ratings .....	4	<b>10</b>	<b>Power Supply Recommendations .....</b>	<b>17</b>
6.2	ESD Ratings .....	4	<b>11</b>	<b>Layout .....</b>	<b>18</b>
6.3	Recommended Operating Conditions .....	4	11.1	Layout Guidelines .....	18
6.4	Thermal Information .....	5	11.2	Layout Example .....	18
6.5	Electrical Characteristics .....	5	<b>12</b>	<b>器件和文档支持 .....</b>	<b>19</b>
6.6	Switching Characteristics .....	6	12.1	文档支持 .....	19
6.7	Analog Switch Characteristics .....	6	12.2	接收文档更新通知 .....	19
6.8	Operating Characteristics .....	7	12.3	社区资源 .....	19
6.9	Typical Characteristics .....	8	12.4	商标 .....	19
<b>7</b>	<b>Parameter Measurement Information .....</b>	<b>9</b>	12.5	静电放电警告 .....	19
<b>8</b>	<b>Detailed Description .....</b>	<b>15</b>	12.6	术语表 .....	19
8.1	Overview .....	15	<b>13</b>	<b>机械、封装和可订购信息 .....</b>	<b>19</b>

4 修订历史记录

注：之前版本的页码可能与当前版本有所不同。

Changes from Revision P (October 2016) to Revision Q	Page
• Changed the <i>Thermal Information</i> table .....	5

Changes from Revision O (December 2015) to Revision P	Page
• Added DSBGA package in <i>Pin Functions</i> table .....	3
• 已添加 接收文档更新通知部分 .....	19

Changes from Revision N (January 2014) to Revision O	Page
• 添加了应用 部分、器件信息表、ESD 额定值表、热性能信息表、特性说明 部分、器件功能模式、应用和实施 部分、电源建议 部分、布局 部分、器件和文档支持 部分以及机械、封装和可订购信息 部分。 .....	1
• Moved $T_{stg}$ to <i>Absolute Maximum Ratings</i> table .....	4

## 5 Pin Configuration and Functions

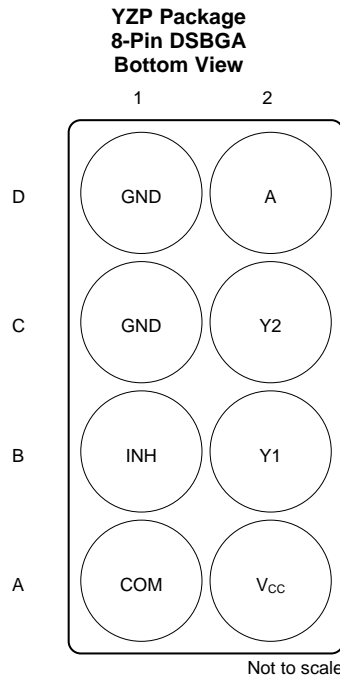
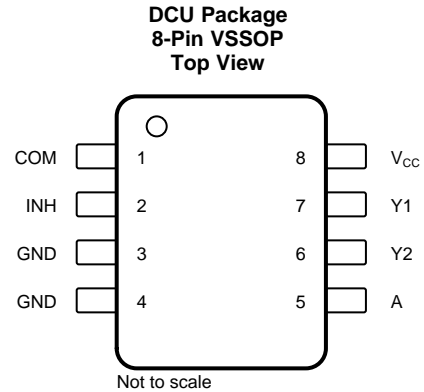
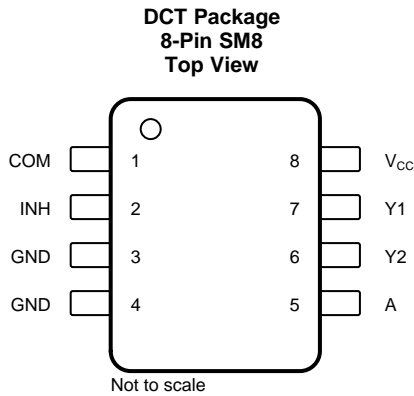

See [机械、封装和可订购信息](#) for dimensions.

### Pin Functions

NAME	PIN		I/O	DESCRIPTION
	SM8, VSSOP	DSBGA		
A	5	D2	I	Controls the switch
COM	1	A1	I/O	Bidirectional signal to be switched
GND	3	C1	—	Ground pin
GND	4	D1	—	Ground pin
INH	2	B1	I	Enables or disables the switch
V <sub>CC</sub>	8	A2	—	Power pin
Y2	6	C2	I/O	Bidirectional signal to be switched
Y1	7	B2	I/O	Bidirectional signal to be switched

## 6 Specifications

### 6.1 Absolute Maximum Ratings

 over operating free-air temperature range (unless otherwise noted)<sup>(1)</sup>

		MIN	MAX	UNIT
V <sub>CC</sub>	Supply voltage <sup>(2)</sup>	-0.5	6.5	V
V <sub>I</sub>	Input voltage <sup>(2)(3)</sup>	-0.5	6.5	V
V <sub>I/O</sub>	Switch I/O voltage <sup>(2)(3)(4)</sup>	-0.5	V <sub>CC</sub> + 0.5	V
I <sub>IK</sub>	Control input clamp current	V <sub>I</sub> < 0	-50	mA
I <sub>I/O</sub>	I/O port diode current	V <sub>I/O</sub> < 0 or V <sub>I/O</sub> > V <sub>CC</sub>	±50	mA
I <sub>T</sub>	ON-state switch current	V <sub>I/O</sub> = 0 to V <sub>CC</sub>	±50	mA
	Continuous current through V <sub>CC</sub> or GND		±100	mA
T <sub>J</sub>	Junction temperature		150	°C
T <sub>stg</sub>	Storage temperature	-65	150	°C

(1) Stresses beyond those listed under *Absolute Maximum Ratings* may cause permanent damage to the device. These are stress ratings only, and functional operation of the device at these or any other conditions beyond those indicated under *Recommended Operating Conditions* is not implied. Exposure to absolute-maximum-rated conditions for extended periods may affect device reliability.

(2) All voltages are with respect to ground, unless otherwise specified.

(3) The input and output voltage ratings may be exceeded if the input and output clamp-current ratings are observed.

(4) This value is limited to 5.5 V maximum.

### 6.2 ESD Ratings

		VALUE	UNIT
V <sub>(ESD)</sub>	Electrostatic discharge	Human body model (HBM), per ANSI/ESDA/JEDEC JS-001 <sup>(1)</sup>	±2000
		Charged-device model (CDM), per JEDEC specification JESD22-C101 <sup>(2)</sup>	±1000

(1) JEDEC document JEP155 states that 500-V HBM allows safe manufacturing with a standard ESD control process.

(2) JEDEC document JEP157 states that 250-V CDM allows safe manufacturing with a standard ESD control process.

### 6.3 Recommended Operating Conditions

 See note<sup>(1)</sup>.

		MIN	MAX	UNIT
V <sub>CC</sub>	Supply voltage	1.65	5.5	V
V <sub>I/O</sub>	I/O port voltage	0	V <sub>CC</sub>	V
V <sub>IH</sub>	High-level input voltage, control input	V <sub>CC</sub> = 1.65 V to 1.95 V	V <sub>CC</sub> × 0.65	V
		V <sub>CC</sub> = 2.3 V to 2.7 V	V <sub>CC</sub> × 0.7	
		V <sub>CC</sub> = 3 V to 3.6 V	V <sub>CC</sub> × 0.7	
		V <sub>CC</sub> = 4.5 V to 5.5 V	V <sub>CC</sub> × 0.7	
V <sub>IL</sub>	Low-level input voltage, control input	V <sub>CC</sub> = 1.65 V to 1.95 V	V <sub>CC</sub> × 0.35	V
		V <sub>CC</sub> = 2.3 V to 2.7 V	V <sub>CC</sub> × 0.3	
		V <sub>CC</sub> = 3 V to 3.6 V	V <sub>CC</sub> × 0.3	
		V <sub>CC</sub> = 4.5 V to 5.5 V	V <sub>CC</sub> × 0.3	
V <sub>I</sub>	Control input voltage	0	5.5	V
Δt/Δv	Input transition rise and fall time	V <sub>CC</sub> = 1.65 V to 1.95 V	20	ns/V
		V <sub>CC</sub> = 2.3 V to 2.7 V	20	
		V <sub>CC</sub> = 3 V to 3.6 V	10	
		V <sub>CC</sub> = 4.5 V to 5.5 V	10	
T <sub>A</sub>	Operating free-air temperature	-40	85	°C

(1) All unused inputs of the device must be held at V<sub>CC</sub> or GND to ensure proper device operation. See [Implications of Slow or Floating CMOS Inputs](#), SCBA004.

## 6.4 Thermal Information

THERMAL METRIC <sup>(1)</sup>		SN74LVC2G53			UNIT
		DCT (SM8)	DCU (VSSOP)	YZP (DSBGA)	
		8 PINS	8 PINS	8 PINS	
$R_{\theta JA}$	Junction-to-ambient thermal resistance <sup>(2)</sup>	185.9	288.9	98.3	°C/W
$R_{\theta JC(top)}$	Junction-to-case (top) thermal resistance	116.3	99.6	1.1	°C/W
$R_{\theta JB}$	Junction-to-board thermal resistance	98.4	207.3	27.6	°C/W
$\Psi_{JT}$	Junction-to-top characterization parameter	41.6	22.4	0.6	°C/W
$\Psi_{JB}$	Junction-to-board characterization parameter	97.3	205.7	27.4	°C/W

(1) For more information about traditional and new thermal metrics, see the [Semiconductor and IC Package Thermal Metrics](#) application report.

(2) The package thermal impedance is calculated in accordance with JESD 51-7.

## 6.5 Electrical Characteristics

over recommended operating free-air temperature range (unless otherwise noted)

PARAMETER		TEST CONDITIONS	$V_{CC}$	MIN	TYP <sup>(1)</sup>	MAX	UNIT
$r_{on}$	ON-state switch resistance	$V_I = V_{CC}$ or GND, $V_{INH} = V_{IL}$ (see <a href="#">Figure 2</a> and <a href="#">Figure 1</a> )	$I_S = 4$ mA	1.65 V	13	30	$\Omega$
			$I_S = 8$ mA	2.3 V	10	20	
			$I_S = 24$ mA	3 V	8.5	17	
			$I_S = 32$ mA	4.5 V	6.5	13	
$r_{on(p)}$	Peak ON-state resistance	$V_I = V_{CC}$ to GND, $V_{INH} = V_{IL}$ (see <a href="#">Figure 2</a> and <a href="#">Figure 1</a> )	$I_S = 4$ mA	1.65 V	86.5	120	$\Omega$
			$I_S = 8$ mA	2.3 V	23	30	
			$I_S = 24$ mA	3 V	13	20	
			$I_S = 32$ mA	4.5 V	8	15	
$\Delta r_{on}$	Difference of ON-state resistance between switches	$V_I = V_{CC}$ to GND, $V_C = V_{IH}$ (see <a href="#">Figure 2</a> and <a href="#">Figure 1</a> )	$I_S = 4$ mA	1.65 V		7	$\Omega$
			$I_S = 8$ mA	2.3 V		5	
			$I_S = 24$ mA	3 V		3	
			$I_S = 32$ mA	4.5 V		2	
$I_{S(off)}$	OFF-state switch leakage current	$V_I = V_{CC}$ and $V_O =$ GND or $V_I =$ GND and $V_O = V_{CC}$ , $V_{INH} = V_{IH}$ (see <a href="#">Figure 3</a> )	5.5 V		$\pm 1$ $\pm 0.1^{(1)}$	$\mu A$	
$I_{S(on)}$	ON-state switch leakage current	$V_I = V_{CC}$ or GND, $V_{INH} = V_{IL}$ , $V_O =$ Open (see <a href="#">Figure 4</a> )	5.5 V		$\pm 1$ $\pm 0.1^{(1)}$	$\mu A$	
$I_I$	Control input current	$V_C = V_{CC}$ or GND	5.5 V		$\pm 1$ $\pm 0.1^{(1)}$	$\mu A$	
$I_{CC}$	Supply current	$V_C = V_{CC}$ or GND	5.5 V		1	$\mu A$	
$\Delta I_{CC}$	Supply-current change	$V_C = V_{CC} - 0.6$ V	5.5 V		500	$\mu A$	
$C_{ic}$	Control input capacitance		5 V		3.5	pF	
$C_{io(off)}$	Switch input/output capacitance	Y	5 V		6.5	pF	
		COM		10			
$C_{io(on)}$	Switch input/output capacitance		5 V		19.5	pF	

(1)  $T_A = 25^\circ C$

## 6.6 Switching Characteristics

over recommended operating free-air temperature range (unless otherwise noted) (see Figure 5)

PARAMETER	FROM (INPUT)	TO (OUTPUT)	V <sub>CC</sub>	MIN	MAX	UNIT
t <sub>pd</sub> <sup>(1)</sup>	COM or Y	Y or COM	V <sub>CC</sub> = 1.8 V ± 0.15 V		2	ns
			V <sub>CC</sub> = 2.5 V ± 0.2 V		1.2	
			V <sub>CC</sub> = 3.3 V ± 0.3 V		0.8	
			V <sub>CC</sub> = 5 V ± 0.5 V		0.6	
t <sub>en</sub> <sup>(2)</sup>	INH	COM or Y	V <sub>CC</sub> = 1.8 V ± 0.15 V	3.3	9	ns
			V <sub>CC</sub> = 2.5 V ± 0.2 V	2.5	6.1	
			V <sub>CC</sub> = 3.3 V ± 0.3 V	2.2	5.4	
			V <sub>CC</sub> = 5 V ± 0.5 V	1.8	4.5	
t <sub>dis</sub> <sup>(3)</sup>	INH	COM or Y	V <sub>CC</sub> = 1.8 V ± 0.15 V	3.2	10.9	ns
			V <sub>CC</sub> = 2.5 V ± 0.2 V	2.3	8.3	
			V <sub>CC</sub> = 3.3 V ± 0.3 V	2.3	8.1	
			V <sub>CC</sub> = 5 V ± 0.5 V	1.6	8	
t <sub>en</sub> <sup>(2)</sup>	A	COM or Y	V <sub>CC</sub> = 1.8 V ± 0.15 V	2.9	10.3	ns
			V <sub>CC</sub> = 2.5 V ± 0.2 V	2.1	7.2	
			V <sub>CC</sub> = 3.3 V ± 0.3 V	1.9	5.8	
			V <sub>CC</sub> = 5 V ± 0.5 V	1.3	5.4	
t <sub>dis</sub> <sup>(3)</sup>	A	COM or Y	V <sub>CC</sub> = 1.8 V ± 0.15 V	2.1	2.1	ns
			V <sub>CC</sub> = 2.5 V ± 0.2 V	1.4	7.9	
			V <sub>CC</sub> = 3.3 V ± 0.3 V	1.1	7.2	
			V <sub>CC</sub> = 5 V ± 0.5 V	1	5	

- (1) t<sub>PLH</sub> and t<sub>PHL</sub> are the same as t<sub>pd</sub>. The propagation delay is the calculated RC time constant of the typical on-state resistance of the switch and the specified load capacitance, when driven by an ideal voltage source (zero output impedance).
- (2) t<sub>PZL</sub> and t<sub>PZH</sub> are the same as t<sub>en</sub>.
- (3) t<sub>PLZ</sub> and t<sub>PHZ</sub> are the same as t<sub>dis</sub>.

## 6.7 Analog Switch Characteristics

 T<sub>A</sub> = 25°C

PARAMETER	FROM (INPUT)	TO (OUTPUT)	TEST CONDITIONS	V <sub>CC</sub>	TYP	UNIT
Frequency response (switch on)	COM or Y	Y or COM	C <sub>L</sub> = 50 pF, R <sub>L</sub> = 600 Ω, f <sub>in</sub> = sine wave (see Figure 6)	1.65 V	35	MHz
				2.3 V	120	
				3 V	190	
				4.5 V	215	
			C <sub>L</sub> = 5 pF, R <sub>L</sub> = 50 Ω, f <sub>in</sub> = sine wave (see Figure 6)	1.65 V	>300	
				2.3 V	>300	
				3 V	>300	
				4.5 V	>300	
Crosstalk <sup>(1)</sup> (between switches)	COM or Y	Y or COM	C <sub>L</sub> = 50 pF, R <sub>L</sub> = 600 Ω, f <sub>in</sub> = 1 MHz (sine wave) (see Figure 7)	1.65 V	-58	dB
				2.3 V	-58	
				3 V	-58	
				4.5 V	-58	
			C <sub>L</sub> = 5 pF, R <sub>L</sub> = 50 Ω, f <sub>in</sub> = 1 MHz (sine wave) (see Figure 7)	1.65 V	-42	
				2.3 V	-42	
				3 V	-42	
				4.5 V	-42	

- (1) Adjust f<sub>in</sub> voltage to obtain 0 dBm at input.

**Analog Switch Characteristics (continued)**
 $T_A = 25^\circ\text{C}$ 

PARAMETER	FROM (INPUT)	TO (OUTPUT)	TEST CONDITIONS	V <sub>CC</sub>	TYP	UNIT
Crosstalk (control input to signal output)	INH	COM or Y	$C_L = 50\text{ pF}$ , $R_L = 600\ \Omega$ , $f_{in} = 1\text{ MHz}$ (square wave) (see Figure 8)	1.65 V	35	mV
				2.3 V	50	
				3 V	70	
				4.5 V	100	
Feedthrough attenuation (switch off)	COM or Y	Y or COM	$C_L = 50\text{ pF}$ , $R_L = 600\ \Omega$ , $f_{in} = 1\text{ MHz}$ (sine wave) (see Figure 9)	1.65 V	–60	dB
				2.3 V	–60	
				3 V	–60	
				4.5 V	–60	
			$C_L = 5\text{ pF}$ , $R_L = 50\ \Omega$ , $f_{in} = 1\text{ MHz}$ (sine wave) (see Figure 9)	1.65 V	–50	
				2.3 V	–50	
				3 V	–50	
				4.5 V	–50	
Sine-wave distortion	COM or Y	Y or COM	$C_L = 50\text{ pF}$ , $R_L = 10\text{ k}\Omega$ , $f_{in} = 1\text{ kHz}$ (sine wave) (see Figure 10)	1.65 V	0.1%	
				2.3 V	0.025%	
				3 V	0.015%	
				4.5 V	0.01%	
			$C_L = 50\text{ pF}$ , $R_L = 10\text{ k}\Omega$ , $f_{in} = 10\text{ kHz}$ (sine wave) (see Figure 10)	1.65 V	0.15%	
				2.3 V	0.025%	
				3 V	0.015%	
				4.5 V	0.01%	

**6.8 Operating Characteristics**
 $T_A = 25^\circ\text{C}$ 

PARAMETER	TEST CONDITIONS	V <sub>CC</sub>	TYP	UNIT
C <sub>pd</sub> Power dissipation capacitance	$C_L = 50\text{ pF}$ , $f = 10\text{ MHz}$	V <sub>CC</sub> = 1.8 V	9	pF
		V <sub>CC</sub> = 2.5 V	10	
		V <sub>CC</sub> = 3.3 V	10	
		V <sub>CC</sub> = 5 V	12	

**6.9 Typical Characteristics**

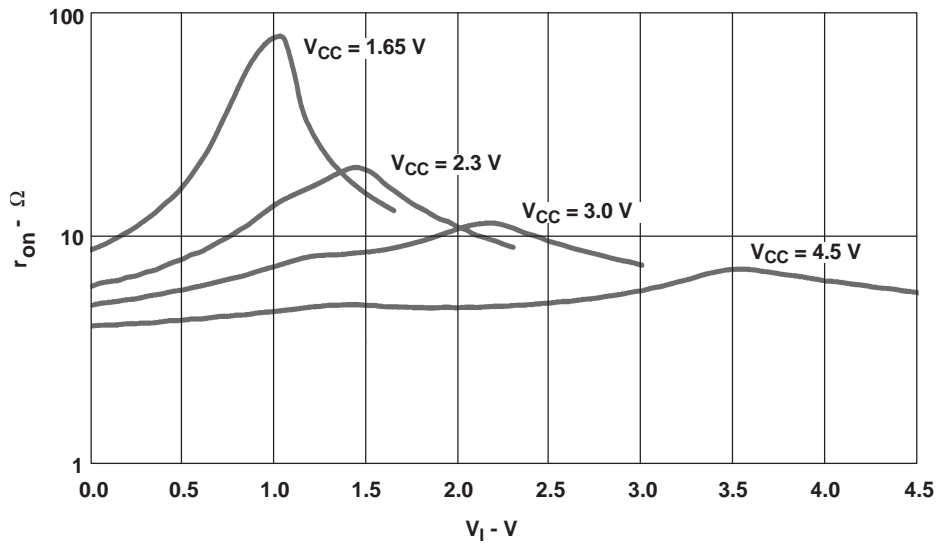

**Figure 1. Typical  $r_{on}$  as a Function of Input Voltage ( $V_I$ ) for  $V_I = 0$  to  $V_{CC}$**



7 Parameter Measurement Information

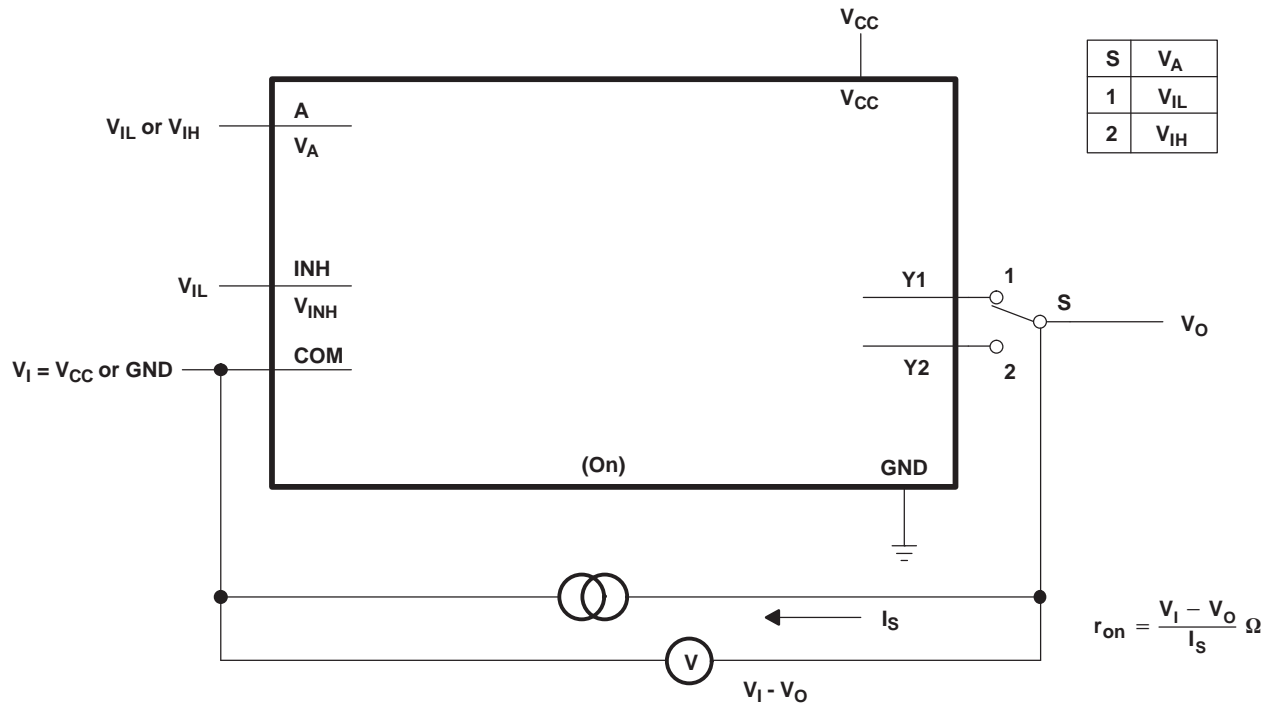

Figure 2. ON-State Resistance Test Circuit

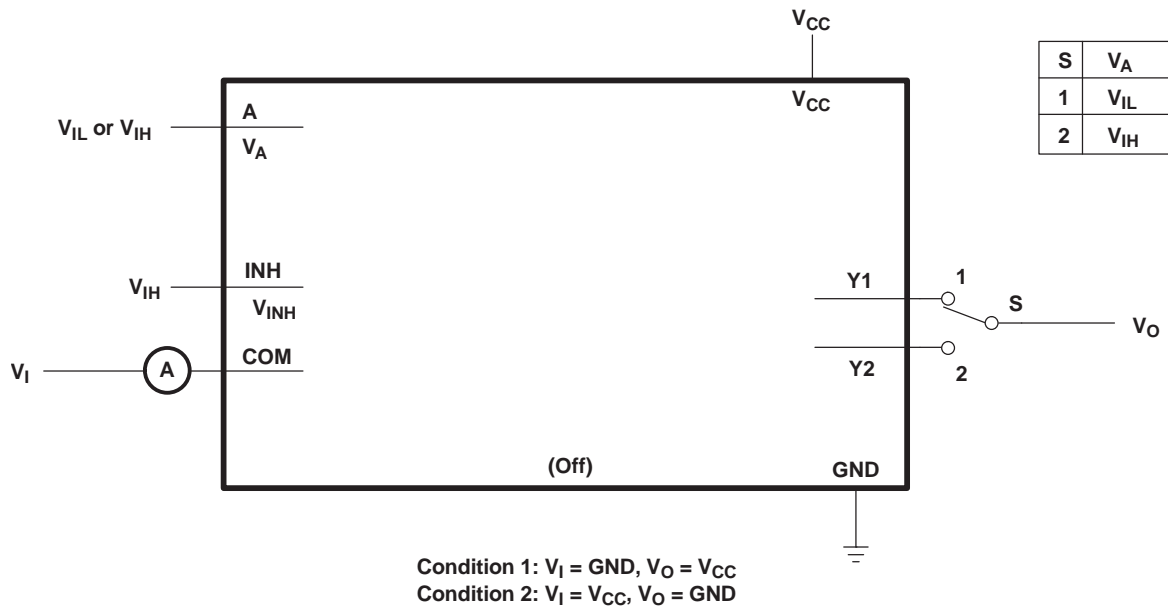
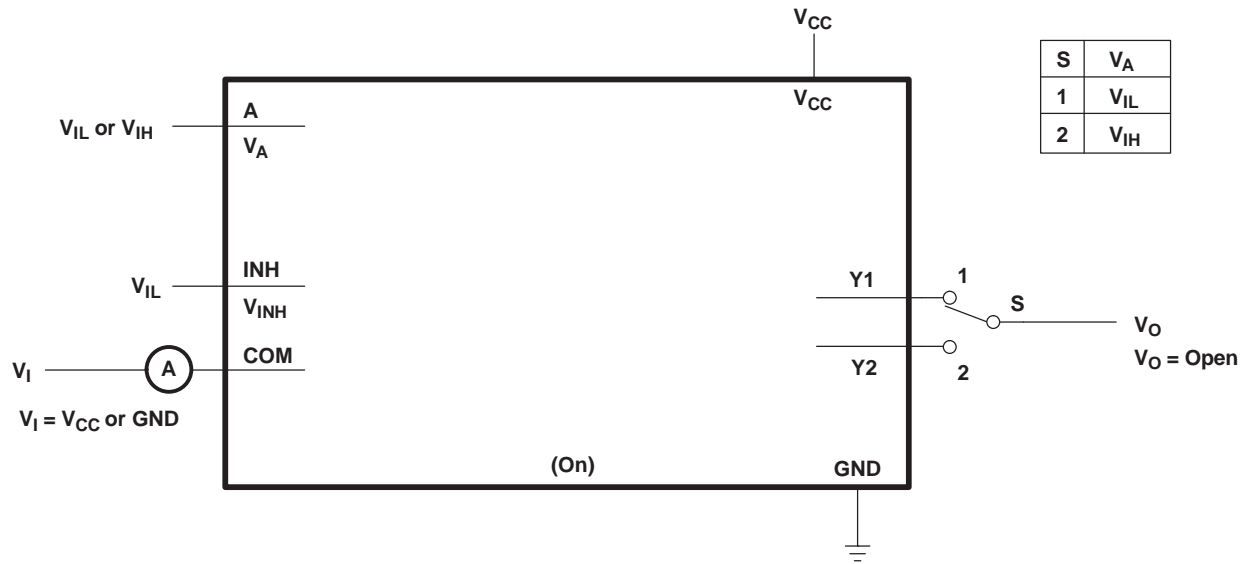
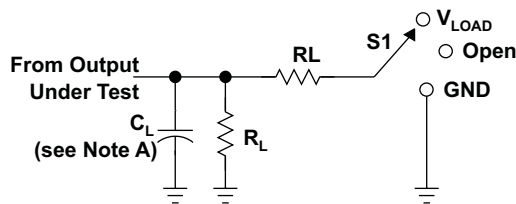

Figure 3. OFF-State Switch Leakage-Current Test Circuit

**Parameter Measurement Information (continued)**

**Figure 4. ON-State Switch Leakage-Current Test Circuit**

Parameter Measurement Information (continued)



TEST	S1
$t_{PLH}/t_{PHL}$	Open
$t_{PLZ}/t_{PZL}$	$V_{LOAD}$
$t_{PHZ}/t_{PZH}$	GND

LOAD CIRCUIT

$V_{CC}$	INPUTS		$V_M$	$V_{LOAD}$	$C_L$	$R_L$	$V_{\Delta}$
	$V_I$	$t_r/t_f$					
$1.8\text{ V} \pm 0.15\text{ V}$	$V_{CC}$	$\leq 2\text{ ns}$	$V_{CC}/2$	$2 \times V_{CC}$	30 pF	1 k $\Omega$	0.15 V
$2.5\text{ V} \pm 0.2\text{ V}$	$V_{CC}$	$\leq 2\text{ ns}$	$V_{CC}/2$	$2 \times V_{CC}$	30 pF	500 $\Omega$	0.15 V
$3.3\text{ V} \pm 0.3\text{ V}$	$V_{CC}$	$\leq 2.5\text{ ns}$	$V_{CC}/2$	$2 \times V_{CC}$	50 pF	500 $\Omega$	0.3 V
$5\text{ V} \pm 0.5\text{ V}$	$V_{CC}$	$\leq 2.5\text{ ns}$	$V_{CC}/2$	$2 \times V_{CC}$	50 pF	500 $\Omega$	0.3 V

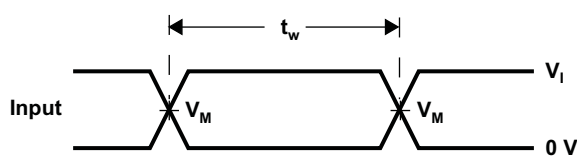

VOLTAGE WAVEFORMS PULSE DURATION

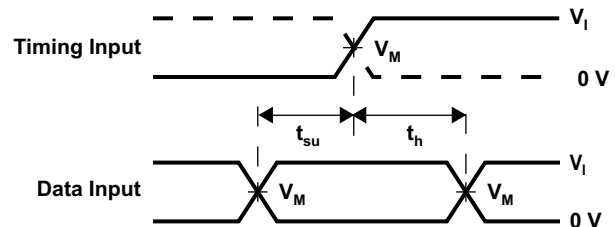

VOLTAGE WAVEFORMS SETUP AND HOLD TIMES

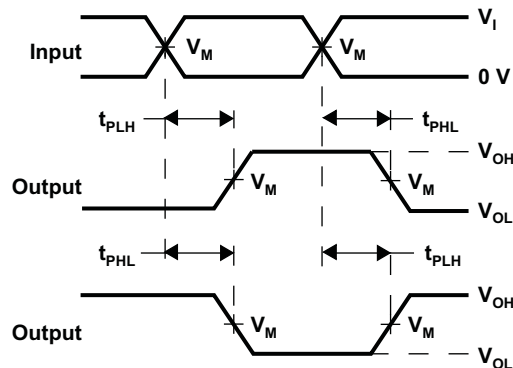

VOLTAGE WAVEFORMS PROPAGATION DELAY TIMES INVERTING AND NONINVERTING OUTPUTS

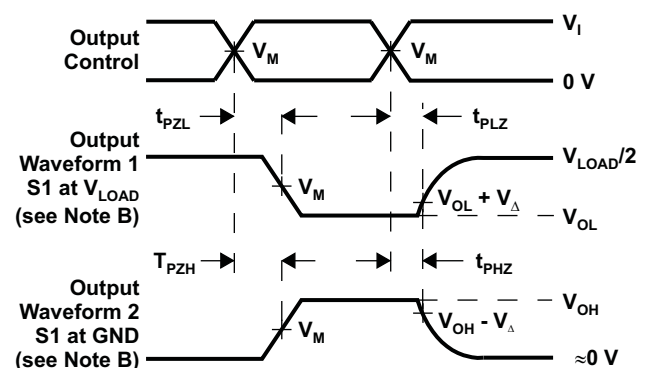

VOLTAGE WAVEFORMS ENABLE AND DISABLE TIMES LOW- AND HIGH-LEVEL ENABLING

- NOTES: A.  $C_L$  includes probe and jig capacitance.  
 B. Waveform 1 is for an output with internal conditions such that the output is low, except when disabled by the output control. Waveform 2 is for an output with internal conditions such that the output is high, except when disabled by the output control.  
 C. All input pulses are supplied by generators having the following characteristics: PRR  $\leq 10\text{ Mhz}$ ,  $Z_O = 50\ \Omega$   
 D. The outputs are measured one at a time, with one transition per measurement.  
 E.  $t_{PLZ}$  and  $t_{PHZ}$  are the same as  $t_{dis}$ .  
 F.  $t_{PZL}$  and  $t_{PZH}$  are the same as  $t_{en}$ .  
 G.  $t_{PLH}$  and  $t_{PHL}$  are the same as  $t_{pd}$ .  
 H. All parameters and waveforms are not applicable to all devices.

Figure 5. Load Circuit and Voltage Waveforms

Parameter Measurement Information (continued)

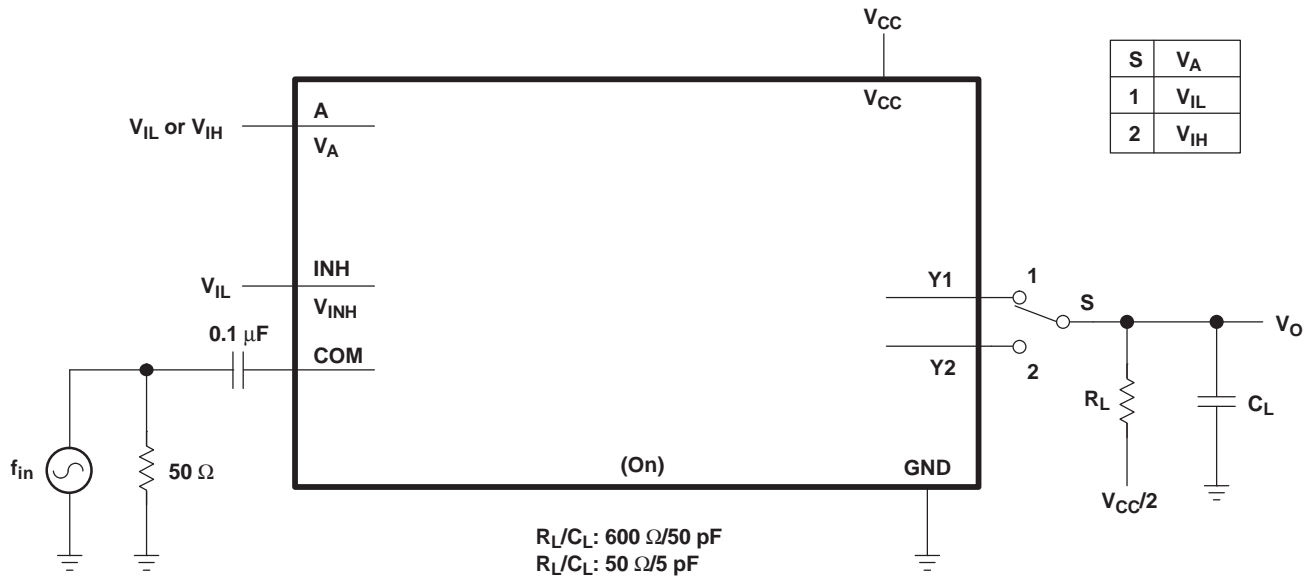

Figure 6. Frequency Response (Switch On)

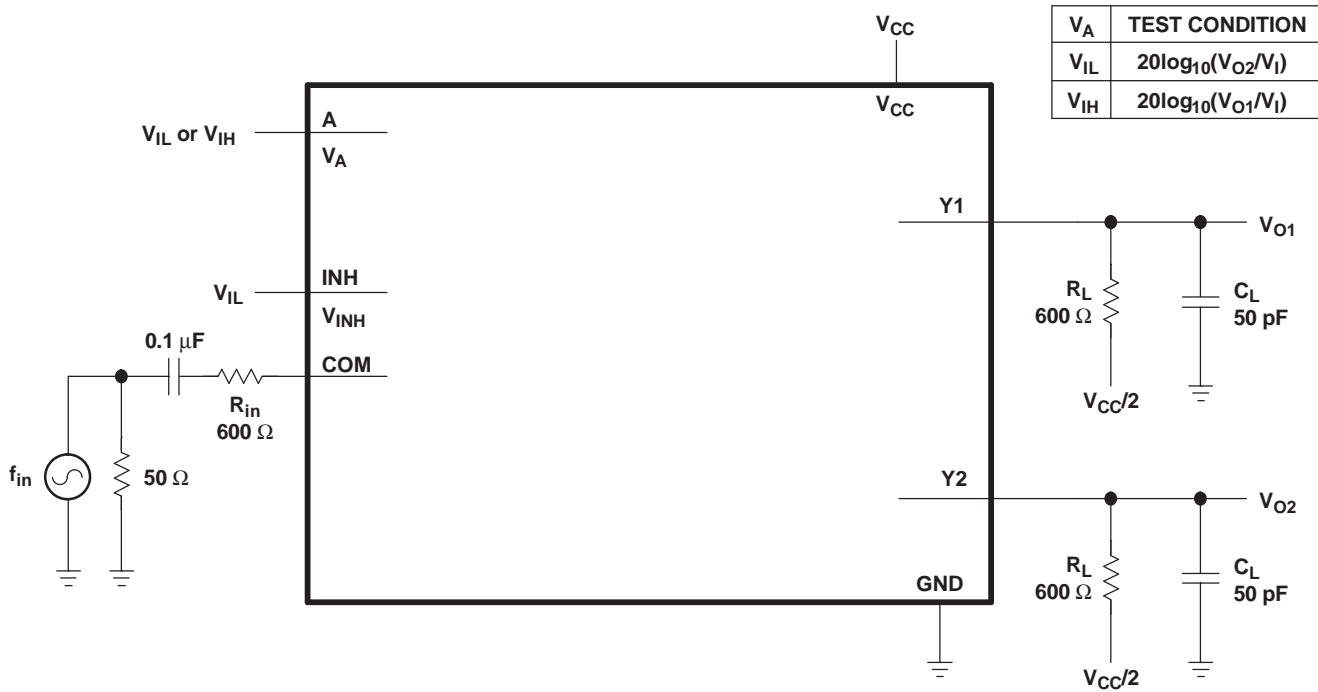

Figure 7. Crosstalk (Between Switches)

Parameter Measurement Information (continued)

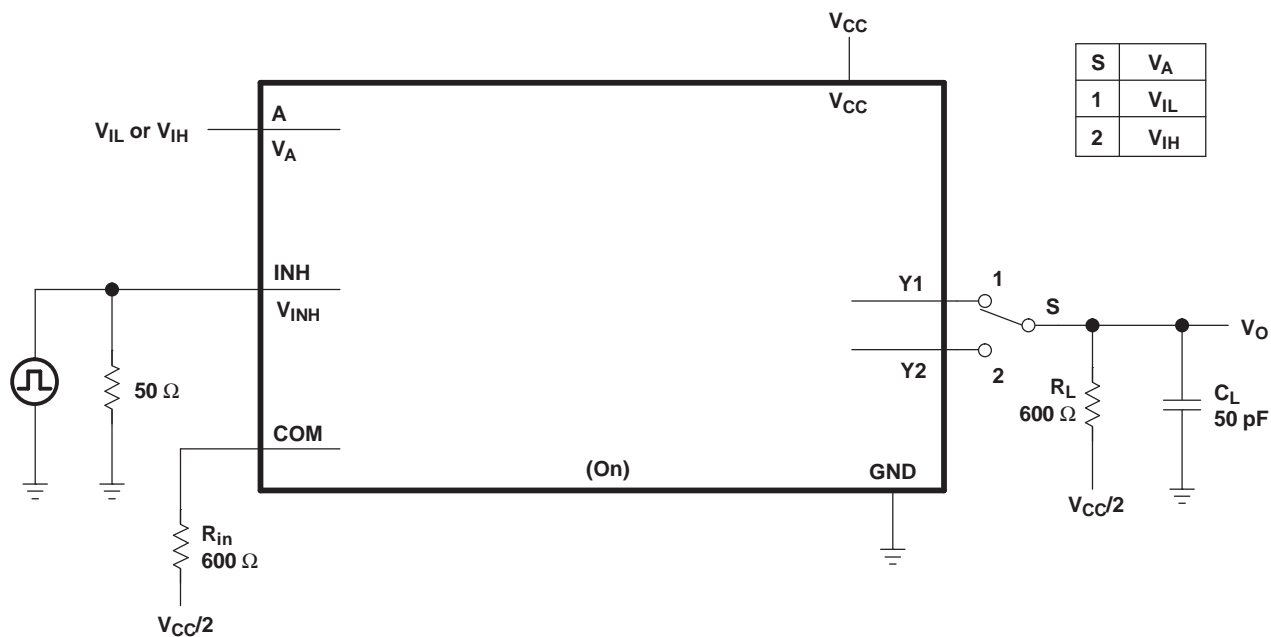

Figure 8. Crosstalk (Control Input, Switch Output)

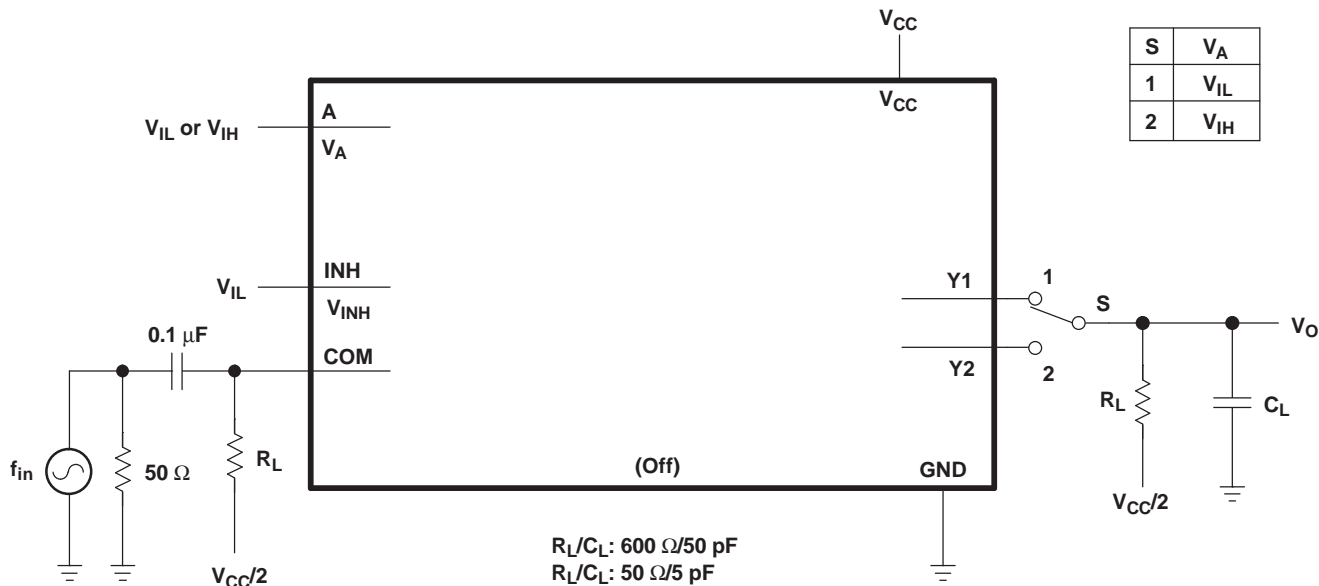
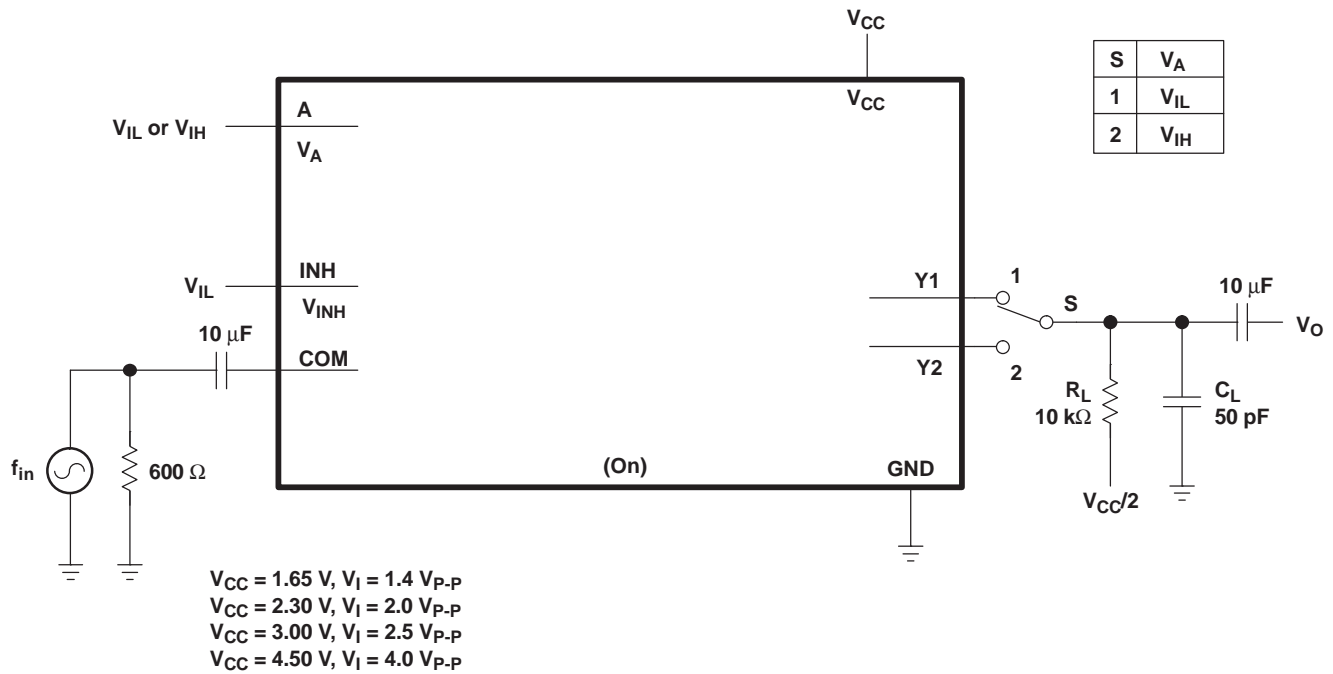

Figure 9. Feedthrough (Switch Off)

**Parameter Measurement Information (continued)**

**Figure 10. Sine-Wave Distortion**

## 8 Detailed Description

### 8.1 Overview

This dual analog multiplexer/demultiplexer is designed for 1.65-V to 5.5-V  $V_{CC}$  operation.

The SN74LVC2G53 device can handle both analog and digital signals. This device permits signals with amplitudes of up to 5.5 V (peak) to be transmitted in either direction.

### 8.2 Functional Block Diagram

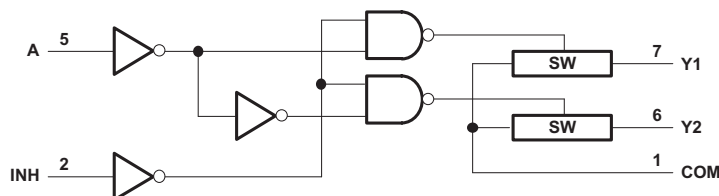

NOTE: For simplicity, the test conditions shown in Figure 1 through Figure 4 and Figure 6 through Figure 10 are for the demultiplexer configuration. Signals can be passed from COM to Y1 (Y2) or from Y1 (Y2) to COM.

Figure 11. Logic Diagram

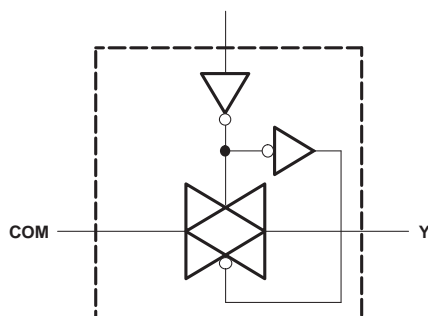

Figure 12. Logic Diagram, Each Switch (SW)

### 8.3 Feature Description

A high-level voltage applied to INH disables the switches. When INH is low, signals can pass from A to Y or Y to A. Low ON-resistance of 6.5  $\Omega$  at 4.5-V  $V_{CC}$  is ideal for analog signal conditioning systems. The control signals can accept voltages up to 5.5 V without  $V_{CC}$  connected in the system. Combination of lower  $t_{pd}$  of 0.8 ns at 3.3 V and low enable and disable time make this part suitable for high-speed signal switching applications.

### 8.4 Device Functional Modes

Table 1 lists the functional modes of the SN74LVC2G53.

Table 1. Function Table

CONTROL INPUTS		ON CHANNEL
INH	A	
L	L	Y1
L	H	Y2
H	X	None

## 9 Application and Implementation

### NOTE

Information in the following applications sections is not part of the TI component specification, and TI does not warrant its accuracy or completeness. TI's customers are responsible for determining suitability of components for their purposes. Customers should validate and test their design implementation to confirm system functionality.

### 9.1 Application Information

The SN74LVC2G53 can be used in any situation where an SPDT switch is required in an application. This switch helps to select one of two signals of which signals can be either digital or analog.

### 9.2 Typical Application

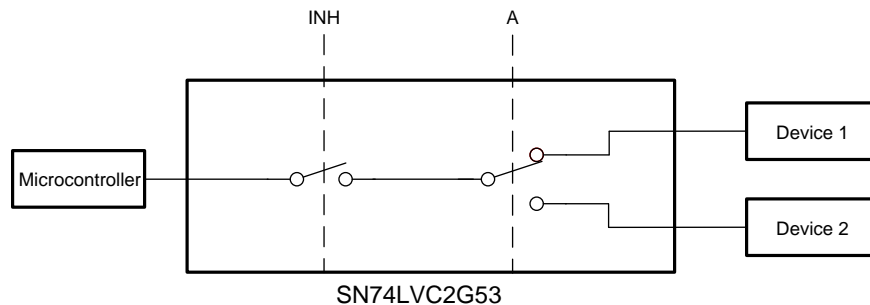

**Figure 13. Typical Application Schematic**

#### 9.2.1 Design Requirements

The SN74LVC2G53 allows on/off control of analog and digital signals with a digital control signal. All input signals should remain between 0 V and  $V_{CC}$  for optimal operation.

#### 9.2.2 Detailed Design Procedure

1. Recommended Input Conditions:
  - For rise time and fall time specifications, see  $\Delta t/\Delta v$  in the [Recommended Operating Conditions](#) table.
  - For specified high and low levels, see  $V_{IH}$  and  $V_{IL}$  in the [Recommended Operating Conditions](#) table.
  - Inputs and outputs are overvoltage tolerant allowing them to go as high as 5.5 V at any valid  $V_{CC}$ .
2. Recommended Output Conditions:
  - Load currents should not exceed  $\pm 50$  mA.
3. Frequency Selection Criterion:
  - Maximum frequency tested is 150 MHz.
  - Added trace resistance or capacitance can reduce maximum frequency capability; use layout practices as directed in [Layout](#).



## Typical Application (continued)

### 9.2.3 Application Curve

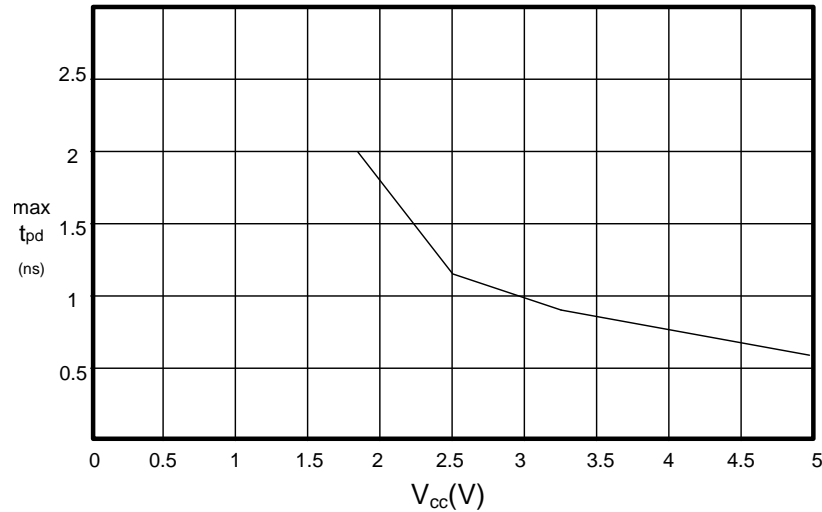

Figure 14.  $t_{pd}$  vs  $V_{CC}$

## 10 Power Supply Recommendations

The power supply can be any voltage between the minimum and maximum supply voltage rating located in the [Absolute Maximum Ratings](#).

Each  $V_{CC}$  terminal should have a good bypass capacitor to prevent power disturbance. For devices with a single supply, a 0.1- $\mu$ F bypass capacitor is recommended. If there are multiple pins labeled  $V_{CC}$ , then a 0.01- $\mu$ F or 0.022- $\mu$ F capacitor is recommended for each  $V_{CC}$  because the  $V_{CC}$  pins will be tied together internally. For devices with dual-supply pins operating at different voltages, for example  $V_{CC}$  and  $V_{DD}$ , a 0.1- $\mu$ F bypass capacitor is recommended for each supply pin. It is acceptable to parallel multiple bypass capacitors to reject different frequencies of noise. 0.1- $\mu$ F and 1- $\mu$ F capacitors are commonly used in parallel. The bypass capacitor should be installed as close to the power terminal as possible for best results.

## 11 Layout

### 11.1 Layout Guidelines

Reflections and matching are closely related to loop antenna theory, but different enough to warrant their own discussion. When a PCB trace turns a corner at a 90° angle, a reflection can occur. This is primarily due to the change of width of the trace. At the apex of the turn, the trace width is increased to 1.414 times its width. This upsets the transmission line characteristics, especially the distributed capacitance and self-inductance of the trace — resulting in the reflection.

**NOTE**

Not all PCB traces can be straight, and so they will have to turn corners. [Figure 15](#) shows progressively better techniques of rounding corners. Only the last example maintains constant trace width and minimizes reflections.

### 11.2 Layout Example

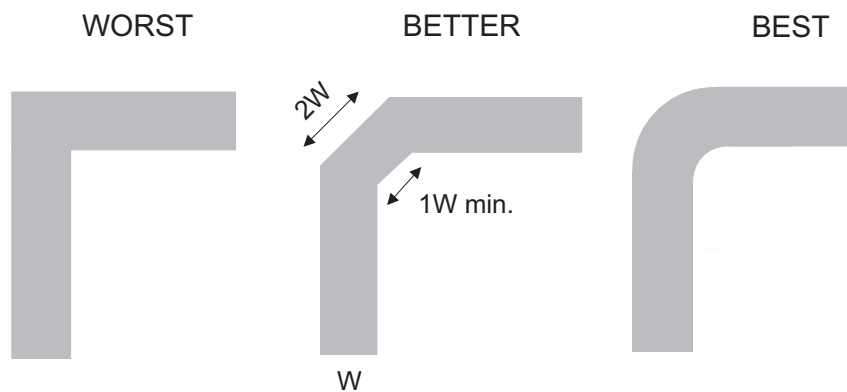

Figure 15. Trace Example

## 12 器件和文档支持

### 12.1 文档支持

#### 12.1.1 相关文档

请参阅如下相关文档：

《慢速或悬空 CMOS 输入的影响》，SCBA004

### 12.2 接收文档更新通知

要接收文档更新通知，请导航至 [TI.com.cn](http://TI.com.cn) 上的器件产品文件夹。单击右上角的通知我进行注册，即可每周接收产品信息更改摘要。有关更改的详细信息，请查看任何已修订文档中包含的修订历史记录。

### 12.3 社区资源

下列链接提供到 TI 社区资源的连接。链接的内容由各个分销商“按照原样”提供。这些内容并不构成 TI 技术规范，并且不一定反映 TI 的观点；请参阅 TI 的《使用条款》。

**TI E2E™ 在线社区** *TI 的工程师对工程师 (E2E) 社区*。此社区的创建目的在于促进工程师之间的协作。在 [e2e.ti.com](http://e2e.ti.com) 中，您可以咨询问题、分享知识、拓展思路并与同行工程师一道帮助解决问题。

**设计支持** *TI 参考设计支持* 可帮助您快速查找有帮助的 E2E 论坛、设计支持工具以及技术支持的联系信息。

### 12.4 商标

NanoFree, E2E are trademarks of Texas Instruments.

All other trademarks are the property of their respective owners.

### 12.5 静电放电警告



这些装置包含有限的内置 ESD 保护。存储或装卸时，应将导线一起截短或将装置放置于导电泡棉中，以防止 MOS 门极遭受静电损伤。

### 12.6 术语表

**SLYZ022** — *TI 术语表*。

这份术语表列出并解释术语、缩写和定义。

## 13 机械、封装和可订购信息

以下页面包含机械、封装和可订购信息。这些信息是指定器件的最新可用数据。数据如有变更，恕不另行通知，且不会对此文档进行修订。如需获取此数据表的浏览器版本，请查阅左侧的导航栏。

**PACKAGING INFORMATION**

Orderable Device	Status (1)	Package Type	Package Drawing	Pins	Package Qty	Eco Plan (2)	Lead finish/ Ball material (6)	MSL Peak Temp (3)	Op Temp (°C)	Device Marking (4/5)	Samples
SN74LVC2G53DCT3	ACTIVE	SM8	DCT	8	3000	RoHS & Non-Green	SNBI	Level-1-260C-UNLIM	-40 to 85	C53 Z	<a href="#">Samples</a>
SN74LVC2G53DCTR	ACTIVE	SM8	DCT	8	3000	RoHS & Green	NIPDAU	Level-1-260C-UNLIM	-40 to 85	C53 Z	<a href="#">Samples</a>
SN74LVC2G53DCTRG4	ACTIVE	SM8	DCT	8	3000	RoHS & Green	NIPDAU	Level-1-260C-UNLIM	-40 to 85	C53 Z	<a href="#">Samples</a>
SN74LVC2G53DCUR	ACTIVE	VSSOP	DCU	8	3000	RoHS & Green	NIPDAU   SN	Level-1-260C-UNLIM	-40 to 85	(53, C53Q, C53R) CZ	<a href="#">Samples</a>
SN74LVC2G53DCURG4	ACTIVE	VSSOP	DCU	8	3000	RoHS & Green	NIPDAU	Level-1-260C-UNLIM	-40 to 85	C53R	<a href="#">Samples</a>
SN74LVC2G53DCUT	ACTIVE	VSSOP	DCU	8	250	RoHS & Green	NIPDAU   SN	Level-1-260C-UNLIM	-40 to 85	(53, C53Q, C53R) CZ	<a href="#">Samples</a>
SN74LVC2G53DCUTG4	ACTIVE	VSSOP	DCU	8	250	RoHS & Green	NIPDAU	Level-1-260C-UNLIM		C53R	<a href="#">Samples</a>
SN74LVC2G53YZPR	ACTIVE	DSBGA	YZP	8	3000	RoHS & Green	SNAGCU	Level-1-260C-UNLIM	-40 to 85	C4N	<a href="#">Samples</a>

(1) The marketing status values are defined as follows:

**ACTIVE:** Product device recommended for new designs.

**LIFEBUY:** TI has announced that the device will be discontinued, and a lifetime-buy period is in effect.

**NRND:** Not recommended for new designs. Device is in production to support existing customers, but TI does not recommend using this part in a new design.

**PREVIEW:** Device has been announced but is not in production. Samples may or may not be available.

**OBSELETE:** TI has discontinued the production of the device.

(2) **RoHS:** TI defines "RoHS" to mean semiconductor products that are compliant with the current EU RoHS requirements for all 10 RoHS substances, including the requirement that RoHS substance do not exceed 0.1% by weight in homogeneous materials. Where designed to be soldered at high temperatures, "RoHS" products are suitable for use in specified lead-free processes. TI may reference these types of products as "Pb-Free".

**RoHS Exempt:** TI defines "RoHS Exempt" to mean products that contain lead but are compliant with EU RoHS pursuant to a specific EU RoHS exemption.

**Green:** TI defines "Green" to mean the content of Chlorine (Cl) and Bromine (Br) based flame retardants meet JS709B low halogen requirements of <=1000ppm threshold. Antimony trioxide based flame retardants must also meet the <=1000ppm threshold requirement.

(3) MSL, Peak Temp. - The Moisture Sensitivity Level rating according to the JEDEC industry standard classifications, and peak solder temperature.

(4) There may be additional marking, which relates to the logo, the lot trace code information, or the environmental category on the device.

<sup>(5)</sup> Multiple Device Markings will be inside parentheses. Only one Device Marking contained in parentheses and separated by a "-" will appear on a device. If a line is indented then it is a continuation of the previous line and the two combined represent the entire Device Marking for that device.

<sup>(6)</sup> Lead finish/Ball material - Orderable Devices may have multiple material finish options. Finish options are separated by a vertical ruled line. Lead finish/Ball material values may wrap to two lines if the finish value exceeds the maximum column width.

**Important Information and Disclaimer:**The information provided on this page represents TI's knowledge and belief as of the date that it is provided. TI bases its knowledge and belief on information provided by third parties, and makes no representation or warranty as to the accuracy of such information. Efforts are underway to better integrate information from third parties. TI has taken and continues to take reasonable steps to provide representative and accurate information but may not have conducted destructive testing or chemical analysis on incoming materials and chemicals. TI and TI suppliers consider certain information to be proprietary, and thus CAS numbers and other limited information may not be available for release.

In no event shall TI's liability arising out of such information exceed the total purchase price of the TI part(s) at issue in this document sold by TI to Customer on an annual basis.

**TAPE AND REEL INFORMATION**

**QUADRANT ASSIGNMENTS FOR PIN 1 ORIENTATION IN TAPE**

\*All dimensions are nominal

Device	Package Type	Package Drawing	Pins	SPQ	Reel Diameter (mm)	Reel Width W1 (mm)	A0 (mm)	B0 (mm)	K0 (mm)	P1 (mm)	W (mm)	Pin1 Quadrant
SN74LVC2G53DCT3	SM8	DCT	8	3000	180.0	13.0	3.35	4.5	1.55	4.0	12.0	Q3
SN74LVC2G53DCTR	SM8	DCT	8	3000	180.0	13.0	3.35	4.5	1.55	4.0	12.0	Q3
SN74LVC2G53DCUR	VSSOP	DCU	8	3000	180.0	9.0	2.25	3.4	1.0	4.0	8.0	Q3
SN74LVC2G53DCUR	VSSOP	DCU	8	3000	180.0	8.4	2.25	3.35	1.05	4.0	8.0	Q3
SN74LVC2G53DCURG4	VSSOP	DCU	8	3000	180.0	8.4	2.25	3.35	1.05	4.0	8.0	Q3
SN74LVC2G53DCUTG4	VSSOP	DCU	8	250	180.0	8.4	2.25	3.35	1.05	4.0	8.0	Q3
SN74LVC2G53YZPR	DSBGA	YZP	8	3000	178.0	9.2	1.02	2.02	0.63	4.0	8.0	Q1

**TAPE AND REEL BOX DIMENSIONS**

\*All dimensions are nominal

Device	Package Type	Package Drawing	Pins	SPQ	Length (mm)	Width (mm)	Height (mm)
SN74LVC2G53DCT3	SM8	DCT	8	3000	182.0	182.0	20.0
SN74LVC2G53DCTR	SM8	DCT	8	3000	182.0	182.0	20.0
SN74LVC2G53DCUR	VSSOP	DCU	8	3000	182.0	182.0	20.0
SN74LVC2G53DCUR	VSSOP	DCU	8	3000	202.0	201.0	28.0
SN74LVC2G53DCURG4	VSSOP	DCU	8	3000	202.0	201.0	28.0
SN74LVC2G53DCUTG4	VSSOP	DCU	8	250	202.0	201.0	28.0
SN74LVC2G53YZPR	DSBGA	YZP	8	3000	220.0	220.0	35.0

YZP0008

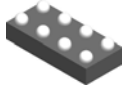

PACKAGE OUTLINE

DSBGA - 0.5 mm max height

DIE SIZE BALL GRID ARRAY

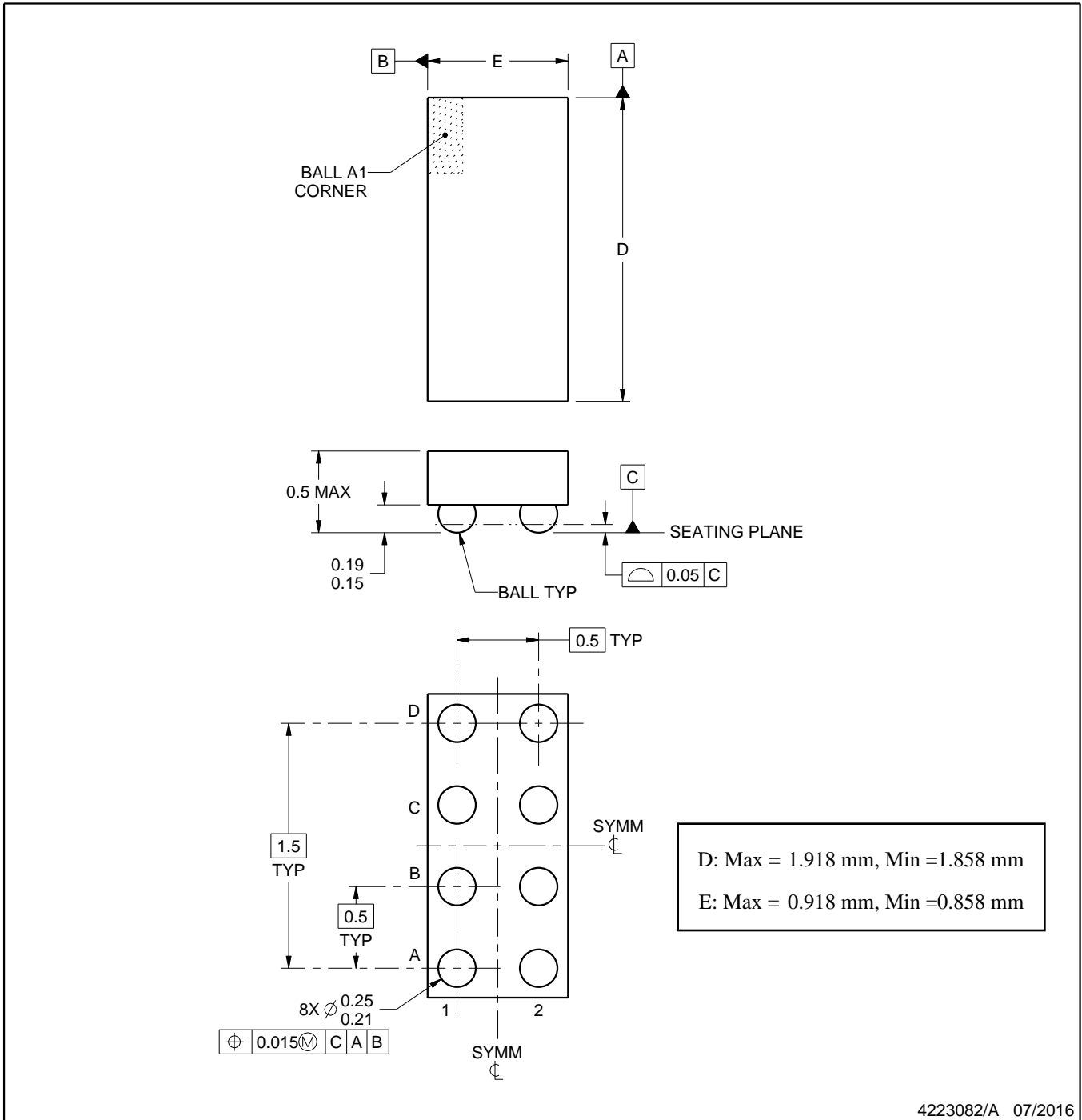

NOTES:

1. All linear dimensions are in millimeters. Any dimensions in parenthesis are for reference only. Dimensioning and tolerancing per ASME Y14.5M.
2. This drawing is subject to change without notice.



# EXAMPLE BOARD LAYOUT

YZP0008

DSBGA - 0.5 mm max height

DIE SIZE BALL GRID ARRAY

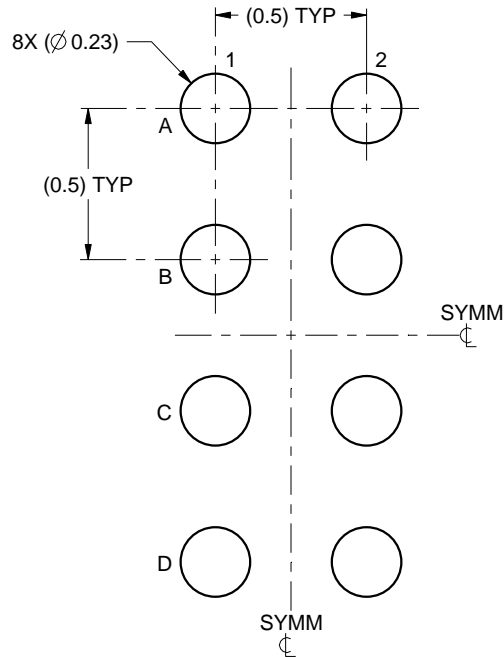

LAND PATTERN EXAMPLE  
SCALE:40X

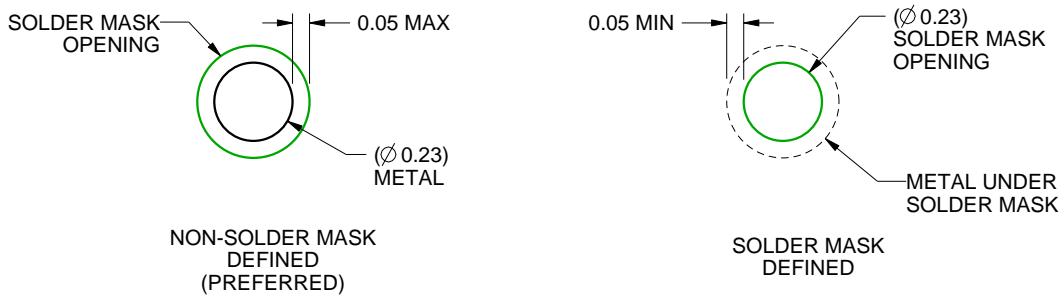

SOLDER MASK DETAILS  
NOT TO SCALE

4223082/A 07/2016

NOTES: (continued)

- Final dimensions may vary due to manufacturing tolerance considerations and also routing constraints. For more information, see Texas Instruments literature number SNVA009 ([www.ti.com/lit/snva009](http://www.ti.com/lit/snva009)).

# EXAMPLE STENCIL DESIGN

YZP0008

DSBGA - 0.5 mm max height

DIE SIZE BALL GRID ARRAY

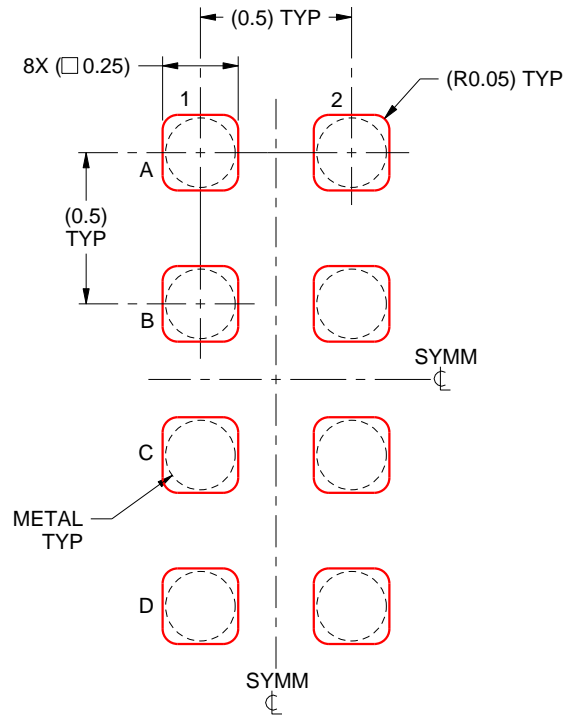

SOLDER PASTE EXAMPLE  
BASED ON 0.1 mm THICK STENCIL  
SCALE:40X

4223082/A 07/2016

NOTES: (continued)

4. Laser cutting apertures with trapezoidal walls and rounded corners may offer better paste release.

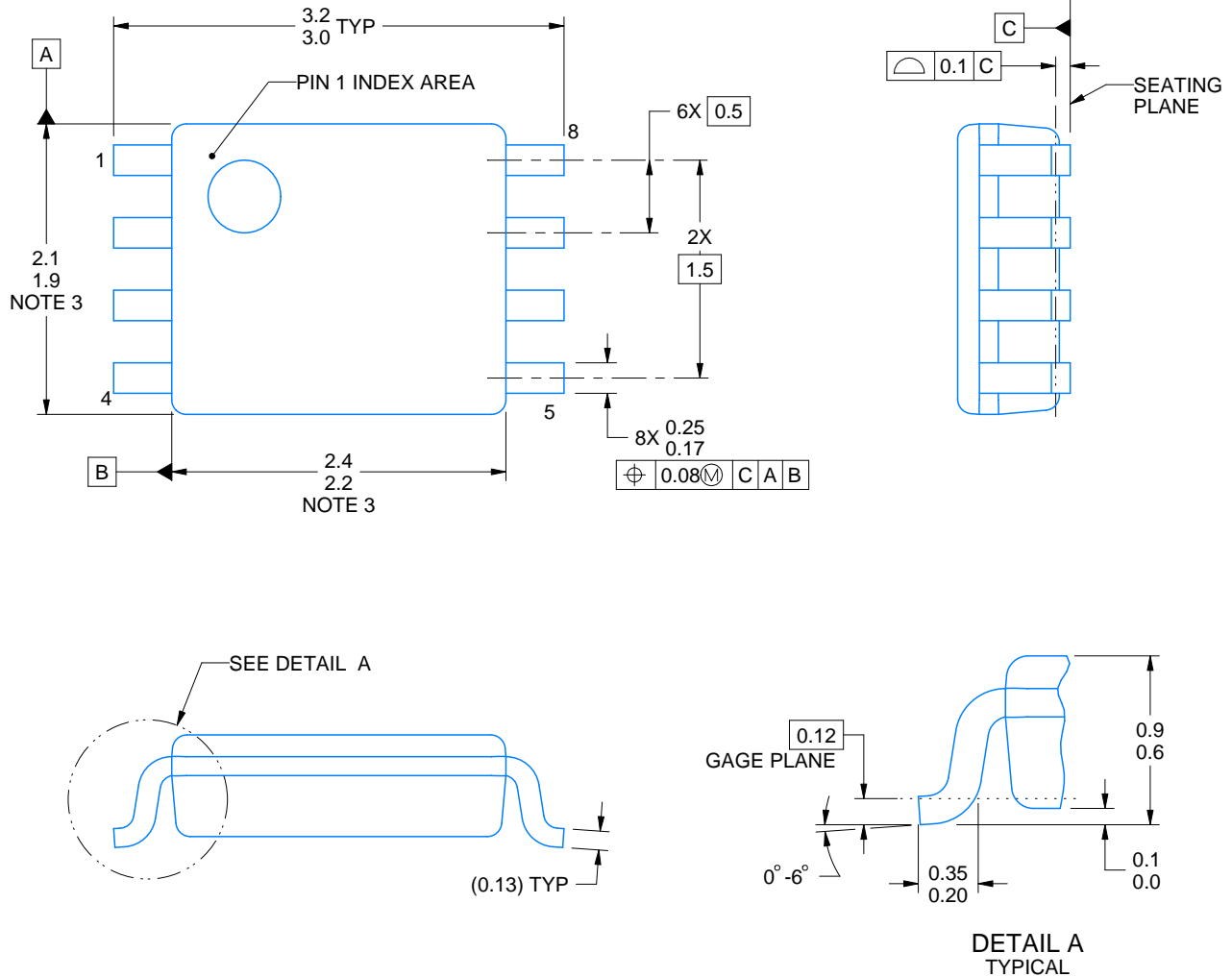

4225266/A 09/2014

NOTES:

1. All linear dimensions are in millimeters. Any dimensions in parenthesis are for reference only. Dimensioning and tolerancing per ASME Y14.5M.
2. This drawing is subject to change without notice.
3. This dimension does not include mold flash, protrusions, or gate burrs. Mold flash, protrusions, or gate burrs shall not exceed 0.15 mm per side.
4. Reference JEDEC registration MO-187 variation CA.

# EXAMPLE BOARD LAYOUT

DCU0008A

VSSOP - 0.9 mm max height

SMALL OUTLINE PACKAGE

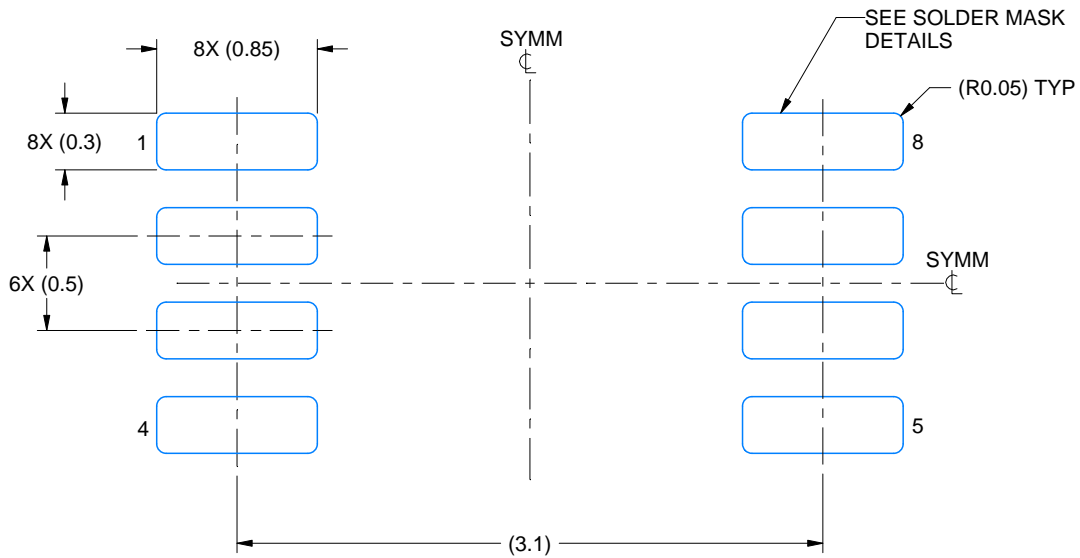

LAND PATTERN EXAMPLE  
EXPOSED METAL SHOWN  
SCALE: 25X

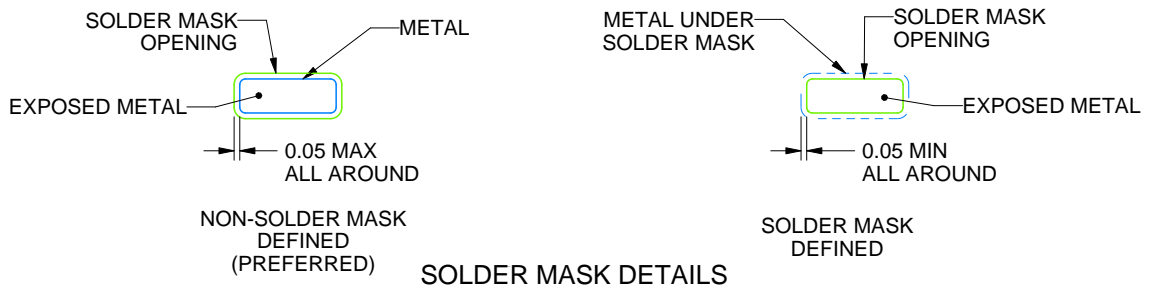

4225266/A 09/2014

NOTES: (continued)

- 5. Publication IPC-7351 may have alternate designs.
- 6. Solder mask tolerances between and around signal pads can vary based on board fabrication site.

# EXAMPLE STENCIL DESIGN

DCU0008A

VSSOP - 0.9 mm max height

SMALL OUTLINE PACKAGE

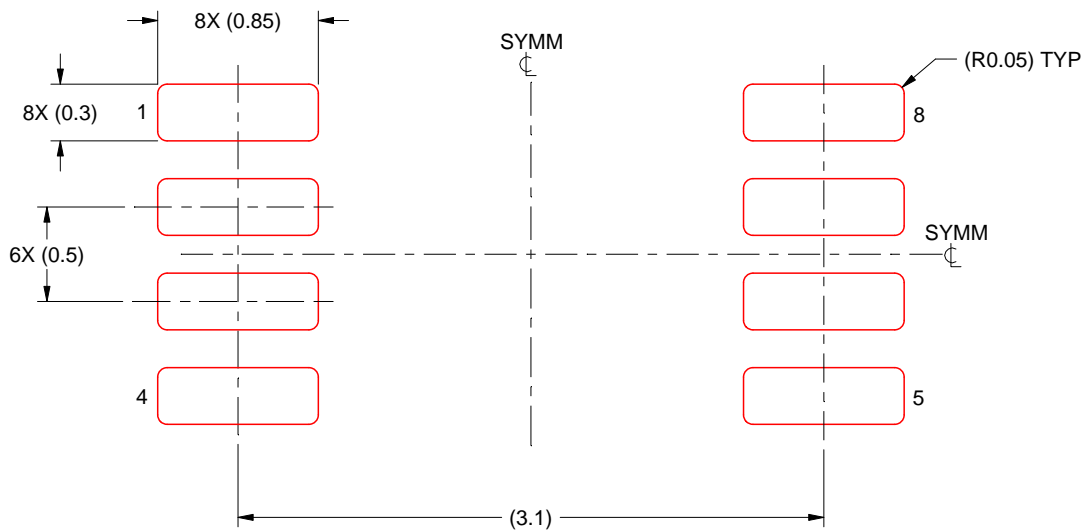

SOLDER PASTE EXAMPLE  
BASED ON 0.125 mm THICK STENCIL  
SCALE: 25X

4225266/A 09/2014

NOTES: (continued)

7. Laser cutting apertures with trapezoidal walls and rounded corners may offer better paste release. IPC-7525 may have alternate design recommendations.
8. Board assembly site may have different recommendations for stencil design.

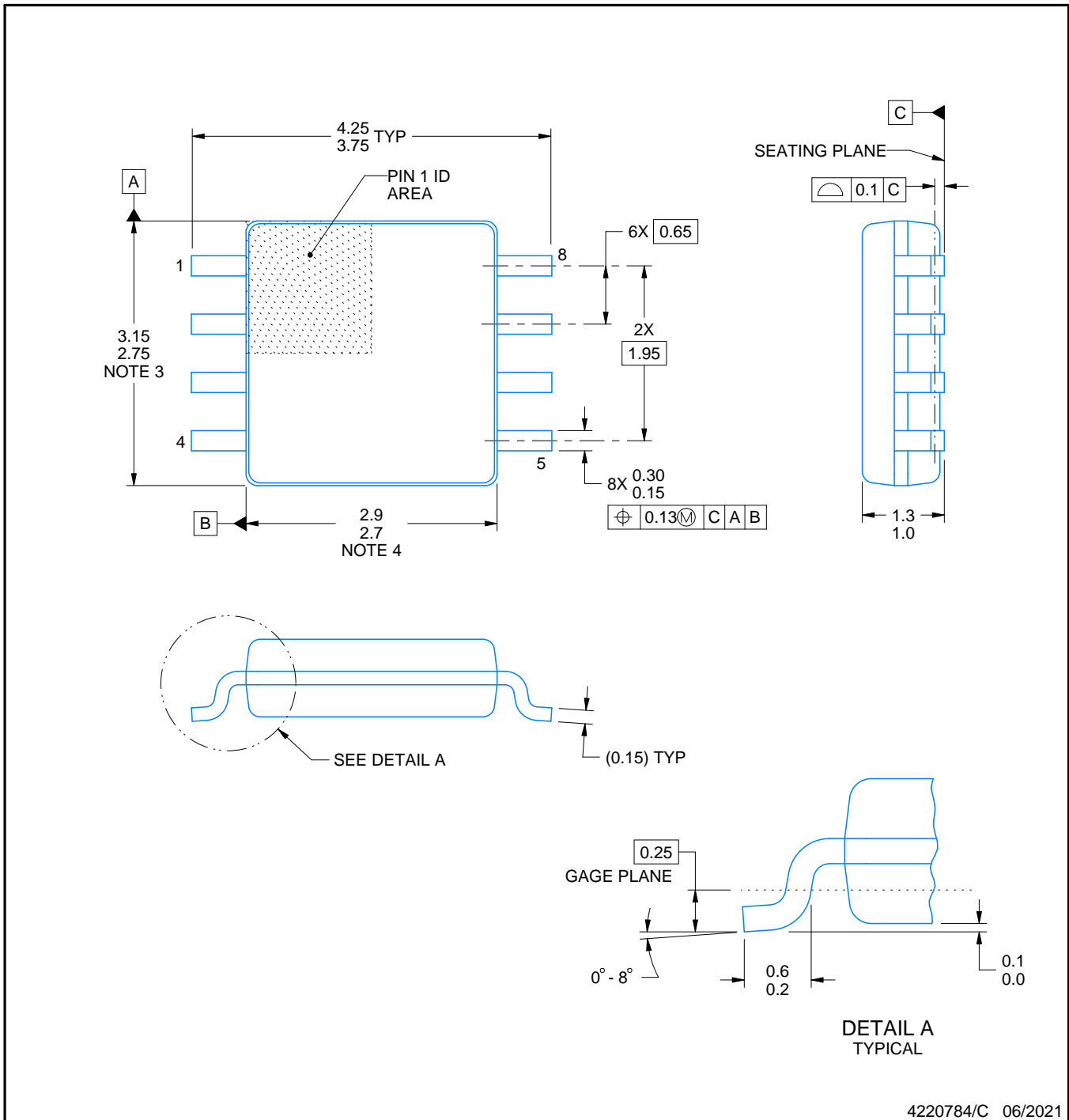
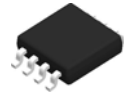

4220784/C 06/2021

NOTES:

1. All linear dimensions are in millimeters. Dimensions in parenthesis are for reference only. Dimensioning and tolerancing per ASME Y14.5M.
2. This drawing is subject to change without notice.
3. This dimension does not include mold flash, protrusions, or gate burrs. Mold flash, protrusions, or gate burrs shall not exceed 0.15 mm per side.
4. This dimension does not include interlead flash. Interlead flash shall not exceed 0.25 mm per side.

# EXAMPLE BOARD LAYOUT

DCT0008A

SSOP - 1.3 mm max height

SMALL OUTLINE PACKAGE

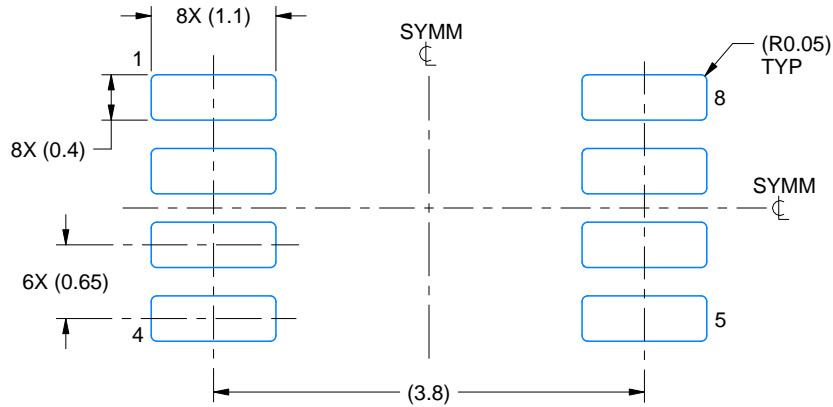

LAND PATTERN EXAMPLE  
EXPOSED METAL SHOWN  
SCALE:15X

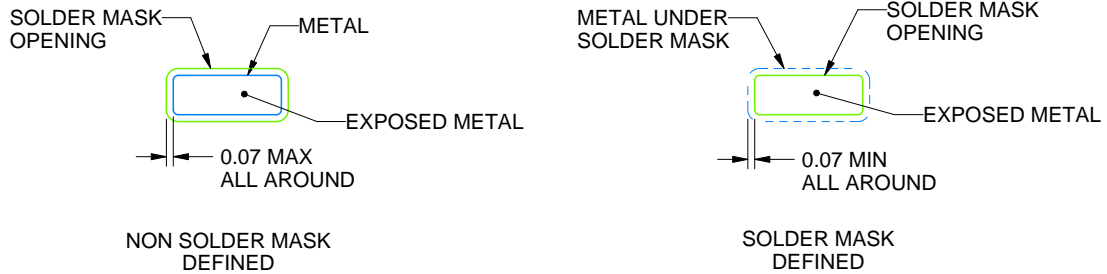

SOLDER MASK DETAILS

4220784/C 06/2021

NOTES: (continued)

- 5. Publication IPC-7351 may have alternate designs.
- 6. Solder mask tolerances between and around signal pads can vary based on board fabrication site.

# EXAMPLE STENCIL DESIGN

DCT0008A

SSOP - 1.3 mm max height

SMALL OUTLINE PACKAGE

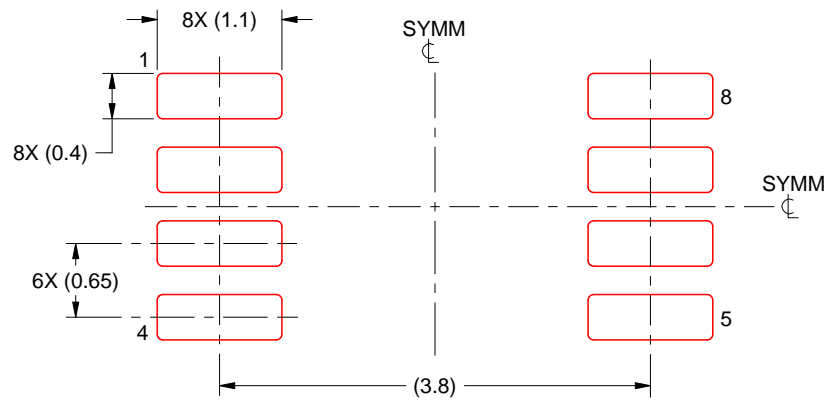

SOLDER PASTE EXAMPLE  
BASED ON 0.125 mm THICK STENCIL  
SCALE:15X

4220784/C 06/2021

NOTES: (continued)

7. Laser cutting apertures with trapezoidal walls and rounded corners may offer better paste release. IPC-7525 may have alternate design recommendations.
8. Board assembly site may have different recommendations for stencil design.



## 重要声明和免责声明

TI“按原样”提供技术和可靠性数据（包括数据表）、设计资源（包括参考设计）、应用或其他设计建议、网络工具、安全信息和其他资源，不保证没有瑕疵且不做任何明示或暗示的担保，包括但不限于对适销性、某特定用途方面的适用性或不侵犯任何第三方知识产权的暗示担保。

这些资源可供使用 TI 产品进行设计的熟练开发人员使用。您将自行承担以下全部责任：(1) 针对您的应用选择合适的 TI 产品，(2) 设计、验证并测试您的应用，(3) 确保您的应用满足相应标准以及任何其他功能安全、信息安全、监管或其他要求。

这些资源如有变更，恕不另行通知。TI 授权您仅可将这些资源用于研发本资源所述的 TI 产品的应用。严禁对这些资源进行其他复制或展示。您无权使用任何其他 TI 知识产权或任何第三方知识产权。您应全额赔偿因在这些资源的使用中对 TI 及其代表造成的任何索赔、损害、成本、损失和债务，TI 对此概不负责。

TI 提供的产品受 [TI 的销售条款](#) 或 [ti.com](#) 上其他适用条款/TI 产品随附的其他适用条款的约束。TI 提供这些资源并不会扩展或以其他方式更改 TI 针对 TI 产品发布的适用的担保或担保免责声明。

TI 反对并拒绝您可能提出的任何其他或不同的条款。

邮寄地址：Texas Instruments, Post Office Box 655303, Dallas, Texas 75265

Copyright © 2023，德州仪器 (TI) 公司