

# DS100BR410 Low Power Quad Channel Repeater with 10.3125 Gbps Equalizer and De-Emphasis Driver

Check for Samples: [DS100BR410](#)

## FEATURES

- Quad channel repeater for up to 10.3125 Gbps
- Low power consumption, with option to power down unused channels
- Adjustable receive equalization
- Adjustable transmit de-emphasis
- Adjustable transmit  $V_{OD}$  (up to 1200 mVp-p)
- IDLE detection — squelch function auto mutes the output for SATA/SAS OOB signal
- $<0.22$  UI of residual DJ at 10.3125 Gbps with 12 meters cable
- Programmable via pin selection or SMBus interface
- Single supply operation at 2.5 V  $\pm 5\%$
- $-40^{\circ}\text{C}$  to  $+85^{\circ}\text{C}$  Operation
- $\geq 7$  kV HBM ESD Rating
- High speed signal flow-through pinout package: 48-pin WQFN (7 mm x 7 mm, 0.5 mm pitch)

## APPLICATIONS

- High-speed active copper cable modules
- FR-4 Backplanes
- 10GE, 8GFC, 10GFC, 10G SONET, SAS, SATA, and InfiniBand

## DESCRIPTION

The DS100BR410 is an extremely low power, high performance quad-channel repeater for high-speed serial links with data rates up to 10.3125 Gbps. The device performs both receive equalization and transmit de-emphasis on each of its 4 channels to compensate for channel loss, allowing maximum flexibility of physical placement within a system.

The receiver's continuous time linear equalizer (CTLE) is capable of opening an input eye that is completely closed due to inter-symbol interference (ISI) induced by the interconnect medium such as backplane trace or cable. The transmitter features adjustable  $V_{OD}$  (output amplitude voltage level) and de-emphasis driver to compensate for PCB trace loss.

With a low power consumption and control to turn-off unused channels, the DS100BR410 is part of TI's PowerWise family of energy efficient devices.

The programmable settings can be applied via pin mode or SMBus mode interface.

## Typical Application Diagram

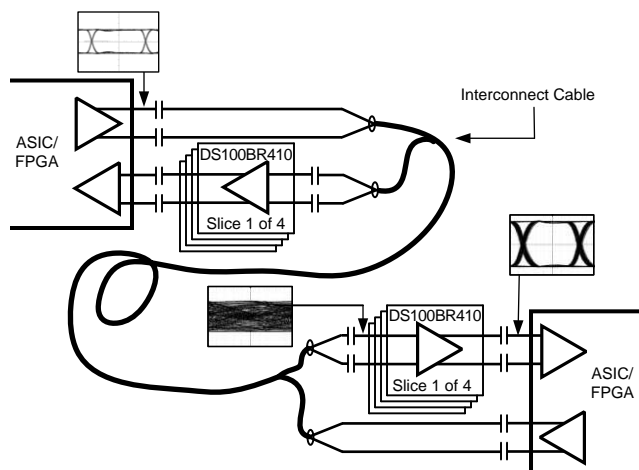

Please be aware that an important notice concerning availability, standard warranty, and use in critical applications of Texas Instruments semiconductor products and disclaimers thereto appears at the end of this data sheet.

All trademarks are the property of their respective owners.

### Connection Diagram

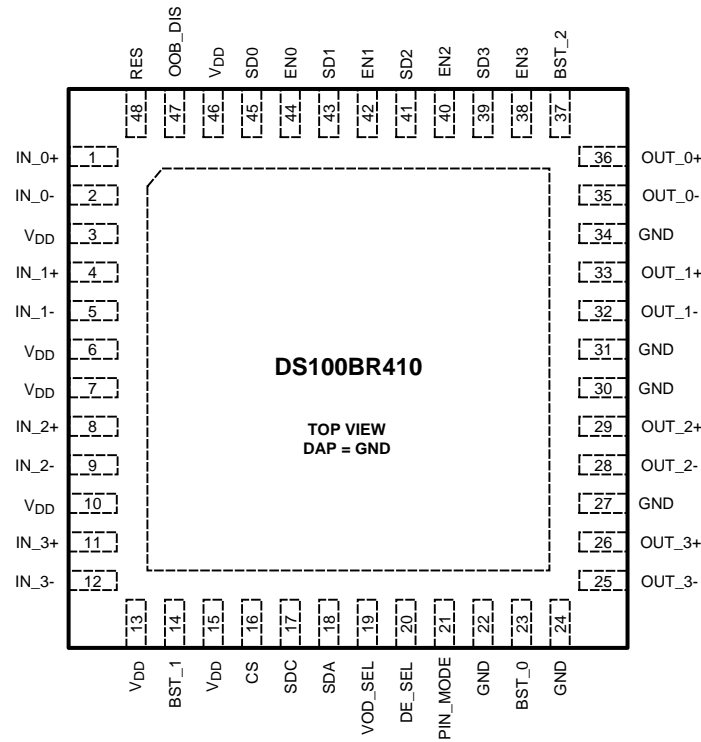

### Pin Descriptions

Pin Name	Pin #	I/O, Type <sup>(1)</sup>	Description
<b>HIGH SPEED DIFFERENTIAL I/O</b>			
IN_0+ IN_0-	1 2	I, CML	Inverting and non-inverting CML differential inputs to the equalizer. An on-chip 100Ω terminating resistor connects IN_0+ to IN_0-.
IN_1+ IN_1-	4 5	I, CML	Inverting and non-inverting CML differential inputs to the equalizer. An on-chip 100Ω terminating resistor connects IN_1+ to IN_1-.
IN_2+ IN_2-	8 9	I, CML	Inverting and non-inverting CML differential inputs to the equalizer. An on-chip 100Ω terminating resistor connects IN_2+ to IN_2-.
IN_3+ IN_3-	11 12	I, CML	Inverting and non-inverting CML differential inputs to the equalizer. An on-chip 100Ω terminating resistor connects IN_3+ to IN_3-.
OUT_0+ OUT_0-	36 35	O, CML	Inverting and non-inverting CML differential outputs from the driver. An on-chip 100Ω terminating resistor connects OUT_0+ to OUT_0-.
OUT_1+ OUT_1-	33 32	O, CML	Inverting and non-inverting CML differential outputs from the driver. An on-chip 100Ω terminating resistor connects OUT_1+ to OUT_1-.
OUT_2+ OUT_2-	29 28	O, CML	Inverting and non-inverting CML differential outputs from the driver. An on-chip 100Ω terminating resistor connects OUT_2+ to OUT_2-.
OUT_3+ OUT_3-	26 25	O, CML	Inverting and non-inverting CML differential outputs from the driver. An on-chip 100Ω terminating resistor connects OUT_3+ to OUT_3-.
<b>2.5V LVCMOS CONTROL PINS</b>			
BST_2 BST_1 BST_0	37 14 23	I, LVCMOS	BST_2, BST_1, and BST_0 select the equalizer boost level for all channels. BST_2 and BST_1 are internally pulled high. BST_0 is internally pulled low. See <a href="#">Table 1</a>
EN0 EN1 EN2 EN3	44 42 40 38	I, LVCMOS	Enable channel n input. When held High, normal operation is selected. When held Low, standby mode is selected. EN is internally pulled High.

(1) **Note:** I = Input O = Output, LVCMOS pins are 2.5 V levels only, **only SMBus pins SDA, SDC and CS are 3.3V tolerant.**

**Pin Descriptions (continued)**

Pin Name	Pin #	I/O, Type <sup>(1)</sup>	Description
PIN_MODE	21	I, LVCMOS	Pin mode control input. When held High, device is in Pin control mode. When held Low, device is in SMBus Control Mode PIN_MODE is internally pulled High.
SD0 SD1 SD2 SD3	45 43 41 39	O, LVCMOS	Signal detect n output. Output is High when signal is detected. Output is Low when signal is NOT detected.
OOB_DIS	47	I, LVCMOS	OOB disable control input. When held High, OOB is disabled. When held Low, OOB is enabled. Out Of Band (OOB) for SATA/SAS applications is active. OOB_DIS is internally pulled Low.
<b>Analog Input Pins (4-level Inputs)</b>			
VOD_SEL	19	I, analog	Differential Output Voltage Select Input Tie to V <sub>DD</sub> , V <sub>OD</sub> = 1.2 Vp-p Leave Open, V <sub>OD</sub> = 1.0 Vp-p Resistor (20 kΩ) to GND, V <sub>OD</sub> = 800 mVp-p Tie to GND, V <sub>OD</sub> = 600 mVp-p
DE_SEL	20	I, analog	De-Emphasis Select Input Tie to V <sub>DD</sub> = -9 dB Leave Open = -6 dB Resistor (20 kΩ) to GND = -3 dB Tie to GND = 0 dB
<b>SERIAL MANAGEMENT BUS (SMBus) INTERFACE</b>			
SDA	18	I/O, LVCMOS	Data Input / Open Drain Output External pull-up resistor is required. Pin is 3.3 V LVCMOS tolerant.
SDC	17	I, LVCMOS	Clock Input Pin is 3.3 V LVCMOS tolerant.
CS	16	I, LVCMOS	Chip Select When high, access to the SMBus registers are enabled. When low, access to the SMBus registers are disabled. Please refer to "SMBus configuration Registers" section for detail information. Pin is 3.3 V LVCMOS tolerant.
<b>POWER</b>			
V <sub>DD</sub>	3, 6, 7, 10, 13, 15, 46	Power	V <sub>DD</sub> = 2.5 V ± 5%
GND	22, 24, 27, 30, 31, 34	Power	Ground reference.
DAP	PAD	Power	Ground reference. The exposed pad at the center of the package must be connected to ground plane of the board with at least 4 via to lower the ground impedance and improve the thermal performance of the package.
RES	48	NC	<b>Reserved</b> – Do not connect



These devices have limited built-in ESD protection. The leads should be shorted together or the device placed in conductive foam during storage or handling to prevent electrostatic damage to the MOS gates.

## Absolute Maximum Ratings <sup>(1)</sup>

Supply Voltage ( $V_{DD}$ )		-0.5V to +2.75V
2.5 I/O Voltage (LVCMOS and Analog Input)		-0.5V to +2.75V
3.3 LVCMOS I/O Voltage (SDA, SDC, CS)		-0.5V to +4.0V
CML Input Voltage ( $IN_{n+/-}$ )		-0.5V to +2.75V
CML Output Voltage ( $OUT_{n+/-}$ )		-0.5V to +2.75V
Junction Temperature		+150°C
Storage Temperature		-65°C to +150°C
ESD Rating	HBM, STD - JESD22-A114F	≥7 kV
	MM, STD - JESD22-A115-A	≥200 V
	CDM, STD - JESD22-C101-D	≥1250 V
Thermal Resistance $\theta_{JA}$ , No Airflow, 4 layer JEDEC, 9 thermal vias		27.6 °C/W
For soldering specifications: see product folder at <a href="http://www.ti.com">www.ti.com</a> <a href="http://www.ti.com/lit/SNOA549">http://www.ti.com/lit/SNOA549</a>		

- (1) "Absolute Maximum Ratings" indicate limits beyond which damage to the device may occur, including inoperability and degradation of device reliability and/or performance. Functional operation of the device and/or non-degradation at the Absolute Maximum Ratings or other conditions beyond those indicated in the Recommended Operating Conditions is not implied.

## Recommended Operating Conditions <sup>(1)</sup>

	Min	Typ	Max	Units
Supply Voltage				
$V_{DD}$ to GND	2.375	2.5	2.625	V
Ambient Temperature	-40	25	+85	°C

- (1) The Recommended Operating Conditions indicate conditions at which the device is functional and the device should not be operated beyond such conditions.

## Electrical Characteristics

Over recommended operating supply and temperature ranges with default register settings unless other specified. <sup>(1)</sup>

Parameter		Test Conditions	Min	Typ	Max	Units
<b>POWER</b>						
PD	Power Supply Consumption	Device Output Enabled (EN[3:0] = High), VOD_SEL = open (1.0 Vp-p)		220	275	mW
		Device Output Disable (EN[3:0] = Low)		25	40	mW
PS <sub>NT</sub>	Supply Noise Tolerance <sup>(2)</sup>	50 Hz to 100 Hz		100		mV <sub>p-p</sub>
		100 Hz to 10 MHz		40		mV <sub>p-p</sub>
		10 MHz to 5.0 GHz		10		mV <sub>p-p</sub>
<b>2.5 LVCMOS DC Specifications</b>						
$V_{IH}$	High Level Input Voltage		1.75		$V_{DD}$	V
$V_{IL}$	Low Level Input Voltage		-0.3		0.7	V
$V_{OH}$	High Level Output Voltage	$I_{OH} = -3mA$	2.0			V
$V_{OL}$	Low Level Output Voltage	$I_{OL} = 3mA$			0.4	V
$I_{IN}$	Input Leakage Current	$V_{IN} = V_{DD}$			+10	μA
		$V_{IN} = GND$	-10			μA

- (1) Typical values represent most likely parametric norms at  $V_{DD} = 2.5V$ ,  $T_A = 25^\circ C$ ., and at the Recommended Operation Conditions at the time of product characterization and are not ensured.  
 (2) Specification is ensured by characterization at optimal boost setting and is not tested in production.

## Electrical Characteristics (continued)

Over recommended operating supply and temperature ranges with default register settings unless other specified. <sup>(1)</sup>

Parameter		Test Conditions	Min	Typ	Max	Units
I <sub>IN-P</sub>	Input Leakage Current with Internal Pull-Down/Up Resistors	V <sub>IN</sub> = V <sub>DD</sub> , with internal pull-down resistors			+65	μA
		V <sub>IN</sub> = GND, with internal pull-up resistors	-50			μA
<b>Signal Detect</b>						
SDH	Signal Detect ON Threshold Level	Default input signal level to assert SD pin, 10.3125 Gbps		130		mV <sub>p-p</sub>
SDL	Signal Detect OFF Threshold Level	Default input signal level to de-assert SD, 10.3125 Gbps		60		mV <sub>p-p</sub>
<b>CML Receiver Inputs (IN<sub>n+</sub>, IN<sub>n-</sub>)</b>						
V <sub>TX</sub>	Source Transmit Launch Signal Level (IN diff)	AC-Coupled Requirement, Differential measurement at point A. <a href="#">Figure 1</a>	600		1600	mV <sub>p-p</sub>
R <sub>LI</sub>	Differential Input Return Loss - SDD11	100 MHz – 6 GHz, with fixture's effect de-embedded		-15		dB
<b>CML Driver Outputs (OUT<sub>n+</sub>, OUT<sub>n-</sub>)</b>						
V <sub>OD</sub>	Output Differential Voltage Level <sup>(3)</sup> , <a href="#">Figure 2</a>	Differential measurement with OUT+ and OUT- terminated by 50Ω to GND, AC-Coupled, VOD_SEL = open (1.0 V <sub>p-p</sub> ), DE_SEL = GND	750	970	1150	mV <sub>p-p</sub>
		Differential measurement with OUT+ and OUT- terminated by 50Ω to GND, AC-Coupled, VOD_SEL = V <sub>DD</sub> (1.2 V <sub>p-p</sub> ), DE_SEL = GND		1140		mV <sub>p-p</sub>
V <sub>OD_DE</sub>	De-Emphasis Levels <sup>(4) (5)</sup>	DE_SEL = 20kΩ to GND, VOD_SEL = V <sub>DD</sub> (1.2 V <sub>p-p</sub> )		-3		dB
		DE_SEL = open, VOD_SEL = V <sub>DD</sub> (1.2 V <sub>p-p</sub> )		-6		dB
		DE_SEL = V <sub>DD</sub> , VOD_SEL = V <sub>DD</sub> (1.2 V <sub>p-p</sub> )		-9		dB
t <sub>R</sub> , t <sub>F</sub>	Transition Time	20% to 80% of differential output voltage, measured within 1" from output pins. <a href="#">Figure 2</a>	30	38	45	ps
R <sub>LO</sub>	Differential Output Return Loss - SDD22	100 MHz – 6 GHz, with fixture's effect de-embedded. IN+ = static high.		-15		dB
t <sub>PLHD</sub>	Differential Low to High Propagation Delay	Propagation delay measurement at 50% crossing between input to output, 100 Mbps. <a href="#">Figure 3</a>		240		ps
t <sub>PHLD</sub>	Differential High to Low Propagation Delay			240		ps
t <sub>CCSK</sub>	Inter Pair Channel to Channel Skew	Difference in 50% crossing between channels		7		ps
t <sub>PPSK</sub>	Part to Part Output Skew	Difference in 50% crossing between outputs		20		ps
RJ	Random Jitter	V <sub>TX</sub> = 1.0 V <sub>p-p</sub> , BST_[2:0] = 000, <sup>(4) (6)</sup>		0.3		ps <sub>rms</sub>

(3) Measured with clock-like {11111 00000} pattern.

(4) Measured with clock-like {11111 00000} pattern.

(5) The de-emphasis level of -3 dB, -6 dB, -9 dB are for V<sub>OD</sub> = 1.2 V<sub>p-p</sub>. At lower V<sub>OD</sub> level, the de-emphasis levels are reduced.

(6) Random jitter contributed by the equalizer is defined as sqrt(J<sub>OUT</sub><sup>2</sup> - J<sub>IN</sub><sup>2</sup>). J<sub>OUT</sub> is the random jitter at equalizer outputs in ps-rms, see point C of [Figure 1](#); J<sub>IN</sub> is the random jitter at the input of the equalizer in ps-rms, see point B of [Figure 1](#).

## Electrical Characteristics (continued)

Over recommended operating supply and temperature ranges with default register settings unless other specified. <sup>(1)</sup>

Parameter	Test Conditions	Min	Typ	Max	Units	
<b>Equalization</b>						
DJ1	Residual Deterministic Jitter at 10.3125 Gbps	$V_{TX} = 1.0 V_{P-P}$ , 12 meter 30 AWG cable, EQ = 03F'h (BST[2:0] = 111), PRBS-7 ( $2^7-1$ ) pattern. <sup>(7)</sup>		0.10	0.22	UI <sub>P-P</sub>
DJ2	Residual Deterministic Jitter at 6.0 Gbps	$V_{TX} = 1.0 V_{P-P}$ , 12 meter 30 AWG cable, EQ = 07F'h, PRBS-7 ( $2^7-1$ ) pattern. <sup>(7)</sup>		0.07	0.12	UI <sub>P-P</sub>
<b>Signal DETECT and ENABLE Timing</b>						
$t_{ZISD}$	Input OFF to ON detect — SD Output High Response Time	Response time measurement at $V_{IN}$ to SD output, $V_{IN} = 800 mV_{P-P}$ , 100 Mbps, 40" of 6 mil microstrip FR4. <a href="#">Figure 4</a>		35		ns
$t_{IZSD}$	Input ON to OFF detect — SD Output Low Response Time			400		ns
$t_{ZOED}$	EN High to Output ON Response Time	Response time measurement at EN input to $V_O$ , $V_{IN} = 800 mV_{P-P}$ , 100 Mbps, 40" of 6 mil microstrip FR4. <a href="#">Figure 5</a>		150		ns
$t_{ZOED}$	EN Low to Output OFF Response Time			5		ns

(7) Deterministic jitter is measured at the differential outputs (point C of [Figure 1](#)), minus the deterministic jitter before the test channel (point A of [Figure 1](#)). Random jitter is removed through the use of averaging or similar means.

## Electrical Characteristics — Serial Management Bus Interface

Over recommended operating supply and temperature ranges unless other specified. <sup>(1)</sup>

Parameter	Test Conditions	Min	Typ	Max	Units	
<b>Serial Bus Interface DC Specifications</b>						
$V_{IL}$	Data, Clock Input Low Voltage			0.8	V	
$V_{IH}$	Data, Clock Input High Voltage	2.1		$V_{DD}$	V	
$I_{PULLUP}$	Current Through Pull-Up Resistor or Current Source	High Power Specification	4		mA	
$V_{DD}$	Nominal Bus Voltage	2.375		3.6	V	
$I_{LEAK-Bus}$	Input Leakage Per Bus Segment	See <sup>(2)</sup>		+200	$\mu A$	
$I_{LEAK-Pin}$	Input Leakage Per Device Pin		-15		$\mu A$	
$C_I$	Capacitance for SDA and SDC	See <sup>(2)</sup> <sup>(3)</sup>		10	pF	
$R_{TERM}$	External Termination Resistance pull to $V_{DD} = 2.5V \pm 5\%$ OR $3.3V \pm 10\%$	$V_{DD3.3}$ , <sup>(2)</sup> <sup>(3)</sup>		2000	$\Omega$	
		$V_{DD2.5}$ , <sup>(2)</sup> <sup>(3)</sup>		1000	$\Omega$	
<b>Serial Bus Interface Timing Specifications – (See <a href="#">Figure 6</a>) <sup>(4)</sup><sup>(5)</sup></b>						
$F_{SMB}$	Bus Operating Frequency		10		100	kHz
$T_{BUF}$	Bus Free Time Between Stop and Start Condition		4.7			$\mu s$
$T_{HD:STA}$	Hold time after (Repeated) Start Condition. After this period, the first clock is generated.	At $I_{PULLUP}$ , Max	4.0			$\mu s$
$T_{SU:STA}$	Repeated Start Condition Setup Time		4.7			$\mu s$
$T_{SU:STO}$	Stop Condition Setup Time		4.0			$\mu s$
$T_{HD:DAT}$	Data Hold Time		300			ns

(1) Typical values represent most likely parametric norms at  $V_{DD} = 2.5V$ ,  $T_A = 25^\circ C.$ , and at the Recommended Operation Conditions at the time of product characterization and are not ensured.

(2) Maximum termination voltage should be identical to the device supply voltage.

(3) Compliant to SMBus 2.0 physical layer specification. See System Management Bus (SMBus) Specification Version 2.0, section 3.1.1 SMBus common AC specifications for details.

(4) Recommended value. Parameter not tested in production.

(5) Recommended maximum capacitance load per bus segment is 400pF.

### Electrical Characteristics — Serial Management Bus Interface (continued)

Over recommended operating supply and temperature ranges unless other specified. <sup>(1)</sup>

Parameter	Test Conditions	Min	Typ	Max	Units
$T_{SU:DAT}$	Data Setup Time	250			ns
$T_{LOW}$	Clock Low Period	4.7			$\mu$ s
$T_{HIGH}$	Clock High Period	4.0		50	$\mu$ s
$t_F$	Clock/Data Fall Time			300	ns
$t_R$	Clock/Data Rise Time			1000	ns
$t_{POR}$	Time in which a device must be operational after power-on reset			500	ms

### AC WAVEFORMS AND TEST CIRCUITS

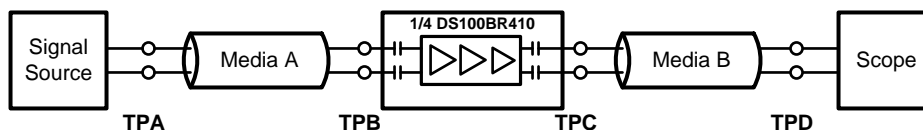

Figure 1. Test Setup Diagram

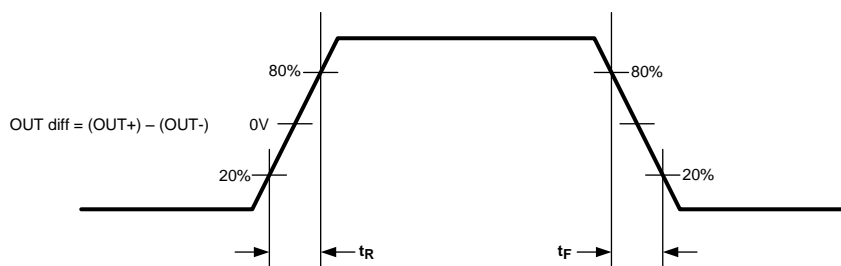

Figure 2. Output Transition Times

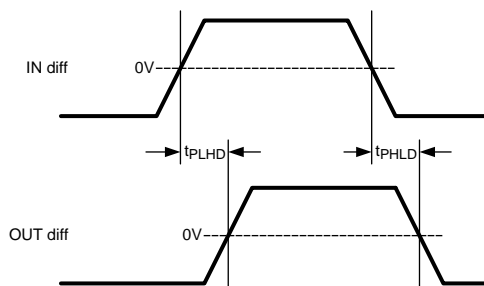

Figure 3. Propagation Delay Timing Diagram

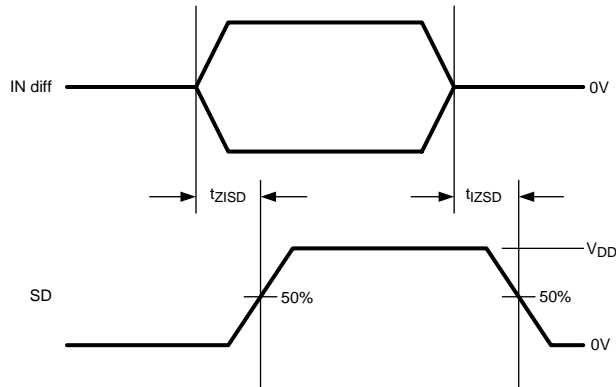

Figure 4. Signal Detect (SD) Delay Timing Diagram

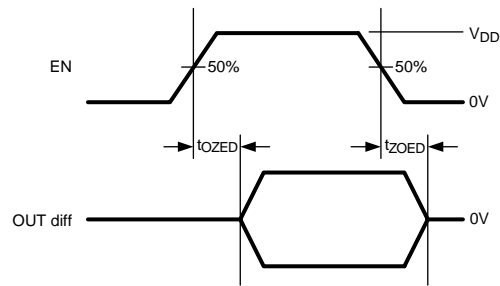

Figure 5. Enable (EN) Delay Timing Diagram

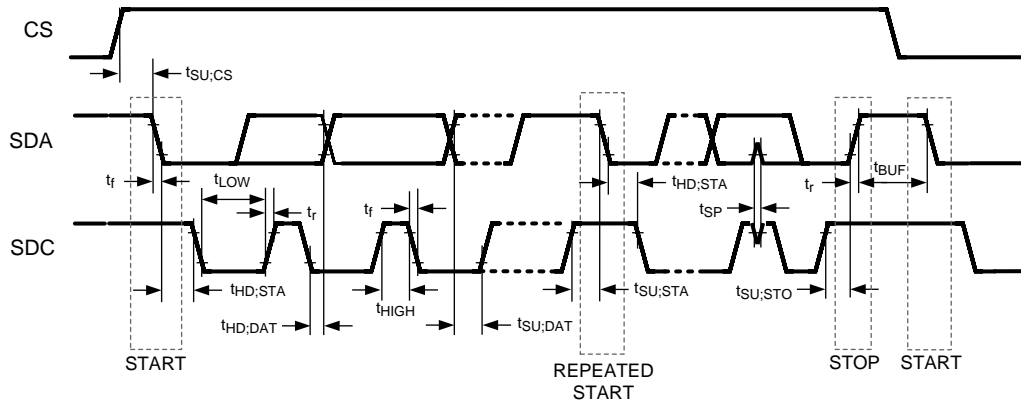

Figure 6. SMBus Timing Parameters



## FUNCTIONAL DESCRIPTION

### DS100BR410 Functional Descriptions

The DS100BR410 is a Low Power Quad Channel Repeater with Equalizer and De-Emphasis Driver optimized for operation up to 10.3125 Gbps for backplane and cable applications.

### DATA CHANNELS

The DS100BR410 provides four data channels. Each data channel consists of an equalizer stage, a limiting amplifier, a DC offset correction block, and a CML driver as shown in Figure 7.

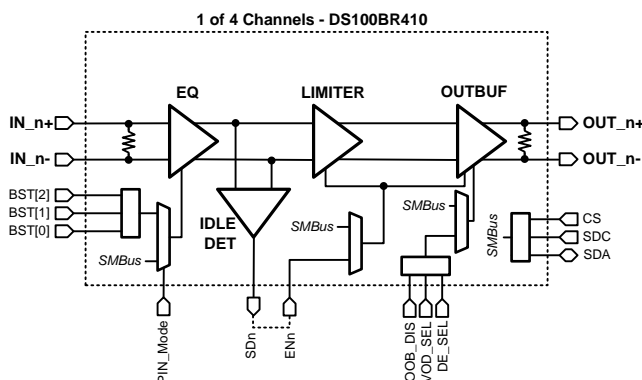

Figure 7. Simplified Block Diagram

### EQUALIZER BOOST CONTROL

Each data channel support eight programmable levels of equalization boost. The state of the PIN\_MODE control input determines how the boost settings are controlled. If PIN\_MODE is held High, then the equalizer boost setting is controlled by the Boost Set pins (BST\_[2:0]) in accordance with Table 1. If this programming method is chosen, then the boost setting selected on the Boost Set pins is applied to all channels. When PIN\_MODE is held Low, the equalizer boost level is controlled through the SMBus. This programming method is accessed via the appropriate SMBus registers (see Table 4). Using this approach, equalizer boost settings can be programmed for each channel individually. PIN\_MODE is internally pulled High, therefore if left open, the boost settings are controlled by the Boost Set pins (BST\_[2:0]). The eight levels of boost settings enables the DS100BR410 to address a wide range of media loss and data rates.

Table 1. Boost / EQ Pin Mode Configuration

Inputs			SMBus Register Bits [8:0]	Result @ 5 GHz
BST_2	BST_1	BST_0		
0	0	0	00000000	2.7 dB
0	0	1	00000001	7.3 dB
0	1	0	00000011	12.2 dB
0	1	1	00000111	16.6 dB
1	0	0	00001111	20.6 dB
1	0	1	00001111	24.8 dB
1	1	0	00010111	27.6 dB (default)
1	1	1	00011111	28.9 dB

## SIGNAL DETECT

The DS100BR410 features a signal detect circuit on each data channel. The status of the signal of each channel can be determined by either reading the Signal Detect bit (SDn) in the SMBus registers (see [Table 4](#)) or by the state of each SDn pin. An output logic high indicates the presence of a signal that has exceeded the ON threshold value (called SDH). An output logic Low means that the input signal has fallen below the OFF threshold value (called SDL). These values are programmed via the SMBus. If not programmed via the SMBus, the thresholds take on the default values. The Signal Detect threshold values can be changed through the SMBus. All threshold values specified are DC peak-to-peak differential signals (positive signal minus negative signal) at the input of the device.

## OUTPUT LEVEL CONTROL

The output amplitude of the CML drivers can be controlled via the 4-level analog input VOD\_SEL pin or via SMBus (see [Table 4](#)). The default V<sub>OD</sub> level is 1.0 V<sub>p-p</sub>.

**Table 2. VOD\_SEL Pin Configuration**

VOD_SEL Pin	Result
Tie High - V <sub>DD</sub>	1.2 V <sub>p-p</sub>
Open* (default)	1.0 V <sub>p-p</sub>
20 kΩ resistor to GND	800 mV <sub>p-p</sub>
Tie to GND	600 mV <sub>p-p</sub>

## OUTPUT DE-EMPHASIS CONTROL

The output De-Emphasis may be controlled via the 4-level analog input DE\_SEL pin or via SMBus (see [Table 4](#)).

**Table 3. DE\_SEL Pin Configuration**

DE_SEL Pin	Result
Tie High - V <sub>DD</sub>	-9 dB
Open* (default)	-6 dB
20 kΩ resistor to GND	-3 dB
Tie to GND	0 dB

## AUTOMATIC ENABLE FEATURE

It may be desirable to place unused channels in power-saving Standby mode. This can be accomplished by connecting the Signal detect (SDn) pin to the Enable (ENn) pin for each channel (See [Figure 7](#)).

## System Management Bus (SMBus) and Configuration Registers

The System Management Bus interface is compatible to SMBus 2.0 physical layer specification. The use of the Chip Select signal is **required**. Holding the CS pin High enables the SMBus port allowing access to the configuration registers. Holding the CS pin Low disables the device's SMBus allowing communication from the host to other slave devices on the bus. In the STANDBY state, the System Management Bus remains active. When communication to other devices on the SMBus is active, the CS signal for the DS100BR410s must be driven Low.

The address byte for all DS100BR410s is AC'h. Based on the SMBus 2.0 specification, the DS100BR410 has a 7-bit slave address of 1010110'b. The LSB is set to 0'b (for a WRITE), thus the 8-bit value is 1010 1100'b or AC'h.

The SDA, SDC and CS pins are 3.3V tolerant, but are not 5V tolerant. External pull-up resistor is required on the SDA. The resistor value can be from 1 kΩ to 5 kΩ depending on the voltage, loading and speed. The SDC and CS may also require an external pull-up resistor and it depends on the Host that drives the bus.

## Transfer of Data via the SMBus

During normal operation the data on SDA must be stable during the time when SDC is High.

There are three unique states for the SMBus:

**START:** A High-to-Low transition on SDA while SDC is High indicates a message START condition.

**STOP:** A Low-to-High transition on SDA while SDC is High indicates a message STOP condition.

**IDLE:** If SDC and SDA are both High for a time exceeding  $t_{BUF}$  from the last detected STOP condition or if they are High for a total exceeding the maximum specification for  $t_{HIGH}$  then the bus will transfer to the IDLE state.

### SMBus Transactions

The device supports WRITE, Burst WRITE, READ, and Burst READ transactions. See [Table 4](#) for register address, type (Read/Write, Read Only), default value and function information.

#### Writing a Register

To write a register, the following protocol is used (see SMBus 2.0 specification).

1. The Host (Master) selects the device by driving its SMBus Chip Select (CS) signal High.
2. The Host drives a START condition, the 7-bit SMBus address, and a “0” indicating a WRITE.
3. The Device (Slave) drives the ACK bit (“0”).
4. The Host drives the 8-bit Register Address.
5. The Device drives an ACK bit (“0”).
6. The Host drive the 8-bit data byte.
7. The Device drives an ACK bit (“0”).
8. The Host drives a STOP condition.
9. The Host de-selects the device by driving its SMBus CS signal Low.

The WRITE transaction is completed, the bus goes IDLE and communication with other SMBus devices may now occur.

#### Reading a Register

To read a register, the following protocol is used (see SMBus 2.0 specification).

1. The Host (Master) selects the device by driving its SMBus Chip Select (CS) signal High.
2. The Host drives a START condition, the 7-bit SMBus address, and a “0” indicating a WRITE.
3. The Device (Slave) drives the ACK bit (“0”).
4. The Host drives the 8-bit Register Address.
5. The Device drives an ACK bit (“0”).
6. The Host drives a START condition.
7. The Host drives the 7-bit SMBus Address, and a “1” indicating a READ.
8. The Device drives an ACK bit “0”.
9. The Device drives the 8-bit data value (register contents).
10. The Host drives a NACK bit “1” indicating end of the READ transfer.
11. The Host drives a STOP condition.
12. The Host de-selects the device by driving its SMBus CS signal Low.

The READ transaction is completed, the bus goes IDLE and communication with other SMBus devices may now occur.

#### Information on the Registers

The status registers 01'h to 03'h provide information of the channel that is selected. The information provided are the OOB\_DIS, EN, EQ Boost, VOD and DEM bits of the selected channel. By default, channel 0 is selected. In order to change the selected channel, write to reg\_07 bit[5:4]. Write a 1 to reg\_07 bit[0] is also needed to allow the registers 13'h to 1A'h to control the channel EN and EQ boost bits of each of the channels. Each channel can be individually enabled (EN) and set to a desired boost level with these registers. Please refer to [Table 4](#) for additional information.

**Table 4. DS100BR410 Register Map**

ADD (hex)	REG Name	Bit(s)	Field	Type	Default (binary)	Description
00	Device ID	7:4	Device ID	R	0010	Device ID Value
		3	SD_CH3	R		1: Signal detected on CH3 0: No signal
		2	SD_CH2	R		1: Signal detected on CH2 0: No signal
		1	SD_CH1	R		1: Signal detected on CH1 0: No signal
		0	SD_CH0	R		1: Signal detected on CH0 0: No signal
01	Status Register for OOB_DIS, EN and Boost_bit[8]	7	<i>Reserved</i>	R		
		6	OOB_DIS	R		OOB_DIS 1: OOB Disabled 0: OOB Enabled
		5	<i>Reserved</i>	R		
		4	EN	R		EN 1: Channel Enabled 0: Channel Disabled
		3:1	<i>Reserved</i>	R		
		0	Boost_bit[8]	R		Boost_bit[8]
02	Status Register for Boost_bit[7:0]	7:0	Boost_bit[7:0]	R		Boost_bit[7:0]
03	Status Register for VOD[5:4] and DEM[1:0]	7:6	<i>Reserved</i>	R		
		5:4	VOD[5:4]	R		VOD[5:4] 00 = 0.6 Vp-p 01 = 0.8 Vp-p 10 = 1.0 Vp-p 11 = 1.2 Vp-p
		3:2	<i>Reserved</i>	R		
		1:0	DEM[1:0]	R		DEM[1:0] 00 = 0 dB 01 = -3 dB 10 = -6 dB 11 = -9 dB
04	<i>Reserved</i>	7:0	<i>Reserved</i>	R	00	
05	Signal Detect Assert Threshold	7:6	SD_ON_CH3	R/W	00	Signal Detect ON Threshold 00 = 130 mV 01 = 125 mV 10 = 150 mV 11 = 140 mV
		5:4	SD_ON_CH2	R/W	00	
		3:2	SD_ON_CH1	R/W	00	
		1:0	SD_ON_CH0	R/W	00	
06	Signal Detect De-assert Threshold	7:6	SD_OFF_CH3	R/W	00	Signal Detect OFF Threshold 00 = 60 mV 01 = 40 mV 10 = 105 mV 11 = 90 mV
		5:4	SD_OFF_CH2	R/W	00	
		3:2	SD_OFF_CH1	R/W	00	
		1:0	SD_FF_CH0	R/W	00	

**Table 4. DS100BR410 Register Map (continued)**

ADD (hex)	REG Name	Bit(s)	Field	Type	Default (binary)	Description
07	Port/Channel Select and Enable SMBus Registers	7:6	<b>Reserved</b>	R/W	00	
		5:4	Port/Channel Select for Status	R/W	00	Select port/channel [1:0] to report status in REG_01 to REG_03 00 = port0 (CH0) 01 = port1 (CH1) 10 = port2 (CH2) 11 = port3 (CH3)
		3:1	<b>Reserved</b>	R/W	000	
		0	SMBUS Channel EN and EQ boost	R/W	0	Channel EN and EQ Boost through pins or smbms REG_13 to REG_1A 0 = Channel EN[3:0] and EQ BST[2:0] boost set by external pins 1 = Allow channel EN and EQ boost to be set by SMBus Register bits: REG_13 to REG_1A
08	Driver V <sub>OD</sub> Control	7	<b>Reserved</b>	R/W	0	
		6:4	<b>Reserved</b>	R/W	111	
		3:2	VOD Control	R/W	10	00 = 0.6 Vp-p 01 = 0.8 Vp-p 10 = 1.0 Vp-p 11 = 1.2 Vp-p
		1:0	<b>Reserved</b>	R/W	00	
09 – 10	<b>Reserved</b>	7:0	<b>Reserved</b>	R/W	00000000	
11	De-Emphasis Control	7:6	DEM_CH3	R/W	00	00 = 0 dB 01 = -3 dB 10 = -6 dB 11 = -9 dB
		5:4	DEM_CH2	R/W	00	
		3:2	DEM_CH1	R/W	00	
		1:0	DEM_CH0	R/W	00	
12	OOB Signal Detect Control	7:3	<b>Reserved</b>	R/W	00000	
		2:1	<b>Reserved</b>	R/W	11	
		0	OOB Signal Detect Control	R/W	0	0 = OOB signal detect enabled 1 = OOB signal detect disabled
13	Channel 3 EN and EQ Control	7:5	<b>Reserved</b>	R/W	000	
		4	Channel Enable	R/W	1	0 = Disabled 1 = Enabled
		3:1	<b>Reserved</b>	R/W	000	
		0	Boost[8]	R/W	0	See <a href="#">Table 5</a>
14	EQ Control Channel 3	7:0	Boost[7:0]	R/W	00000000	See <a href="#">Table 5</a>
15	Channel 2 EN and EQ Control	7:5	<b>Reserved</b>	R/W	000	
		4	Channel Enable	R/W	1	0 = Disabled 1 = Enabled
		3:1	<b>Reserved</b>	R/W	000	
		0	Boost[8]	R/W	0	See <a href="#">Table 5</a>
16	EQ Control Channel 2	7:0	Boost[7:0]	R/W	00000000	See <a href="#">Table 5</a>
17	Channel 1 EN and EQ Control	7:5	<b>Reserved</b>	R/W	000	
		4	Channel Enable	R/W	1	0 = Disabled 1 = Enabled
		3:1	<b>Reserved</b>	R/W	000	
		0	Boost[8]	R/W	0	See <a href="#">Table 5</a>
18	EQ Control Channel 1	7:0	Boost[7:0]	R/W	00000000	See <a href="#">Table 5</a>

**Table 4. DS100BR410 Register Map (continued)**

ADD (hex)	REG Name	Bit(s)	Field	Type	Default (binary)	Description
19	Channel 0 EN and EQ Control	7:5	<i>Reserved</i>	R/W	000	
		4	Channel Enable	R/W	1	0 = Disabled 1 = Enabled
		3:1	<i>Reserved</i>	R/W	000	
		0	Boost[8]	R/W	0	See <a href="#">Table 5</a>
1A	EQ Control Channel 0	7:0	Boost[7:0]	R/W	00000000	See <a href="#">Table 5</a>

**Table 5. Boost / EQ SMBus Register: 16 levels - recommended settings**

Boost Register Bits									Result
bit[8]	bit[7]	bit[6]	bit[5]	bit[4]	bit[3]	bit[2]	bit[1]	bit[0]	@ 5.5 GHz
0	0	0	0	0	0	0	0	0	000'h - 2.7 dB (BST_[2:0]=000)
0	0	0	0	0	0	0	0	1	001'h - 7.3 dB (BST_[2:0]=001)
0	0	0	0	0	0	0	1	0	002'h - 10.3 dB
0	0	0	0	0	0	0	1	1	003'h - 12.2 dB (BST_[2:0]=010)
0	0	0	0	0	0	1	1	1	007'h - 16.6 dB (BST_[2:0]=011)
0	0	0	0	1	0	1	0	1	015'h - 17 dB
0	0	0	0	0	1	0	1	1	00B'h - 19.2 dB
0	0	0	0	0	1	1	1	1	00F'h - 20.6 dB (BST_[2:0]=100)
0	0	1	0	1	0	1	0	1	055'h - 21.9 dB
0	0	0	0	1	1	1	1	1	01F'h - 24.8 dB (BST_[2:0]=101)
0	0	0	1	0	1	1	1	1	02F'h - 27.6 dB (BST_[2:0]=110)
0	0	0	1	1	1	1	1	1	03F'h - 28.9 dB (BST_[2:0]=111)
0	1	0	1	0	1	0	1	0	0AA'h - 31.3 dB
0	0	1	1	1	1	1	1	1	07F'h - 33.3 dB
0	1	0	1	1	1	1	1	1	0BF'h - 35.7 dB
0	1	1	1	1	1	1	1	1	0FF'h - 37 dB

## Applications Information

### GENERAL RECOMMENDATIONS

The DS100BR410 is a high performance circuit capable of delivering excellent performance up to 10.3125 Gbps. Careful attention must be paid to the details associated with high-speed design as well as providing a clean power supply. Refer to the LVDS Owner's Manual for more detailed information on high speed design tips to address signal integrity design issues.

### UNUSED CHANNEL

It is recommended to disable the unused channel (EN[3:0] = LOW). The power consumption of the device is reduced when the channel is disabled.

### PCB LAYOUT CONSIDERATIONS FOR DIFFERENTIAL PAIRS

The high speed CML inputs and outputs must have a controlled differential impedance of 100Ω. It is preferable to route differential lines exclusively on one layer of the board, particularly for the input traces. The use of vias should be avoided if possible. If vias must be used, they should be used sparingly and must be placed symmetrically for each side of a given differential pair. Route the differential signals away from other signals and noise sources on the printed circuit board. See [AN-1187 \(SNOA401\)](#) for additional information on WQFN packages.

Impedance discontinuities at the differential via can be minimized or eliminated by increasing the swell around each via hole. To further improve the signal quality, a ground via placed close to the signal via for a low inductance return current path is recommended. When the via structure is associated with stripline trace and a thick board, further optimization such as back drilling is often used to reduce the high frequency effects of via stubs on the signal path. To minimize cross-talk coupling, it is recommended to have >3X gap spacing between the differential pairs. For example, if the trace width is 5 mils with 5 mils spacing – 100Ω differential impedance (closely coupled). The gap spacing between the differential pairs should be >15 mils.

### **POWER SUPPLY BYPASSING**

Two approaches are recommended to ensure that the DS100BR410 is provided with an adequate power supply. First, the supply (VDD) and ground (GND) pins should be connected to power planes routed on adjacent layers of the printed circuit board. The layer thickness of the dielectric should be minimized so that the V<sub>DD</sub> and GND planes create a low inductance supply with distributed capacitance. Second, careful attention to supply bypassing through the proper use of bypass capacitors is required. A 0.1μF or 0.01 μF bypass capacitor should be connected to each V<sub>DD</sub> pin such that the capacitor is placed as close as possible to the DS100BR410. Smaller body size capacitors can help facilitate proper component placement. Additionally, three capacitors with capacitance in the range of 2.2 μF to 10 μF should be incorporated in the power supply bypassing design as well. These capacitors can be either tantalum or an ultra-low ESR ceramic.

Typical Performance Curves Characteristics

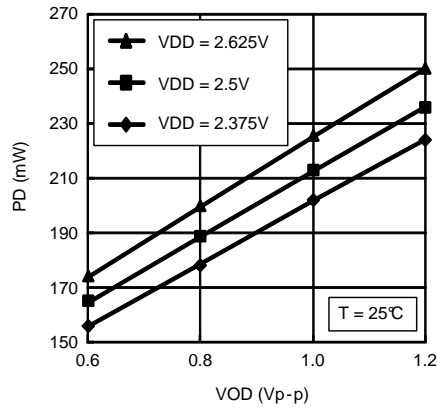

Figure 8. Power Dissipation (PD) vs. Output Differential Voltage (VOD)

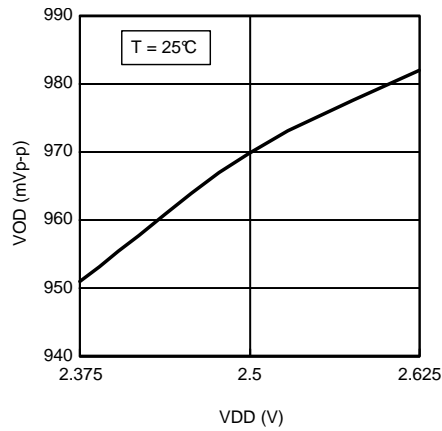

Figure 9. Output Differential Voltage (VOD = 1.0 Vp-p) vs. Supply Voltage (VDD)

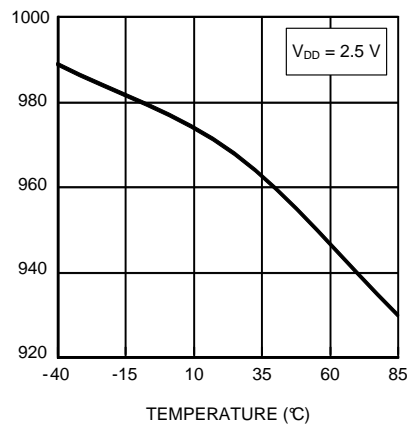

Figure 10. Output Differential Voltage (VOD = 1.0 Vp-p) vs. Temperature



### Typical Performance Eye Diagrams Characteristics

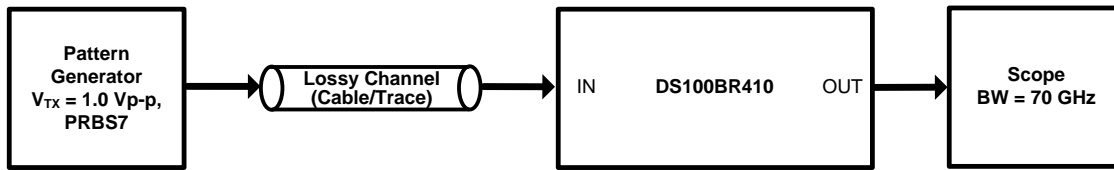

Figure 11. Test Setup Connections Diagram

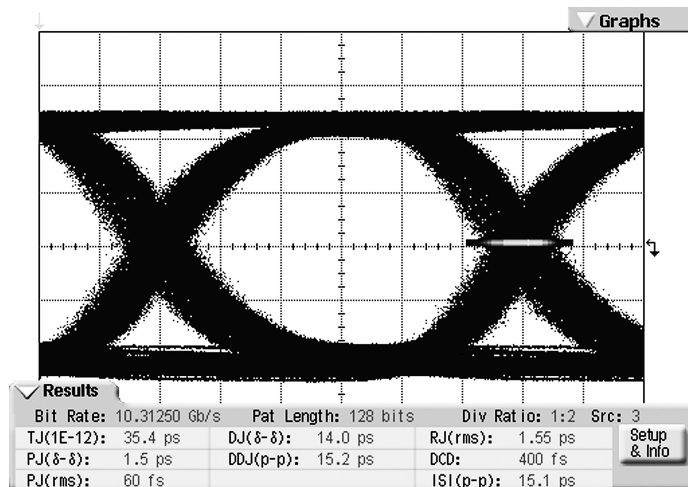

Figure 12. 12 meters, 30-AWG Cable at 10.3125 Gbps, BST[2:0] = 111, DE\_SEL = 0 dB

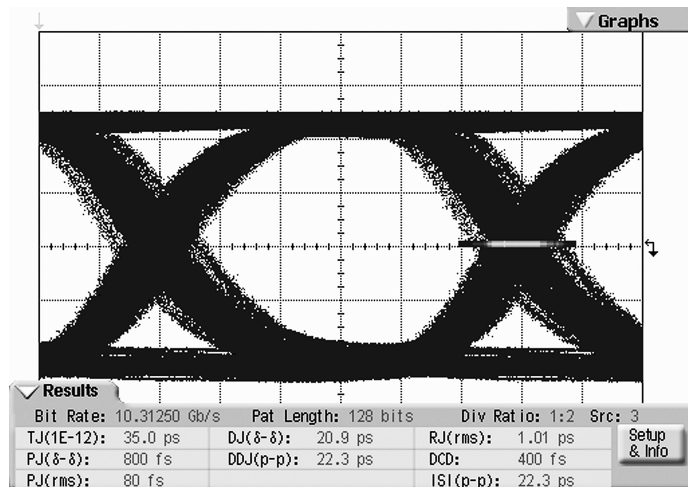

Figure 13. 40 inches, 6-mil FR4 Trace at 10.3125 Gbps, BST[2:0] = 101, DE\_SEL = 0 dB

### REVISION HISTORY

Changes from Revision A (April 2013) to Revision B	Page
• Changed layout of National Data Sheet to TI format .....	<a href="#">17</a>

**PACKAGING INFORMATION**

Orderable Device	Status (1)	Package Type	Package Drawing	Pins	Package Qty	Eco Plan (2)	Lead finish/ Ball material (6)	MSL Peak Temp (3)	Op Temp (°C)	Device Marking (4/5)	Samples
DS100BR410SQ/NOPB	ACTIVE	WQFN	RHS	48	1000	RoHS & Green	SN	Level-3-260C-168 HR	-40 to 85	100BR410	<a href="#">Samples</a>
DS100BR410SQE/NOPB	ACTIVE	WQFN	RHS	48	250	RoHS & Green	SN	Level-3-260C-168 HR	-40 to 85	100BR410	<a href="#">Samples</a>
DS100BR410SQX/NOPB	ACTIVE	WQFN	RHS	48	2500	RoHS & Green	SN	Level-3-260C-168 HR	-40 to 85	100BR410	<a href="#">Samples</a>

(1) The marketing status values are defined as follows:

**ACTIVE:** Product device recommended for new designs.

**LIFEBUY:** TI has announced that the device will be discontinued, and a lifetime-buy period is in effect.

**NRND:** Not recommended for new designs. Device is in production to support existing customers, but TI does not recommend using this part in a new design.

**PREVIEW:** Device has been announced but is not in production. Samples may or may not be available.

**OBSOLETE:** TI has discontinued the production of the device.

(2) **RoHS:** TI defines "RoHS" to mean semiconductor products that are compliant with the current EU RoHS requirements for all 10 RoHS substances, including the requirement that RoHS substance do not exceed 0.1% by weight in homogeneous materials. Where designed to be soldered at high temperatures, "RoHS" products are suitable for use in specified lead-free processes. TI may reference these types of products as "Pb-Free".

**RoHS Exempt:** TI defines "RoHS Exempt" to mean products that contain lead but are compliant with EU RoHS pursuant to a specific EU RoHS exemption.

**Green:** TI defines "Green" to mean the content of Chlorine (Cl) and Bromine (Br) based flame retardants meet JS709B low halogen requirements of <=1000ppm threshold. Antimony trioxide based flame retardants must also meet the <=1000ppm threshold requirement.

(3) MSL, Peak Temp. - The Moisture Sensitivity Level rating according to the JEDEC industry standard classifications, and peak solder temperature.

(4) There may be additional marking, which relates to the logo, the lot trace code information, or the environmental category on the device.

(5) Multiple Device Markings will be inside parentheses. Only one Device Marking contained in parentheses and separated by a "~" will appear on a device. If a line is indented then it is a continuation of the previous line and the two combined represent the entire Device Marking for that device.

(6) Lead finish/Ball material - Orderable Devices may have multiple material finish options. Finish options are separated by a vertical ruled line. Lead finish/Ball material values may wrap to two lines if the finish value exceeds the maximum column width.

**Important Information and Disclaimer:**The information provided on this page represents TI's knowledge and belief as of the date that it is provided. TI bases its knowledge and belief on information provided by third parties, and makes no representation or warranty as to the accuracy of such information. Efforts are underway to better integrate information from third parties. TI has taken and continues to take reasonable steps to provide representative and accurate information but may not have conducted destructive testing or chemical analysis on incoming materials and chemicals. TI and TI suppliers consider certain information to be proprietary, and thus CAS numbers and other limited information may not be available for release.

In no event shall TI's liability arising out of such information exceed the total purchase price of the TI part(s) at issue in this document sold by TI to Customer on an annual basis.

**TAPE AND REEL INFORMATION**

**QUADRANT ASSIGNMENTS FOR PIN 1 ORIENTATION IN TAPE**

\*All dimensions are nominal

Device	Package Type	Package Drawing	Pins	SPQ	Reel Diameter (mm)	Reel Width W1 (mm)	A0 (mm)	B0 (mm)	K0 (mm)	P1 (mm)	W (mm)	Pin1 Quadrant
DS100BR410SQ/NOPB	WQFN	RHS	48	1000	330.0	16.4	7.3	7.3	1.3	12.0	16.0	Q1
DS100BR410SQE/NOPB	WQFN	RHS	48	250	178.0	16.4	7.3	7.3	1.3	12.0	16.0	Q1
DS100BR410SQX/NOPB	WQFN	RHS	48	2500	330.0	16.4	7.3	7.3	1.3	12.0	16.0	Q1

**TAPE AND REEL BOX DIMENSIONS**

\*All dimensions are nominal

Device	Package Type	Package Drawing	Pins	SPQ	Length (mm)	Width (mm)	Height (mm)
DS100BR410SQ/NOPB	WQFN	RHS	48	1000	356.0	356.0	35.0
DS100BR410SQE/NOPB	WQFN	RHS	48	250	208.0	191.0	35.0
DS100BR410SQX/NOPB	WQFN	RHS	48	2500	356.0	356.0	35.0

## GENERIC PACKAGE VIEW

**RHS 48**

**WQFN - 0.8 mm max height**

7 x 7 mm, 0.5 mm pitch

PLASTIC QUAD FLATPACK - NO LEAD

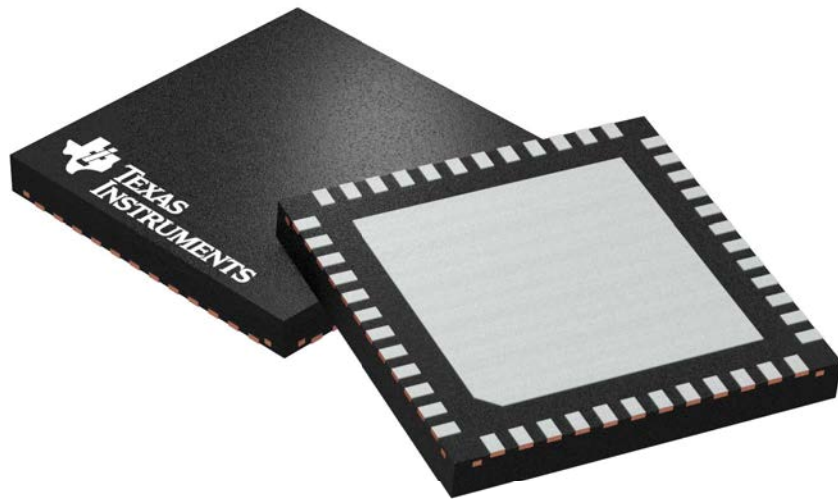

Images above are just a representation of the package family, actual package may vary.  
Refer to the product data sheet for package details.

4205855/C

## IMPORTANT NOTICE AND DISCLAIMER

TI PROVIDES TECHNICAL AND RELIABILITY DATA (INCLUDING DATA SHEETS), DESIGN RESOURCES (INCLUDING REFERENCE DESIGNS), APPLICATION OR OTHER DESIGN ADVICE, WEB TOOLS, SAFETY INFORMATION, AND OTHER RESOURCES "AS IS" AND WITH ALL FAULTS, AND DISCLAIMS ALL WARRANTIES, EXPRESS AND IMPLIED, INCLUDING WITHOUT LIMITATION ANY IMPLIED WARRANTIES OF MERCHANTABILITY, FITNESS FOR A PARTICULAR PURPOSE OR NON-INFRINGEMENT OF THIRD PARTY INTELLECTUAL PROPERTY RIGHTS.

These resources are intended for skilled developers designing with TI products. You are solely responsible for (1) selecting the appropriate TI products for your application, (2) designing, validating and testing your application, and (3) ensuring your application meets applicable standards, and any other safety, security, regulatory or other requirements.

These resources are subject to change without notice. TI grants you permission to use these resources only for development of an application that uses the TI products described in the resource. Other reproduction and display of these resources is prohibited. No license is granted to any other TI intellectual property right or to any third party intellectual property right. TI disclaims responsibility for, and you will fully indemnify TI and its representatives against, any claims, damages, costs, losses, and liabilities arising out of your use of these resources.

TI's products are provided subject to [TI's Terms of Sale](#) or other applicable terms available either on [ti.com](https://www.ti.com) or provided in conjunction with such TI products. TI's provision of these resources does not expand or otherwise alter TI's applicable warranties or warranty disclaimers for TI products.

TI objects to and rejects any additional or different terms you may have proposed.

Mailing Address: Texas Instruments, Post Office Box 655303, Dallas, Texas 75265  
Copyright © 2023, Texas Instruments Incorporated