

LP2957/LP2957A 5V Low-Dropout Regulator for μ P Applications

Check for Samples: [LP2957](#), [LP2957A](#)

FEATURES

- 5V Output within 1.4% Over Temperature (A Grade)
- Easily Programmed for Snap-On/Snap-Off Output
- Ensured 250 mA Output Current
- Extremely Low Quiescent Current
- Low Input-Output Voltage Required for Regulation
- Reverse Battery Protection
- Extremely Tight Line and Load Regulation
- Very Low Temperature Coefficient
- Current and Thermal Limiting
- Error Flag Signals when Output is out of Regulation

APPLICATIONS

- High-Efficiency Linear Regulator
- Battery-Powered Regulator

Package Outline

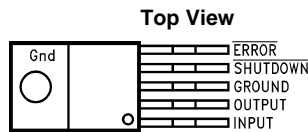

**Figure 1. Bent, Staggered Leads
5-Lead TO-220 Package
See Package Number NDH0005D**

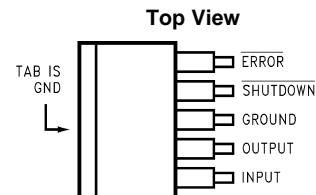

**Figure 2. Plastic Surface Mount Package
5-Lead DDPAK/TO-263 Package
See Package Number KTT0005B**

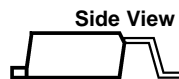

Figure 3. See Package Number KTT0005B



These devices have limited built-in ESD protection. The leads should be shorted together or the device placed in conductive foam during storage or handling to prevent electrostatic damage to the MOS gates.



Please be aware that an important notice concerning availability, standard warranty, and use in critical applications of Texas Instruments semiconductor products and disclaimers thereto appears at the end of this data sheet.

All trademarks are the property of their respective owners.

Absolute Maximum Ratings⁽¹⁾⁽²⁾

Operating Junction	Temperature Range	-40°C to +125°C
Storage Temperature Range		-65°C to +150°C
Lead Temperature (Soldering, 5 Seconds)		260°C
Power Dissipation ⁽³⁾		Internally Limited
Input Supply Voltage		-20V to +30V
Shutdown Input		-0.3V to +30V
ESD Rating		2 kV

- (1) Absolute maximum ratings indicate limits beyond which damage to the component may occur. Electrical specifications do not apply when operating the device outside of its rated operating conditions.
- (2) If Military/Aerospace specified devices are required, please contact the Texas Instruments Sales Office/Distributors for availability and specifications.
- (3) The maximum allowable power dissipation is a function of the maximum junction temperature, $T_{J(MAX)}$, the junction-to-ambient thermal resistance, θ_{JA} , and the ambient temperature, T_A . The maximum allowable power dissipation at any ambient temperature is calculated using: $P_{(MAX)} = \frac{T_{J(MAX)} - T_A}{\theta_{JA}}$ Exceeding the maximum allowable power dissipation will result in excessive die temperature, and the regulator will go into thermal shutdown. The junction-to-ambient thermal resistance of the TO-220 (without heatsink) is 60°C/W and 73°C/W for the DDPAK/TO-263. If the DDPAK/TO-263 package is used, the thermal resistance can be reduced by increasing the P.C. board copper area thermally connected to the package: Using 0.5 Square inches of copper area, θ_{JA} is 50°C/W, with 1 square inch of copper area, θ_{JA} is 37°C/W; and with 1.6 or more square inches of copper area, θ_{JA} is 32°C/W. The junction-to-case thermal resistance is 3°C/W. If an external heatsink is used, the effective junction-to-ambient thermal resistance is the sum of the junction-to-case resistance (3°C/W), the specified thermal resistance of the heatsink selected, and the thermal resistance of the interface between the heatsink and the LP2957 (see [Application Hints](#)).

Electrical Characteristics

Limits in standard typeface are for $T_J = 25^\circ\text{C}$, and limits in **boldface type** apply over the full operating temperature range. Unless otherwise specified: $V_{IN} = 6\text{V}$, $I_L = 1\text{ mA}$, $C_L = 2.2\ \mu\text{F}$, $V_{SD} = 3\text{V}$.

Symbol	Parameter	Conditions	Typical	LP2957AI		LP2957I		Units
				Min	Max	Min	Max	
V_O	Output Voltage ⁽¹⁾		5.0	4.975	5.025	4.950	5.050	V
		$1\text{ mA} \leq I_L \leq 250\text{ mA}$	5.0	4.930	5.070	4.880	5.120	
$\frac{\Delta V_O}{\Delta T}$	Output Voltage Temperature Coefficient	See ⁽²⁾	20		100		150	ppm/°C
$\frac{\Delta V_O}{V_O}$	Line Regulation	$V_{IN} = 6\text{V to } 30\text{V}$	0.03		0.10		0.20	%
					0.20		0.40	
$\frac{\Delta V_O}{V_O}$	Load Regulation	$I_L = 1\text{ mA to } 250\text{ mA}$	0.04		0.16		0.20	%
		$I_L = 0.1\text{ mA to } 1\text{ mA}^{(3)}$			0.20		0.30	
$V_{IN}-V_O$	Dropout Voltage ⁽⁴⁾	$I_L = 1\text{ mA}$	60		100		100	mV
		$I_L = 50\text{ mA}$	240		150		150	
		$I_L = 100\text{ mA}$	310		300		300	
		$I_L = 250\text{ mA}$	470		420		420	
					520		520	
					800		800	

- (1) When used in dual-supply systems where the regulator load is returned to a negative supply, the output voltage must be diode-clamped to ground.
- (2) Output voltage temperature coefficient is defined as the worst case voltage change divided by the total temperature range.
- (3) Regulation is measured at constant junction temperature using low duty cycle pulse testing. Parts are tested separately for load regulation in the load ranges 0.1 mA–1 mA and 1 mA–250 mA. Changes in output voltage due to heating effects are covered by the thermal regulation specification.
- (4) Dropout voltage is defined as the input to output voltage differential at which the output voltage drops 100 mV below the value measured with a 1V input to output differential.

Electrical Characteristics (continued)

Limits in standard typeface are for $T_J = 25^\circ\text{C}$, and limits in **boldface type** apply over the full operating temperature range. Unless otherwise specified: $V_{IN} = 6\text{V}$, $I_L = 1\text{ mA}$, $C_L = 2.2\ \mu\text{F}$, $V_{SD} = 3\text{V}$.

Symbol	Parameter	Conditions	Typical	LP2957AI		LP2957I		Units
				Min	Max	Min	Max	
I_{GND}	Ground Pin Current ⁽⁵⁾	$I_L = 1\text{ mA}$	150		200 230		200 230	μA
		$I_L = 50\text{ mA}$	1.1		2 2.5		2 2.5	mA
		$I_L = 100\text{ mA}$	3		6 8		6 8	
		$I_L = 250\text{ mA}$	16		28 33		28 33	
I_{GND}	Ground Pin Current in Shutdown ⁽⁵⁾	$I_L = 0$ $V_{SD} = 0.4\text{V}$	130		180 200		180 200	μA
I_{GND}	Ground Pin Current at Dropout ⁽⁵⁾	$V_{IN} = 4.5\text{V}$	180		230		230	μA
		$I_L = 0.1\text{ mA}$			250		250	
I_O (Sink)	Off-State Output Pulldown Current	$V_{IN} = 5.3\text{V}$ $V_O = 5\text{V}$, $V_{SD} = 0.4\text{V}$	50	30 20		30 20		mA
I_O (Off)	Output Leakage in Shutdown	$I_{\text{(SD IN)}} \geq 1\ \mu\text{A}$ $V_{IN} = 30\text{V}$, $V_{\text{OUT}} = 0\text{V}$	3		10 20		10 20	μA
I_{LIMIT}	Current Limit	$R_L = 1\ \Omega$	400		500 530		500 530	mA
$\frac{\Delta V_O}{\Delta P_d}$	Thermal Regulation	See ⁽⁶⁾	0.05		0.2		0.2	%/W
e_n	Output Noise Voltage (10 Hz to 100 kHz) $I_L = 100\text{ mA}$	$C_L = 2.2\ \mu\text{F}$	500					$\mu\text{V RMS}$
		$C_L = 33\ \mu\text{F}$	320					
SHUTDOWN INPUT								
V_{SD} (ON)	Output Turn-On Threshold Voltage			1.155 1.140	1.305 1.320	1.155 1.140	1.305 1.320	V
HYST	Hysteresis		6					mV
I_B	Input Bias Current	$V_{\text{IN(SD)}} = 0\text{V to }5\text{V}$	10	-30 -50	30 50	-30 -50	30 50	nA
DROPOUT DETECTION COMPARATOR								
I_{OH}	Output "HIGH" Leakage	$V_{\text{OH}} = 30\text{V}$	0.01		1 2		1 2	μA
V_{OL}	Output "LOW" Voltage	$V_{IN} = 4\text{V}$ $I_{\text{O(Comp)}} = 400\ \mu\text{A}$	150		250 400		250 400	mV
V_{THR} (Max)	Upper Threshold Voltage	See ⁽⁷⁾	-240	-320 -380	-150 -100	-320 -380	-150 -100	mV
V_{THR} (Min)	Lower Threshold Voltage	See ⁽⁷⁾	-350	-450 -640	-230 -160	-450 -640	-230 -160	mV
HYST	Hysteresis	See ⁽⁷⁾	60					mV

(5) Ground pin current is the regulator quiescent current. The total current drawn from the source is the sum of the load current plus the ground pin current.

(6) Thermal regulation is defined as the change in output voltage at a time T after a change in power dissipation is applied, excluding load or line regulation effects. Specifications are for a 200 mA load pulse at $V_{IN} = 20\text{V}$ (3W pulse) for $T = 10\text{ ms}$.

(7) Voltages are referenced to the nominal regulated output voltage.

Typical Performance Characteristics

Unless otherwise specified: $V_{IN} = 6V$, $I_L = 1\text{ mA}$, $C_L = 2.2\ \mu\text{F}$, $V_{SD} = 3V$, $T_A = 25^\circ\text{C}$

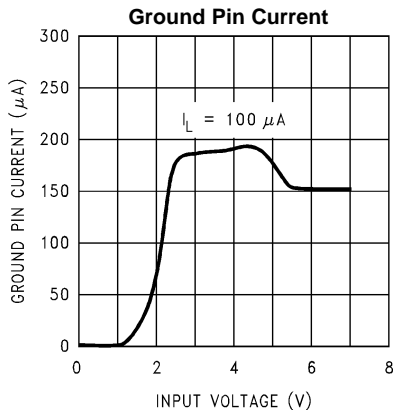

Figure 4.

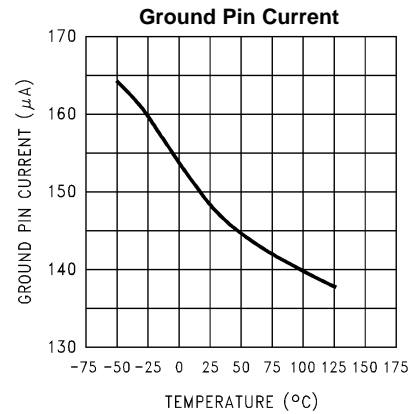

Figure 5.

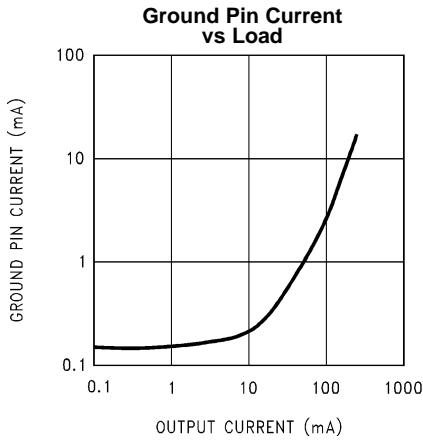

Figure 6.

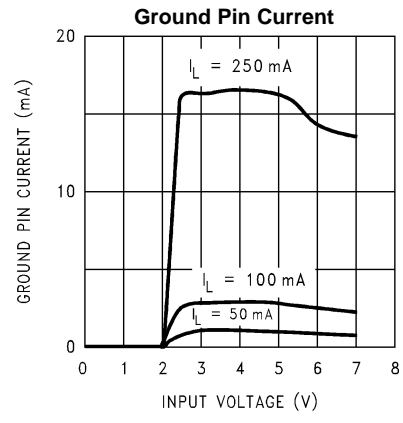

Figure 7.

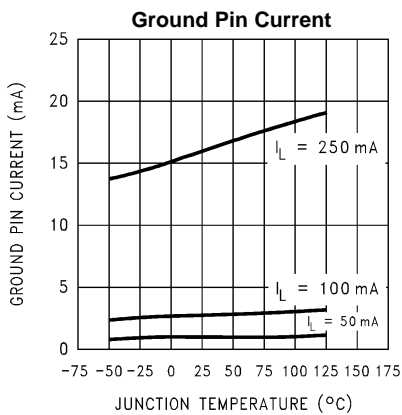

Figure 8.

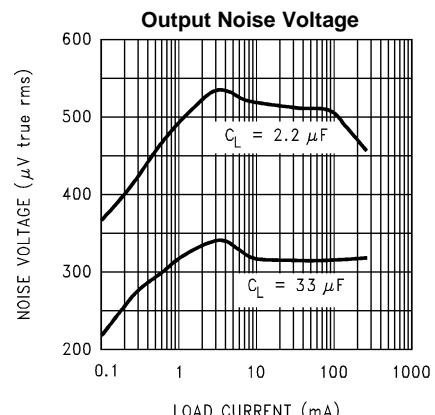

Figure 9.

Typical Performance Characteristics (continued)

Unless otherwise specified: $V_{IN} = 6V$, $I_L = 1\text{ mA}$, $C_L = 2.2\text{ }\mu\text{F}$, $V_{SD} = 3V$, $T_A = 25^\circ\text{C}$

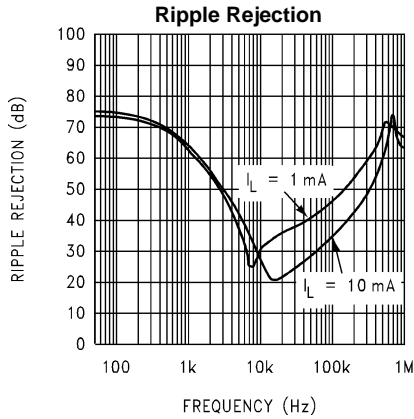

Figure 10.

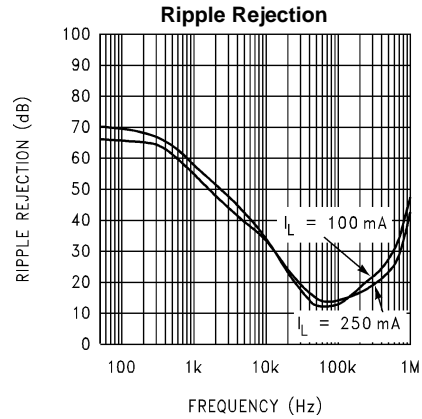

Figure 11.

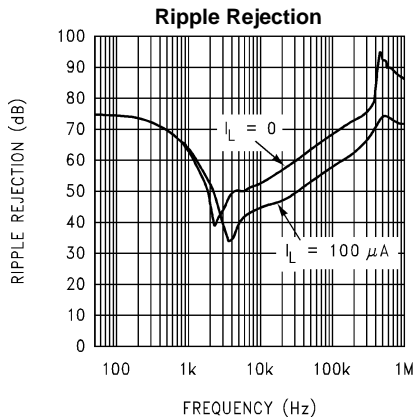

Figure 12.

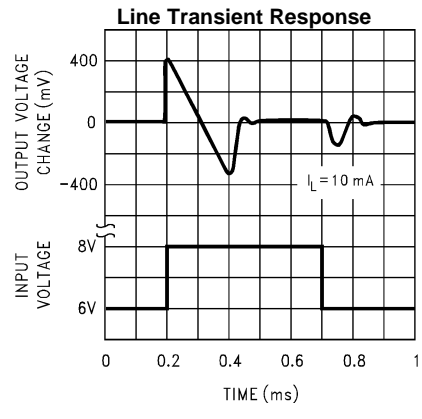

Figure 13.

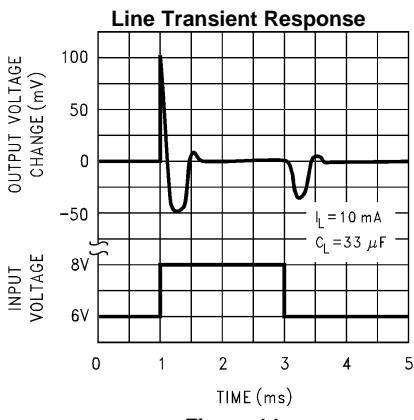

Figure 14.

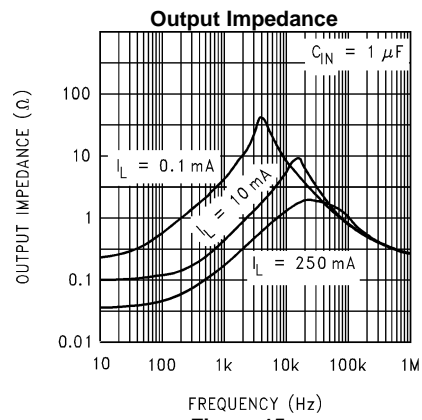

Figure 15.

Typical Performance Characteristics (continued)

Unless otherwise specified: $V_{IN} = 6V$, $I_L = 1\text{ mA}$, $C_L = 2.2\ \mu\text{F}$, $V_{SD} = 3V$, $T_A = 25^\circ\text{C}$

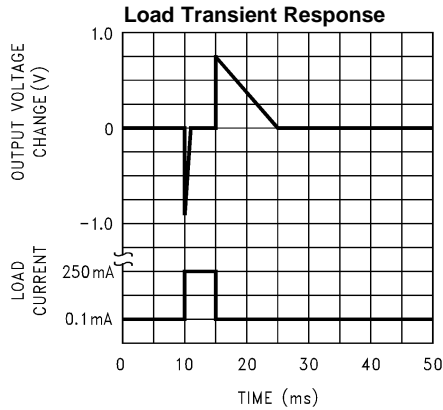

Figure 16.

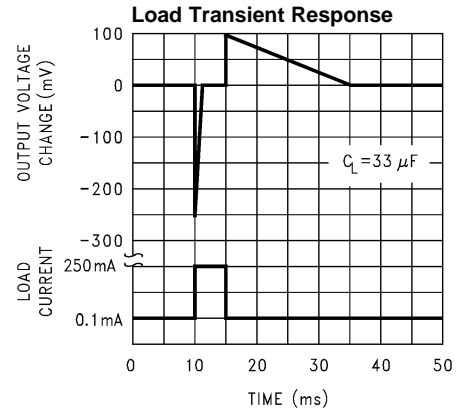

Figure 17.

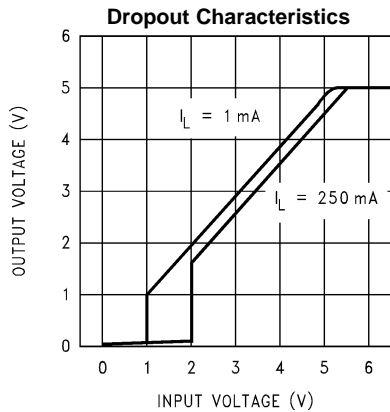

Figure 18.

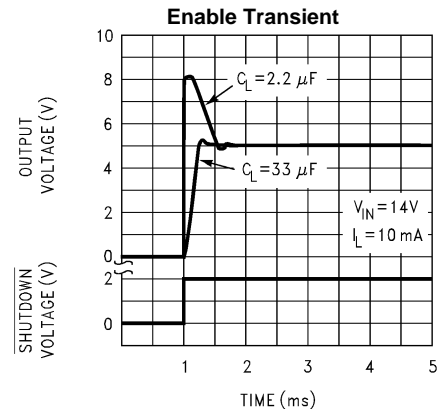

Figure 19.

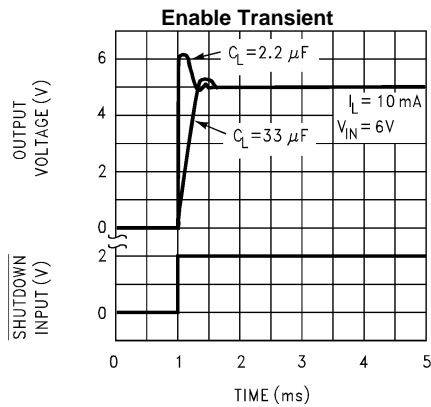

Figure 20.

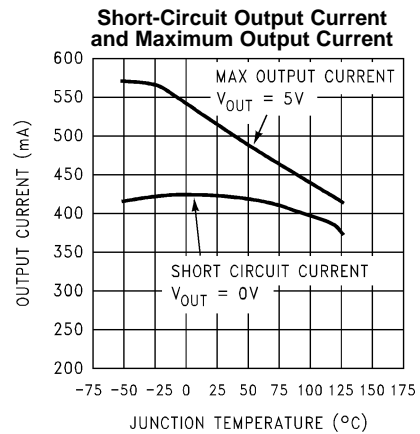

Figure 21.

Typical Performance Characteristics (continued)

Unless otherwise specified: $V_{IN} = 6V$, $I_L = 1\text{ mA}$, $C_L = 2.2\text{ }\mu\text{F}$, $V_{SD} = 3V$, $T_A = 25^\circ\text{C}$

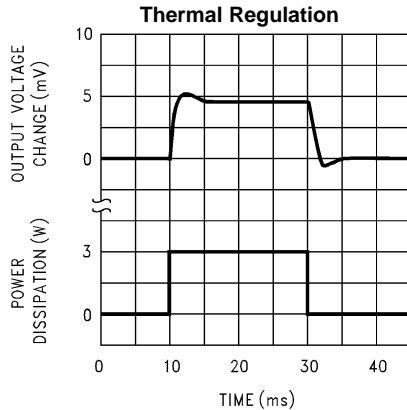

Figure 22.

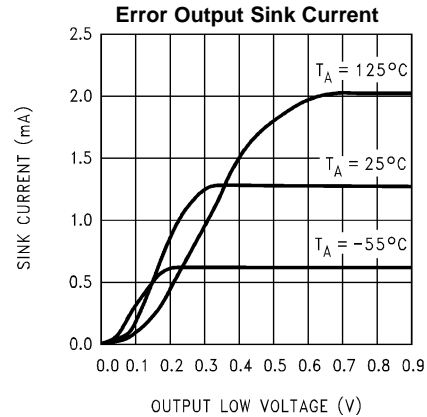

Figure 23.

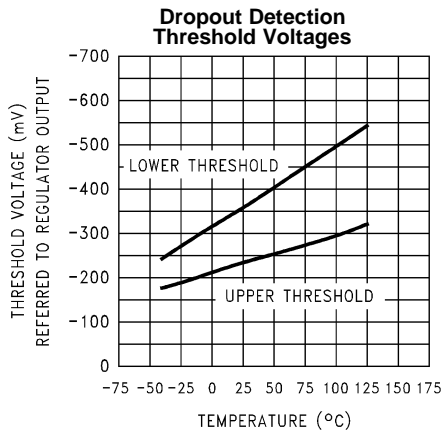

Figure 24.

Maximum Power Dissipation (DDPAK/TO-263)⁽¹⁾

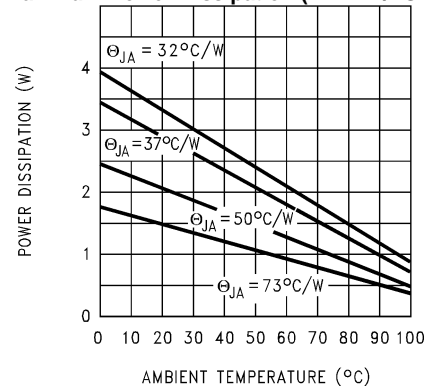

Figure 25.

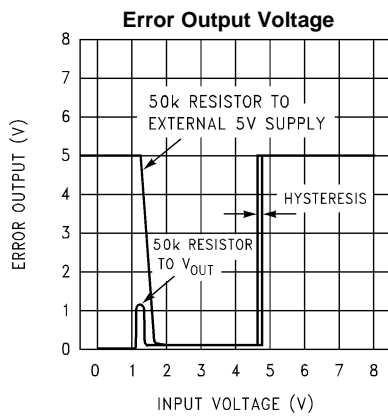

Figure 26.

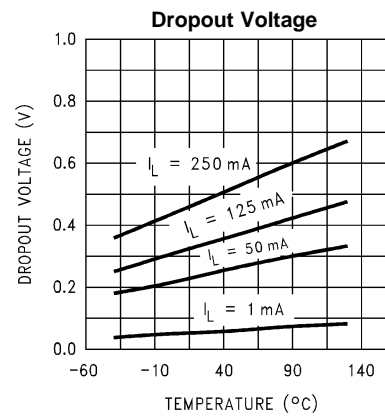

Figure 27.

- (1) The maximum allowable power dissipation is a function of the maximum junction temperature, $T_{J(\text{MAX})}$, the junction-to-ambient thermal resistance, θ_{JA} , and the ambient temperature, T_A . The maximum allowable power dissipation at any ambient temperature is calculated

$$P_{(\text{MAX})} = \frac{T_{J(\text{MAX})} - T_A}{\theta_{JA}}$$

using: Exceeding the maximum allowable power dissipation will result in excessive die temperature, and the regulator will go into thermal shutdown. The junction-to-ambient thermal resistance of the TO-220 (without heatsink) is 60°C/W and 73°C/W for the DDPAK/TO-263. If the DDPAK/TO-263 package is used, the thermal resistance can be reduced by increasing the P.C. board copper area thermally connected to the package: Using 0.5 Square inches of copper area, θ_{JA} is 50°C/W , with 1 square inch of copper area, θ_{JA} is 37°C/W ; and with 1.6 or more square inches of copper area, θ_{JA} is 32°C/W . The junction-to-case thermal resistance is 3°C/W . If an external heatsink is used, the effective junction-to-ambient thermal resistance is the sum of the junction-to-case resistance (3°C/W), the specified thermal resistance of the heatsink selected, and the thermal resistance of the interface between the heatsink and the LP2957 (see [Application Hints](#)).

Block Diagram

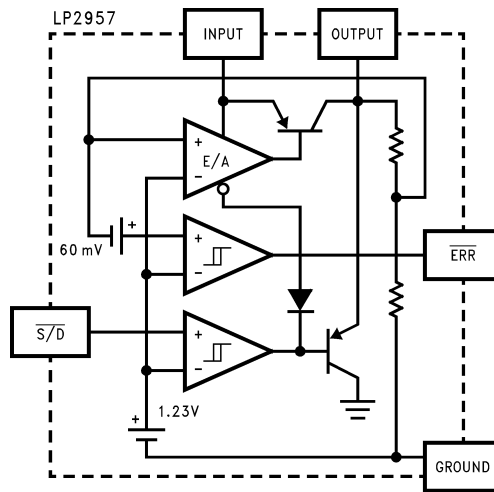

Typical Application Circuits

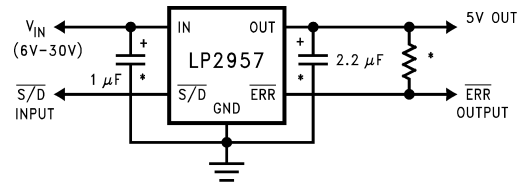
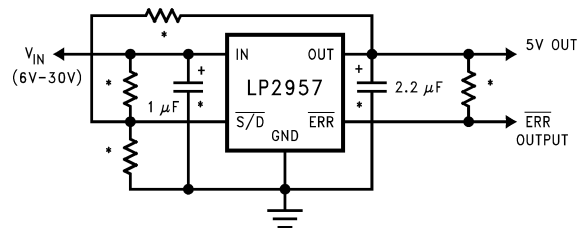

Figure 28. LP2957 Basic Application



*See [Application Hints](#)

Figure 29. LP2957 Application with Snap-On/Snap-Off Output

APPLICATION HINTS

EXTERNAL CAPACITORS

A 2.2 μF (or greater) capacitor is required between the output pin and ground to assure stability (refer to [Figure 30](#)). Without this capacitor, the part may oscillate. Most type of tantalum or aluminum electrolytics will work here. Film types will work, but are more expensive. Many aluminum electrolytics contain electrolytes which freeze at -30°C , which requires the use of solid tantalums below -25°C . The important parameters of the capacitor are an ESR of about 5Ω or less and a resonant frequency above 500 kHz (the ESR may increase by a factor of **20** or **30** as the temperature is reduced from 25°C to -30°C). The value of this capacitor may be increased without limit. At lower values of output current, less output capacitance is required for stability. The capacitor can be reduced to $0.68\ \mu\text{F}$ for currents below 10 mA or $0.22\ \mu\text{F}$ for currents below 1 mA.

A 1 μF capacitor should be placed from the input pin to ground if there is more than 10 inches of wire between the input and the AC filter capacitor or if a battery input is used. This **capacitor may have to be increased if the regulator is wired for snap-on/snap-off output and the source impedance is high** (see [Snap-On/Snap-Off Operation](#) section).

SHUTDOWN INPUT

A logic-level signal will shut off the regulator output when a “LOW” ($< 1.2\text{V}$) is applied to the Shutdown input.

To prevent possible mis-operation, the Shutdown input must be actively terminated. If the input is driven from open-collector logic, a pull-up resistor (20 k Ω to 100 k Ω recommended) must be connected from the Shutdown input to the regulator input.

If the Shutdown input is driven from a source that actively pulls high and low (like an op-amp), the pull-up resistor is not required, but may be used.

If the shutdown function is not to be used, the cost of the pull-up resistor can be saved by tying the Shutdown input directly to the regulator input.

IMPORTANT: Since the [Absolute Maximum Ratings](#) state that the Shutdown input can not go more than 0.3V below ground, the reverse-battery protection feature which protects the regulator input is sacrificed if the Shutdown input is tied directly to the regulator input.

If reverse-battery protection is required in an application, the pull-up resistor between the Shutdown input and the regulator input must be used.

MINIMUM LOAD

It should be noted that a minimum load current is specified in several of the electrical characteristic test conditions, so the value listed must be used to obtain correlation on these tested limits. The part is parametrically tested down to 100 μA , but is functional with no load.

DROPOUT VOLTAGE

The dropout voltage of the regulator is defined as the minimum input-to-output voltage differential required for the output voltage to stay within 100 mV of the output voltage measured with a 1V differential. The dropout voltages for various values of load current are listed under [Electrical Characteristics](#).

If the regulator is powered from a transformer connected to the AC line, the **minimum AC line voltage** and **maximum load current** must be used to measure the minimum voltage at the input of the regulator. The minimum input voltage is the lowest voltage level **including ripple on the filter capacitor**. It is also advisable to verify operation at **minimum operating ambient temperature**, since the increasing ESR of the filter capacitor makes this a worst-case test due to increased ripple amplitude.

HEATSINK REQUIREMENTS

A heatsink may be required with the LP2957 depending on the maximum power dissipation and maximum ambient temperature of the application. Under all possible operating conditions, the junction temperature must be within the range specified under [Absolute Maximum Ratings](#).

To determine if a heatsink is required, the maximum power dissipated by the regulator, P(max), must be calculated. It is important to remember that if the regulator is powered from a transformer connected to the AC line, the **maximum specified AC input voltage** must be used (since this produces the maximum DC input voltage to the regulator), and the **maximum load current** must also be used. [Figure 30](#) shows the voltages and currents which are present in the circuit. The formula for calculating the power dissipated in the regulator is also shown in [Figure 30](#).

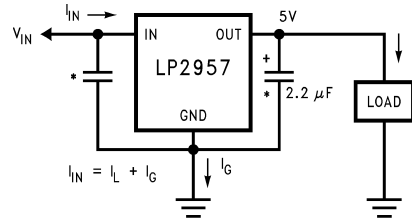

$$P_{TOTAL} = (V_{IN} - 5)V_L + (V_{IN})I_G$$

*See [EXTERNAL CAPACITORS](#)

Figure 30. Basic 5V Regulator Circuit

The next parameter which must be calculated is the maximum allowable temperature rise, T_R(Max). This is calculated by using the formula:

$$T_R(\text{Max}) = T_J(\text{Max}) - T_A(\text{Max})$$

where

- T_J(Max) is the maximum allowable junction temperature
- T_A(Max) is the maximum ambient temperature

Using the calculated values for T_R(Max) and P(Max), the required value for junction-to-ambient thermal resistance, θ_(JA), can now be found:

$$\theta_{(JA)} = T_R(\text{Max})/P(\text{Max})$$

If the calculated value is 60°C/W or higher, the regulator may be operated without an external heatsink. If the calculated value is below 60°C/W, an external heatsink is required. The required thermal resistance for this heatsink, θ_(HA), can be calculated using the formula:

$$\theta_{(HA)} = \theta_{(JA)} - \theta_{(JC)} - \theta_{(CH)}$$

where

- θ_(JC) is the junction-to-case thermal resistance, which is specified as 3°C/W for the LP2957
- θ_(CH) is the case-to-heatsink thermal resistance, which is dependent on the interfacing material (see [Table 1](#) and [Table 2](#))

Typical TO-220 Case-To-Heatsink

Thermal Resistance in °C/W

Table 1. (From AAVID)

Silicone Grease	1.0
Dry Interface	1.3
Mica with Grease	1.4

Table 2. (From Thermalloy)

Thermasil III	1.3
Thermasil II	1.5
Thermalfilm (0.002) with Grease	2.2

$\theta_{(HA)}$ is the heatsink-to-ambient thermal resistance. It is this specification (listed on the heatsink manufacturers data sheet) which defines the effectiveness of the heatsink. The heatsink selected must have a thermal resistance which is **equal to or lower** than the value of $\theta_{(HA)}$ calculated from the above listed formula.

ERROR COMPARATOR

This comparator produces a logic “LOW” whenever the output falls out of regulation by more than about 5%. This figure results from the comparator’s built-in offset of 60 mV divided by the 1.23V reference. An out-of-regulation condition can result from low input voltage, current limiting, or thermal limiting.

Figure 31 gives a timing diagram showing the relationship between the output voltage, the $\overline{\text{ERROR}}$ output, and input voltage as the input voltage is ramped up and down to the regulator **without snap-on/snap-off output**. The $\overline{\text{ERROR}}$ signal becomes low at about 1.3V input. It goes high at about 5V input, where the output equals 4.75V. Since the dropout voltage is load dependent, the **input** voltage trip points will vary with load current. The **output** voltage trip point does not vary.

The comparator has an open-collector output which requires an external pull-up resistor. This resistor may be connected to the regulator output or some other supply voltage. Using the regulator output prevents an invalid “HIGH” on the comparator output which occurs if it is pulled up to an external voltage while the regulator input voltage is reduced below 1.3V. In selecting a value for the pull-up resistor, note that while the output can sink 400 μA , this current adds to battery drain. Suggested values range from 100k to 1 M Ω . The resistor is not required if the output is unused.

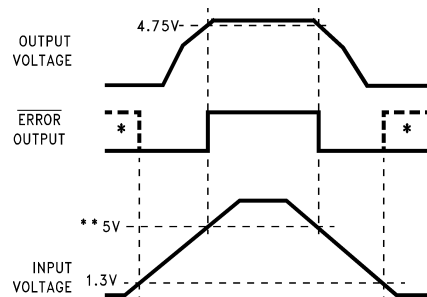

*In shutdown mode, $\overline{\text{ERROR}}$ will go high if it has been pulled up to an external supply. To avoid this invalid response, pull up to regulator output.

**Exact value depends on dropout voltage, which varies with load current.

Figure 31. $\overline{\text{ERROR}}$ Output Timing

If a single pull-up resistor is connected to the regulator output, the error flag may briefly rise up to about 1.3V as the input voltage ramps up or down through the 0V to 1.3V region.

In some cases, this 1.3V signal may be mis-interpreted as a false high by a μP which is still “alive” with 1.3V applied to it.

To prevent this, the user may elect to use **two** resistors which are equal in value on the error output (one connected to ground and the other connected to the regulator output).

If this two-resistor divider is used, the error output will only be pulled up to about 0.6V (not 1.3V) during power-up or power-down, so it can not be interpreted as a high signal. When the regulator output is in regulation (4.8V to 5V), the error output voltage will be 2.4V to 2.5V, which is clearly a high signal.

OUTPUT ISOLATION

The regulator output can be connected to an active voltage source (such as a battery) with the regulator input turned off, **as long as the regulator ground pin is connected to ground**. If the ground pin is left floating, **damage to the regulator can occur** if the output is pulled up by an external voltage source.

SNAP-ON/SNAP-OFF OPERATION

The LP2957 output can be wired for snap-on/snap-off operation using three external resistors:

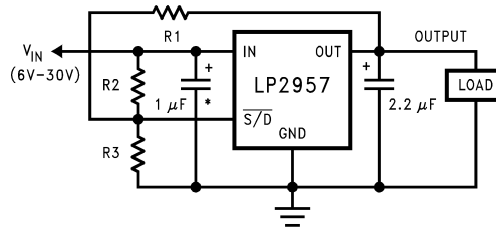

*Minimum value (increase as required for smooth turn-on characteristic).

Figure 32. Snap-On/Snap-Off Output

When connected as shown, the shutdown input holds the regulator off until the input voltage rises up to the turn-on threshold (V_{ON}), at which point the output “snaps on”.

When the input power is shut off (and the input voltage starts to decay) the output voltage will snap off when the input voltage reaches the turn-off threshold, V_{OFF} .

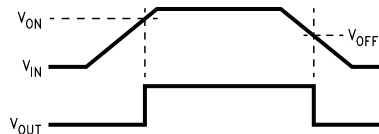

Figure 33. Snap-On/Snap-Off Input and Output Voltage Diagram

It is important to note that the voltage V_{OFF} must always be lower than V_{ON} (the difference in these voltage levels is called the hysteresis).

Hysteresis is **required** when using snap-on/snap-off output, with the minimum amount of hysteresis required for a specific application being dependent on the source impedance of whatever is supplying V_{IN} .

Caution: A type of **low-frequency oscillation** can occur if V_{ON} and V_{OFF} are too close together (**insufficient hysteresis**). When the output snaps on, the regulator must draw sufficient current to power the load and charge up the output capacitor (in most cases, the regulator will briefly draw the maximum current allowed by its internal limiter).

For this reason, it is best to assume the LP2957 may pull a peak current of about **600 mA** from the source (which is the listed maximum short-circuit load current of **530 mA** plus the ground pin current of **70 mA**).

This high peak current causes V_{IN} to drop by an amount equal to the source impedance multiplied by the current. If V_{IN} drops below V_{OFF} , the regulator will turn off and stop drawing current from the source. This will allow V_{IN} to rise back up above V_{ON} , and the cycle will start over. The regulator will stay in this oscillating mode and never come into regulation.

HYSTERESIS IN TRANSFORMER-POWERED

APPLICATIONS:

If the unregulated DC input voltage to the regulator comes from a transformer, the required hysteresis is easily measured by loading the source with a resistive load.

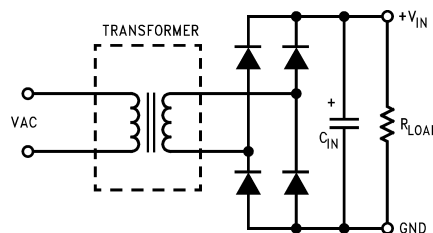

Figure 34. Transformer Powered Input Supply

If the regulator is powered from a battery, the source impedance will probably be low enough that other considerations will determine the optimum values for hysteresis (see Design Example #2).

For best results, the load resistance used to test the transformer should be selected to draw about **600 mA** for the maximum load current test, since this is the maximum peak current the LP2957 could be expected to draw from the source.

The difference in input voltage measured at no load and full load defines the amount of hysteresis required for proper snap-on/snap-off operation (the programmed hysteresis must be **greater** than the difference in voltages).

CALCULATING RESISTOR VALUES:

The values of R1, R2 and R3 can be calculated assuming the designer knows the hysteresis.

In most transformer-powered applications, it can be assumed that **V_{OFF}** (the input voltage at turn-off) **should be set for about 5.5V**, since this allows about 500 mV across the LP2957 to keep the output in regulation until it snaps off. **V_{ON}** (the input voltage at turn on) is found by **adding the hysteresis voltage to V_{OFF}**.

R1, R2 and R3 are found by solving the node equations for the currents entering the node nearest the shutdown pin (written at the turn-on and turn-off thresholds).

The shutdown pin bias current (10 nA typical) is not included in the calculations:

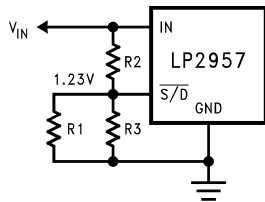

Figure 35. Turn-ON Transition - Equivalent Circuit

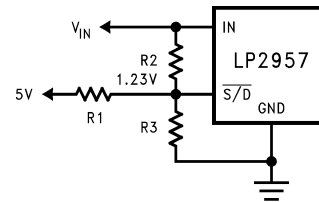

Figure 36. Turn-OFF Transition - Equivalent Circuits

$$\left(\frac{V_{ON} - 1.23}{R2} \right) = \frac{1.23}{R1} + \frac{1.23}{R3} \quad \text{(TURN-ON)}$$

$$\frac{V_{OFF} - 1.23}{R2} + \frac{5 - 1.23}{R1} = \frac{1.23}{R3} \quad \text{(TURN-OFF)}$$

(4)

Since these **two** equations contain **three** unknowns (R1, R2 and R3) one resistor value must be assumed and then the remaining two values can be obtained by solving the equations.

The node equations will be simplified by solving both equations for R2, and then equating the two to generate an expression in terms of R1 and R3.

$$R2 = \frac{(R1 \times R3) \times (V_{ON} - 1.23)}{1.23 \times (R1 + R3)} \quad \text{(TURN-ON)}$$

$$R2 = \frac{(R1 \times R3) \times (V_{OFF} - 1.23)}{(1.23R1 - 3.77R3)} \quad \text{(TURN-OFF)}$$

(5)

Setting these equal to each other and solving for R1 yields:

$$R1 = \frac{R3 \times (V_{OFF} + 3.07V_{ON} - 5)}{V_{ON} - V_{OFF}}$$

(6)

The same equation solved for R3 is:

$$R3 = \frac{R1 \times (V_{ON} - V_{OFF})}{V_{OFF} + 3.07V_{ON} - 5}$$

(7)

A value for R1 or R3 can be derived using either one of the above equations, if the designer assumes a value for one of the resistors.

The simplest approach is to assume a value for R3. Best results will typically be obtained using values between about **20 kΩ and 100 kΩ** (this keeps the current drain low, but also generates realistic values for the other resistors).

There is no limit on the **minimum value** of R3, but current should be minimized as it generates power that drains the source and does not power the load.

SUMMARY: TO SOLVE FOR R1, R2 AND R3:

1. Assume a value for either R1 or R3.
2. Solve for the other variable using the equation for R1 or R3.
3. Take the values for R1 and R3 and plug them back into **either** equation for R2 and solve for this value.

DESIGN EXAMPLE #1:

A 5V regulated output is to be powered from a transformer secondary which is rectified and filtered. The voltage V_{IN} is measured at zero current and maximum current (600 mA) to determine the minimum allowable hysteresis.

V_{IN} is measured using an oscilloscope (both traces are shown on the same grid for clarity):

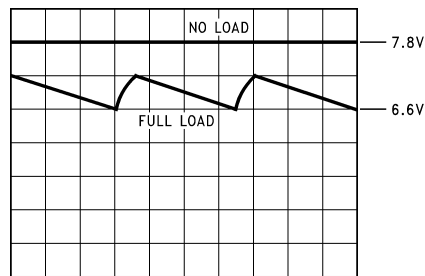

Figure 37. V_{IN} VOLTAGE WAVEFORMS

The full-load voltage waveform from a transformer-powered supply will have ripple voltage as shown. The correct point to measure is the **lowest** value of the waveform.

The 1.2V differential between no-load and full-load conditions means that **at least 1.2V** of hysteresis is required for proper snap-on/snap-off operation (for this example, **we will use 1.5V**).

As a starting point, we will assume:

$$V_{OFF} = 5.5V \quad V_{ON} = V_{OFF} + HYST = 5.5 + 1.5 = 7V \quad R3 = 49.9k$$

Solving for R1:

$$R1 = \frac{R3 \times (V_{OFF} + 3.07V_{ON} - 5)}{V_{ON} - V_{OFF}}$$

$$R1 = \frac{49.9k \times (5.5 + (3.07 \times 7) - 5)}{7 - 5.5}$$

$$R1 = 731k \text{ (standard size 732k)}$$

(8)

Solving for R2:

$$R2 = \frac{(R1 \times R3) \times V_{ON} - 1.23}{1.23 \times (R1 + R3)}$$

$$R2 = \frac{(732k \times 49.9k) \times (7 - 1.23)}{1.23 \times (732k + 49.9k)}$$

$$R2 = 219k \text{ (standard size 221k)}$$

(9)

DESIGN EXAMPLE #2:

A 5V regulated output is to be powered from a battery made up of six NiCad cells. The cell data is:

cell voltage (full charged): 1.4V

cell voltage (90% discharged): 1.0V

The internal impedance of a typical battery is low enough that source loading during regulator turn-on is not usually a problem.

In a battery-powered application, the turn-off voltage V_{OFF} should be selected so that the regulator is shut down when the batteries are about 90% discharged (over discharge can damage rechargeable batteries).

In this case, the battery voltage will be **6.0V** at the 90% discharge point (since there are six cells at 1.0V each). That means for this application, V_{OFF} will be set to 6.0V.

Selecting the optimum voltage for V_{ON} requires understanding battery behavior. If a Ni-Cad battery is nearly discharged (cell voltage 1.0V) **and the load is removed**, the cell voltage will drift back up. The voltage where the regulator turns on must be set high enough to keep the regulator from re-starting during this time, or an on-off pulsing mode can occur.

If the regulator restarts when the discharged cell voltage drifts up, the load on the battery will cause the cell voltage to fall below the turn-off level, which causes the regulator to shut down. The cell voltage will again float up and the on-off cycling will continue.

For NiCad batteries, a good cell voltage to use to calculate V_{ON} is about 1.2V per cell. In this application, this will yield a value for V_{ON} of 7.2V.

We can now find R1, R2 and R3 assuming:

$$V_{OFF} = 6.0V \quad V_{ON} = 7.2V \quad R3 = 49.9k$$

Solving for R1:

$$R1 = \frac{R3 \times (V_{OFF} + 3.07V_{ON} - 5)}{V_{ON} - V_{OFF}}$$

$$R1 = \frac{49.9k \times (6 + (3.07 \times 7.2) - 5)}{7.2 - 6}$$

$$\mathbf{R1 = 961k \text{ (standard size 953k)}} \quad (10)$$

Solving for R2:

$$R2 = \frac{(R1 \times R3) \times (V_{ON} - 1.23)}{1.23 \times (R1 + R3)}$$

$$R2 = \frac{(953k \times 49.9k) \times (7.2 - 1.23)}{1.23 \times (953k + 49.9k)}$$

$$\mathbf{R2 = 230k \text{ (standard size 232k)}} \quad (11)$$

Schematic Diagram

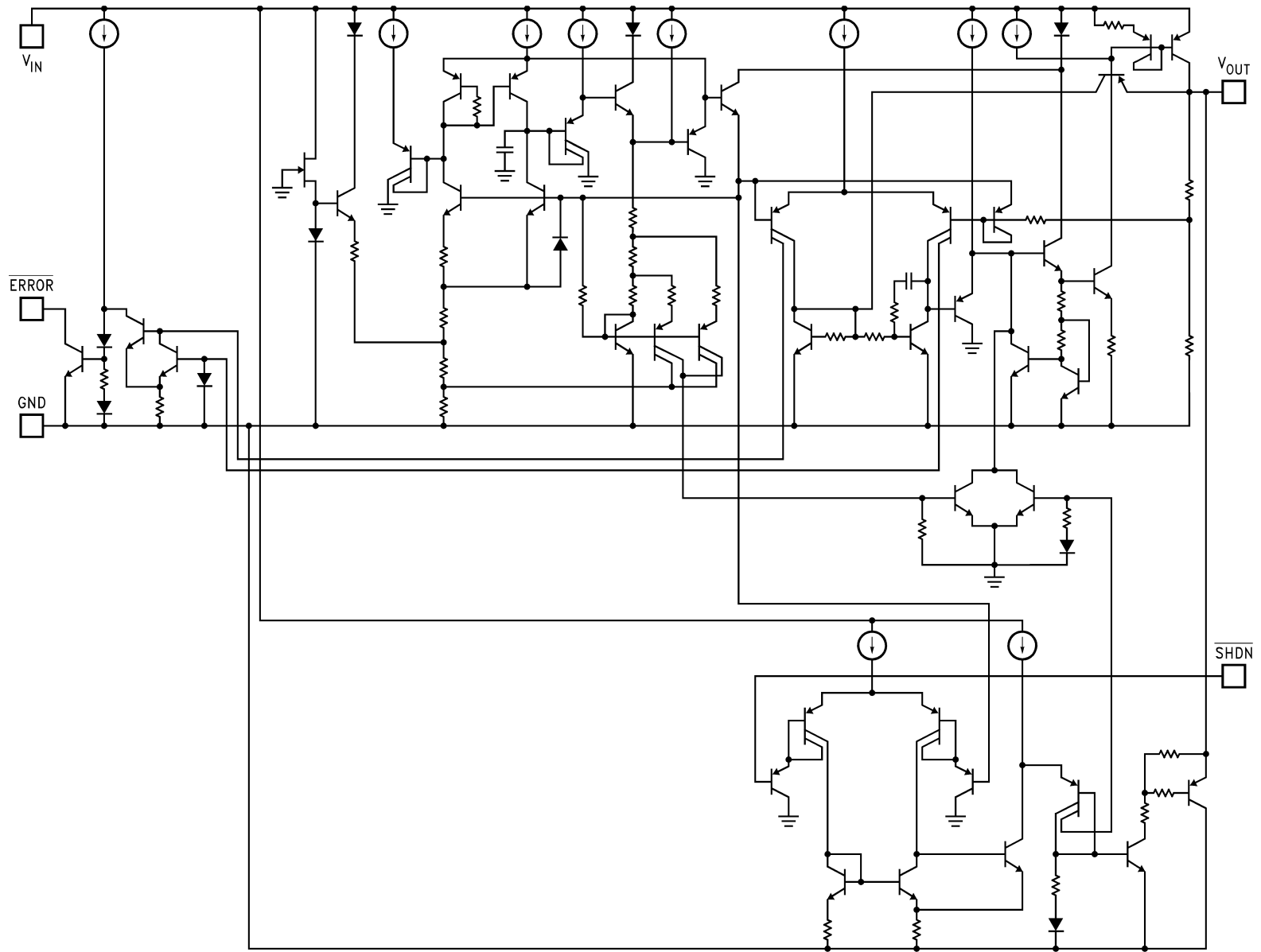

REVISION HISTORY

Changes from Revision B (April 2013) to Revision C	Page
<hr/> <ul style="list-style-type: none">• Changed layout of National Data Sheet to TI format	<hr/> 16

PACKAGING INFORMATION

Orderable Device	Status (1)	Package Type	Package Drawing	Pins	Package Qty	Eco Plan (2)	Lead finish/ Ball material (6)	MSL Peak Temp (3)	Op Temp (°C)	Device Marking (4/5)	Samples
LP2957AISX/NOPB	ACTIVE	DDPAK/ TO-263	KTT	5	500	RoHS-Exempt & Green	SN	Level-3-245C-168 HR	-40 to 125	LP2957AIS	Samples
LP2957AIT/NOPB	ACTIVE	TO-220	NDH	5	45	RoHS & Green	SN	Level-1-NA-UNLIM	-40 to 125	LP2957AIT	Samples
LP2957ISX/NOPB	ACTIVE	DDPAK/ TO-263	KTT	5	500	RoHS-Exempt & Green	SN	Level-3-245C-168 HR	-40 to 125	LP2957IS	Samples

(1) The marketing status values are defined as follows:

ACTIVE: Product device recommended for new designs.

LIFEBUY: TI has announced that the device will be discontinued, and a lifetime-buy period is in effect.

NRND: Not recommended for new designs. Device is in production to support existing customers, but TI does not recommend using this part in a new design.

PREVIEW: Device has been announced but is not in production. Samples may or may not be available.

OBSELETE: TI has discontinued the production of the device.

(2) **RoHS:** TI defines "RoHS" to mean semiconductor products that are compliant with the current EU RoHS requirements for all 10 RoHS substances, including the requirement that RoHS substance do not exceed 0.1% by weight in homogeneous materials. Where designed to be soldered at high temperatures, "RoHS" products are suitable for use in specified lead-free processes. TI may reference these types of products as "Pb-Free".

RoHS Exempt: TI defines "RoHS Exempt" to mean products that contain lead but are compliant with EU RoHS pursuant to a specific EU RoHS exemption.

Green: TI defines "Green" to mean the content of Chlorine (Cl) and Bromine (Br) based flame retardants meet JS709B low halogen requirements of <=1000ppm threshold. Antimony trioxide based flame retardants must also meet the <=1000ppm threshold requirement.

(3) MSL, Peak Temp. - The Moisture Sensitivity Level rating according to the JEDEC industry standard classifications, and peak solder temperature.

(4) There may be additional marking, which relates to the logo, the lot trace code information, or the environmental category on the device.

(5) Multiple Device Markings will be inside parentheses. Only one Device Marking contained in parentheses and separated by a "-" will appear on a device. If a line is indented then it is a continuation of the previous line and the two combined represent the entire Device Marking for that device.

(6) Lead finish/Ball material - Orderable Devices may have multiple material finish options. Finish options are separated by a vertical ruled line. Lead finish/Ball material values may wrap to two lines if the finish value exceeds the maximum column width.

Important Information and Disclaimer:The information provided on this page represents TI's knowledge and belief as of the date that it is provided. TI bases its knowledge and belief on information provided by third parties, and makes no representation or warranty as to the accuracy of such information. Efforts are underway to better integrate information from third parties. TI has taken and continues to take reasonable steps to provide representative and accurate information but may not have conducted destructive testing or chemical analysis on incoming materials and chemicals. TI and TI suppliers consider certain information to be proprietary, and thus CAS numbers and other limited information may not be available for release.

In no event shall TI's liability arising out of such information exceed the total purchase price of the TI part(s) at issue in this document sold by TI to Customer on an annual basis.

TAPE AND REEL INFORMATION

QUADRANT ASSIGNMENTS FOR PIN 1 ORIENTATION IN TAPE

*All dimensions are nominal

Device	Package Type	Package Drawing	Pins	SPQ	Reel Diameter (mm)	Reel Width W1 (mm)	A0 (mm)	B0 (mm)	K0 (mm)	P1 (mm)	W (mm)	Pin1 Quadrant
LP2957AISX/NOPB	DDPAK/TO-263	KTT	5	500	330.0	24.4	10.75	14.85	5.0	16.0	24.0	Q2
LP2957ISX/NOPB	DDPAK/TO-263	KTT	5	500	330.0	24.4	10.75	14.85	5.0	16.0	24.0	Q2

TAPE AND REEL BOX DIMENSIONS

*All dimensions are nominal

Device	Package Type	Package Drawing	Pins	SPQ	Length (mm)	Width (mm)	Height (mm)
LP2957AISX/NOPB	DDPAK/TO-263	KTT	5	500	367.0	367.0	45.0
LP2957ISX/NOPB	DDPAK/TO-263	KTT	5	500	367.0	367.0	45.0

TUBE

*All dimensions are nominal

Device	Package Name	Package Type	Pins	SPQ	L (mm)	W (mm)	T (μm)	B (mm)
LP2957AIT/NOPB	NDH	TO-220	5	45	502	30	30048.2	10.74

NDH0005D



T05D (REV A)

KTT0005B



TS5B (Rev D)

IMPORTANT NOTICE AND DISCLAIMER

TI PROVIDES TECHNICAL AND RELIABILITY DATA (INCLUDING DATA SHEETS), DESIGN RESOURCES (INCLUDING REFERENCE DESIGNS), APPLICATION OR OTHER DESIGN ADVICE, WEB TOOLS, SAFETY INFORMATION, AND OTHER RESOURCES "AS IS" AND WITH ALL FAULTS, AND DISCLAIMS ALL WARRANTIES, EXPRESS AND IMPLIED, INCLUDING WITHOUT LIMITATION ANY IMPLIED WARRANTIES OF MERCHANTABILITY, FITNESS FOR A PARTICULAR PURPOSE OR NON-INFRINGEMENT OF THIRD PARTY INTELLECTUAL PROPERTY RIGHTS.

These resources are intended for skilled developers designing with TI products. You are solely responsible for (1) selecting the appropriate TI products for your application, (2) designing, validating and testing your application, and (3) ensuring your application meets applicable standards, and any other safety, security, regulatory or other requirements.

These resources are subject to change without notice. TI grants you permission to use these resources only for development of an application that uses the TI products described in the resource. Other reproduction and display of these resources is prohibited. No license is granted to any other TI intellectual property right or to any third party intellectual property right. TI disclaims responsibility for, and you will fully indemnify TI and its representatives against, any claims, damages, costs, losses, and liabilities arising out of your use of these resources.

TI's products are provided subject to [TI's Terms of Sale](#) or other applicable terms available either on ti.com or provided in conjunction with such TI products. TI's provision of these resources does not expand or otherwise alter TI's applicable warranties or warranty disclaimers for TI products.

TI objects to and rejects any additional or different terms you may have proposed.

Mailing Address: Texas Instruments, Post Office Box 655303, Dallas, Texas 75265
Copyright © 2022, Texas Instruments Incorporated