

CSD25202W15 20V P 通道 NexFET™ 功率金属氧化物半导体场效应晶体管 (MOSFET)

1 特性

- 低电阻
- 小尺寸封装 1.5mm x 1.5mm
- 栅极静电放电 (ESD) 保护 - 3kV
- 无铅
- 符合 RoHS 环保标准
- 无卤素
- 栅 - 源电压钳位

2 应用范围

- 电池管理
- 电池保护

3 说明

这款 21mΩ, 20V 器件设计用于在超薄且具有出色散热特性的 1.5mm x 1.5mm 小外形封装内提供最低的导通电阻和栅极电荷。低导通电阻与小型封装尺寸和低高度结合在一起, 使得此器件非常适合于电池供电运行的空间受限应用。

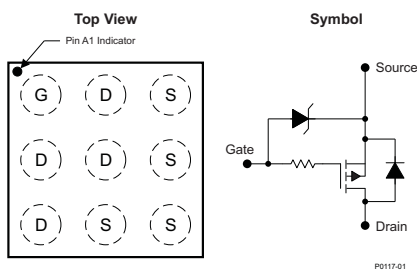

产品概要

T _A = 25°C		典型值		单位
V _{DS}	漏源电压	-20		V
Q _g	栅极电荷总量 (-4.5V)	5.8		nC
Q _{gd}	栅漏栅极电荷	0.8		nC
R _{DS(on)}	漏源导通电阻	V _{GS} = -1.8V	40	mΩ
		V _{GS} = -2.5V	26	mΩ
		V _{GS} = -4.5V	21	mΩ
V _{GS(th)}	阈值电压	-0.75		V

订购信息⁽¹⁾

器件	数量	介质	封装	出货
CSD25202W15	3000	7 英寸卷带	1.5mm x 1.5mm 晶圆级封装	卷带封装
CSD25202W15T	250	7 英寸卷带		

(1) 要了解所有可用封装, 请见数据表末尾的可订购产品附录。

最大绝对额定值

T _A = 25°C		值	单位
V _{DS}	漏源电压	-20	V
V _{GS}	栅源电压	-6	V
I _D	持续漏极电流 ⁽¹⁾	-4	A
	脉冲漏极电流 ⁽²⁾	-38	A
I _G	持续栅极电流 ⁽¹⁾	-0.5	A
	脉冲栅极电流 ⁽²⁾	-7	A
P _D	功率耗散	0.5	W
T _J , T _{stg}	运行结温 储存温度范围	-55 至 150	°C

(1) 焊球受限

(2) R_{θJA} = 220°C/W (典型值), 脉冲持续时间 ≤ 100μs, 占空比 ≤ 1%

R_{DS(on)} 与 V_{GS} 间的关系

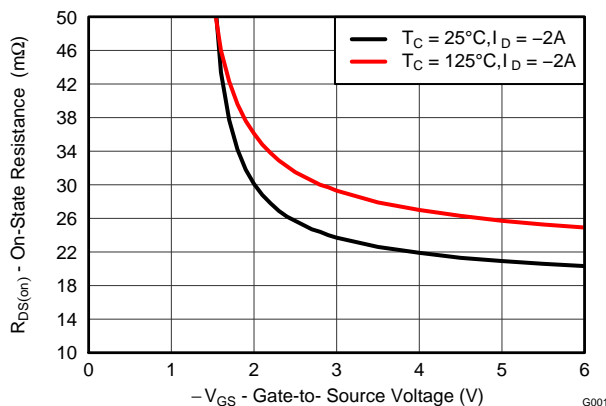

栅极电荷

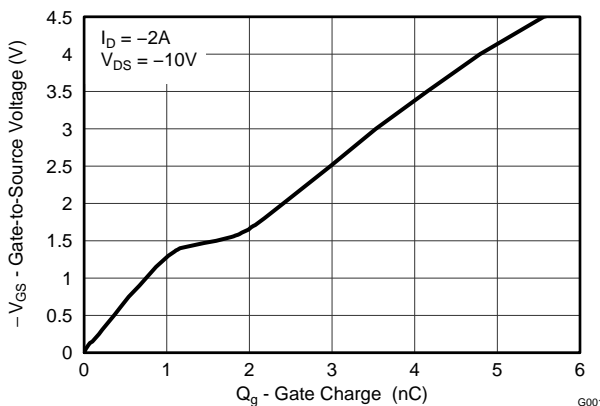

目录

1 特性 1 2 应用范围 1 3 说明 1 4 修订历史记录 2 5 Specifications 3 5.1 Electrical Characteristics 3 5.2 Thermal Information 3 5.3 Typical MOSFET Characteristics 4	6 器件和文档支持 7 6.1 商标 7 6.2 静电放电警告 7 6.3 术语表 7 7 机械封装和可订购信息 8 7.1 CSD25202W15 封装尺寸 8 7.2 建议焊盘图案 9 7.3 卷带信息 9
--	--

4 修订历史记录

Changes from Original (June 2014) to Revision A	Page
• “漏漏电压”已更正为“漏源电压”	1

5 Specifications

5.1 Electrical Characteristics

(T_A = 25°C unless otherwise stated)

PARAMETER		TEST CONDITIONS	MIN	TYP	MAX	UNIT
STATIC CHARACTERISTICS						
B _V DSS	Drain-to-Source Voltage	V _{GS} = 0 V, I _{DS} = -250 μA	-20			V
B _V GSS	Gate-to-Source Voltage	V _{DS} = 0 V, I _G = -250 μA	-6		-7.2	V
I _{DDS}	Drain-to-Source Leakage Current	V _{GS} = 0 V, V _{DS} = -16 V			-1	μA
I _{GSS}	Gate-to-Source Leakage Current	V _{DS} = 0 V, V _{GS} = -6 V			-100	nA
V _{GS(th)}	Gate-to-Source Threshold Voltage	V _{DS} = V _{GS} , I _{DS} = -250 μA	-0.45	-0.75	-1.05	V
R _{DS(on)}	Drain-to-Source On Resistance	V _{GS} = -1.8 V, I _{DS} = -2 A		40	52	mΩ
		V _{GS} = -2.5 V, I _{DS} = -2 A		26	32	mΩ
		V _{GS} = -4.5 V, I _{DS} = -2 A		21	26	mΩ
g _{fs}	Transconductance	V _{DS} = -2 V, I _{DS} = -2 A		16		S
DYNAMIC CHARACTERISTICS						
C _{ISS}	Input Capacitance	V _{GS} = 0 V, V _{DS} = -10 V, f = 1 MHz		778	1010	pF
C _{OSS}	Output Capacitance			400	520	pF
C _{RSS}	Reverse Transfer Capacitance			21	27	pF
R _G	Series Gate Resistance ⁽¹⁾			31		Ω
Q _g	Gate Charge Total (-4.5 V)	V _{DS} = -10 V, I _D = -2 A		5.8	7.5	nC
Q _{gd}	Gate Charge - Gate-to-Drain			0.8		nC
Q _{gs}	Gate Charge - Gate-to-Source			1.1		nC
Q _{g(th)}	Gate Charge at V _{th}			0.6		nC
Q _{OSS}	Output Charge	V _{DS} = -9.5 V, V _{GS} = 0 V		8.7		nC
t _{d(on)}	Turn On Delay Time ⁽²⁾	V _{DS} = -10 V, V _{GS} = -4.5 V, I _{DS} = -2 A, R _G = 2 Ω		15		ns
t _r	Rise Time ⁽²⁾			12		ns
t _{d(off)}	Turn Off Delay Time ⁽²⁾			64		ns
t _f	Fall Time ⁽²⁾			28		ns
DIODE CHARACTERISTICS						
V _{SD}	Diode Forward Voltage	I _{DS} = -2 A, V _{GS} = 0 V		-0.75	-1	V
Q _{rr}	Reverse Recovery Charge	V _{SD} = -10 V, I _F = -2 A, di/dt = 200 A/μs		19		nC
t _{rr}	Reverse Recovery Time				26	

(1) Includes gate clamp resistor

(2) External R_G is in addition to the internal gate clamp resistor

5.2 Thermal Information

(T_A = 25°C unless otherwise stated)

THERMAL METRIC		MIN	TYP	MAX	UNIT
R _{θJA}	Junction-to-Ambient Thermal Resistance ⁽¹⁾		220		°C/W
	Junction-to-Ambient Thermal Resistance ⁽²⁾		140		

(1) Device mounted on FR4 material with minimum Cu mounting area.

(2) Device mounted on FR4 material with 1-inch² (6.45-cm²), 2-oz. (0.071-mm thick) Cu.

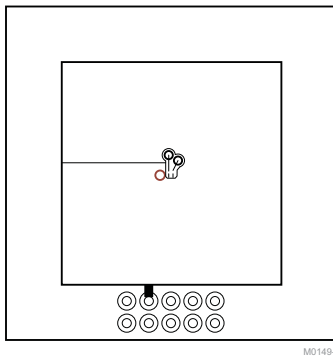

Typ $R_{\theta JA} = 140^{\circ}\text{C/W}$ when mounted on 1 inch² (6.45 cm²) of 2-oz. (0.071-mm thick) Cu.

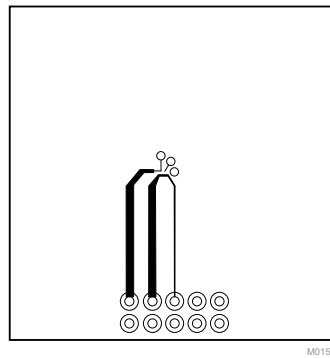

Typ $R_{\theta JA} = 220^{\circ}\text{C/W}$ when mounted on a minimum pad area of 2-oz. (0.071-mm thick) Cu.

5.3 Typical MOSFET Characteristics

($T_A = 25^{\circ}\text{C}$ unless otherwise stated)

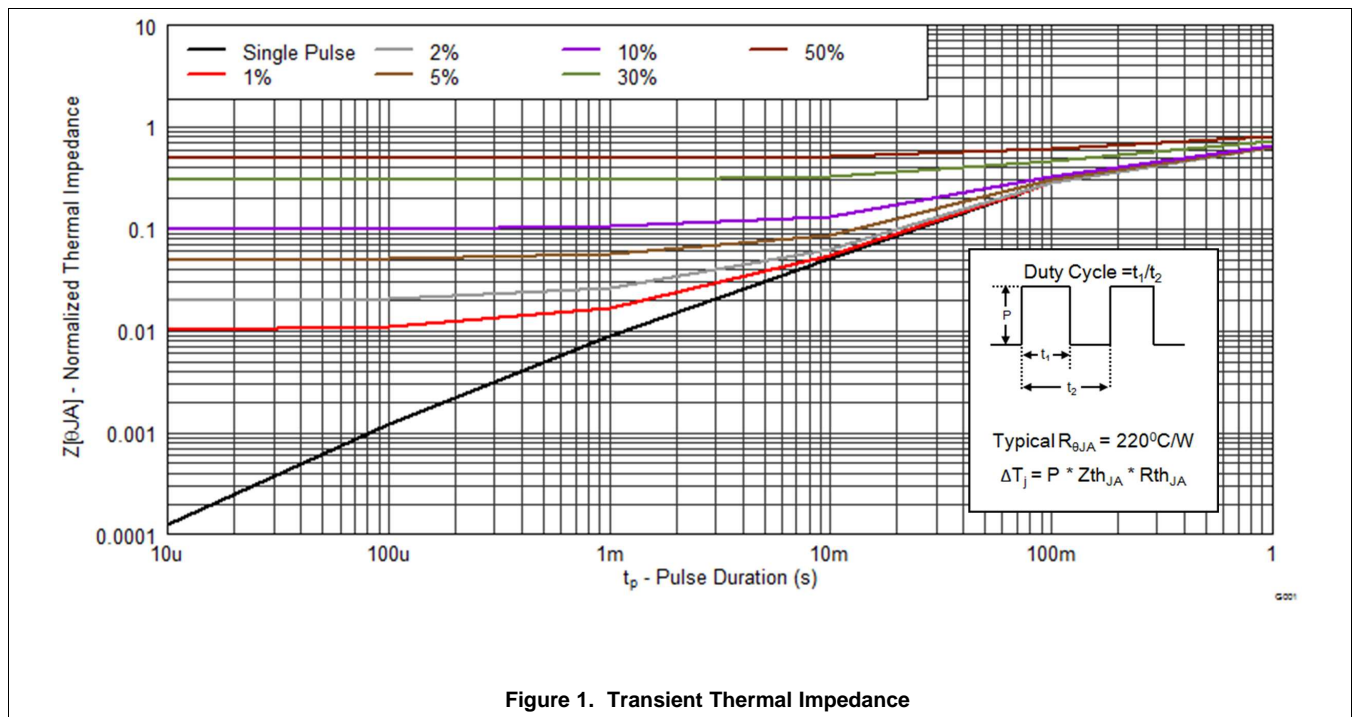

Figure 1. Transient Thermal Impedance

Typical MOSFET Characteristics (continued)

($T_A = 25^\circ\text{C}$ unless otherwise stated)

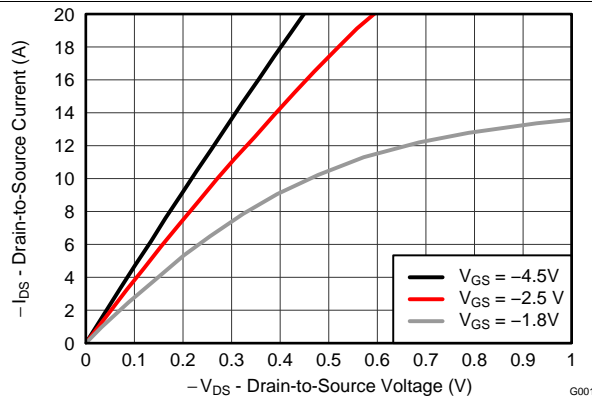

Figure 2. Saturation Characteristics

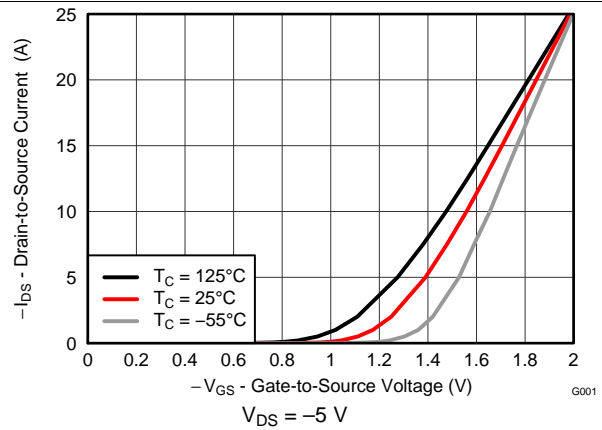

Figure 3. Transfer Characteristics

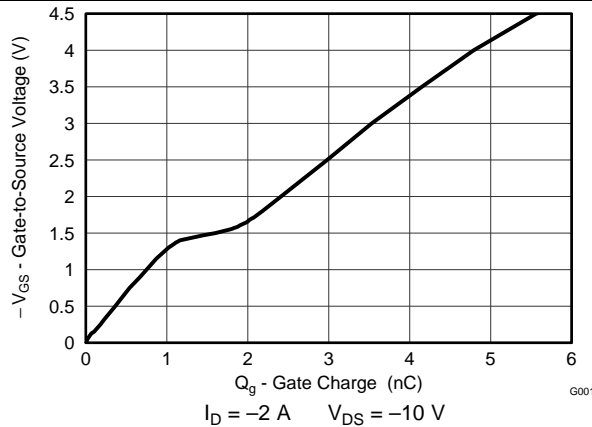

Figure 4. Gate Charge

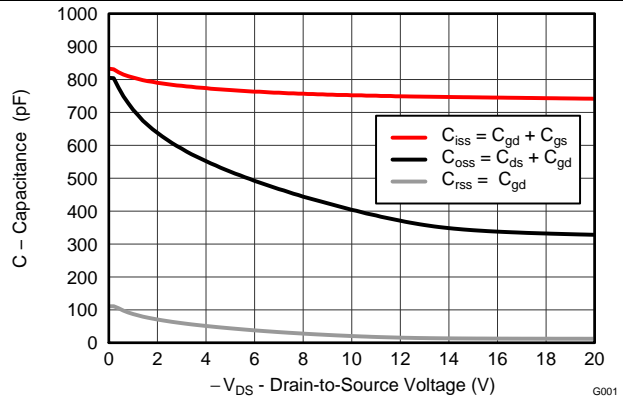

Figure 5. Capacitance

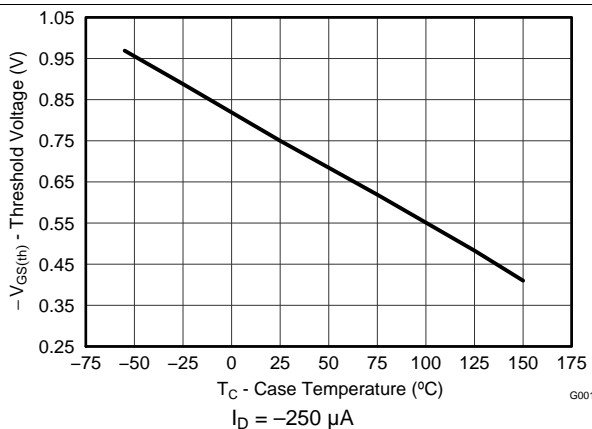

Figure 6. Threshold Voltage vs Temperature

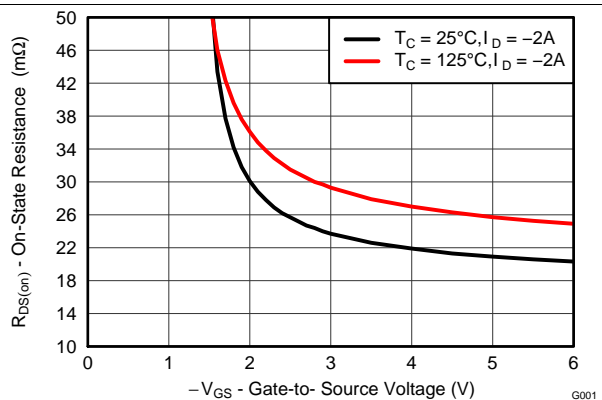

Figure 7. On-State Resistance vs Gate-to-Source Voltage

Typical MOSFET Characteristics (continued)

($T_A = 25^\circ\text{C}$ unless otherwise stated)

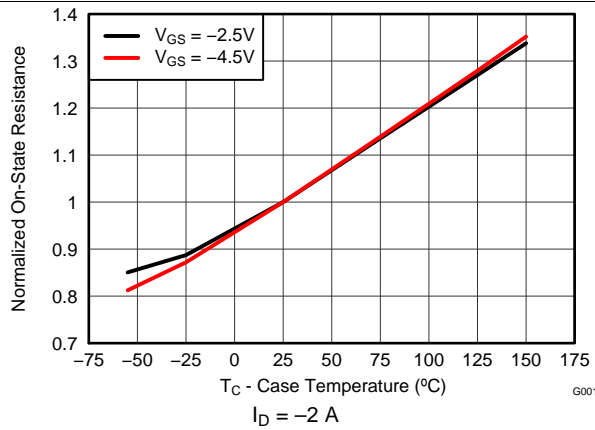

Figure 8. Normalized On-State Resistance vs Temperature

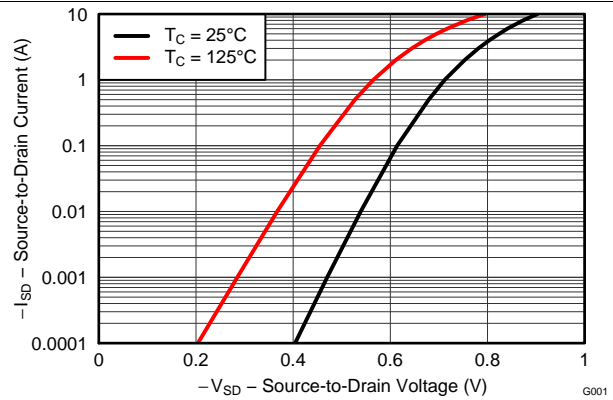

Figure 9. Typical Diode Forward Voltage

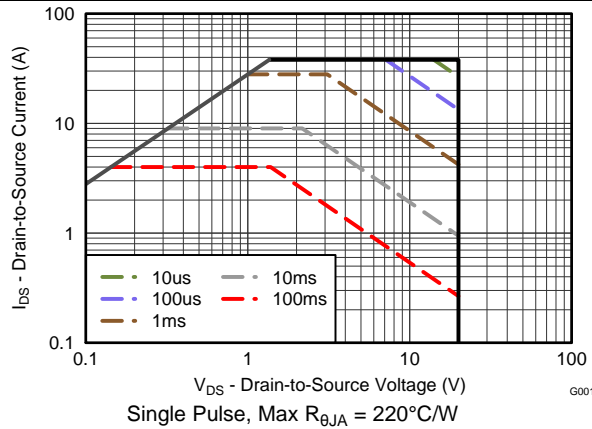

Figure 10. Maximum Safe Operating Area

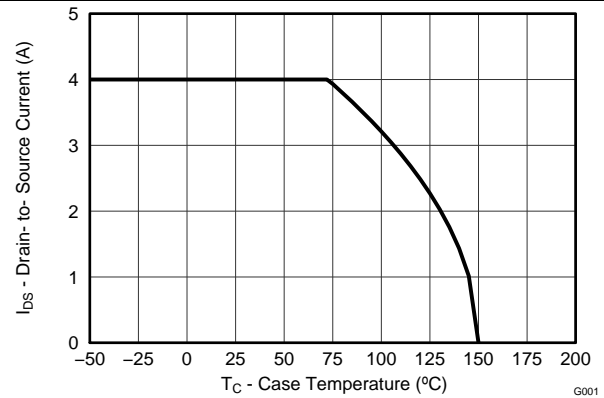

Figure 11. Maximum Drain Current vs Temperature

6 器件和文档支持

6.1 商标

NexFET is a trademark of Texas Instruments.
All other trademarks are the property of their respective owners.

6.2 静电放电警告



这些装置包含有限的内置 ESD 保护。存储或装卸时，应将导线一起截短或将装置放置于导电泡棉中，以防止 MOS 门极遭受静电损伤。

6.3 术语表

[SLYZ022](#) — *TI* 术语表。

这份术语表列出并解释术语、首字母缩略词和定义。

7 机械封装和可订购信息

以下页中包括机械封装和可订购信息。 这些信息是针对指定器件可提供的最新数据。 这些数据会在无通知且不对本文档进行修订的情况下发生改变。 欲获得该数据表的浏览器版本，请查阅左侧的导航栏。

7.1 CSD25202W15 封装尺寸

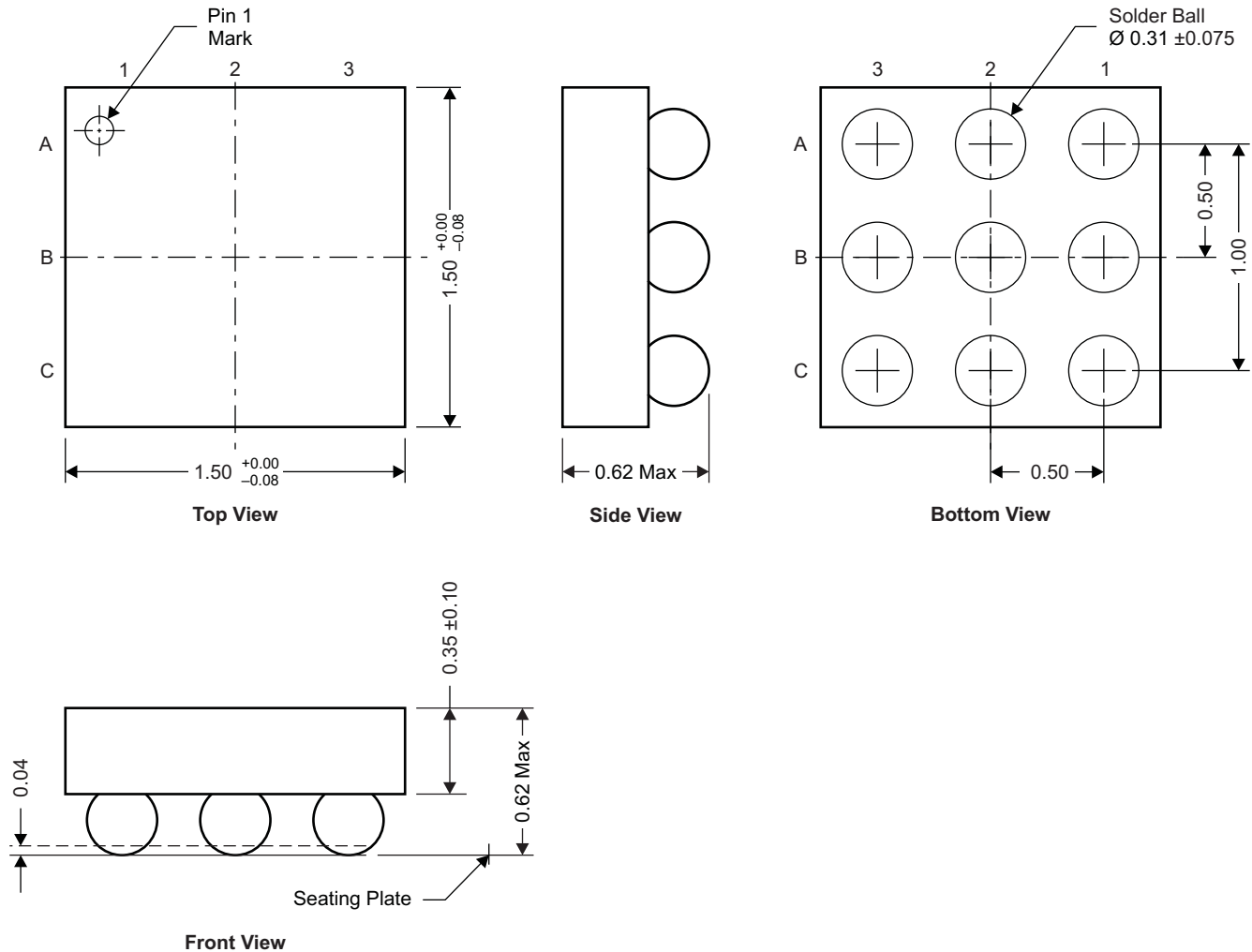

M0171-01

NOTE: 全部尺寸单位为 mm (除非另外注明)

引脚分配

位置	名称
A1	栅极
A2, B1, B2, C1	漏
A3, B3, C2, C3	源

7.2 建议焊盘图案

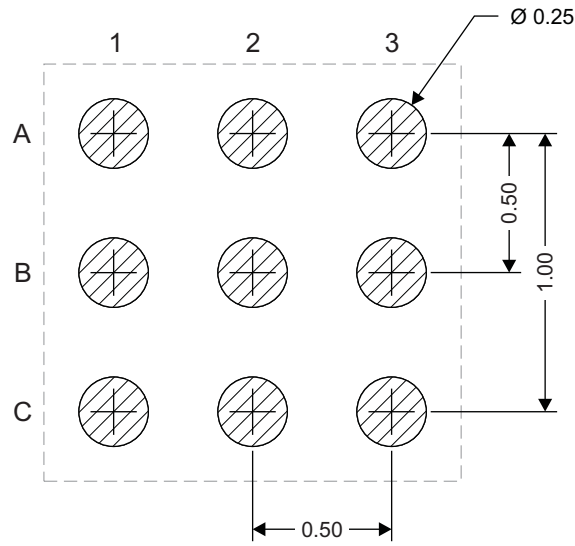

M0172-01

NOTE: 全部尺寸单位为 mm (除非另外注明)

7.3 卷带信息

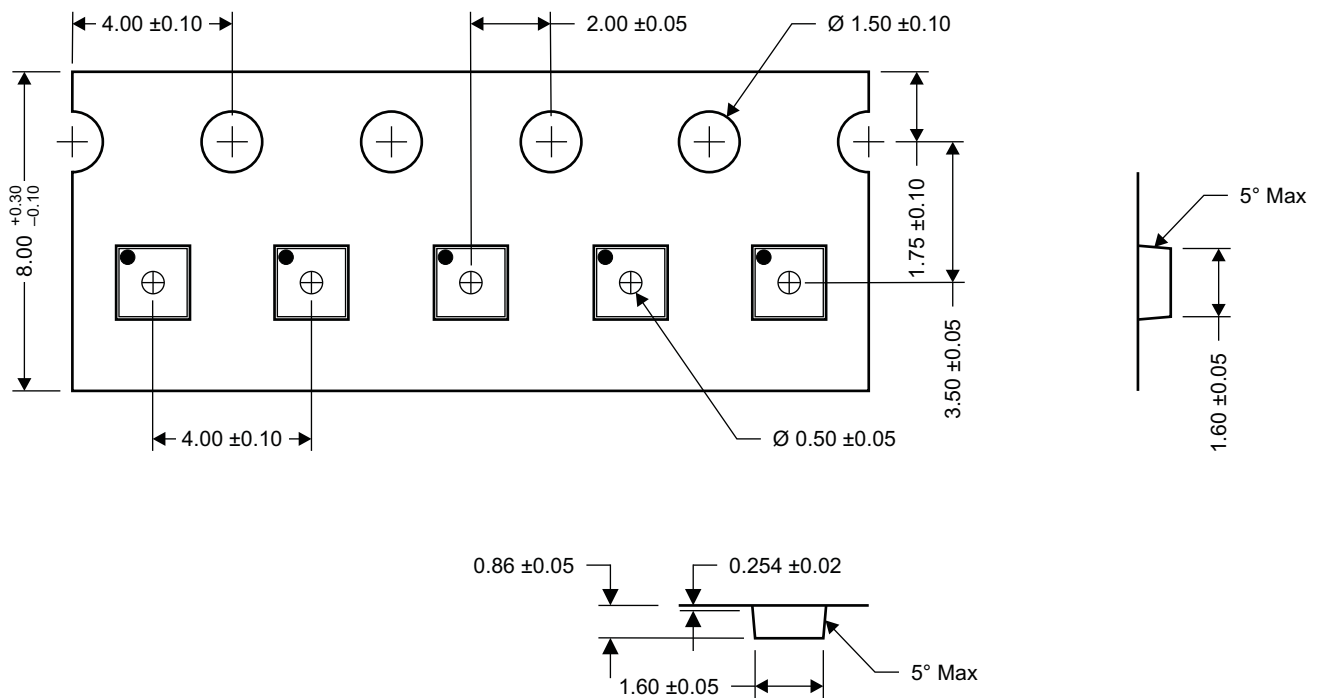

M0173-01

- NOTES: 1. 10 个链齿孔的累积容差为 ± 0.2
2. 每 100mm 长度的外倾角不能超过 1mm, 在 250mm 长度上不累积
3. 材料: 黑色抗静电聚苯乙烯
4. 全部尺寸单位为 mm (除非另外注明)
5. 厚度: 0.30 ± 0.05 mm
6. MSL1 260°C (红外 (IR) 和传导) PbF 回流焊兼容

PACKAGING INFORMATION

Orderable Device	Status (1)	Package Type	Package Drawing	Pins	Package Qty	Eco Plan (2)	Lead finish/ Ball material (6)	MSL Peak Temp (3)	Op Temp (°C)	Device Marking (4/5)	Samples
CSD25202W15	ACTIVE	DSBGA	YZF	9	3000	RoHS & Green	SNAGCU	Level-1-260C-UNLIM		25202	Samples
CSD25202W15T	ACTIVE	DSBGA	YZF	9	250	RoHS & Green	SNAGCU	Level-1-260C-UNLIM	-55 to 150	25202	Samples

(1) The marketing status values are defined as follows:

ACTIVE: Product device recommended for new designs.

LIFEBUY: TI has announced that the device will be discontinued, and a lifetime-buy period is in effect.

NRND: Not recommended for new designs. Device is in production to support existing customers, but TI does not recommend using this part in a new design.

PREVIEW: Device has been announced but is not in production. Samples may or may not be available.

OBSOLETE: TI has discontinued the production of the device.

(2) **RoHS:** TI defines "RoHS" to mean semiconductor products that are compliant with the current EU RoHS requirements for all 10 RoHS substances, including the requirement that RoHS substance do not exceed 0.1% by weight in homogeneous materials. Where designed to be soldered at high temperatures, "RoHS" products are suitable for use in specified lead-free processes. TI may reference these types of products as "Pb-Free".

RoHS Exempt: TI defines "RoHS Exempt" to mean products that contain lead but are compliant with EU RoHS pursuant to a specific EU RoHS exemption.

Green: TI defines "Green" to mean the content of Chlorine (Cl) and Bromine (Br) based flame retardants meet JS709B low halogen requirements of <=1000ppm threshold. Antimony trioxide based flame retardants must also meet the <=1000ppm threshold requirement.

(3) MSL, Peak Temp. - The Moisture Sensitivity Level rating according to the JEDEC industry standard classifications, and peak solder temperature.

(4) There may be additional marking, which relates to the logo, the lot trace code information, or the environmental category on the device.

(5) Multiple Device Markings will be inside parentheses. Only one Device Marking contained in parentheses and separated by a "~" will appear on a device. If a line is indented then it is a continuation of the previous line and the two combined represent the entire Device Marking for that device.

(6) Lead finish/Ball material - Orderable Devices may have multiple material finish options. Finish options are separated by a vertical ruled line. Lead finish/Ball material values may wrap to two lines if the finish value exceeds the maximum column width.

Important Information and Disclaimer:The information provided on this page represents TI's knowledge and belief as of the date that it is provided. TI bases its knowledge and belief on information provided by third parties, and makes no representation or warranty as to the accuracy of such information. Efforts are underway to better integrate information from third parties. TI has taken and continues to take reasonable steps to provide representative and accurate information but may not have conducted destructive testing or chemical analysis on incoming materials and chemicals. TI and TI suppliers consider certain information to be proprietary, and thus CAS numbers and other limited information may not be available for release.

In no event shall TI's liability arising out of such information exceed the total purchase price of the TI part(s) at issue in this document sold by TI to Customer on an annual basis.

TAPE AND REEL INFORMATION

QUADRANT ASSIGNMENTS FOR PIN 1 ORIENTATION IN TAPE

*All dimensions are nominal

Device	Package Type	Package Drawing	Pins	SPQ	Reel Diameter (mm)	Reel Width W1 (mm)	A0 (mm)	B0 (mm)	K0 (mm)	P1 (mm)	W (mm)	Pin1 Quadrant
CSD25202W15	DSBGA	YZF	9	3000	180.0	9.0	1.69	1.69	0.69	4.0	8.0	Q1
CSD25202W15	DSBGA	YZF	9	3000	179.0	14.4	1.6	1.6	0.86	4.0	8.0	Q1
CSD25202W15T	DSBGA	YZF	9	250	180.0	9.0	1.69	1.69	0.69	4.0	8.0	Q1
CSD25202W15T	DSBGA	YZF	9	250	179.0	14.4	1.6	1.6	0.86	4.0	8.0	Q1

TAPE AND REEL BOX DIMENSIONS

*All dimensions are nominal

Device	Package Type	Package Drawing	Pins	SPQ	Length (mm)	Width (mm)	Height (mm)
CSD25202W15	DSBGA	YZF	9	3000	195.0	210.0	39.0
CSD25202W15	DSBGA	YZF	9	3000	199.0	211.0	35.0
CSD25202W15T	DSBGA	YZF	9	250	195.0	210.0	39.0
CSD25202W15T	DSBGA	YZF	9	250	199.0	211.0	35.0

YZF0009

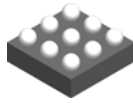

PACKAGE OUTLINE

DSBGA - 0.625 mm max height

DIE SIZE BALL GRID ARRAY

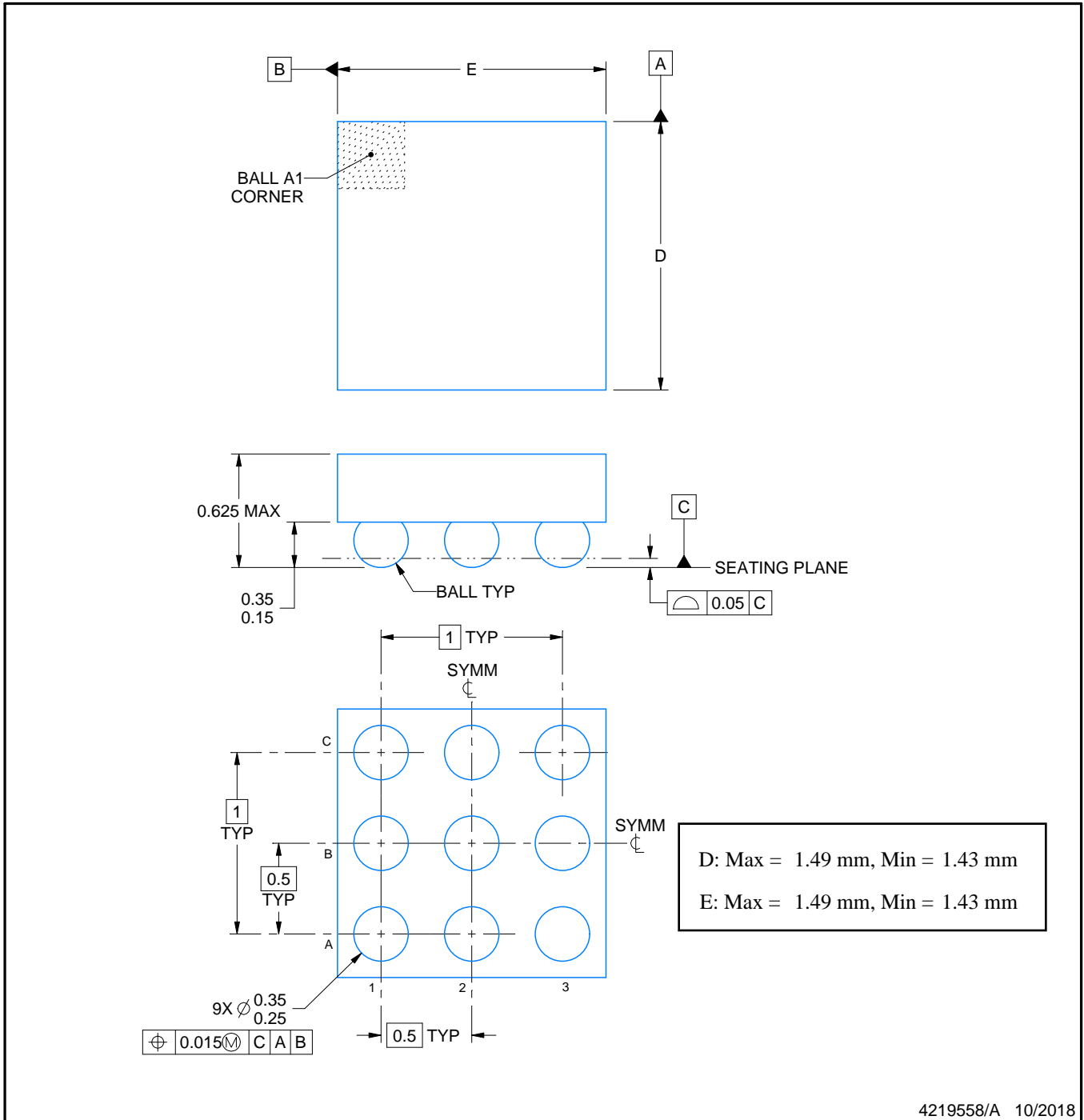

NOTES:

- 1. All linear dimensions are in millimeters. Any dimensions in parenthesis are for reference only. Dimensioning and tolerancing per ASME Y14.5M.
- 2. This drawing is subject to change without notice.

EXAMPLE BOARD LAYOUT

YZF0009

DSBGA - 0.625 mm max height

DIE SIZE BALL GRID ARRAY

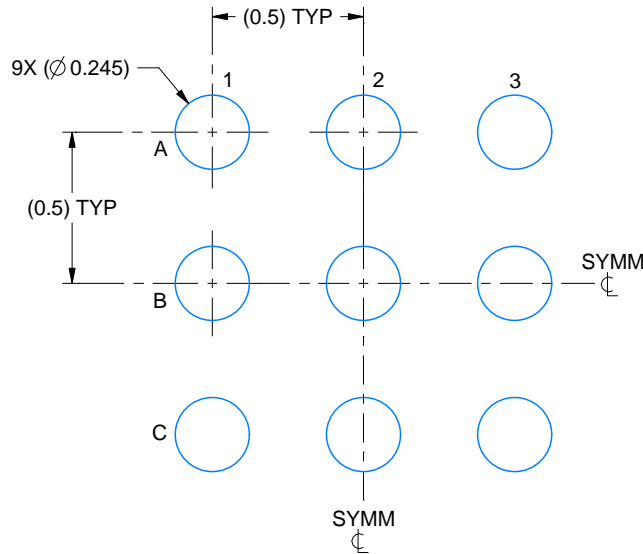

LAND PATTERN EXAMPLE
EXPOSED METAL SHOWN
SCALE: 40X

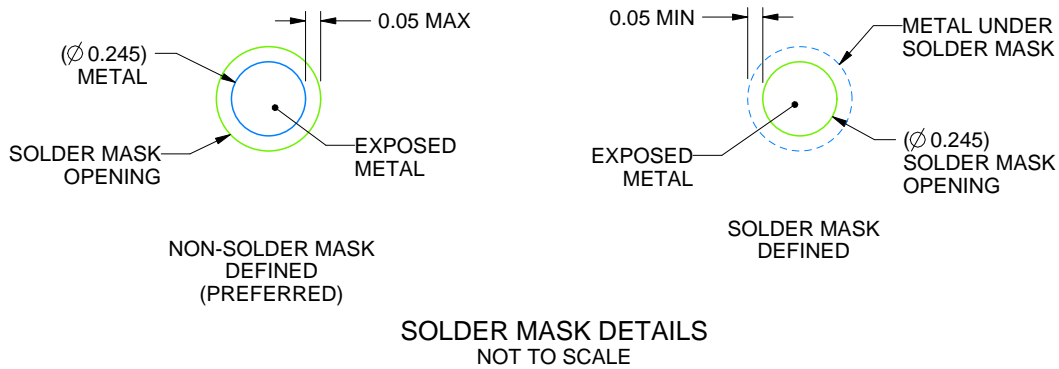

SOLDER MASK DETAILS
NOT TO SCALE

4219558/A 10/2018

NOTES: (continued)

- Final dimensions may vary due to manufacturing tolerance considerations and also routing constraints. See Texas Instruments Literature No. SNVA009 (www.ti.com/lit/snva009).

EXAMPLE STENCIL DESIGN

YZF0009

DSBGA - 0.625 mm max height

DIE SIZE BALL GRID ARRAY

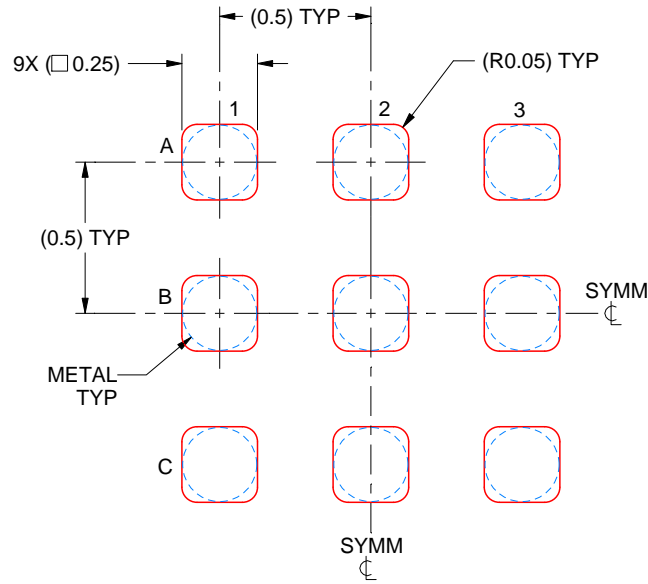

SOLDER PASTE EXAMPLE
BASED ON 0.1 mm THICK STENCIL
SCALE: 40X

4219558/A 10/2018

NOTES: (continued)

4. Laser cutting apertures with trapezoidal walls and rounded corners may offer better paste release.

重要声明和免责声明

TI“按原样”提供技术和可靠性数据（包括数据表）、设计资源（包括参考设计）、应用或其他设计建议、网络工具、安全信息和其他资源，不保证没有瑕疵且不做任何明示或暗示的担保，包括但不限于对适销性、某特定用途方面的适用性或不侵犯任何第三方知识产权的暗示担保。

这些资源可供使用 TI 产品进行设计的熟练开发人员使用。您将自行承担以下全部责任：(1) 针对您的应用选择合适的 TI 产品，(2) 设计、验证并测试您的应用，(3) 确保您的应用满足相应标准以及任何其他功能安全、信息安全、监管或其他要求。

这些资源如有变更，恕不另行通知。TI 授权您仅可将这些资源用于研发本资源所述的 TI 产品的应用。严禁对这些资源进行其他复制或展示。您无权使用任何其他 TI 知识产权或任何第三方知识产权。您应全额赔偿因在这些资源的使用中对 TI 及其代表造成的任何索赔、损害、成本、损失和债务，TI 对此概不负责。

TI 提供的产品受 [TI 的销售条款](#) 或 [ti.com](#) 上其他适用条款/TI 产品随附的其他适用条款的约束。TI 提供这些资源并不会扩展或以其他方式更改 TI 针对 TI 产品发布的适用的担保或担保免责声明。

TI 反对并拒绝您可能提出的任何其他或不同的条款。

邮寄地址：Texas Instruments, Post Office Box 655303, Dallas, Texas 75265

Copyright © 2022，德州仪器 (TI) 公司