

SWITCHING DIODE

FEATURES

- Low Forward voltage
- Fast Reverse Recovery Time
- Surface Mount device
- For General Purpose Switching Applications

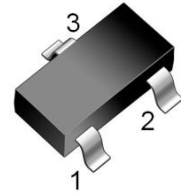

SOT-23

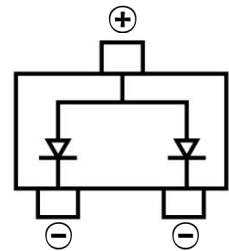

MECHANICAL DATA

- Case: SOT-23
- Case Material: Molded Plastic. UL flammability
- Classification Rating: 94V-0
- Weight: 0.008 grams (approximate)

MAXIMUM RATINGS (T_A = 25°C unless otherwise noted)

Parameter	Symbol	Value	Unit
Non-Repetitive Peak Reverse Voltage	V _{RM}	85	V
DC Blocking Reverse Voltage	V _R	80	V
Forward Current	I _F	300	mA
Average Rectified Output Current	I _O	100	mA
Non-Repetitive Peak Forward Surge Current @t@=8.3ms	I _{FSM}	2.0	A
Power Dissipation	P _D	150	mW
Thermal Resistance From Junction To Ambient	R _{θJA}	833	°C/W
Junction Temperature	T _J	150	°C
Storage Temperature	T _{STG}	-55 ~+150	°C

ELECTRICAL CHARACTERISTICS (T_A = 25°C unless otherwise specified)

Parameter	Symbol	Min	Max	Unit	Conditions
Reverse breakdown voltage	V _(BR)	80		V	I _R =100uA
Reverse voltage leakage current	I _R		0.5	uA	V _R =80V
Forward voltage	V _F		1.2	V	I _F =100mA
Diode capacitance	C _D		4	pF	V _R =0V, f=1MHz
Reverse recovery time	T _{rr}		4	nS	I _F =I _R =10mA I _{tr} =0.1×I _R R _L =100Ω

SWITCHING DIODE

Typical Characteristics

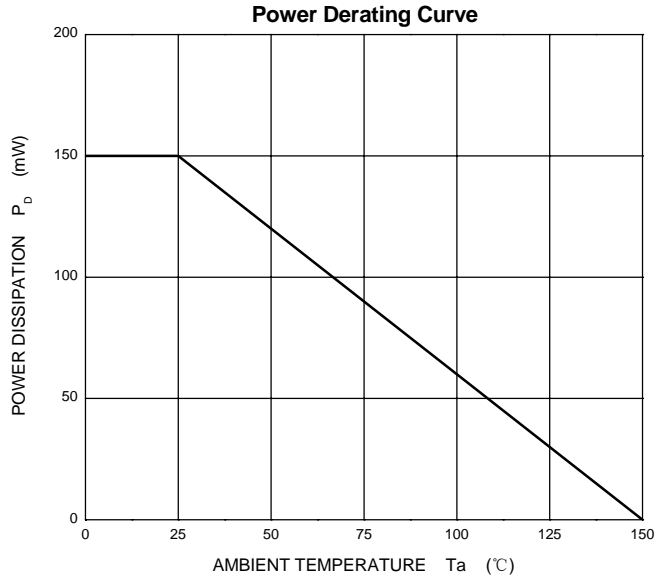
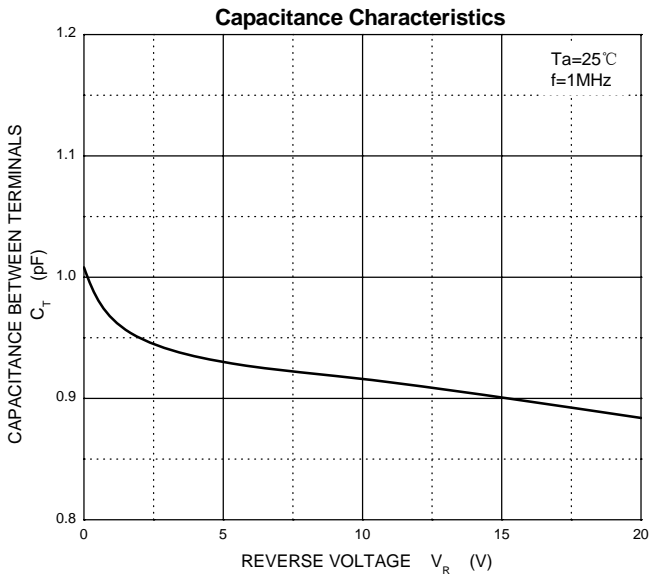
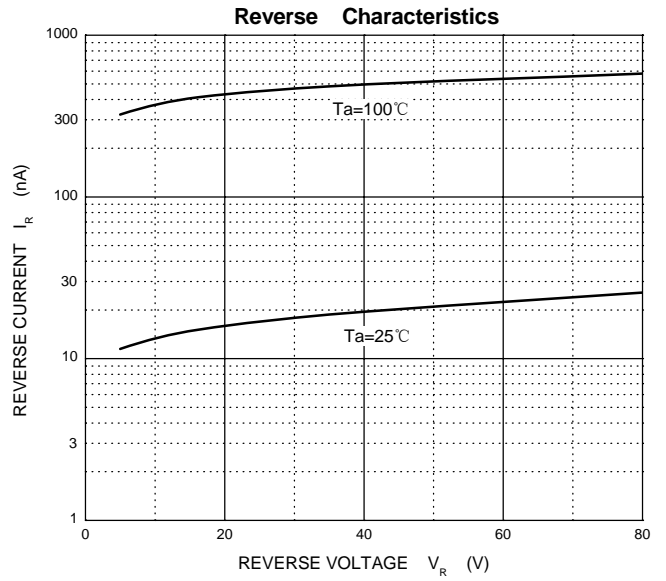
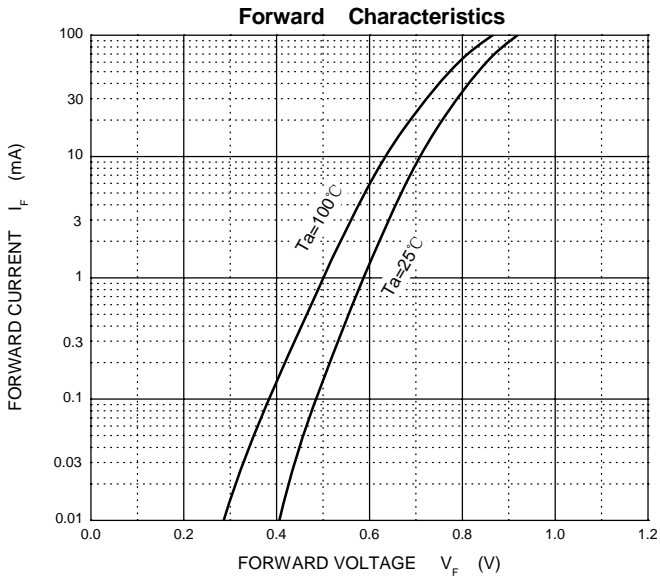

SWITCHING DIODE

SOT-23 Package Outline Dimensions

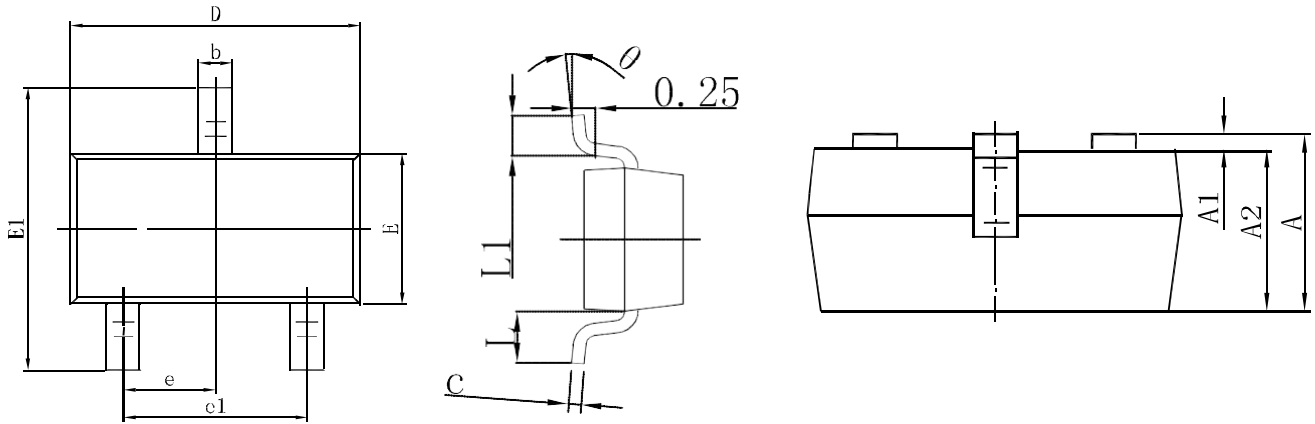

Symbol	Dimensions In Millimeters		Dimensions In Inches	
	Min.	Max.	Min.	Max.
A	0.900	1.150	0.035	0.045
A1	0.000	0.100	0.000	0.004
A2	0.900	1.050	0.035	0.041
b	0.300	0.500	0.012	0.020
c	0.080	0.150	0.003	0.006
D	2.800	3.000	0.110	0.118
E	1.200	1.400	0.047	0.055
E1	2.250	2.550	0.089	0.100
e	0.950 TYP		0.037 TYP	
e1	1.800	2.000	0.071	0.079
L	0.550 REF		0.022 REF	
L1	0.300	0.500	0.012	0.020
θ	0°	8°	0°	8°

SOT-23 Suggested Pad Layout

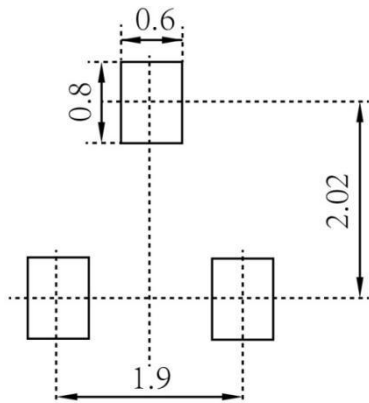

Note:

1. Controlling dimension: in millimeters
2. General tolerance: ±0.05mm
3. The pad layout is for reference purposes only

SWITCHING DIODE

SOT-23 Tape and Reel

SOT-23 Embossed Carrier Tape

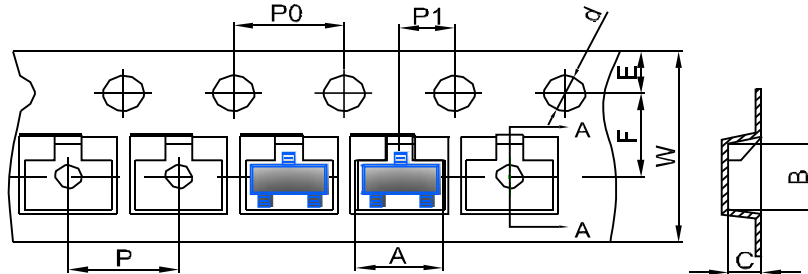

DIMENSIONS ARE IN MILLIMETER										
TYPE	A	B	C	d	E	F	P0	P	P1	W
SOT-23	3.15	2.77	1.22	Ø1.50	1.75	3.50	4.00	4.00	2.00	8.00
TOLERANCE	±0.1	±0.1	±0.1	±0.1	±0.1	±0.1	±0.1	±0.1	±0.1	±0.1

SOT-23 Tape Leader and Trailer

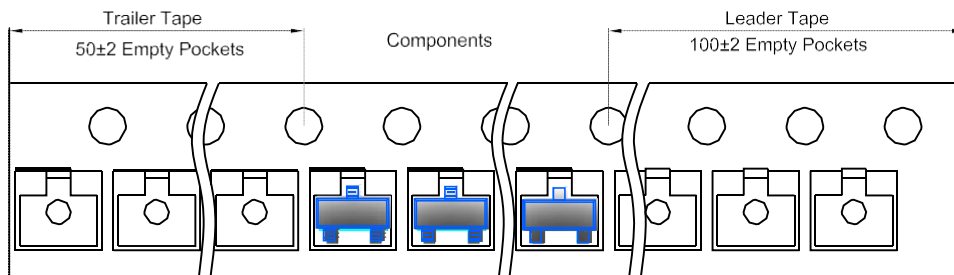

SOT-23 Reel

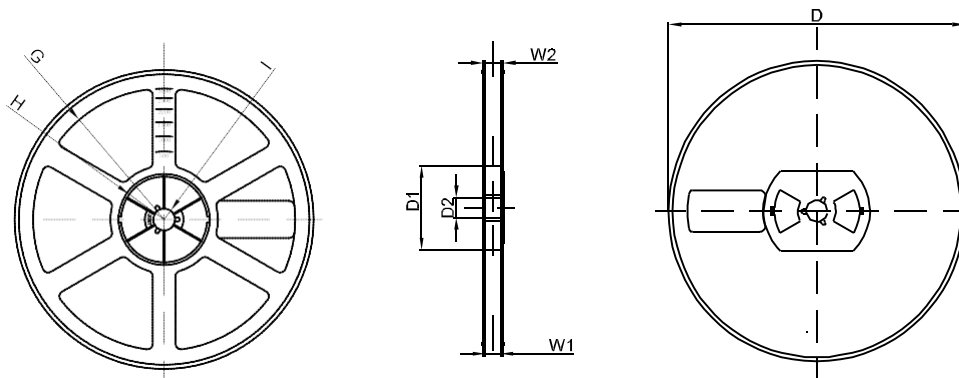

DIMENSIONS ARE IN MILLIMETER								
REEL OPTION	D	D1	D2	G	H	I	W1	W2
7" DIA	Ø178	54.40	13.00	R78	R25.60	R6.50	9.50	12.30
TOLERANCE	±2	±1	±1	±1	±1	±1	±1	±1