

TPS720 350 mA, Ultra-Low V_{IN} , RF Low-Dropout Linear Regulator With Bias Pin

1 Features

- 350-mA High-Performance LDO
- Low Quiescent Current: 38 μ A
- Excellent Load Transient Response:
 ± 15 mV for $I_{LOAD} = 0$ mA to 350 mA in 1 μ s
- Excellent Line Transient Response:
 $\Delta V_{OUT} = \pm 2$ mV for $\Delta V_{BIAS} = \pm 600$ mV in 1 μ s
 $\Delta V_{OUT} = \pm 200$ μ V for $\Delta V_{IN} = \pm 400$ mV in 1 μ s
- Low Noise: 48 μ V_{RMS} (10 Hz to 100 kHz)
- 80 dB V_{IN} PSRR (10 Hz to 10 kHz)
- 70 dB V_{BIAS} PSRR (10 Hz to 10 kHz)
- Fast Start-Up Time: 140 μ s
- Built-In Soft-Start With Monotonic V_{OUT} Rise and Start-Up Current Limited to 100 mA + I_{LOAD}
- Overcurrent and Thermal Protection
- Low Dropout: 110 mV at $I_{LOAD} = 350$ mA
- Stable with 2.2- μ F Output Capacitor
- Available in 1.33 mm \times 0.96 mm DSBGA-5 and 2 mm \times 2 mm SON-6 Packages

2 Applications

- Digital Cameras
- Cellular Camera Phones
- Wireless LAN
- Handheld Products

3 Description

The TPS720 family of dual rail, low-dropout linear regulators (LDOs) offers outstanding ac performance (PSRR, load and line transient response), while consuming a very low quiescent current of 38 μ A.

The V_{BIAS} rail that powers the control circuit of the LDO draws very low current (on the order of the quiescent current of the LDO) and can be connected to any power supply that is equal to or greater than 1.4 V above the output voltage. The main power path is through V_{IN} , which can be a lower voltage than V_{BIAS} ; it can be as low as $V_{OUT} + V_{DO}$, increasing the efficiency of the solution in many power-sensitive applications. For example, V_{IN} can be an output of a high-efficiency, DC-DC step-down regulator.

The TPS720 supports a novel feature in which the output of the LDO regulates under light loads when the IN pin is left floating. The light-load drive current is sourced from V_{BIAS} under this condition. This feature is particularly useful in power-saving applications where the DC-DC converter connected to the IN pin is disabled but the LDO is still required to regulate the voltage to a light load.

The TPS720 is stable with ceramic capacitors and uses an advanced BICMOS fabrication process that yields a dropout of 110 mV at a 350-mA output load. The TPS720 has the unique feature of providing a monotonic V_{OUT} rise (overshoot limited to 3%) with V_{IN} inrush current limited to 100 mA + I_{LOAD} with an output capacitor of 2.2 μ F.

The TPS720 uses a precision voltage reference and feedback loop to achieve overall accuracy of 2% over load, line, process, and temperature extremes. An ultra-small DSBGA package makes the TPS720 ideal for handheld applications. The TPS720 is also available in a SON-8 package. This family of devices is fully specified over the temperature range of $T_J = -40^{\circ}\text{C}$ to 125°C .

Device Information⁽¹⁾

PART NUMBER	PACKAGE	BODY SIZE (NOM)
TPS720	DSBGA (5)	1.36 mm \times 0.96 mm
	SON (6)	2.00 mm \times 2.00 mm

(1) For all available packages, see the orderable addendum at the end of the data sheet.

Simplified Schematic

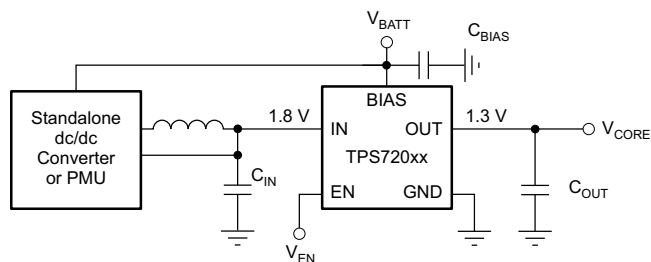

Table of Contents

1 Features	1	8.1 Application Information.....	14
2 Applications	1	8.2 Typical Application	15
3 Description	1	9 Power Supply Recommendations	17
4 Revision History	2	10 Layout	17
5 Pin Configuration and Functions	3	10.1 Layout Guidelines	17
6 Specifications	3	10.2 Layout Example	17
6.1 Absolute Maximum Ratings	3	10.3 Thermal Considerations	17
6.2 ESD Ratings.....	4	10.4 Power Dissipation	18
6.3 Recommended Operating Conditions.....	4	11 Device and Documentation Support	19
6.4 Thermal Information	4	11.1 Device Support	19
6.5 Electrical Characteristics.....	5	11.2 Documentation Support	19
6.6 Typical Characteristics.....	7	11.3 Community Resources.....	19
7 Detailed Description	12	11.4 Trademarks	19
7.1 Overview	12	11.5 Electrostatic Discharge Caution.....	19
7.2 Functional Block Diagram	12	11.6 Glossary	19
7.3 Feature Description.....	12	12 Mechanical, Packaging, and Orderable Information	20
7.4 Device Functional Modes.....	13	12.1 Package Mounting	20
8 Application and Implementation	14		

4 Revision History

NOTE: Page numbers for previous revisions may differ from page numbers in the current version.

Changes from Revision D (August 2009) to Revision E	Page
• Added <i>ESD Ratings</i> table, <i>Feature Description</i> section, <i>Device Functional Modes</i> , <i>Application and Implementation</i> section, <i>Power Supply Recommendations</i> section, <i>Layout</i> section, <i>Device and Documentation Support</i> section, and <i>Mechanical, Packaging, and Orderable Information</i> section	1

Changes from Revision C (September, 2008) to Revision D	Page
• Added electrical specifications for DRV package.....	5
• Noted electrical specifications for YZU package	5

5 Pin Configuration and Functions

DRV Package
6-Pin SON With Exposed Thermal Pad
Top View

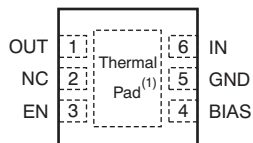

- (1) TI recommends connecting the SON (DRV) package thermal pad to ground.

YZU Package
5-Pin DSBGA
Top View

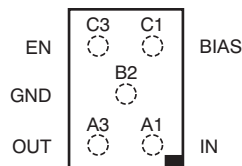

Pin Functions

PIN			I/O	DESCRIPTION
NAME	DRV	YZU		
OUT	1	A3	O	Output pin. A 2.2- μ F ceramic capacitor is connected from this pin to ground, for stability and to provide load transients. See Input and Output Capacitor Requirements .
NC	2	—	—	No connection.
EN	3	C3	I	Enable pin. A logic high signal on this pin turns the device on and regulates the voltage from IN to OUT. A logic low on this pin turns off the device.
BIAS	4	C1	I	Bias supply pin. TI recommends bypassing this input with a ceramic capacitor to ground for better transient performance. See Input and Output Capacitor Requirements .
GND	5	B2	—	Ground pin.
IN	6	A1	I	Input pin. This pin can be a maximum of 4.5 V; V_{IN} must not exceed V_{BIAS} . Bypass this input with a ceramic capacitor to ground. See Input and Output Capacitor Requirements .

6 Specifications

6.1 Absolute Maximum Ratings

At $T_J = -40^\circ\text{C}$ to 125°C (unless otherwise noted). All voltages are with respect to GND. ⁽¹⁾

		MIN	MAX	UNIT
$V_{IN}^{(2)}$	Input voltage (steady-state)	-0.3	V_{BIAS} or 5 ⁽³⁾	V
$V_{IN_PEAK}^{(4)}$	Peak transient input		5.5	V
V_{BIAS}	Bias voltage	-0.3	6	V
V_{EN}	Enable voltage	-0.3	6	V
V_{OUT}	Output voltage	-0.3	5	V
I_{OUT}	Peak output current	Internally limited		
	Output short circuit duration	Indefinite		
P_{DISS}	Total continuous power dissipation	See Thermal Information		
T_J	Operating junction temperature	-55	125	$^\circ\text{C}$
T_{stg}	Storage temperature	-55	150	$^\circ\text{C}$

- (1) Stresses beyond those listed under *Absolute Maximum Ratings* may cause permanent damage to the device. These are stress ratings only, which do not imply functional operation of the device at these or any other conditions beyond those indicated under *Recommended Operating Conditions*. Exposure to absolute-maximum-rated conditions for extended periods may affect device reliability.
- (2) To ensure proper operation of the device it is necessary that $V_{IN} \leq V_{BIAS}$ under all conditions.
- (3) Whichever is less.
- (4) For durations no longer than 1ms each, for a total of no more than 1000 occurrences over the lifetime of the device.

6.2 ESD Ratings

		VALUE	UNIT
$V_{(ESD)}$ Electrostatic discharge	Human-body model (HBM), per ANSI/ESDA/JEDEC JS-001 ⁽¹⁾	±2000	V
	Charged-device model (CDM), per JEDEC specification JESD22-C101 ⁽²⁾	±500	
	Machine model (MM)	±100	

- (1) JEDEC document JEP155 states that 500-V HBM allows safe manufacturing with a standard ESD control process.
 (2) JEDEC document JEP157 states that 250-V CDM allows safe manufacturing with a standard ESD control process.

6.3 Recommended Operating Conditions

over operating junction-air temperature range (unless otherwise noted)

		MIN	NOM	MAX	UNIT
V_{IN}	Input voltage (steady-state)	1.1		V_{BIAS} or 4.5 ⁽¹⁾	V
V_{BIAS}	Bias voltage	2.5 or or $V_{OUT} + 1.4$ ⁽²⁾		5.5	V
V_{OUT}	Output voltage	0.9		3.6	V
I_{OUT}	Peak output current	0		350	mA
C_{IN}	Input capacitance		1		μF
C_{BIAS}	Bias capacitance		0.1		μF
C_{OUT} ⁽³⁾	Output capacitance	2.2			μF

- (1) Whichever is less
 (2) Whichever is greater
 (3) Maximum ESR should be less than 250 mΩ.

6.4 Thermal Information

THERMAL METRIC ⁽¹⁾	TPS720		UNIT	
	DRV (SON)	YZU (WSCP)		
	6 PINS	5 PINS		
$R_{\theta JA}$	Junction-to-ambient thermal resistance	66.5	144.9	°C/W
$R_{\theta JC(top)}$	Junction-to-case (top) thermal resistance	86.2	1.1	°C/W
$R_{\theta JB}$	Junction-to-board thermal resistance	36.1	27.5	°C/W
ψ_{JT}	Junction-to-top characterization parameter	1.7	4.1	°C/W
ψ_{JB}	Junction-to-board characterization parameter	36.6	27.4	°C/W
$R_{\theta JC(bot)}$	Junction-to-case (bottom) thermal resistance	7.4	N/A	°C/W

- (1) For more information about traditional and new thermal metrics, see the *Semiconductor and IC Package Thermal Metrics* application report, [SPRA953](#).

6.5 Electrical Characteristics

Over operating temperature range ($T_J = -40^\circ\text{C}$ to 125°C), $V_{BIAS} = (V_{OUT} + 1.4\text{ V})$ or 2.5 V (whichever is greater); $V_{IN} \geq V_{OUT} + 0.5\text{ V}$, $I_{OUT} = 1\text{ mA}$, $V_{EN} = 1.1\text{ V}$, $C_{OUT} = 2.2\text{ }\mu\text{F}$, unless otherwise noted. Typical values are at $T_J = 25^\circ\text{C}$.

PARAMETER		TEST CONDITIONS	MIN	TYP	MAX	UNIT	
V_{IN}	Input voltage		1.1 ⁽¹⁾		V_{BIAS} or 4.5 ⁽²⁾	V	
V_{BIAS}	Bias voltage		2.5		5.5	V	
V_{OUT} ⁽³⁾	Output voltage ⁽⁴⁾		0.9		3.6	V	
	Output accuracy	Nominal	$T_J = 25^\circ\text{C}$	-3		3	mV
		Over V_{BIAS} , V_{IN} , I_{OUT} , $T_J = -40^\circ\text{C}$ to 125°C	$V_{OUT} + 1.4\text{ V} \leq V_{BIAS} \leq 5.5\text{ V}$, $V_{OUT} + 0.5\text{ V} \leq V_{IN} \leq 4.5\text{ V}$, $0\text{ mA} \leq I_{OUT} \leq 350\text{ mA}$	-2%		2%	
		Over V_{BIAS} , V_{IN} , I_{OUT} , $T_J = -40^\circ\text{C}$ to 125°C	DRV package only: $V_{OUT} + 1.4\text{ V} \leq V_{BIAS} \leq 5.5\text{ V}$, $V_{OUT} + 0.5\text{ V} \leq V_{IN} \leq 4.5\text{ V}$, $0\text{ mA} \leq I_{OUT} \leq 350\text{ mA}$, $V_{OUT} < 1.2\text{ V}$	-25		25	mV
		Over V_{BIAS} , V_{IN} , I_{OUT} , $T_J = -10^\circ\text{C}$ to 85°C	YZU package only: $V_{OUT} + 1.4\text{ V} \leq V_{BIAS} \leq 5.5\text{ V}$, $V_{OUT} + 0.5\text{ V} \leq V_{IN} \leq 4.5\text{ V}$, $0\text{ mA} \leq I_{OUT} \leq 350\text{ mA}$, $1.6\text{ V} \leq V_{OUT} \leq 3.3\text{ V}$	-1%		1%	
V_{IN} floating	$V_{OUT} + 1.4\text{ V} \leq V_{BIAS} \leq 5.5\text{ V}$, $0\text{ }\mu\text{A} \leq I_{OUT} \leq 500\text{ }\mu\text{A}$		$\pm 1\%$				
$\Delta V_{OUT}/\Delta V_{IN}$	V_{IN} line regulation	$V_{IN} = (V_{OUT} + 0.5\text{ V})$ to 4.5 V , $I_{OUT} = 1\text{ mA}$		16		$\mu\text{V}/\text{V}$	
$\Delta V_{OUT}/\Delta V_{BIAS}$	V_{BIAS} line regulation	$V_{BIAS} = (V_{OUT} + 1.4\text{ V})$ or 2.5 V (whichever is greater) to 5.5 V , $I_{OUT} = 1\text{ mA}$		16		$\mu\text{V}/\text{V}$	
	V_{IN} line transient	$\Delta V_{IN} = 400\text{ mV}$, $t_{RISE} = t_{FALL} = 1\text{ }\mu\text{s}$		± 200		μV	
	V_{BIAS} line transient	$\Delta V_{BIAS} = 600\text{ mV}$, $t_{RISE} = t_{FALL} = 1\text{ }\mu\text{s}$		± 0.8		mV	
$\Delta V_{OUT}/\Delta I_{OUT}$	Load regulation	$0\text{ mA} \leq I_{OUT} \leq 350\text{ mA}$ (no load to full load)		-15		$\mu\text{V}/\text{mA}$	
	Load transient	$0\text{ mA} \leq I_{OUT} \leq 350\text{ mA}$, $t_{RISE} = t_{FALL} = 1\text{ }\mu\text{s}$		± 15		mV	
V_{DO_IN}	V_{IN} dropout voltage ⁽⁵⁾	$V_{IN} = V_{OUT(NOM)} - 0.1\text{ V}$, $(V_{BIAS} - V_{OUT(NOM)}) = 1.4\text{ V}$, $I_{OUT} = 350\text{ mA}$		110	200	mV	
V_{DO_BIAS}	V_{BIAS} dropout voltage ⁽⁶⁾	$V_{IN} = V_{OUT(NOM)} + 0.3\text{ V}$, $I_{OUT} = 350\text{ mA}$		1.09	1.4	V	
I_{CL}	Output current limit	$V_{OUT} = 0.9 \times V_{OUT(NOM)}$	420	525	800	mA	
I_{GND}	Ground pin current	$I_{OUT} = 100\text{ }\mu\text{A}$		38		μA	
		$I_{OUT} = 0\text{ mA}$ to 350 mA		54	80		
I_{SHDN}	Shutdown current (I_{GND})	$V_{EN} \leq 0.4\text{ V}$, $T_J = -40^\circ\text{C}$ to 85°C		0.5	2	μA	
PSRR	V_{IN} power-supply rejection ratio	$V_{IN} - V_{OUT} \geq 0.5\text{ V}$, $V_{BIAS} = V_{OUT} + 1.4\text{ V}$, $I_{OUT} = 350\text{ mA}$	$f = 10\text{ Hz}$		85	dB	
			$f = 100\text{ Hz}$		85		
			$f = 1\text{ kHz}$		85		
			$f = 10\text{ kHz}$		80		
			$f = 100\text{ kHz}$		70		
			$f = 1\text{ MHz}$		50		

(1) Performance specifications are ensured up to a minimum $V_{IN} = V_{OUT} + 0.5\text{ V}$.

(2) Whichever is less.

(3) Minimum $V_{BIAS} = (V_{OUT} + 1.4\text{ V})$ or 2.5 V (whichever is greater) and $V_{IN} = V_{OUT} + 0.5\text{ V}$.

(4) V_O nominal value is factory programmable through the onchip EEPROM.

(5) Measured for devices with $V_{OUT(NOM)} \geq 1.2\text{ V}$.

(6) $V_{BIAS} - V_{OUT}$ with $V_{OUT} = V_{OUT(NOM)} - 0.1\text{ V}$. Measured for devices with $V_{OUT(NOM)} \geq 1.8\text{ V}$.

Electrical Characteristics (continued)

Over operating temperature range ($T_J = -40^\circ\text{C}$ to 125°C), $V_{\text{BIAS}} = (V_{\text{OUT}} + 1.4 \text{ V})$ or 2.5 V (whichever is greater); $V_{\text{IN}} \geq V_{\text{OUT}} + 0.5 \text{ V}$, $I_{\text{OUT}} = 1 \text{ mA}$, $V_{\text{EN}} = 1.1 \text{ V}$, $C_{\text{OUT}} = 2.2 \mu\text{F}$, unless otherwise noted. Typical values are at $T_J = 25^\circ\text{C}$.

PARAMETER		TEST CONDITIONS	MIN	TYP	MAX	UNIT
PSRR	V_{BIAS} power-supply rejection ratio	$V_{\text{IN}} - V_{\text{OUT}} \geq 0.5 \text{ V}$, $V_{\text{BIAS}} = V_{\text{OUT}} + 1.4 \text{ V}$, $I_{\text{OUT}} = 350 \text{ mA}$	$f = 10 \text{ Hz}$	80		dB
			$f = 100 \text{ Hz}$	80		
			$f = 1 \text{ kHz}$	75		
			$f = 10 \text{ kHz}$	65		
			$f = 100 \text{ kHz}$	55		
			$f = 1 \text{ MHz}$	35		
V_{N}	Output noise voltage	$\text{BW} = 10 \text{ Hz to } 100 \text{ kHz}$, $V_{\text{BIAS}} \geq 2.5 \text{ V}$, $V_{\text{IN}} = V_{\text{OUT}} + 0.5 \text{ V}$		48		μV_{RMS}
$I_{\text{VIN_INRUSH}}$	Inrush current on V_{IN}	$V_{\text{BIAS}} = (V_{\text{OUT}} + 1.4 \text{ V})$ or 2.5 V (whichever is greater), $V_{\text{IN}} = V_{\text{OUT}} + 0.5 \text{ V}$		$100 + I_{\text{LOAD}}$		mA
t_{STR}	Start-up time	$V_{\text{OUT}} = 95\% V_{\text{OUT(NOM)}}$, $I_{\text{OUT}} = 350 \text{ mA}$, $C_{\text{OUT}} = 2.2 \mu\text{F}$		140		μs
$V_{\text{EN(HI)}}$	Enable pin high (enabled)		1.1			V
$V_{\text{EN(LO)}}$	Enable pin low (disabled)		0		0.4	V
I_{EN}	Enable pin current	$V_{\text{EN}} = 5.5 \text{ V}$, $V_{\text{IN}} = 4.5 \text{ V}$, $V_{\text{BIAS}} = 5.5 \text{ V}$			1	μA
UVLO	Undervoltage lockout	V_{BIAS} rising	2.41	2.45	2.49	V
	Hysteresis	V_{BIAS} falling		150		mV
T_{SD}	Thermal shutdown temperature	Shutdown, temperature increasing		160		$^\circ\text{C}$
		Reset, temperature decreasing		140		
T_J	Operating junction temperature		-40		125	$^\circ\text{C}$

6.6 Typical Characteristics

Over operating temperature range ($T_J = -40^\circ\text{C}$ to 125°C), $V_{\text{BIAS}} = (V_{\text{OUT}} + 1.4 \text{ V})$ or 2.5 V (whichever is greater); $V_{\text{IN}} = V_{\text{OUT}} + 0.5 \text{ V}$, $I_{\text{OUT}} = 1 \text{ mA}$, $V_{\text{EN}} = 1.1 \text{ V}$, $C_{\text{OUT}} = 2.2 \mu\text{F}$, unless otherwise noted. Typical values are at $T_J = 25^\circ\text{C}$.

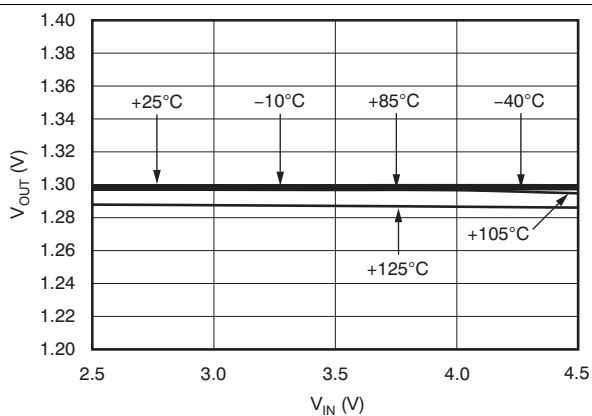

$I_{\text{OUT}} = 0 \text{ mA}$

Figure 1. V_{IN} Line Regulation (TPS72013YZU)

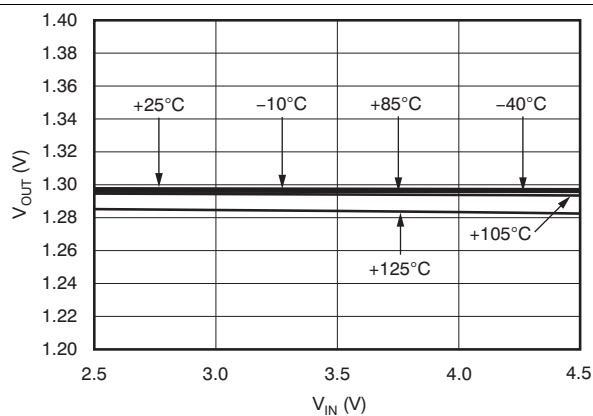

$I_{\text{OUT}} = 350 \text{ mA}$

Figure 2. V_{IN} Line Regulation (TPS72013YZU)

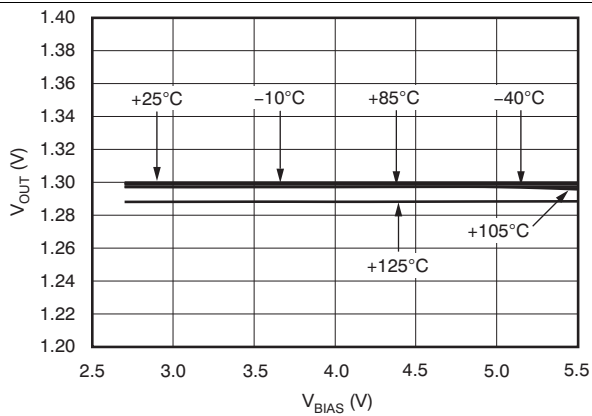

$I_{\text{OUT}} = 0 \text{ mA}$

Figure 3. V_{BIAS} Line Regulation (TPS72013YZU)

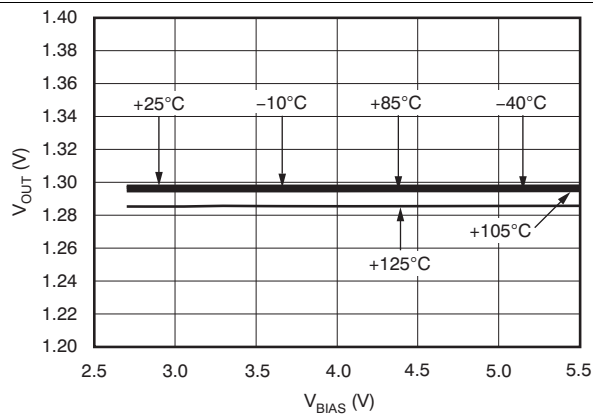

$I_{\text{OUT}} = 350 \text{ mA}$

Figure 4. V_{BIAS} Line Regulation (TPS72013YZU)

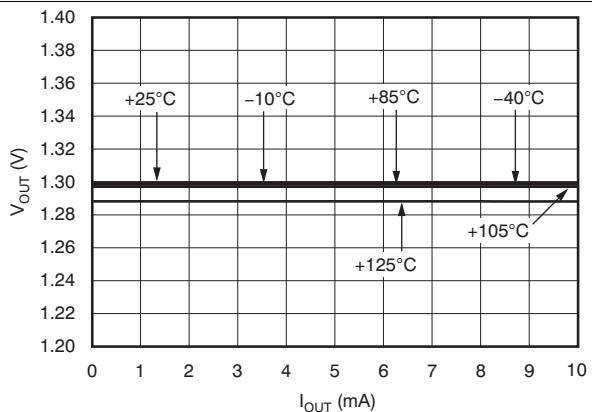

Figure 5. Load Regulation Under Light Loads (TPS72013YZU)

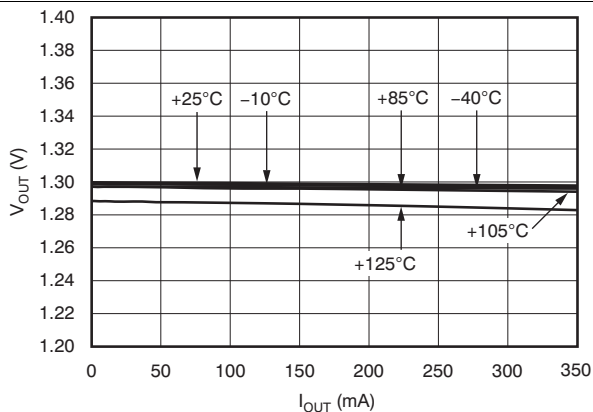

Figure 6. Load Regulation (TPS72013YZU)

Typical Characteristics (continued)

Over operating temperature range ($T_J = -40^{\circ}\text{C}$ to 125°C), $V_{BIAS} = (V_{OUT} + 1.4\text{ V})$ or 2.5 V (whichever is greater); $V_{IN} = V_{OUT} + 0.5\text{ V}$, $I_{OUT} = 1\text{ mA}$, $V_{EN} = 1.1\text{ V}$, $C_{OUT} = 2.2\text{ }\mu\text{F}$, unless otherwise noted. Typical values are at $T_J = 25^{\circ}\text{C}$.

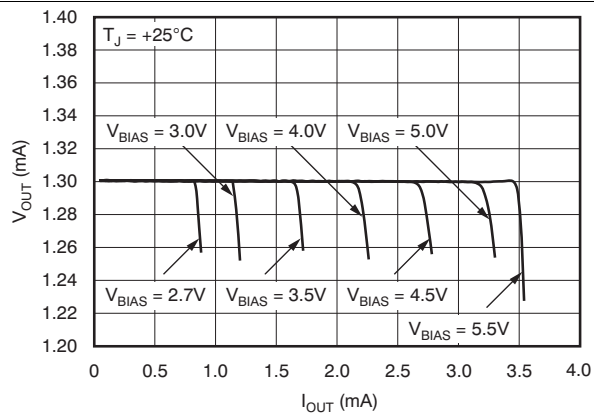

Figure 7. Load Regulation With V_{IN} Floating (TPS72013YZU)

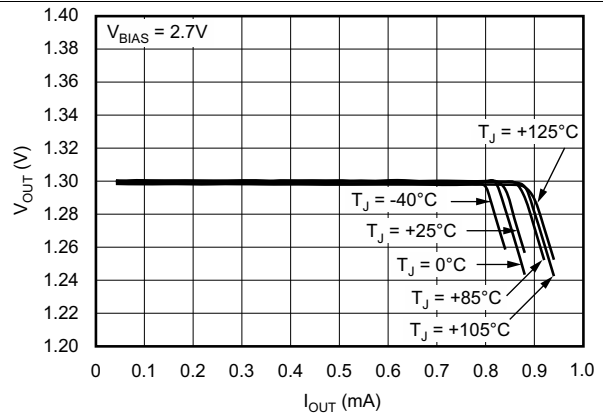

Figure 8. Load Regulation With V_{IN} Floating (TPS72013YZU)

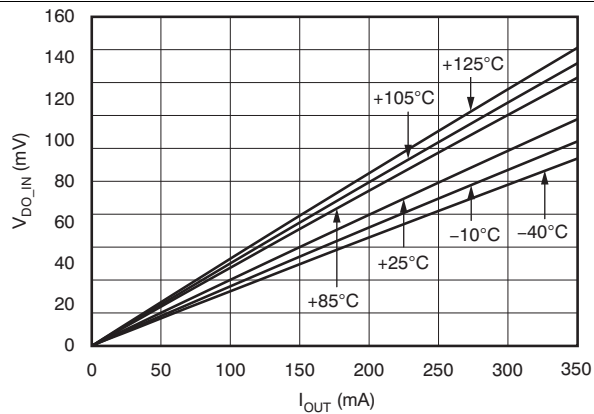

Figure 9. V_{IN} Dropout Voltage vs Output Current (TPS72013YZU)

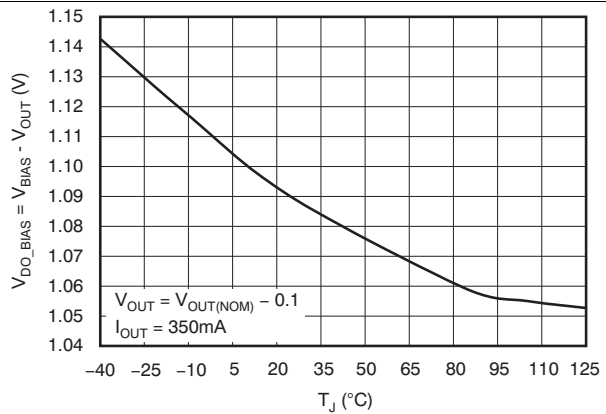

Figure 10. V_{BIAS} Dropout Voltage vs Temperature (TPS72033YZU)

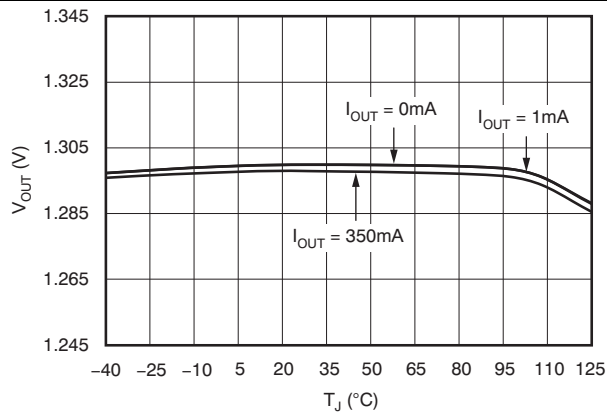

Figure 11. Output Voltage vs Temperature (TPS72013YZU)

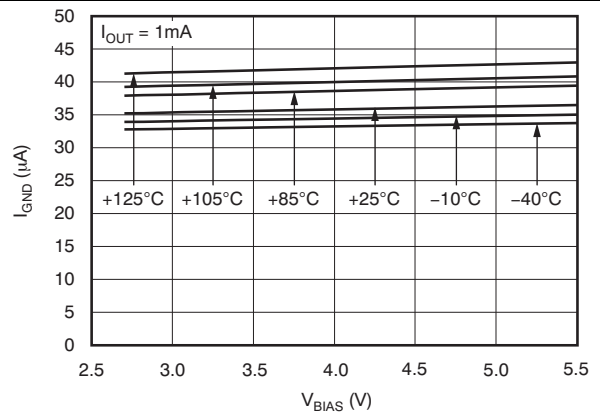

Figure 12. Ground Pin Current vs V_{BIAS} Input Voltage (TPS72013YZU)

Typical Characteristics (continued)

Over operating temperature range ($T_J = -40^\circ\text{C}$ to 125°C), $V_{BIAS} = (V_{OUT} + 1.4\text{ V})$ or 2.5 V (whichever is greater); $V_{IN} = V_{OUT} + 0.5\text{ V}$, $I_{OUT} = 1\text{ mA}$, $V_{EN} = 1.1\text{ V}$, $C_{OUT} = 2.2\text{ }\mu\text{F}$, unless otherwise noted. Typical values are at $T_J = 25^\circ\text{C}$.

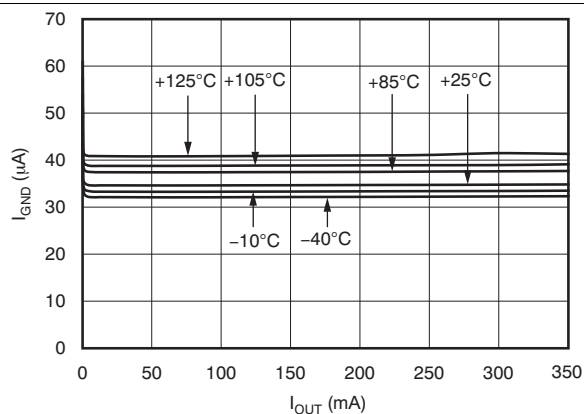

Figure 13. Ground Pin Current vs Output Current (TPS72013YZU)

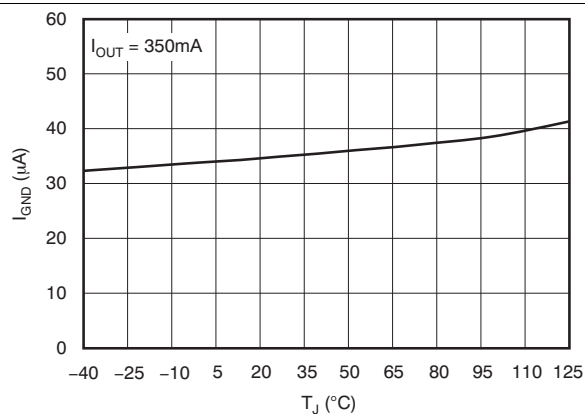

Figure 14. Ground Pin Current vs Temperature (TPS72013YZU)

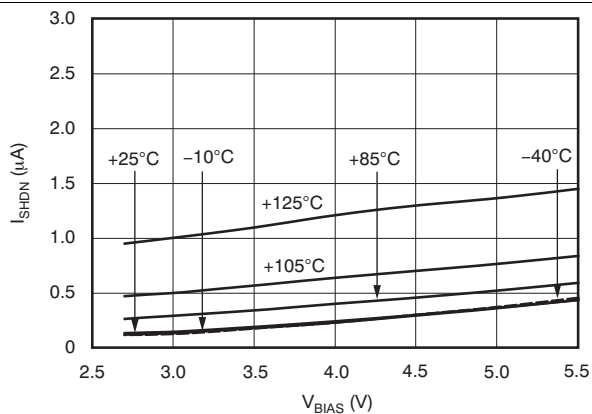

Figure 15. Shutdown Current vs VBIAS Input Voltage (TPS72013YZU)

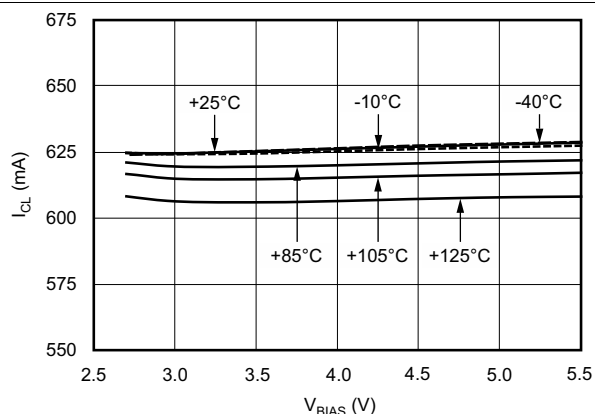

Figure 16. Current Limit vs VBIAS Input Voltage (TPS72013YZU)

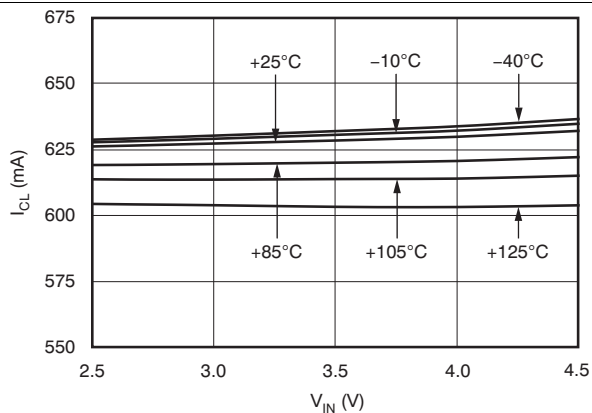

Figure 17. Current Limit vs VIN Input Voltage (TPS72013YZU)

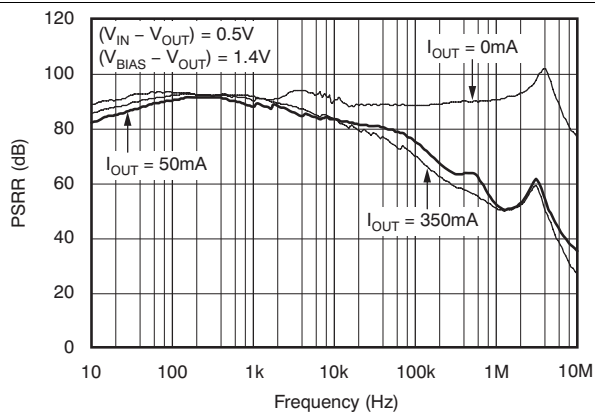

Figure 18. VIN Power-Supply Ripple Rejection vs Frequency (TPS72015YZU)

Typical Characteristics (continued)

Over operating temperature range ($T_J = -40^{\circ}\text{C}$ to 125°C), $V_{BIAS} = (V_{OUT} + 1.4\text{ V})$ or 2.5 V (whichever is greater); $V_{IN} = V_{OUT} + 0.5\text{ V}$, $I_{OUT} = 1\text{ mA}$, $V_{EN} = 1.1\text{ V}$, $C_{OUT} = 2.2\text{ }\mu\text{F}$, unless otherwise noted. Typical values are at $T_J = 25^{\circ}\text{C}$.

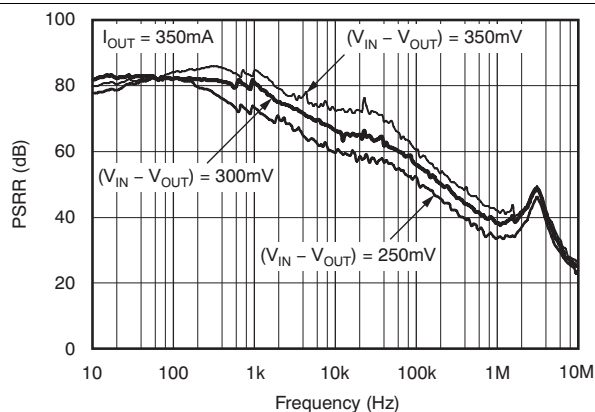

Figure 19. V_{IN} Power-Supply Ripple Rejection vs Frequency (TPS72015YZU)

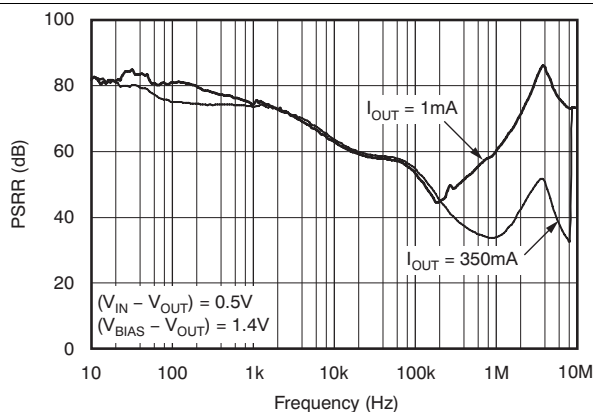

Figure 20. V_{BIAS} Power-Supply Ripple Rejection vs Frequency (TPS72015YZU)

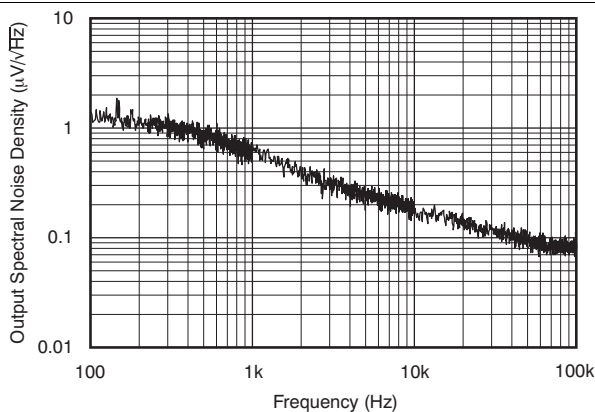
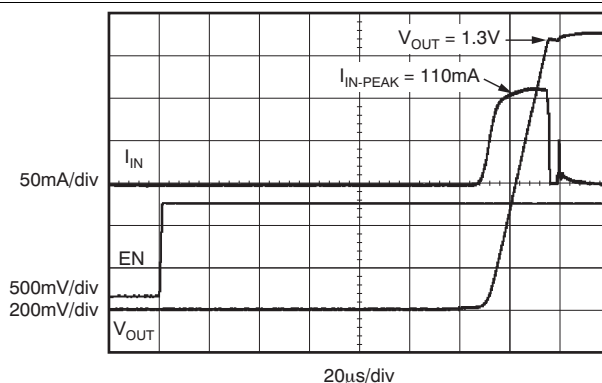
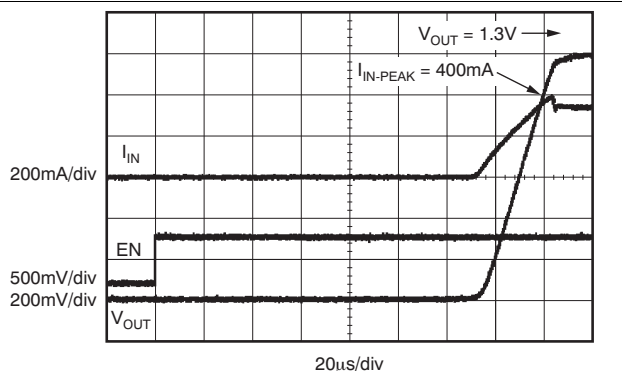

Figure 21. Output Spectral Noise Density vs Frequency (TPS72015YZU)



$V_{IN} = 1.8\text{ V}$ $V_{OUT} = 1.3\text{ V}$ $V_{BIAS} = 2.7\text{ V}$
 $I_{OUT} = 0\text{ mA}$

Figure 22. V_{IN} Inrush Current



$V_{IN} = 1.8\text{ V}$ $V_{OUT} = 1.3\text{ V}$ $V_{BIAS} = 2.7\text{ V}$
 $I_{OUT} = 350\text{ mA}$

Figure 23. V_{IN} Inrush Current

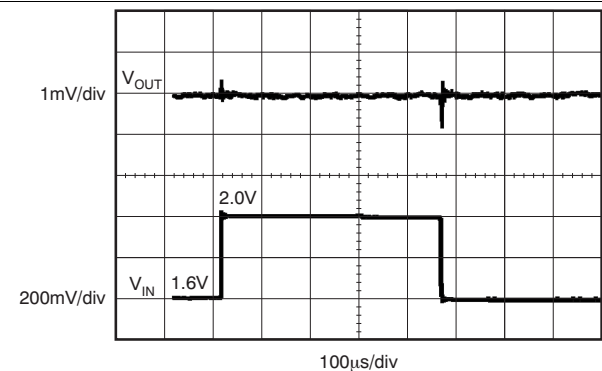

$V_{IN} = 1.6\text{ to }2\text{ V}$ $V_{OUT} = 1.3\text{ V}$ $V_{BIAS} = 2.7\text{ V}$
 V_{IN} Slew Rate = $1\text{ V}/\mu\text{s}$ $I_{OUT} = 350\text{ mA}$

Figure 24. V_{IN} Line Transient Response

Typical Characteristics (continued)

Over operating temperature range ($T_J = -40^{\circ}\text{C}$ to 125°C), $V_{\text{BIAS}} = (V_{\text{OUT}} + 1.4 \text{ V})$ or 2.5 V (whichever is greater); $V_{\text{IN}} = V_{\text{OUT}} + 0.5 \text{ V}$, $I_{\text{OUT}} = 1 \text{ mA}$, $V_{\text{EN}} = 1.1 \text{ V}$, $C_{\text{OUT}} = 2.2 \mu\text{F}$, unless otherwise noted. Typical values are at $T_J = 25^{\circ}\text{C}$.

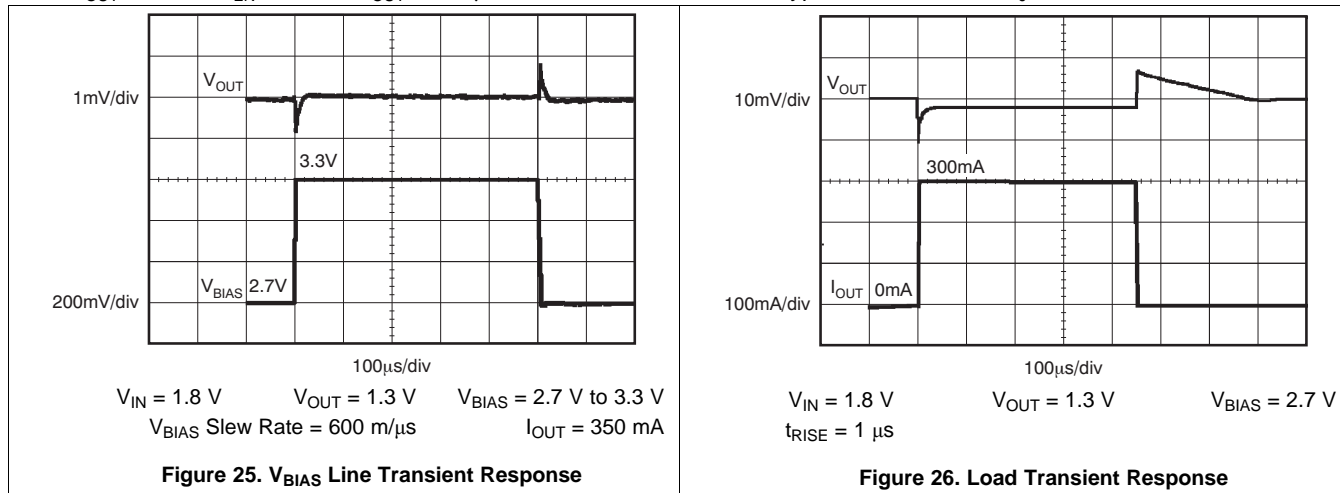

7 Detailed Description

7.1 Overview

The TPS720 belongs to a family of new generation LDO regulators that use innovative circuitry to achieve ultra-wide bandwidth and high loop gain, resulting in extremely high PSRR (up to 1 MHz) at very low headroom ($V_{IN} - V_{OUT}$). The implementation of the BIAS pin on the TPS720 vastly improves efficiency of low V_{OUT} applications by allowing the use of a preregulated, low-voltage input supply. The TPS720 supports a novel feature in which the output of the LDO regulates under light loads (<500 μ A) when the IN pin is left floating. The light-load drive current is sourced from V_{BIAS} under this condition. This feature is particularly useful in power-saving applications where the DC-DC converter connected to the IN pin is disabled but the LDO is still required to regulate the voltage to a light load. These features, combined with low noise, low ground pin current, and ultra-small packaging, make this device ideal for portable applications. This family of regulators offers sub-bandgap output voltages, current limit and thermal protection, and is fully specified from -40°C to 125°C .

7.2 Functional Block Diagram

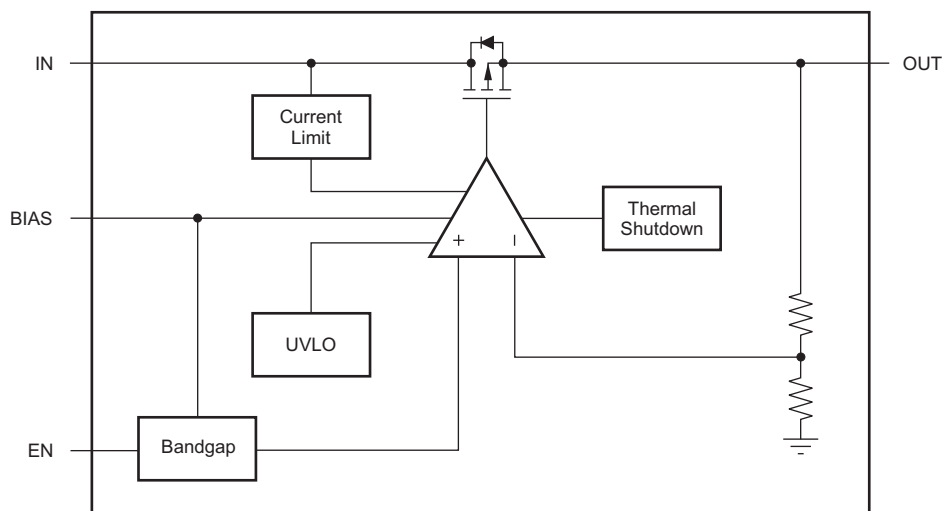

7.3 Feature Description

7.3.1 Internal Current Limit

The TPS720 internal current limits help protect the regulator during fault conditions. During current limit, the output sources a fixed amount of current that is largely independent of output voltage. In such a case, the output voltage is not regulated, and is $V_{OUT} = I_{LIMIT} \times R_{LOAD}$. The NMOS pass transistor dissipates $(V_{IN} - V_{OUT}) \times I_{LIMIT}$ until thermal shutdown is triggered and the device is turned off. As the device cools down, it is turned on by the internal thermal shutdown circuit. If the fault condition continues, the device cycles between current limit and thermal shutdown. See the [Thermal Considerations](#) section for more details.

The NMOS pass element in the TPS720 has a built-in body diode that conducts current when the voltage at OUT exceeds the voltage at IN. This current is not limited, so if extended reverse voltage operation is anticipated, external limiting to 5% of rated output current is recommended.

7.3.2 Inrush Current Limit

The TPS720 family of LDO regulators implement a novel inrush current limit circuit architecture: the current drawn through the IN pin is limited to a finite value. This $I_{INRUSHLIMIT}$ charges the output to its final voltage. All the current drawn through V_{IN} goes to charge the output capacitance when the load is disconnected. The following equation shows the inrush current limit performed by the circuit:

$$I_{INRUSHLIMIT}(A) = C_{OUT}(\mu F) \times 0.0454545 (V/\mu s) + I_{LOAD}(A) \quad (1)$$

Feature Description (continued)

Assuming a C_{OUT} of 2.2 μF with the load disconnected (that is, $I_{LOAD} = 0$) the $I_{INRUSHLIMIT}$ is calculated to be 100 mA. The inrush current charges the LDO output capacitor. If the output of the LDO regulates to 1.3 V, then the LDO charges the output capacitor to the final output value in approximately 28.6 μs .

Another consideration is when a load is connected to the output of an LDO. The connected load tries to steer a portion of the current away from V_{OUT} . The TPS720 inrush current limit circuit employs a new technique that supplies not only the $I_{INRUSHLIMIT}$, but also the additional current needed by the load. If $I_{LOAD} = 350$ mA, then the $I_{INRUSHLIMIT}$ calculates to be approximately 450 mA (from [Equation 1](#)).

7.3.3 Shutdown

The enable pin (EN) is active high and is compatible with standard and low voltage, TTL-CMOS levels. When shutdown capability is not required, EN can be connected to the IN pin.

7.3.4 Undervoltage Lockout (UVLO)

The TPS720 uses an undervoltage lock-out circuit on the BIAS pin to keep the output shut off until the internal circuitry is operating properly. The UVLO circuit has a deglitch feature so that it typically ignores undershoot transients on the input if they are less than 50- μs duration.

7.4 Device Functional Modes

Driving the EN pin over 1.1 V turns on the regulator. Driving the EN pin below 0.4 V causes the regulator to enter shutdown mode. In shutdown, the current consumption of the device is reduced to 500 nA, typically.

8 Application and Implementation

NOTE

Information in the following applications sections is not part of the TI component specification, and TI does not warrant its accuracy or completeness. TI's customers are responsible for determining suitability of components for their purposes. Customers should validate and test their design implementation to confirm system functionality.

8.1 Application Information

8.1.1 Input and Output Capacitor Requirements

Although an input capacitor is not required for stability on the IN pin, it is good analog design practice to connect a 0.1- μF to 1- μF low equivalent series resistance (ESR) capacitor across the IN pin input supply near the regulator. This capacitor counteracts reactive input sources and improves transient response, noise rejection, and ripple rejection. A higher-value capacitor may be necessary if large, fast rise-time load transients are anticipated, or if the device is located close to the power source. If source impedance is not sufficiently low, a 0.1- μF input capacitor may be necessary to ensure stability.

The BIAS pin does not require an input capacitor because it does not source high currents. However, if source impedance is not sufficiently low, then TI recommends a small 0.1- μF bypass capacitor.

The TPS720 is designed to be stable with standard ceramic capacitors with values of 2.2 μF or larger at the output. X5R- and X7R-type capacitors are best because they have minimal variation in value and ESR over temperature. Maximum ESR should be less than 250 m Ω .

8.1.2 Output Regulation With IN Pin Floating

The TPS720 supports a novel feature in which the output of the LDO regulates under light loads when the IN pin is left floating. Under normal conditions, when the IN pin is connected to a power source, the BIAS pin draws only tens of milliamperes. However, when the IN pin is floating, an innovative circuit is used that allows a maximum current of 500 μA to be drawn by the load through the BIAS pin, while maintaining the output in regulation. This feature is particularly useful in power-saving applications where a DC-DC converter connected to the IN pin is disabled, but the LDO is required to regulate the output voltage to a light load.

Figure 27 shows an application example where a microcontroller is not turned off (to maintain the state of the internal memory), but where the regulated supply (shown as the TPS62xxx) is turned off to reduce power. In this case, the TPS720 BIAS pin provides sufficient load current to maintain a regulated voltage to the microcontroller.

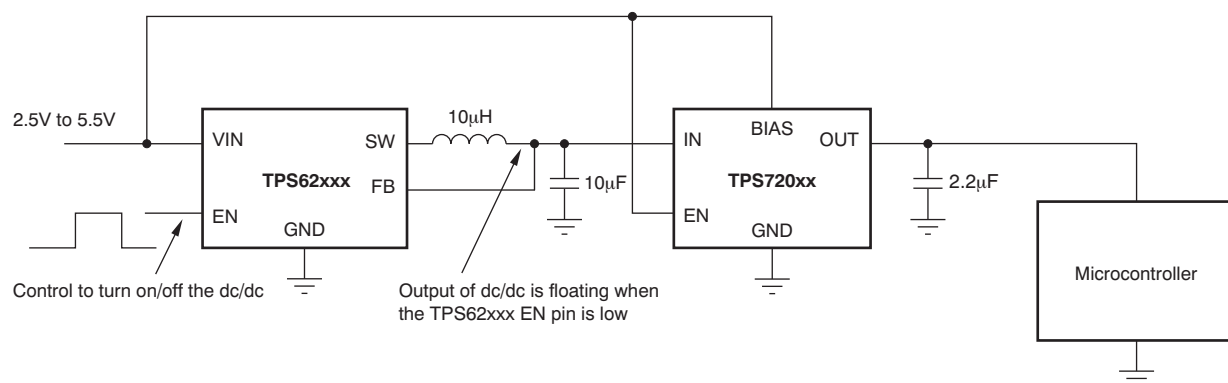

Figure 27. Example of Floating IN Pin Regulation

Application Information (continued)

8.1.3 Dropout Voltage

The TPS720 uses a NMOS pass transistor to achieve low dropout. When $(V_{IN} - V_{OUT})$ is less than the dropout voltage (V_{DO}), the NMOS pass device is in the linear region of operation and the input-to-output resistance is the $R_{DS(ON)}$ of the NMOS pass element. V_{DO} approximately scales with output current because the NMOS device behaves as a resistor in dropout.

As with any linear regulator, PSRR and transient response are degraded as $(V_{IN} - V_{OUT})$ approaches dropout. This effect is shown in [Figure 19](#).

8.1.4 Transient Response

As with any regulator, increasing the size of the output capacitor reduces overshoot and undershoot magnitude but increases duration of the transient response.

8.1.5 Minimum Load

The TPS720 is stable with no output load. Traditional LDOs suffer from low loop gain at very light output loads. The TPS720 employs an innovative, low-current mode circuit under very light or no-load conditions, resulting in improved output voltage regulation performance reduced to zero output current.

8.2 Typical Application

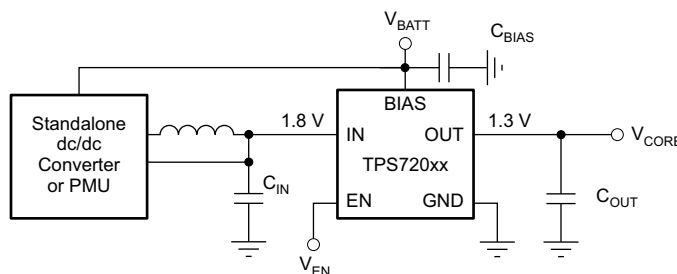

Figure 28. Typical Application Schematic

8.2.1 Design Requirements

[Table 1](#) shows the parameters for this design example.

Table 1. Design Parameters

DESIGN PARAMETER	EXAMPLE VALUE
V_{IN}	1.8 V
V_{BIAS}	2.7 V
V_{OUT}	1.3 V
I_{OUT}	10-mA typical, 350-mA peak

8.2.2 Detailed Design Procedures

A small-size solution is desired, so select the minimum recommended component size. Set $C_{IN} = 1 \mu F$, $C_{BIAS} = 100 \text{ nF}$, $C_{OUT} = 2.2 \mu F$.

8.2.3 Application Curves

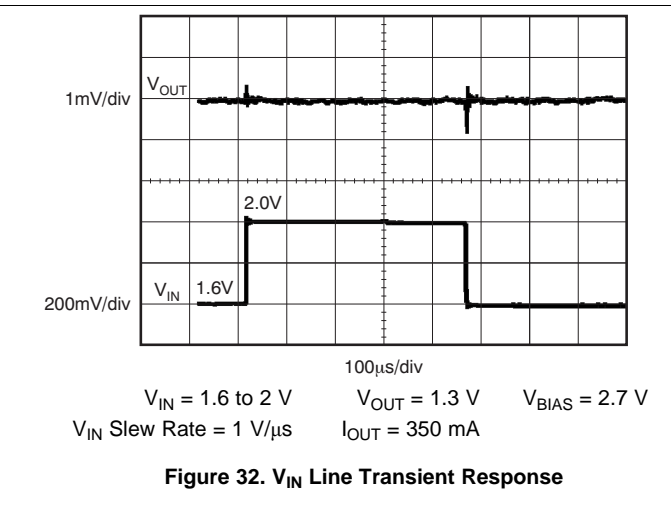
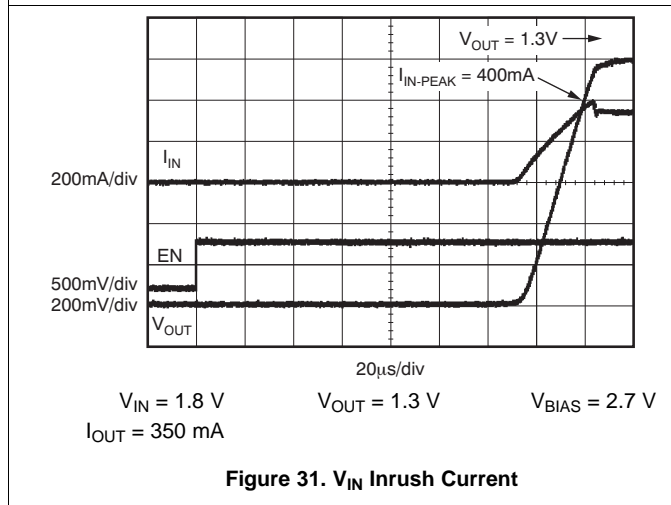
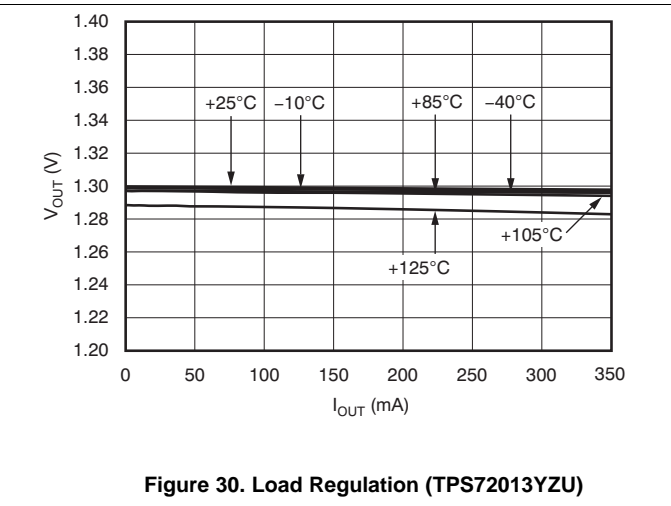
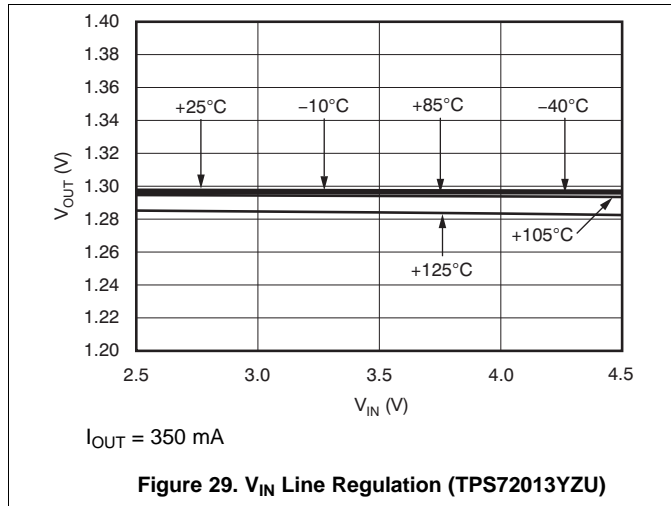

9 Power Supply Recommendations

The input supply and bias supply for the LDO must be within its recommended operating conditions and provide adequate headroom for the device to have a regulated output. The minimum capacitor requirements must be met, and if the input supply is noisy, then additional input capacitors with low ESR can help improve transient performance.

10 Layout

10.1 Layout Guidelines

To improve AC performance such as PSRR, output noise, and transient response, TI recommends designing the board with separate ground planes for V_{IN} and V_{OUT} , with the ground plane connected only at the GND pin of the device. In addition, the ground connection for the output capacitor should be connected directly to the GND pin of the device. High equivalent series resistance (ESR) capacitors may degrade PSRR. The BIAS pin draws very little current and can be routed as a signal (make sure to shield it from high-frequency coupling).

10.2 Layout Example

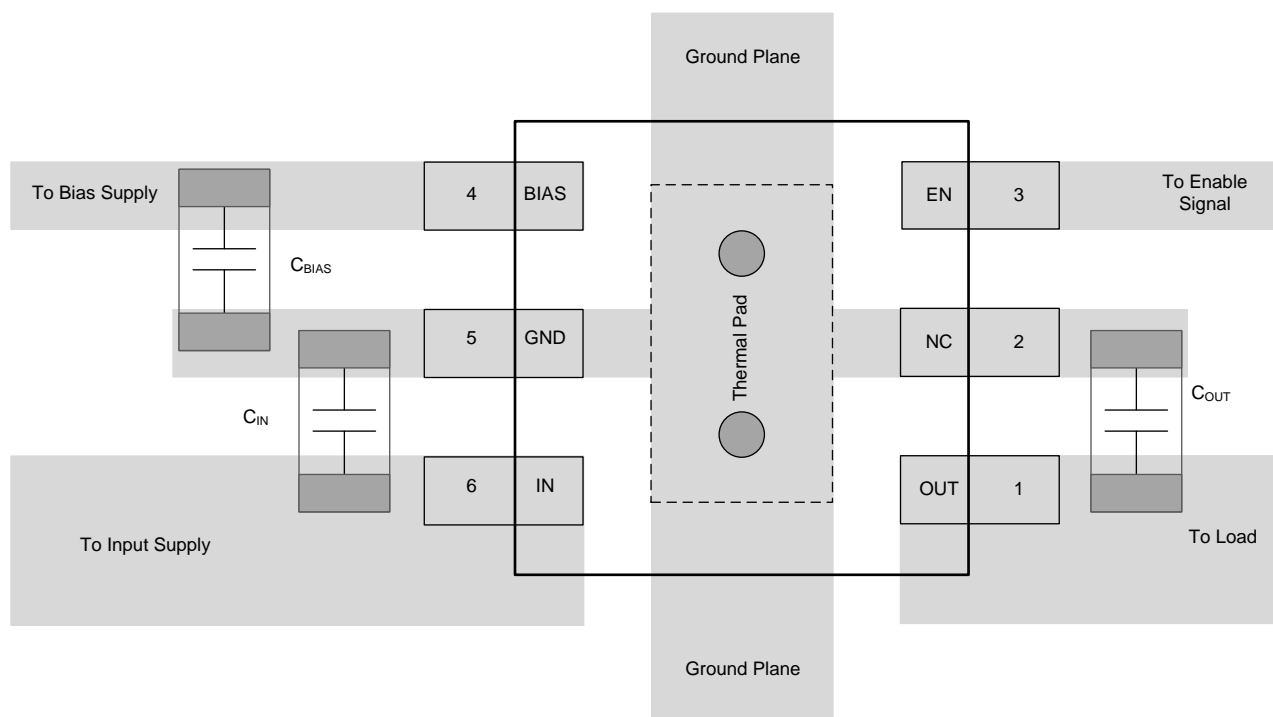

Figure 33. Recommended Layout

10.3 Thermal Considerations

Thermal protection disables the output when the junction temperature rises to approximately 160°C, allowing the device to cool. When the junction temperature cools to approximately 140°C, the output circuitry is again enabled. Depending on power dissipation, thermal resistance, and ambient temperature, the thermal protection circuit may cycle on and off. This cycling limits the dissipation of the regulator, protecting it from damage as a result of overheating.

Thermal Considerations (continued)

Any tendency to activate the thermal protection circuit indicates excessive power dissipation or an inadequate heatsink. For reliable operation, junction temperature should be limited to 125°C maximum. To estimate the margin of safety in a complete design (including heatsink), increase the ambient temperature until the thermal protection is triggered; use worst-case loads and signal conditions. For good reliability, thermal protection should trigger at least 35°C above the maximum expected ambient condition of the particular application. This configuration produces a worst-case junction temperature of 125°C at the highest expected ambient temperature and worst-case load.

The internal protection circuitry of the TPS720 has been designed to protect against overload conditions. It was not intended to replace proper heatsinking. Continuously running the TPS720 into thermal shutdown degrades device reliability.

10.4 Power Dissipation

The ability to remove heat from the die is different for each package type, presenting different considerations in the printed-circuit-board (PCB) layout. The PCB area around the device that is free of other components moves the heat from the device to the ambient air. Performance data for JEDEC low- and high-K boards are given in the [Thermal Information](#) table. Using heavier copper increases the effectiveness in removing heat from the device. The addition of plated through-holes to heat-dissipating layers also improves the heatsink effectiveness.

Power dissipation depends on input voltage and load conditions. Power dissipation (P_D) is equal to the product of the output current times the voltage drop across the output pass element (V_{IN} to V_{OUT}), as shown in [Equation 2](#):

$$P_D = (V_{IN} - V_{OUT}) \times I_{OUT} \quad (2)$$

11 Device and Documentation Support

11.1 Device Support

11.1.1 Development Support

11.1.1.1 Evaluation Module

An evaluation module (EVM) is available to assist in the initial circuit performance evaluation using the TPS720. The [TPS720xxDRVEVM evaluation module](#) (and [related user guide](#)) can be requested at the Texas Instruments website through the product folders or purchased directly from the [TI eStore](#).

11.1.2 Device Nomenclature

Table 2. Device Nomenclature⁽¹⁾⁽²⁾

PRODUCT	V _{OUT}
TPS720xx(x)	<p>xx(x) is the nominal output voltage. For output voltages with a resolution of 100 mV, two digits are used in the ordering number; otherwise, three digits are used (for example, 28 = 2.8 V; 125 = 1.25 V).</p> <p>yy is the package designator.</p> <p>z is the package quantity. R is for reel (3000 pieces), T is for tape (250 pieces).</p>

- (1) For the most current package and ordering information see the Package Option Addendum at the end of this document, or visit the device product folder on www.ti.com.
- (2) Output voltages from 0.9 V to 3.6 V in 50-mV increments are available. Contact the factory for details and availability.

11.2 Documentation Support

11.2.1 Related Documentation

For related documentation see the following:

- [TPS720xxDRVEVM Evaluation Module, SBVU024](#)
- [Using New Thermal Metrics, SBVA025](#)

11.3 Community Resources

The following links connect to TI community resources. Linked contents are provided "AS IS" by the respective contributors. They do not constitute TI specifications and do not necessarily reflect TI's views; see TI's [Terms of Use](#).

TI E2E™ Online Community *TI's Engineer-to-Engineer (E2E) Community*. Created to foster collaboration among engineers. At e2e.ti.com, you can ask questions, share knowledge, explore ideas and help solve problems with fellow engineers.

Design Support *TI's Design Support* Quickly find helpful E2E forums along with design support tools and contact information for technical support.

11.4 Trademarks

E2E is a trademark of Texas Instruments.
All other trademarks are the property of their respective owners.

11.5 Electrostatic Discharge Caution



These devices have limited built-in ESD protection. The leads should be shorted together or the device placed in conductive foam during storage or handling to prevent electrostatic damage to the MOS gates.

11.6 Glossary

[SLYZ022](#) — *TI Glossary*.

This glossary lists and explains terms, acronyms, and definitions.

12 Mechanical, Packaging, and Orderable Information

The following pages include mechanical, packaging, and orderable information. This information is the most current data available for the designated devices. This data is subject to change without notice and revision of this document. For browser-based versions of this data sheet, refer to the left-hand navigation.

12.1 Package Mounting

Solder pad footprint recommendations for the TPS720 are available from the Texas Instruments website at www.ti.com.

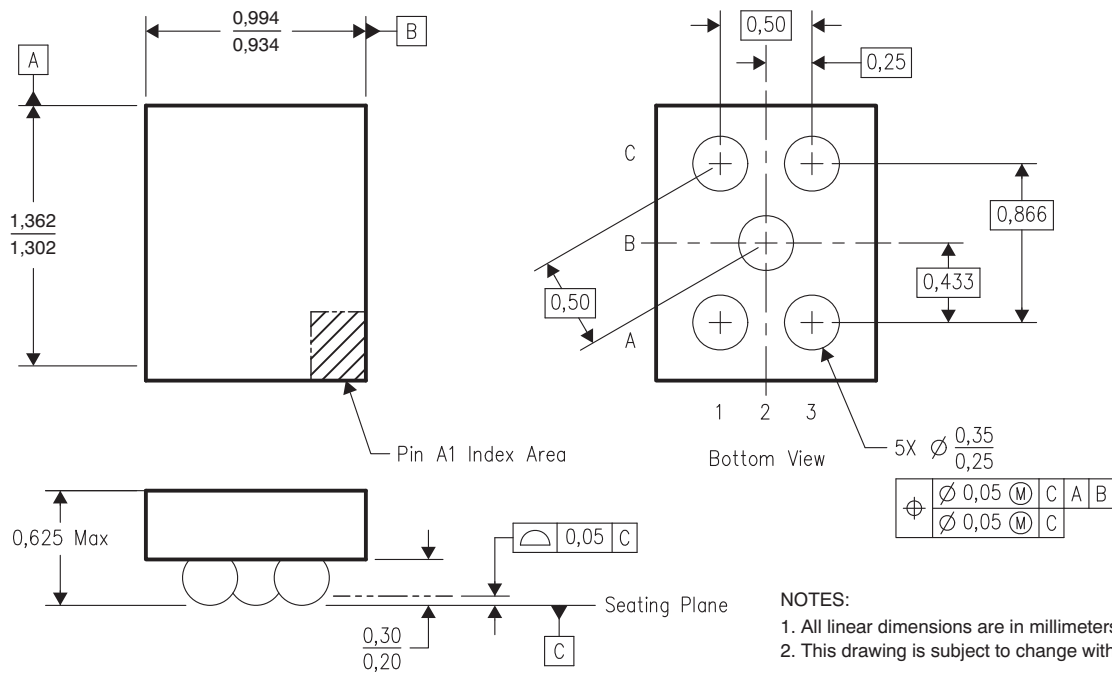

Figure 34. YZU Wafer Chip-Scale Package Dimensions (in mm)

PACKAGING INFORMATION

Orderable Device	Status (1)	Package Type	Package Drawing	Pins	Package Qty	Eco Plan (2)	Lead finish/ Ball material (6)	MSL Peak Temp (3)	Op Temp (°C)	Device Marking (4/5)	Samples
TPS72009YZUR	ACTIVE	DSBGA	YZU	5	3000	RoHS & Green	SNAGCU	Level-1-260C-UNLIM	-40 to 125	G3	Samples
TPS72009YZUT	ACTIVE	DSBGA	YZU	5	250	RoHS & Green	SNAGCU	Level-1-260C-UNLIM	-40 to 125	G3	Samples
TPS720102YZUR	ACTIVE	DSBGA	YZU	5	3000	RoHS & Green	SNAGCU	Level-1-260C-UNLIM	-40 to 125	DI	Samples
TPS720102YZUT	ACTIVE	DSBGA	YZU	5	250	RoHS & Green	SNAGCU	Level-1-260C-UNLIM	-40 to 125	DI	Samples
TPS720105DRVR	ACTIVE	WSO	DRV	6	3000	RoHS & Green	NIPDAU	Level-1-260C-UNLIM	-40 to 125	ODC	Samples
TPS720105DRVT	ACTIVE	WSO	DRV	6	250	RoHS & Green	NIPDAU	Level-1-260C-UNLIM	-40 to 125	ODC	Samples
TPS720105YZUR	ACTIVE	DSBGA	YZU	5	3000	RoHS & Green	SNAGCU	Level-1-260C-UNLIM	-40 to 125	NM	Samples
TPS720105YZUT	ACTIVE	DSBGA	YZU	5	250	RoHS & Green	SNAGCU	Level-1-260C-UNLIM	-40 to 125	NM	Samples
TPS72010DRVR	ACTIVE	WSO	DRV	6	3000	RoHS & Green	NIPDAU	Level-1-260C-UNLIM	-40 to 125	DAA	Samples
TPS72010DRVT	ACTIVE	WSO	DRV	6	250	RoHS & Green	NIPDAUAG	Level-1-260C-UNLIM	-40 to 125	DAA	Samples
TPS720115DRVR	ACTIVE	WSO	DRV	6	3000	RoHS & Green	NIPDAUAG	Level-1-260C-UNLIM	-40 to 125	SHP	Samples
TPS720115DRVT	ACTIVE	WSO	DRV	6	250	RoHS & Green	NIPDAUAG	Level-1-260C-UNLIM	-40 to 125	SHP	Samples
TPS72011DRVR	ACTIVE	WSO	DRV	6	3000	RoHS & Green	NIPDAUAG	Level-1-260C-UNLIM	-40 to 125	PAR	Samples
TPS72011DRVT	ACTIVE	WSO	DRV	6	250	RoHS & Green	NIPDAUAG	Level-1-260C-UNLIM	-40 to 125	PAR	Samples
TPS72011YZUR	ACTIVE	DSBGA	YZU	5	3000	RoHS & Green	SNAGCU	Level-1-260C-UNLIM	-40 to 125	BQ	Samples
TPS72011YZUT	ACTIVE	DSBGA	YZU	5	250	RoHS & Green	SNAGCU	Level-1-260C-UNLIM	-40 to 125	BQ	Samples
TPS72012DRVR	ACTIVE	WSO	DRV	6	3000	RoHS & Green	NIPDAUAG	Level-1-260C-UNLIM	-40 to 125	DAB	Samples
TPS72012DRVT	ACTIVE	WSO	DRV	6	250	RoHS & Green	NIPDAUAG	Level-1-260C-UNLIM	-40 to 125	DAB	Samples
TPS72012YZUR	ACTIVE	DSBGA	YZU	5	3000	RoHS & Green	SNAGCU	Level-1-260C-UNLIM	-40 to 125	NN	Samples
TPS72012YZUT	ACTIVE	DSBGA	YZU	5	250	RoHS & Green	SNAGCU	Level-1-260C-UNLIM	-40 to 125	NN	Samples

Orderable Device	Status (1)	Package Type	Package Drawing	Pins	Package Qty	Eco Plan (2)	Lead finish/ Ball material (6)	MSL Peak Temp (3)	Op Temp (°C)	Device Marking (4/5)	Samples
TPS720132YZUR	ACTIVE	DSBGA	YZU	5	3000	RoHS & Green	SNAGCU	Level-1-260C-UNLIM	-40 to 125	7J	Samples
TPS720132YZUT	ACTIVE	DSBGA	YZU	5	250	RoHS & Green	SNAGCU	Level-1-260C-UNLIM	-40 to 125	7J	Samples
TPS72013YZUR	ACTIVE	DSBGA	YZU	5	3000	RoHS & Green	SNAGCU	Level-1-260C-UNLIM	-40 to 125	FS	Samples
TPS72013YZUT	ACTIVE	DSBGA	YZU	5	250	RoHS & Green	SNAGCU	Level-1-260C-UNLIM	-40 to 125	FS	Samples
TPS72015DRVR	ACTIVE	WSON	DRV	6	3000	RoHS & Green	NIPDAU	Level-1-260C-UNLIM	-40 to 125	DAC	Samples
TPS72015DRVT	ACTIVE	WSON	DRV	6	250	RoHS & Green	NIPDAU	Level-1-260C-UNLIM	-40 to 125	DAC	Samples
TPS72015YZUR	ACTIVE	DSBGA	YZU	5	3000	RoHS & Green	SNAGCU	Level-1-260C-UNLIM	-40 to 125	FT	Samples
TPS72015YZUT	ACTIVE	DSBGA	YZU	5	250	RoHS & Green	SNAGCU	Level-1-260C-UNLIM	-40 to 125	FT	Samples
TPS72017YZUR	ACTIVE	DSBGA	YZU	5	3000	RoHS & Green	SNAGCU	Level-1-260C-UNLIM	-40 to 125	GC	Samples
TPS72017YZUT	ACTIVE	DSBGA	YZU	5	250	RoHS & Green	SNAGCU	Level-1-260C-UNLIM	-40 to 125	GC	Samples
TPS72018DRVR	ACTIVE	WSON	DRV	6	3000	RoHS & Green	NIPDAUAG	Level-1-260C-UNLIM	-40 to 125	DAD	Samples
TPS72018DRVT	ACTIVE	WSON	DRV	6	250	RoHS & Green	NIPDAUAG	Level-1-260C-UNLIM	-40 to 125	DAD	Samples
TPS72018YZUR	ACTIVE	DSBGA	YZU	5	3000	RoHS & Green	SNAGCU	Level-1-260C-UNLIM	-40 to 125	GD	Samples
TPS72018YZUT	ACTIVE	DSBGA	YZU	5	250	RoHS & Green	SNAGCU	Level-1-260C-UNLIM	-40 to 125	GD	Samples
TPS72023YZUR	ACTIVE	DSBGA	YZU	5	3000	RoHS & Green	SNAGCU	Level-1-260C-UNLIM	-40 to 125	6F	Samples
TPS72023YZUT	ACTIVE	DSBGA	YZU	5	250	RoHS & Green	SNAGCU	Level-1-260C-UNLIM	-40 to 125	6F	Samples

(1) The marketing status values are defined as follows:

ACTIVE: Product device recommended for new designs.

LIFEBUY: TI has announced that the device will be discontinued, and a lifetime-buy period is in effect.

NRND: Not recommended for new designs. Device is in production to support existing customers, but TI does not recommend using this part in a new design.

PREVIEW: Device has been announced but is not in production. Samples may or may not be available.

OBSOLETE: TI has discontinued the production of the device.

(2) **RoHS:** TI defines "RoHS" to mean semiconductor products that are compliant with the current EU RoHS requirements for all 10 RoHS substances, including the requirement that RoHS substance do not exceed 0.1% by weight in homogeneous materials. Where designed to be soldered at high temperatures, "RoHS" products are suitable for use in specified lead-free processes. TI may reference these types of products as "Pb-Free".

RoHS Exempt: TI defines "RoHS Exempt" to mean products that contain lead but are compliant with EU RoHS pursuant to a specific EU RoHS exemption.

Green: TI defines "Green" to mean the content of Chlorine (Cl) and Bromine (Br) based flame retardants meet JS709B low halogen requirements of ≤ 1000 ppm threshold. Antimony trioxide based flame retardants must also meet the ≤ 1000 ppm threshold requirement.

(3) MSL, Peak Temp. - The Moisture Sensitivity Level rating according to the JEDEC industry standard classifications, and peak solder temperature.

(4) There may be additional marking, which relates to the logo, the lot trace code information, or the environmental category on the device.

(5) Multiple Device Markings will be inside parentheses. Only one Device Marking contained in parentheses and separated by a "~" will appear on a device. If a line is indented then it is a continuation of the previous line and the two combined represent the entire Device Marking for that device.

(6) Lead finish/Ball material - Orderable Devices may have multiple material finish options. Finish options are separated by a vertical ruled line. Lead finish/Ball material values may wrap to two lines if the finish value exceeds the maximum column width.

Important Information and Disclaimer: The information provided on this page represents TI's knowledge and belief as of the date that it is provided. TI bases its knowledge and belief on information provided by third parties, and makes no representation or warranty as to the accuracy of such information. Efforts are underway to better integrate information from third parties. TI has taken and continues to take reasonable steps to provide representative and accurate information but may not have conducted destructive testing or chemical analysis on incoming materials and chemicals. TI and TI suppliers consider certain information to be proprietary, and thus CAS numbers and other limited information may not be available for release.

In no event shall TI's liability arising out of such information exceed the total purchase price of the TI part(s) at issue in this document sold by TI to Customer on an annual basis.

OTHER QUALIFIED VERSIONS OF TPS720 :

- Automotive : [TPS720-Q1](#)

NOTE: Qualified Version Definitions:

- Automotive - Q100 devices qualified for high-reliability automotive applications targeting zero defects

TAPE AND REEL INFORMATION

QUADRANT ASSIGNMENTS FOR PIN 1 ORIENTATION IN TAPE

*All dimensions are nominal

Device	Package Type	Package Drawing	Pins	SPQ	Reel Diameter (mm)	Reel Width W1 (mm)	A0 (mm)	B0 (mm)	K0 (mm)	P1 (mm)	W (mm)	Pin1 Quadrant
TPS72009YZUR	DSBGA	YZU	5	3000	180.0	8.4	1.07	1.42	0.74	4.0	8.0	Q1
TPS72009YZUT	DSBGA	YZU	5	250	180.0	8.4	1.07	1.42	0.74	4.0	8.0	Q1
TPS720102YZUR	DSBGA	YZU	5	3000	180.0	8.4	1.07	1.42	0.74	4.0	8.0	Q1
TPS720102YZUT	DSBGA	YZU	5	250	180.0	8.4	1.07	1.42	0.74	4.0	8.0	Q1
TPS720105DRVR	WSO	DRV	6	3000	180.0	8.4	2.3	2.3	1.15	4.0	8.0	Q2
TPS720105DRVR	WSO	DRV	6	3000	179.0	8.4	2.2	2.2	1.2	4.0	8.0	Q2
TPS720105DRVT	WSO	DRV	6	250	179.0	8.4	2.2	2.2	1.2	4.0	8.0	Q2
TPS720105DRVT	WSO	DRV	6	250	180.0	8.4	2.3	2.3	1.15	4.0	8.0	Q2
TPS720105YZUR	DSBGA	YZU	5	3000	180.0	8.4	1.07	1.42	0.74	4.0	8.0	Q1
TPS720105YZUT	DSBGA	YZU	5	250	180.0	8.4	1.07	1.42	0.74	4.0	8.0	Q1
TPS72010DRVR	WSO	DRV	6	3000	179.0	8.4	2.2	2.2	1.2	4.0	8.0	Q2
TPS72010DRVT	WSO	DRV	6	250	179.0	8.4	2.2	2.2	1.2	4.0	8.0	Q2
TPS720115DRVR	WSO	DRV	6	3000	179.0	8.4	2.2	2.2	1.2	4.0	8.0	Q2
TPS720115DRVT	WSO	DRV	6	250	179.0	8.4	2.2	2.2	1.2	4.0	8.0	Q2
TPS72011DRVR	WSO	DRV	6	3000	179.0	8.4	2.2	2.2	1.2	4.0	8.0	Q2
TPS72011DRVT	WSO	DRV	6	250	179.0	8.4	2.2	2.2	1.2	4.0	8.0	Q2
TPS72011YZUR	DSBGA	YZU	5	3000	180.0	8.4	1.07	1.42	0.74	4.0	8.0	Q1
TPS72011YZUT	DSBGA	YZU	5	250	180.0	8.4	1.07	1.42	0.74	4.0	8.0	Q1

Device	Package Type	Package Drawing	Pins	SPQ	Reel Diameter (mm)	Reel Width W1 (mm)	A0 (mm)	B0 (mm)	K0 (mm)	P1 (mm)	W (mm)	Pin1 Quadrant
TPS72012DRVR	WSO	DRV	6	3000	179.0	8.4	2.2	2.2	1.2	4.0	8.0	Q2
TPS72012DRVT	WSO	DRV	6	250	179.0	8.4	2.2	2.2	1.2	4.0	8.0	Q2
TPS72012YZUR	DSBGA	YZU	5	3000	180.0	8.4	1.07	1.42	0.74	4.0	8.0	Q1
TPS72012YZUT	DSBGA	YZU	5	250	180.0	8.4	1.07	1.42	0.74	4.0	8.0	Q1
TPS720132YZUR	DSBGA	YZU	5	3000	180.0	8.4	1.07	1.42	0.74	4.0	8.0	Q1
TPS720132YZUT	DSBGA	YZU	5	250	180.0	8.4	1.07	1.42	0.74	4.0	8.0	Q1
TPS72013YZUR	DSBGA	YZU	5	3000	180.0	8.4	1.07	1.42	0.74	4.0	8.0	Q1
TPS72013YZUT	DSBGA	YZU	5	250	180.0	8.4	1.07	1.42	0.74	4.0	8.0	Q1
TPS72015DRVR	WSO	DRV	6	3000	180.0	8.4	2.3	2.3	1.15	4.0	8.0	Q2
TPS72015DRVT	WSO	DRV	6	250	179.0	8.4	2.2	2.2	1.2	4.0	8.0	Q2
TPS72015YZUR	DSBGA	YZU	5	3000	180.0	8.4	1.07	1.42	0.74	4.0	8.0	Q1
TPS72015YZUT	DSBGA	YZU	5	250	180.0	8.4	1.07	1.42	0.74	4.0	8.0	Q1
TPS72017YZUR	DSBGA	YZU	5	3000	180.0	8.4	1.07	1.42	0.74	4.0	8.0	Q1
TPS72017YZUT	DSBGA	YZU	5	250	180.0	8.4	1.07	1.42	0.74	4.0	8.0	Q1
TPS72018DRVR	WSO	DRV	6	3000	179.0	8.4	2.2	2.2	1.2	4.0	8.0	Q2
TPS72018DRVT	WSO	DRV	6	250	179.0	8.4	2.2	2.2	1.2	4.0	8.0	Q2
TPS72018YZUR	DSBGA	YZU	5	3000	180.0	8.4	1.07	1.42	0.74	4.0	8.0	Q1
TPS72018YZUT	DSBGA	YZU	5	250	180.0	8.4	1.07	1.42	0.74	4.0	8.0	Q1
TPS72023YZUR	DSBGA	YZU	5	3000	180.0	8.4	1.07	1.42	0.74	4.0	8.0	Q1
TPS72023YZUT	DSBGA	YZU	5	250	180.0	8.4	1.07	1.42	0.74	4.0	8.0	Q1

TAPE AND REEL BOX DIMENSIONS

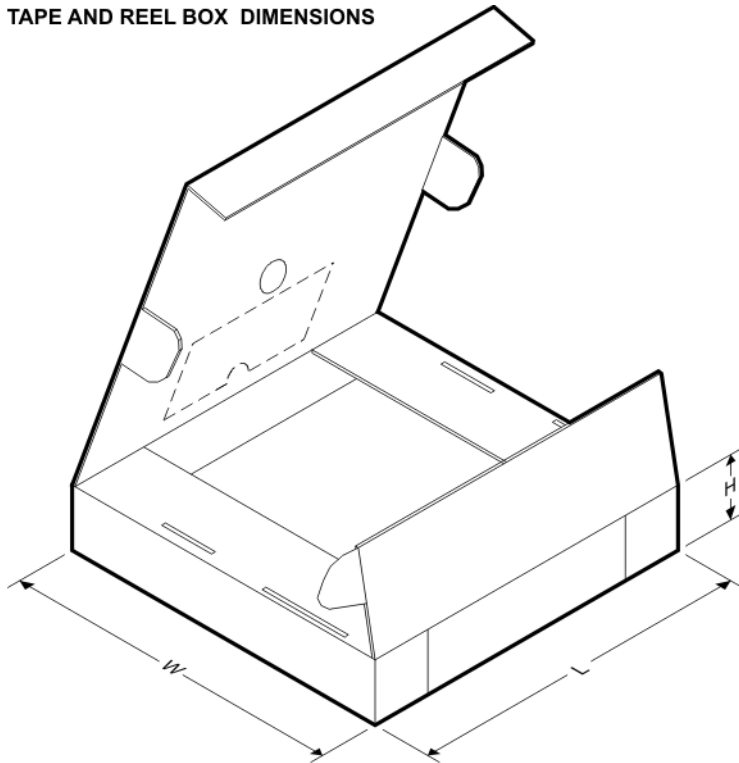

*All dimensions are nominal

Device	Package Type	Package Drawing	Pins	SPQ	Length (mm)	Width (mm)	Height (mm)
TPS72009YZUR	DSBGA	YZU	5	3000	182.0	182.0	20.0
TPS72009YZUT	DSBGA	YZU	5	250	182.0	182.0	20.0
TPS720102YZUR	DSBGA	YZU	5	3000	182.0	182.0	20.0
TPS720102YZUT	DSBGA	YZU	5	250	182.0	182.0	20.0
TPS720105DRVR	WSON	DRV	6	3000	182.0	182.0	20.0
TPS720105DRVR	WSON	DRV	6	3000	200.0	183.0	25.0
TPS720105DRVT	WSON	DRV	6	250	200.0	183.0	25.0
TPS720105DRVT	WSON	DRV	6	250	182.0	182.0	20.0
TPS720105YZUR	DSBGA	YZU	5	3000	182.0	182.0	20.0
TPS720105YZUT	DSBGA	YZU	5	250	182.0	182.0	20.0
TPS72010DRVR	WSON	DRV	6	3000	200.0	183.0	25.0
TPS72010DRVT	WSON	DRV	6	250	200.0	183.0	25.0
TPS720115DRVR	WSON	DRV	6	3000	203.0	203.0	35.0
TPS720115DRVT	WSON	DRV	6	250	203.0	203.0	35.0
TPS72011DRVR	WSON	DRV	6	3000	200.0	183.0	25.0
TPS72011DRVT	WSON	DRV	6	250	200.0	183.0	25.0
TPS72011YZUR	DSBGA	YZU	5	3000	182.0	182.0	20.0
TPS72011YZUT	DSBGA	YZU	5	250	182.0	182.0	20.0
TPS72012DRVR	WSON	DRV	6	3000	200.0	183.0	25.0
TPS72012DRVT	WSON	DRV	6	250	200.0	183.0	25.0
TPS72012YZUR	DSBGA	YZU	5	3000	182.0	182.0	20.0
TPS72012YZUT	DSBGA	YZU	5	250	182.0	182.0	20.0
TPS720132YZUR	DSBGA	YZU	5	3000	182.0	182.0	20.0
TPS720132YZUT	DSBGA	YZU	5	250	182.0	182.0	20.0
TPS72013YZUR	DSBGA	YZU	5	3000	182.0	182.0	20.0
TPS72013YZUT	DSBGA	YZU	5	250	182.0	182.0	20.0
TPS72015DRVR	WSON	DRV	6	3000	182.0	182.0	20.0
TPS72015DRVT	WSON	DRV	6	250	203.0	203.0	35.0
TPS72015YZUR	DSBGA	YZU	5	3000	210.0	185.0	35.0
TPS72015YZUT	DSBGA	YZU	5	250	210.0	185.0	35.0
TPS72017YZUR	DSBGA	YZU	5	3000	210.0	185.0	35.0
TPS72017YZUT	DSBGA	YZU	5	250	210.0	185.0	35.0
TPS72018DRVR	WSON	DRV	6	3000	200.0	183.0	25.0
TPS72018DRVT	WSON	DRV	6	250	203.0	203.0	35.0
TPS72018YZUR	DSBGA	YZU	5	3000	210.0	185.0	35.0
TPS72018YZUT	DSBGA	YZU	5	250	210.0	185.0	35.0
TPS72023YZUR	DSBGA	YZU	5	3000	182.0	182.0	20.0
TPS72023YZUT	DSBGA	YZU	5	250	182.0	182.0	20.0

GENERIC PACKAGE VIEW

DRV 6

WSON - 0.8 mm max height

PLASTIC SMALL OUTLINE - NO LEAD



Images above are just a representation of the package family, actual package may vary.
Refer to the product data sheet for package details.

4206925/F



4222173/B 04/2018

NOTES:

1. All linear dimensions are in millimeters. Any dimensions in parenthesis are for reference only. Dimensioning and tolerancing per ASME Y14.5M.
2. This drawing is subject to change without notice.
3. The package thermal pad must be soldered to the printed circuit board for thermal and mechanical performance.

EXAMPLE BOARD LAYOUT

DRV0006A

WSON - 0.8 mm max height

PLASTIC SMALL OUTLINE - NO LEAD



LAND PATTERN EXAMPLE
SCALE:25X



SOLDER MASK DETAILS

4222173/B 04/2018

NOTES: (continued)

4. This package is designed to be soldered to a thermal pad on the board. For more information, see Texas Instruments literature number SLUA271 (www.ti.com/lit/sl原因271).
5. Vias are optional depending on application, refer to device data sheet. If some or all are implemented, recommended via locations are shown.

EXAMPLE STENCIL DESIGN

DRV0006A

WSON - 0.8 mm max height

PLASTIC SMALL OUTLINE - NO LEAD



SOLDER PASTE EXAMPLE
BASED ON 0.125 mm THICK STENCIL

EXPOSED PAD #7
88% PRINTED SOLDER COVERAGE BY AREA UNDER PACKAGE
SCALE:30X

4222173/B 04/2018

NOTES: (continued)

6. Laser cutting apertures with trapezoidal walls and rounded corners may offer better paste release. IPC-7525 may have alternate design recommendations.



4225563/A 12/2019

NOTES:

1. All linear dimensions are in millimeters. Any dimensions in parenthesis are for reference only. Dimensioning and tolerancing per ASME Y14.5M.
2. This drawing is subject to change without notice.
3. The package thermal pad must be soldered to the printed circuit board for thermal and mechanical performance.

EXAMPLE BOARD LAYOUT

DRV0006D

WSON - 0.8 mm max height

PLASTIC SMALL OUTLINE - NO LEAD



LAND PATTERN EXAMPLE
EXPOSED METAL SHOWN
SCALE:25X



SOLDER MASK DETAILS

4225563/A 12/2019

NOTES: (continued)

4. This package is designed to be soldered to a thermal pad on the board. For more information, see Texas Instruments literature number SLUA271 (www.ti.com/lit/sluea271).
5. Vias are optional depending on application, refer to device data sheet. If some or all are implemented, recommended via locations are shown.

EXAMPLE STENCIL DESIGN

DRV0006D

WSON - 0.8 mm max height

PLASTIC SMALL OUTLINE - NO LEAD



SOLDER PASTE EXAMPLE
BASED ON 0.125 mm THICK STENCIL

EXPOSED PAD #7
88% PRINTED SOLDER COVERAGE BY AREA UNDER PACKAGE
SCALE:30X

4225563/A 12/2019

NOTES: (continued)

6. Laser cutting apertures with trapezoidal walls and rounded corners may offer better paste release. IPC-7525 may have alternate design recommendations.

YZU0005

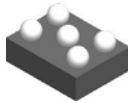

PACKAGE OUTLINE

DSBGA - 0.625 mm max height

DIE SIZE BALL GRID ARRAY

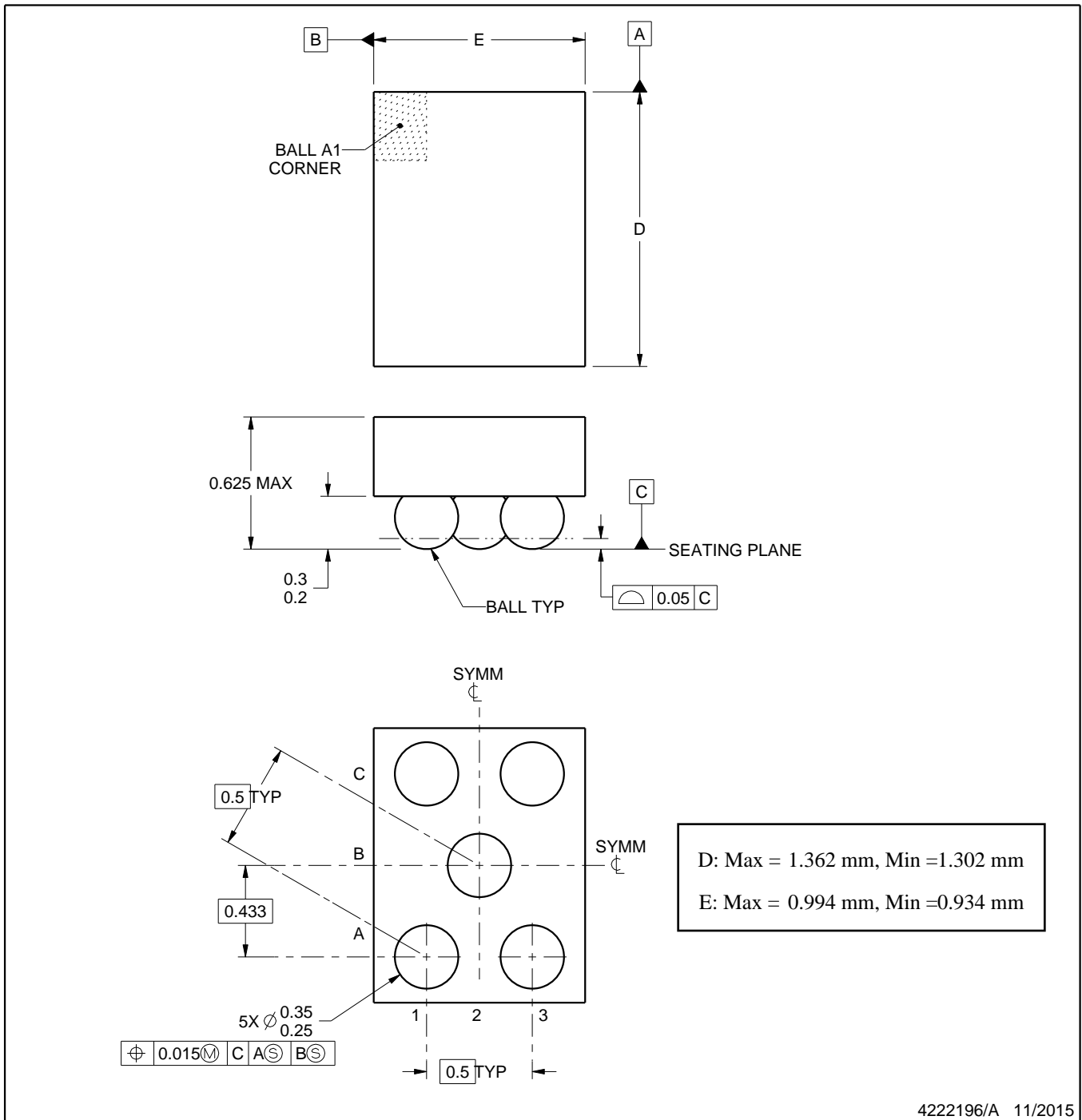

NOTES:

1. All linear dimensions are in millimeters. Any dimensions in parenthesis are for reference only. Dimensioning and tolerancing per ASME Y14.5M.
2. This drawing is subject to change without notice.

EXAMPLE BOARD LAYOUT

YZU0005

DSBGA - 0.625 mm max height

DIE SIZE BALL GRID ARRAY

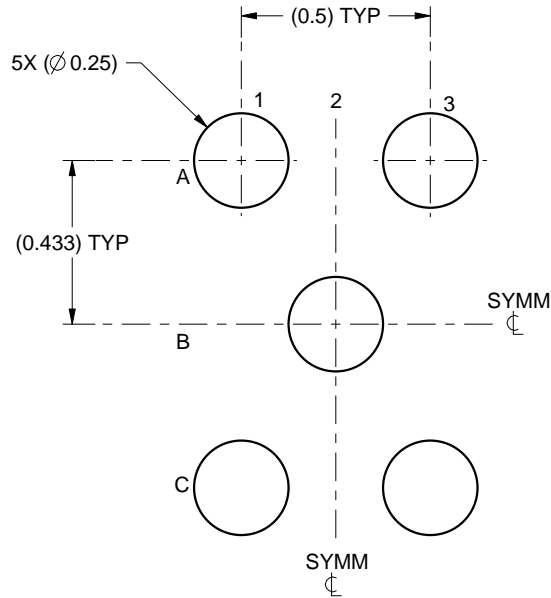

LAND PATTERN EXAMPLE
SCALE:50X

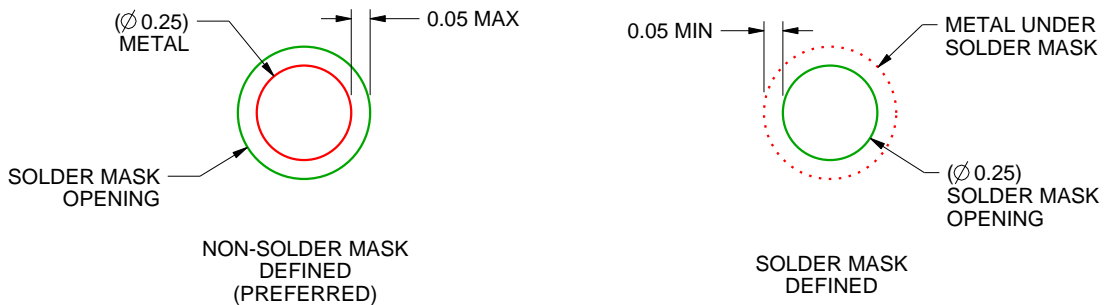

SOLDER MASK DETAILS
NOT TO SCALE

4222196/A 11/2015

NOTES: (continued)

3. Final dimensions may vary due to manufacturing tolerance considerations and also routing constraints. Refer to Texas Instruments Literature No. SNVA009 (www.ti.com/lit/snva009).

EXAMPLE STENCIL DESIGN

YZU0005

DSBGA - 0.625 mm max height

DIE SIZE BALL GRID ARRAY

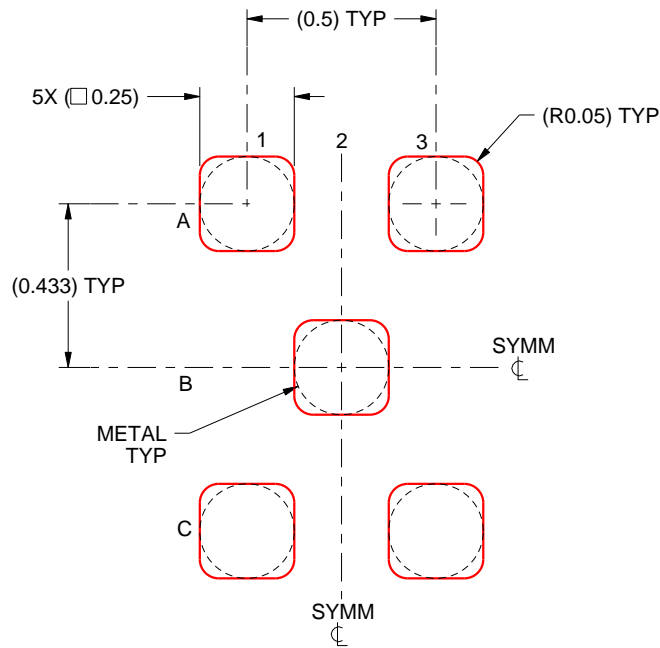

SOLDER PASTE EXAMPLE
BASED ON 0.1 mm THICK STENCIL
SCALE:50X

4222196/A 11/2015

NOTES: (continued)

4. Laser cutting apertures with trapezoidal walls and rounded corners may offer better paste release.

IMPORTANT NOTICE AND DISCLAIMER

TI PROVIDES TECHNICAL AND RELIABILITY DATA (INCLUDING DATA SHEETS), DESIGN RESOURCES (INCLUDING REFERENCE DESIGNS), APPLICATION OR OTHER DESIGN ADVICE, WEB TOOLS, SAFETY INFORMATION, AND OTHER RESOURCES "AS IS" AND WITH ALL FAULTS, AND DISCLAIMS ALL WARRANTIES, EXPRESS AND IMPLIED, INCLUDING WITHOUT LIMITATION ANY IMPLIED WARRANTIES OF MERCHANTABILITY, FITNESS FOR A PARTICULAR PURPOSE OR NON-INFRINGEMENT OF THIRD PARTY INTELLECTUAL PROPERTY RIGHTS.

These resources are intended for skilled developers designing with TI products. You are solely responsible for (1) selecting the appropriate TI products for your application, (2) designing, validating and testing your application, and (3) ensuring your application meets applicable standards, and any other safety, security, regulatory or other requirements.

These resources are subject to change without notice. TI grants you permission to use these resources only for development of an application that uses the TI products described in the resource. Other reproduction and display of these resources is prohibited. No license is granted to any other TI intellectual property right or to any third party intellectual property right. TI disclaims responsibility for, and you will fully indemnify TI and its representatives against, any claims, damages, costs, losses, and liabilities arising out of your use of these resources.

TI's products are provided subject to [TI's Terms of Sale](#) or other applicable terms available either on ti.com or provided in conjunction with such TI products. TI's provision of these resources does not expand or otherwise alter TI's applicable warranties or warranty disclaimers for TI products.

TI objects to and rejects any additional or different terms you may have proposed.

Mailing Address: Texas Instruments, Post Office Box 655303, Dallas, Texas 75265
Copyright © 2022, Texas Instruments Incorporated