

具有高 CMTI 的 AMC1306x 小型、高精度、增强型 隔离式 Δ - Σ 调制器

1 特性

- 针对基于分流电阻器的电流测量进行优化的引脚兼容系列：
 - 输入电压范围为 $\pm 50\text{mV}$ 或 $\pm 250\text{mV}$
 - 曼彻斯特编码或未编码的位流选项
- 出色的直流性能：
 - 失调电压误差： $\pm 50\mu\text{V}$ 或 $\pm 100\mu\text{V}$ （最大值）
 - 温漂： $1\mu\text{V}/^\circ\text{C}$ （最大值）
 - 增益误差： $\pm 0.2\%$ （最大值）
 - 增益漂移： $\pm 40\text{ppm}/^\circ\text{C}$ （最大值）
- 瞬态抗扰性： $100\text{kV}/\mu\text{s}$ （典型值）
- 系统级诊断功能
- 安全相关认证：
 - $7000\text{V}_{\text{PEAK}}$ 增强型隔离，符合 DIN VDE V 0884-11: 2017-01 标准
 - 符合 UL1577 标准且长达 1 分钟的 $5000\text{V}_{\text{RMS}}$ 隔离
 - 符合 CAN/CSA No. 5A 组件验收服务通知和 IEC 62368-1 终端设备标准
- 完整的额定工作温度范围： -40°C 至 $+125^\circ\text{C}$

2 应用

- 基于分流电阻器的电流感应和隔离式电压测量，包括：
 - 工业电机驱动
 - 光电逆变器
 - 不间断电源

3 说明

AMC1306 是一款高精度 Δ - Σ 调制器，通过抗电磁干扰性能极强的电容式双隔离层将输出与输入电路隔离开。该隔离层经过认证，可以按照 DIN VDE V 0884-11 和 UL1577 标准提供高达 $7000\text{V}_{\text{PEAK}}$ 的增强型隔离。与隔离式电源结合使用时，该隔离式调制器可将以不同共模电压等级运行的系统的各器件隔离，并防止较低电压器件损坏。

AMC1306 的输入针对直接连接分流电阻器或其他低电压等级信号源进行了优化。器件具有独特的 $\pm 50\text{mV}$ 低输入电压范围，可通过分流器显著降低功率耗散，同时具有出色的交流和直流性能。AMC1306 的输出位流采用曼彻斯特编码 (AMC1306Ex) 或未编码 (AMC1306Mx)，具体情况因导数而异。通过使用集成式数字滤波器（如 TMS320F2807x 或 TMS320F2837x 微控制器系列中的滤波器）来抽取位流，该器件可在 78kSPS 数据速率下实现 85dB 动态范围的 16 位分辨率。

曼彻斯特编码的 AMC1306Ex 版本的位流输出支持单线数据和时钟传输，无需考虑接收设备的设置和保持时间要求。

器件信息⁽¹⁾

器件型号	封装	封装尺寸（标称值）
AMC1306x	SOIC (8)	5.85mm × 7.50mm

(1) 如需了解所有可用封装，请参阅数据表末尾的可订购产品附录。

简化原理图

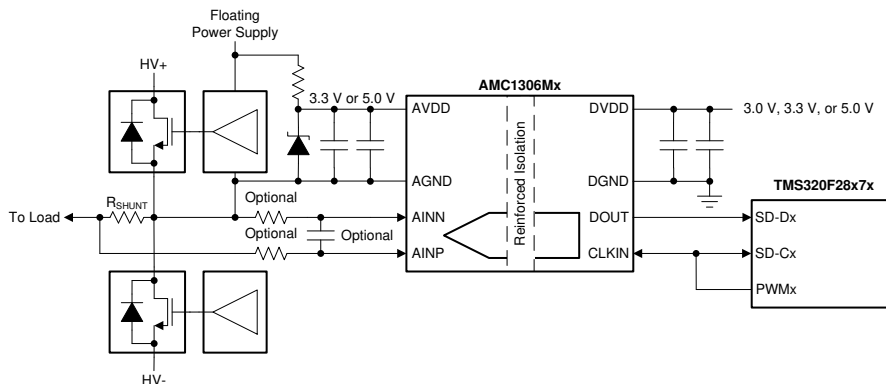

目录

1 特性	1	8.1 Overview	21
2 应用	1	8.2 Functional Block Diagram	21
3 说明	1	8.3 Feature Description	22
4 修订历史记录	2	8.4 Device Functional Modes	26
5 Device Comparison Table	4	9 Application and Implementation	27
6 Pin Configuration and Functions	4	9.1 Application Information	27
7 Specifications	5	9.2 Typical Applications	28
7.1 Absolute Maximum Ratings	5	10 Power Supply Recommendations	33
7.2 ESD Ratings	5	11 Layout	34
7.3 Recommended Operating Conditions	5	11.1 Layout Guidelines	34
7.4 Thermal Information	5	11.2 Layout Example	34
7.5 Power Ratings	5	12 器件和文档支持	35
7.6 Insulation Specifications	6	12.1 器件支持	35
7.7 Safety-Related Certifications	7	12.2 文档支持	35
7.8 Safety Limiting Values	7	12.3 相关链接	35
7.9 Electrical Characteristics: AMC1306x05	8	12.4 接收文档更新通知	35
7.10 Electrical Characteristics: AMC1306x25	10	12.5 社区资源	35
7.11 Switching Characteristics	12	12.6 商标	35
7.12 Insulation Characteristics Curves	13	12.7 静电放电警告	35
7.13 Typical Characteristics	14	12.8 Glossary	36
8 Detailed Description	21	13 机械、封装和可订购信息	36

4 修订历史记录

Changes from Revision B (June 2018) to Revision C	Page
• 已更改 更改了安全相关认证 项目符号（位于特性 部分）：将 VDE 认证 版本从 DIN V VDE V 0884-10 (VDE V 0884-11) 更改为 DIN VDE V 0884-11，并将 IEC 60950-1 和 IEC 60065 更改为 IEC 62368-1	1
• 已更改 将 DIN V VDE V 更改为 DIN VDE V（位于说明 部分）	1
• Changed CLR and CPG values from ≥ 9 mm to ≥ 8.5 mm in <i>Insulation Specifications</i> table	6
• Changed <i>Insulation Specifications</i> table header row from DIN V VDE V 0884-11 (VDE V 0884-11): 2017-01 to DIN VDE V 0884-11: 2017-01	6
• Changed VDE certification details in <i>Safety-Related Certifications</i> table	7
• Changed <i>Safety Limiting Values</i> table format as per current standard	7
• Changed <i>free air</i> to <i>ambient</i> in condition statement of <i>Switching Characteristics</i> table	12
• Changed 6.05 dB to 6.02 dB in Equation 3	27
• Changed input common-mode voltage from 2 V to 1.9 V for consistency with <i>Input Bias Current vs Common-Mode Input Voltage</i> figure in <i>What To Do and What Not To Do</i> section	32
• Changed VINx to AINx in <i>Layout Guidelines</i> section	34
• Changed <i>Recommended Layout of the AMC1306x</i> figure to include connection to the shunt resistor and input filter components	34

Changes from Revision A (July 2017) to Revision B	Page
• Changed <i>Reinforced Isolation Capacitor Lifetime Projection</i> figure	13

Changes from Original (March 2017) to Revision A	Page
• AMC1306E05 和 AMC1306M05 已投入生产	1
• 已添加 向第一个直流性能 子项目符号中添加了 $\pm 50\mu\text{V}$ ，以反映 AMC1306x05 器件的情况	1
• 已更改 将第一个安全相关认证 子项目符号中的标准偏差从 0884-10 更改为 0884-11	1

• 已更改 将 V_{PEAK} 从 8000 更改为 7000, 将标准偏差从 0884-10 变更为 0884-11 (均位于说明 部分的第一段)	1
• Deleted Status column from <i>Device Comparison Table</i>	4
• Changed standard deviation from 0884-10 to 0884-11 in <i>DIN V VDE V 0884-11</i> section of <i>Insulation Specifications</i> table	6
• Changed standard deviation from 0884-10 to 0884-11 in <i>Safety-Related Certifications</i> table	7
• Changed <i>prevent</i> to <i>minimize</i> in condition statement of <i>Safety Limiting Values</i> table.....	7
• Added <i>Electrical Characteristics: AMC1306x05</i> table	8
• Changed test conditions of Analog Inputs test conditions from $(AINP - AINN) / 2$ to AGND to $(AINP + AINN) / 2$ to AGND to include all possible conditions.....	10
• Changed I_{IB} test condition from <i>Inputs shorted to AGND</i> to $AINP = AINN = AGND, I_{IB} = I_{IBP} + I_{IBN}$	10
• Added $AINP = AINN = AGND$ to E_O parameter test conditions	10
• Changed minus sign to plus or minus sign in typical specification of E_G parameter	10
• Changed <i>10% to 90%</i> to <i>90% to 10%</i> in test conditions of t_f parameter	12
• Added AMC1306x05 devices to <i>Typical Characteristics</i> section	14

5 Device Comparison Table

PART NUMBER	INPUT VOLTAGE RANGE	DIFFERENTIAL INPUT RESISTANCE	DIGITAL OUTPUT INTERFACE
AMC1306E05	±50 mV	4.9 kΩ	Manchester coded CMOS
AMC1306E25	±250 mV	22 kΩ	Manchester coded CMOS
AMC1306M05	±50 mV	4.9 kΩ	Uncoded CMOS
AMC1306M25	±250 mV	22 kΩ	Uncoded CMOS

6 Pin Configuration and Functions

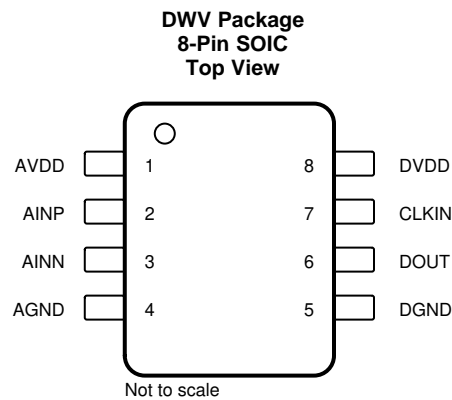

Pin Functions

PIN		I/O	DESCRIPTION
NO.	NAME		
1	AVDD	—	Analog (high-side) power supply, 3.0 V to 5.5 V. See the Power Supply Recommendations section for decoupling recommendations.
2	AINP	I	Noninverting analog input
3	AINN	I	Inverting analog input
4	AGND	—	Analog (high-side) ground reference
5	DGND	—	Digital (controller-side) ground reference
6	DOUT	O	Modulator data output. This pin is a Manchester coded output for AMC1306Ex derivatives.
7	CLKIN	I	Modulator clock input: 5 MHz to 21 MHz (5-V operation) with internal pulldown resistor (typical value: 1.5 MΩ)
8	DVDD	—	Digital (controller-side) power supply, 2.7 V to 5.5 V. See the Power Supply Recommendations section for decoupling recommendations.

7 Specifications

7.1 Absolute Maximum Ratings⁽¹⁾

		MIN	MAX	UNIT
Supply voltage	AVDD to AGND or DVDD to DGND	-0.3	6.5	V
Analog input voltage at AINP, AINN		AGND - 6	AVDD + 0.5	V
Digital input or output voltage at CLKIN or DOUT		DGND - 0.5	DVDD + 0.5	V
Input current to any pin except supply pins		-10	10	mA
Junction temperature, T _J			150	°C
Storage temperature, T _{stg}		-65	150	°C

- (1) Stresses beyond those listed under *Absolute Maximum Ratings* may cause permanent damage to the device. These are stress ratings only, and do not imply functional operation of the device at these or any other conditions beyond those indicated under *Recommended Operating Conditions*. Exposure to absolute-maximum-rated conditions for extended periods may affect device reliability.

7.2 ESD Ratings

			VALUE	UNIT
V _(ESD)	Electrostatic discharge	Human-body model (HBM), per ANSI/ESDA/JEDEC JS-001 ⁽¹⁾	±2000	V
		Charged-device model (CDM), per JEDEC specification JESD22-C101 ⁽²⁾	±1000	

- (1) JEDEC document JEP155 states that 500-V HBM allows safe manufacturing with a standard ESD control process.
(2) JEDEC document JEP157 states that 250-V CDM allows safe manufacturing with a standard ESD control process.

7.3 Recommended Operating Conditions

over operating ambient temperature range (unless otherwise noted)

		MIN	NOM	MAX	UNIT
AVDD	Analog (high-side) supply voltage (AVDD to AGND)	3.0	5.0	5.5	V
DVDD	Digital (controller-side) supply voltage (DVDD to DGND)	2.7	3.3	5.5	V
T _A	Operating ambient temperature	-40		125	°C

7.4 Thermal Information

THERMAL METRIC ⁽¹⁾		AMC1306x	UNIT
		DWV (SOIC)	
		8 PINS	
R _{θJA}	Junction-to-ambient thermal resistance	112.2	°C/W
R _{θJC(top)}	Junction-to-case (top) thermal resistance	47.6	°C/W
R _{θJB}	Junction-to-board thermal resistance	60.0	°C/W
ψ _{JT}	Junction-to-top characterization parameter	23.1	°C/W
ψ _{JB}	Junction-to-board characterization parameter	60.0	°C/W
R _{θJC(bot)}	Junction-to-case (bottom) thermal resistance	n/a	°C/W

- (1) For more information about traditional and new thermal metrics, see the [Semiconductor and IC Package Thermal Metrics](#) application report.

7.5 Power Ratings

PARAMETER		TEST CONDITIONS	MIN	TYP	MAX	UNIT
P _D	Maximum power dissipation (both sides)	AMC1306Ex, AVDD = DVDD = 5.5 V			91.85	mW
		AMC1306Mx, AVDD = DVDD = 5.5 V			86.90	
P _{D1}	Maximum power dissipation (high-side supply)	AVDD = 5.5 V			53.90	mW
P _{D2}	Maximum power dissipation (low-side supply)	AMC1306Ex, DVDD = 5.5 V			37.95	mW
		AMC1306Mx, DVDD = 5.5 V			33.00	

7.6 Insulation Specifications

over operating ambient temperature range (unless otherwise noted)

PARAMETER		TEST CONDITIONS	VALUE	UNIT
GENERAL				
CLR	External clearance ⁽¹⁾	Shortest pin-to-pin distance through air	≥ 8.5	mm
CPG	External creepage ⁽¹⁾	Shortest pin-to-pin distance across the package surface	≥ 8.5	mm
DTI	Distance through insulation	Minimum internal gap (internal clearance) of the double insulation (2 × 0.0105 mm)	≥ 0.021	mm
CTI	Comparative tracking index	DIN EN 60112 (VDE 0303-11); IEC 60112	≥ 600	V
	Material group	According to IEC 60664-1	I	
	Overvoltage category per IEC 60664-1	Rated mains voltage ≤ 300 V _{RMS}	I-IV	
		Rated mains voltage ≤ 600 V _{RMS}	I-IV	
		Rated mains voltage ≤ 1000 V _{RMS}	I-III	
DIN VDE V 0884-11: 2017-01⁽²⁾				
V _{IORM}	Maximum repetitive peak isolation voltage	At ac voltage (bipolar)	2121	V _{PK}
V _{IOWM}	Maximum-rated isolation working voltage	At ac voltage (sine wave)	1500	V _{RMS}
		At dc voltage	2121	V _{DC}
V _{IOTM}	Maximum transient isolation voltage	V _{TEST} = V _{IOTM} , t = 60 s (qualification test)	7000	V _{PK}
		V _{TEST} = 1.2 × V _{IOTM} , t = 1 s (100% production test)	8400	
V _{IOSM}	Maximum surge isolation voltage ⁽³⁾	Test method per IEC 60065, 1.2/50-μs waveform, V _{TEST} = 1.6 × V _{IOSM} = 12800 V _{PK} (qualification)	8000	V _{PK}
q _{pd}	Apparent charge ⁽⁴⁾	Method a, after input/output safety test subgroup 2/3, V _{ini} = V _{IOTM} , t _{ini} = 60 s, V _{pd(m)} = 1.2 × V _{IORM} = 2545 V _{PK} , t _m = 10 s	≤ 5	pC
		Method a, after environmental tests subgroup 1, V _{ini} = V _{IOTM} , t _{ini} = 60 s, V _{pd(m)} = 1.6 × V _{IORM} = 3394 V _{PK} , t _m = 10 s	≤ 5	
		Method b1, at routine test (100% production) and preconditioning (type test), V _{ini} = V _{IOTM} , t _{ini} = 1 s, V _{pd(m)} = 1.875 × V _{IORM} = 3977 V _{PK} , t _m = 1 s	≤ 5	
C _{IO}	Barrier capacitance, input to output ⁽⁵⁾	V _{IO} = 0.5 V _{PP} at 1 MHz	~1	pF
R _{IO}	Insulation resistance, input to output ⁽⁵⁾	V _{IO} = 500 V at T _A = 25°C	> 10 ¹²	Ω
		V _{IO} = 500 V at 100°C ≤ T _A ≤ 125°C	> 10 ¹¹	
		V _{IO} = 500 V at T _S = 150°C	> 10 ⁹	
	Pollution degree		2	
	Climatic category		40/125/21	
UL1577				
V _{ISO}	Withstand isolation voltage	V _{TEST} = V _{ISO} = 5000 V _{RMS} or 7000 V _{DC} , t = 60 s (qualification), V _{TEST} = 1.2 × V _{ISO} = 6000 V _{RMS} , t = 1 s (100% production test)	5000	V _{RMS}

- (1) Apply creepage and clearance requirements according to the specific equipment isolation standards of an application. Care must be taken to maintain the creepage and clearance distance of a board design to ensure that the mounting pads of the isolator on the printed circuit board (PCB) do not reduce this distance. Creepage and clearance on a PCB become equal in certain cases. Techniques such as inserting grooves and ribs on the PCB are used to help increase these specifications.
- (2) This coupler is suitable for *safe electrical insulation* only within the safety ratings. Compliance with the safety ratings shall be ensured by means of suitable protective circuits.
- (3) Testing is carried out in air or oil to determine the intrinsic surge immunity of the isolation barrier.
- (4) Apparent charge is electrical discharge caused by a partial discharge (pd).
- (5) All pins on each side of the barrier are tied together, creating a two-pin device.

7.7 Safety-Related Certifications

VDE	UL
Certified according to DIN VDE V 0884-11: 2017-01, DIN EN 62368-1: 2016-05, EN 62368-1: 2014, and IEC 62368-1: 2014	Recognized under 1577 component recognition and CSA component acceptance NO 5 programs
Reinforced insulation	Single protection
File number: DIN 40040142	File number: E181974

7.8 Safety Limiting Values

Safety limiting intends to minimize potential damage to the isolation barrier upon failure of input or output circuitry.

PARAMETER		TEST CONDITIONS	MIN	TYP	MAX	UNIT
I _S	Safety input, output, or supply current	R _{θJA} = 112.2°C/W, AVDD = DVDD = 5.5 V, T _J = 150°C, T _A = 25°C			202.5	mA
		R _{θJA} = 112.2°C/W, AVDD = DVDD = 3.6 V, T _J = 150°C, T _A = 25°C			309.4	
P _S	Safety input, output, or total power	R _{θJA} = 112.2°C/W, T _J = 150°C, T _A = 25°C			1114 ⁽¹⁾	mW
T _S	Maximum safety temperature				150	°C

- (1) The maximum safety temperature, T_S, has the same value as the maximum junction temperature, T_J, specified for the device. The I_S and P_S parameters represent the safety current and safety power, respectively. Do not exceed the maximum limits of I_S and P_S. These limits vary with the ambient temperature, T_A.

The junction-to-air thermal resistance, R_{θJA}, in the [Thermal Information](#) table is that of a device installed on a high-K test board for leaded surface-mount packages. Use these equations to calculate the value for each parameter:

$T_J = T_A + R_{\theta JA} \times P$, where P is the power dissipated in the device.

$T_{J(max)} = T_S = T_A + R_{\theta JA} \times P_S$, where T_{J(max)} is the maximum junction temperature.

$P_S = I_S \times AVDD_{max} + I_S \times AVDD_{max}$, where AVDD_{max} is the maximum high-side supply voltage and DVDD_{max} is the maximum controller-side supply voltage.

7.9 Electrical Characteristics: AMC1306x05

minimum and maximum specifications apply from $T_A = -40^{\circ}\text{C}$ to $+125^{\circ}\text{C}$, $AVDD = 3.0\text{ V}$ to 5.5 V , $DVDD = 2.7\text{ V}$ to 5.5 V , $AINP = -50\text{ mV}$ to 50 mV , $AINN = \text{AGND}$, and sinc³ filter with $\text{OSR} = 256$ (unless otherwise noted); typical specifications are at $T_A = 25^{\circ}\text{C}$, $\text{CLKIN} = 20\text{ MHz}$, $AVDD = 5\text{ V}$, and $DVDD = 3.3\text{ V}$

PARAMETER		TEST CONDITIONS	MIN	TYP	MAX	UNIT
ANALOG INPUTS						
V_{Clipping}	Differential input voltage before clipping output	$V_{\text{IN}} = \text{AINP} - \text{AINN}$		±64		mV
FSR	Specified linear differential full-scale	$V_{\text{IN}} = \text{AINP} - \text{AINN}$	-50		50	mV
	Absolute common-mode input voltage ⁽¹⁾	$(\text{AINP} + \text{AINN}) / 2$ to AGND	-2		AVDD	V
V_{CM}	Operating common-mode input voltage	$(\text{AINP} + \text{AINN}) / 2$ to AGND	-0.032		AVDD - 2.1	V
V_{CMov}	Common-mode overvoltage detection level ⁽²⁾	$(\text{AINP} + \text{AINN}) / 2$ to AGND	AVDD - 2			V
C_{IN}	Single-ended input capacitance	$\text{AINN} = \text{AGND}$		4		pF
C_{IND}	Differential input capacitance			2		pF
I_{IB}	Input bias current	$\text{AINP} = \text{AINN} = \text{AGND}$, $I_{\text{B}} = I_{\text{IBP}} + I_{\text{IBN}}$	-97	-72	-57	µA
R_{IN}	Single-ended input resistance	$\text{AINN} = \text{AGND}$		4.75		kΩ
R_{IND}	Differential input resistance			4.9		kΩ
I_{IO}	Input offset current			±10		nA
CMTI	Common-mode transient immunity		50	100		kV/µs
CMRR	Common-mode rejection ratio	$\text{AINP} = \text{AINN}$, $f_{\text{IN}} = 0\text{ Hz}$, $V_{\text{CM min}} \leq V_{\text{IN}} \leq V_{\text{CM max}}$		-99		dB
		$\text{AINP} = \text{AINN}$, f_{IN} from 0.1 Hz to 50 kHz, $V_{\text{CM min}} \leq V_{\text{IN}} \leq V_{\text{CM max}}$		-98		
BW	Input bandwidth ⁽³⁾			800		kHz
DC ACCURACY						
DNL	Differential nonlinearity	Resolution: 16 bits	-0.99		0.99	LSB
INL	Integral nonlinearity ⁽⁴⁾	Resolution: 16 bits, $4.5\text{ V} \leq AVDD \leq 5.5\text{ V}$	-4	±1	4	LSB
		Resolution: 16 bits, $3.0\text{ V} \leq AVDD \leq 3.6\text{ V}$	-5	±1.5	5	
E_{O}	Offset error	Initial, at 25°C , $\text{AINP} = \text{AINN} = \text{AGND}$	-50	±2.5	50	µV
TCE_{O}	Offset error thermal drift ⁽⁵⁾		-1	±0.25	1	µV/°C
E_{G}	Gain error	Initial, at 25°C	-0.2%	±0.005%	0.2%	
TCE_{G}	Gain error thermal drift ⁽⁶⁾		-40	±20	40	ppm/°C
PSRR	Power-supply rejection ratio	$\text{AINP} = \text{AINN} = \text{AGND}$, $3.0\text{ V} \leq AVDD \leq 5.5\text{ V}$, at dc		-108		dB
		$\text{AINP} = \text{AINN} = \text{AGND}$, $3.0\text{ V} \leq AVDD \leq 5.5\text{ V}$, 10 kHz, 100-mV ripple		-107		
AC ACCURACY						
SNR	Signal-to-noise ratio	$f_{\text{IN}} = 1\text{ kHz}$	78	82.5		dB
SINAD	Signal-to-noise + distortion	$f_{\text{IN}} = 1\text{ kHz}$	77.5	82.3		dB
THD	Total harmonic distortion	$4.5\text{ V} \leq AVDD \leq 5.5\text{ V}$, $5\text{ MHz} \leq f_{\text{CLKIN}} \leq 21\text{ MHz}$, $f_{\text{IN}} = 1\text{ kHz}$		-98	-84	dB
		$3.0\text{ V} \leq AVDD \leq 3.6\text{ V}$, $5\text{ MHz} \leq f_{\text{CLKIN}} \leq 20\text{ MHz}$, $f_{\text{IN}} = 1\text{ kHz}$		-93	-83	
SFDR	Spurious-free dynamic range	$f_{\text{IN}} = 1\text{ kHz}$	83	100		dB

- (1) Steady-state voltage supported by the device in case of a system failure. See specified common-mode input voltage V_{CM} for normal operation. Observe analog input voltage range as specified in the *Absolute Maximum Ratings* table.
- (2) The common-mode overvoltage detection level has a typical hysteresis of 90 mV.
- (3) This is the -3-dB, second-order roll-off frequency of the integrated differential input amplifier to consider for the antialiasing filter design.
- (4) Integral nonlinearity is defined as the maximum deviation from a straight line passing through the end-points of the ideal ADC transfer function expressed as a number of LSBs or as a percent of the specified linear full-scale range (FSR).
- (5) Offset error drift is calculated using the box method, as described by the following equation:

$$TCE_{\text{O}} = \frac{\text{value}_{\text{MAX}} - \text{value}_{\text{MIN}}}{\text{TempRange}}$$

- (6) Gain error drift is calculated using the box method, as described by the following equation:

$$TCE_{\text{G}} (\text{ppm}) = \left(\frac{\text{value}_{\text{MAX}} - \text{value}_{\text{MIN}}}{\text{value} \times \text{TempRange}} \right) \times 10^6$$

Electrical Characteristics: AMC1306x05 (continued)

minimum and maximum specifications apply from $T_A = -40^\circ\text{C}$ to $+125^\circ\text{C}$, $AVDD = 3.0\text{ V}$ to 5.5 V , $DVDD = 2.7\text{ V}$ to 5.5 V , $A\text{INP} = -50\text{ mV}$ to 50 mV , $A\text{INN} = \text{AGND}$, and sinc³ filter with $\text{OSR} = 256$ (unless otherwise noted); typical specifications are at $T_A = 25^\circ\text{C}$, $\text{CLKIN} = 20\text{ MHz}$, $AVDD = 5\text{ V}$, and $DVDD = 3.3\text{ V}$

PARAMETER		TEST CONDITIONS	MIN	TYP	MAX	UNIT
DIGITAL INPUTS/OUTPUTS						
CMOS Logic With Schmitt-Trigger						
I_{IN}	Input current	$\text{DGND} \leq V_{\text{IN}} \leq \text{DVDD}$	0		7	μA
C_{IN}	Input capacitance			4		pF
V_{IH}	High-level input voltage		$0.7 \times \text{DVDD}$		$\text{DVDD} + 0.3$	V
V_{IL}	Low-level input voltage		-0.3		$0.3 \times \text{DVDD}$	V
C_{LOAD}	Output load capacitance			30		pF
V_{OH}	High-level output voltage	$I_{\text{OH}} = -20\ \mu\text{A}$	$\text{DVDD} - 0.1$			V
		$I_{\text{OH}} = -4\ \text{mA}$	$\text{DVDD} - 0.4$			
V_{OL}	Low-level output voltage	$I_{\text{OL}} = 20\ \mu\text{A}$			0.1	V
		$I_{\text{OL}} = 4\ \text{mA}$			0.4	
POWER SUPPLY						
$AVDD$	High-side supply voltage		3.0	5.0	5.5	V
I_{AVDD}	High-side supply current	$3.0\ \text{V} \leq AVDD \leq 3.6\ \text{V}$		6.3	8.5	mA
		$4.5\ \text{V} \leq AVDD \leq 5.5\ \text{V}$		7.2	9.8	
$DVDD$	Controller-side supply voltage		2.7	3.3	5.5	V
I_{DVDD}	Controller-side supply current	AMC1306Ex, $2.7\ \text{V} \leq \text{DVDD} \leq 3.6\ \text{V}$, $C_{\text{LOAD}} = 15\ \text{pF}$		4.1	5.5	mA
		AMC1306Mx, $2.7\ \text{V} \leq \text{DVDD} \leq 3.6\ \text{V}$, $C_{\text{LOAD}} = 15\ \text{pF}$		3.3	4.8	
		AMC1306Ex, $4.5\ \text{V} \leq \text{DVDD} \leq 5.5\ \text{V}$, $C_{\text{LOAD}} = 15\ \text{pF}$		5.0	6.9	
		AMC1306Mx, $4.5\ \text{V} \leq \text{DVDD} \leq 5.5\ \text{V}$, $C_{\text{LOAD}} = 15\ \text{pF}$		3.9	6.0	

7.10 Electrical Characteristics: AMC1306x25

minimum and maximum specifications apply from $T_A = -40^{\circ}\text{C}$ to $+125^{\circ}\text{C}$, $\text{AVDD} = 3.0\text{ V}$ to 5.5 V , $\text{DVDD} = 2.7\text{ V}$ to 5.5 V , $\text{AINP} = -250\text{ mV}$ to 250 mV , $\text{AINN} = \text{AGND}$, and sinc^3 filter with $\text{OSR} = 256$ (unless otherwise noted); typical specifications are at $T_A = 25^{\circ}\text{C}$, $\text{CLKIN} = 20\text{ MHz}$, $\text{AVDD} = 5\text{ V}$, and $\text{DVDD} = 3.3\text{ V}$

PARAMETER		TEST CONDITIONS	MIN	TYP	MAX	UNIT
ANALOG INPUTS						
V_{Clipping}	Differential input voltage before clipping output	$\text{AINP} - \text{AINN}$		± 320		mV
FSR	Specified linear differential full-scale	$\text{AINP} - \text{AINN}$	-250		250	mV
	Absolute common-mode input voltage ⁽¹⁾	$(\text{AINP} + \text{AINN}) / 2$ to AGND	-2		AVDD	V
V_{CM}	Operating common-mode input voltage	$(\text{AINP} + \text{AINN}) / 2$ to AGND	-0.16		AVDD - 2.1	V
V_{CMov}	Common-mode overvoltage detection level ⁽²⁾	$(\text{AINP} + \text{AINN}) / 2$ to AGND	AVDD - 2			V
C_{IN}	Single-ended input capacitance	$\text{AINN} = \text{AGND}$		2		pF
C_{IND}	Differential input capacitance			1		pF
I_{IB}	Input bias current	$\text{AINP} = \text{AINN} = \text{AGND}$, $I_{\text{IB}} = I_{\text{IBP}} + I_{\text{IBN}}$	-82	-60	-48	μA
R_{IN}	Single-ended input resistance	$\text{AINN} = \text{AGND}$		19		$\text{k}\Omega$
R_{IND}	Differential input resistance			22		$\text{k}\Omega$
I_{IO}	Input offset current			± 5		nA
CMTI	Common-mode transient immunity		50	100		$\text{kV}/\mu\text{s}$
CMRR	Common-mode rejection ratio	$\text{AINP} = \text{AINN}$, $f_{\text{IN}} = 0\text{ Hz}$, $V_{\text{CM min}} \leq V_{\text{IN}} \leq V_{\text{CM max}}$		-95		dB
		$\text{AINP} = \text{AINN}$, f_{IN} from 0.1 Hz to 50 kHz, $V_{\text{CM min}} \leq V_{\text{IN}} \leq V_{\text{CM max}}$		-95		
BW	Input bandwidth ⁽³⁾			900		kHz
DC ACCURACY						
DNL	Differential nonlinearity	Resolution: 16 bits	-0.99		0.99	LSB
INL	Integral nonlinearity ⁽⁴⁾	Resolution: 16 bits	-4	± 1	4	LSB
E_{O}	Offset error	Initial, at 25°C , $\text{AINP} = \text{AINN} = \text{AGND}$	-100	± 4.5	100	μV
TCE_{O}	Offset error thermal drift ⁽⁵⁾		-1	± 0.15	1	$\mu\text{V}/^{\circ}\text{C}$
E_{G}	Gain error	Initial, at 25°C	-0.2%	$\pm 0.005\%$	0.2%	
TCE_{G}	Gain error thermal drift ⁽⁶⁾		-40	± 20	40	ppm/ $^{\circ}\text{C}$
PSRR	Power-supply rejection ratio	$\text{AINP} = \text{AINN} = \text{AGND}$, $3.0\text{ V} \leq \text{AVDD} \leq 5.5\text{ V}$, at dc		-103		dB
		$\text{AINP} = \text{AINN} = \text{AGND}$, $3.0\text{ V} \leq \text{AVDD} \leq 5.5\text{ V}$, 10 kHz, 100-mV ripple		-92		
AC ACCURACY						
SNR	Signal-to-noise ratio	$f_{\text{IN}} = 1\text{ kHz}$	82	86		dB
SINAD	Signal-to-noise + distortion	$f_{\text{IN}} = 1\text{ kHz}$	81.9	85.7		dB
THD	Total harmonic distortion	$4.5\text{ V} \leq \text{AVDD} \leq 5.5\text{ V}$, $5\text{ MHz} \leq f_{\text{CLKIN}} \leq 21\text{ MHz}$, $f_{\text{IN}} = 1\text{ kHz}$		-98	-86	dB
		$3.0\text{ V} \leq \text{AVDD} \leq 3.6\text{ V}$, $5\text{ MHz} \leq f_{\text{CLKIN}} \leq 20\text{ MHz}$, $f_{\text{IN}} = 1\text{ kHz}$		-93	-85	
SFDR	Spurious-free dynamic range	$f_{\text{IN}} = 1\text{ kHz}$	83	100		dB

- Steady-state voltage supported by the device in case of a system failure; see the specified common-mode input voltage V_{CM} for normal operation. Adhere to the analog input voltage range as specified in the [Absolute Maximum Ratings](#) table.
- The common-mode overvoltage detection level has a typical hysteresis of 90 mV.
- This parameter is the -3-dB, second-order, roll-off frequency of the integrated differential input amplifier to consider for antialiasing filter designs.
- Integral nonlinearity is defined as the maximum deviation from a straight line passing through the end-points of the ideal ADC transfer function expressed as number of LSBs or as a percent of the specified linear full-scale range FSR.
- Offset error drift is calculated using the box method, as described by the following equation:

$$\text{TCE}_{\text{O}} = \frac{\text{value}_{\text{MAX}} - \text{value}_{\text{MIN}}}{\text{TempRange}}$$
- Gain error drift is calculated using the box method, as described by the following equation:

$$\text{TCE}_{\text{G}} (\text{ppm}) = \left(\frac{\text{value}_{\text{MAX}} - \text{value}_{\text{MIN}}}{\text{value} \times \text{TempRange}} \right) \times 10^6$$

Electrical Characteristics: AMC1306x25 (continued)

minimum and maximum specifications apply from $T_A = -40^\circ\text{C}$ to $+125^\circ\text{C}$, $AVDD = 3.0\text{ V}$ to 5.5 V , $DVDD = 2.7\text{ V}$ to 5.5 V , $A\text{INP} = -250\text{ mV}$ to 250 mV , $A\text{INN} = \text{AGND}$, and sinc³ filter with $\text{OSR} = 256$ (unless otherwise noted); typical specifications are at $T_A = 25^\circ\text{C}$, $\text{CLKIN} = 20\text{ MHz}$, $AVDD = 5\text{ V}$, and $DVDD = 3.3\text{ V}$

PARAMETER		TEST CONDITIONS	MIN	TYP	MAX	UNIT
DIGITAL INPUTS/OUTPUTS						
CMOS Logic with Schmitt-trigger						
I_{IN}	Input current	$\text{DGND} \leq V_{\text{IN}} \leq \text{DVDD}$	0		7	μA
C_{IN}	Input capacitance			4		pF
V_{IH}	High-level input voltage		$0.7 \times \text{DVDD}$		$\text{DVDD} + 0.3$	V
V_{IL}	Low-level input voltage		-0.3		$0.3 \times \text{DVDD}$	V
C_{LOAD}	Output load capacitance	$f_{\text{CLKIN}} = 20\text{ MHz}$		30		pF
V_{OH}	High-level output voltage	$I_{\text{OH}} = -20\ \mu\text{A}$	$\text{DVDD} - 0.1$			V
		$I_{\text{OH}} = -4\ \text{mA}$	$\text{DVDD} - 0.4$			
V_{OL}	Low-level output voltage	$I_{\text{OL}} = 20\ \mu\text{A}$			0.1	V
		$I_{\text{OL}} = 4\ \text{mA}$			0.4	
POWER SUPPLY						
$AVDD$	High-side supply voltage		3.0	5.0	5.5	V
I_{AVDD}	High-side supply current	$3.0\text{ V} \leq AVDD \leq 3.6\text{ V}$		6.3	8.5	mA
		$4.5\text{ V} \leq AVDD \leq 5.5\text{ V}$		7.2	9.8	
$DVDD$	Controller-side supply voltage		2.7	3.3	5.5	V
I_{DVDD}	Controller-side supply current	AMC1306Ex, $2.7\text{ V} \leq \text{DVDD} \leq 3.6\text{ V}$, $C_{\text{LOAD}} = 15\text{ pF}$		4.1	5.5	mA
		AMC1306Mx, $2.7\text{ V} \leq \text{DVDD} \leq 3.6\text{ V}$, $C_{\text{LOAD}} = 15\text{ pF}$		3.3	4.8	
		AMC1306Ex, $4.5\text{ V} \leq \text{DVDD} \leq 5.5\text{ V}$, $C_{\text{LOAD}} = 15\text{ pF}$		5.0	6.9	
		AMC1306Mx, $4.5\text{ V} \leq \text{DVDD} \leq 5.5\text{ V}$, $C_{\text{LOAD}} = 15\text{ pF}$		3.9	6.0	

7.11 Switching Characteristics

over operating ambient temperature range (unless otherwise noted)

PARAMETER		TEST CONDITIONS	MIN	TYP	MAX	UNIT
f _{CLKIN}	CLKIN clock frequency	4.5 V ≤ AVDD ≤ 5.5 V	5		21	MHz
		3.0 V ≤ AVDD ≤ 5.5 V	5		20	
t _{CLKIN}	CLKIN clock period	4.5 V ≤ AVDD ≤ 5.5 V	47.6		200	ns
		3.0 V ≤ AVDD ≤ 5.5 V	50		200	
t _{HIGH}	CLKIN clock high time		20	25	120	ns
t _{LOW}	CLKIN clock low time		20	25	120	ns
t _H	DOUT hold time after rising edge of CLKIN	AMC1306Mx ⁽¹⁾ , C _{LOAD} = 15 pF	3.5			ns
t _D	Rising edge of CLKIN to DOUT valid delay	AMC1306Mx ⁽¹⁾ , C _{LOAD} = 15 pF			15	ns
t _r	DOUT rise time	10% to 90%, 2.7 V ≤ DVDD ≤ 3.6 V, C _{LOAD} = 15 pF		0.8	3.5	ns
		10% to 90%, 4.5 V ≤ DVDD ≤ 5.5 V, C _{LOAD} = 15 pF		1.8	3.9	
t _f	DOUT fall time	90% to 10%, 2.7 V ≤ DVDD ≤ 3.6 V, C _{LOAD} = 15 pF		0.8	3.5	ns
		90% to 10%, 4.5 V ≤ DVDD ≤ 5.5 V, C _{LOAD} = 15 pF		1.8	3.9	
t _{ISTART}	Interface startup time	DVDD at 2.7 V (min) to DOUT valid with AVDD ≥ 3.0 V	32		32	CLKIN cycles
t _{ASTART}	Analog startup time	AVDD step to 3.0 V with DVDD ≥ 2.7 V, 0.1% settling		0.5		ms

(1) The output of the Manchester encoded versions of the AMC1306Ex can change with every edge of CLKIN with a typical delay of 6 ns; see the [Manchester Coding Feature](#) section for additional details.

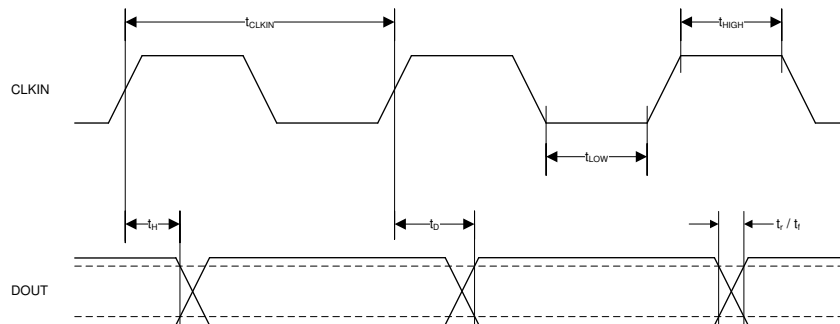

Figure 1. Digital Interface Timing

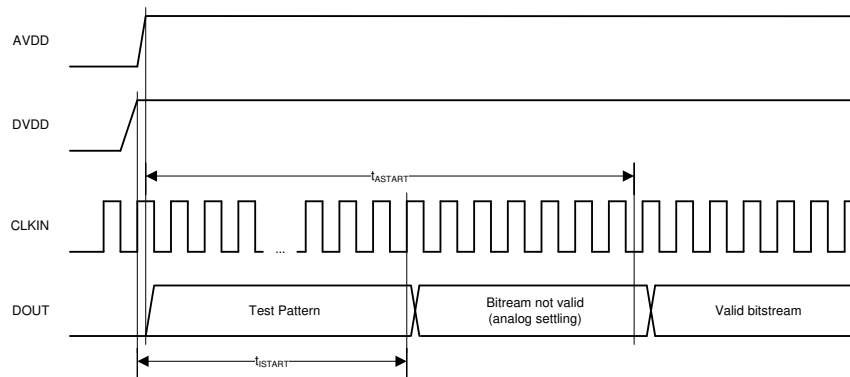
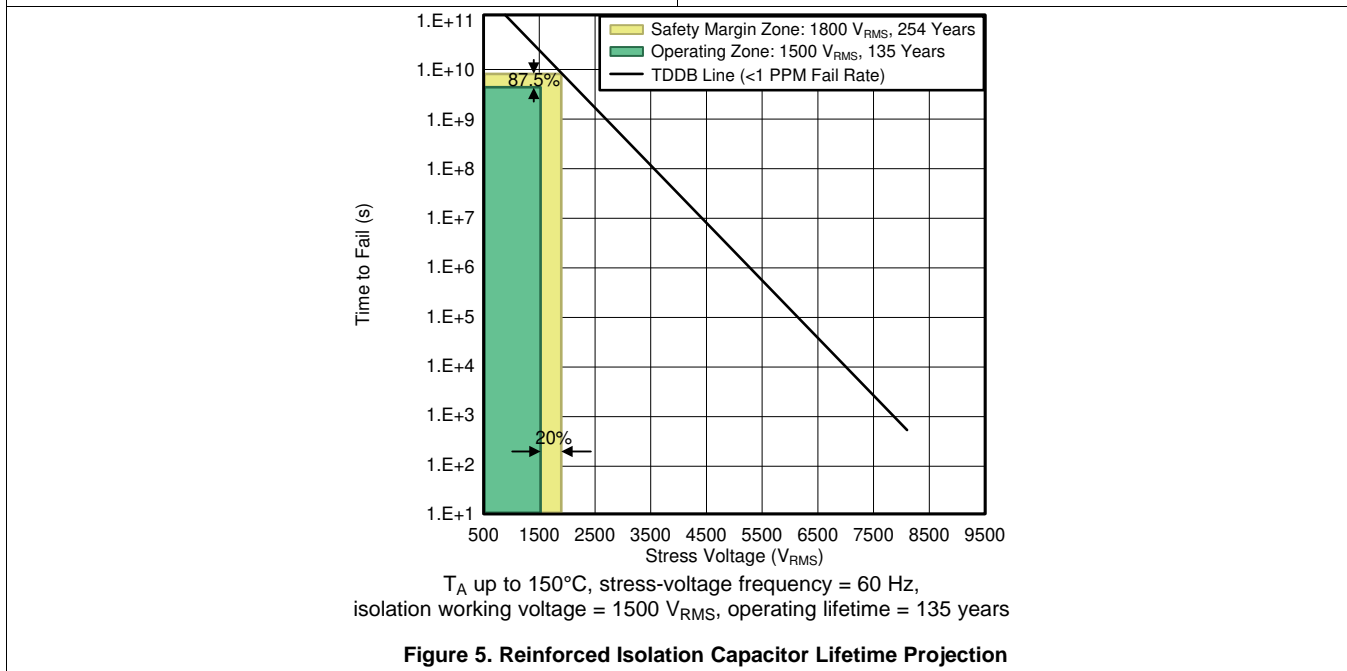
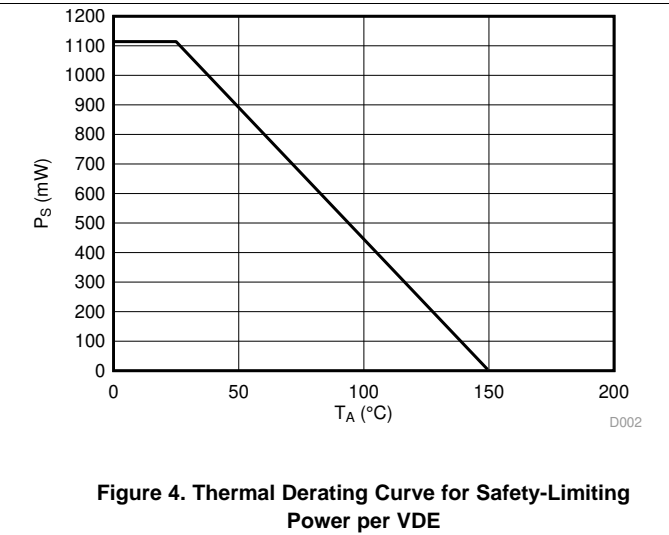
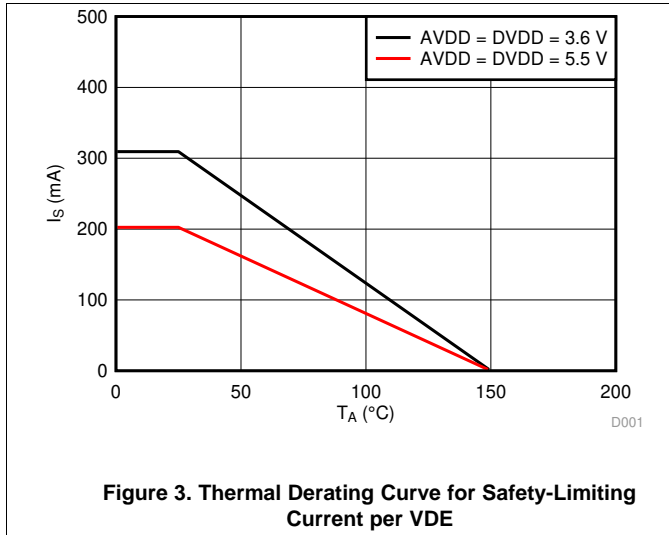

Figure 2. Device Startup Timing

7.12 Insulation Characteristics Curves



7.13 Typical Characteristics

at AVDD = 5 V, DVDD = 3.3 V, AINP = -50 mV to 50 mV (AMC1306x05) or -250 mV to 250 mV (AMC1306x25), AINN = AGND, f_{CLKIN} = 20 MHz, and sinc³ filter with OSR = 256 (unless otherwise noted)

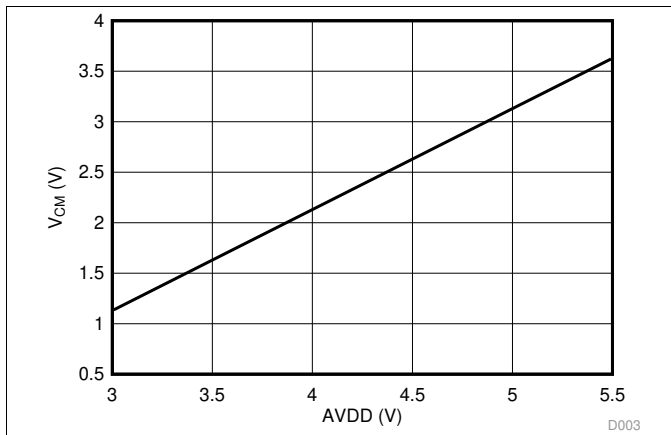

Figure 6. Maximum Operating Common-Mode Input Voltage vs High-Side Supply Voltage

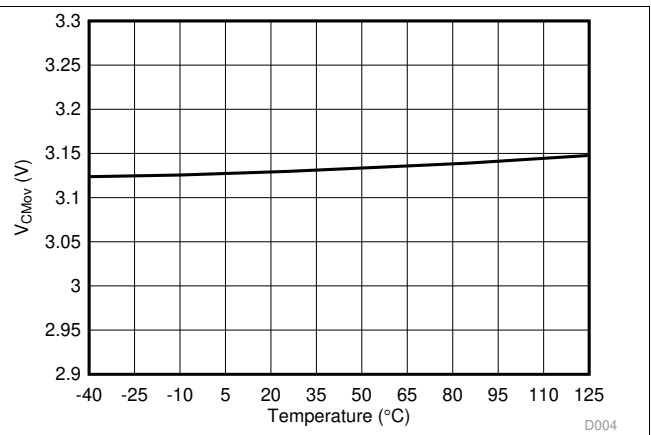

Figure 7. Common-Mode Overvoltage Detection Level vs Temperature

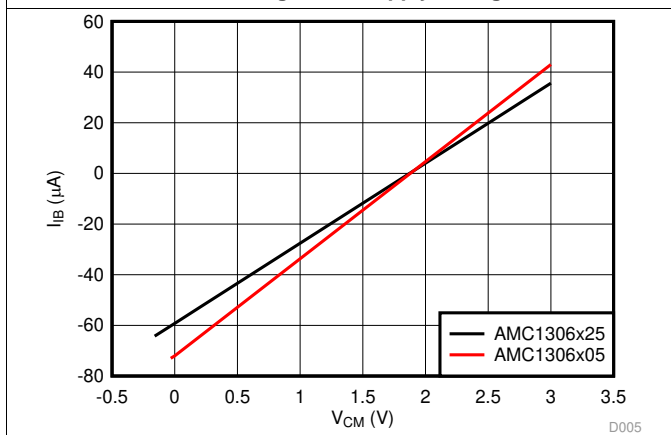

Figure 8. Input Bias Current vs Common-Mode Input Voltage

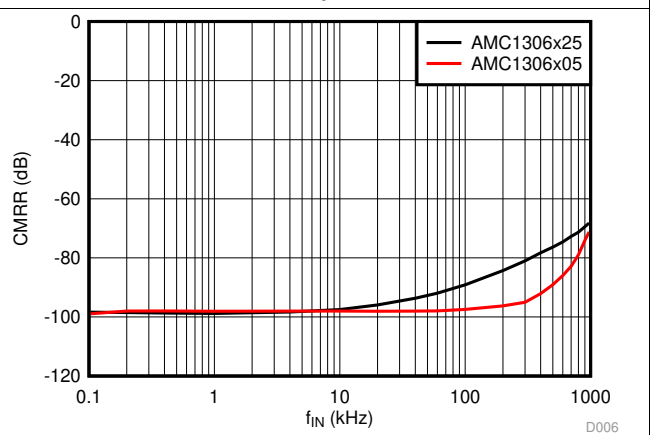

Figure 9. Common-Mode Rejection Ratio vs Input Signal Frequency

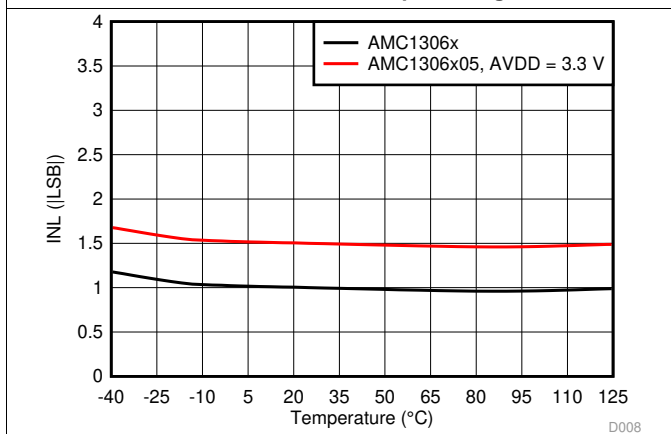

Figure 10. Integral Nonlinearity vs Temperature

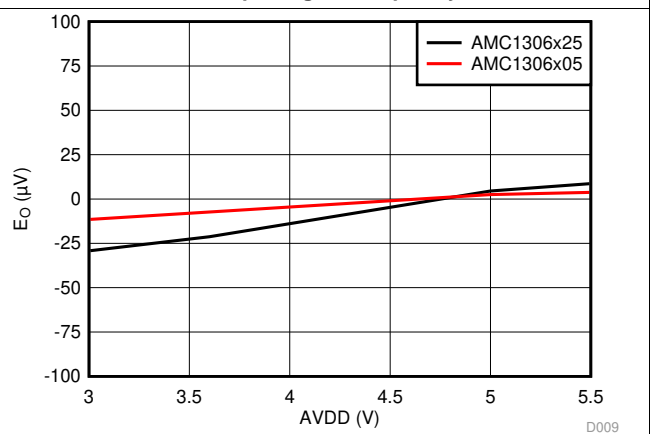

Figure 11. Offset Error vs High-Side Supply Voltage

Typical Characteristics (continued)

at AVDD = 5 V, DVDD = 3.3 V, AINP = -50 mV to 50 mV (AMC1306x05) or -250 mV to 250 mV (AMC1306x25), AINN = AGND, f_{CLKIN} = 20 MHz, and sinc³ filter with OSR = 256 (unless otherwise noted)

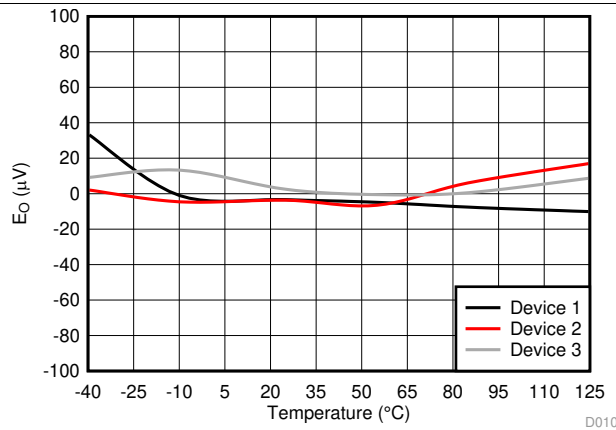

Figure 12. Offset Error vs Temperature

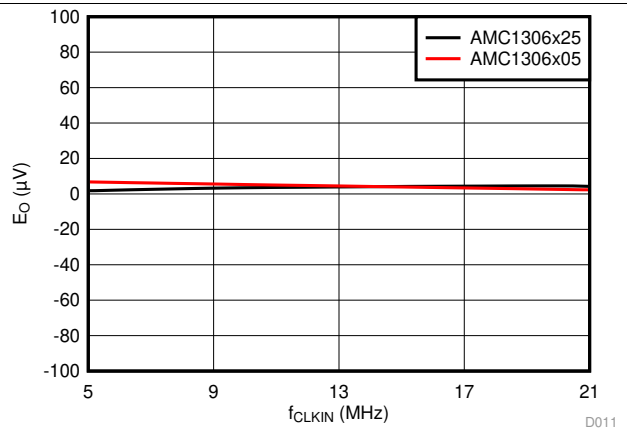

Figure 13. Offset Error vs Clock Frequency

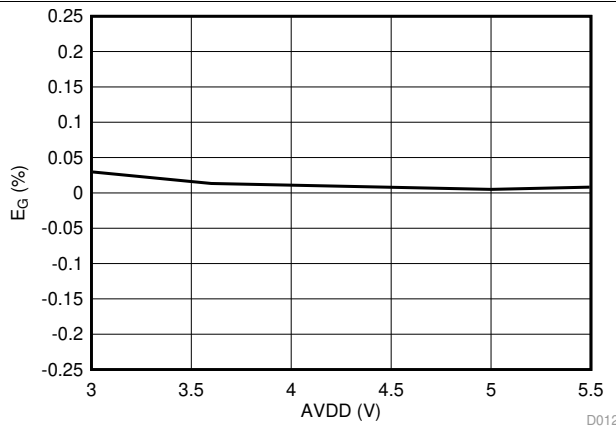

Figure 14. Gain Error vs High-Side Supply Voltage

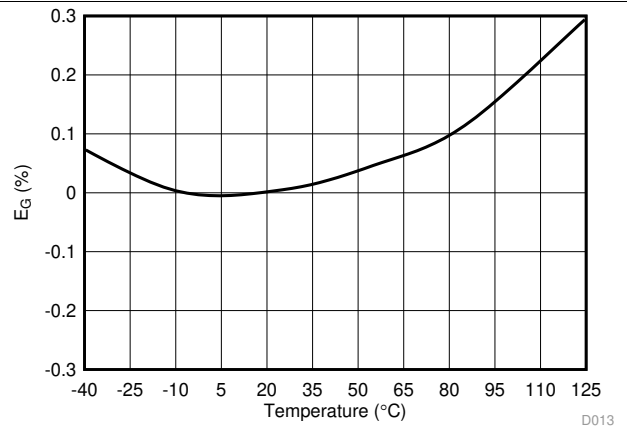

Figure 15. Gain Error vs Temperature

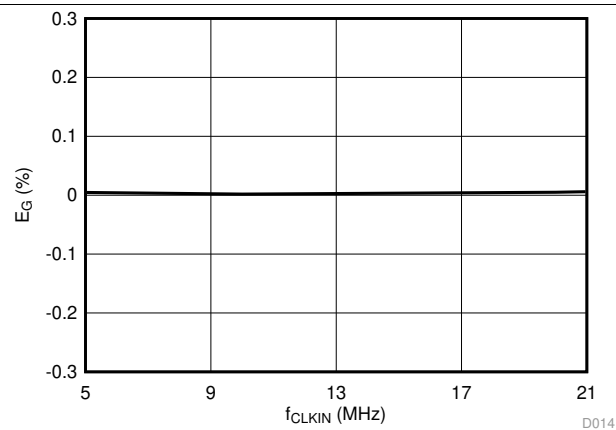

Figure 16. Gain Error vs Clock Frequency

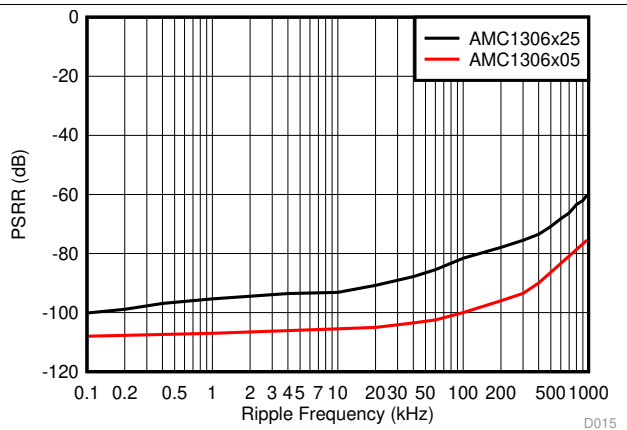

Figure 17. Power-Supply Rejection Ratio vs Ripple Frequency

Typical Characteristics (continued)

at AVDD = 5 V, DVDD = 3.3 V, AINP = -50 mV to 50 mV (AMC1306x05) or -250 mV to 250 mV (AMC1306x25), AINN = AGND, $f_{CLKIN} = 20$ MHz, and sinc³ filter with OSR = 256 (unless otherwise noted)

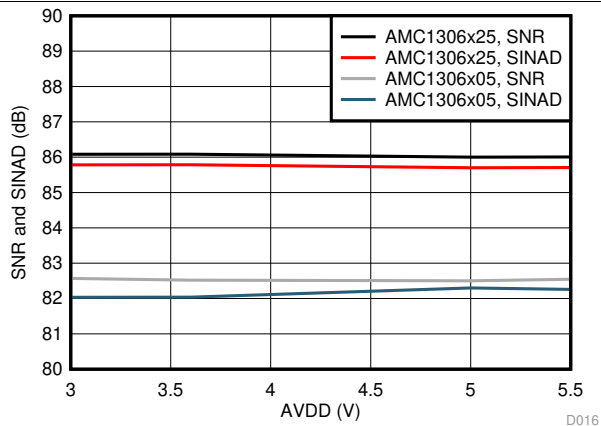

Figure 18. Signal-to-Noise Ratio and Signal-to-Noise + Distortion vs High-Side Supply Voltage

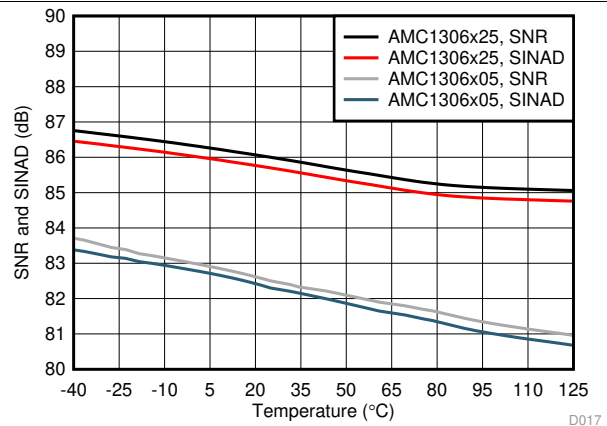

Figure 19. Signal-to-Noise Ratio and Signal-to-Noise + Distortion vs Temperature

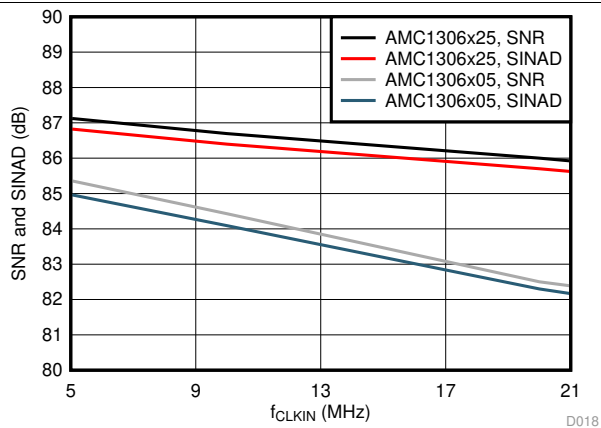

Figure 20. Signal-to-Noise Ratio and Signal-to-Noise + Distortion vs Clock Frequency

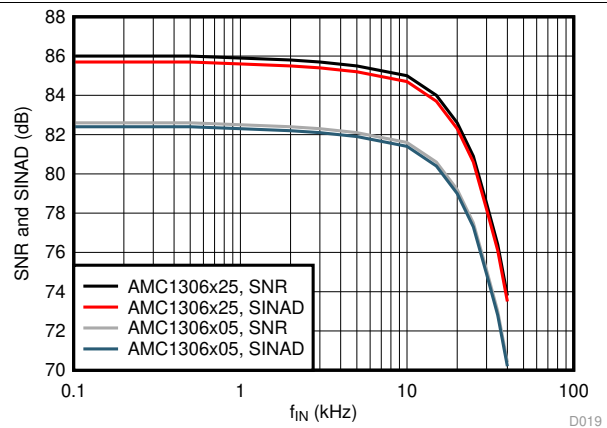

Figure 21. Signal-to-Noise Ratio and Signal-to-Noise + Distortion vs Input Signal Frequency

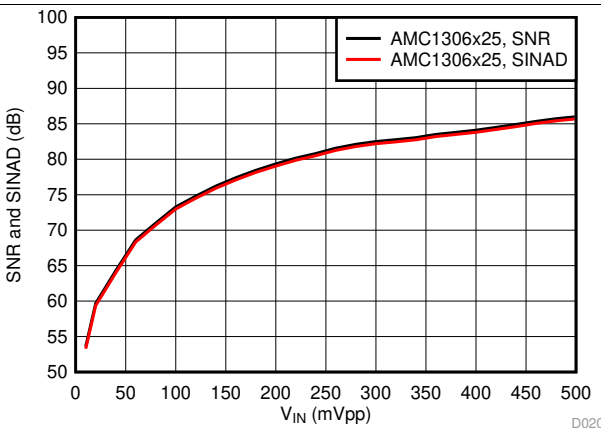

Figure 22. Signal-to-Noise Ratio and Signal-to-Noise + Distortion vs Input Signal Amplitude

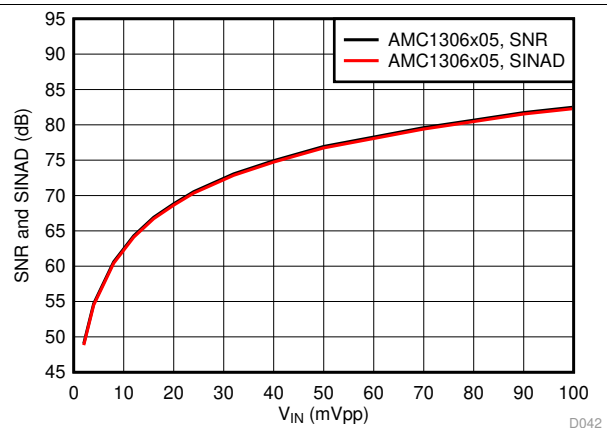

Figure 23. Signal-to-Noise Ratio and Signal-to-Noise + Distortion vs Input Signal Amplitude

Typical Characteristics (continued)

at AVDD = 5 V, DVDD = 3.3 V, AINP = -50 mV to 50 mV (AMC1306x05) or -250 mV to 250 mV (AMC1306x25), AINN = AGND, f_{CLKIN} = 20 MHz, and sinc³ filter with OSR = 256 (unless otherwise noted)

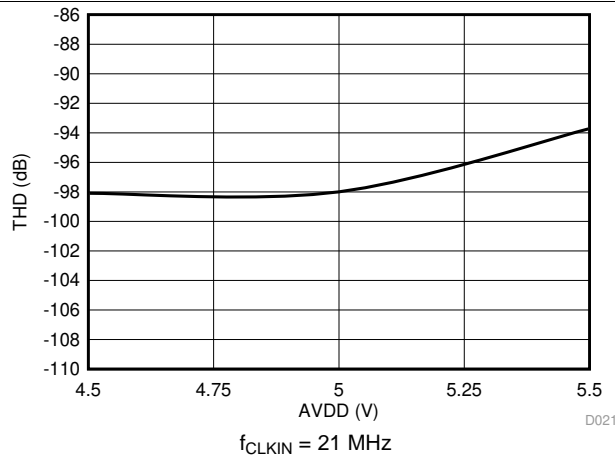

Figure 24. Total Harmonic Distortion vs High-Side Supply Voltage (5 V, nom)

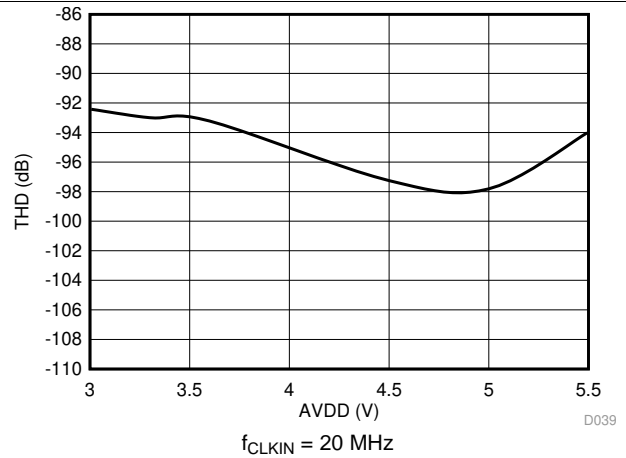

Figure 25. Total Harmonic Distortion vs High-Side Supply Voltage (3.3 V, nom)

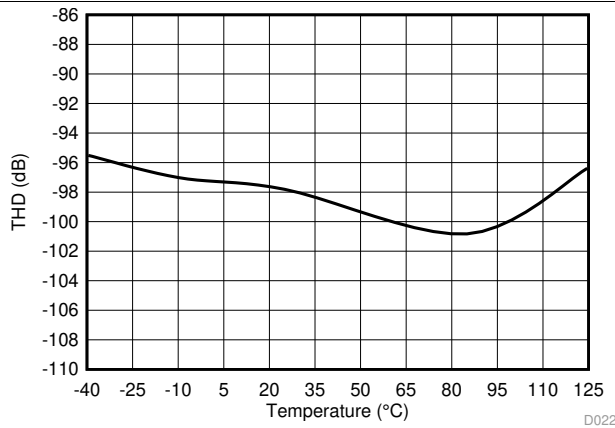

Figure 26. Total Harmonic Distortion vs Temperature

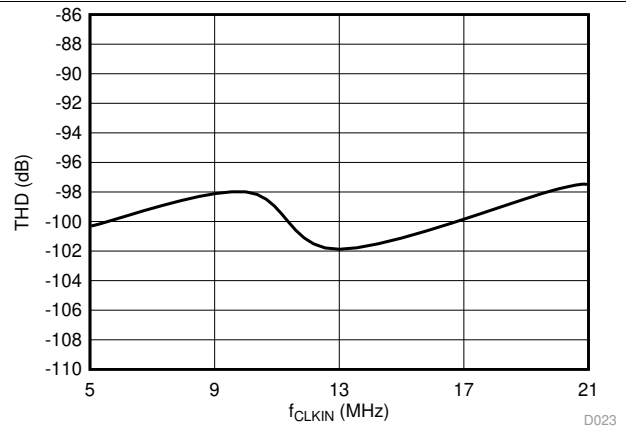

Figure 27. Total Harmonic Distortion vs Clock Frequency

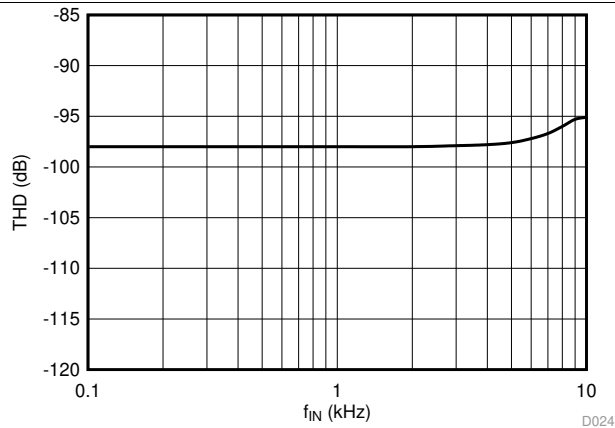

Figure 28. Total Harmonic Distortion vs Input Signal Frequency

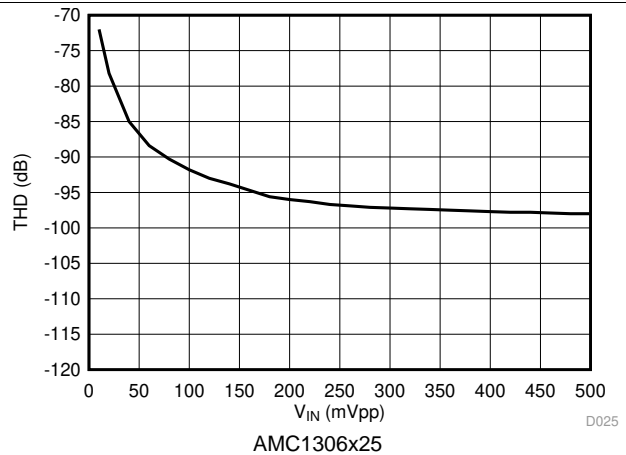

Figure 29. Total Harmonic Distortion vs Input Signal Amplitude

Typical Characteristics (continued)

at AVDD = 5 V, DVDD = 3.3 V, AINP = -50 mV to 50 mV (AMC1306x05) or -250 mV to 250 mV (AMC1306x25), AINN = AGND, $f_{CLKIN} = 20$ MHz, and sinc³ filter with OSR = 256 (unless otherwise noted)

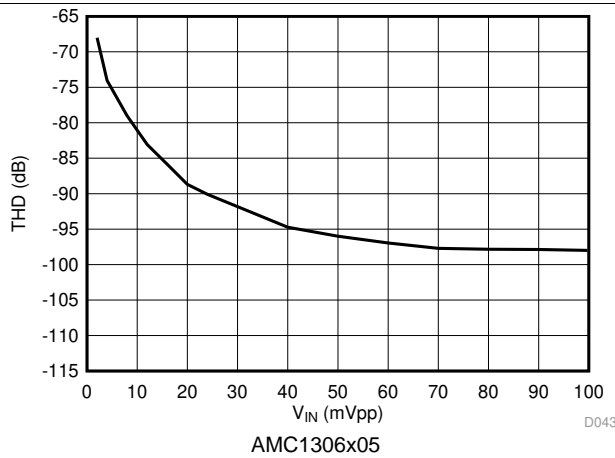

Figure 30. Total Harmonic Distortion vs Input Signal Amplitude

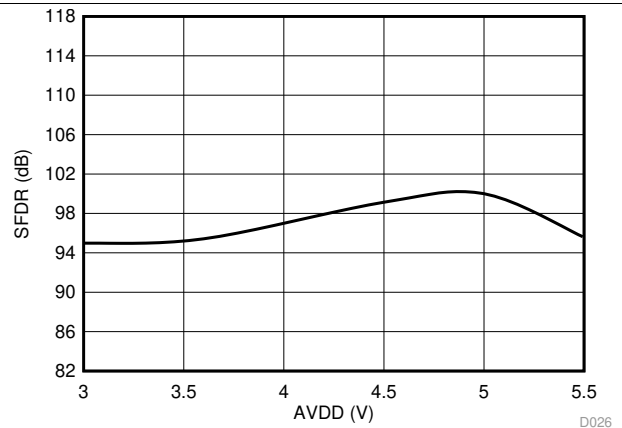

Figure 31. Spurious-Free Dynamic Range vs High-Side Supply Voltage

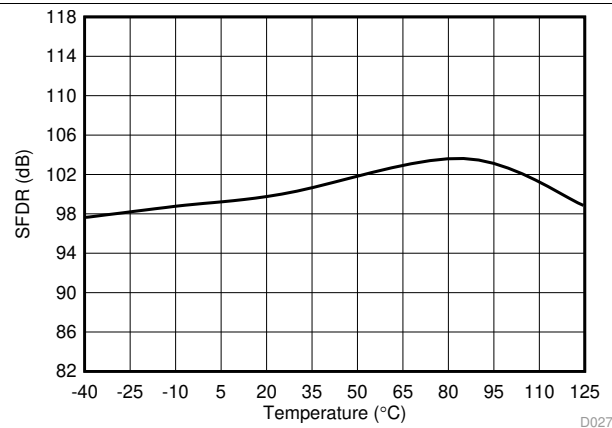

Figure 32. Spurious-Free Dynamic Range vs Temperature

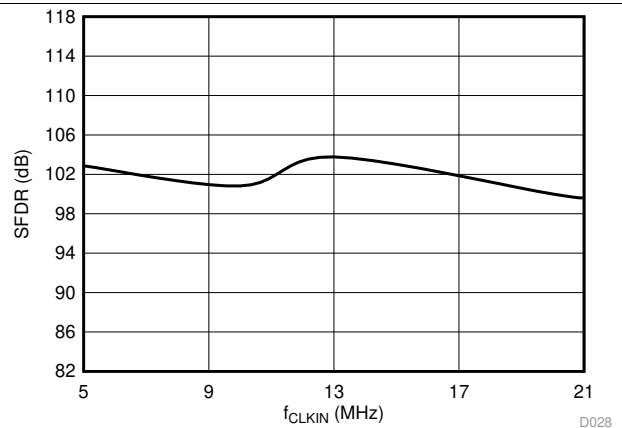

Figure 33. Spurious-Free Dynamic Range vs Clock Frequency

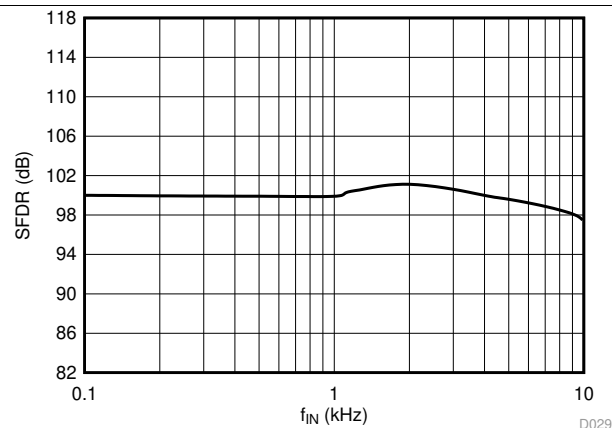

Figure 34. Spurious-Free Dynamic Range vs Input Signal Frequency

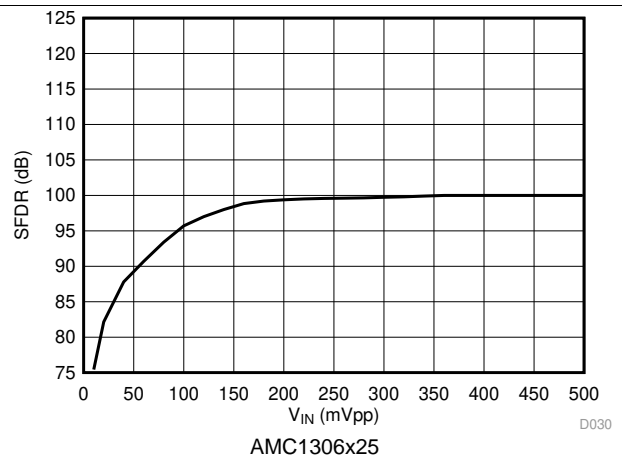

Figure 35. Spurious-Free Dynamic Range vs Input Signal Amplitude

Typical Characteristics (continued)

at AVDD = 5 V, DVDD = 3.3 V, AINP = -50 mV to 50 mV (AMC1306x05) or -250 mV to 250 mV (AMC1306x25), AINN = AGND, f_{CLKIN} = 20 MHz, and sinc³ filter with OSR = 256 (unless otherwise noted)

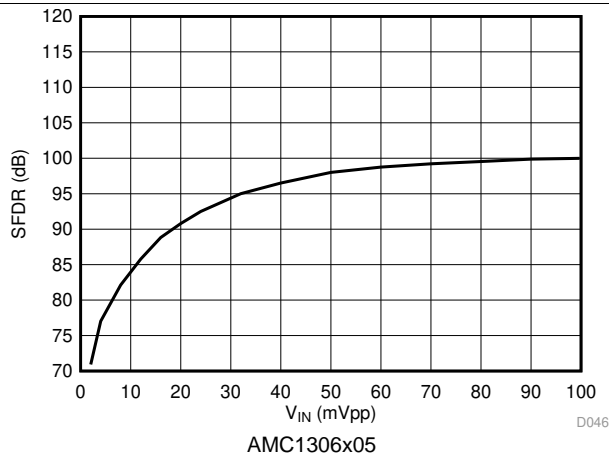

Figure 36. Spurious-Free Dynamic Range vs Input Signal Amplitude

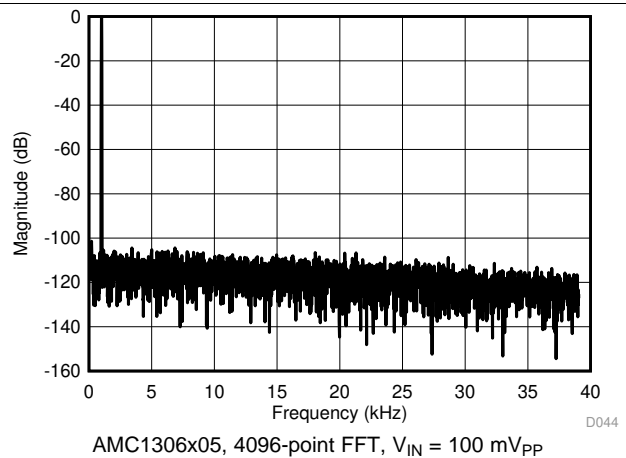

Figure 37. Frequency Spectrum with 1-kHz Input Signal

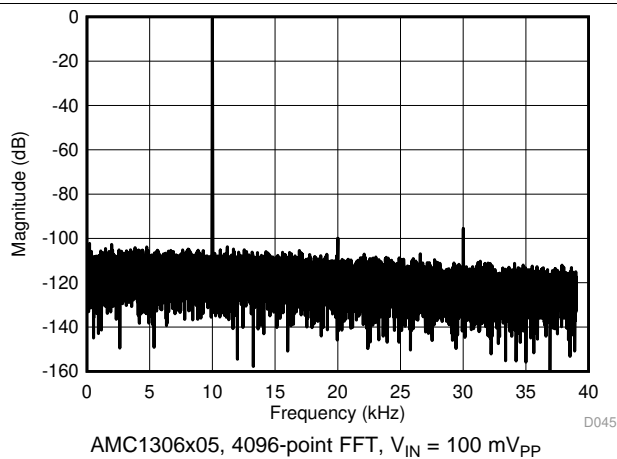

Figure 38. Frequency Spectrum with 10-kHz Input Signal

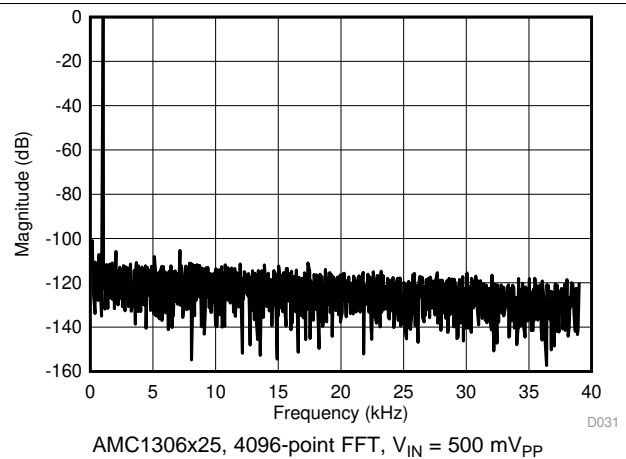

Figure 39. Frequency Spectrum with 1-kHz Input Signal

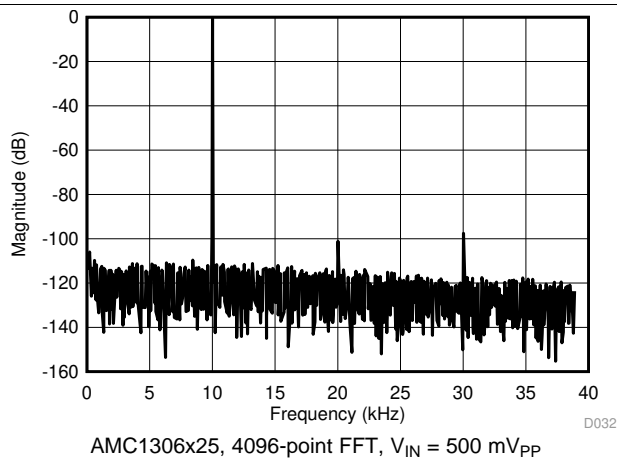

Figure 40. Frequency Spectrum with 10-kHz Input Signal

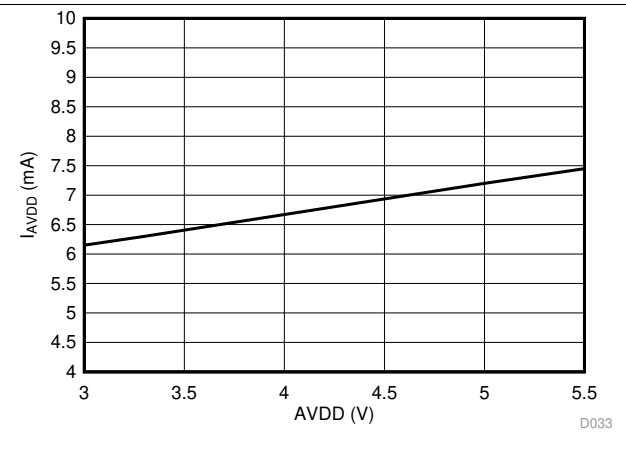

Figure 41. High-Side Supply Current vs High-Side Supply Voltage

Typical Characteristics (continued)

at AVDD = 5 V, DVDD = 3.3 V, AINP = -50 mV to 50 mV (AMC1306x05) or -250 mV to 250 mV (AMC1306x25), AINN = AGND, f_{CLKIN} = 20 MHz, and sinc³ filter with OSR = 256 (unless otherwise noted)

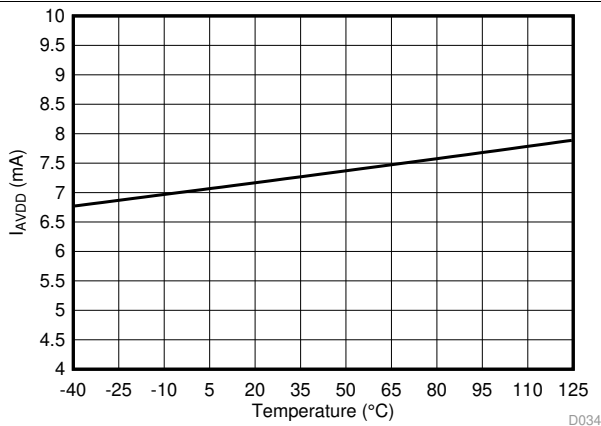

Figure 42. High-Side Supply Current vs Temperature

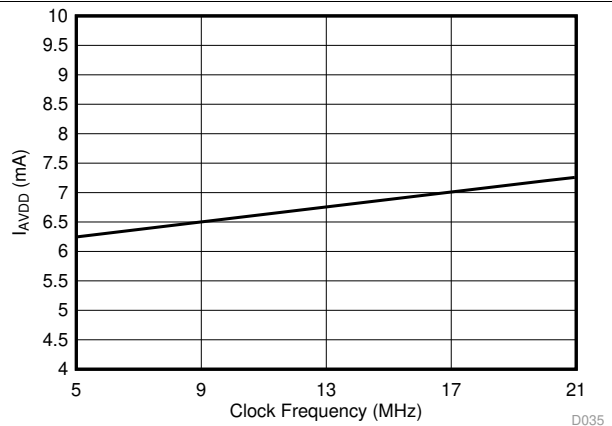

Figure 43. High-Side Supply Current vs Clock Frequency

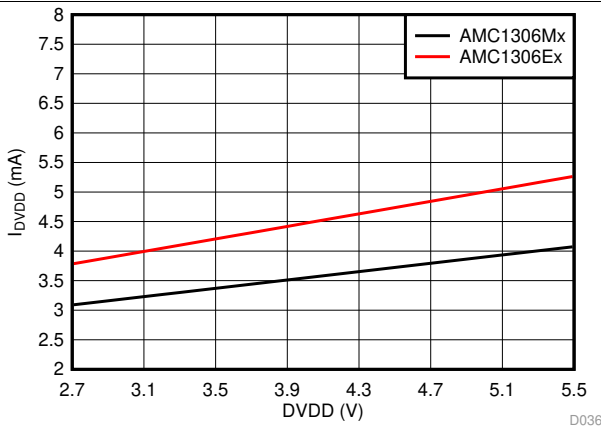

Figure 44. Controller-Side Supply Current vs Controller-Side Supply Voltage

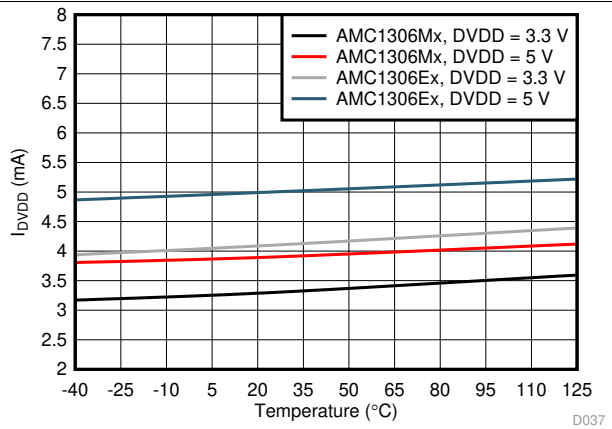

Figure 45. Controller-Side Supply Current vs Temperature

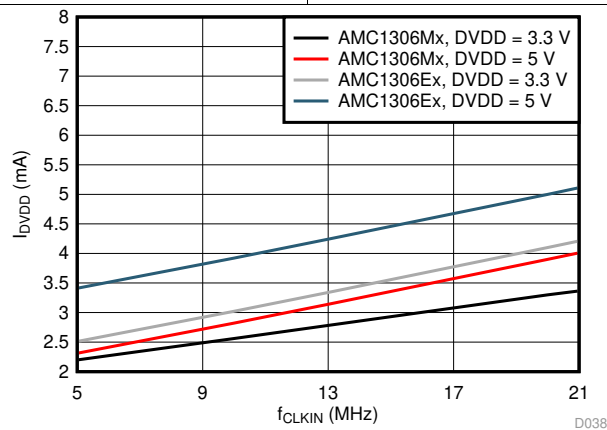

Figure 46. Controller-Side Supply Current vs Clock Frequency

8 Detailed Description

8.1 Overview

The differential analog input (comprised of input signals AINP and AINN) of the AMC1306 is a fully-differential amplifier feeding the switched-capacitor input of a second-order, delta-sigma ($\Delta\Sigma$) modulator stage that digitizes the input signal into a 1-bit output stream. The isolated data output DOUT of the converter provides a stream of digital ones and zeros that is synchronous to the externally-provided clock source at the CLKIN pin with a frequency in the range of 5 MHz to 21 MHz. The time average of this serial bitstream output is proportional to the analog input voltage.

The [Functional Block Diagram](#) section shows a detailed block diagram of the AMC1306. The analog input range is tailored to directly accommodate a voltage drop across a shunt resistor used for current sensing. The silicon-dioxide (SiO_2) based capacitive isolation barrier supports a high level of magnetic field immunity as described in the [ISO72x Digital Isolator Magnetic-Field Immunity](#) application report, available for download at www.ti.com. The external clock input simplifies the synchronization of multiple current-sensing channels on the system level. The extended frequency range of up to 21 MHz supports higher performance levels compared to the other solutions available on the market.

8.2 Functional Block Diagram

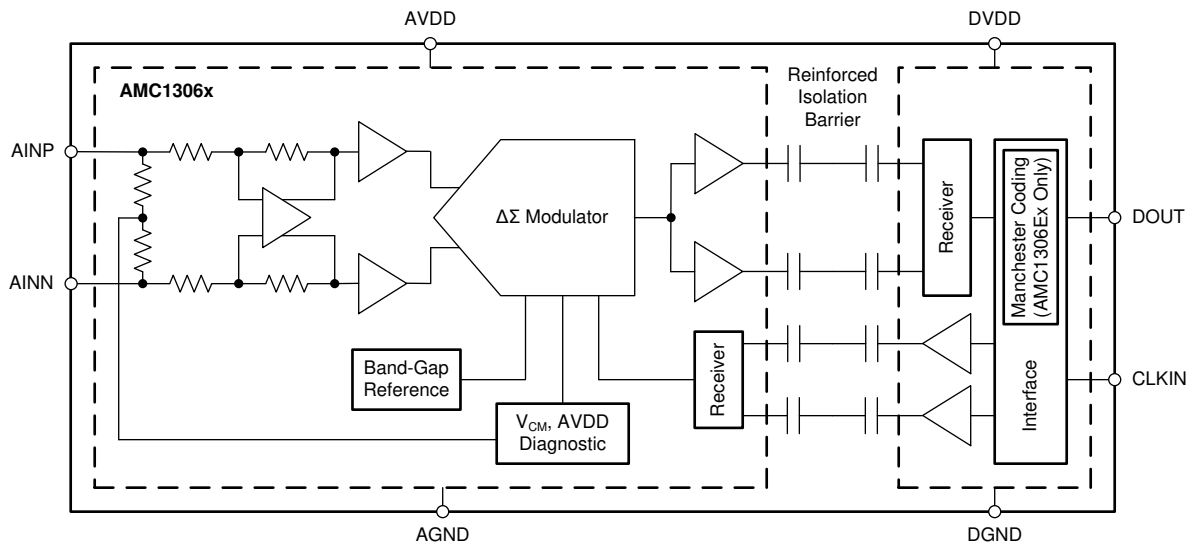

8.3 Feature Description

8.3.1 Analog Input

The AMC1306 incorporates front-end circuitry that contains a differential amplifier and a sampling stage, followed by a $\Delta\Sigma$ modulator. The gain of the differential amplifier is set by internal precision resistors to a factor of 4 for devices with a specified input voltage range of ± 250 mV (this value is for the AMC1306x25), or to a factor of 20 in devices with a ± 50 -mV input voltage range (for the AMC1306x05), resulting in a differential input impedance of 4.9 k Ω (for the AMC1306x05) or 22 k Ω (for the AMC1306x25). For reduced offset and offset drift, the differential amplifier is chopper-stabilized with the switching frequency set at $f_{CLKIN} / 32$. The switching frequency generates a spur as shown in Figure 47.

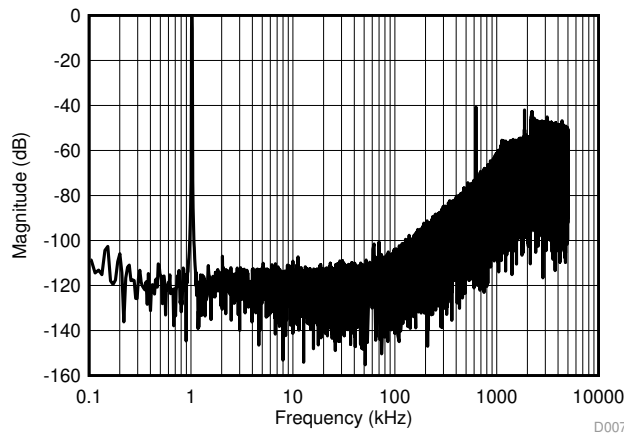

sinc^3 filter, $\text{OSR} = 2$, $f_{CLKIN} = 20$ MHz, $f_{IN} = 1$ kHz

Figure 47. Quantization Noise Shaping

Consider the input impedance of the AMC1306 in designs with high-impedance signal sources that can cause degradation of gain and offset specifications. The importance of this effect, however, depends on the desired system performance. Additionally, the input bias current caused by the internal common-mode voltage at the output of the differential amplifier is dependent on the actual amplitude of the input signal; see the [Isolated Voltage Sensing](#) section for more details on reducing these effects.

There are two restrictions on the analog input signals (AINP and AINN). First, if the input voltage exceeds the range $\text{AGND} - 6$ V to $\text{AVDD} + 0.5$ V, the input current must be limited to 10 mA because the device input electrostatic discharge (ESD) diodes turn on. In addition, the linearity and noise performance of the device are ensured only when the differential analog input voltage remains within the specified linear full-scale range (FSR), that is ± 250 mV (for the AMC1306x25) or ± 50 mV (for the AMC1306x05), and within the specified input common-mode range.

Feature Description (continued)

8.3.2 Modulator

The modulator implemented in the AMC1306 is a second-order, switched-capacitor, feed-forward $\Delta\Sigma$ modulator, such as the one conceptualized in Figure 48. The analog input voltage V_{IN} and the output V_5 of the 1-bit digital-to-analog converter (DAC) are differentiated, providing an analog voltage V_1 at the input of the first integrator stage. The output of the first integrator feeds the input of the second integrator stage, resulting in output voltage V_3 that is differentiated with the input signal V_{IN} and the output of the first integrator V_2 . Depending on the polarity of the resulting voltage V_4 , the output of the comparator is changed. In this case, the 1-bit DAC responds on the next clock pulse by changing the associated analog output voltage V_5 , causing the integrators to progress in the opposite direction and forcing the value of the integrator output to track the average value of the input.

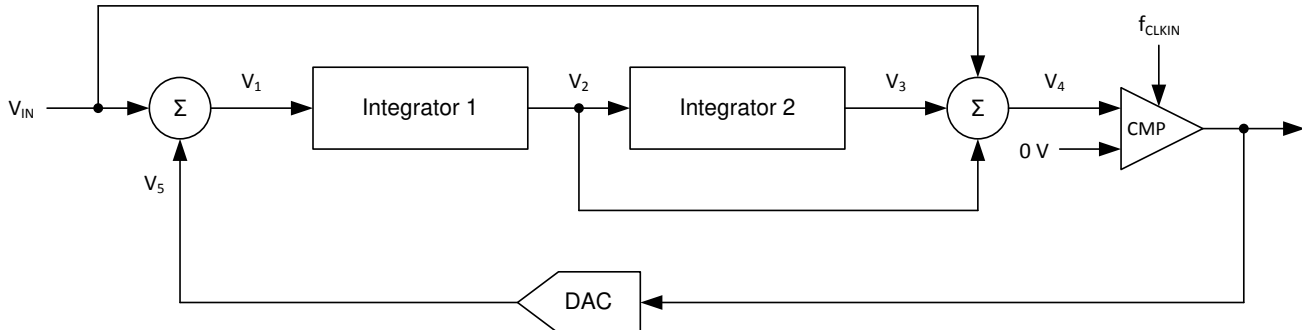

Figure 48. Block Diagram of a Second-Order Modulator

The modulator shifts the quantization noise to high frequencies, as shown in Figure 48. Therefore, use a low-pass digital filter at the output of the device to increase the overall performance. This filter is also used to convert from the 1-bit data stream at a high sampling rate into a higher-bit data word at a lower rate (decimation). TI's microcontroller families TMS320F2807x and TMS320F2837x offer a suitable programmable, hardwired filter structure termed a *sigma-delta filter module* (SDFM) optimized for usage with the AMC1306 family. Also, SD24_B converters on the MSP430F677x microcontrollers offer a path to directly access the integrated sinc-filters for a simple system-level solution for multichannel, isolated current sensing. An additional option is to use a suitable application-specific device, such as the AMC1210 (a four-channel digital sinc-filter). Alternatively, a field-programmable gate array (FPGA) can be used to implement the filter.

Feature Description (continued)

8.3.3 Isolation Channel Signal Transmission

The AMC1306 device uses an on-off keying (OOK) modulation scheme to transmit the modulator output bitstream across the capacitive SiO₂-based isolation barrier. The transmitter modulates the bitstream at TX IN in Figure 49 with an internally-generated, 480-MHz carrier across the isolation barrier to represent a digital *one* and sends a *no signal* to represent the digital *zero*. The receiver demodulates the signal after advanced signal conditioning and produces the output. The symmetrical design of each isolation channel improves the CMTI performance and reduces the radiated emissions caused by the high-frequency carrier. The block diagram of an isolation channel integrated in the AMC1306 is shown in Figure 49.

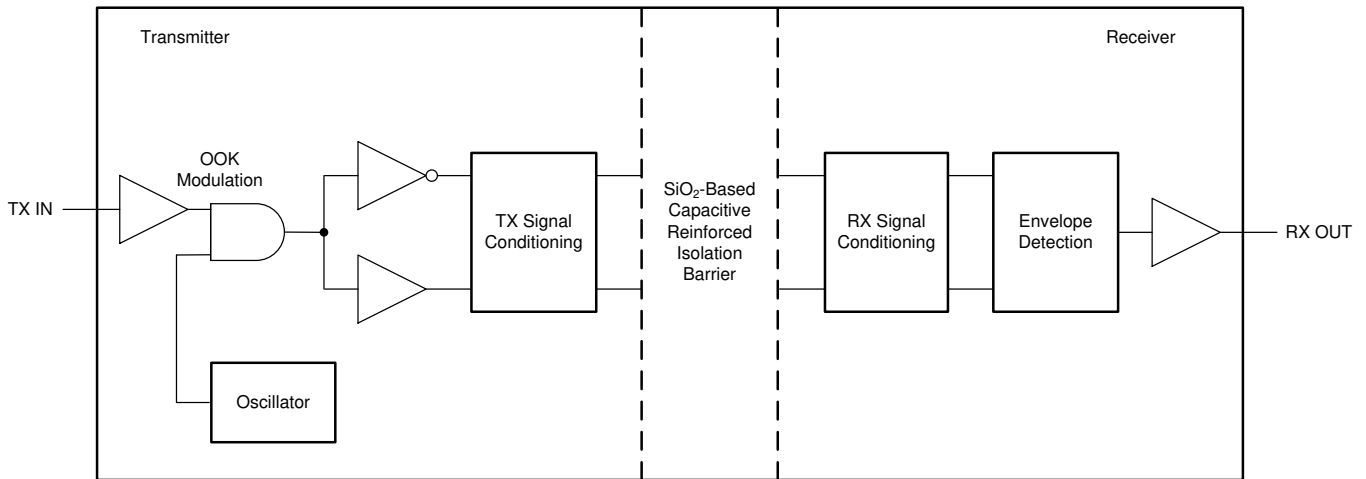

Figure 49. Block Diagram of an Isolation Channel

Figure 50 shows the concept of the on-off keying scheme.

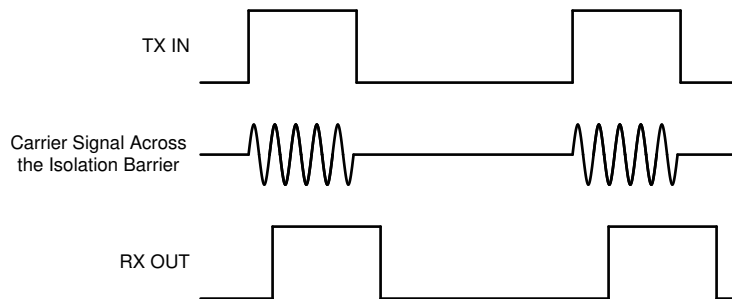

Figure 50. OOK-Based Modulation Scheme

Feature Description (continued)

8.3.4 Digital Output

A differential input signal of 0 V ideally produces a stream of ones and zeros that are high 50% of the time. A differential input of 250 mV (for the AMC1306x25) or 50 mV (for the AMC1306x05) produces a stream of ones and zeros that are high 89.06% of the time. With 16 bits of resolution, that percentage ideally corresponds to the code 58368. A differential input of –250 mV (–50 mV for the AMC1306x05) produces a stream of ones and zeros that are high 10.94% of the time and ideally results in code 7168 with 16-bit resolution. These input voltages are also the specified linear ranges of the different AMC1306 versions with performance as specified in this document. If the input voltage value exceeds these ranges, the output of the modulator shows nonlinear behavior when the quantization noise increases. The output of the modulator clips with a stream of only zeros with an input less than or equal to –320 mV (–64 mV for the AMC1306x05) or with a stream of only ones with an input greater than or equal to 320 mV (64 mV for the AMC1306x05). In this case, however, the AMC1306 generates a single 1 (if the input is at negative full-scale) or 0 every 128 clock cycles to indicate proper device function (see the [Fail-Safe Output](#) section for more details). The input voltage versus the output modulator signal is shown in [Figure 51](#).

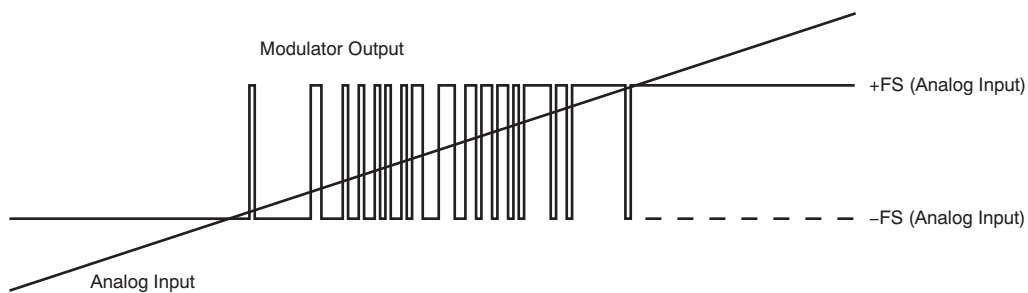

Figure 51. Analog Input versus the AMC1306 Modulator Output

The density of ones in the output bitstream for any input voltage value (with the exception of a full-scale input signal, as described in the [Output Behavior in Case of a Full-Scale Input](#) section) can be calculated using [Equation 1](#):

$$\frac{V_{IN} + V_{Clipping}}{2 \times V_{Clipping}} \quad (1)$$

The AMC1306 system clock is provided externally at the CLKIN pin. For more details, see the [Switching Characteristics](#) table and the [Manchester Coding Feature](#) section.

8.3.5 Manchester Coding Feature

The AMC1306Ex offers the IEEE 802.3-compliant Manchester coding feature that generates at least one transition per bit to support clock signal recovery from the bitstream. A Manchester coded bitstream is free of dc components. The Manchester coding combines the clock and data information using exclusive or (XOR) logical operation and results in a bitstream as shown in [Figure 52](#). The duty cycle of the Manchester encoded bitstream depends on the duty cycle of the input clock CLKIN.

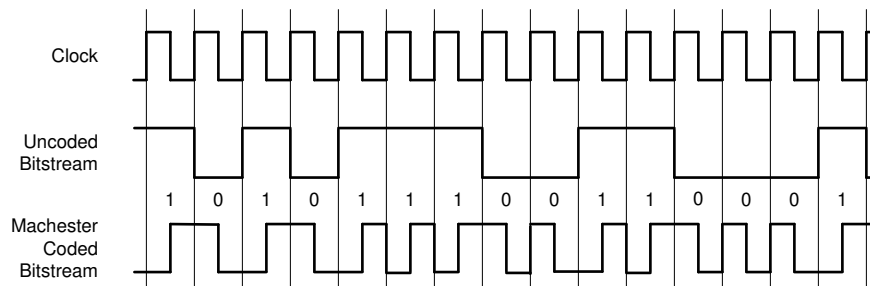

Figure 52. Manchester Coded Output of the AMC1306Ex

8.4 Device Functional Modes

8.4.1 Fail-Safe Output

In the case of a missing high-side supply voltage AVDD, the output of a $\Delta\Sigma$ modulator is not defined and can cause a system malfunction. In systems with high safety requirements, this behavior is not acceptable. Therefore, the AMC1306 implements a fail-safe output function that ensures that the output DOUT of the device offers a steady-state bitstream of logic 0's in case of a missing AVDD, as shown in Figure 53.

Additionally, if the common-mode voltage of the input reaches or exceeds the specified common-mode overvoltage detection level V_{CMov} as defined in the *Electrical Characteristics* table, the AMC1306 offers a steady-state bitstream of logic 1's at the output DOUT, as also shown in Figure 53.

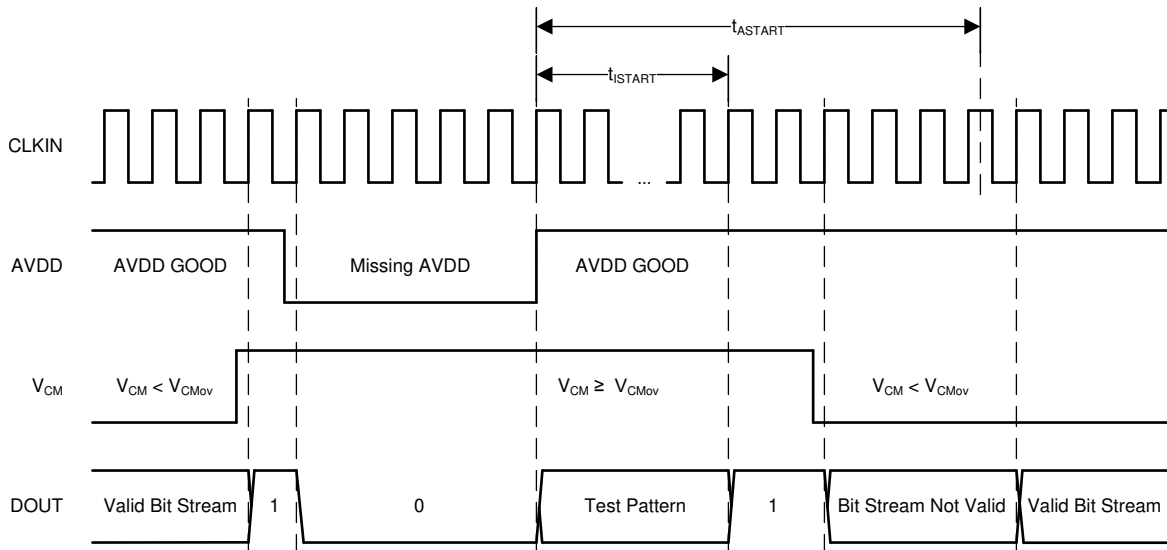

Figure 53. Fail-Safe Output of the AMC1306

8.4.2 Output Behavior in Case of a Full-Scale Input

If a full-scale input signal is applied to the AMC1306 (that is, $V_{IN} \geq V_{Clipping}$), the device generates a single one or zero every 128 bits at DOUT, depending on the actual polarity of the signal being sensed, as shown in Figure 54. In this way, differentiating between a missing AVDD and a full-scale input signal is possible on the system level.

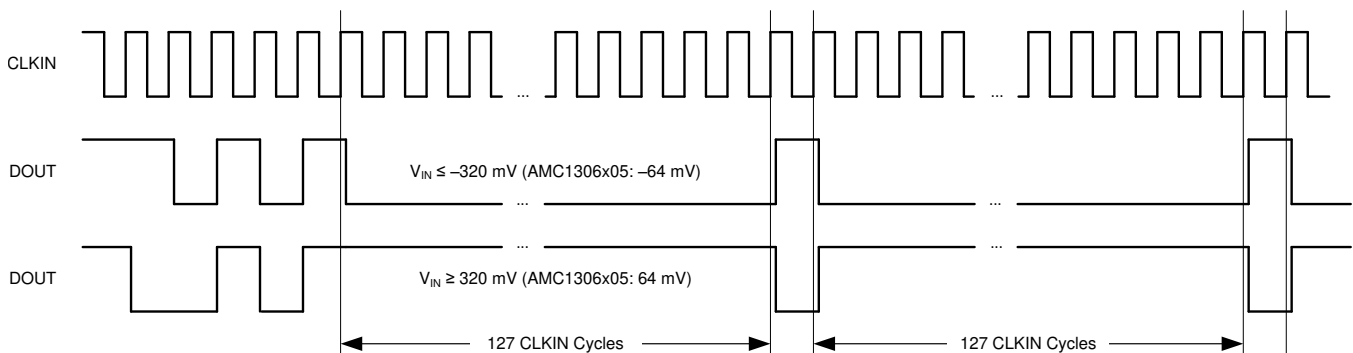

Figure 54. Overrange Output of the AMC1306

9 Application and Implementation

NOTE

Information in the following applications sections is not part of the TI component specification, and TI does not warrant its accuracy or completeness. TI's customers are responsible for determining suitability of components for their purposes. Customers should validate and test their design implementation to confirm system functionality.

9.1 Application Information

9.1.1 Digital Filter Usage

The modulator generates a bitstream that is processed by a digital filter to obtain a digital word similar to a conversion result of a conventional analog-to-digital converter (ADC). A very simple filter, built with minimal effort and hardware, is a sinc³-type filter, as shown in Equation 2:

$$H(z) = \left(\frac{1 - z^{-OSR}}{1 - z^{-1}} \right)^3 \quad (2)$$

This filter provides the best output performance at the lowest hardware size (count of digital gates) for a second-order modulator. All the characterization in this document is also done with a sinc³ filter with an oversampling ratio (OSR) of 256 and an output word width of 16 bits.

The effective number of bits (ENOB) is often used to compare the performance of ADCs and $\Delta\Sigma$ modulators. Figure 55 shows the ENOB of the AMC1306 with different oversampling ratios. In this document, this number is calculated from the SINAD by using Equation 3:

$$\text{SINAD} = 1.76 \text{ dB} + 6.02 \text{ dB} \times \text{ENOB} \quad (3)$$

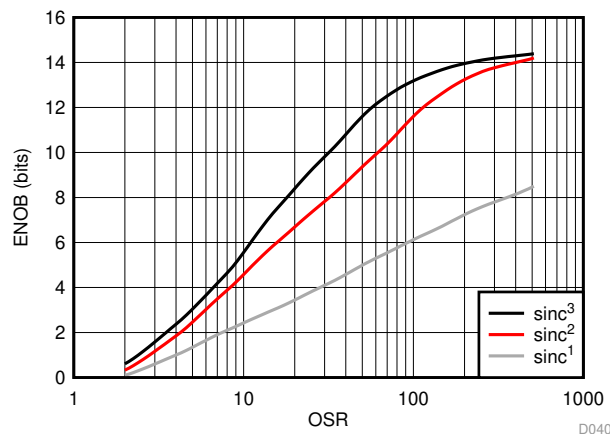

Figure 55. Measured Effective Number of Bits versus Oversampling Ratio

An example code for implementing a sinc³ filter in an FPGA is discussed in the *Combining the ADS1202 with an FPGA Digital Filter for Current Measurement in Motor Control Applications* application note, available for download at www.ti.com.

9.2 Typical Applications

9.2.1 Frequency Inverter Application

Isolated $\Delta\Sigma$ modulators are being widely used in frequency inverter designs because of their high ac and dc performance. Frequency inverters are critical parts of industrial motor drives, photovoltaic inverters (string and central inverters), uninterruptible power supplies (UPS), electrical and hybrid electrical vehicles, and other industrial applications.

Figure 56 shows a simplified schematics of the AMC1306Mx in a typical frequency inverter application as used in industrial motor drives with shunt resistors (R_{SHUNT}) used for current sensing. Depending on the system design, either all three or only two motor phase currents are sensed.

The Manchester coded bitstream output of the AMC1306Ex minimizes the wiring efforts of the connection between the power board and the control board; see Figure 57. This bitstream output also allows the clock to be generated locally on the power board without the having to adjust the propagation delay time of each DOUT connection to fulfill the setup and hold time requirements of the microcontroller.

In both examples, an additional fourth AMC1306 is used to support isolated voltage sensing of the dc link. This high voltage is reduced using a high-impedance resistive divider and is sensed by the device across a smaller resistor. The value of this resistor can degrade the performance of the measurement, as described in the [Isolated Voltage Sensing](#) section.

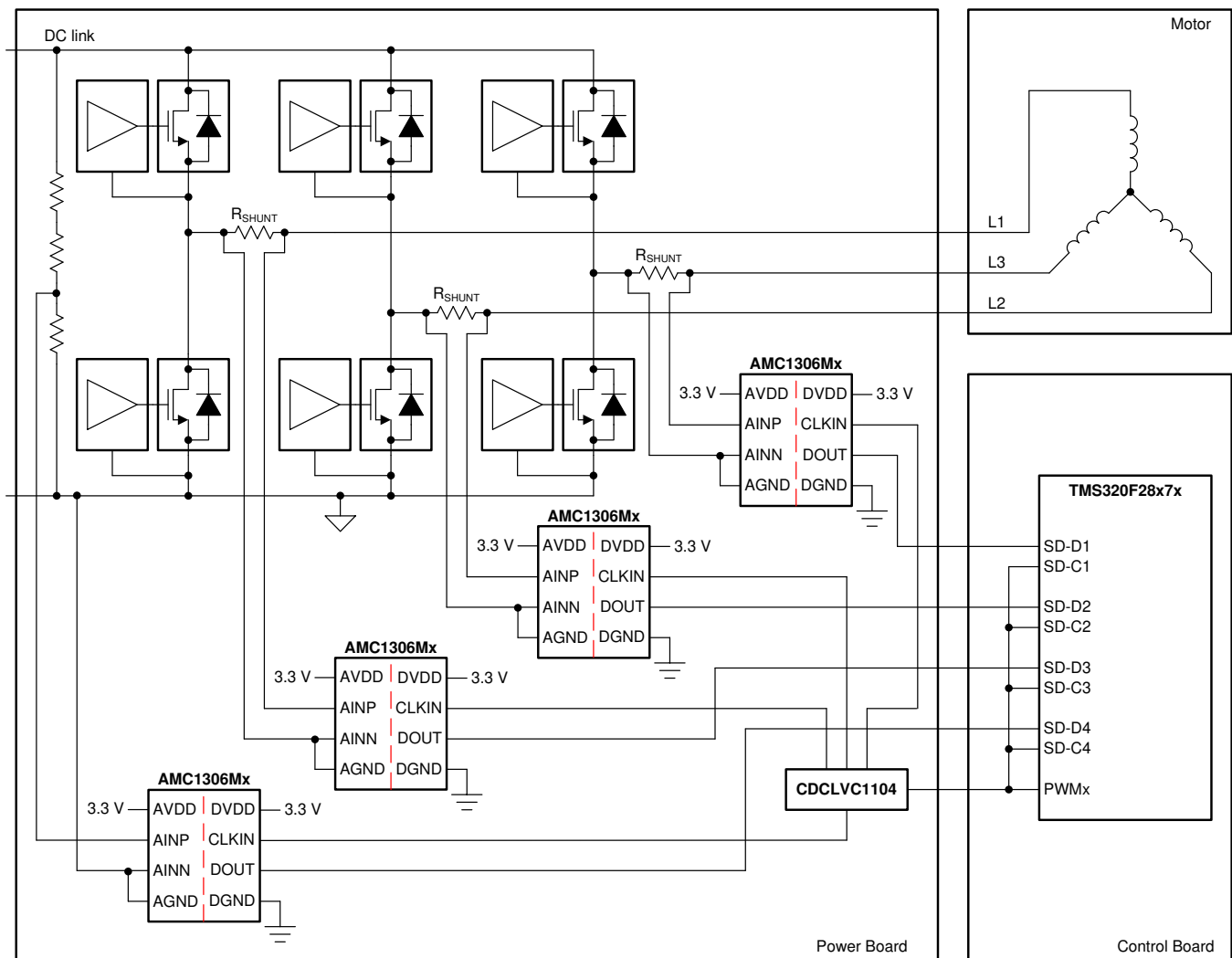

Figure 56. The AMC1306Mx in a Frequency Inverter Application

Typical Applications (continued)

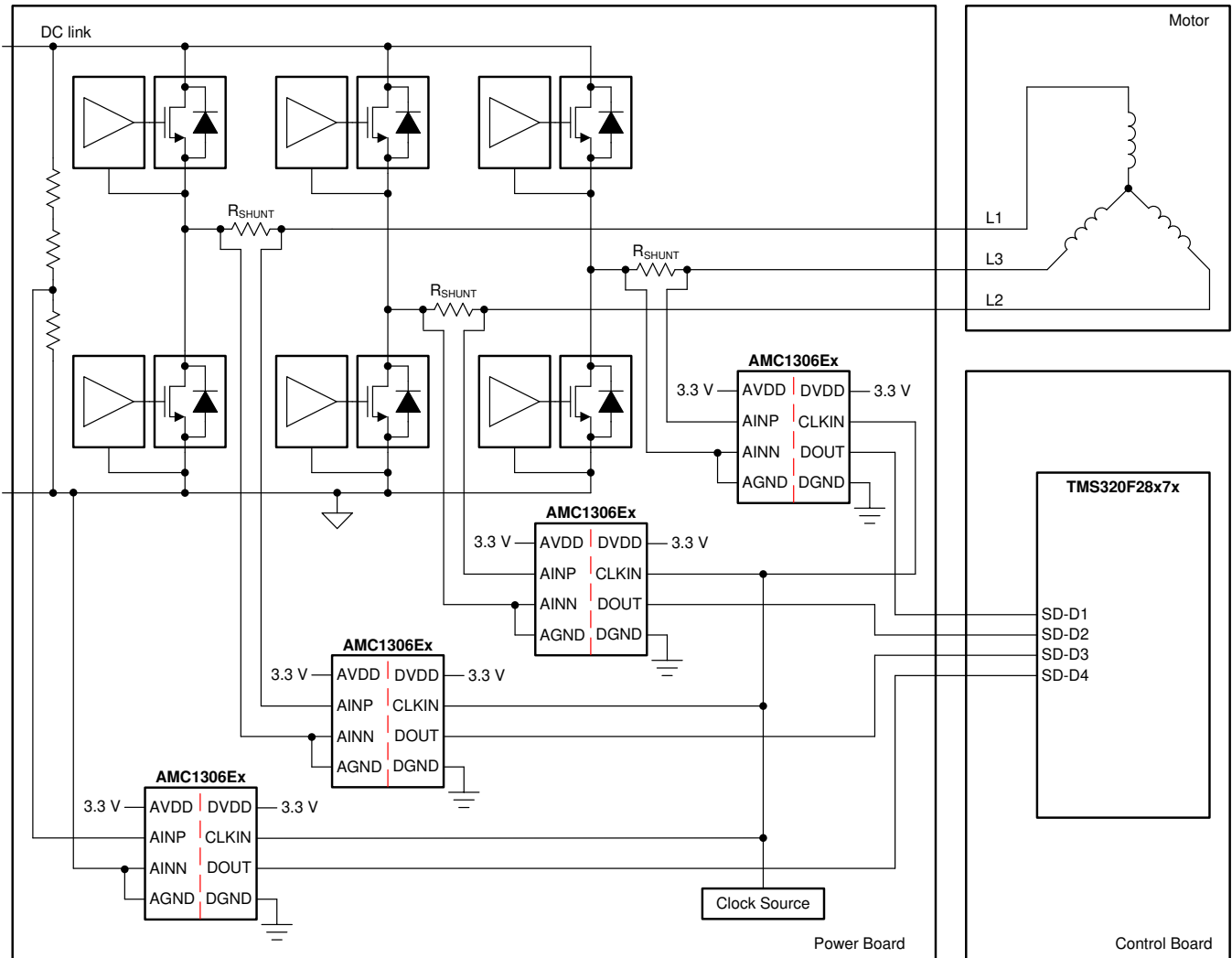

Figure 57. The AMC1306Ex in a Frequency Inverter Application

9.2.1.1 Design Requirements

Table 1 lists the parameters for the typical application in the *Frequency Inverter Application* section.

Table 1. Design Requirements

PARAMETER	VALUE
High-side supply voltage	3.3 V or 5 V
Low-side supply voltage	3.3 V or 5 V
Voltage drop across the shunt for a linear response	±250 mV (maximum)

9.2.1.2 Detailed Design Procedure

The high-side power supply (AVDD) for the AMC1306 device is derived from the power supply of the upper gate driver. Further details are provided in the [Power Supply Recommendations](#) section.

The floating ground reference (AGND) is derived from one of the ends of the shunt resistor that is connected to the negative input of the AMC1306 (AINN). If a four-pin shunt is used, the inputs of the device are connected to the inner leads and AGND is connected to one of the outer shunt leads.

Use Ohm's Law to calculate the voltage drop across the shunt resistor (V_{SHUNT}) for the desired measured current: $V_{SHUNT} = I \times R_{SHUNT}$.

Consider the following two restrictions to choose the proper value of the shunt resistor R_{SHUNT} :

- The voltage drop caused by the nominal current range must not exceed the recommended differential input voltage range: $V_{SHUNT} \leq \pm 250 \text{ mV}$
- The voltage drop caused by the maximum allowed overcurrent must not exceed the input voltage that causes a clipping output: $|V_{SHUNT}| \leq |V_{Clipping}|$

The typically recommended RC filter in front of a $\Delta\Sigma$ modulator to improve signal-to-noise performance of the signal path is not required for the AMC1306. By design, the input bandwidth of the analog front-end of the device is limited as specified in the [Electrical Characteristics](#) table.

For modulator output bitstream filtering, a device from TI's [TMS320F2807x](#) family of low-cost microcontrollers (MCUs) or [TMS320F2837x](#) family of dual-core MCUs is recommended. These families support up to eight channels of dedicated hardwired filter structures that significantly simplify system level design by offering two filtering paths per channel: one providing high accuracy results for the control loop and one fast response path for overcurrent detection.

9.2.1.3 Application Curve

In motor control applications, a very fast response time for overcurrent detection is required. The time for fully settling the filter in case of a step-signal at the input of the modulator depends on the filter order; that is, a sinc^3 filter requires three data updates for full settling (with $f_{DATA} = f_{CLK} / OSR$). Therefore, for overcurrent protection, filter types other than sinc^3 can be a better choice; an alternative is the sinc^2 filter. [Figure 58](#) compares the settling times of different filter orders.

The delay time of the sinc filter with a continuous signal is half of the settling time.

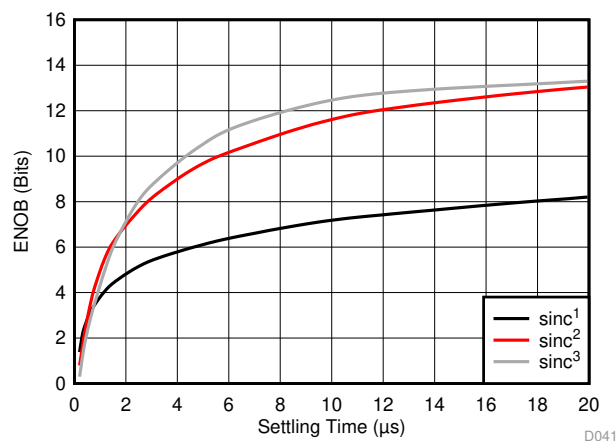

Figure 58. Measured Effective Number of Bits versus Settling Time

9.2.2 Isolated Voltage Sensing

The AMC1306 is optimized for usage in current-sensing applications using low-impedance shunts. However, the device can also be used in isolated voltage-sensing applications if the affect of the (usually higher) impedance of the resistor used in this case is considered.

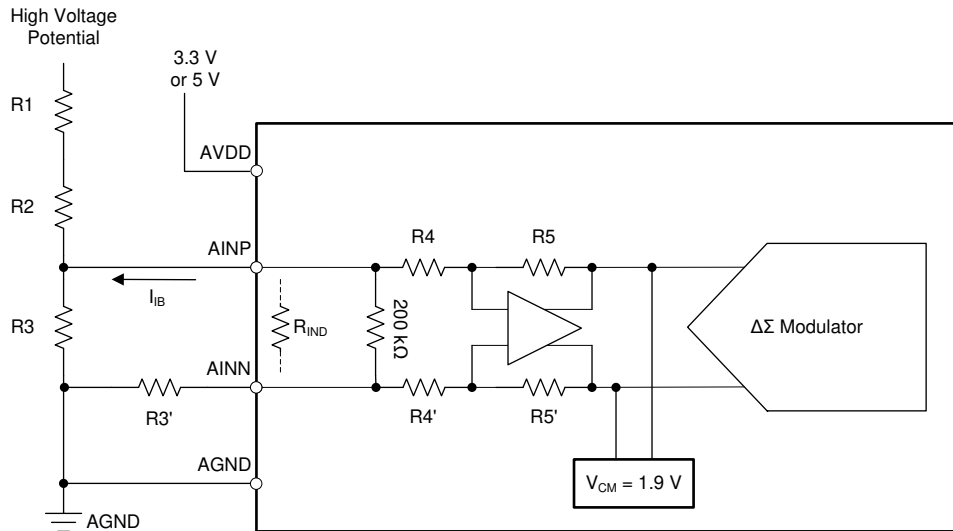

Figure 59. Using the AMC1306 for Isolated Voltage Sensing

9.2.2.1 Design Requirements

Figure 59 shows a simplified circuit typically used in high-voltage-sensing applications. The high impedance resistors (R1 and R2) are used as voltage dividers and dominate the current value definition. The resistance of the sensing resistor R3 is chosen to meet the input voltage range of the AMC1306. This resistor and the differential input impedance of the device (the AMC1306x25 is 22 kΩ, the AMC1306x05 is 4.9 kΩ) also create a voltage divider that results in an additional gain error. With the assumption of R1, R2, and R_{IN} having a considerably higher value than R3, the resulting total gain error can be estimated using Equation 4, with E_G being the gain error of the AMC1306.

$$|E_{G_{tot}}| = |E_G| + \frac{R3}{R_{IN}} \quad (4)$$

This gain error can be easily minimized during the initial system-level gain calibration procedure.

9.2.2.2 Detailed Design Procedure

As indicated in Figure 59, the output of the integrated differential amplifier is internally biased to a common-mode voltage of 1.9 V. This voltage results in a bias current I_{IB} through the resistive network R4 and R5 (or R4' and R5') used for setting the gain of the amplifier. The value range of this current is specified in the [Electrical Characteristics](#) table. This bias current generates additional offset error that depends on the value of the resistor R3. The initial system offset calibration does not minimize this effect because the value of the bias current depends on the actual common-mode amplitude of the input signal (as illustrated in Figure 60). Therefore, in systems with high accuracy requirements, a series resistor is recommended to be used at the negative input (AINN) of the AMC1306 with a value equal to the shunt resistor R3 (that is, R3' = R3 in Figure 59) to eliminate the effect of the bias current.

This additional series resistor ($R3'$) influences the gain error of the circuit. The effect can be calculated using Equation 5 with $R5 = R5' = 50 \text{ k}\Omega$ and $R4 = R4' = 2.5 \text{ k}\Omega$ (for the AMC1306x05) or $12.5 \text{ k}\Omega$ (for the AMC1306x25).

$$E_G(\%) = \left(1 - \frac{R4}{R4' + R3'} \right) \times 100\% \quad (5)$$

9.2.2.3 Application Curve

Figure 60 shows the dependency of the input bias current on the common-mode voltage at the input of the AMC1306.

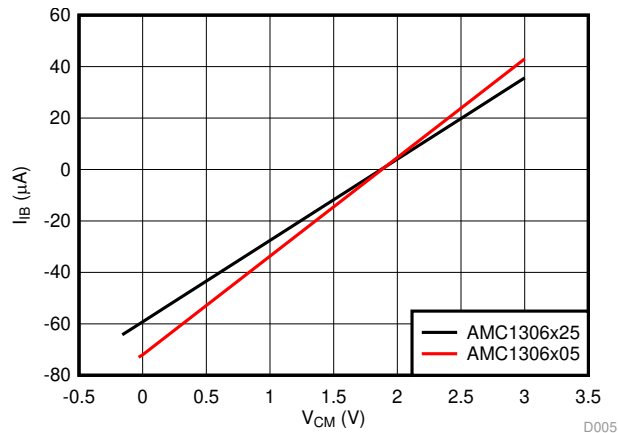

Figure 60. Input Bias Current vs Common-Mode Input Voltage

9.2.3 What To Do and What Not To Do

Do not leave the inputs of the AMC1306 unconnected (floating) when the device is powered up. If both modulator inputs are left floating, the input bias current drives these inputs to the output common-mode of the analog front-end of approximately 1.9 V. If that voltage is above the specified input common-mode range, the front gain diminishes and the modulator outputs a bitstream resembling a zero input differential voltage.

10 Power Supply Recommendations

In a typical frequency-inverter application, the high-side power supply (AVDD) for the device is directly derived from the floating power supply of the upper gate driver. For lowest system-level cost, a Zener diode can be used to limit the voltage to 5 V or 3.3 V ($\pm 10\%$). Alternatively a low-cost low-drop regulator (LDO), for example the LM317-N, can be used to adjust the supply voltage level and minimize noise on the power-supply node. A low-ESR decoupling capacitor of 0.1 μF is recommended for filtering this power-supply path. Place this capacitor (C2 in Figure 61) as close as possible to the AVDD pin of the AMC1306 for best performance. If better filtering is required, an additional 10- μF capacitor can be used.

The floating ground reference (AGND) is derived from the end of the shunt resistor that is connected to the negative input (AINN) of the device. If a four-pin shunt is used, the device inputs are connected to the inner leads and AGND is connected to one of the outer leads of the shunt.

For decoupling of the digital power supply on the controller side, a 0.1- μF capacitor is recommended to be placed as close to the DVDD pin of the AMC1306 as possible, followed by an additional capacitor in the range of 1 μF to 10 μF .

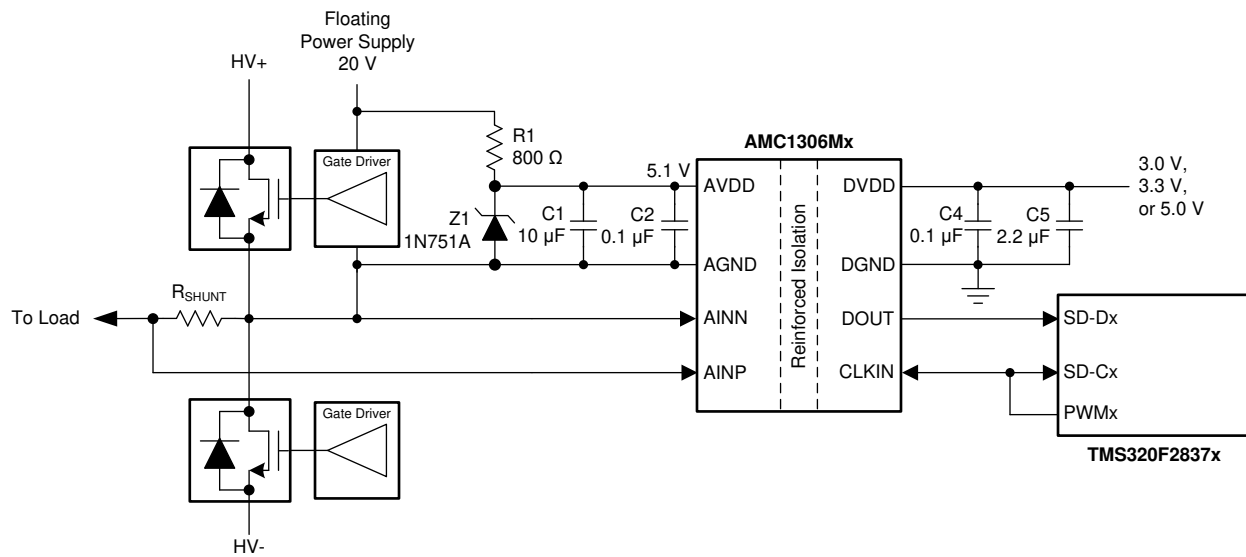

Figure 61. Decoupling the AMC1306

11 Layout

11.1 Layout Guidelines

A layout recommendation showing the critical placement of the decoupling capacitors (as close as possible to the AMC1306) and placement of the other components required by the device is shown in Figure 62. For best performance, place the shunt resistor close to the AINP and AINN inputs of the AMC1306 and keep the layout of both connections symmetrical.

11.2 Layout Example

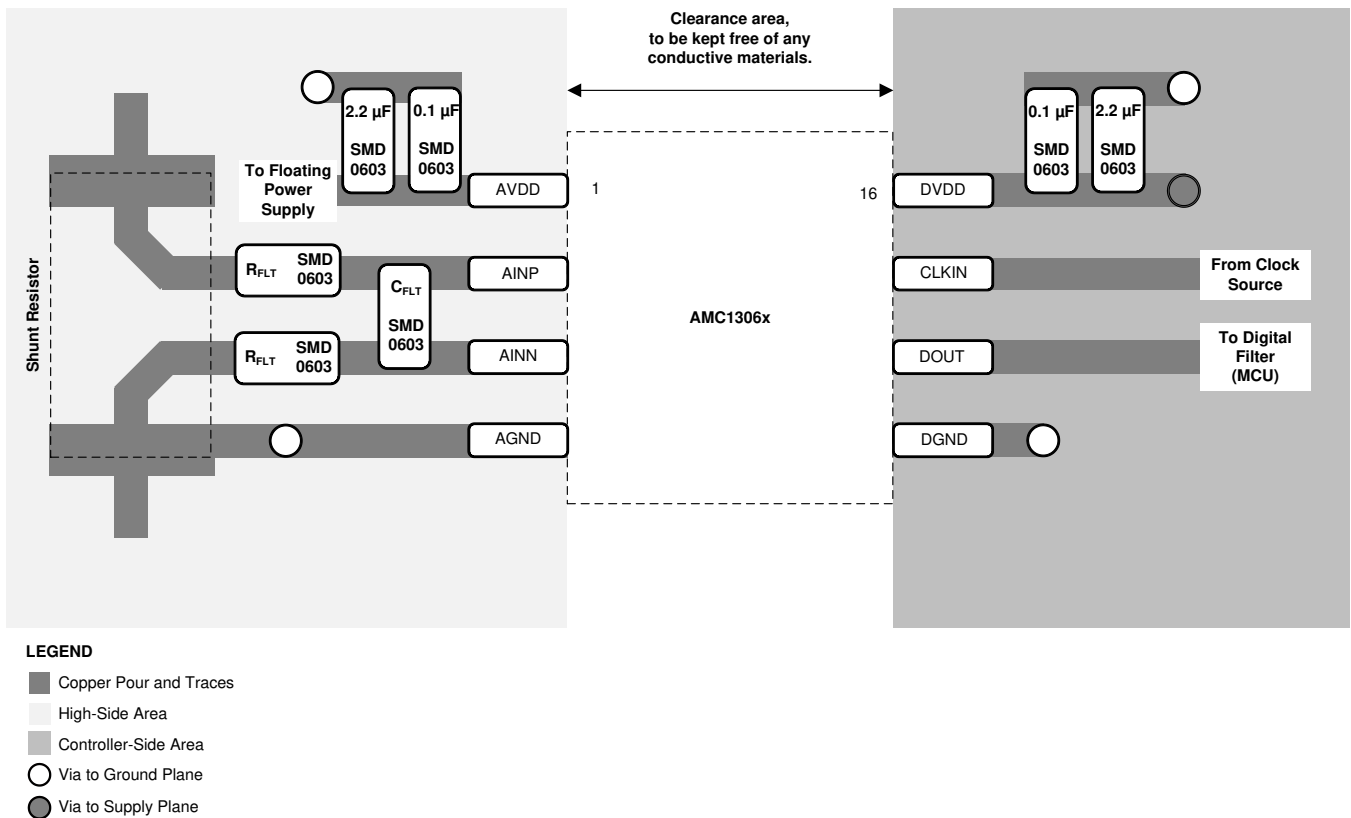

Figure 62. Recommended Layout of the AMC1306x

12 器件和文档支持

12.1 器件支持

12.1.1 器件命名规则

12.1.1.1 隔离相关术语

请参阅《[隔离相关术语](#)》

12.2 文档支持

12.2.1 相关文档

请参阅如下相关文档：

- 《[适用于二阶 \$\Delta\$ - \$\Sigma\$ 调制器的 AMC1210 四路数字滤波器](#)》
- 《[MSP430F677x 多相位仪表计量 SoC](#)》
- 《[TMS320F2807x Piccolo™ 微控制器](#)》
- 《[TMS320F2837xD 双核 Delfino™ 微控制器](#)》
- 《[ISO72x 数字隔离器磁场抗扰度](#)》
- 《[将 ADS1202 与 FPGA 数字滤波器结合，以便在电机控制应用中进行电流测量](#)》
- 《[CDCLVC11xx 3.3V 和 2.5V LVCMOS 高性能时钟缓冲器系列](#)》

12.3 相关链接

下表列出了快速访问链接。类别包括技术文档、支持和社区资源、工具和软件，以及立即订购快速访问。

表 2. 相关链接

器件	产品文件夹	立即订购	技术文档	工具与软件	支持和社区
AMC1306E05	单击此处	单击此处	单击此处	单击此处	单击此处
AMC1306E25	单击此处	单击此处	单击此处	单击此处	单击此处
AMC1306M05	单击此处	单击此处	单击此处	单击此处	单击此处
AMC1306M25	单击此处	单击此处	单击此处	单击此处	单击此处

12.4 接收文档更新通知

要接收文档更新通知，请导航至 ti.com 上的器件产品文件夹。单击右上角的通知我进行注册，即可每周接收产品信息更改摘要。有关更改的详细信息，请查看任何已修订文档中包含的修订历史记录。

12.5 社区资源

[TI E2E™ support forums](#) are an engineer's go-to source for fast, verified answers and design help — straight from the experts. Search existing answers or ask your own question to get the quick design help you need.

Linked content is provided "AS IS" by the respective contributors. They do not constitute TI specifications and do not necessarily reflect TI's views; see TI's [Terms of Use](#).

12.6 商标

E2E is a trademark of Texas Instruments.

All other trademarks are the property of their respective owners.

12.7 静电放电警告



ESD 可能会损坏该集成电路。德州仪器 (TI) 建议通过适当的预防措施处理所有集成电路。如果不遵守正确的处理措施和安装程序，可能会损坏集成电路。

ESD 的损坏小至导致微小的性能降级，大至整个器件故障。精密的集成电路可能更容易受到损坏，这是因为非常细微的参数更改都可能会导致器件与其发布的规格不相符。

12.8 Glossary

[SLYZ022](#) — *TI Glossary*.

This glossary lists and explains terms, acronyms, and definitions.

13 机械、封装和可订购信息

以下页面包含机械、封装和可订购信息。这些信息是指定器件的最新可用数据。数据如有变更，恕不另行通知，且不会对此文档进行修订。如需获取此数据表的浏览器版本，请查阅左侧的导航栏。

PACKAGING INFORMATION

Orderable Device	Status (1)	Package Type	Package Drawing	Pins	Package Qty	Eco Plan (2)	Lead finish/ Ball material (6)	MSL Peak Temp (3)	Op Temp (°C)	Device Marking (4/5)	Samples
AMC1306E05DWV	ACTIVE	SOIC	DWV	8	64	RoHS & Green	NIPDAU	Level-3-260C-168 HR	-40 to 125	1306E05	Samples
AMC1306E05DWVR	ACTIVE	SOIC	DWV	8	1000	RoHS & Green	NIPDAU	Level-3-260C-168 HR	-40 to 125	1306E05	Samples
AMC1306E25DWV	ACTIVE	SOIC	DWV	8	64	RoHS & Green	NIPDAU	Level-3-260C-168 HR	-40 to 125	1306E25	Samples
AMC1306E25DWVR	ACTIVE	SOIC	DWV	8	1000	RoHS & Green	NIPDAU	Level-3-260C-168 HR	-40 to 125	1306E25	Samples
AMC1306M05DWV	ACTIVE	SOIC	DWV	8	64	RoHS & Green	NIPDAU	Level-3-260C-168 HR	-40 to 125	1306M05	Samples
AMC1306M05DWVR	ACTIVE	SOIC	DWV	8	1000	RoHS & Green	NIPDAU	Level-3-260C-168 HR	-40 to 125	1306M05	Samples
AMC1306M25DWV	ACTIVE	SOIC	DWV	8	64	RoHS & Green	NIPDAU	Level-3-260C-168 HR	-40 to 125	1306M25	Samples
AMC1306M25DWVR	ACTIVE	SOIC	DWV	8	1000	RoHS & Green	NIPDAU	Level-3-260C-168 HR	-40 to 125	1306M25	Samples

(1) The marketing status values are defined as follows:

ACTIVE: Product device recommended for new designs.

LIFEBUY: TI has announced that the device will be discontinued, and a lifetime-buy period is in effect.

NRND: Not recommended for new designs. Device is in production to support existing customers, but TI does not recommend using this part in a new design.

PREVIEW: Device has been announced but is not in production. Samples may or may not be available.

OBSELETE: TI has discontinued the production of the device.

(2) **RoHS:** TI defines "RoHS" to mean semiconductor products that are compliant with the current EU RoHS requirements for all 10 RoHS substances, including the requirement that RoHS substance do not exceed 0.1% by weight in homogeneous materials. Where designed to be soldered at high temperatures, "RoHS" products are suitable for use in specified lead-free processes. TI may reference these types of products as "Pb-Free".

RoHS Exempt: TI defines "RoHS Exempt" to mean products that contain lead but are compliant with EU RoHS pursuant to a specific EU RoHS exemption.

Green: TI defines "Green" to mean the content of Chlorine (Cl) and Bromine (Br) based flame retardants meet JS709B low halogen requirements of <=1000ppm threshold. Antimony trioxide based flame retardants must also meet the <=1000ppm threshold requirement.

(3) MSL, Peak Temp. - The Moisture Sensitivity Level rating according to the JEDEC industry standard classifications, and peak solder temperature.

(4) There may be additional marking, which relates to the logo, the lot trace code information, or the environmental category on the device.

(5) Multiple Device Markings will be inside parentheses. Only one Device Marking contained in parentheses and separated by a "~" will appear on a device. If a line is indented then it is a continuation of the previous line and the two combined represent the entire Device Marking for that device.

⁽⁶⁾ Lead finish/Ball material - Orderable Devices may have multiple material finish options. Finish options are separated by a vertical ruled line. Lead finish/Ball material values may wrap to two lines if the finish value exceeds the maximum column width.

Important Information and Disclaimer: The information provided on this page represents TI's knowledge and belief as of the date that it is provided. TI bases its knowledge and belief on information provided by third parties, and makes no representation or warranty as to the accuracy of such information. Efforts are underway to better integrate information from third parties. TI has taken and continues to take reasonable steps to provide representative and accurate information but may not have conducted destructive testing or chemical analysis on incoming materials and chemicals. TI and TI suppliers consider certain information to be proprietary, and thus CAS numbers and other limited information may not be available for release.

In no event shall TI's liability arising out of such information exceed the total purchase price of the TI part(s) at issue in this document sold by TI to Customer on an annual basis.

TAPE AND REEL INFORMATION

QUADRANT ASSIGNMENTS FOR PIN 1 ORIENTATION IN TAPE

*All dimensions are nominal

Device	Package Type	Package Drawing	Pins	SPQ	Reel Diameter (mm)	Reel Width W1 (mm)	A0 (mm)	B0 (mm)	K0 (mm)	P1 (mm)	W (mm)	Pin1 Quadrant
AMC1306E05DWVR	SOIC	DWV	8	1000	330.0	16.4	12.05	6.15	3.3	16.0	16.0	Q1
AMC1306E25DWVR	SOIC	DWV	8	1000	330.0	16.4	12.05	6.15	3.3	16.0	16.0	Q1
AMC1306M05DWVR	SOIC	DWV	8	1000	330.0	16.4	12.05	6.15	3.3	16.0	16.0	Q1
AMC1306M25DWVR	SOIC	DWV	8	1000	330.0	16.4	12.05	6.15	3.3	16.0	16.0	Q1

TAPE AND REEL BOX DIMENSIONS

*All dimensions are nominal

Device	Package Type	Package Drawing	Pins	SPQ	Length (mm)	Width (mm)	Height (mm)
AMC1306E05DWVR	SOIC	DWV	8	1000	350.0	350.0	43.0
AMC1306E25DWVR	SOIC	DWV	8	1000	350.0	350.0	43.0
AMC1306M05DWVR	SOIC	DWV	8	1000	350.0	350.0	43.0
AMC1306M25DWVR	SOIC	DWV	8	1000	350.0	350.0	43.0

TUBE

*All dimensions are nominal

Device	Package Name	Package Type	Pins	SPQ	L (mm)	W (mm)	T (μm)	B (mm)
AMC1306E05DWV	DWV	SOIC	8	64	505.46	13.94	4826	6.6
AMC1306E25DWV	DWV	SOIC	8	64	505.46	13.94	4826	6.6
AMC1306M05DWV	DWV	SOIC	8	64	505.46	13.94	4826	6.6
AMC1306M25DWV	DWV	SOIC	8	64	505.46	13.94	4826	6.6



DWV0008A

SOIC - 2.8 mm max height

SOIC

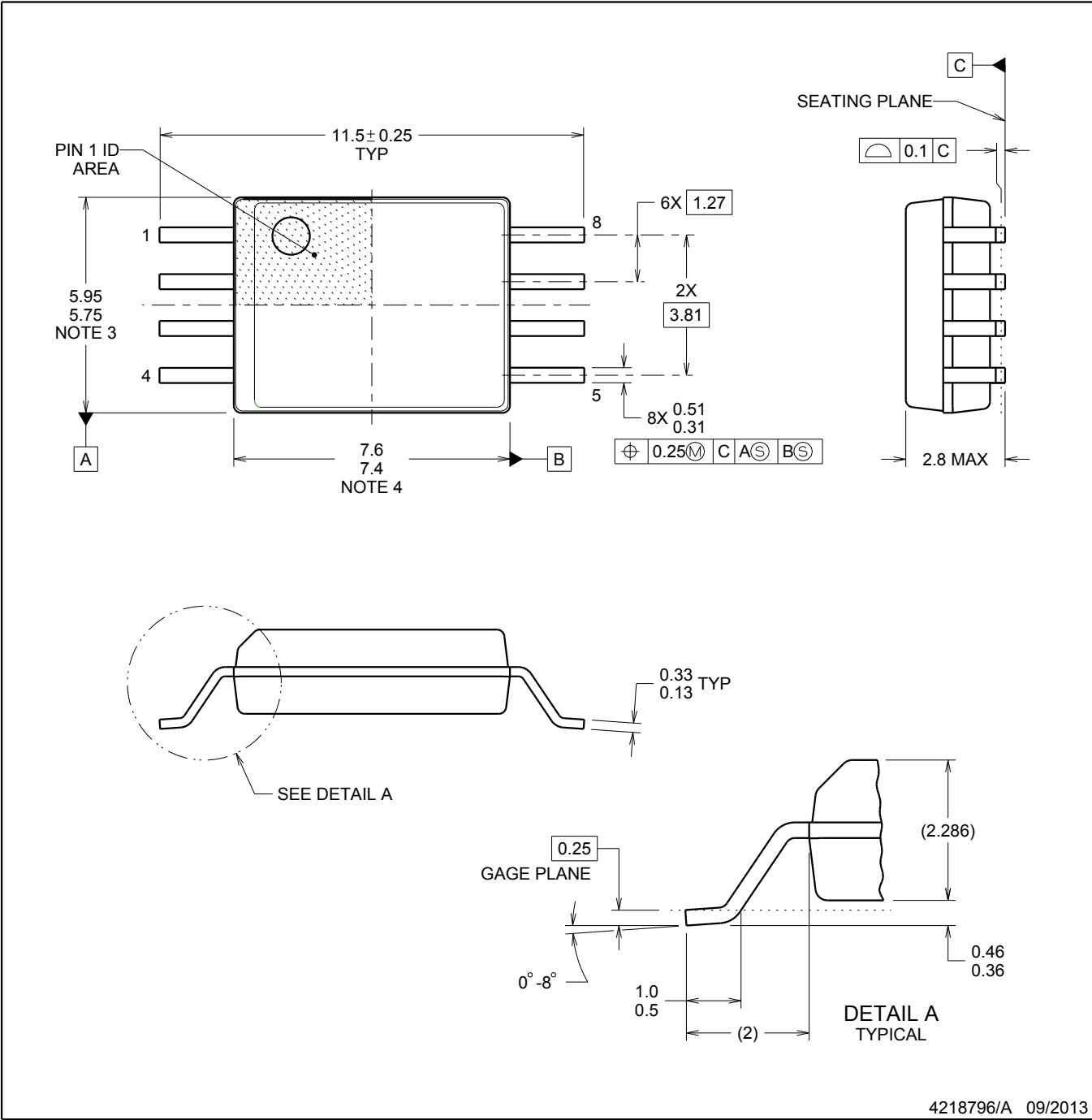

4218796/A 09/2013

NOTES:

- 1. All linear dimensions are in millimeters. Dimensions in parenthesis are for reference only. Dimensioning and tolerancing per ASME Y14.5M.
- 2. This drawing is subject to change without notice.
- 3. This dimension does not include mold flash, protrusions, or gate burrs. Mold flash, protrusions, or gate burrs shall not exceed 0.15 mm, per side.
- 4. This dimension does not include interlead flash. Interlead flash shall not exceed 0.25 mm, per side.

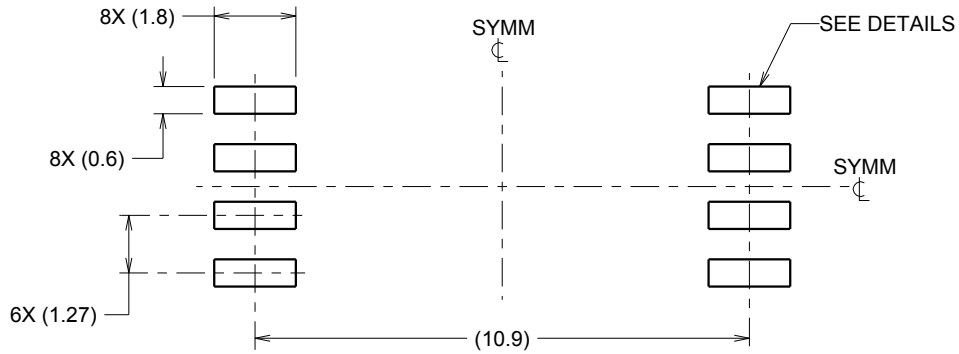

LAND PATTERN EXAMPLE
 9.1 mm NOMINAL CLEARANCE/CREEPAGE
 SCALE:6X

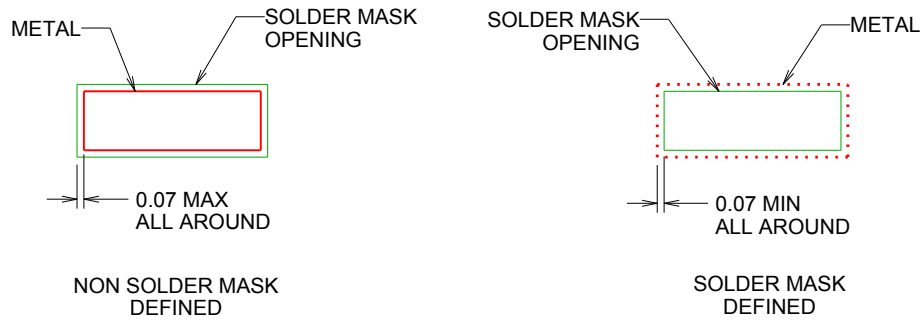

SOLDER MASK DETAILS

4218796/A 09/2013

NOTES: (continued)

- 5. Publication IPC-7351 may have alternate designs.
- 6. Solder mask tolerances between and around signal pads can vary based on board fabrication site.

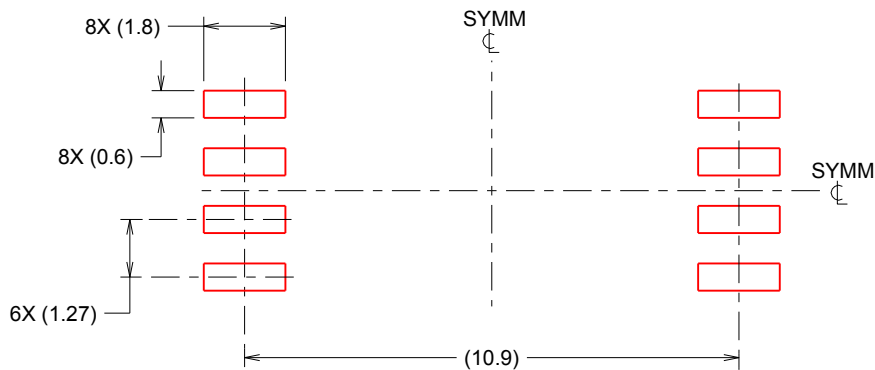

SOLDER PASTE EXAMPLE
 BASED ON 0.125 mm THICK STENCIL
 SCALE:6X

4218796/A 09/2013

NOTES: (continued)

- 7. Laser cutting apertures with trapezoidal walls and rounded corners may offer better paste release. IPC-7525 may have alternate design recommendations.
- 8. Board assembly site may have different recommendations for stencil design.

重要声明和免责声明

TI“按原样”提供技术和可靠性数据（包括数据表）、设计资源（包括参考设计）、应用或其他设计建议、网络工具、安全信息和其他资源，不保证没有瑕疵且不做任何明示或暗示的担保，包括但不限于对适销性、某特定用途方面的适用性或不侵犯任何第三方知识产权的暗示担保。

这些资源可供使用 TI 产品进行设计的熟练开发人员使用。您将自行承担以下全部责任：(1) 针对您的应用选择合适的 TI 产品，(2) 设计、验证并测试您的应用，(3) 确保您的应用满足相应标准以及任何其他功能安全、信息安全、监管或其他要求。

这些资源如有变更，恕不另行通知。TI 授权您仅可将这些资源用于研发本资源所述的 TI 产品的应用。严禁对这些资源进行其他复制或展示。您无权使用任何其他 TI 知识产权或任何第三方知识产权。您应全额赔偿因在这些资源的使用中对 TI 及其代表造成的任何索赔、损害、成本、损失和债务，TI 对此概不负责。

TI 提供的产品受 [TI 的销售条款](#) 或 [ti.com](#) 上其他适用条款/TI 产品随附的其他适用条款的约束。TI 提供这些资源并不会扩展或以其他方式更改 TI 针对 TI 产品发布的适用的担保或担保免责声明。

TI 反对并拒绝您可能提出的任何其他或不同的条款。

邮寄地址：Texas Instruments, Post Office Box 655303, Dallas, Texas 75265

Copyright © 2022，德州仪器 (TI) 公司