

200mA Low-Dropout Linear Regulator with Pin-Selectable Dual-Voltage Level Output

FEATURES

- **Very Low Dropout: 230mV Typical at 200mA**
- **3% Accuracy Over Load/Line/Temperature**
- **Low I_Q: 50µA in Active Mode**
- **Available in Fixed-Output Voltages From 0.9V to 3.6V Using Innovative Factory EEPROM Programming**
- **VSET Pin Toggles Output Voltage Between Two Preset Levels**
 - **Preset Output Voltage Levels Can Be EEPROM-Programmed To Any Combination**
- **High PSRR: 65dB at 1kHz**
- **Stable with a 1.0µF Ceramic Capacitor**
- **Thermal Shutdown and Over-Current Protection**
- **Available in Wafer-Level Chip Scale and 2mm x 2mm SON Packages**

APPLICATIONS

- **Power Rails with Programming Mode**
- **Dual Voltage Levels for Power-Saving Mode**
- **Leakage Reduction for 90nm and 65nm Processors**
- **Wireless Handsets, Smart Phones, PDAs**
- **MP3 Players and Other Handheld Products**

DESCRIPTION

The TPS728xx series of low-dropout linear regulators (LDOs), with a selectable dual-voltage level output, is designed specially for applications that require two levels of output voltage regulation. Programming fuses and memory cards, reducing leakage effects, and conserving power in nanometric processes are some application examples.

The VSET pin is used to select one of two output voltage levels preset through innovative factory EEPROM programming. A precision bandgap and error amplifier provides an overall 3% accuracy over load, line, and temperature extremes.

Ultra-small wafer chip scale (WCSP) and 2mm x 2mm SON packages make the TPS728xx series ideal for handheld applications.

This family of devices is fully specified over a temperature range of T_J = –40°C to +125°C.

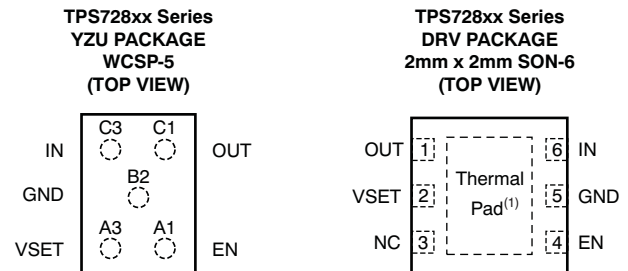

(1) It is recommended that the SON package thermal pad be connected to ground.



Please be aware that an important notice concerning availability, standard warranty, and use in critical applications of Texas Instruments semiconductor products and disclaimers thereto appears at the end of this data sheet.

All trademarks are the property of their respective owners.



This integrated circuit can be damaged by ESD. Texas Instruments recommends that all integrated circuits be handled with appropriate precautions. Failure to observe proper handling and installation procedures can cause damage.

ESD damage can range from subtle performance degradation to complete device failure. Precision integrated circuits may be more susceptible to damage because very small parametric changes could cause the device not to meet its published specifications.

ORDERING INFORMATION⁽¹⁾

PRODUCT	V _{OUT} ⁽²⁾
TPS728vvvxxxyyyz	<p>VVV is the nominal output voltage for V_{OUT1} and corresponds to V_{SET} = Low. XXX is the nominal output voltage for V_{OUT2} and corresponds to V_{SET} = High. YYY is package designator. Z is Tape and reel quantity (R = 3000, T = 250).</p>

- (1) For the most current package and ordering information see the Package Option Addendum at the end of this document, or see the TI website at www.ti.com.
- (2) Output voltages from 0.9V to 3.6V in 50mV increments are available through the use of innovative factory EEPROM programming; minimum order quantities may apply. Contact factory for details and availability.

ABSOLUTE MAXIMUM RATINGS⁽¹⁾

At T_J = –40°C to +125°C (unless otherwise noted). All voltages are with respect to GND.

PARAMETER	TPS728xx Series	UNIT
Input voltage range, V _{IN}	–0.3 to +7.0	V
Enable and VSET voltage range, V _{EN} and V _{SET}	–0.3 to V _{IN} + 0.3 ⁽²⁾	V
Output voltage range, V _{OUT}	–0.3 to +7.0	V
Maximum output current, I _{OUT}	Internally limited	
Output short-circuit duration	Indefinite	
Total continuous power dissipation, P _{DISS}	See Dissipation Ratings Table	
ESD rating	Human body model (HBM)	2 kV
	Charged device model (CDM)	500 V
Operating junction temperature range, T _J	–55 to +150	°C
Storage temperature range, T _{STG}	–55 to +150	°C

- (1) Stresses above these ratings may cause permanent damage. Exposure to absolute maximum conditions for extended periods may degrade device reliability. These are stress ratings only, and functional operation of the device at these or any other conditions beyond those specified is not implied.
- (2) V_{EN} and V_{SET} absolute maximum rating is V_{IN} + 0.3V or +7.0V, whichever is less.

DISSIPATION RATINGS

BOARD	PACKAGE	R _{θJC}	R _{θJA}	DERATING FACTOR ABOVE T _A = +25°C	T _A < +25°C	T _A = +70°C	T _A = +85°C
High-K ⁽¹⁾	DRV	20°C/W	65°C/W	15.4mW/°C	1540mW	845mW	615mW
High-K ⁽¹⁾	YZU	85°C/W	268°C/W	3.7mW/°C	370mW	205mW	150mW

- (1) The JEDEC high-K (2s2p) board used to derive this data was a 3- × 3-inch, multilayer board with 1-ounce internal power and ground planes and 2-ounce copper traces on top and bottom of the board.

ELECTRICAL CHARACTERISTICS

Over operating temperature range ($T_J = -40^{\circ}\text{C}$ to $+125^{\circ}\text{C}$), $V_{IN} = V_{OUT(TYP)} + 0.5\text{V}$ or 2.7V , whichever is greater;
 $I_{OUT} = 0.5\text{mA}$, $V_{SET} = V_{EN} = V_{IN}$, $C_{OUT} = 1.0\mu\text{F}$, unless otherwise noted. Typical values are at $T_J = +25^{\circ}\text{C}$.

PARAMETER		TEST CONDITIONS	MIN	TYP	MAX	UNIT	
V_{IN}	Input voltage range		2.7		6.5	V	
$V_{OUT}^{(1)}$	DC output accuracy	Nominal	$T_J = +25^{\circ}\text{C}$, $V_{SET} = \text{high/low}$	-2.5		+2.5	mV
		Over V_{IN} , I_{OUT} , temperature	$V_{OUT} + 0.5\text{V} \leq V_{IN} \leq 6.5\text{V}$, $0\text{mA} \leq I_{OUT} \leq 200\text{mA}$, $V_{SET} = \text{high/low}$	-3.0		+3.0	%
ΔV_{OUT}	Load transient	100 μA to 200mA in 1 μs , 200mA to 100 μA in 1 μs , $C_{OUT} = 1\mu\text{F}$		± 60.0		mV	
V_O	Output voltage range		0.9		3.6	V	
$\Delta V_O/\Delta V_{IN}$	Line regulation	$V_{OUT(NOM)} + 0.5\text{V} \leq V_{IN} \leq 6.5\text{V}$, $I_{OUT} = 5\text{mA}$		130		$\mu\text{V/V}$	
$\Delta V_O/\Delta I_{OUT}$	Load regulation	$0\text{mA} \leq I_{OUT} \leq 200\text{mA}$		75		$\mu\text{V/mA}$	
V_{DO}	Dropout voltage ⁽²⁾	$V_{IN} = V_{OUT(NOM)} - 0.1\text{V}$, $I_{OUT} = 200\text{mA}$		230	400	mV	
I_{CL}	Output current limit	$V_{OUT} = 0.9 \times V_{OUT(NOM)}$	240	340	575	mA	
I_{GND}	Ground pin current	$I_{OUT} = 0\text{mA}$		50	80	μA	
		$I_{OUT} = 200\text{mA}$		120		μA	
I_{SHDN}	Shutdown current (I_{GND})	$V_{EN} \leq 0.4\text{V}$, $2.7\text{V} \leq V_{IN} < 4.5\text{V}$, $T_J = -40^{\circ}\text{C}$ to $+85^{\circ}\text{C}$		0.10	1.0	μA	
PSRR	Power-supply rejection ratio	$V_{IN} = 3.8\text{V}$, $V_{OUT} = 2.8\text{V}$, $I_{OUT} = 200\text{mA}$	$f = 100\text{Hz}$		65		dB
			$f = 1\text{kHz}$		65		dB
			$f = 10\text{kHz}$		55		dB
			$f = 100\text{kHz}$		40		dB
V_N	Output noise voltage	$\text{BW} = 100\text{Hz}$ to 100kHz , $V_{IN} = 3.3\text{V}$, $V_{OUT} = 2.8\text{V}$, $I_{OUT} = 10\text{mA}$		$75 \times V_{OUT}$		μV_{RMS}	
t_{TR}	Transition time (low-to-high) $V_{OUT} = V_{OUT_LOW}$ to V_{OUT_HIGH} $V_{OUT} = 97\% \times V_{OUT_HIGH}$	$V_{OUT_LOW} = 1.8\text{V}$, $V_{OUT_HIGH} = 3.15\text{V}$, $I_{OUT} = 10\text{mA}$		60		μs	
t_{STR}	Startup time ⁽³⁾	$C_{OUT} = 1.0\mu\text{F}$		160		μs	
t_{SHUT}	Shutdown time ⁽⁴⁾	$R_L = \infty$, $C_{OUT} = 1.0\mu\text{F}$, $V_{OUT} = 2.8\text{V}$		180 ⁽⁵⁾		μs	
V_{HI}	VSET high (output V_{OUT2} selected), or enable pin high (enabled)		1.2		V_{IN}	V	
V_{LO}	VSET low (output V_{OUT1} selected), or enable pin low (disabled)		0		0.4	V	
I_{EN} , I_{VSET}	Enable and select pin currents	$EN = VSET = 6.5\text{V}$		0.04	1.0	μA	
UVLO	Undervoltage lockout	V_{IN} rising, $V_{SET} = \text{high/low}$	2.38	2.51	2.65	V	
	Hysteresis	V_{IN} falling, $V_{SET} = \text{high/low}$		230		mV	
T_{SD}	Thermal shutdown temperature	Shutdown, temperature increasing		+160		$^{\circ}\text{C}$	
		Reset, temperature decreasing		+140		$^{\circ}\text{C}$	
T_J	Operating junction temperature		-40		+125	$^{\circ}\text{C}$	

- (1) The output voltage for $V_{SET} = \text{low/high}$ is programmed at the factory.
- (2) V_{DO} is not measured for devices with $V_{OUT(NOM)} < 2.8\text{V}$ because minimum $V_{IN} = 2.7\text{V}$.
- (3) Time from $V_{EN} = 1.2\text{V}$ to $V_{OUT} = 97\%$ ($V_{OUT(NOM)}$).
- (4) Time from $V_{EN} = 0.4\text{V}$ to $V_{OUT} = 5\%$ ($V_{OUT(NOM)}$).
- (5) See [Shutdown](#) in the *Application Information* section for more details.

DEVICE INFORMATION

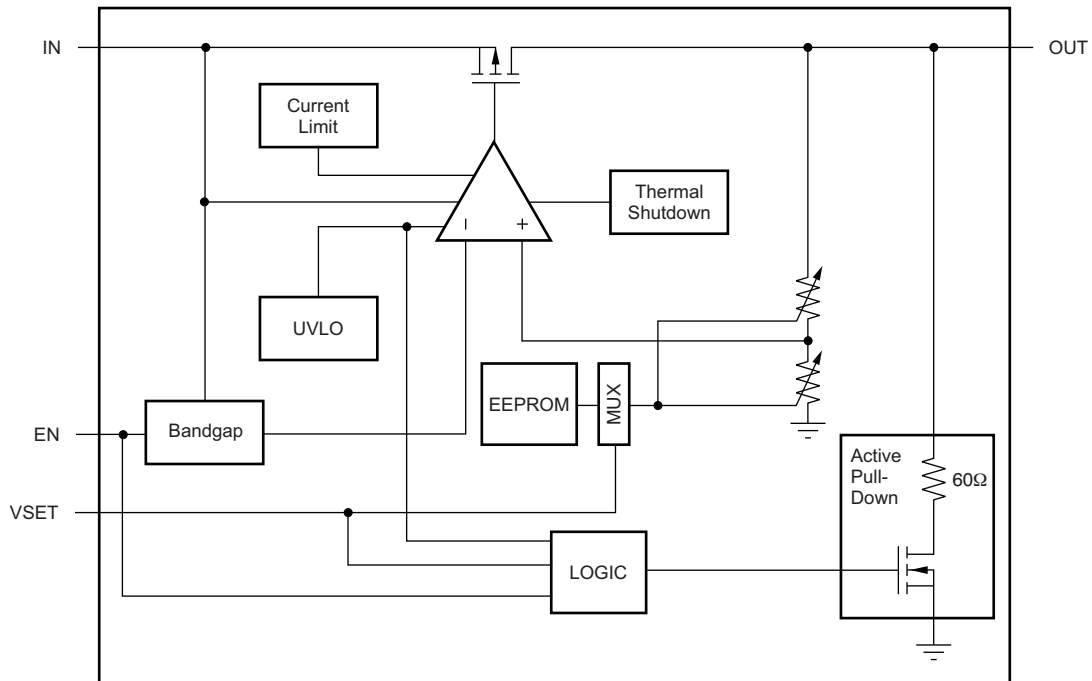
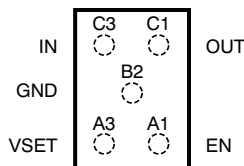
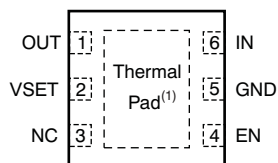

Figure 1. Functional Block Diagram

**YZU PACKAGE
WCSP-5
(TOP VIEW)**



**DRV PACKAGE
SON-8
(TOP VIEW)**



(1) It is recommended that the SON package thermal pad be connected to ground.

PIN DESCRIPTIONS

TPS728xx Series			DESCRIPTION
NAME	DRV	YZU	
OUT	1	C1	Regulated output voltage pin. A small 1 μ F ceramic capacitor is needed from this pin to ground to assure stability. See Input and Output Capacitor Requirements in the <i>Application Information</i> section for more details.
VSET	2	A3	Select pin. Driving VSET below 0.4V selects preset output voltage V_{OUT1} . Driving VSET over 1.2V selects preset output voltage V_{OUT2} .
NC	3	—	No connection.
EN	4	A1	Enable pin. Driving EN over 1.2V turns on the regulator. Driving EN below 0.4V puts the regulator into shutdown mode, thus reducing the operating current to 100nA, nominal.
GND	5	B2	Ground pin (connect DRV thermal pad to ground)
IN	6	C3	Input pin. A small capacitor is needed from this pin to ground to assure stability. See Input and Output Capacitor Requirements in the <i>Application Information</i> section for more details.

TYPICAL CHARACTERISTICS

Over operating temperature range ($T_J = -40^{\circ}\text{C}$ to $+125^{\circ}\text{C}$), $V_{IN} = V_{OUT(TYP)} + 0.5\text{V}$ or 2.7V , whichever is greater; $I_{OUT} = 0.5\text{mA}$, $V_{EN} = V_{SET} = V_{IN}$, $C_{OUT} = 1.0\mu\text{F}$, unless otherwise noted. Typical values are at $T_J = +25^{\circ}\text{C}$.

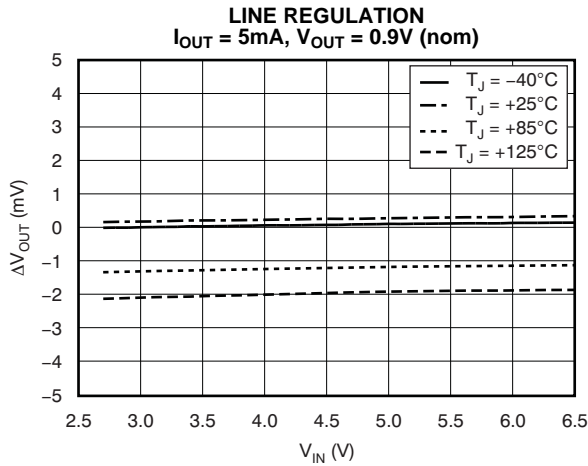

Figure 2.

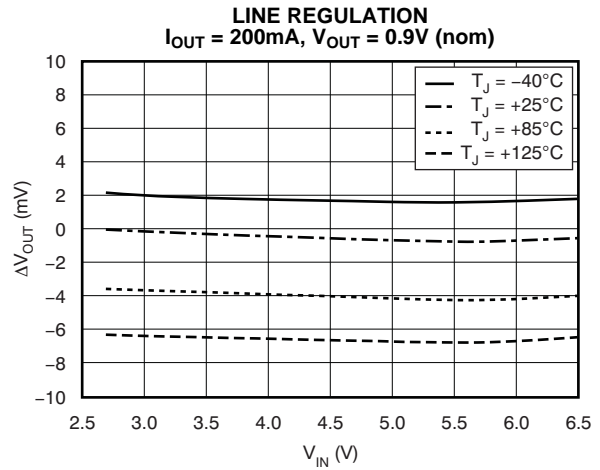

Figure 3.

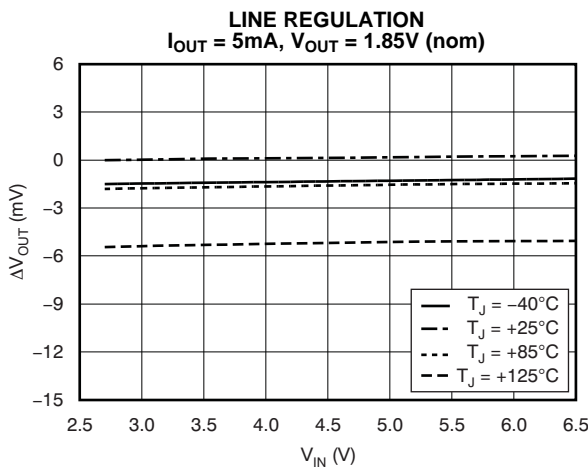

Figure 4.

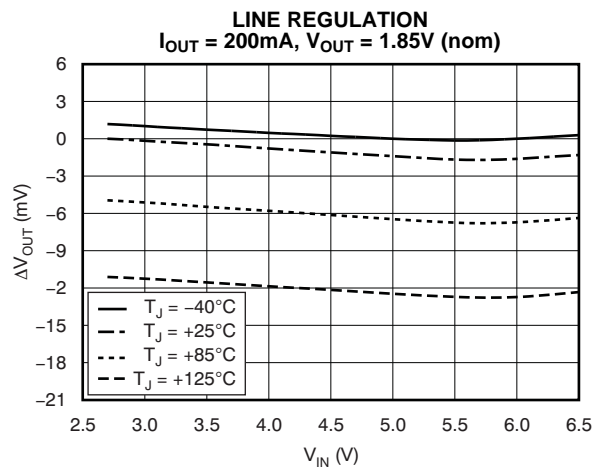

Figure 5.

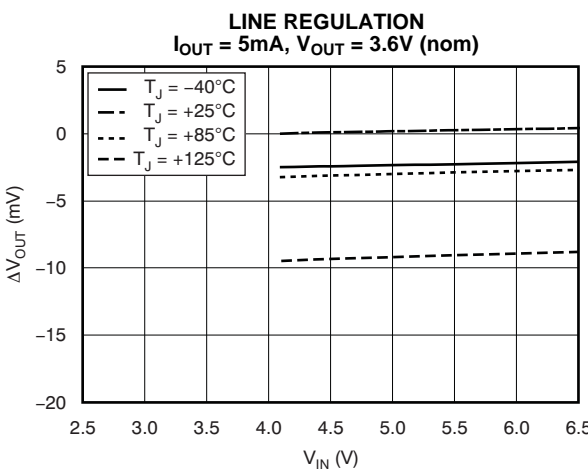

Figure 6.

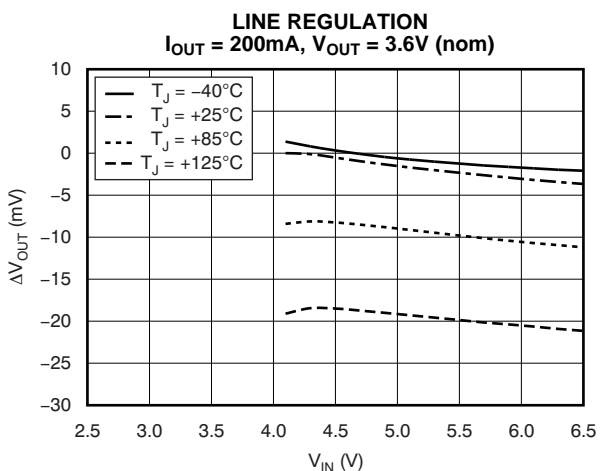

Figure 7.

TYPICAL CHARACTERISTICS (continued)

Over operating temperature range ($T_J = -40^\circ\text{C}$ to $+125^\circ\text{C}$), $V_{IN} = V_{OUT(TYP)} + 0.5\text{V}$ or 2.7V , whichever is greater; $I_{OUT} = 0.5\text{mA}$, $V_{EN} = V_{SET} = V_{IN}$, $C_{OUT} = 1.0\mu\text{F}$, unless otherwise noted. Typical values are at $T_J = +25^\circ\text{C}$.

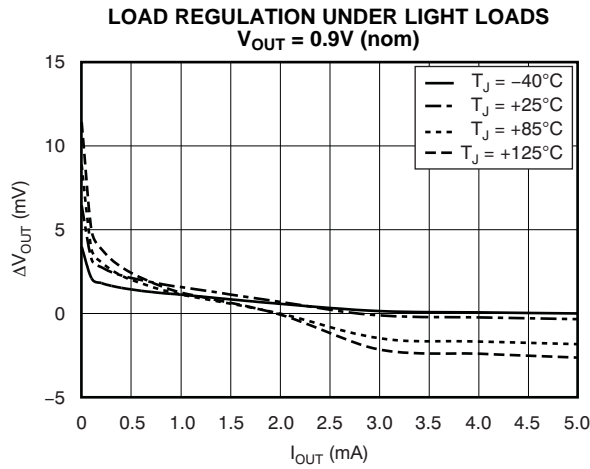

Figure 8.

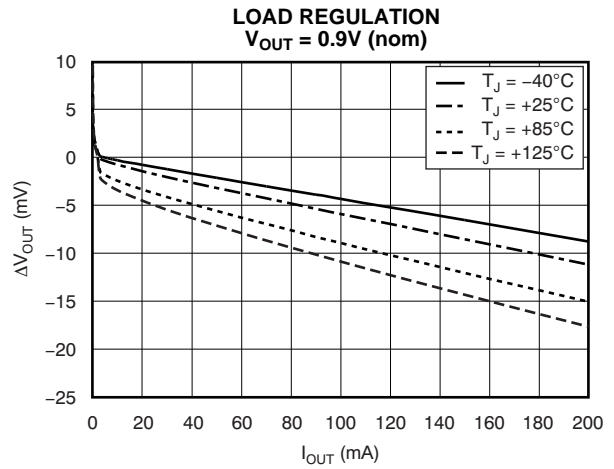

Figure 9.

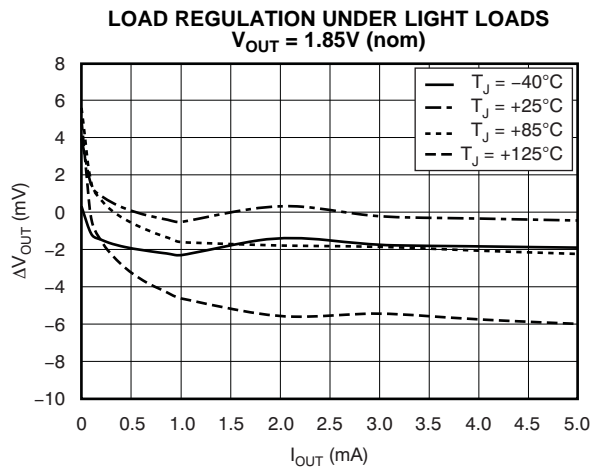

Figure 10.

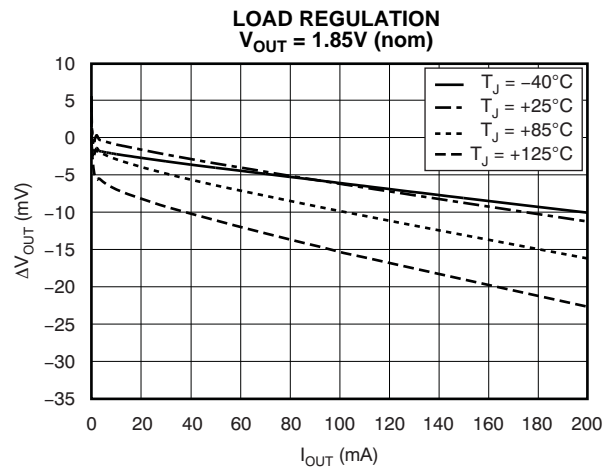

Figure 11.

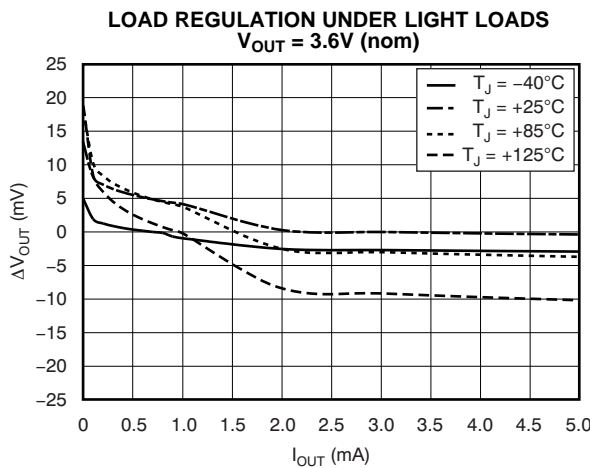

Figure 12.

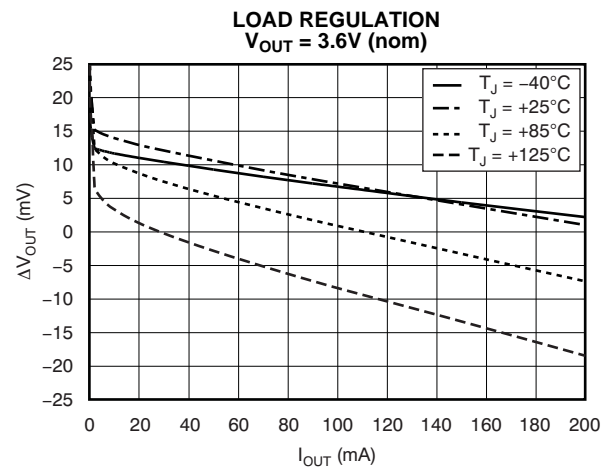

Figure 13.

TYPICAL CHARACTERISTICS (continued)

Over operating temperature range ($T_J = -40^\circ\text{C}$ to $+125^\circ\text{C}$), $V_{IN} = V_{OUT(TYP)} + 0.5\text{V}$ or 2.7V , whichever is greater; $I_{OUT} = 0.5\text{mA}$, $V_{EN} = V_{SET} = V_{IN}$, $C_{OUT} = 1.0\mu\text{F}$, unless otherwise noted. Typical values are at $T_J = +25^\circ\text{C}$.

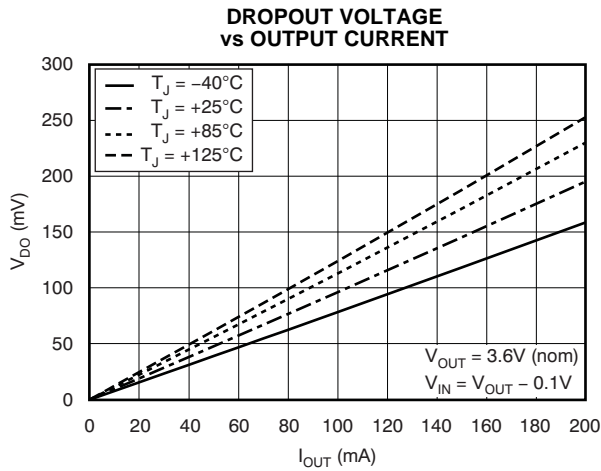

Figure 14.

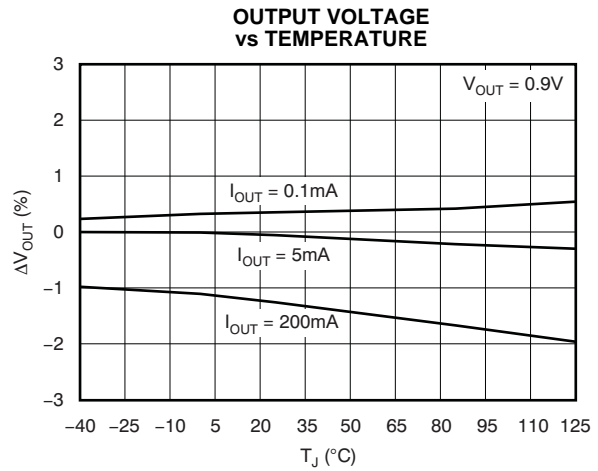

Figure 15.

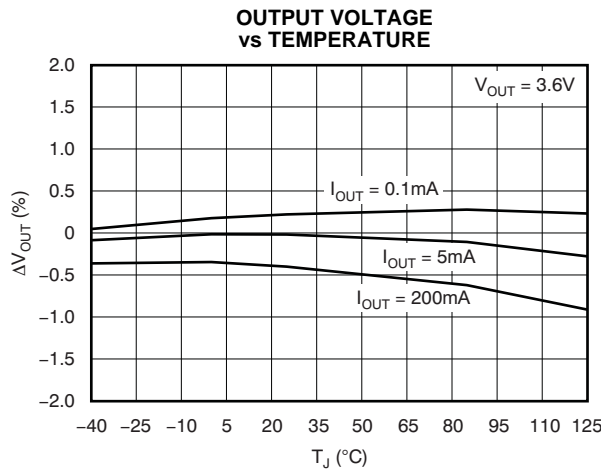

Figure 16.

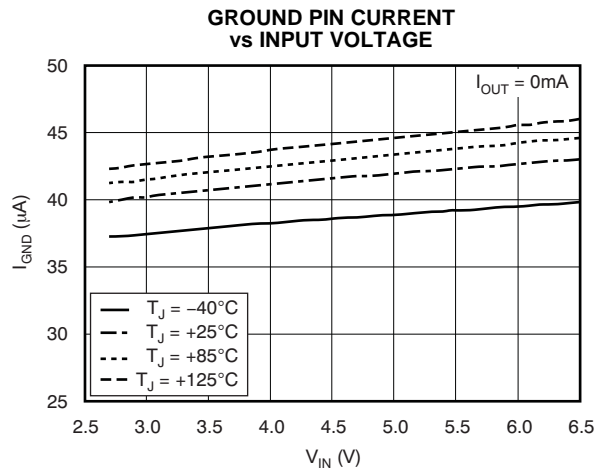

Figure 17.

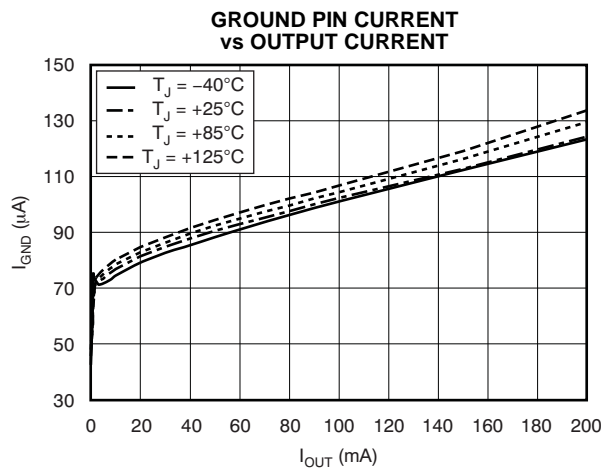

Figure 18.

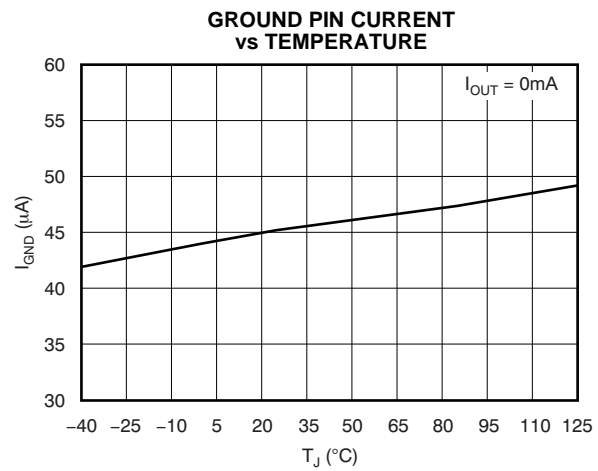

Figure 19.

TYPICAL CHARACTERISTICS (continued)

Over operating temperature range ($T_J = -40^\circ\text{C}$ to $+125^\circ\text{C}$), $V_{IN} = V_{OUT(TYP)} + 0.5\text{V}$ or 2.7V , whichever is greater; $I_{OUT} = 0.5\text{mA}$, $V_{EN} = V_{SET} = V_{IN}$, $C_{OUT} = 1.0\mu\text{F}$, unless otherwise noted. Typical values are at $T_J = +25^\circ\text{C}$.

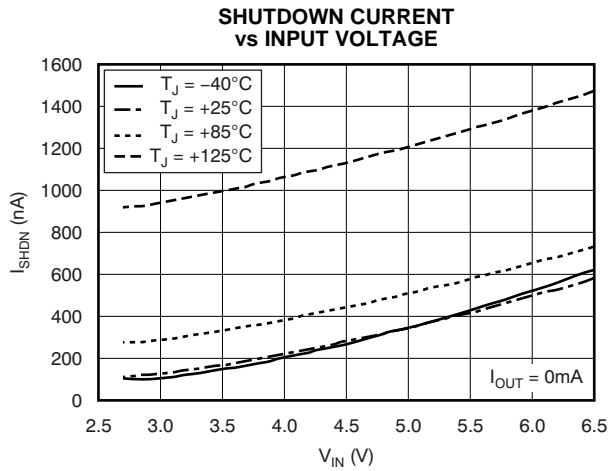

Figure 20.

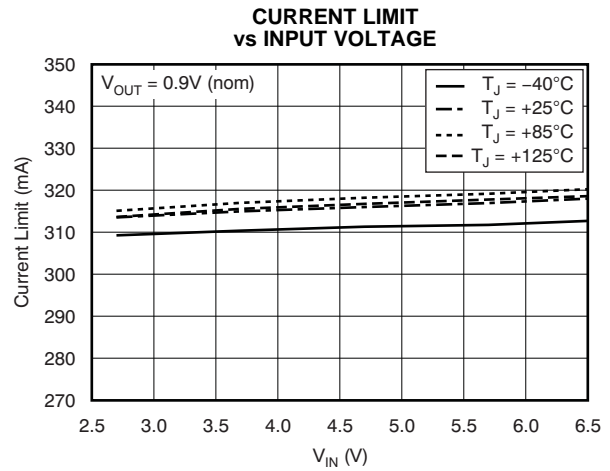

Figure 21.

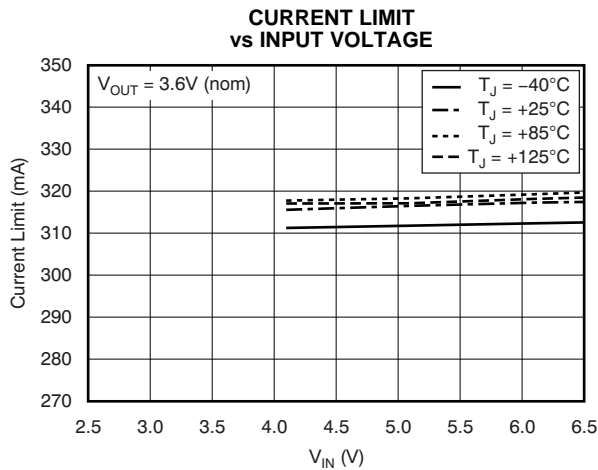

Figure 22.

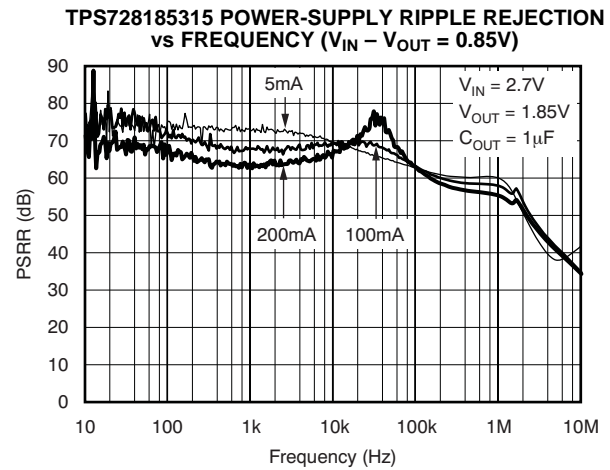

Figure 23.

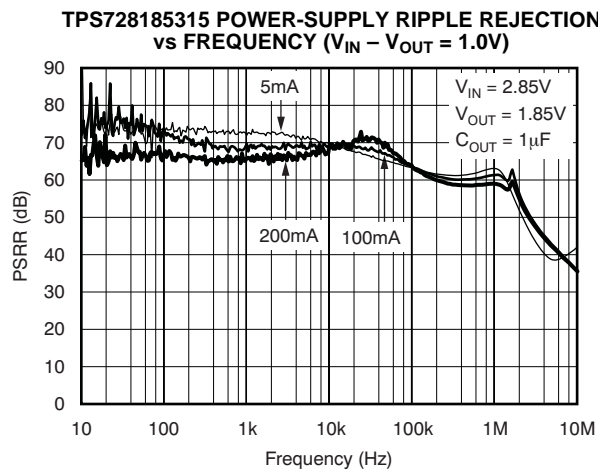

Figure 24.

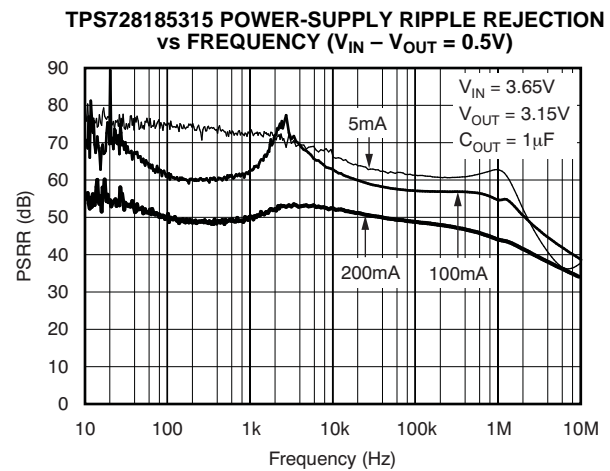

Figure 25.

TYPICAL CHARACTERISTICS (continued)

Over operating temperature range ($T_J = -40^{\circ}\text{C}$ to $+125^{\circ}\text{C}$), $V_{IN} = V_{OUT(TYP)} + 0.5\text{V}$ or 2.7V , whichever is greater; $I_{OUT} = 0.5\text{mA}$, $V_{EN} = V_{SET} = V_{IN}$, $C_{OUT} = 1.0\mu\text{F}$, unless otherwise noted. Typical values are at $T_J = +25^{\circ}\text{C}$.

TPS728185315 POWER-SUPPLY RIPPLE REJECTION vs FREQUENCY ($V_{IN} - V_{OUT} = 1.0\text{V}$)

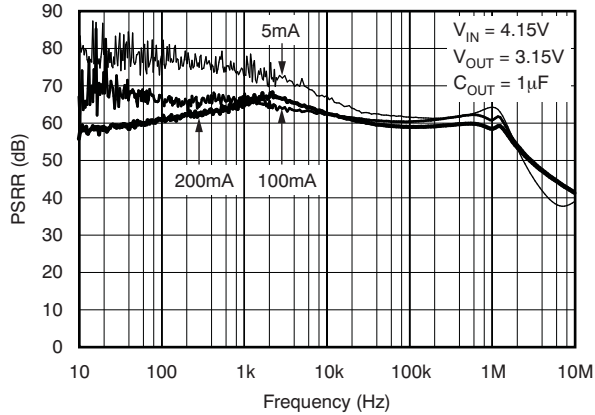

Figure 26.

OUTPUT SPECTRAL NOISE DENSITY vs FREQUENCY

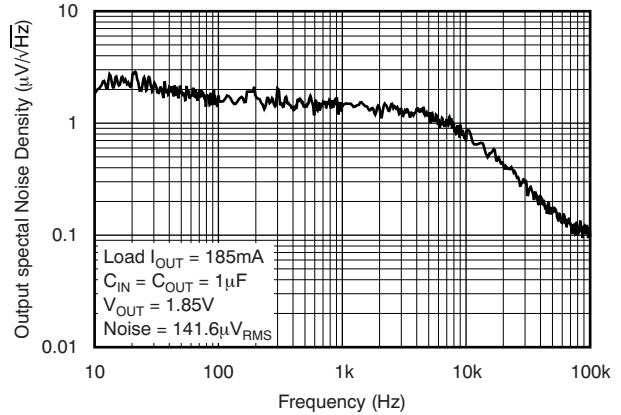

Figure 27.

OUTPUT SPECTRAL NOISE DENSITY vs FREQUENCY

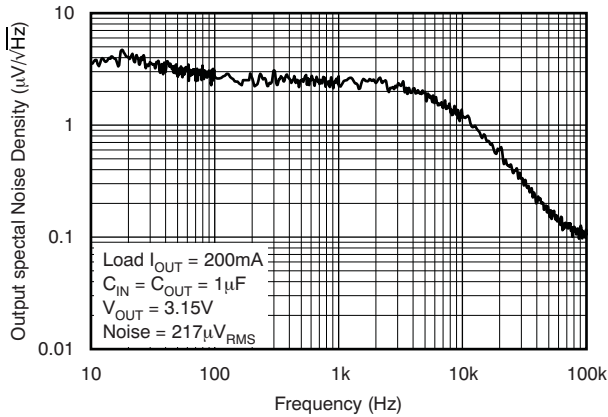

Figure 28.

LINE TRANSIENT RESPONSE

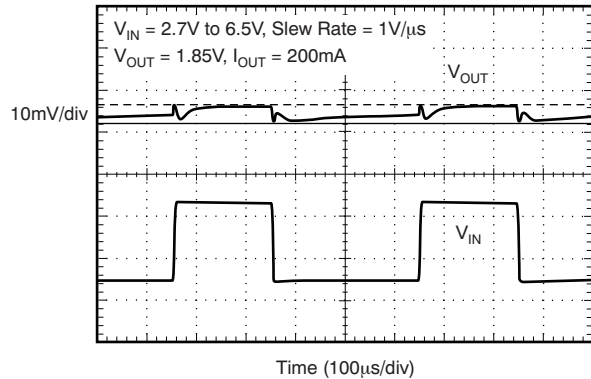

Figure 29.

LINE TRANSIENT RESPONSE

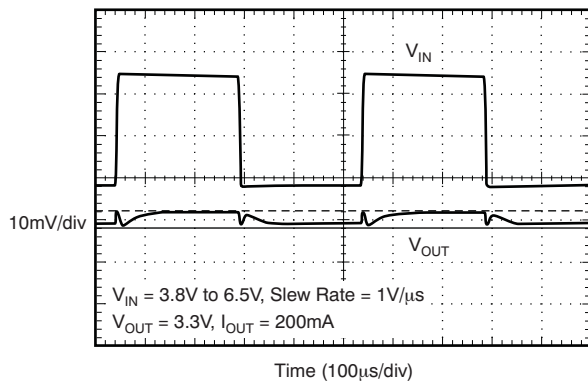

Figure 30.

LOAD TRANSIENT RESPONSE

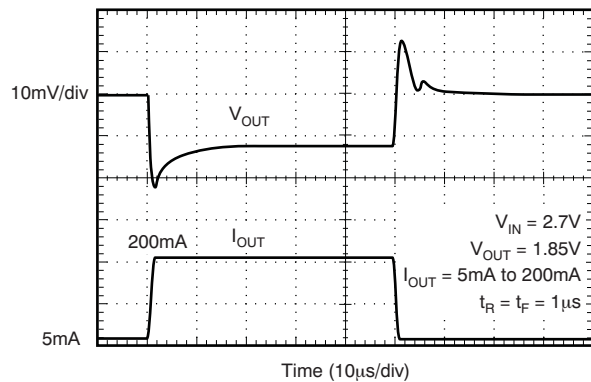

Figure 31.

TYPICAL CHARACTERISTICS (continued)

Over operating temperature range ($T_J = -40^{\circ}\text{C}$ to $+125^{\circ}\text{C}$), $V_{IN} = V_{OUT(TYP)} + 0.5\text{V}$ or 2.7V , whichever is greater; $I_{OUT} = 0.5\text{mA}$, $V_{EN} = V_{SET} = V_{IN}$, $C_{OUT} = 1.0\mu\text{F}$, unless otherwise noted. Typical values are at $T_J = +25^{\circ}\text{C}$.

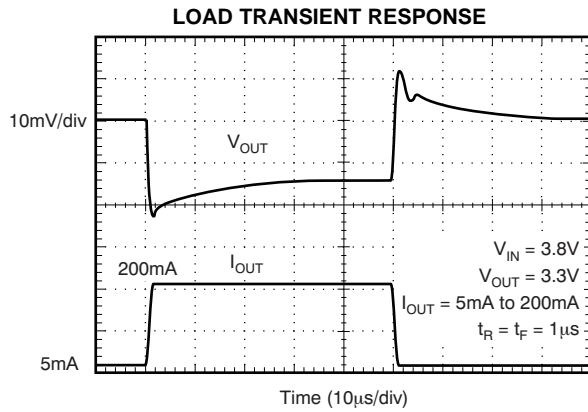

Figure 32.

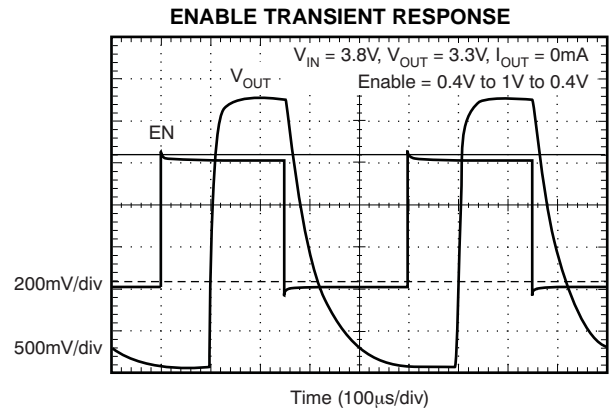

Figure 33.

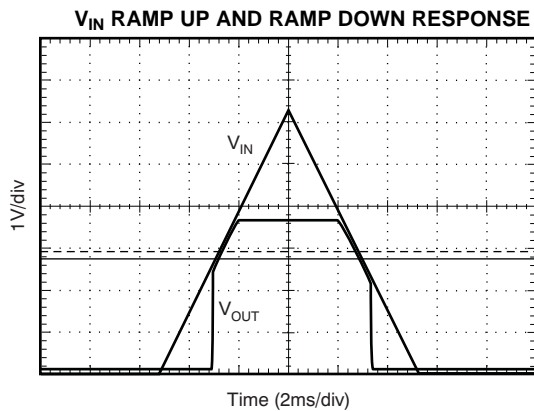

Figure 34.

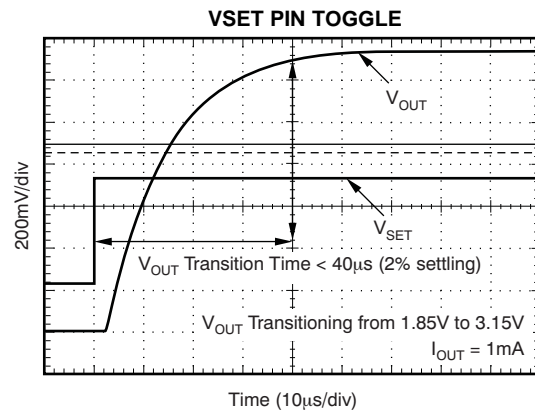

Figure 35.

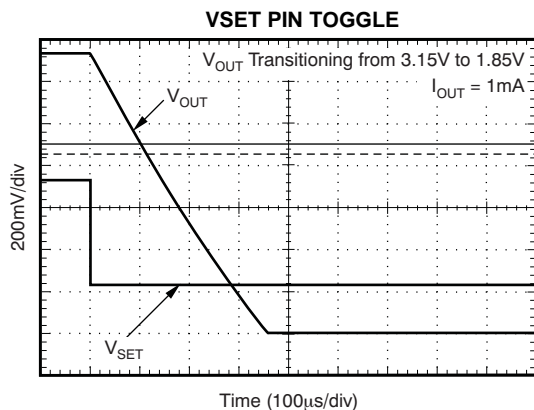

Figure 36.

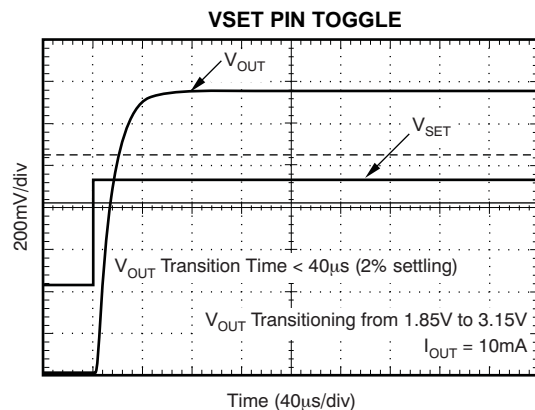

Figure 37.

TYPICAL CHARACTERISTICS (continued)

Over operating temperature range ($T_J = -40^{\circ}\text{C}$ to $+125^{\circ}\text{C}$), $V_{IN} = V_{OUT(TYP)} + 0.5\text{V}$ or 2.7V , whichever is greater; $I_{OUT} = 0.5\text{mA}$, $V_{EN} = V_{SET} = V_{IN}$, $C_{OUT} = 1.0\mu\text{F}$, unless otherwise noted. Typical values are at $T_J = +25^{\circ}\text{C}$.

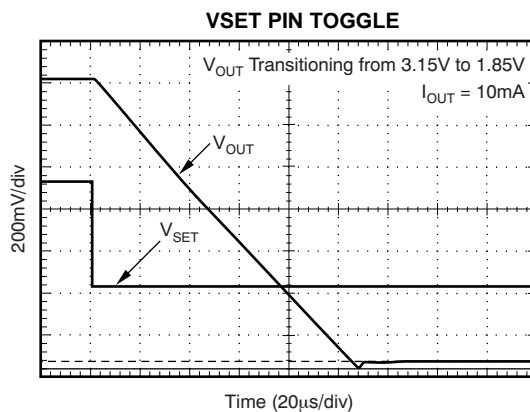

Figure 38.

APPLICATION INFORMATION

The TPS728xx series belongs to a family of new generation LDO regulators that use innovative circuitry to achieve ultra-wide bandwidth and high loop gain, resulting in extremely high PSRR (up to 1MHz) at very low headroom ($V_{IN} - V_{OUT}$). These features, combined with low noise, low ground pin current, and ultra-small packaging, make this device ideal for portable applications. This family of regulators offers sub-bandgap output voltages, current limit and thermal protection, and is fully specified from -40°C to $+125^{\circ}\text{C}$.

Figure 39 shows the basic circuit connections.

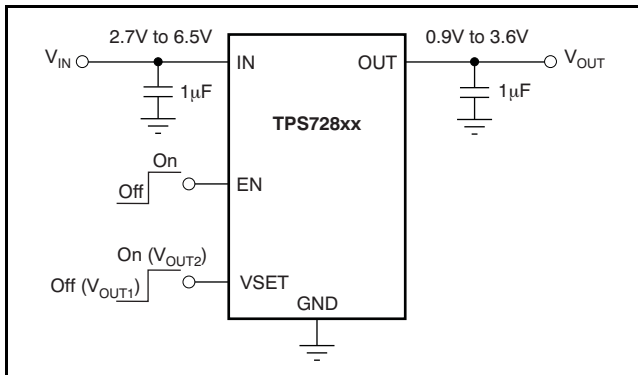

Figure 39. Typical Application Circuit

APPLICATION EXAMPLES

EEPROM-based applications require the programming voltage to be higher than the operating voltage. The TPS728xx suits such applications where the maximum programming voltage of the EEPROM is higher than the operating voltage. The VSET logic pin allows the application to transition between the higher EEPROM programming voltage and the lower operating voltage. For example, the TPS728xx typically takes less than $40\mu\text{s}$ to transition from a lower voltage of 1.85V to a higher voltage of 3.15V under an output load of 1mA to 10mA, as shown in Figure 35 and Figure 37, respectively. The special circuitry in the TPS728xx helps transition from the higher voltage to the lower voltage under no load. The load on the output at the end of the programming cycle is typically under 10mA. Output voltage overshoots and undershoots are minimal under this load condition. The TPS728xx typically takes less than 1ms of transition time going from 3.15V to 1.85V, as shown in Figure 36 and Figure 38, respectively. Both output states of the TPS728xx are programmable between 0.9V to 3.6V.

Another area where the TPS728xx can be used effectively is in dynamic voltage scaling (DVS) applications. In DVS applications, it is required to dynamically switch between a high operational voltage to a low standby voltage in order to balance performance of processors and achieve power savings. Modern multimillion gate microprocessors fabricated with the latest sub-micron processes save on power by transitioning to a lower voltage to reduce leakage currents without losing content. This architecture enables the microprocessor to transition quickly into an operational state (wake up) without requiring reloading of the states from external memory, or a reboot.

INPUT AND OUTPUT CAPACITOR REQUIREMENTS

Although an input capacitor is not required for stability, it is good analog design practice to connect a $0.1\mu\text{F}$ to $1.0\mu\text{F}$ low equivalent series resistance (ESR) capacitor across the input supply near the regulator. This capacitor counteracts reactive input sources and improves transient response, noise rejection, and ripple rejection. A higher-value capacitor may be necessary if large, fast rise-time load transients are anticipated, or if the device is not located near the power source. If source impedance is not sufficiently low, a $0.1\mu\text{F}$ input capacitor may be necessary to ensure stability.

The TPS728xx is designed to be stable with standard ceramic capacitors with values of $1.0\mu\text{F}$ or larger at the output. X5R- and X7R-type capacitors are best because they have minimal variation in value and ESR over temperature. Maximum ESR should be less than 1.0Ω .

BOARD LAYOUT RECOMMENDATIONS TO IMPROVE PSRR AND NOISE PERFORMANCE

To improve ac performance such as PSRR, output noise, and transient response, it is recommended that the board be designed with separate ground planes for V_{IN} and V_{OUT} , with each ground plane connected only at the GND pin of the device. In addition, the ground connection for the output capacitor should connect directly to the GND pin of the device. High ESR capacitors may degrade PSRR.

INTERNAL CURRENT LIMIT

The TPS728xx internal current limits help protect the regulator during fault conditions. During current limit, the output sources a fixed amount of current that is largely independent of output voltage. For reliable operation, the device should not be operated in a current limit state for extended periods of time.

The PMOS pass element in the TPS728xx has a built-in body diode that conducts current when the voltage at OUT exceeds the voltage at IN. This current is not limited, so if extended reverse voltage operation is anticipated, external limiting to 5% of rated output current may be appropriate.

SHUTDOWN

The enable pin (EN) is active high and is compatible with standard and low voltage, TTL-CMOS levels. When shutdown capability is not required, EN can be connected to the IN pin, as shown in [Figure 40](#). [Figure 41](#) shows when both EN and VSET are tied to IN. The TPS728xx, with internal active output pulldown circuitry, discharges the output to within 5% of V_{OUT} with a time (t) of:

$$t = 3 \left[\frac{60 \times R_L}{60 + R_L} \right] \times C_{OUT}$$

Where:

- R_L = output load resistance
- C_{OUT} = output capacitance

DROPOUT VOLTAGE

The TPS728xx uses a PMOS pass transistor to achieve low dropout. When $(V_{IN} - V_{OUT})$ is less than the dropout voltage (V_{DO}), the PMOS pass device is in the linear region of operation and the input-to-output resistance is the $R_{DS(ON)}$ of the PMOS pass element. V_{DO} approximately scales with output current because the PMOS device behaves like a resistor in dropout.

As with any linear regulator, PSRR and transient response are degraded as $(V_{IN} - V_{OUT})$ approaches dropout. This effect is shown in [Figure 25](#) and [Figure 26](#) in the [Typical Characteristics](#) section.

TRANSIENT RESPONSE

As with any regulator, increasing the size of the output capacitor reduces over/undershoot magnitude but increases duration of the transient response.

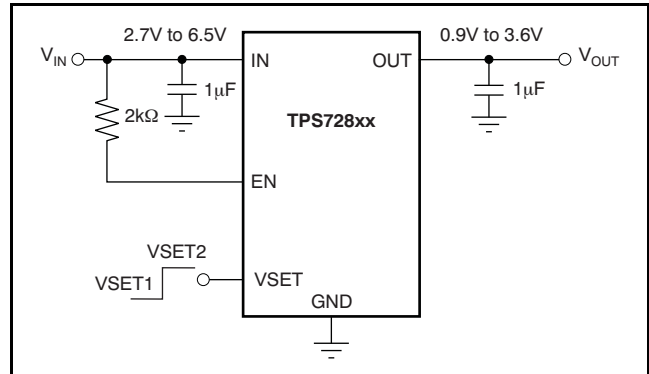

Figure 40. Circuit Showing EN Tied High when Shutdown Capability is Not Required

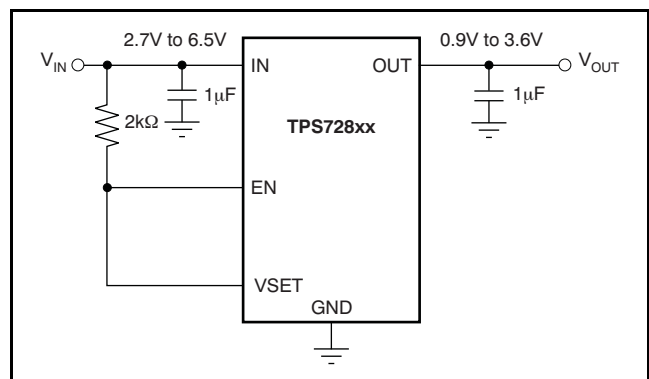

Figure 41. Circuit to Tie Both EN and VSET High

UNDERVOLTAGE LOCK-OUT (UVLO)

The TPS728xx uses an undervoltage lock-out circuit to keep the output shut off until the internal circuitry is operating properly. The UVLO circuit has a deglitch feature so that it typically ignores undershoot transients on the input if they are less than 5μs duration. The UVLO circuit triggers at approximately 2.3V on an undershooting or a falling input voltage. On the TPS728xx, the active pulldown discharges V_{OUT} when the device is in UVLO off condition. However, the input voltage must be greater than 0.8V for the active pulldown to work.

MINIMUM LOAD

The TPS728xx is stable with no output load. Traditional PMOS LDO regulators suffer from lower loop gain at very light output loads. The TPS728xx employs an innovative, low-current mode circuit under very light or no-load conditions, resulting in improved output voltage regulation performance down to zero output current.

THERMAL INFORMATION

Thermal Protection

Thermal protection disables the output when the junction temperature rises to approximately +160°C, allowing the device to cool. When the junction temperature cools to approximately +140°C the output circuitry is again enabled. Depending on power dissipation, thermal resistance, and ambient temperature, the thermal protection circuit may cycle on and off. This cycling limits the dissipation of the regulator, protecting it from damage as a result of overheating.

Any tendency to activate the thermal protection circuit indicates excessive power dissipation or an inadequate heatsink. For reliable operation, junction temperature should be limited to +125°C maximum. To estimate the margin of safety in a complete design (including heatsink), increase the ambient temperature until the thermal protection is triggered; use worst-case loads and signal conditions. For good reliability, thermal protection should trigger at least +35°C above the maximum expected ambient condition of your particular application. This configuration produces a worst-case junction temperature of +125°C at the highest expected ambient temperature and worst-case load.

The internal protection circuitry of the TPS728xx has been designed to protect against overload conditions.

It was not intended to replace proper heatsinking. Continuously running the TPS728xx into thermal shutdown degrades device reliability.

Power Dissipation

The ability to remove heat from the die is different for each package type, presenting different considerations in the printed circuit board (PCB) layout. The PCB area around the device that is free of other components moves the heat from the device to the ambient air. Performance data for JEDEC low- and high-K boards are given in the [Dissipation Ratings](#) table. Using heavier copper increases the effectiveness in removing heat from the device. The addition of plated through-holes to heat-dissipating layers also improves the heatsink effectiveness.

Power dissipation depends on input voltage and load conditions. Power dissipation (P_D) is equal to the product of the output current times the voltage drop across the output pass element (V_{IN} to V_{OUT}), as shown in [Equation 1](#):

$$P_D = (V_{IN} - V_{OUT}) \times I_{OUT} \quad (1)$$

Package Mounting

Solder pad footprint recommendations for the TPS728xx are available from the Texas Instruments web site at www.ti.com.

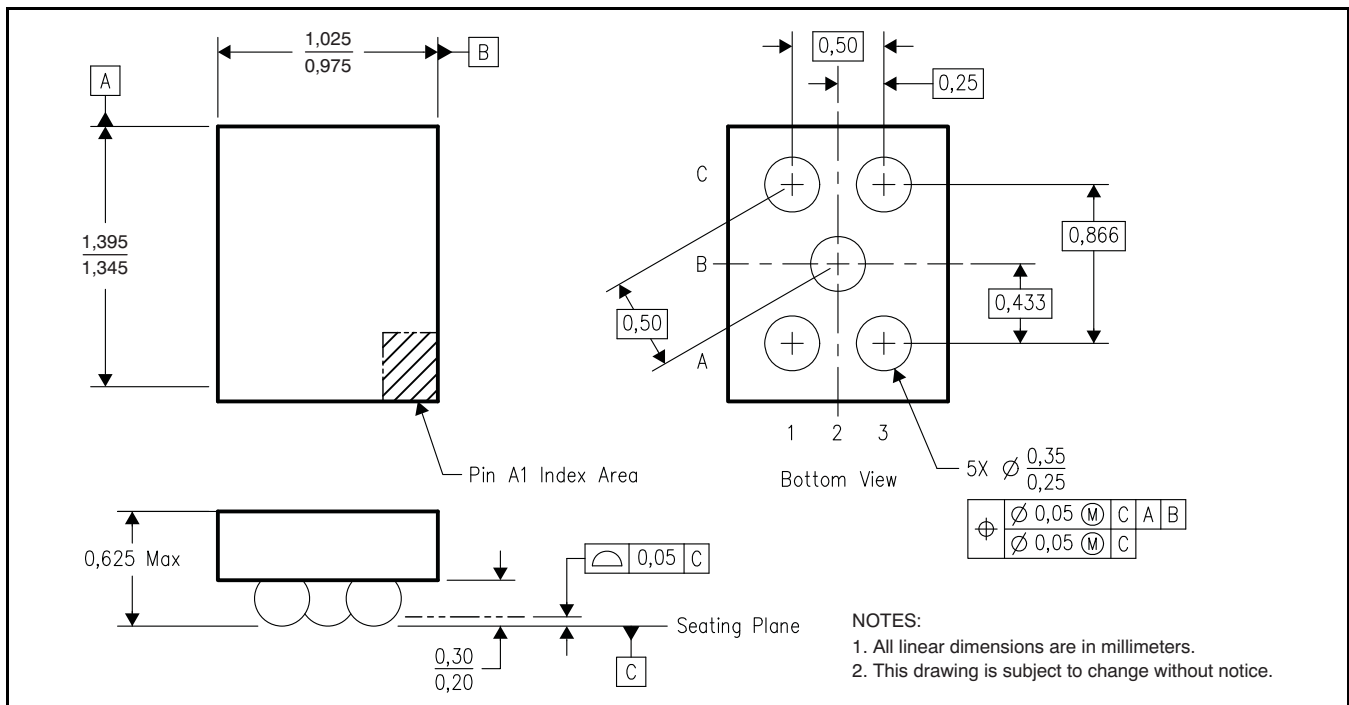

Figure 42. YZU Wafer Chip-Scale Package Dimensions (in mm)

PACKAGING INFORMATION

Orderable Device	Status (1)	Package Type	Package Drawing	Pins	Package Qty	Eco Plan (2)	Lead finish/ Ball material (6)	MSL Peak Temp (3)	Op Temp (°C)	Device Marking (4/5)	Samples
TPS728100180DRVR	ACTIVE	WSON	DRV	6	3000	RoHS & Green	NIPDAU	Level-1-260C-UNLIM	-40 to 125	1GZ	Samples
TPS728120150DRVR	ACTIVE	WSON	DRV	6	3000	RoHS & Green	NIPDAUAG	Level-1-260C-UNLIM	-40 to 125	DAO	Samples
TPS728120150DRVT	ACTIVE	WSON	DRV	6	250	RoHS & Green	NIPDAUAG	Level-1-260C-UNLIM	-40 to 125	DAO	Samples
TPS728175295YZUR	ACTIVE	DSBGA	YZU	5	3000	RoHS & Green	SNAGCU	Level-1-260C-UNLIM	-40 to 125	AU	Samples
TPS728175295YZUT	ACTIVE	DSBGA	YZU	5	250	RoHS & Green	SNAGCU	Level-1-260C-UNLIM	-40 to 125	AU	Samples
TPS728180285YZUR	ACTIVE	DSBGA	YZU	5	3000	RoHS & Green	SNAGCU	Level-1-260C-UNLIM	-40 to 125	DT	Samples
TPS728180285YZUT	ACTIVE	DSBGA	YZU	5	250	RoHS & Green	SNAGCU	Level-1-260C-UNLIM	-40 to 125	DT	Samples
TPS728180300YZUR	ACTIVE	DSBGA	YZU	5	3000	RoHS & Green	SNAGCU	Level-1-260C-UNLIM	-40 to 125	VL	Samples
TPS728180300YZUT	ACTIVE	DSBGA	YZU	5	250	RoHS & Green	SNAGCU	Level-1-260C-UNLIM	-40 to 125	VL	Samples
TPS728185295YZUR	ACTIVE	DSBGA	YZU	5	3000	RoHS & Green	SNAGCU	Level-1-260C-UNLIM	-40 to 125	VM	Samples
TPS728185295YZUT	ACTIVE	DSBGA	YZU	5	250	RoHS & Green	SNAGCU	Level-1-260C-UNLIM	-40 to 125	VM	Samples
TPS728185315DRVT	ACTIVE	WSON	DRV	6	250	RoHS & Green	NIPDAUAG	Level-1-260C-UNLIM	-40 to 125	BYW	Samples
TPS728185315YZUR	ACTIVE	DSBGA	YZU	5	3000	RoHS & Green	SNAGCU	Level-1-260C-UNLIM	-40 to 125	FN	Samples
TPS728185315YZUT	ACTIVE	DSBGA	YZU	5	250	RoHS & Green	SNAGCU	Level-1-260C-UNLIM	-40 to 125	FN	Samples
TPS728285180YZUR	ACTIVE	DSBGA	YZU	5	3000	RoHS & Green	SNAGCU	Level-1-260C-UNLIM	-40 to 125	TL	Samples
TPS728285180YZUT	ACTIVE	DSBGA	YZU	5	250	RoHS & Green	SNAGCU	Level-1-260C-UNLIM	-40 to 125	TL	Samples
TPS728330180YZUR	ACTIVE	DSBGA	YZU	5	3000	RoHS & Green	SNAGCU	Level-1-260C-UNLIM	-40 to 125	DJ	Samples
TPS728330180YZUT	ACTIVE	DSBGA	YZU	5	250	RoHS & Green	SNAGCU	Level-1-260C-UNLIM	-40 to 125	DJ	Samples
TPS728330185DRVR	ACTIVE	WSON	DRV	6	3000	RoHS & Green	NIPDAU	Level-1-260C-UNLIM	-40 to 125	SBD	Samples
TPS728330185DRVT	ACTIVE	WSON	DRV	6	250	RoHS & Green	NIPDAU	Level-1-260C-UNLIM	-40 to 125	SBD	Samples

(1) The marketing status values are defined as follows:

ACTIVE: Product device recommended for new designs.

LIFEBUY: TI has announced that the device will be discontinued, and a lifetime-buy period is in effect.

NRND: Not recommended for new designs. Device is in production to support existing customers, but TI does not recommend using this part in a new design.

PREVIEW: Device has been announced but is not in production. Samples may or may not be available.

OBSOLETE: TI has discontinued the production of the device.

(2) **RoHS:** TI defines "RoHS" to mean semiconductor products that are compliant with the current EU RoHS requirements for all 10 RoHS substances, including the requirement that RoHS substance do not exceed 0.1% by weight in homogeneous materials. Where designed to be soldered at high temperatures, "RoHS" products are suitable for use in specified lead-free processes. TI may reference these types of products as "Pb-Free".

RoHS Exempt: TI defines "RoHS Exempt" to mean products that contain lead but are compliant with EU RoHS pursuant to a specific EU RoHS exemption.

Green: TI defines "Green" to mean the content of Chlorine (Cl) and Bromine (Br) based flame retardants meet JS709B low halogen requirements of ≤ 1000 ppm threshold. Antimony trioxide based flame retardants must also meet the ≤ 1000 ppm threshold requirement.

(3) MSL, Peak Temp. - The Moisture Sensitivity Level rating according to the JEDEC industry standard classifications, and peak solder temperature.

(4) There may be additional marking, which relates to the logo, the lot trace code information, or the environmental category on the device.

(5) Multiple Device Markings will be inside parentheses. Only one Device Marking contained in parentheses and separated by a "~" will appear on a device. If a line is indented then it is a continuation of the previous line and the two combined represent the entire Device Marking for that device.

(6) Lead finish/Ball material - Orderable Devices may have multiple material finish options. Finish options are separated by a vertical ruled line. Lead finish/Ball material values may wrap to two lines if the finish value exceeds the maximum column width.

Important Information and Disclaimer: The information provided on this page represents TI's knowledge and belief as of the date that it is provided. TI bases its knowledge and belief on information provided by third parties, and makes no representation or warranty as to the accuracy of such information. Efforts are underway to better integrate information from third parties. TI has taken and continues to take reasonable steps to provide representative and accurate information but may not have conducted destructive testing or chemical analysis on incoming materials and chemicals. TI and TI suppliers consider certain information to be proprietary, and thus CAS numbers and other limited information may not be available for release.

In no event shall TI's liability arising out of such information exceed the total purchase price of the TI part(s) at issue in this document sold by TI to Customer on an annual basis.

TAPE AND REEL INFORMATION

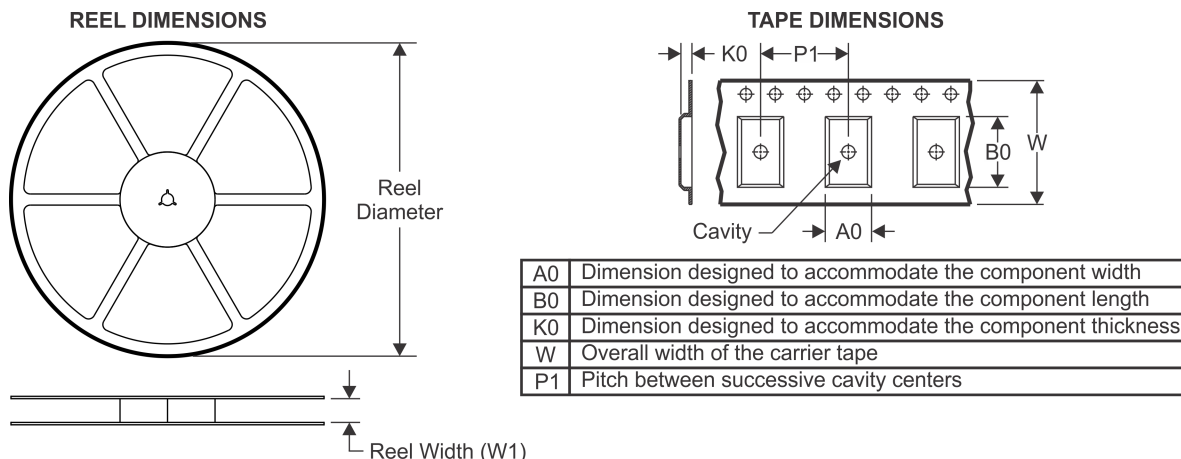

QUADRANT ASSIGNMENTS FOR PIN 1 ORIENTATION IN TAPE



*All dimensions are nominal

Device	Package Type	Package Drawing	Pins	SPQ	Reel Diameter (mm)	Reel Width W1 (mm)	A0 (mm)	B0 (mm)	K0 (mm)	P1 (mm)	W (mm)	Pin1 Quadrant
TPS728100180DRVR	WSO	DRV	6	3000	180.0	8.4	2.2	2.2	1.2	4.0	8.0	Q2
TPS728120150DRVR	WSO	DRV	6	3000	179.0	8.4	2.2	2.2	1.2	4.0	8.0	Q2
TPS728120150DRVT	WSO	DRV	6	250	179.0	8.4	2.2	2.2	1.2	4.0	8.0	Q2
TPS728175295YZUR	DSBGA	YZU	5	3000	180.0	8.4	1.07	1.42	0.74	4.0	8.0	Q1
TPS728175295YZUT	DSBGA	YZU	5	250	180.0	8.4	1.07	1.42	0.74	4.0	8.0	Q1
TPS728180285YZUR	DSBGA	YZU	5	3000	180.0	8.4	1.07	1.42	0.74	4.0	8.0	Q1
TPS728180285YZUT	DSBGA	YZU	5	250	180.0	8.4	1.07	1.42	0.74	4.0	8.0	Q1
TPS728180300YZUR	DSBGA	YZU	5	3000	180.0	8.4	1.07	1.42	0.74	4.0	8.0	Q1
TPS728180300YZUT	DSBGA	YZU	5	250	180.0	8.4	1.07	1.42	0.74	4.0	8.0	Q1
TPS728185295YZUR	DSBGA	YZU	5	3000	180.0	8.4	1.07	1.42	0.74	4.0	8.0	Q1
TPS728185295YZUT	DSBGA	YZU	5	250	180.0	8.4	1.07	1.42	0.74	4.0	8.0	Q1
TPS728185315DRVT	WSO	DRV	6	250	179.0	8.4	2.2	2.2	1.2	4.0	8.0	Q2
TPS728185315YZUR	DSBGA	YZU	5	3000	180.0	8.4	1.07	1.42	0.74	4.0	8.0	Q1
TPS728185315YZUT	DSBGA	YZU	5	250	180.0	8.4	1.07	1.42	0.74	4.0	8.0	Q1
TPS728285180YZUR	DSBGA	YZU	5	3000	180.0	8.4	1.07	1.42	0.74	4.0	8.0	Q1
TPS728285180YZUT	DSBGA	YZU	5	250	180.0	8.4	1.07	1.42	0.74	4.0	8.0	Q1
TPS728330180YZUR	DSBGA	YZU	5	3000	180.0	8.4	1.07	1.42	0.74	4.0	8.0	Q1
TPS728330180YZUT	DSBGA	YZU	5	250	180.0	8.4	1.07	1.42	0.74	4.0	8.0	Q1

Device	Package Type	Package Drawing	Pins	SPQ	Reel Diameter (mm)	Reel Width W1 (mm)	A0 (mm)	B0 (mm)	K0 (mm)	P1 (mm)	W (mm)	Pin1 Quadrant
TPS728330185DRVR	WSON	DRV	6	3000	179.0	8.4	2.2	2.2	1.2	4.0	8.0	Q2
TPS728330185DRVT	WSON	DRV	6	250	179.0	8.4	2.2	2.2	1.2	4.0	8.0	Q2

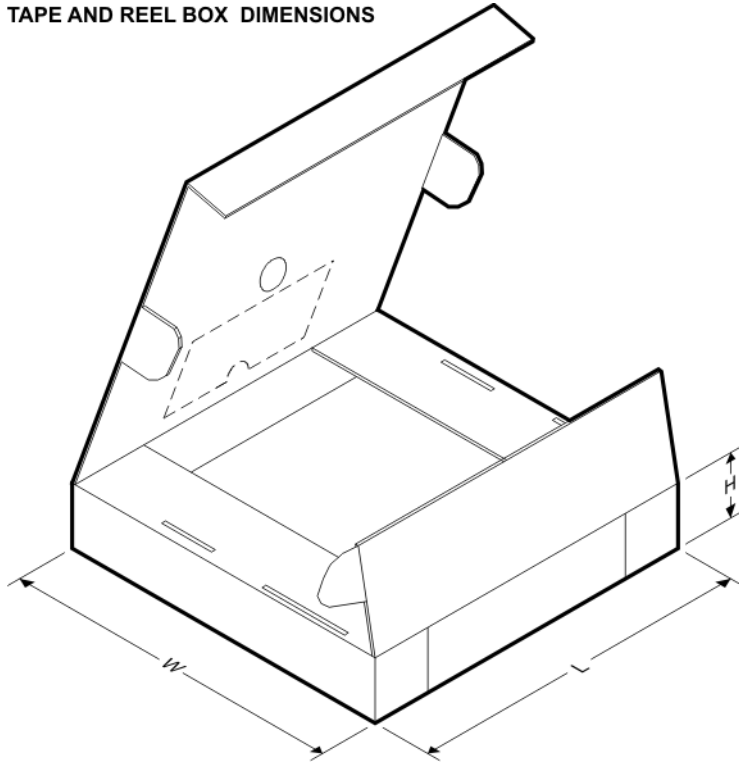
TAPE AND REEL BOX DIMENSIONS

*All dimensions are nominal

Device	Package Type	Package Drawing	Pins	SPQ	Length (mm)	Width (mm)	Height (mm)
TPS728100180DRVR	WSON	DRV	6	3000	200.0	183.0	25.0
TPS728120150DRVR	WSON	DRV	6	3000	200.0	183.0	25.0
TPS728120150DRVT	WSON	DRV	6	250	200.0	183.0	25.0
TPS728175295YZUR	DSBGA	YZU	5	3000	182.0	182.0	20.0
TPS728175295YZUT	DSBGA	YZU	5	250	182.0	182.0	20.0
TPS728180285YZUR	DSBGA	YZU	5	3000	182.0	182.0	20.0
TPS728180285YZUT	DSBGA	YZU	5	250	182.0	182.0	20.0
TPS728180300YZUR	DSBGA	YZU	5	3000	182.0	182.0	20.0
TPS728180300YZUT	DSBGA	YZU	5	250	182.0	182.0	20.0
TPS728185295YZUR	DSBGA	YZU	5	3000	182.0	182.0	20.0
TPS728185295YZUT	DSBGA	YZU	5	250	182.0	182.0	20.0
TPS728185315DRVT	WSON	DRV	6	250	200.0	183.0	25.0
TPS728185315YZUR	DSBGA	YZU	5	3000	182.0	182.0	20.0
TPS728185315YZUT	DSBGA	YZU	5	250	182.0	182.0	20.0
TPS728285180YZUR	DSBGA	YZU	5	3000	182.0	182.0	20.0

Device	Package Type	Package Drawing	Pins	SPQ	Length (mm)	Width (mm)	Height (mm)
TPS728285180YZUT	DSBGA	YZU	5	250	182.0	182.0	20.0
TPS728330180YZUR	DSBGA	YZU	5	3000	182.0	182.0	20.0
TPS728330180YZUT	DSBGA	YZU	5	250	182.0	182.0	20.0
TPS728330185DRVR	WSON	DRV	6	3000	200.0	183.0	25.0
TPS728330185DRVT	WSON	DRV	6	250	200.0	183.0	25.0

YZU0005

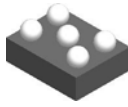

PACKAGE OUTLINE

DSBGA - 0.625 mm max height

DIE SIZE BALL GRID ARRAY

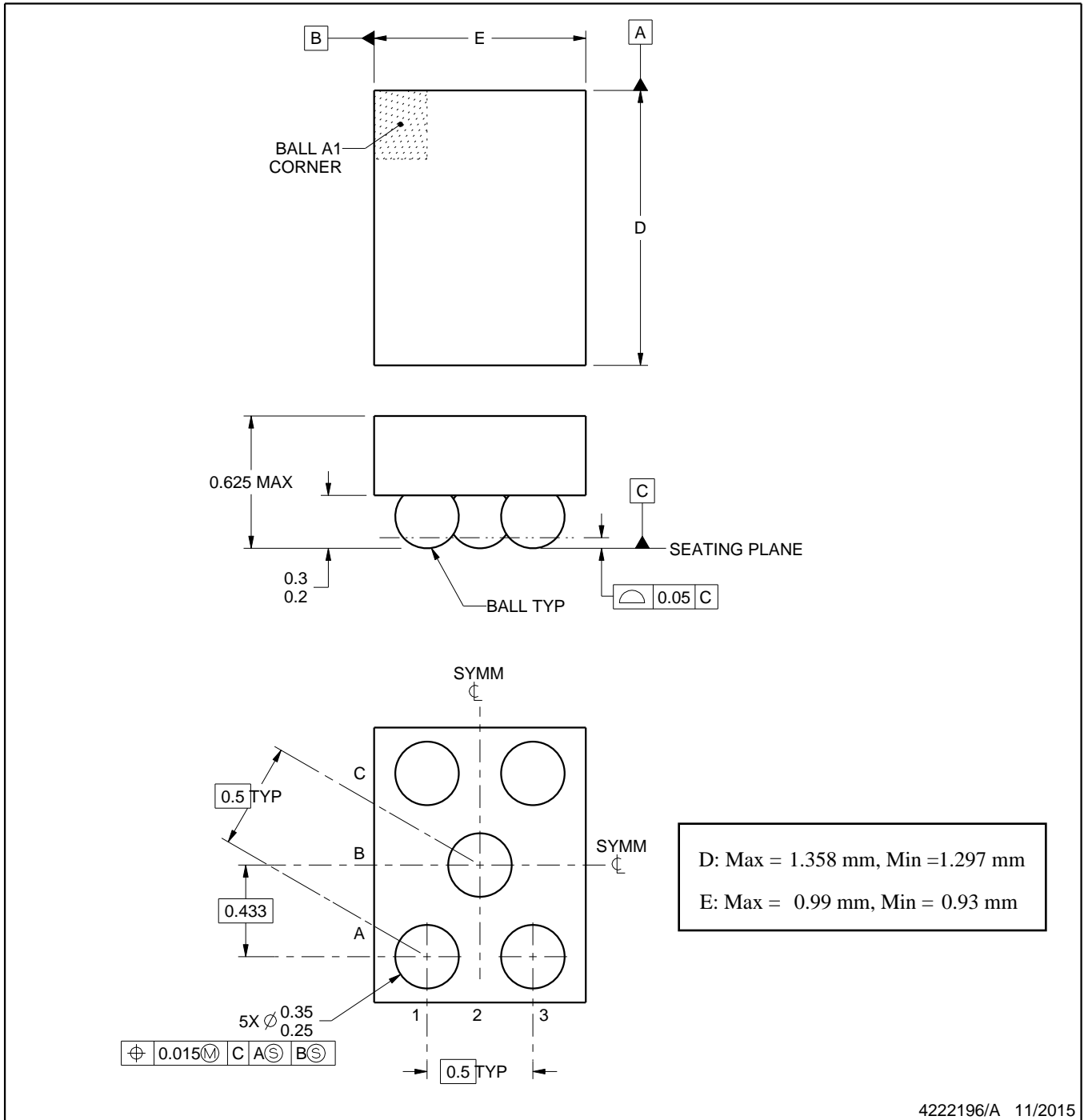

NOTES:

1. All linear dimensions are in millimeters. Any dimensions in parenthesis are for reference only. Dimensioning and tolerancing per ASME Y14.5M.
2. This drawing is subject to change without notice.

EXAMPLE BOARD LAYOUT

YZU0005

DSBGA - 0.625 mm max height

DIE SIZE BALL GRID ARRAY

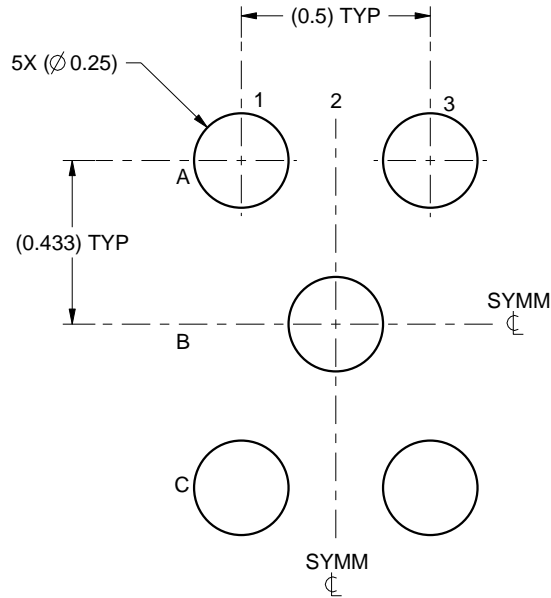

LAND PATTERN EXAMPLE
SCALE:50X

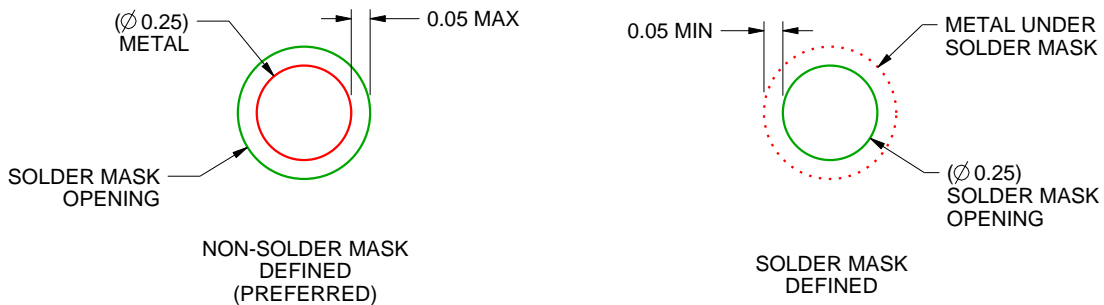

SOLDER MASK DETAILS
NOT TO SCALE

4222196/A 11/2015

NOTES: (continued)

- Final dimensions may vary due to manufacturing tolerance considerations and also routing constraints. Refer to Texas Instruments Literature No. SNVA009 (www.ti.com/lit/snva009).

EXAMPLE STENCIL DESIGN

YZU0005

DSBGA - 0.625 mm max height

DIE SIZE BALL GRID ARRAY

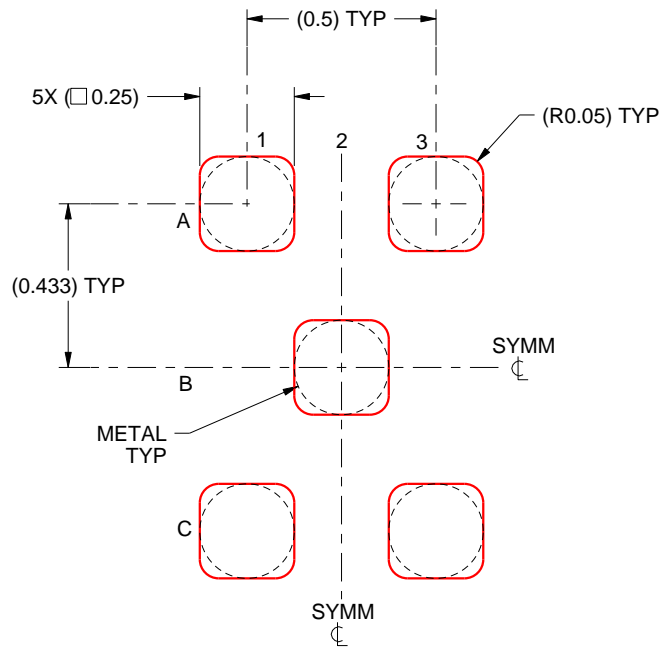

SOLDER PASTE EXAMPLE
BASED ON 0.1 mm THICK STENCIL
SCALE:50X

4222196/A 11/2015

NOTES: (continued)

4. Laser cutting apertures with trapezoidal walls and rounded corners may offer better paste release.

GENERIC PACKAGE VIEW

DRV 6

WSON - 0.8 mm max height

PLASTIC SMALL OUTLINE - NO LEAD



Images above are just a representation of the package family, actual package may vary.
Refer to the product data sheet for package details.

4206925/F



4222173/B 04/2018

NOTES:

1. All linear dimensions are in millimeters. Any dimensions in parenthesis are for reference only. Dimensioning and tolerancing per ASME Y14.5M.
2. This drawing is subject to change without notice.
3. The package thermal pad must be soldered to the printed circuit board for thermal and mechanical performance.

EXAMPLE BOARD LAYOUT

DRV0006A

WSON - 0.8 mm max height

PLASTIC SMALL OUTLINE - NO LEAD



LAND PATTERN EXAMPLE
SCALE:25X



SOLDER MASK DETAILS

4222173/B 04/2018

NOTES: (continued)

4. This package is designed to be soldered to a thermal pad on the board. For more information, see Texas Instruments literature number SLUA271 (www.ti.com/lit/sluea271).
5. Vias are optional depending on application, refer to device data sheet. If some or all are implemented, recommended via locations are shown.

EXAMPLE STENCIL DESIGN

DRV0006A

WSON - 0.8 mm max height

PLASTIC SMALL OUTLINE - NO LEAD



SOLDER PASTE EXAMPLE
BASED ON 0.125 mm THICK STENCIL

EXPOSED PAD #7
88% PRINTED SOLDER COVERAGE BY AREA UNDER PACKAGE
SCALE:30X

4222173/B 04/2018

NOTES: (continued)

6. Laser cutting apertures with trapezoidal walls and rounded corners may offer better paste release. IPC-7525 may have alternate design recommendations.

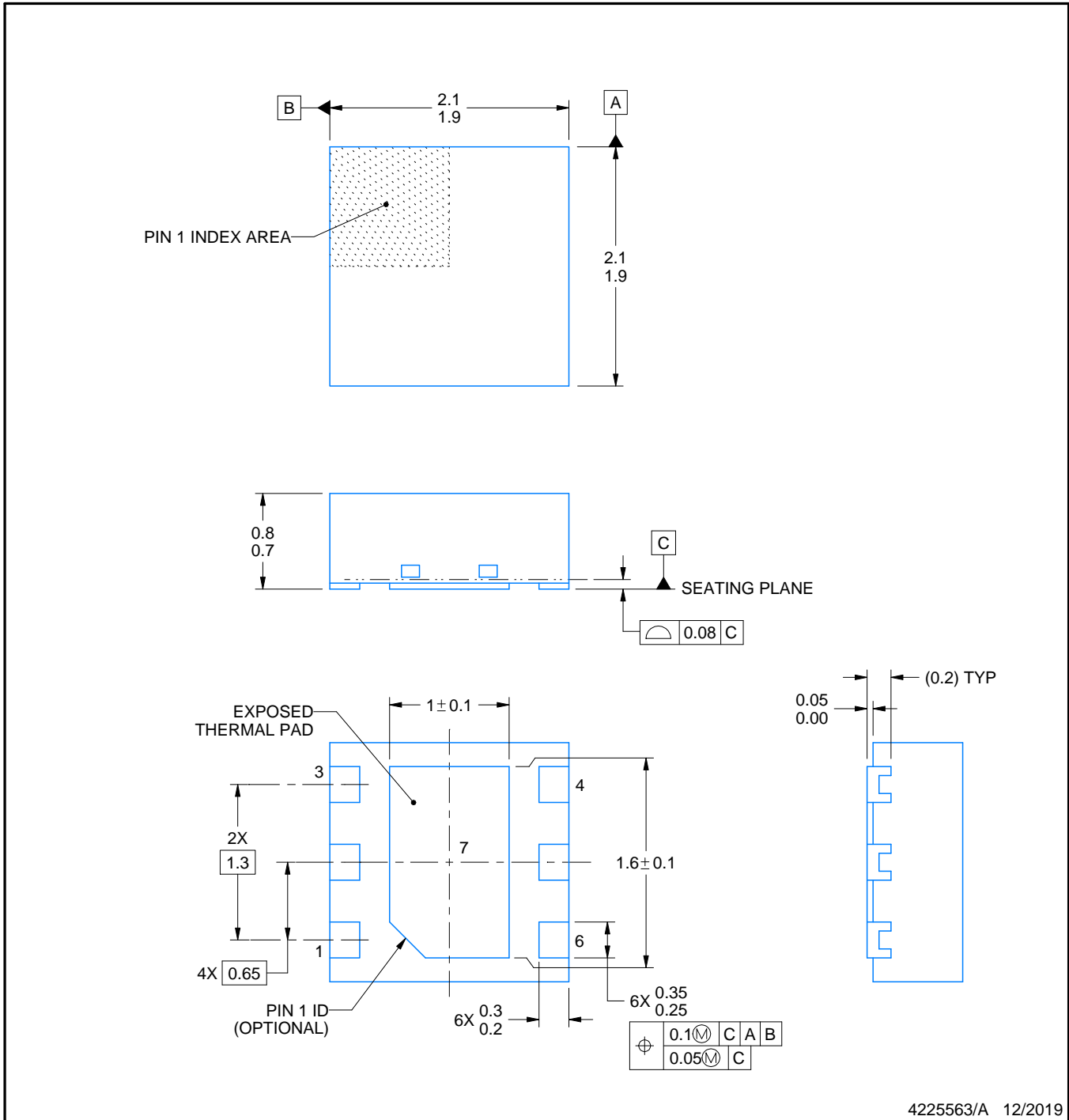

NOTES:

1. All linear dimensions are in millimeters. Any dimensions in parenthesis are for reference only. Dimensioning and tolerancing per ASME Y14.5M.
2. This drawing is subject to change without notice.
3. The package thermal pad must be soldered to the printed circuit board for thermal and mechanical performance.

EXAMPLE BOARD LAYOUT

DRV0006D

WSON - 0.8 mm max height

PLASTIC SMALL OUTLINE - NO LEAD



LAND PATTERN EXAMPLE
EXPOSED METAL SHOWN
SCALE:25X



SOLDER MASK DETAILS

4225563/A 12/2019

NOTES: (continued)

4. This package is designed to be soldered to a thermal pad on the board. For more information, see Texas Instruments literature number SLUA271 (www.ti.com/lit/sluea271).
5. Vias are optional depending on application, refer to device data sheet. If some or all are implemented, recommended via locations are shown.

EXAMPLE STENCIL DESIGN

DRV0006D

WSON - 0.8 mm max height

PLASTIC SMALL OUTLINE - NO LEAD



SOLDER PASTE EXAMPLE
BASED ON 0.125 mm THICK STENCIL

EXPOSED PAD #7
88% PRINTED SOLDER COVERAGE BY AREA UNDER PACKAGE
SCALE:30X

4225563/A 12/2019

NOTES: (continued)

6. Laser cutting apertures with trapezoidal walls and rounded corners may offer better paste release. IPC-7525 may have alternate design recommendations.

IMPORTANT NOTICE AND DISCLAIMER

TI PROVIDES TECHNICAL AND RELIABILITY DATA (INCLUDING DATA SHEETS), DESIGN RESOURCES (INCLUDING REFERENCE DESIGNS), APPLICATION OR OTHER DESIGN ADVICE, WEB TOOLS, SAFETY INFORMATION, AND OTHER RESOURCES "AS IS" AND WITH ALL FAULTS, AND DISCLAIMS ALL WARRANTIES, EXPRESS AND IMPLIED, INCLUDING WITHOUT LIMITATION ANY IMPLIED WARRANTIES OF MERCHANTABILITY, FITNESS FOR A PARTICULAR PURPOSE OR NON-INFRINGEMENT OF THIRD PARTY INTELLECTUAL PROPERTY RIGHTS.

These resources are intended for skilled developers designing with TI products. You are solely responsible for (1) selecting the appropriate TI products for your application, (2) designing, validating and testing your application, and (3) ensuring your application meets applicable standards, and any other safety, security, regulatory or other requirements.

These resources are subject to change without notice. TI grants you permission to use these resources only for development of an application that uses the TI products described in the resource. Other reproduction and display of these resources is prohibited. No license is granted to any other TI intellectual property right or to any third party intellectual property right. TI disclaims responsibility for, and you will fully indemnify TI and its representatives against, any claims, damages, costs, losses, and liabilities arising out of your use of these resources.

TI's products are provided subject to [TI's Terms of Sale](#) or other applicable terms available either on ti.com or provided in conjunction with such TI products. TI's provision of these resources does not expand or otherwise alter TI's applicable warranties or warranty disclaimers for TI products.

TI objects to and rejects any additional or different terms you may have proposed.

Mailing Address: Texas Instruments, Post Office Box 655303, Dallas, Texas 75265
Copyright © 2022, Texas Instruments Incorporated