

带集成式合成器的 LMX8410L 高性能混合器

1 特性

- 宽带射频输入：4 至 10GHz
- 大型中频带宽：直流至 1350MHz
- 输入 IP3：5GHz 射频输入时为 28dBm
- 噪声系数：5GHz 射频输入时为 15dB
- 高电压转换增益：5GHz 射频输入时为 11dB
- 集成宽带射频输入平衡-非平衡变压器
- 自动离线直流失调电压校正为 $\pm 2\text{mV}$
- 可编程 IMRR 校准
- 针对多个器件的同步功能
- 高性能集成 LO 合成器：5GHz 载波条件下具有 56.5dBc 的 DSB 集成噪声
- 外部 LO 模式：可旁路绕开集成 LO 合成器；支持外部 LO 注入
- 集成低噪声 LDO
- 7mm x 7mm 48 引脚 QFN 封装

2 应用

- 测试和测量设备
- 无线基础设施
- 相控阵雷达
- 微波回程
- 卫星通信
- 软件定义无线电

3 说明

LMX8410L 是一款具有集成 LO 和 IF 放大器的高性能宽带（射频输入为 4 至 10GHz）I/Q 解调器。在 IIP3 为 28dBm 而 NF 为 15dB（频率均为 5GHz）的情况下，该器件可提供出色的动态范围，适用于高性能应用中使用 DP83869。该器件可提供 2.7GHz 的大型复杂带宽，适用于高数据速率应用。

LMX8410L 提供自动直流失调电压校正算法，可将失调电压降至 $\pm 2\text{mV}$ 以下。使用 SPI 接口可以精确控制 I 和 Q 通道的增益和相位，从而实现高镜像抑制。

LMX8410L 具有高度集成度，可提供高性能，同时还能节省布板空间并降低复杂性。它集成了宽带射频输入平衡-非平衡变压器，因此无需外部平衡-非平衡变压器。它集成了高性能 PLL 和 VCO，因此无需外部 LO 和 LO 驱动器。该器件还集成了一个 IF 放大器和几个低噪声 LDO，进一步简化了电路板。

LMX8410L 集成了一个极低噪声的合成器，PLL FOM 为 -236dBc/Hz ，在 5GHz 载波条件下提供高达 56.5dBc 的 DSB 集成噪声。LO 允许跨多个器件进行相位同步。高性能合成器输出可用于驱动另一级或数据转换器。对于共享外部 LO 的应用，可以旁路掉集成的 LO。

器件信息⁽¹⁾

器件型号	封装	封装尺寸（标称值）
LMX8410L	VQFN (48)	7.00mm x 7.00mm

(1) 如需了解所有可用封装，请参阅产品说明书末尾的可订购产品附录。

简化方框图

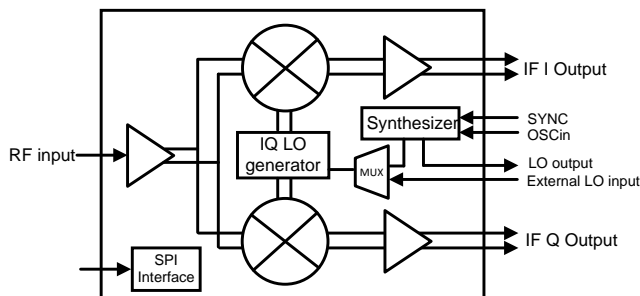

目录

1	特性	1	7.5	Programming.....	29
2	应用	1	7.6	Register Map.....	30
3	说明	1	8	Application and Implementation	53
4	修订历史记录	2	8.1	Application Information.....	53
5	Pin Configuration and Functions	3	8.2	Typical Application	53
6	Specifications.....	6	9	Power Supply Recommendations.....	56
6.1	Absolute Maximum Ratings	6	10	Layout.....	56
6.2	ESD Ratings.....	6	10.1	Layout Guidelines	56
6.3	Recommended Operating Conditions.....	6	10.2	Layout Examples.....	57
6.4	Thermal Information	6	11	器件和文档支持	61
6.5	Electrical Characteristics.....	7	11.1	文档支持.....	61
6.6	Timing Requirements	12	11.2	接收文档更新通知	61
6.7	Typical Characteristics	14	11.3	社区资源	61
7	Detailed Description	22	11.4	商标	61
7.1	Overview	22	11.5	静电放电警告.....	61
7.2	Functional Block Diagram	22	11.6	术语表	61
7.3	Feature Description.....	23	12	机械、封装和可订购信息.....	61
7.4	Device Functional Modes.....	28			

4 修订历史记录

注：之前版本的页码可能与当前版本有所不同。

Changes from Original (March 2018) to Revision A	Page
• 首次发布生产数据产品说明书	1
• Changed many numbers in electrical specifications table.	6
• 已添加 typical performance characteristics section.	14
• 已更改 and added significant details in detailed descriptions sections. Added sections, changed several portions of the register map.....	22

5 Pin Configuration and Functions

**RGZ Package
48-Pin QFN
Top View**

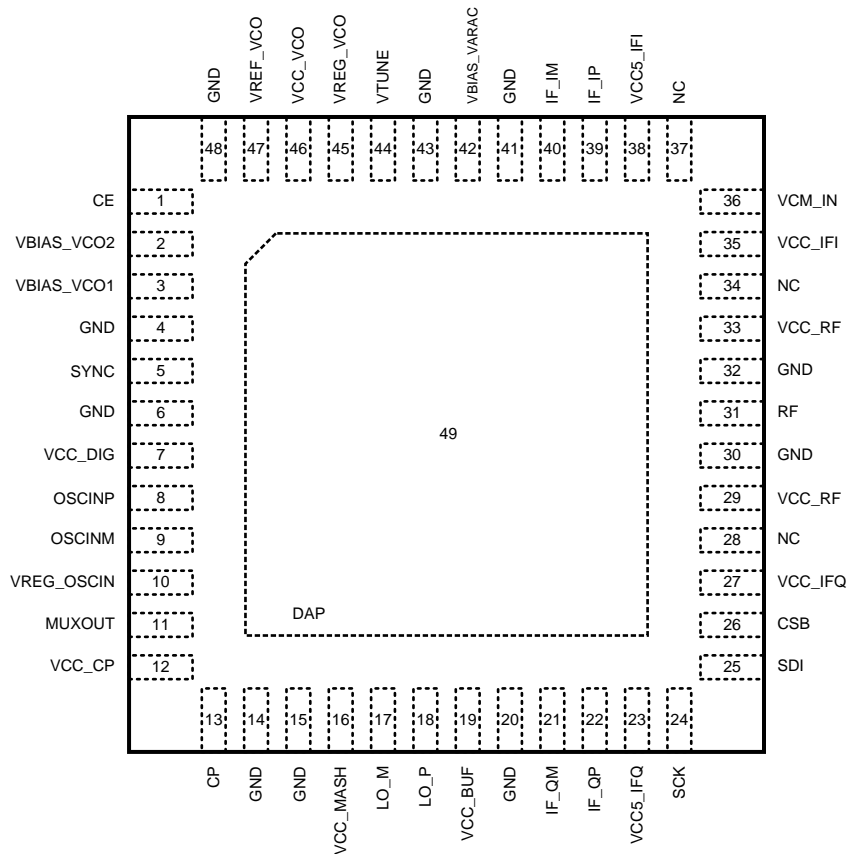

Pin Functions

PIN		I/O	DESCRIPTION
NAME	NAME		
1	CE	Input	Chip Enable input. Active HIGH powers on the device. 1.8V to 3.3V logic.
2	VBIAS_VCO2	Bypass	VCO bias. Requires connecting 10- μ F capacitor to VCO ground. Place close to pin. If using external LO, this pin should either be floated or configured the same way as internal LO mode.
3	VBIAS_VCO1	Bypass	VCO bias. Requires connecting 10- μ F capacitor to VCO ground. Place close to pin. If using external LO, this pin should either be floated or configured the same way as internal LO mode.
4	GND	Ground	VCO ground. VBIAS pin capacitors must bypass to this point.
5	SYNC	Input	Trigger pin for synchronizing multiple devices. If using external LO, tie this pin to GND.
6	GND	Ground	Digital ground. VCC_DIG bypass capacitors must bypass to this point.
7	VCC_DIG	Supply	Digital supply. TI recommends connecting 0.1- μ F capacitor to digital ground.
8	OSCINP	Input	Reference input clock (+). High input impedance. Requires connecting series capacitor (0.1 μ F recommended). If using external LO, tie this pin to GND.
9	OSCINM	Input	Reference input clock (-). High input impedance. Requires connecting series capacitor (0.1 μ F recommended). If using external LO, tie this pin to GND.
10	VREG_OSCIN	Bypass	Internal LDO output. Requires connecting 1- μ F capacitor to digital ground. Place close to pin. If using external LO, this pin should either be floated or configured the same way as internal LO mode.

Pin Functions (continued)

PIN		I/O	DESCRIPTION
NAME	NAME		
11	MUXOUT	Output	Readback or lock detect output. Pin mode configured by internal register settings.
12	VCC_CP	Supply	Charge pump supply. TI recommends connecting 0.1 μ F and 100 pF to charge pump ground. Place close to pin. This pin must be connected to VCC, even if using external LO.
13	CP	Output	Charge pump output. TI recommends connecting C1 of loop filter close to pin. If using external LO, this pin should either be floated or configured the same way as internal LO mode.
14	GND	Ground	Charge pump ground. VCC_CP bypass capacitors must bypass to this point.
15	GND	Ground	MASH engine ground. VCC_MASH bypass capacitors must bypass to this point.
16	VCC_MASH	Supply	MASH engine supply. TI recommends connecting 0.1 μ F and 100 pF to MASH engine ground. Place close to pin. This pin must be connected to VCC, even if using external LO.
17	LO_M	Input/Output	Internal LO differential output (–) or external LO differential input (–). In differential output mode, requires connecting 50- Ω resistor pullup to V _{CC} as close as possible to pin. In differential input mode, remove the pull up resistors or inductors. The input should be capacitively coupled with internal biasing. See LO Interface for more information.
18	LO_P	Input/Output	Internal LO differential output (+) or external LO differential input (+). In differential output mode, requires connecting 50- Ω resistor pullup to V _{CC} as close as possible to pin. In differential input mode, remove the pull up resistors or inductors. The input should be capacitively coupled with internal biasing. See LO Interface for more information.
19	VCC_BUF	Supply	LO buffer supply. TI recommends connecting 0.1 μ F and 100 pF to VCO ground. This pin must be connected to VCC, even if using external LO.
20	GND	Ground	IF amplifier Q-channel ground. Q-channel VCC5 bypass capacitors must bypass to this point.
21	IF_QM	Output	IF amplifier Q-channel differential output (–). TI recommends connecting series 50- Ω resistor close to pin.
22	IF_QP	Output	IF amplifier Q-channel differential output (+). TI recommends connecting series 50- Ω resistor close to pin.
23	VCC5_IFQ	Supply	IF amplifier Q-channel 5-V supply. TI recommends connecting 0.1 μ F and 100 pF to IF amplifier Q-channel ground. Place close to pin.
24	SCK	Input	SPI clock signal. High impedance CMOS input. 1.8-V to 3.3-V logic.
25	SDI	Input	SPI data signal. High impedance CMOS input. 1.8-V to 3.3-V logic.
26	CSB	Input	SPI chip select signal. High impedance CMOS input. 1.8-V to 3.3-V logic.
27	VCC_IFQ	Supply	IF mixer Q-channel supply. TI recommends connecting 0.1 μ F and 100 pF to digital ground.
28	NC	N/A	No connect. Pin is not internally connected and may be floated or shorted to other nodes.
29	VCC_RFQ	Supply	RF Q-channel supply. TI recommends connecting 0.1 μ F and 100 pF to digital ground.
32	GND	Ground	RF input path ground.
31	RF	Input	RF input. Single-ended. Must be AC coupled.
32	GND	Ground	RF input path ground.
33	VCC_RFI	Supply	RF I-channel supply. TI recommends connecting 0.1 μ F and 100 pF to digital ground.
34	GND	Ground	Should be connected IF ground.
35	VCC_IFI	Supply	IF mixer I-channel supply. TI recommends connecting 0.1 μ F and 100 pF to digital ground.
36	VCM_IN	Input	Common-mode voltage input. When the VCM_CONFIG register is set to external (0xF), the voltage on this pin sets the common-mode voltage of the IF amplifiers.
37	NC	Ground	Connect this pin to IF ground.
38	VCC5_IFI	Supply	IF amplifier I-channel 5-V supply. TI recommends connecting 0.1 μ F and 100 pF to IF amplifier I-channel ground. Place close to pin.
39	IF_IP	Output	IF amplifier I-channel differential output (+). TI recommends connecting series 50- Ω resistor close to pin.
40	IF_IM	Output	IF amplifier I-channel differential output (–). TI recommends connecting series 50- Ω resistor close to pin.
41	GND	Ground	IF amplifier I-channel ground. I-channel VCC5 bypass capacitors should bypass to this point.
42	VBIAS_VARAC	Bypass	VCO varactor bias. Requires connecting 10 μ F capacitor to VCO ground. If using external LO, this pin should either be floated or configured the same way as internal LO mode.
43	GND	Ground	VCO ground. Varactor bias bypass capacitor should bypass to this point.

Pin Functions (continued)

PIN		I/O	DESCRIPTION
NAME	NAME		
44	VTUNE	Input	VCO tuning voltage input. If using internal LO, connect the output of the loop filter to this point. If using external LO, tie this pin to GND.
45	VREG_VCO	Bypass	VCO LDO output node. Requires connecting 10- μ F capacitor to VCO ground. Place close to pin. This capacitor must be present even if used in external LO mode.
46	VCC_VCO	Supply	VCO supply. TI recommends connecting 0.1- μ F and 100-pF capacitors to VCO ground. This pin must be connected to VCC, even if using external LO.
47	VREF_VCO	Bypass	VCO LDO reference node. Requires connecting 1- μ F capacitor to VCO ground. If using external LO, this pin should either be floated or configured the same way as internal LO mode.
48	GND	Ground	VCO ground. VCO LDO, LDO reference, and supply bypass capacitors must bypass to this point.
49	PAD	Ground	Die attach pad. Internally connected to ground. TI recommends shorting ground pins to this pad on the same plane, if possible.

6 Specifications

6.1 Absolute Maximum Ratings

over operating free-air temperature range (unless otherwise noted)⁽¹⁾

		MIN	MAX	UNIT
V _{CC}	Power supply voltage, 3.3-V rail	-0.3	3.6	V
V _{CC5}	Power supply voltage, 5-V rail	-0.3	5.3	V
P _D	Power dissipation		5	W
T _J	Junction temperature	-40	150	°C
T _{stg}	Storage temperature	-65	150	°C

(1) Stresses beyond those listed under *Absolute Maximum Rating* may cause permanent damage to the device. These are stress ratings only, which do not imply functional operation of the device at these or any other conditions beyond those indicated under *Recommended Operating Condition*. Exposure to absolute-maximum-rated conditions for extended periods may affect device reliability.

6.2 ESD Ratings

		VALUE	UNIT
V _(ESD)	Electrostatic discharge	Human body model (HBM), per ANSI/ESDA/JEDEC JS-001, all pins	2500
		Charged device model (CDM), per JEDEC specification JESD22-C101, all pins	500

6.3 Recommended Operating Conditions

over operating free-air temperature range (unless otherwise noted)

		MIN	NOM	MAX	UNIT
V _{CC}	Power supply voltage, 3.3V rail	3.15	3.3	3.45	V
V _{CC5}	Power supply voltage, 5V rail	4.75	5	5.25	V
T _A	Ambient temperature	-40	25	85	°C
T _J	Junction temperature			125	°C

6.4 Thermal Information

THERMAL METRIC ⁽¹⁾ (2)		LMX8410L	UNIT
		RGZ (VQFN)	
		48 PINS	
R _{θJA}	Junction-to-ambient thermal resistance	21.9	°C/W
R _{θJC(top)}	Junction-to-case (top) thermal resistance	9.4	°C/W
R _{θJB}	Junction-to-board thermal resistance	5.6	°C/W
Ψ _{JT}	Junction-to-top characterization parameter	0.1	°C/W
Ψ _{JB}	Junction-to-board characterization parameter	5.6	°C/W
R _{θJC(bot)}	Junction-to-case (bottom) thermal resistance	0.4	°C/W

- (1) For more information about traditional and new thermal metrics, see the [Semiconductor and IC Package Thermal Metrics](#) application report.
- (2) Thermal model based on JEDEC standard coupon, 50.8 mm × 50.8 mm × 1.6 mm, six-layer Cu, 0.5 oz top layer, 2 oz else. 6 × 6 thermal vias in DAP, 0.2 mm diameter.

6.5 Electrical Characteristics

Measurements are done at 25 degree C. Parameters are measured at IF = 65MHz with high side injection, unless otherwise noted. Measurements are done with external VCM = 1.7V.

PARAMETER		TEST CONDITIONS	MIN	TYP	MAX	UNIT
POWER SUPPLY						
V _{CC}	Power supply voltage, 3.3-V rail		3.15	3.3	3.45	V
I _{CC}	Power supply current, 3.3-V rail	Internal LO		650		mA
		External LO		330		
V _{CC5}	Power supply voltage, 5-V rail		4.75	5	5.25	V
I _{CC5}	Power supply current both channels I and Q, 5-V rail			130		mA
FREQUENCY RANGES						
F _{RF}	RF port frequency range		4000		10000	MHz
F _{LO}	LO port frequency range		4000		10000	MHz
F _{IF}	IF port frequency range (3dB bandwidth)		DC		1350	MHz
DYNAMIC PERFORMANCE						
NF	Noise figure	RF = 4 GHz		15		dB
		RF = 5 GHz		15		
		RF = 6 GHz		16		
		RF = 7 GHz		17		
		RF = 8 GHz		18		
		RF = 9 GHz		19		
		RF = 10 GHz		19		
G	Voltage gain ⁽¹⁾	RF = 4 GHz		11		dB
		RF = 5 GHz		11		
		RF = 6 GHz		10.5		
		RF = 7 GHz		9.5		
		RF = 8 GHz		9		
		RF = 10 GHz		7		
IIP3	Input intercept point, 3rd order ⁽²⁾	RF = 4 GHz		28		dBm
		RF = 5 GHz		28		
		RF = 6 GHz		26.5		
		RF = 7 GHz		27		
		RF = 8 GHz		26.5		
		RF = 10 GHz		27		
IIP2	Input intercept point, 2nd order (uncalibrated)	RF = 4 GHz		48		dBm
		RF = 5 GHz		48		
		RF = 6 GHz		46		
		RF = 7 GHz		44		
		RF = 8 GHz		45		
		RF = 10 GHz		42		

(1) For measurements that require RF input, RF input power is -10dBm unless otherwise specified.

(2) For two-tone measurements, tone separation is 17MHz.

Electrical Characteristics (continued)

Measurements are done at 25 degree C. Parameters are measured at IF = 65MHz with high side injection, unless otherwise noted. Measurements are done with external VCM = 1.7V.

PARAMETER		TEST CONDITIONS	MIN	TYP	MAX	UNIT
SP _{2x2}	2x2 spur [RF input power at -10 dBm]	RF = 4 GHz		-58		dBc
		RF = 5 GHz		-58		
		RF = 6 GHz		-58		
		RF = 7 GHz		-54		
		RF = 8 GHz		-52		
		RF = 9 GHz		-50		
		RF = 10 GHz		-48		
SP _{3x3}	3x3 spur [RF input power at -10 dBm]	RF = 4 GHz		-75		dBc
		RF = 5 GHz		-75		
		RF = 6 GHz		-75		
		RF = 7 GHz		-75		
		RF = 8 GHz		-75		
		RF = 9 GHz		-75		
		RF = 10 GHz		-75		
OP _{1dB}	Output 1-dB compression point	RF = 4 GHz		12		dBm
		RF = 5 GHz		12		
		RF = 6 GHz		12		
		RF = 7 GHz		12		
		RF = 8 GHz		12		
		RF = 9 GHz		12		
		RF = 10 GHz		12		
IRR	Image rejection ratio [calibrated]	RF = 4 GHz		43		dB
		RF = 5 GHz		43		
		RF = 6 GHz		44		
		RF = 7 GHz		44		
		RF = 8 GHz		43		
		RF = 9 GHz		42		
		RF = 10 GHz		36		
ISO _{RFxIF}	RF to IF isolation	RF = 4 GHz		40		dB
		RF = 5 GHz		40		
		RF = 6 GHz		40		
		RF = 7 GHz		40		
		RF = 8 GHz		40		
		RF = 9 GHz		40		
		RF = 10 GHz		40		
LEAK _{RFxIF}	LO to IF leakage	LO = 4 GHz		-35		dBm
		LO = 5 GHz		-35		
		LO = 6 GHz		-35		
		LO = 7 GHz		-35		
		LO = 8 GHz		-35		
		LO = 9 GHz		-35		
		LO = 10 GHz		-35		

Electrical Characteristics (continued)

Measurements are done at 25 degree C. Parameters are measured at IF = 65MHz with high side injection, unless otherwise noted. Measurements are done with external VCM = 1.7V.

PARAMETER		TEST CONDITIONS	MIN	TYP	MAX	UNIT
LEAK _{LOxRF}	LO to RF leakage (internal Lo mode)	LO = 4 GHz		-60		dBm
		LO = 5 GHz		-60		
		LO = 6 GHz		-52		
		LO = 7 GHz		-50		
		LO = 8 GHz		-50		
		LO = 9 GHz		-45		
		LO = 10 GHz		-40		
PERFORMANCE TUNING						
G _{IQ_CAL}	I/Q gain calibration range	IMRR_GCAL register full range		±0.5		dB
G _{IQ_STEP}	I/Q gain calibration step size			0.05		dB
PH _{IQ_CAL}	I/Q phase calibration range	IMRR_PCAL register full range		±20		Deg
PH _{IQ_STEP}	I/Q phase calibration step size	Step size can be made reduced to 0.25 deg in fine accuracy mode		0.45		Deg
V _{DCOC}	calibrated differential DC offset			+/- 2		mV
PORTS						
S _{11RF}	RF return loss	RF = 4 GHz		8		dB
		RF = 5 GHz		19		dB
		RF = 6 GHz		21		dB
		RF = 7 GHz		16		dB
		RF = 8 GHz		10		dB
		RF = 9 GHz		9		dB
		RF = 10 GHz		9		dB
S _{11LO}	LO return loss (differential measurement)	RF = 4 GHz		15		dB
		RF = 5 GHz		15		dB
		RF = 6 GHz		20		dB
		RF = 7 GHz		17		dB
		RF = 8 GHz		18		dB
		RF = 9 GHz		17		dB
		RF = 10 GHz		12		dB
P _{LO_IN}	External LO input power	8 GHz RF _{IN}		6		dBm
P _{LO_OUT}	External LO output power ⁽³⁾	<7 GHz RF _{out}		2		dBm
		<10 GHz RF _{out}		-1		dBm
V _{IF_RANGE}	IF output voltage swing (differential)			2		V _{PP}
V _{CM}	IF common mode voltage, internal or external source		1.2	1.7	2	V
P _{inRF}	RF input power				5	dBm
LO SYNTHESIZER INPUT SIGNAL PATH						
F _{OSCIN}	Reference oscillator port frequency range	OSC_2X = 0		5	1400	MHz
		OSC_2X = 1		5	200	
V _{OSCIN}	Reference input voltage	AC-coupled required ⁽⁴⁾		0.2	2	V _{pp}
F _{MULT}	Multiplier frequency (when multiplier enabled)	Input range		30	70	MHz
		Output range		180	250	

(3) Output power, spurs, and harmonics can vary based on board layout and components.

(4) For lower VCO frequencies, the N divider minimum value can limit the phase detector frequency.

Electrical Characteristics (continued)

Measurements are done at 25 degree C. Parameters are measured at IF = 65MHz with high side injection, unless otherwise noted. Measurements are done with external VCM = 1.7V.

PARAMETER	TEST CONDITIONS	MIN	TYP	MAX	UNIT
LO SYNTHESIZER PHASE DETECTOR AND CHARGE PUMP					
F _{PD}	Phase detector frequency	Integer Mode (FRAC_ORDER = 0)	0.125	400	MHz
		Fractional Mode (FRAC_ORDER = 1,2,3)	5	300	
		Fractional Mode (FRAC_ORDER = 4)	5	240	
I _{CPOUT}	Charge pump leakage current	CPG = 0	15		nA
	Effective charge pump current (sum of up and down currents)	CPG = 4	3		mA
		CPG = 1	6		
		CPG = 5	9		
		CPG = 3	12		
		CPG = 7	15		
PN _{1/F}	Normalized PLL flicker noise	F _{PD} = 100 MHz, F _{VCO} = 12 GHz ⁽⁵⁾		-129	dBc/Hz
PN _{FLAT}	Normalized PLL thermal noise floor			-236	dBc/Hz

- (5) The PLL noise contribution is measured using a clean reference and a wide loop bandwidth and is composed into flicker and flat components. $PLL_{FLAT} = PLL_{FOM} + 20\log(F_{VCO} / F_{PD}) + 10\log(F_{PD} / 1\text{Hz})$. $PLL_{FLICKER}(\text{offset}) = PLL_{FLICKER_NORM} + 20\log(F_{VCO} / 1\text{GHz}) - 10\log(\text{offset frequency} / 10\text{kHz})$. Once these two components are found, the total PLL noise can be calculated as $PLL_{NOISE} = 10\log(10^{PLL_{FLAT} / 10} + 10^{PLL_{FLICKER} / 10})$.

Electrical Characteristics (continued)

Measurements are done at 25 degree C. Parameters are measured at IF = 65MHz with high side injection, unless otherwise noted. Measurements are done with external VCM = 1.7V.

PARAMETER		TEST CONDITIONS	MIN	TYP	MAX	UNIT
LO SYNTHESIZER VCO						
PN _{vco}	Open loop VCO phase noise	8 GHz VCO, 10 kHz offset		-80		dBc/Hz
		8 GHz VCO, 100 kHz offset		-107		
		8 GHz VCO, 1 MHz offset		-128		
		8 GHz VCO, 10 MHz offset		-148		
		8 GHz VCO, 90 MHz offset		-157		
		9.2 GHz VCO, 10 kHz offset		-79		
		9.2 GHz VCO, 100 kHz offset		-105		
		9.2 GHz VCO, 1 MHz offset		-127		
		9.2 GHz VCO, 10 MHz offset		-147		
		9.2 GHz VCO, 90 MHz offset		-157		
		10.3 GHz VCO, 10 kHz offset		-77		
		10.3 GHz VCO, 100 kHz offset		-104		
		10.3 GHz VCO, 1 MHz offset		-126		
		10.3 GHz VCO, 10 MHz offset		-147		
		10.3 GHz VCO, 90 MHz offset		-157		
		11.3 GHz VCO, 10 kHz offset		-76		
		11.3 GHz VCO, 100 kHz offset		-103		
		11.3 GHz VCO, 1 MHz offset		-125		
		11.3 GHz VCO, 10 MHz offset		-145		
		11.3 GHz VCO, 90 MHz offset		-158		
		12.5 GHz VCO, 10 kHz offset		-74		
		12.5 GHz VCO, 100 kHz offset		-100		
		12.5 GHz VCO, 1 MHz offset		-123		
		12.5 GHz VCO, 10 MHz offset		-144		
		12.5 GHz VCO, 90 MHz offset		-157		
		13.3 GHz VCO, 10 kHz offset		-73		
		13.3 GHz VCO, 100 kHz offset		-100		
		13.3 GHz VCO, 1 MHz offset		-122		
		13.3 GHz VCO, 10 MHz offset		-143		
		13.3 GHz VCO, 90 MHz offset		-155		
14.5 GHz VCO, 10 kHz offset		-73				
14.5 GHz VCO, 100 kHz offset		-99				
14.5 GHz VCO, 1 MHz offset		-121				
14.5 GHz VCO, 10 MHz offset		-143				
14.5 GHz VCO, 90 MHz offset		-152				
t _{VCO_CAL}	VCO calibration speed, switch across the entire frequency band, F _{OSC} = 200 MHz, F _{PD} = 100 MHz ⁽⁶⁾	No assist		50		μs
		Close frequency		20		

(6) See Application and Implementation for more details on the different VCO calibration modes.

Electrical Characteristics (continued)

Measurements are done at 25 degree C. Parameters are measured at IF = 65MHz with high side injection, unless otherwise noted. Measurements are done with external VCM = 1.7V.

PARAMETER		TEST CONDITIONS	MIN	TYP	MAX	UNIT
K _{VCO}	VCO gain	8 GHz		89		MHz/V
		9.2 GHz		93		
		10.3 GHz		110		
		11.3 GHz		124		
		12.5 GHz		189		
		13.3 GHz		182		
		14.5 GHz		205		
ΔT _{CL}	Allowable temperature drift when VCO is not re-calibrated			125		°C
H2	VCO second harmonic	FVCO = 8 GHz, divider disabled		-30		dBc
H3	VCO third harmonic	FVCO = 8 GHz, divider disabled		-40		
SYNC PIN AND PHASE ALIGNMENT						
F _{OSCIN_SYNC}	Maximum usable OSCIN frequency with SYNC pin	Category 3 (int LO mode)	0		100	MHz
		Category 1 or 2	0		1400	
DIGITAL INTERFACE (SCK, SDI, CSB, MUXOUT, SYNC, CE)						
V _{IH}	High level input voltage		1.4		VCC	V
V _{IL}	Low level input voltage		0		0.4	V
I _{IH}	High level input current		-50		50	μA
I _{IL}	Low level input current		-50		50	μA
V _{OH}	High level output voltage	I _L = -5 mA		VCC - 0.55		V
V _{OL}	High level output current	I _L = 5 mA			0.55	V

6.6 Timing Requirements

		MIN	NOM	MAX	UNIT
SYNC					
t _{SETUP}	Setup time for pin relative to OSCIN rising edge	2.5			ns
t _{HOLD}	Hold time for pin relative to OSCIN rising edge	2			ns
DIGITAL WRITE INTERFACE⁽¹⁾					
F _{SPI_WRITE}	SPI write speed			50	MHz
t _{ES}	Clock to enable low time	5			ns
t _{CS}	Data to clock setup time	2			ns
t _{CH}	Data to clock hold time	2			ns
t _{CWH}	Clock pulse width high	5			ns
t _{CWL}	Clock pulse width low	10			ns
t _{CES}	Enable to clock setup time	10			ns
t _{EWL}	Enable pulse width high	10			ns
DIGITAL READBACK INTERFACE⁽²⁾					
F _{SPI_READ}	SPI readback speed			50	MHz
t _{ES}	Clock to enable low time	10			ns
t _{CS}	Clock to data wait time			10	ns
t _{CWH}	Clock pulse width high	10			ns
t _{CWL}	Clock pulse width low	10			ns
t _{CES}	Enable to clock setup time	10			ns

(1) See Figure 1

(2) See Figure 2

Timing Requirements (continued)

		MIN	NOM	MAX	UNIT
t_{EWH}	Enable pulse width high	10			ns



图 1. Serial Data Input Timing Diagram

There are several other considerations for writing on the SPI:

- The R/W bit must be set to 0.
- The signal on the SDI pin is clocked into a shift register on each rising edge of the SCK pin.
- The CSB must be held low for data to be clocked. Device ignores clock pulses if CSB is held high.
- The CSB transition from high to low must occur when SCK is low.
- When SCK and SDI lines are shared between devices, TI recommends holding the CSB line high on any devices besides the intended programming target.

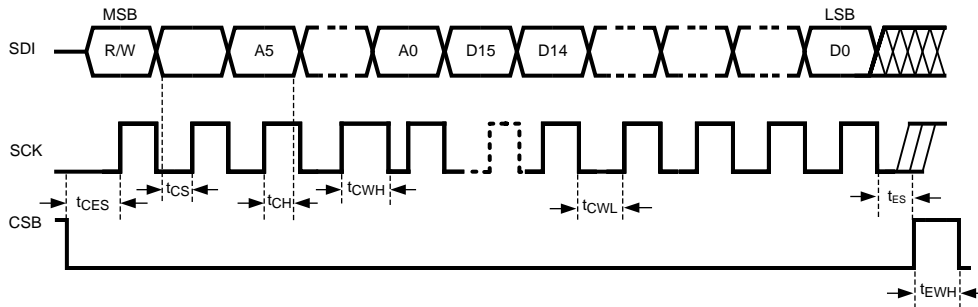

图 2. Serial Data Readback Timing Diagram

There are several other considerations for SPI readback:

- The R/W bit must be set to 1.
- The MUXOUT pin is always for the address portion of the transaction.
- The address on the SDI pin is clocked into a shift register on each rising edge of the SCK pin.
- The data portion of the transaction on the SDI line is always ignored.
- The data on the MUXOUT pin should be considered valid on each rising edge of the SCK pin, provided all timing requirements are met.
- All CSB considerations for SPI writing also apply to SPI readback.

6.7 Typical Characteristics

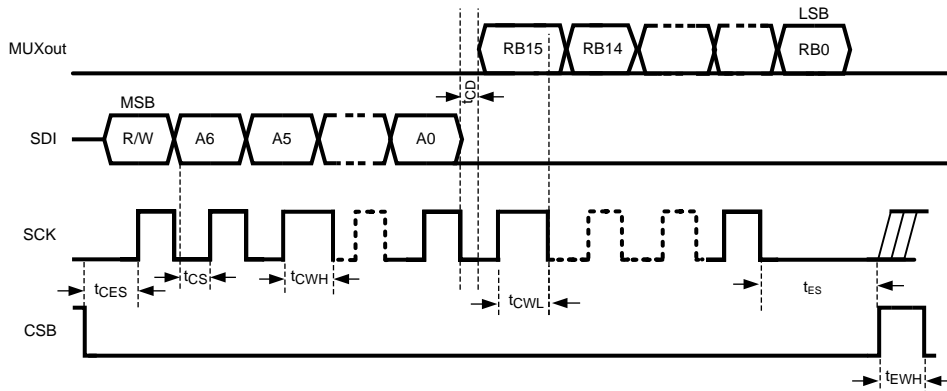

图 3. Voltage Gain Across LO Frequency for Internal LO Mode



图 4. Voltage Gain Across LO frequency for External LO Mode

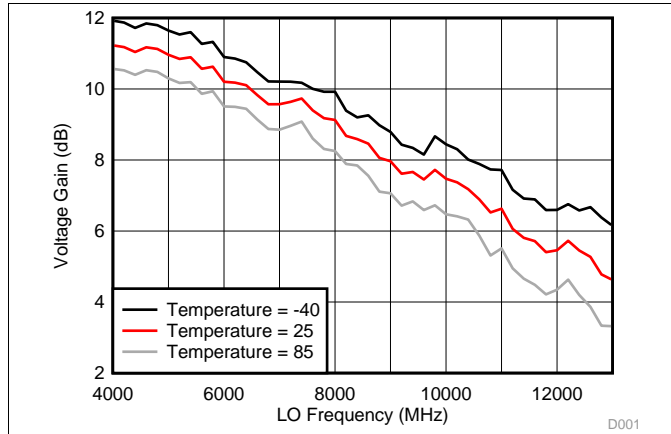

图 5. Voltage Gain Across IF Frequency for Internal LO Mode

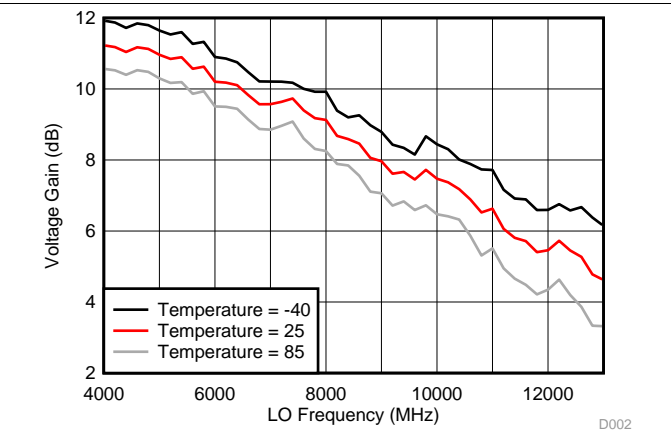

图 6. Voltage Gain Across IF Frequency for External LO Mode

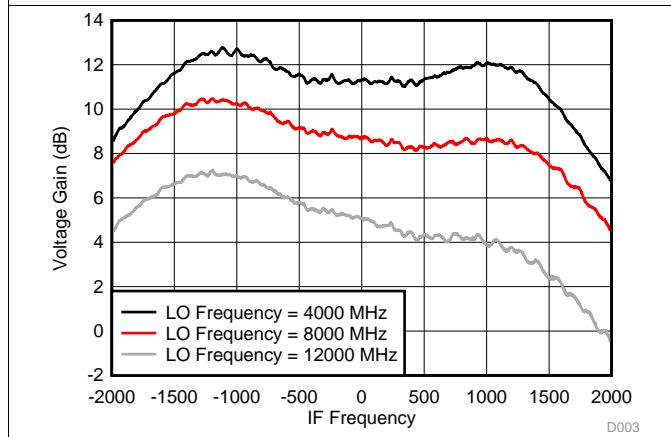

图 7. IIP3 Across LO Frequency for Internal LO Mode

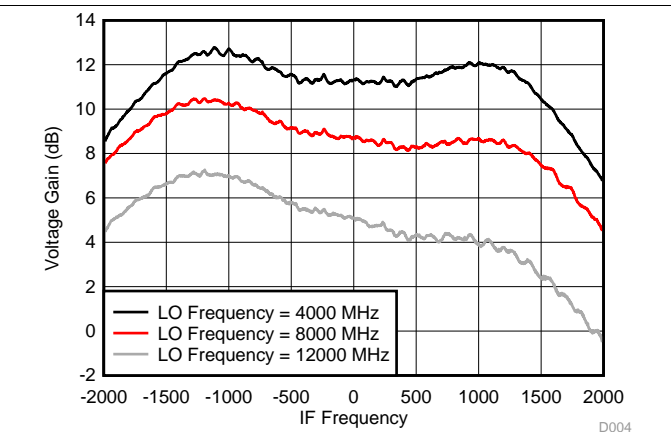

图 8. IIP3 Across LO Frequency for External LO Mode

Typical Characteristics (接下页)

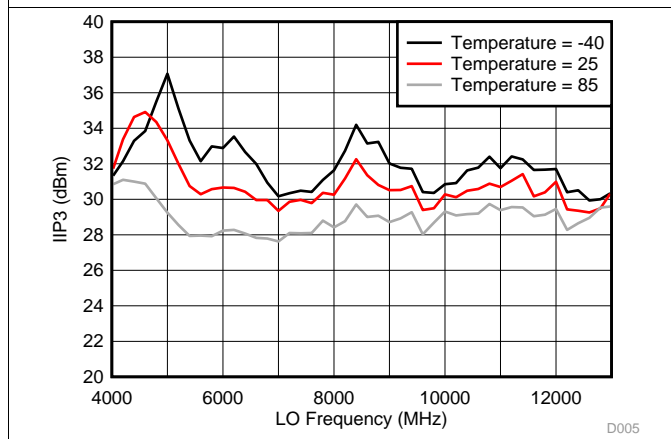

图 9. IIP3 Across IF Frequency for Internal LO Mode

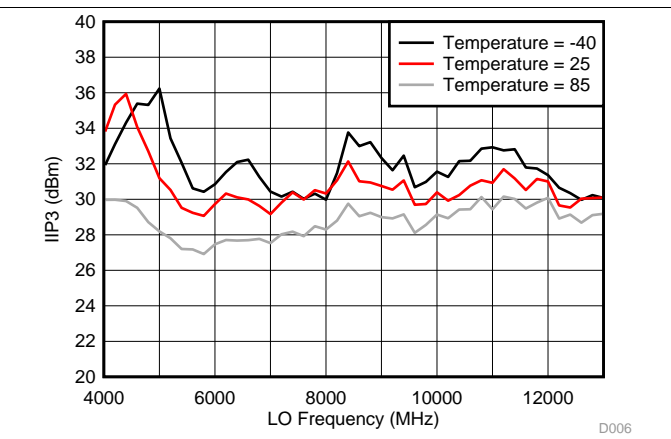

图 10. IIP3 Across IF Frequency for External LO Mode

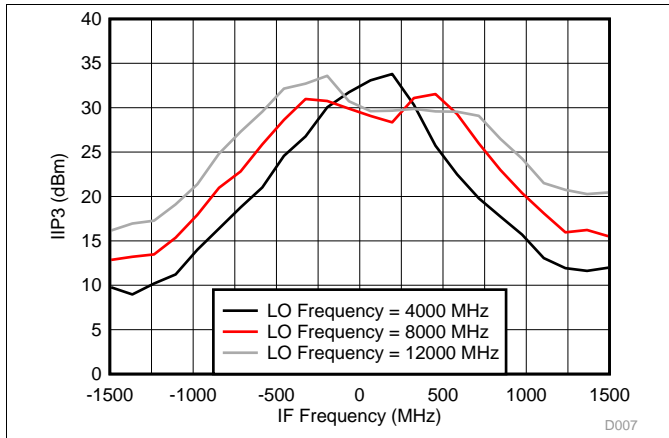

图 11. IIP2: F1-F2 Across LO Frequency for Internal LO Mode

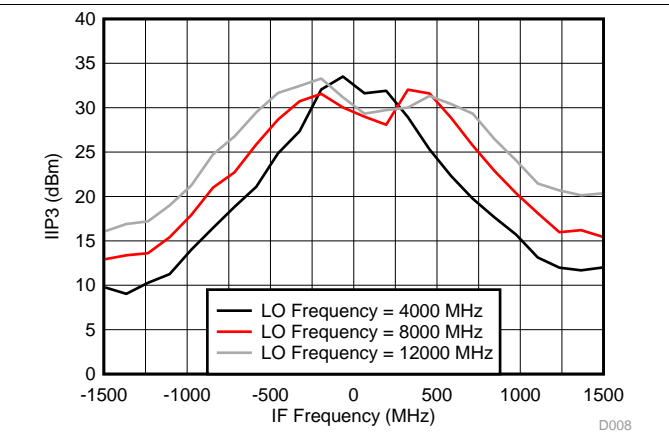

图 12. IIP2: F1-F2 Across LO Frequency for External LO Mode

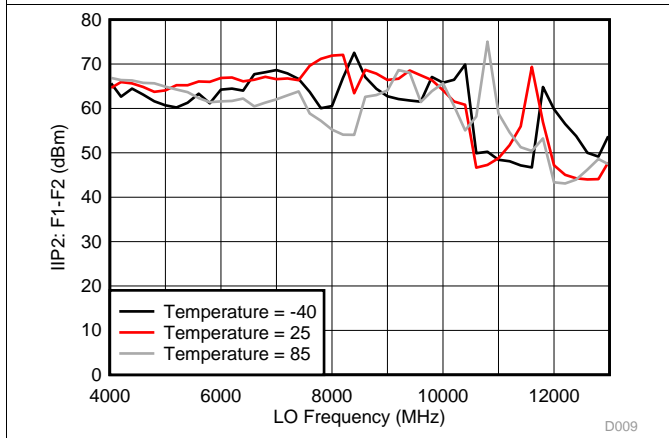

图 13. IIP2: F1-F2 Across IF Frequency for Internal LO Mode

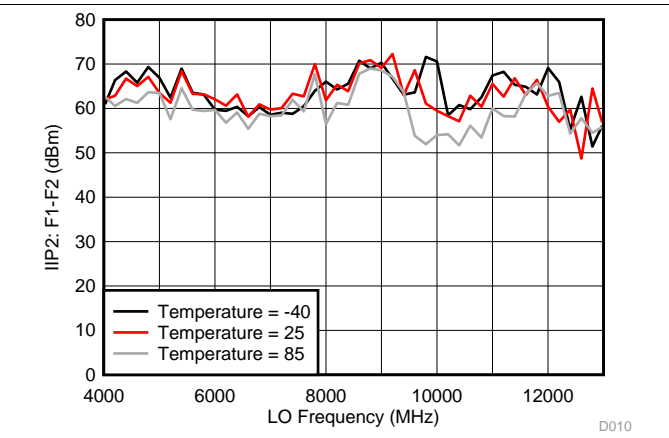

图 14. IIP2: F1-F2 Across IF Frequency for External LO Mode

Typical Characteristics (接下页)

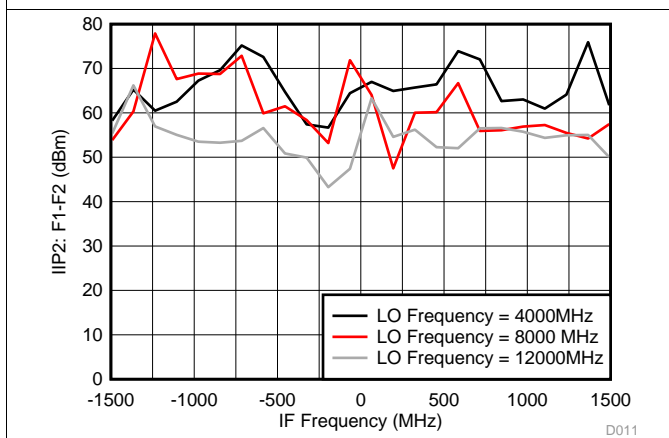

Typical Characteristics (接下页)

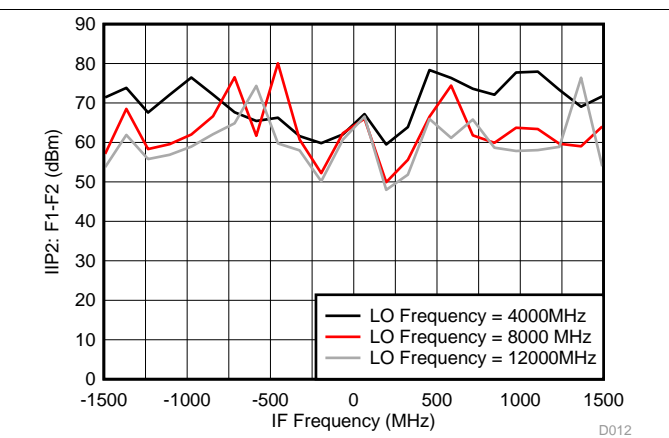
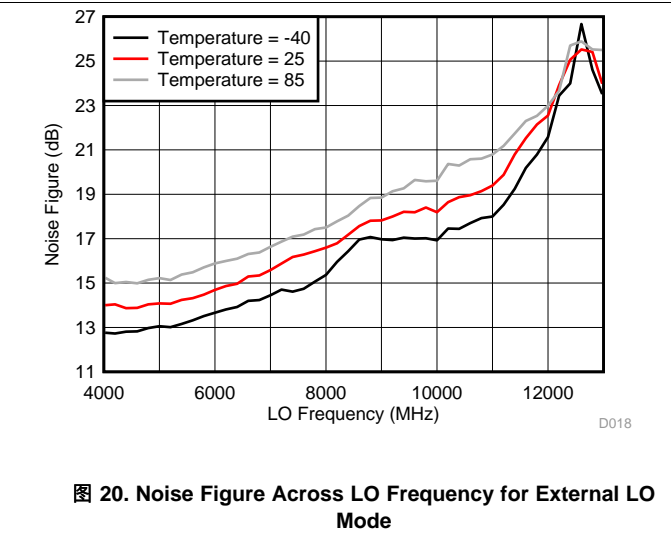
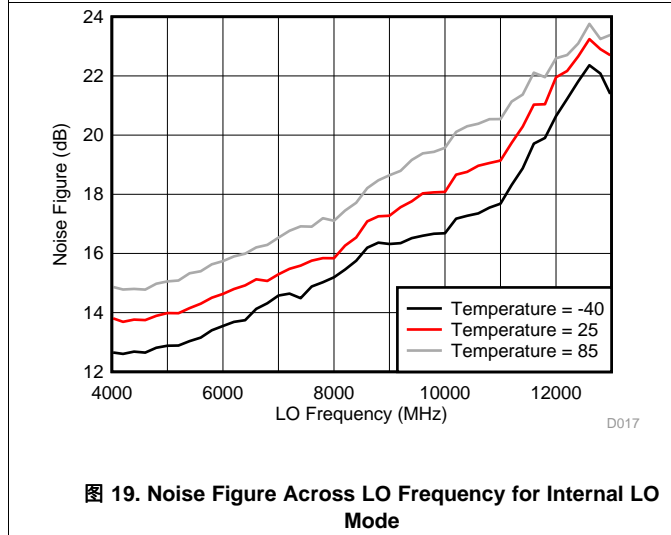
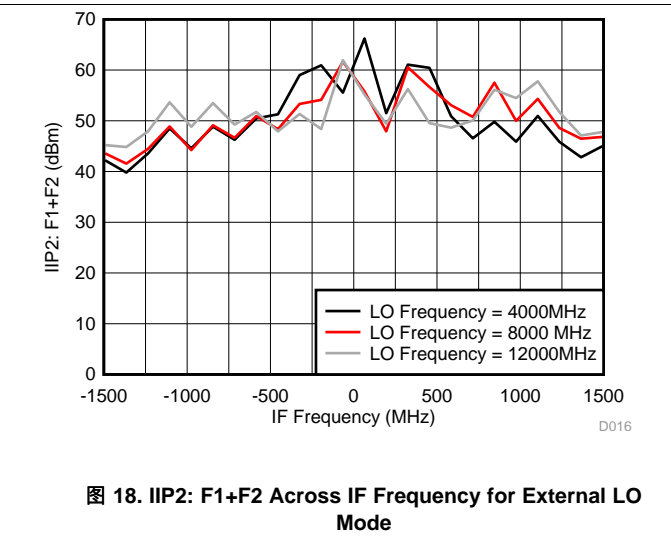
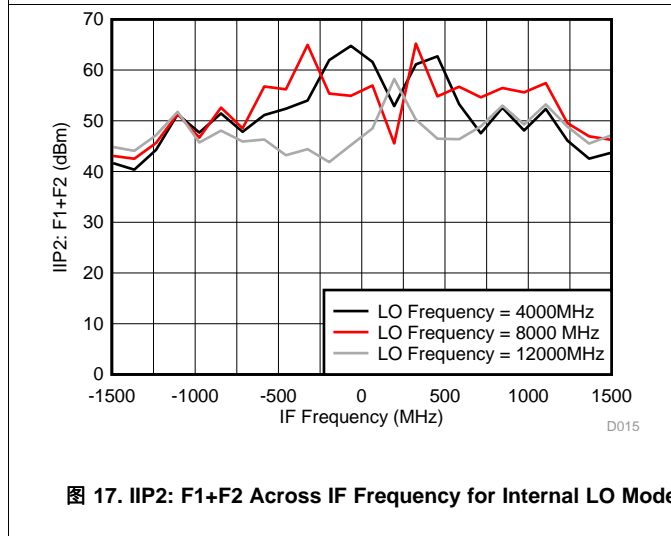
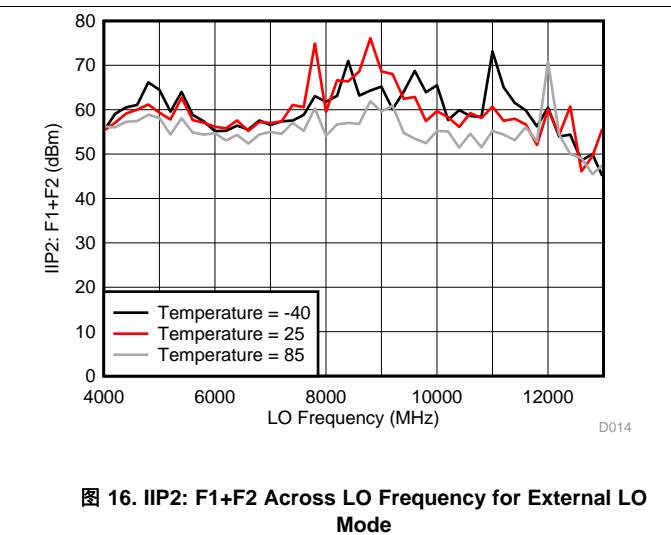
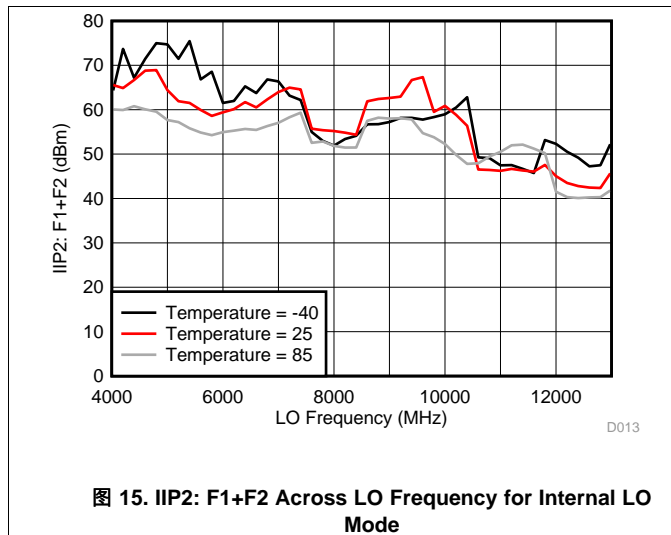
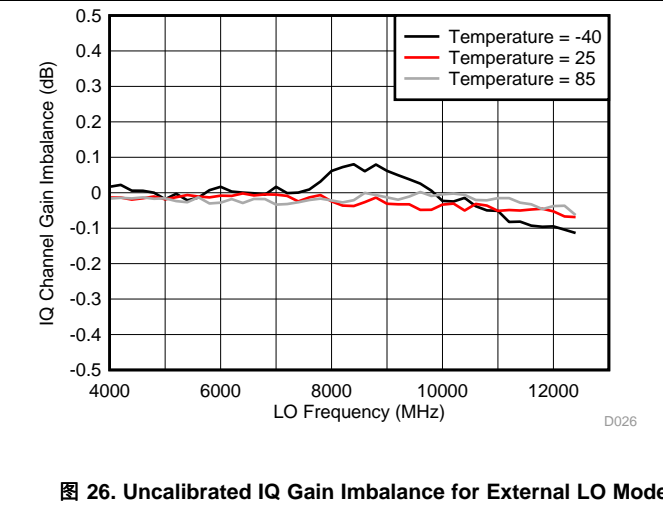
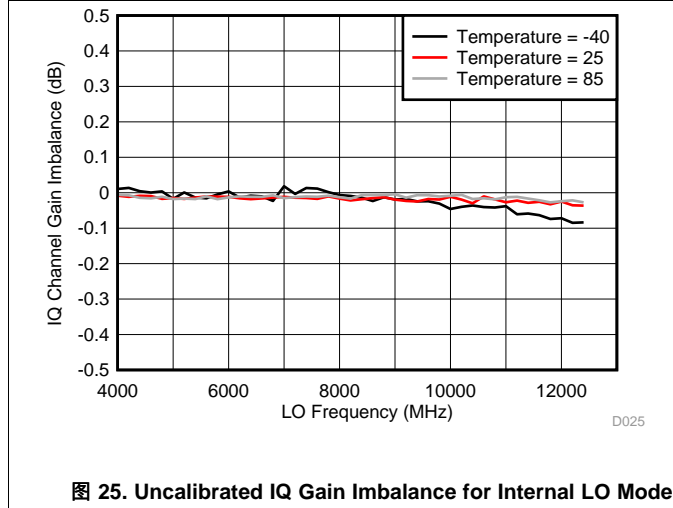
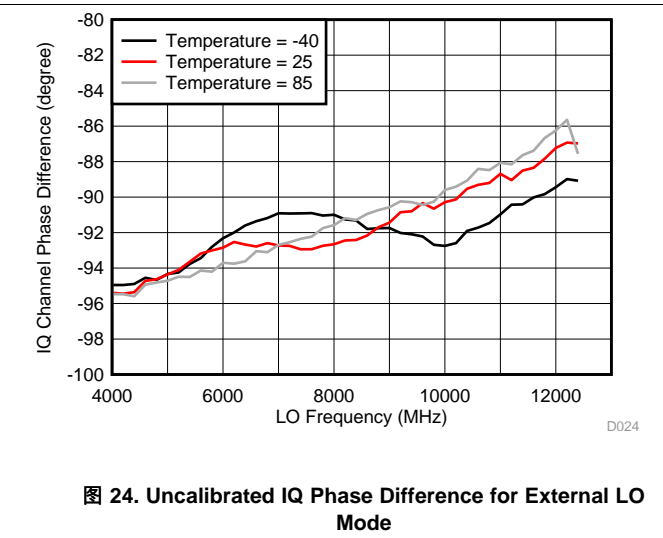
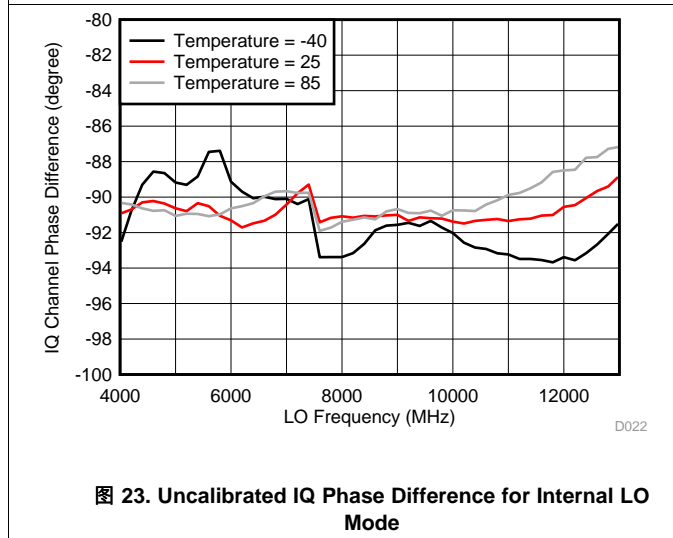
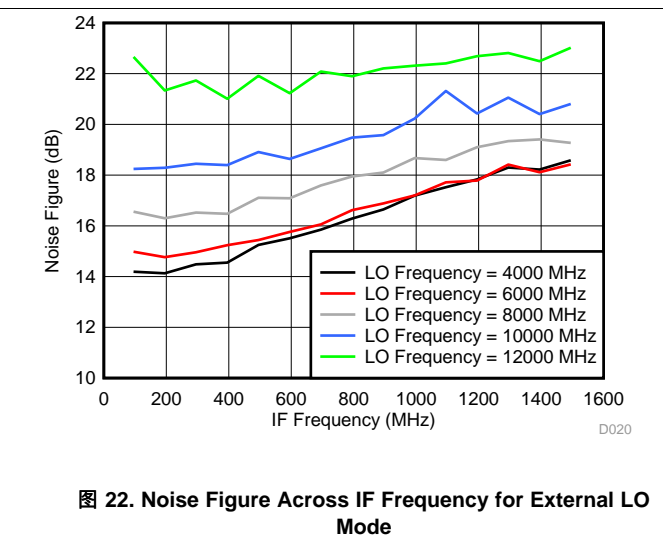
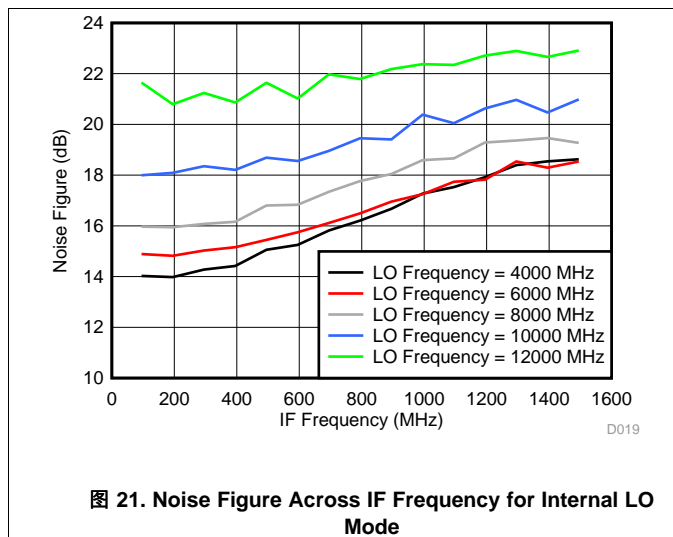

Typical Characteristics (接下页)

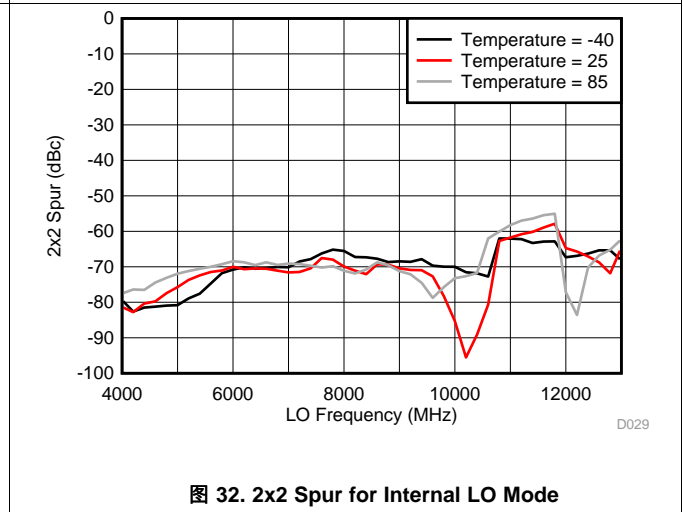
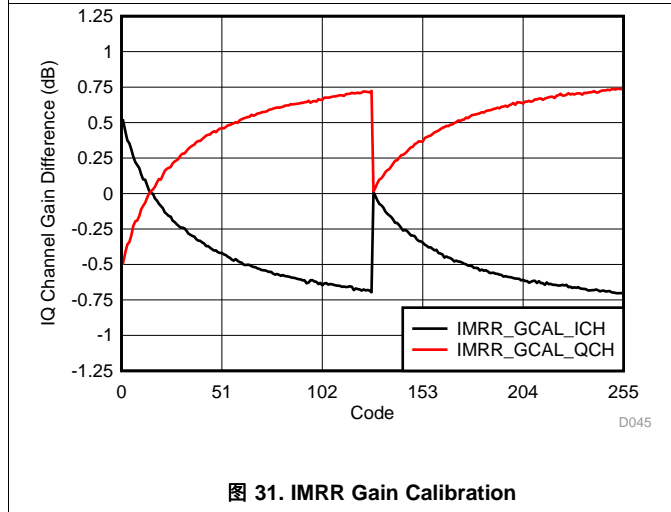
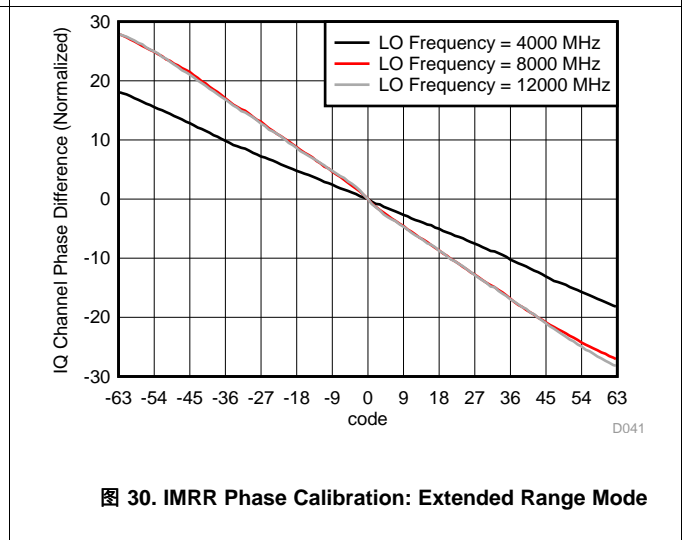
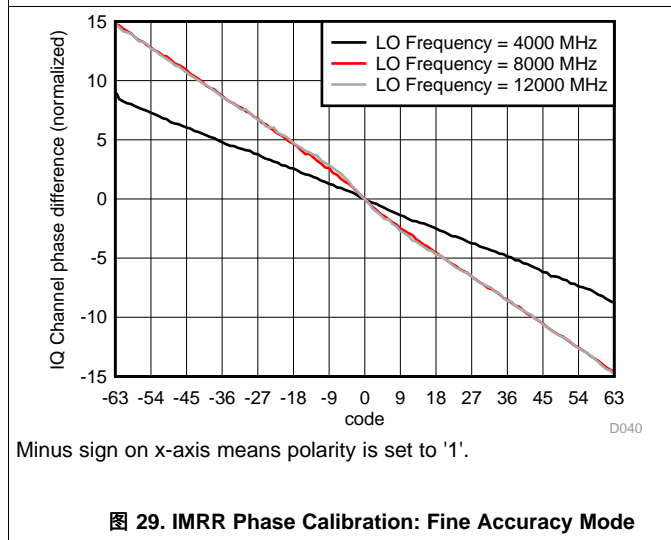
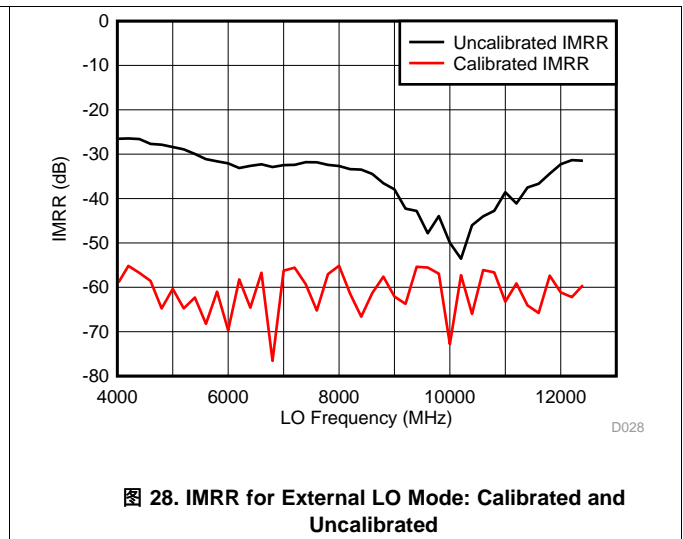
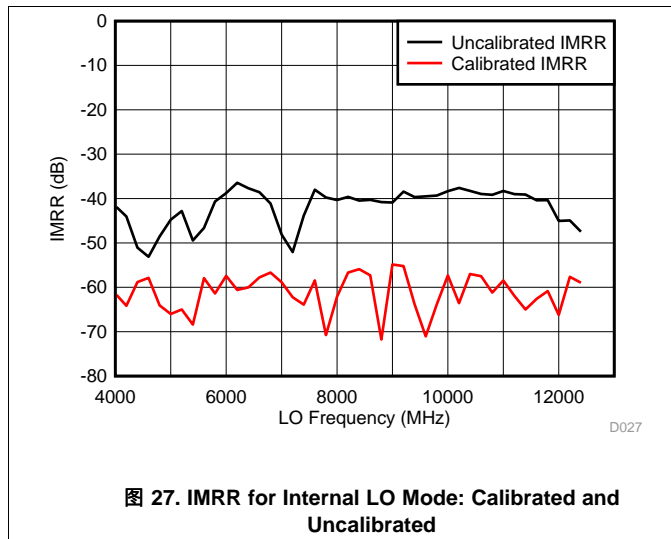

Typical Characteristics (接下页)



图 33. 2x2 Spur for External LO Mode



图 34. 3x3 Spur for Internal LO Mode

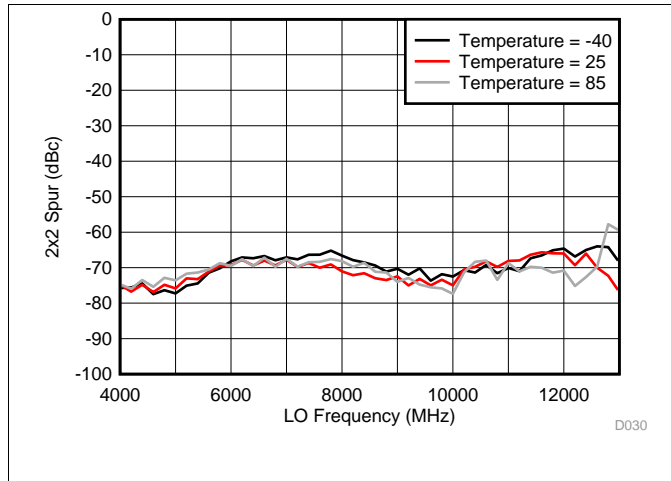

图 35. 3x3 Spur for External LO Mode

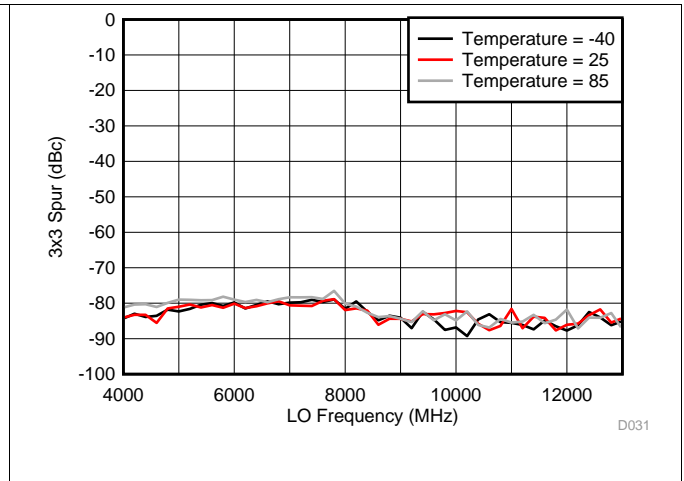

图 36. RF to IF Isolation

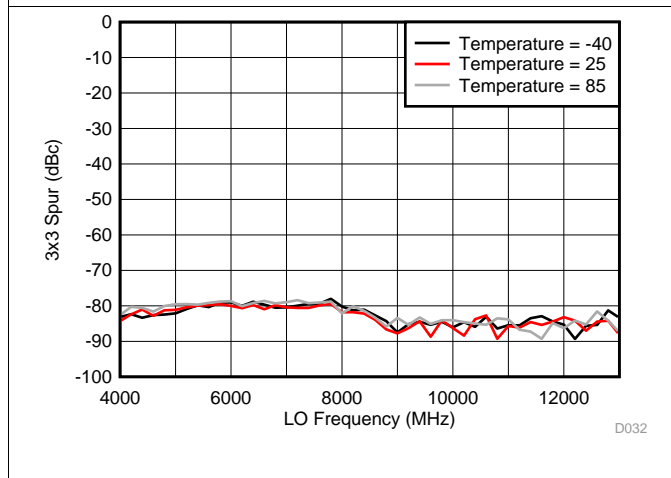

图 37. LO to IF Leakage Level

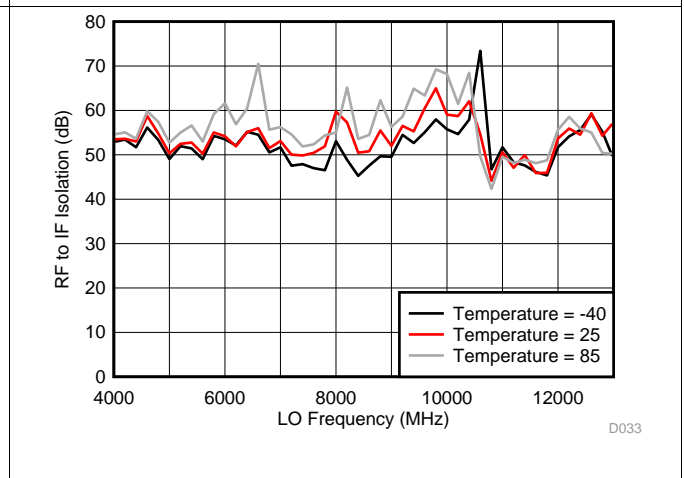

图 38. LO to RF Leakage Level: Internal LO Mode

Typical Characteristics (接下页)

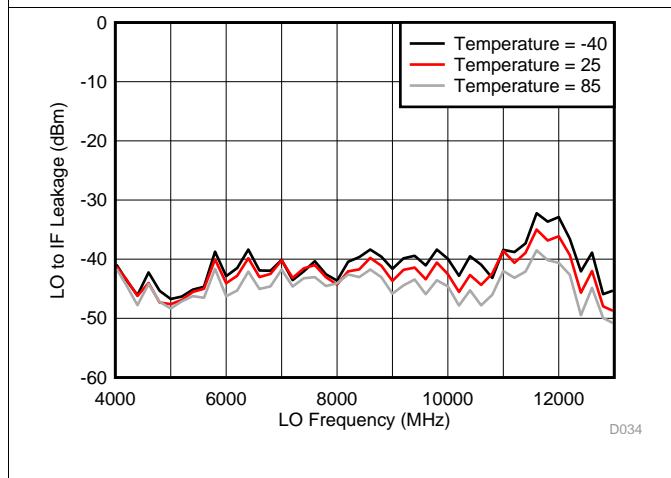

图 39. LO to RF Leakage Level: External LO Mode

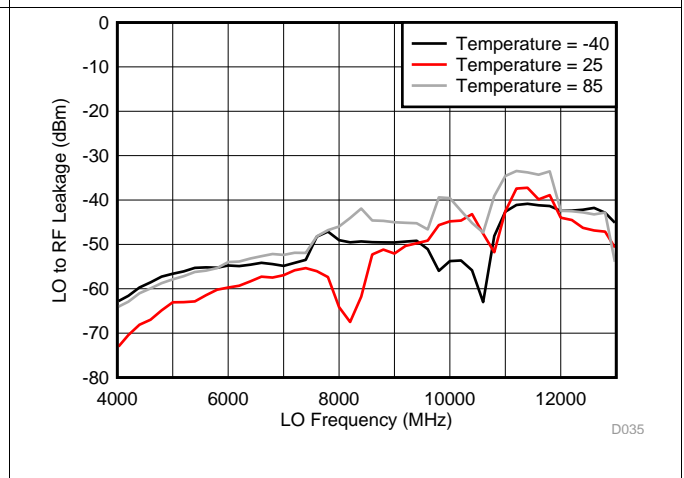

图 40. OP1dB Across LO Frequency

1. The LO frequency is capped at 6600MHz because IP1dB exceeds +10dBm when LO frequency goes beyond 6600MHz; The device can be damaged when input power is more than +10dBm.

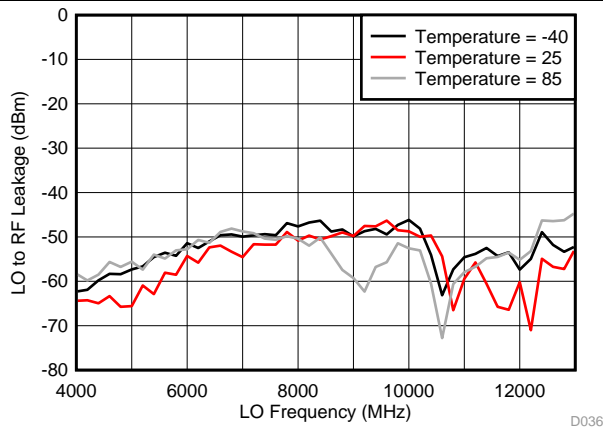

图 41. Noise Figure with Jammer

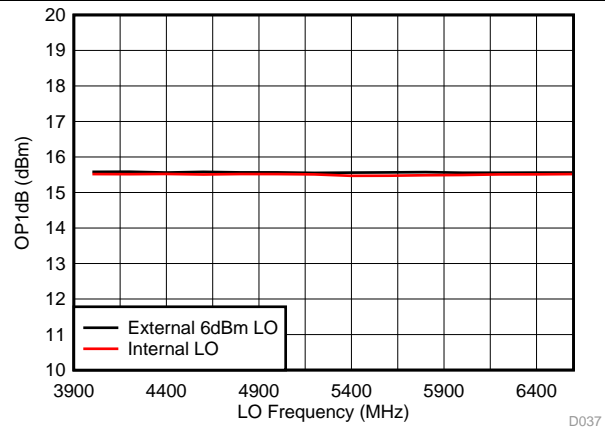
1. Jammer frequency = 8.8GHz, LO = 7.8GHz, IF = 100MHz.
2. Internal LO phase noise values used for calculation at -40, 25, and 85 degrees C are -155, -154.5 and -154 dBc/Hz, separately.

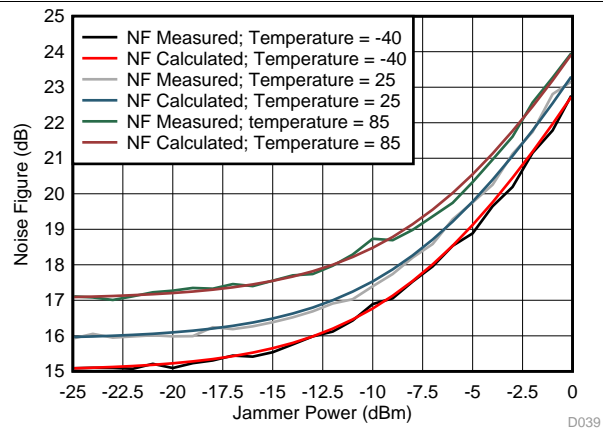

图 42. RF Port S11

Typical Characteristics (接下页)

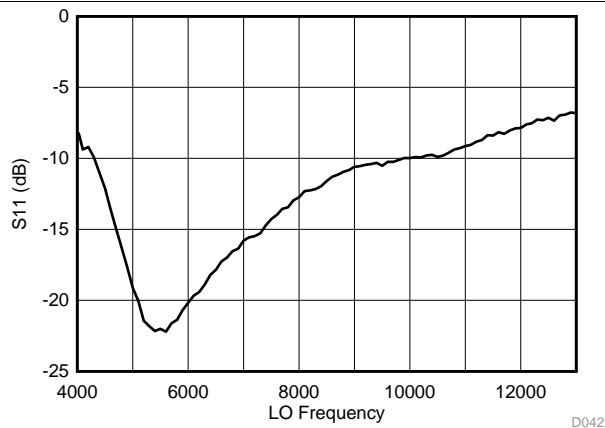
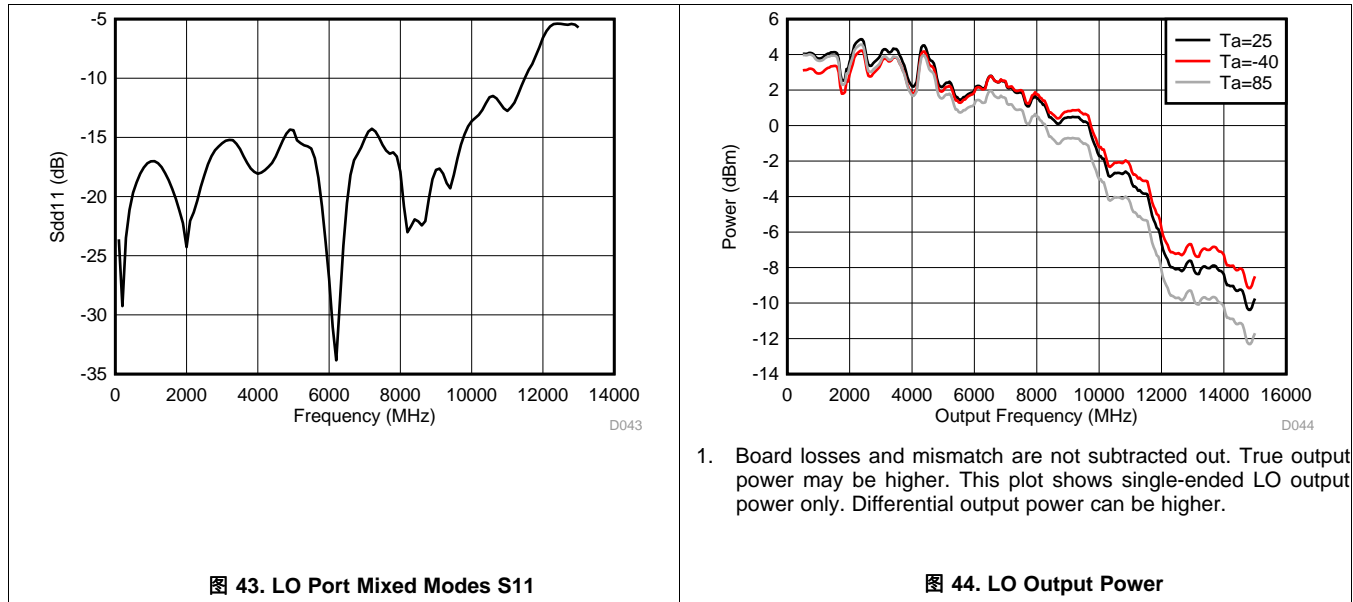

1. Board losses and mismatch are not subtracted out. True output power may be higher. This plot shows single-ended LO output power only. Differential output power can be higher.

Measurements are done at 25 degree C unless temperature is specified in the plots.
 For measurements across LO frequency, IF = 65MHz, and LO injection type is high side injection. For measurements across IF frequency, high side injection is applied
 For all measurements that require RF input, RF input power = -10 dBm unless otherwise specified.
 For two-tone measurements, the separation between two tones is 17MHz.
 For all measurements, internal 1.7V VCM is applied.
 For all external LO mode measurements, LO power = +6 dBm.
 IF baluns used for measurements are: ADT2-18+ from Mini-Circuits™.
 LO balun used for measurements is: BIB-100G from PPM-Test™.
 RF combiner used for measurements of IP2, IP3 and NF with jammer is: 4426-2 from Narda-MITEQ™.
 All path losses are calibrated out.

LMX8410L

ZHCSHV3A – MARCH 2018 – REVISED NOVEMBER 2018

www.ti.com.cn

7 Detailed Description

7.1 Overview

The LMX8410L is a high-performance I/Q demodulator with an RF input range of 4 to 10 GHz and an IF output range of DC to 1350 MHz. This device integrates many components to allow high system performance as well as simplified design. There is an integrated synthesizer that generates wide-band frequencies at very low phase noise, with signal carefully conditioned for driving the mixer LO port. The RF input is single ended, enabled by an integrated wide-band RF balun at the front end. The two mixers on each I/Q channel are highly linear with optimized filtering and interfacing with components on each port. The IF amplifier is a high gain and high linearity component, saving users from matching discrete amplifiers and being restricted by common mode voltages typically encountered when interfacing mixers and ADC's. In addition to high linearity and low noise performance, the LMX8410L comes equipped with many features to further optimize certain parameters. The automatic DC offset calibration is run by an internal automatic algorithm which will sense and tune the DC offset between the N and P sides of the differential signal of each IF amplifier, thus ensuring optimal performance when directly DC coupled to the ADC. The I/Q calibration knob allows tuning blocks within the mixer and IF amplifier to balance both the gain and the phase of the I/Q output signals, thus giving the user capability to adjust and achieve high image rejection. The internal synthesizer also has a feature of synchronization, which allows multiple LMX8410L designed in parallel to have synchronized LO signal phase.

7.2 Functional Block Diagram

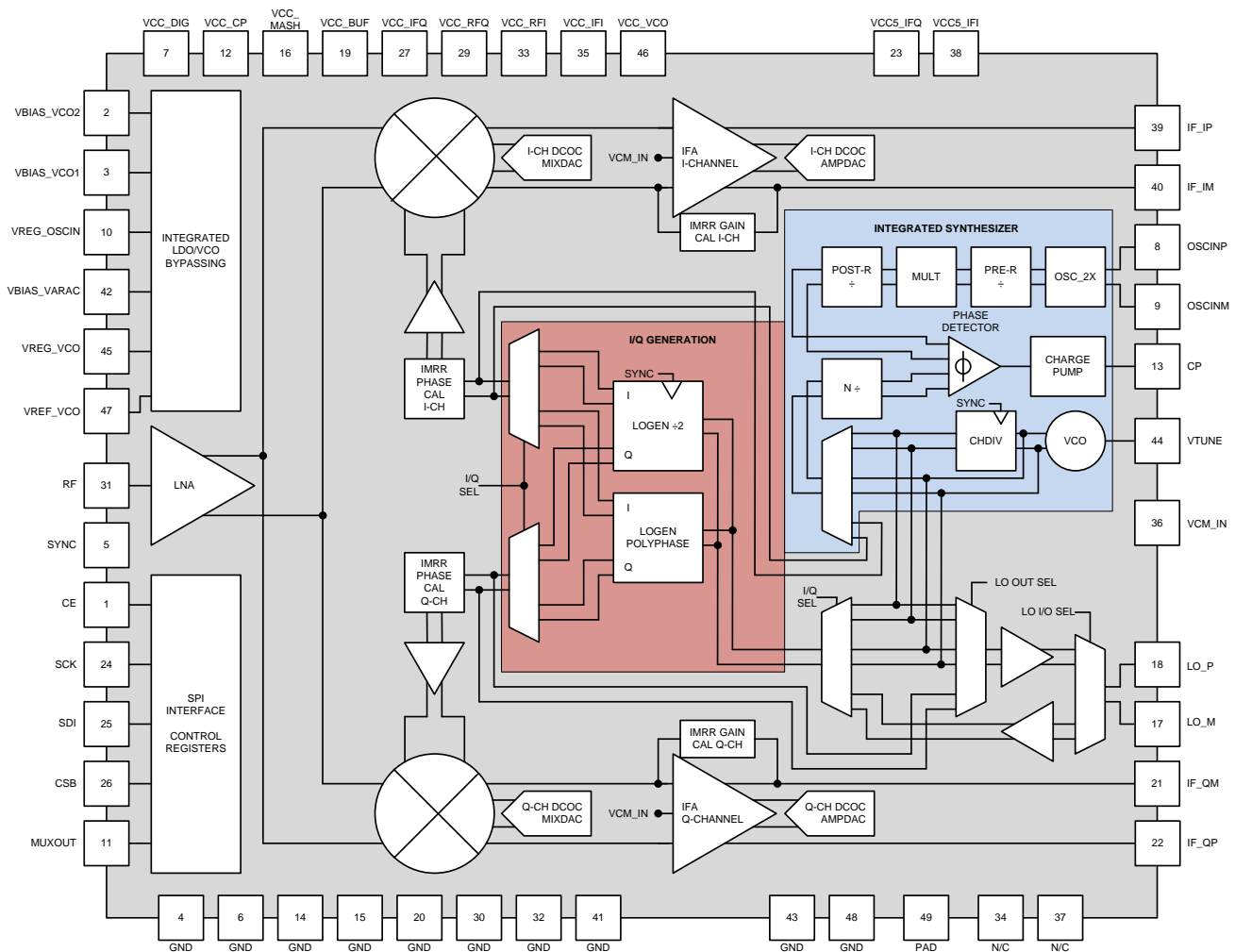

7.3 Feature Description

7.3.1 Device Configurations and Feature Description

7.3.1.1 RF, LO and IF Interfaces

7.3.1.1.1 RF Interface

LMX8410 RF input stage provides a wideband input matching in complete RF frequency range. The RF interface requires an external DC block capacitor.



图 45. RF Interface

7.3.1.1.2 LO Interface

LO interface for LMX8410 serves dual functionality:

1. Drive the VCO or channel divider output to pin LO_M and LO_P.
2. Inject external LO signal in external LO mode where on-chip synthesizer needs to be bypassed.

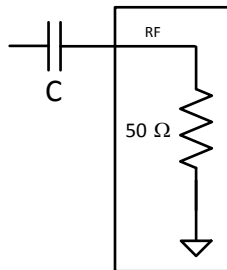
7.3.1.1.2.1 LO Interface as Output Port

When LO interface operates as output port, it drives either VCO or Channel Divider output to the port. The device provides open collector output. Therefore, a pair of off-chip load resistors or inductors are needed in order to have LO output power.



图 46. LO Port Operating In Output Mode Requires Load Resistors Or Inductors

7.3.1.1.2.2 LO Interface as Input Port

When LO interface operates as input port, the pull-up resistors or inductors must be removed. Device pins must be AC coupled with DC block. LO pins offer wideband differential 100 Ohm termination to enable port matching. The value of termination can be set to 100Ohm, 200Ohm or high impedance through register EXTLO_INT_MATCH_RES (R123<1:0>). It is recommended to keep the termination setting to 100 ohm during external LO injection and to high impedance mode while LO is brought out from the device.

Feature Description (接下页)

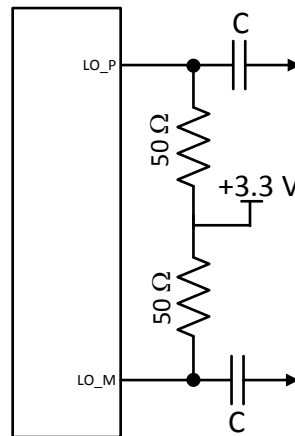
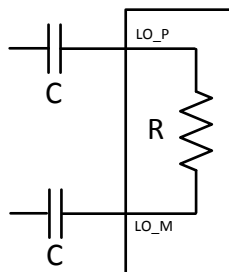
图 47. LO Port Operating In Input Mode
7.3.1.1.3 Baseband Interface

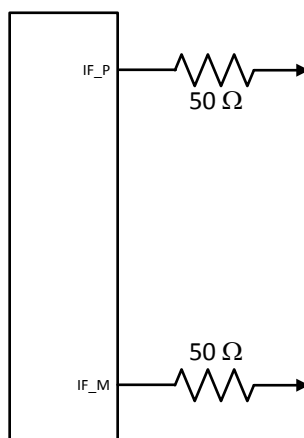
LMX8410 has a low impedance output driver capable of driving the resistive as well as capacitive loads. Therefore, a pair of 50 ohm off-chip resistors can be placed in both IF_P and IF_M paths to provide 100Ohm differential matching if IF port matching is required.

图 48. IF Interface Requires External Resistors for 100Ohm Differential Matching
7.3.1.2 Device Configurations Overview

Follow below steps to configure the device successfully.

7.3.1.2.1 Initialize the Device

After the device is powered on, follow below setups in sequence.

1. Set R127 = 0x0003
2. Set R6 = 0x0100
3. Set R127 = 0x0000
4. Load device configuration bits.

7.3.1.2.2 Configure LO Modes

Refer to [表 5](#) to set up correct LO modes. After LO mode is configured, In case of internal LO mode, lock the integrated synthesizer and jump to [Perform DCOC \(DC Offset Correction\)](#). In case of external LO mode, go to [Set Up External LO Clock](#).

Feature Description (接下页)

7.3.1.2.3 Set Up External LO Clock

Follow below steps to set up external LO clock:

1. Set external LO divider. Refer to [State Machine Clock](#)
2. Provide external LO signal on the pin.
3. Enable the divider by setting EXTLO_CLK_DIV_EN (R81<7:6>) to 3. This step should be done only after valid external LO signal is driven on the pin.
4. Select SM clock source towards external LO driven SM clock by setting SM_CLK_SEL (R81<0>) = 1.
5. Wait for 100 usec before performing DCOC.

7.3.1.2.4 Perform DCOC (DC Offset Correction)

Perform DCOC for both I and Q channels. Refer to [DCOC \(DC Offset Correction\)](#) for detailed instructions.

7.3.1.2.5 Turn Off SM Clock

Turn off SM clock after DCOC to remove coupling spurs from clock signals.

1. In internal LO mode, set SM_CLK_EN (R2<10>) to 0.
2. In external LO mode, set EXTLO_CLK_DIV_EN (R81<7:6>) to 0.

7.3.1.2.6 Perform IMRR (Image Rejection Ratio) Calibration

Refer to [Image Rejection Calibration](#) for detailed instructions.

7.3.1.3 State Machine Clock

The State machine clock can be derived, through a MUX, from division of OSCin frequency in internal LO mode or from division of external LO frequency in external LO mode. The upper bound for State machine clock is 200MHz while lower bound is 1MHz/10MHZ in internal/external LO modes. In external LO mode, two sets of dividers need to be programmed to set the right SM clock frequency. DIV_A is an 8-state divider which drives DIV_B. Input frequency to DIV_B must be kept less than 1.4GHz. Recommended SM_CLK frequency is 100MHz.



图 49. Block Diagram of SM Clock

7.3.1.3.1 Set Divider Values For Internal LO Mode

The value of divider in internal LO mode is $2^{(value\ of\ CAL_CLK_DIV)}$.

Feature Description (接下页)

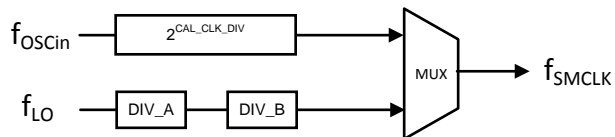
7.3.1.3.2 Set Divider Values For External LO Mode

The divider for external LO mode is EXTLO_DIV (R82<5:0>), where R82<5:3> sets DIV_A and R82<2:0> sets DIV_B. The value of DIV_A should be set according to 表 1. The value of DIV_B is 2^(value of R82<2:0>).

表 1. DIV_A Encoding

EXTLO_DIV (R82<5:3>)	Division Value
000	/1
001	/2
010	/16
011	/4
100	/16
101	/16
110	/16
111	/8

7.3.1.4 DCOC (DC Offset Correction)

The DC offset of IF output can be automatically corrected by checking EN_DCOC_ICH_LUT and EN_DCOC_QCH_LUT



图 50. DC Offset Correction Diagram

7.3.1.4.1 RF Input Power Restriction During DCOC

For best accuracy, power at the RF input of the LMX8410 should be kept below -50dBm during DCOC calibration. Additional isolation (~15dB) can be obtained by turning of LNA_PD and LNA_BIAS_OFF.

7.3.1.4.2 Set Up DCOC Clock Divider

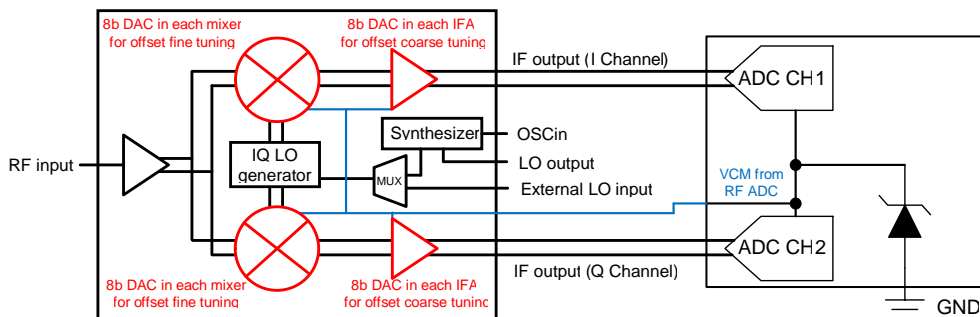
DCOC state machine clock can operate from 0.5MHz to 2MHz, preferably set to 1MHz. Calculation of clock frequency: DCOC clock Frequency = (SM_CLK frequency)/(2*DCOC_CLK_DIV value). Refer to [State Machine Clock](#) for SM_CLK setup. It is recommended to set and reset DCOC_FSM_RESET (R126<8>) every time the LO frequency is changed.

7.3.1.5 Image Rejection Calibration

LMX8410 provides registers to vary the gain and phase of the I and Q channel individually to improve image rejection.



图 51. Image Reject Calibration Example

7.3.1.5.1 Phase Calibration

Phase magnitude can be tuned using IMRR_PHCAL (R95<14:9>), polarity of phase calibration can be set by IMRR_PHCAL_POL (R95<15>). If Q channel leads I by > 90 deg. Set polarity to '0', otherwise set it to '1'. Typical step size of magnitude tuning is 0.2 deg for fine accuracy mode and 0.45 deg for extended range mode. The fine accuracy mode and extended range mode can be set by IMRR_PHCAL_EXTEND (R126<15>). Refer to 图 29 and 图 30 for details of the two modes.

7.3.1.5.2 Gain Calibration

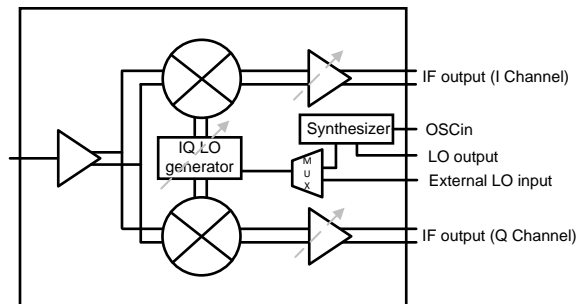
The voltage magnitude of I and Q channel can be tuned by IMRR_GCAL_ICH (R94<7:0>) and IMRR_GCAL_QCH (R94<15:8>). The recommended code range is 128 to 255. In this code range, gain tuning range is 0.5dB. Extended code range is 0 to 127. In this range, step size is higher and gain tuning range is 1dB. Refer to 图 31 for details of the two code ranges. Re-calibration may be needed with temperature drift.

7.3.1.6 IF Amplifier Common Mode Configurations

IF amplifier common mode voltage can be set by VCM_CONFIG (R83<12:9>). Additional setups are needed depending on VCM magnitude. Refer to 表 2 for more details. For best common mode voltage accuracy, supply external VCM and choose "External" in VCM_CONFIG.

表 2. IF Amplifier Common Mode Configurations

IFA common mode(V)	IFA_PULLUP_EN (R79<6>)	IFA_PULLUP (R83<15:13>)	IFA_CONFIG (R88<1:0>)
1.2	1	7	0
1.3	1	3	0
1.4	1	1	0
1.5	0	0	0
>= 1.6	0	0	3

7.3.1.7 Synchronization Mode (Internal LO Mode Only)

7.3.1.7.1 Synchronization of the LO_OUT Output to the Fosc Input

The LO_OUT pin can be synchronized to the Fosc input in exactly the same way that the LMX2594 can. For cases where the output frequency is not a multiple of the input frequency, the SYNC pin can be used.

7.3.1.7.2 Synchronization of I/Q Outputs to Fosc Inputs Using Internal LO

When the internal LO is used, IF outputs of two devices can be synchronized to the Fosc input if and only if the VCO frequency is a multiple of the Fosc frequency and there is no multiplication in the input path (OSC_2X = 0 and MULT=1). The device is inherently in SYNC all the time in this condition so therefore there is no need to use the SYNC pin or to toggle the SYNC_PHASE_PLL bit.

7.4 Device Functional Modes

The LMX8410L can be programmed for two functional modes: internal LO mode (using the integrated synthesizer) or external LO mode (bypassing the integrated synthesizer). In internal LO mode, when 4GHz <= LO frequency <= 7.5 GHz, use divide-by-2 (Div 2) mode; when 7.5 GHz <= LO frequency <= 10 GHz, use polyphase filter mode (Poly). Refer to [表 3](#) to set up registers correctly. Under special circumstances where integrated synthesizer fails to lock at 7.5 ~ 7.7GHz, refer to [VCO Range Uncertainty for 7.5 to 7.7 GHz](#) for more instructions.

表 3. Internal LO Mode and External LO Mode Register Configurations

FIELD NAME	ADDRESS	INTERNAL LO/DIV2	INTERNAL LO/Poly	EXTERNAL LO
PLL_PD	R0[0]	0	0	1
LO_OUT_PD	R44[7]	1	1	1
SIGCHAIN_PD	R79[0]	0	0	0
LO_PATH_EN	R79[14:12]	0	7	7
LO_MUX	R80[5:0]	9	10	34
SM_CLK_SEL	R81[0]	0	0	1
EXTLO_CLK_DRV_EN	R81[2:1]	0	0	3
LO_DRV_MODE	R81[5:4]	1	0	3
EXTLO_CLK_DIV_EN	R81[7:6]	0	0	3
LO_POLY_MODE1	R81[11:8]	3	0	15
LO_POLY_MODE2	R103[13:10]	11	0	0
EXTLO_INT_MATCH_RES	R123[1:0]	0	0	3

7.4.1 Internal LO Mode

When using internal LO mode, the integrated synthesizer is activated to generate the desired LO frequency. The OSCINP and OSCINM pins are used to provide a reference frequency to the PLL and are required to generate the internal state machine clock. The CP pin generates the phase detector output for use with an external loop filter. The filtered phase detector output is fed into the VTUNE pin to control the internal VCO, generating frequencies between 7.5 GHz and 15 GHz. The VCO output is divided down to close the loop into the phase detector. The VCO output may be fed directly into the I/Q generation circuitry.

The I/Q generation circuitry has two paths: a divide-by-2 path, and a polyphase filter path. Depending on the frequency of the LO, the I/Q generation circuitry used will differ. The divide-by-2 path requires the VCO frequency to be double that of the LO frequency. When the LO frequency is between 4 GHz and 7.5 GHz, the VCO can be programmed to between 8 GHz and 15 GHz, and the VCO output can be fed into the divide-by-2 path. When the LO frequency is greater than 7.5 GHz, the VCO can be programmed to between 7.5 GHz and 15 GHz, and the VCO output can be fed into the polyphase filter path.

In Internal LO mode, the LO pins may be used as outputs (refer to [LO Interface as Output Port](#)) for three separate signals internal to the device:

1. The VCO output may be fed directly to the LO pins.
2. The VCO may be divided by any possible combination using the channel divider, and the divided output may be fed to the LO pins. Refer to the datasheet of LMX2594 for more details.

7.4.1.1 VCO Range Uncertainty for 7.5 to 7.7 GHz

Although the majority of devices have a VCO range of 7.5 to 15 GHz, this is NOT ensured. In reality, the VCO is tested for sure to cover 7.7 to 15 GHz. In the range of 7.5 to 7.7 GHz and 15 to 15.4 GHz, the VCO will cover at least enough frequency to cover a factor of two in frequency. What this means if using the internal mixer is that if one wants a LO frequency of 7.6 GHz, then first try this using the poly mode and VCO frequency of 7.6 GHz. However, if the VCO can not do 7.6 GHz, then one has to try DIV2 Mode with the VCO at 15.2 GHz.

表 4. VCO Ensured Frequency

Parameter	Symbol	Ensured Condition
Minimum VCO Frequency	f_{VCOMin}	$f_{VCOMin} \leq 7.7 \text{ GHz}$
Maximum VCO Frequency	f_{VCOMax}	$f_{VCOMax} \geq \text{Max}\{ 15 \text{ GHz}, 2 \times f_{VCOMin} \}$

7.4.2 External LO Mode

When using External LO mode, the integrated synthesizer may be powered down and bypassed. The internal state machine clock is derived by dividing down the LO input. Since the frequency range of the LO circuit is bounded below the operational frequency of the divide-by-2 path, I/Q generation must be done using the polyphase filter path.

In External LO mode, some pins must be configured differently than in Internal LO mode. Even when the synthesizer circuitry is bypassed, VCC should be applied to all power pins (though bypass capacitors are no longer required). 表 5 contains a summary of the External LO requirements.

表 5. External LO Pin Configuration

PIN NO.	NAME	I/O	EXTERNAL LO REQUIREMENTS
2	VBIAS_VCO2	Bypass	Floating (no connection) or same configuration with internal LO mode
3	VBIAS_VCO1	Bypass	Floating (no connection) or same configuration with internal LO mode
5	SYNC	Input	Grounded
8	OSCINP	input	Grounded
9	OSCINM	input	Grounded
10	VREG_OSCIN	Bypass	Floating (no connection) or same configuration with internal LO mode
13	CP	Output	Floating (no connection) or same configuration with internal LO mode
17	LO_M	Input	Matching network recommended. No pull-up resistors / inductors. ⁽¹⁾
18	LO_P	Input	Matching network recommended. No pull-up resistors / inductors. ⁽¹⁾
42	VBIAS_VARAC	Bypass	Floating (no connection) or same configuration with internal LO mode
44	VTUNE	Input	Grounded
47	VREF_VCO	Bypass	Floating (no connection) or same configuration with internal LO mode

(1) Refer to [LO Interface as Input Port](#) for LO interfacing.

7.5 Programming

7.5.1 General Comments Regarding Programming

This device is programmed using 24-bit shift registers. The shift register consists of a R/W bit (MSB), followed by a 7-bit address field and a 16-bit data field. For the R/W bit, 0 is for write, and 1 is for read. The address field ADDRESS[6:0] is used to decode the internal register address. The remaining 16 bits form the data field DATA[15:0]. While CSB is low, serial data is clocked into the shift register upon the rising edge of clock (data is programmed MSB first). When CSB goes

Programming (接下页)

7.5.2 Recommended Initial Power Up Sequence

For the most reliable programming, TI recommends this procedure: 1. 2. Program RESET = 1 to reset registers. 3. Program RESET = 0 to remove reset. 4. Program registers as shown in the register map in REVERSE order from highest to lowest. 5. Program register R0 one additional time with FCAL_EN = 1 to ensure that the VCO calibration runs from a stable state.

1. Apply power to device.
2. Program Register R127 to value 0x7F0003
3. Program Register R6 to value 0x060100
4. Program registers R127 to R0 in REVERSE Order
5. If using internal LO, wait 10 ms and then Program register R0 again

7.5.3 Recommended and Power on Reset Bit Values

There are a few points of clarification for power on reset values and recommended values.

1. Whenever power is cycled on the chip, the registers are reset to their power on reset (not necessarily recommended) state.
2. In the main register map, there are several registers with only 1's and 0's and no defined words. DO NOT ASSUME that these registers do not need to be programmed. In many cases, these 1's and 0's are different than the power on reset values.
3. In the register description, the word 'RESET' is used, but what is really meant is "Recommended" State

7.6 Register Map

This device has 128 registers from R0 to R127. They must be programmed in REVERSE order. Note that there are several registers that have no description, but they still need to be programmed as the power on reset value is not always the correct value. The complete listing for all registers, including those not described in this datasheet are available on the Registers tab on the TI TICSPRO software.

表 6. Full Register Map

	D15	D14	D13	D12	D11	D10	D9	D8	D7	D6	D5	D4	D3	D2	D1	D0
R0	0	SYNC_P HASE_P LL	1	0	0	0	OUT_MU TE	FCAL_HPFD_ADJ 0			0	1	FCAL_E N	MUXOU T_SEL	RESET_ PLL	PLL_PD
R1	0	0	0	0	1	0	0	0	0	0	0	0	1	CAL_CLK_DIV		
R2	0	0	0	0	0	1	0	1	0	0	0	0	0	0	0	0
R3	0	0	0	0	0	1	1	0	0	1	0	0	0	0	1	0
R4	0	0	0	1	1	0	0	1	0	1	0	0	0	0	1	1
R5	0	0	0	0	0	0	0	0	1	1	0	0	1	0	0	0
R6	1	1	0	0	1	0	0	0	0	0	0	0	0	0	1	0
R7	0	0	0	0	0	0	0	0	1	0	1	1	0	0	1	0
R8	0	0	1	0	0	0	0	0	0	0	0	0	0	0	0	0
R9	0	0	0	OSC_2X	0	1	1	0	0	0	0	0	0	1	0	0
R10	0	0	0	1	MULT					1	0	1	1	0	0	0
R11	0	0	0	0	PLL_R							1	0	0	0	
R12	0	1	0	1	0	0	0	0	0	0	0	0	0	0	0	1
R13	0	1	0	0	0	0	0	0	0	0	0	0	0	0	0	0
R14	0	0	0	1	0	0	1	1	1	CPG			0	0	0	0
R15	0	0	0	0	0	1	1	0	0	1	0	0	1	1	1	1
R16	0	0	0	0	0	0	0	0	1	0	0	0	0	0	0	0
R17	0	0	0	0	0	0	0	0	1	1	1	1	1	0	1	0
R18	0	0	0	0	0	0	0	0	0	1	1	0	0	1	0	0
R19	0	0	1	0	0	1	1	1	1	0	1	1	0	1	1	1
R20	1	1	1	1	1	0	0	0	0	1	0	0	1	0	0	0
R21	0	0	0	0	0	1	0	0	0	0	0	0	0	0	0	1
R22	0	0	0	0	0	0	0	0	0	0	0	0	0	0	0	1
R23	0	0	0	0	0	0	0	0	0	1	1	1	1	1	0	0
R24	0	0	0	0	0	1	1	1	0	0	0	1	1	0	1	0
R25	0	0	0	0	0	1	1	0	0	0	1	0	0	1	0	0
R26	0	0	0	0	1	1	0	1	1	0	1	1	0	0	0	0
R27	0	0	0	0	0	0	0	0	0	0	0	0	0	0	1	0
R28	0	0	0	0	0	1	0	0	1	0	0	0	1	0	0	0
R29	0	0	1	1	0	0	0	1	1	0	0	0	1	1	0	0
R30	0	0	1	1	0	0	0	1	1	0	0	0	1	1	0	0
R31	0	1	0	0	0	0	1	1	1	1	1	0	1	1	0	0

表 6. Full Register Map (接下页)

	D15	D14	D13	D12	D11	D10	D9	D8	D7	D6	D5	D4	D3	D2	D1	D0	
R32	0	0	0	0	0	0	1	1	1	0	0	1	0	0	1	1	
R33	0	0	0	1	1	1	1	0	0	0	1	0	0	0	0	1	
R34	0	0	0	0	0	0	0	0	0	0	0	0	0	0	0	0	
R35	0	0	0	0	0	0	0	0	0	0	0	0	0	1	0	0	
R36	PLL_N																
R37	1	0	PFD_DLY_SEL						0	0	0	0	0	0	1	0	0
R38	PLL_DEN[31:16]																
R39	PLL_DEN[15:0]																
R40	MASH_SEED[31:16]																
R41	MASH_SEED[15:0]																
R42	PLL_NUM[31:16]																
R43	PLL_NUM[15:0]																
R44	0	0	0	1	1	1	1	1	LO_OUT_PD	0	MASH_RESET_N	0	0	MASH_ORDER			
R45	1	1	0	0	1	1	1	0	1	1	0	1	1	1	1	1	
R46	0	0	0	0	0	1	1	1	1	1	1	1	1	1	LO_OUT_MUX		
R47	0	0	0	0	0	0	1	1	0	0	0	0	0	0	0	0	
R48	0	0	0	0	0	0	1	1	0	0	0	0	0	0	0	0	
R49	0	1	0	0	0	0	0	1	1	0	0	0	0	0	0	0	
R50	0	0	0	0	0	0	0	0	0	0	0	0	0	0	0	0	
R51	0	0	0	0	0	0	0	0	1	0	0	0	0	0	0	0	
R52	0	0	0	0	1	0	0	0	0	0	1	0	0	0	0	0	
R53	0	0	0	0	0	0	0	0	0	0	0	0	0	0	0	0	
R54	0	0	0	0	0	0	0	0	0	0	0	0	0	0	0	0	
R55	0	0	0	0	0	0	0	0	0	0	0	0	0	0	0	0	
R56	0	0	0	0	0	0	0	0	0	0	0	0	0	0	0	0	
R57	0	0	0	0	0	0	0	0	0	0	0	0	0	0	0	0	
R58	SYNC_PIGNORE	0	0	0	0	0	0	0	0	0	0	0	0	0	0	1	
R59	0	0	0	0	0	0	0	0	0	0	0	0	0	0	0	LD_TYPE	
R60	0	0	0	0	0	0	1	1	1	1	1	0	1	0	0	0	
R61	0	0	0	0	0	0	0	0	1	0	1	0	1	0	0	0	
R62	0	0	0	0	0	0	0	0	0	0	1	0	0	0	1	0	

表 6. Full Register Map (接下页)

	D15	D14	D13	D12	D11	D10	D9	D8	D7	D6	D5	D4	D3	D2	D1	D0	
R63	0	0	0	0	0	0	0	0	0	0	0	0	0	0	0	0	
R64	0	0	0	1	0	0	1	1	1	0	0	0	1	0	0	0	
R65	0	0	0	0	0	0	0	0	0	0	0	0	0	0	0	0	
R66	0	0	0	0	0	0	0	1	1	1	1	1	0	1	0	0	
R67	0	0	0	0	0	0	0	0	0	0	0	0	0	0	0	0	
R68	0	0	0	0	0	0	1	1	1	1	1	0	1	0	0	0	
R69	MASH_RST_COUNT[31:16]																
R70	MASH_RST_COUNT[15:0]																
R71	0	0	0	0	0	0	0	0	1	0	0	0	0	0	0	1	
R72	0	0	0	0	0	0	0	0	0	0	0	0	0	0	0	1	
R73	0	0	0	0	0	0	0	0	0	0	1	1	1	1	1	1	
R74	0	0	0	0	0	0	0	0	0	0	0	0	0	0	0	0	
R75	0	0	0	0	1	CHDIV					0	0	0	0	0	0	
R76	0	0	0	0	0	0	0	0	0	0	0	0	1	1	0	0	
R77	0	0	0	0	0	0	0	0	0	0	0	0	0	0	0	0	
R78	0	0	0	0	0	0	VCO_CALSTART_CLOSE	0	0	1	1	0	0	1	0	0	
R79	0	LO_PATH_EN			0	0	0	0	0	0	IFA_PULLUP_EN	0	0	0	LNA_PD	SIGPATH_RST	SIGCHAIN_PD
R80	0	0	0	0	SYNC_PHASE_MXLO	SYNC_DRV2_EN	SYNC_DRV1_EN	0	0	0	LO_MUX						
R81	0	0	0	0	LO_POLY_MODE1				EXTLO_CLK_DIV_EN		LO_DVR_MODE		0	EXTLO_CLK_DRV_EN		SM_CLK_SEL	
R82	0	0	0	0	1	0	1	0	0	0	EXTLO_DIV						
R83	IFA_PULLUP			VCM_CONFIG				0	0	0	1	0	0	0	0	1	
R84	DCOC_CLK_DIV										0	0	0	0	EN_DCO_C_QCH_LUT	EN_DCO_C_ICH_LUT	
R85	0	0	0	0	0	0	0	0	0	0	0	0	0	0	0	0	
R86	0	0	0	0	0	0	0	0	0	0	0	0	0	0	0	0	
R87	0	0	0	0	0	0	0	0	0	0	0	0	0	0	0	0	
R88	rb_DCOC_CAL		0	0	0	0	0	0	0	0	0	0	0	0	1	1	
R89	0	0	0	0	0	0	0	0	0	0	0	0	0	0	0	0	
R90	0	0	0	0	0	0	0	0	0	0	0	0	0	0	0	0	

表 6. Full Register Map (接下页)

	D15	D14	D13	D12	D11	D10	D9	D8	D7	D6	D5	D4	D3	D2	D1	D0	
R91	0	0	0	0	0	0	0	0	0	0	0	0	0	0	0	0	
R92	0	0	0	0	0	0	0	0	0	0	0	0	0	0	0	0	
R93	0	0	0	0	0	0	0	0	0	0	0	0	0	0	0	0	
R94	IMRR_GCAL_QCH							IMRR_GCAL_ICH									
R95	IMRR_P HCAL_P OL	IMRR_PHCAL						0	0	0	0	0	0	0	0	0	0
R96	1	0	0	1	0	0	1	0	0	0	0	1	1	0	0	0	
R97	0	0	0	0	0	0	0	0	0	0	0	0	0	0	0	0	
R98	0	0	0	0	0	0	0	0	0	0	0	0	0	0	0	0	
R99	0	0	0	0	0	0	0	0	0	0	0	0	0	0	0	0	
R100	0	0	0	0	0	0	0	0	0	0	0	0	0	0	1	0	
R101	0	0	0	0	0	0	0	0	0	0	0	0	0	0	1	0	
R102	0	0	0	0	0	0	0	0	0	0	0	0	0	0	0	0	
R103	0	0	LO_POLY_MODE2				0	0	0	0	0	0	0	0	0	0	0
R104	0	1	0	0	0	0	0	0	0	0	0	1	0	0	0	0	
R105	0	0	0	0	0	0	0	0	0	0	0	1	1	1	0	0	
R106	0	0	0	0	0	0	0	0	0	0	0	0	0	0	0	0	
R107	0	0	0	0	0	0	0	0	0	0	0	0	0	0	0	0	
R108	0	0	0	0	0	0	0	0	0	0	0	0	0	0	0	0	
R109	0	0	0	0	0	0	0	0	0	0	0	0	0	0	0	0	
R110	0	0	0	0	0	rb_LD_VTUNE		0	rb_VCO_SEL			0	0	0	0	0	
R111	0	0	0	0	0	0	0	0	rb_VCO_CAPCTRL								
R112	0	0	0	0	0	0	0	rb_VCO_DACISSET									
R113	0	0	0	0	0	0	0	0	0	0	0	0	0	0	0	0	
R114	0	0	0	0	0	0	0	0	0	0	0	0	0	0	0	0	
R115	0	0	0	0	0	1	1	1	0	0	0	0	0	0	0	0	
R116	0	0	0	0	0	0	0	0	0	0	0	0	0	0	0	0	
R117	0	0	0	0	0	0	0	0	1	1	0	0	0	0	0	0	
R118	0	0	0	0	0	0	0	0	0	0	0	0	0	0	0	0	
R119	0	0	0	0	0	0	0	0	0	0	0	0	1	0	1	0	
R120	0	0	0	0	0	0	0	0	0	0	0	0	0	0	0	0	
R121	0	0	0	0	0	0	0	0	0	BIAS_LNA_CUR_C ONFIG		0	0	0	0	0	
R122	0	0	0	0	0	0	0	0	0	0	0	0	0	0	0	0	

表 6. Full Register Map (接下页)

	D15	D14	D13	D12	D11	D10	D9	D8	D7	D6	D5	D4	D3	D2	D1	D0
R123	0	0	0	0	0	0	0	0	0	0	0	0	0	0	EXTLO_INT_MATC H_RES	
R124	0	0	0	0	0	0	0	0	0	0	0	0	0	0	0	0
R125	0	0	0	0	0	0	0	0	0	0	0	0	0	0	0	0
R126	IMRR_P HCAL_E XTEND	0	0	0	0	0	0	0	0	0	0	0	0	0	0	0
R127	0	0	0	0	0	0	0	0	0	0	0	0	0	0	0	0

Table 7 lists the memory-mapped registers for the Device registers. All register offset addresses not listed in Table 7 should be considered as reserved locations and the register contents should not be modified.

Table 7. Device Registers

Address	Acronym	Register Name	Section
0x0	R0		Go
0x1	R1		Go
0x2	R2		Go
0x9	R9		Go
0xA	R10		Go
0xB	R11		Go
0xE	R14		Go
0x24	R36		Go
0x25	R37		Go
0x26	R38		Go
0x27	R39		Go
0x28	R40		Go
0x29	R41		Go
0x2A	R42		Go
0x2B	R43		Go
0x2C	R44		Go
0x2E	R46		Go
0x3A	R58		Go
0x3B	R59		Go
0x45	R69		Go
0x46	R70		Go
0x4B	R75		Go
0x4E	R78		Go
0x4F	R79		Go
0x50	R80		Go
0x51	R81		Go
0x52	R82		Go
0x53	R83		Go
0x54	R84		Go
0x58	R88		Go
0x5E	R94		Go
0x5F	R95		Go
0x67	R103		Go
0x6E	R110		Go
0x6F	R111		Go
0x70	R112		Go
0x79	R121		Go
0x7B	R123		Go
0x7E	R126		Go

Complex bit access types are encoded to fit into small table cells. Table 8 shows the codes that are used for access types in this section.

Table 8. Device Access Type Codes

Access Type	Code	Description
Read Type		
R	R	Read
Write Type		
W	W	Write
Reset or Default Value		
-n		Value after reset or the default value

7.6.1 R0 Register (Address = 0x0) [reset = X]

R0 is shown in [Figure 52](#) and described in [Table 9](#).

Return to [Summary Table](#).

Figure 52. R0 Register

7	6	5	4	3	2	1	0
FCAL_HPFD_ADJ	RESERVED			FCAL_EN	MUXOUT_SEL	RESET_PLL	PLL_PD
R/W-0x0	R-0x0			R/W-0x1	R/W-0x1	R/W-0x0	R/W-0x0

Table 9. R0 Register Field Descriptions

Bit	Field	Type	Reset	Description
14	SYNC_PHASE_PLL	R/W	X	Puts PLL in SYNC mode so that the channel divider can be synchronized
13-10	RESERVED	R	X	
9	OUT_MUTE	R/W	X	Output buffer automute. 0x0 = Disabled 0x1 = Mutes output buffer during FCAL and when PLL not locked
8-7	FCAL_HPFD_ADJ	R/W	0x0	VCO calibration adjust for higher phase detector frequencies 0x0 = Fpd < 100 MHz 0x1 = Fpd 100 - 150 MHz 0x2 = Fpd 150 - 200 MHz 0x3 = Fpd > 200 MHz
6-4	RESERVED	R	0x0	
3	FCAL_EN	R/W	0x1	Enables frequency calibration. When this bit is high, the VCO frequency calibration will be triggered whenever the R0 register is written to.
2	MUXOUT_SEL	R/W	0x1	Selects to route readback serial data output or lock detect output at the MUXout pin 0x0 = Readback 0x1 = Lock Detect
1	RESET_PLL	R/W	0x0	Reset registers to default values. This bit is self-clearing. 0x0 = No Reset 0x1 = Trigger Reset
0	PLL_PD	R/W	0x0	PLL power down. 0x0 = Powerd Up 0x1 = Powered Down

7.6.2 R1 Register (Address = 0x1) [reset = 0x3]

R1 is shown in [Figure 53](#) and described in [Table 10](#).

Return to [Summary Table](#).

Figure 53. R1 Register

7	6	5	4	3	2	1	0
RESERVED					CAL_CLK_DIV		
R-0x0					R/W-0x3		

Table 10. R1 Register Field Descriptions

Bit	Field	Type	Reset	Description
7-3	RESERVED	R	0x0	
2-0	CAL_CLK_DIV	R/W	0x3	Divides down for state machine clock [SM clock = $F_{osc}/2^{CAL_CLK_DIV}$]. Maximum state machine clock frequency is 200MHz. For fastest calibration speed, choose value which will make state machine clock closest to 200 MHz.

7.6.3 R2 Register (Address = 0x2) [reset = X]

R2 is shown in [Figure 54](#) and described in [Table 11](#).

Return to [Summary Table](#).

Figure 54. R2 Register

7	6	5	4	3	2	1	0
RESERVED							
R-0x0							

Table 11. R2 Register Field Descriptions

Bit	Field	Type	Reset	Description
10	SM_CLK_EN	R/W	X	Enables state machine clock
9-0	RESERVED	R	0x0	

7.6.4 R9 Register (Address = 0x9) [reset = X]

R9 is shown in [Figure 55](#) and described in [Table 12](#).

Return to [Summary Table](#).

Figure 55. R9 Register

7	6	5	4	3	2	1	0
RESERVED							
R-0x0							

Table 12. R9 Register Field Descriptions

Bit	Field	Type	Reset	Description
12	OSC_2X	R/W	X	Enables the frequency doubler after the input reference signal. 0x0 = Bypass 0x1 = Enable doubler
11-0	RESERVED	R	0x0	

7.6.5 R10 Register (Address = 0xA) [reset = 0x80]

R10 is shown in [Figure 56](#) and described in [Table 13](#).

Return to [Summary Table](#).

Figure 56. R10 Register

7	6	5	4	3	2	1	0
MULT		RESERVED					
R/W-0x1		R-0x0					

Table 13. R10 Register Field Descriptions

Bit	Field	Type	Reset	Description
11-7	MULT	R/W	0x1	Input signal multiplier. When not in bypass, input range is 40-70MHz, output range is 180-250MHz. 1,3,4,5,6, and 7 are the only valid values. 0x1 = Bypass 0x3 = x3 0x4 = x4 0x5 = x5 0x6 = x6
6-0	RESERVED	R	0x0	

7.6.6 R11 Register (Address = 0xB) [reset = 0x10]

R11 is shown in [Figure 57](#) and described in [Table 14](#).

Return to [Summary Table](#).

Figure 57. R11 Register

7	6	5	4	3	2	1	0
PLL_R				RESERVED			
R/W-0x1				R-0x0			

Table 14. R11 Register Field Descriptions

Bit	Field	Type	Reset	Description
11-4	PLL_R	R/W	0x1	PLL R divider that is after the input multiplier.
3-0	RESERVED	R	0x0	

7.6.7 R14 Register (Address = 0xE) [reset = 0x70]

R14 is shown in [Figure 58](#) and described in [Table 15](#).

Return to [Summary Table](#).

Figure 58. R14 Register

7	6	5	4	3	2	1	0
RESERVED		CPG			RESERVED		
R-0x0		R/W-0x7			R-0x0		

Table 15. R14 Register Field Descriptions

Bit	Field	Type	Reset	Description
7	RESERVED	R	0x0	
6-4	CPG	R/W	0x7	Charge pump gain 0x0 = 0 mA 0x1 = 6 mA 0x2 = 6 mA 0x3 = 12 mA 0x4 = 3 mA 0x5 = 9 mA 0x6 = 9 mA 0x7 = 15 mA
3-0	RESERVED	R	0x0	

7.6.8 R36 Register (Address = 0x24) [reset = 0x64]

 R36 is shown in [Figure 59](#) and described in [Table 16](#).

 Return to [Summary Table](#).

Figure 59. R36 Register

15	14	13	12	11	10	9	8	7	6	5	4	3	2	1	0
PLL_N															
R/W-0x64															

Table 16. R36 Register Field Descriptions

Bit	Field	Type	Reset	Description
15-0	PLL_N	R/W	0x64	Integer part of N divider

7.6.9 R37 Register (Address = 0x25) [reset = 0x200]

 R37 is shown in [Figure 60](#) and described in [Table 17](#).

 Return to [Summary Table](#).

Figure 60. R37 Register

15	14	13	12	11	10	9	8
RESERVED				PFD_DLY_SEL			
R-0x0				R/W-0x2			
7	6	5	4	3	2	1	0
RESERVED							
R-0x0							

Table 17. R37 Register Field Descriptions

Bit	Field	Type	Reset	Description
15-14	RESERVED	R	0x0	
13-8	PFD_DLY_SEL	R/W	0x2	Sets the appropriate delay adjustment for the phase detector based on PLL_N, MASH_ORDER, and phase detector frequency.
7-0	RESERVED	R	0x0	

7.6.10 R38 Register (Address = 0x26) [reset = 0x0]

R38 is shown in [Figure 61](#) and described in [Table 18](#).

Return to [Summary Table](#).

Figure 61. R38 Register

15	14	13	12	11	10	9	8	7	6	5	4	3	2	1	0
PLL_DEN_31:16															
R/W-0x0															

Table 18. R38 Register Field Descriptions

Bit	Field	Type	Reset	Description
15-0	PLL_DEN_31:16	R/W	0x0	Denominator of N divider fraction (MSB)

7.6.11 R39 Register (Address = 0x27) [reset = 0x2710]

R39 is shown in [Figure 62](#) and described in [Table 19](#).

Return to [Summary Table](#).

Figure 62. R39 Register

15	14	13	12	11	10	9	8	7	6	5	4	3	2	1	0
PLL_DEN															
R/W-0x2710															

Table 19. R39 Register Field Descriptions

Bit	Field	Type	Reset	Description
15-0	PLL_DEN	R/W	0x2710	Denominator of N divider fraction (LSB)

7.6.12 R40 Register (Address = 0x28) [reset = 0x0]

R40 is shown in [Figure 63](#) and described in [Table 20](#).

Return to [Summary Table](#).

Figure 63. R40 Register

15	14	13	12	11	10	9	8	7	6	5	4	3	2	1	0
MASH_SEED_31:16															
R/W-0x0															

Table 20. R40 Register Field Descriptions

Bit	Field	Type	Reset	Description
15-0	MASH_SEED_31:16	R/W	0x0	MSB bit of MASH_SEED

7.6.13 R41 Register (Address = 0x29) [reset = 0x0]

R41 is shown in [Figure 64](#) and described in [Table 21](#).

Return to [Summary Table](#).

Figure 64. R41 Register

15	14	13	12	11	10	9	8	7	6	5	4	3	2	1	0
MASH_SEED															
R/W-0x0															

Table 21. R41 Register Field Descriptions

Bit	Field	Type	Reset	Description
15-0	MASH_SEED	R/W	0x0	The MASH_SEED can be used for optimizing fractional mode (see simulation tool) and also phase adjustment feature. Phase adjustment writing to this register will trigger a phase shift (in degrees) = $360 \times [\text{MASH_SEED}] \times [\text{PLL_N_PRE}] / [\text{N-divider denominator}] / [\text{Channel divider}]$. MASH_SEED must be less than N-divider denominator. For example, for MASH_SEED = 100, PLL_N_PRE=2, PLL_DEN = 200, CHDIV=3, Phase Shift = $360 * 100 * 2 / 200 / 3 = 120$ degrees

7.6.14 R42 Register (Address = 0x2A) [reset = 0x0]

 R42 is shown in [Figure 65](#) and described in [Table 22](#).

 Return to [Summary Table](#).

Figure 65. R42 Register

15	14	13	12	11	10	9	8	7	6	5	4	3	2	1	0
PLL_NUM_31:16															
R/W-0x0															

Table 22. R42 Register Field Descriptions

Bit	Field	Type	Reset	Description
15-0	PLL_NUM_31:16	R/W	0x0	Numerator of N divider fraction (MSB)

7.6.15 R43 Register (Address = 0x2B) [reset = 0x0]

 R43 is shown in [Figure 66](#) and described in [Table 23](#).

 Return to [Summary Table](#).

Figure 66. R43 Register

15	14	13	12	11	10	9	8	7	6	5	4	3	2	1	0
PLL_NUM															
R/W-0x0															

Table 23. R43 Register Field Descriptions

Bit	Field	Type	Reset	Description
15-0	PLL_NUM	R/W	0x0	Numerator of N divider fraction (LSB)

7.6.16 R44 Register (Address = 0x2C) [reset = 0xA2]

 R44 is shown in [Figure 67](#) and described in [Table 24](#).

 Return to [Summary Table](#).

Figure 67. R44 Register

15	14	13	12	11	10	9	8
RESERVED							
R-0x0							
7	6	5	4	3	2	1	0
LO_OUT_PD	RESERVED	MASH_RESET_N	RESERVED			MASH_ORDER	
R/W-0x1	R-0x0	R/W-0x1	R-0x0			R/W-0x2	

Table 24. R44 Register Field Descriptions

Bit	Field	Type	Reset	Description
15-8	RESERVED	R	0x0	
7	LO_OUT_PD	R/W	0x1	Disable output buffer of output A 0x0 = Enable 0x1 = Disable (disable if not using output B)
6	RESERVED	R	0x0	
5	MASH_RESET_N	R/W	0x1	MASH enable. Should be set to 1 in fractional mode. To reset the MASH toggle from 0 to 1.
4-3	RESERVED	R	0x0	
2-0	MASH_ORDER	R/W	0x2	Fractional-N divider sigma-delta MASH engine order. This sets the algorithm used in fractional-N mode generation and has impact on fractional spurs. Refer to the datasheet for more information. Recommended values are as follows, but other values may also work.

7.6.17 R46 Register (Address = 0x2E) [reset = 0x1]

R46 is shown in [Figure 68](#) and described in [Table 25](#).

Return to [Summary Table](#).

Figure 68. R46 Register

15	14	13	12	11	10	9	8
RESERVED							
R-0x0							
7	6	5	4	3	2	1	0
RESERVED						LO_OUT_MUX	
R-0x0						R/W-0x1	

Table 25. R46 Register Field Descriptions

Bit	Field	Type	Reset	Description
15-2	RESERVED	R	0x0	
1-0	LO_OUT_MUX	R/W	0x1	Selects signal to route to output B 0x0 = Selects the output from channel divider MUX 0x1 = Selects output from VCO

7.6.18 R58 Register (Address = 0x3A) [reset = 0x8000]

R58 is shown in [Figure 69](#) and described in [Table 26](#).

Return to [Summary Table](#).

Figure 69. R58 Register

15	14	13	12	11	10	9	8
SYNC_PIN_IG NORE	RESERVED						
R/W-0x1	R-0x0						
7	6	5	4	3	2	1	0
RESERVED							
R-0x0							

Table 26. R58 Register Field Descriptions

Bit	Field	Type	Reset	Description
15	SYNC_PIN_IGNORE	R/W	0x1	Enable this bit when NOT using SYNC mode as the SYNC pin interferes with lock detect in this case. When PLL_PHASE_SYNC=1, this bit may be disabled with no issues with lock detect.
14-0	RESERVED	R	0x0	

7.6.19 R59 Register (Address = 0x3B) [reset = 0x1]

 R59 is shown in [Figure 70](#) and described in [Table 27](#).

 Return to [Summary Table](#).

Figure 70. R59 Register

15	14	13	12	11	10	9	8
RESERVED							
R-0x0							
7	6	5	4	3	2	1	0
RESERVED							LD_TYPE
R-0x0							R/W-0x1

Table 27. R59 Register Field Descriptions

Bit	Field	Type	Reset	Description
15-1	RESERVED	R	0x0	
0	LD_TYPE	R/W	0x1	Lock detect type. VCOCal lock detect is high except when the VCO is calibrating and also during a timeout count right after calibration set LD_DLY. Vtune and VCOCal lock detect is high whenever VCOCal lock detect would be high and the VCO tuning voltage is within an acceptable range. 0x0 = VCOCal 0x1 = Vtune and VCOCal.

7.6.20 R69 Register (Address = 0x45) [reset = 0x0]

 R69 is shown in [Figure 71](#) and described in [Table 28](#).

 Return to [Summary Table](#).

Figure 71. R69 Register

15	14	13	12	11	10	9	8	7	6	5	4	3	2	1	0
MASH_RST_COUNT_31:16															
R/W-0x0															

Table 28. R69 Register Field Descriptions

Bit	Field	Type	Reset	Description
15-0	MASH_RST_COUNT_31:16	R/W	0x0	MSB of MASH_RST_COUNT

7.6.21 R70 Register (Address = 0x46) [reset = 0xC350]

 R70 is shown in [Figure 72](#) and described in [Table 29](#).

 Return to [Summary Table](#).

Figure 72. R70 Register

15	14	13	12	11	10	9	8	7	6	5	4	3	2	1	0
MASH_RST_COUNT															
R/W-0xC350															

Table 29. R70 Register Field Descriptions

Bit	Field	Type	Reset	Description
15-0	MASH_RST_COUNT	R/W	0xC350	When using a fractional N value with PLL_PHASE_SYNC=1, this is used to set a delay to allow the SYNC to work properly. In general, it should be set to a count equal to 4X the analog settling time of the PLL. (LSB)

7.6.22 R75 Register (Address = 0x4B) [reset = 0x0]

R75 is shown in [Figure 73](#) and described in [Table 30](#).

Return to [Summary Table](#).

Figure 73. R75 Register

15	14	13	12	11	10	9	8
RESERVED						CHDIV	
R-0x0						R/W-0x0	
7	6	5	4	3	2	1	0
CHDIV		RESERVED					
R/W-0x0		R-0x0					

Table 30. R75 Register Field Descriptions

Bit	Field	Type	Reset	Description
15-11	RESERVED	R	0x0	
10-6	CHDIV	R/W	0x0	Channel divider that divides the VCO frequency.
5-0	RESERVED	R	0x0	

7.6.23 R78 Register (Address = 0x4E) [reset = 0x0]

R78 is shown in [Figure 74](#) and described in [Table 31](#).

Return to [Summary Table](#).

Figure 74. R78 Register

15	14	13	12	11	10	9	8
RESERVED						VCO_CALSTA RT_CLOSE	RESERVED
R-0x0						R/W-0x0	R-0x0
7	6	5	4	3	2	1	0
RESERVED							
R-0x0							

Table 31. R78 Register Field Descriptions

Bit	Field	Type	Reset	Description
15-10	RESERVED	R	0x0	
9	VCO_CALSTART_CLOS E	R/W	0x0	Uses current values for VCO core, frequency band, and amplitude as the starting point for the next VCO calibration. Enable this if the VCO frequency change is close, on the order of 50 MHz or less.
8-0	RESERVED	R	0x0	

7.6.24 R79 Register (Address = 0x4F) [reset = 0x7000]

 R79 is shown in [Figure 75](#) and described in [Table 32](#).

 Return to [Summary Table](#).

Figure 75. R79 Register

15	14	13	12	11	10	9	8
RESERVED	LO_PATH_EN			RESERVED			
R-0x0	R/W-0x7			R-0x0			
7	6	5	4	3	2	1	0
RESERVED	IFA_PULLUP_EN	RESERVED			LNA_PD	SIGPATH_RST	SIGCHAIN_PD
R-0x0	R/W-0x0	R-0x0			R/W-0x0	R/W-0x0	R/W-0x0

Table 32. R79 Register Field Descriptions

Bit	Field	Type	Reset	Description
15	RESERVED	R	0x0	
14-12	LO_PATH_EN	R/W	0x7	Enables various parts of the Poly and DIV2 Path
11-7	RESERVED	R	0x0	
6	IFA_PULLUP_EN	R/W	0x0	Enable the pull up resistor at the input of the IFA. Needed when the output comoon mode is <1.4V
5-3	RESERVED	R	0x0	
2	LNA_PD	R/W	0x0	LNA power down
1	SIGPATH_RST	R/W	0x0	Master reset for the signal chain
0	SIGCHAIN_PD	R/W	0x0	Master power down for the signal chain.

7.6.25 R80 Register (Address = 0x50) [reset = 0xA]

 R80 is shown in [Figure 76](#) and described in [Table 33](#).

 Return to [Summary Table](#).

Figure 76. R80 Register

15	14	13	12	11	10	9	8
RESERVED				SYNC_PHASE_MIXLO	SYNC_DRV2_EN	SYNC_DRV1_EN	RESERVED
R-0x0				R/W-0x0	R/W-0x0	R/W-0x0	R-0x0
7	6	5	4	3	2	1	0
RESERVED		LO_MUX					
R-0x0		R/W-0xA					

Table 33. R80 Register Field Descriptions

Bit	Field	Type	Reset	Description
15-12	RESERVED	R	0x0	
11	SYNC_PHASE_MIXLO	R/W	0x0	Sync bit to close the loop from Mixer LO back to synthesizer
10	SYNC_DRV2_EN	R/W	0x0	Enables the SYNC 2nd stage driver from the LO output path. It should be enabled in SYNC mode. 0x0 = Disabled 0x1 = Enabled
9	SYNC_DRV1_EN	R/W	0x0	Enables the SYNC first stage driver from the LO output path. It should be enabled in SYNC mode. 0x0 = Disabled 0x1 = Enabled
8-6	RESERVED	R	0x0	

Table 33. R80 Register Field Descriptions (continued)

Bit	Field	Type	Reset	Description
5-0	LO_MUX	R/W	0xA	Sets up various MUXs and Drivers 0x9 = Internal LO DIV2 Mode 0x10 = Internal LO Poly 48 External LO

7.6.26 R81 Register (Address = 0x51) [reset = 0x0]

R81 is shown in [Figure 77](#) and described in [Table 34](#).

Return to [Summary Table](#).

Figure 77. R81 Register

15	14	13	12	11	10	9	8
RESERVED				LO_POLY_MODE1			
R-0x0				R/W-0x0			
7	6	5	4	3	2	1	0
EXTLO_CLK_DIV_EN		LO_DRV_MODE		RESERVED	EXTLO_CLK_DRV_EN		SM_CLK_SEL
R/W-0x0		R/W-0x0		R-0x0	R/W-0x0		R/W-0x0

Table 34. R81 Register Field Descriptions

Bit	Field	Type	Reset	Description
15-12	RESERVED	R	0x0	
11-8	LO_POLY_MODE1	R/W	0x0	Sets up parameters for the poly path 0x0 = Internal LO Poly 0x15 = External LO 0x19 = Internal LO DIV2
7-6	EXTLO_CLK_DIV_EN	R/W	0x0	Selects driver for SMCLK 0x0 = Internal LO 0x1 = Reserved 0x2 = Reserved 0x3 = External LO
5-4	LO_DRV_MODE	R/W	0x0	Sets up drivers for LO quadrature path 0x0 = Internal LO Poly 0x1 = Internal LO DIV2 0x2 = Reserved 0x3 = External LO
3	RESERVED	R	0x0	
2-1	EXTLO_CLK_DRV_EN	R/W	0x0	Enables drivers for state machine clock.
0	SM_CLK_SEL	R/W	0x0	Selects the state machine clock source for the signal path 0x0 = Internal LO 0x1 = External LO

7.6.27 R82 Register (Address = 0x52) [reset = 0x23]

R82 is shown in [Figure 78](#) and described in [Table 35](#).

Return to [Summary Table](#).

Figure 78. R82 Register

15	14	13	12	11	10	9	8
RESERVED							
R-0x0							
7	6	5	4	3	2	1	0

RESERVED	EXTLO_DIV
R-0x0	R/W-0x23

Table 35. R82 Register Field Descriptions

Bit	Field	Type	Reset	Description
15-6	RESERVED	R	0x0	
5-0	EXTLO_DIV	R/W	0x23	Sets total divide value for the state machine clock when using an external LO. This total divide is the product of two divides, DIVA and DIVB. 0x0 = 1 0x1 = 2 0x2 = 16 0x3 = 8 0x4 = 16 0x5 = 16 0x6 = 64 0x7 = 8

7.6.28 R83 Register (Address = 0x53) [reset = 0x2000]

 R83 is shown in [Figure 79](#) and described in [Table 36](#).

 Return to [Summary Table](#).

Figure 79. R83 Register

15	14	13	12	11	10	9	8
IFA_PULLUP			VCM_CONFIG				RESERVED
R/W-0x1			R/W-0x0				R-0x0
7	6	5	4	3	2	1	0
RESERVED							
R-0x0							

Table 36. R83 Register Field Descriptions

Bit	Field	Type	Reset	Description
15-13	IFA_PULLUP	R/W	0x1	IFA virtual node pull up resistor to set the biasing of the IFA input stage correct when the output common mode is <1.4V. Should be used in conjunction with the corresponding EN bit in first register. 0x2 = Invalid 0x4 = Invalid 0x5 = Invalid 0x6 = Invalid
12-9	VCM_CONFIG	R/W	0x0	Output Common mode (VOCM) configuration for IFA. Only one bit to be set as high at a time. Only valid states are 0,3,5,9. 0x0 = 1.7 0x3 = 2V 0x5 = External 0x9 = 1.4V
8-0	RESERVED	R	0x0	

7.6.29 R84 Register (Address = 0x54) [reset = 0x1900]

 R84 is shown in [Figure 80](#) and described in [Table 37](#).

 Return to [Summary Table](#).

Figure 80. R84 Register

15	14	13	12	11	10	9	8	
DCOC_CLK_DIV								
R/W-0x64								
7	6	5	4	3	2	1	0	
DCOC_CLK_DIV		RESERVED				EN_DCOC_QC_H_LUT	EN_DCOC_IC_H_LUT	
R/W-0x64		R-0x0				R/W-0x0	R/W-0x0	

Table 37. R84 Register Field Descriptions

Bit	Field	Type	Reset	Description
15-6	DCOC_CLK_DIV	R/W	0x64	DCOC clock division controlled
5-2	RESERVED	R	0x0	
1	EN_DCOC_QCH_LUT	R/W	0x0	Enable offset calibration for Q channel. Write 1 to trigger calibration. To re-trigger, clear this bit and then write 1 again.
0	EN_DCOC_ICH_LUT	R/W	0x0	Enable offset calibration for I channel. Write 1 to trigger calibration. To re-trigger, clear this bit and then write 1 again.

7.6.30 R88 Register (Address = 0x58) [reset = 0x0]

R88 is shown in [Figure 81](#) and described in [Table 38](#).

Return to [Summary Table](#).

Figure 81. R88 Register

15	14	13	12	11	10	9	8
RESERVED	rb_DCOC_CAL	RESERVED					
R-0x0	R-0x0	R-0x0					
7	6	5	4	3	2	1	0
RESERVED							
R-0x0							

Table 38. R88 Register Field Descriptions

Bit	Field	Type	Reset	Description
15	RESERVED	R	0x0	
14	rb_DCOC_CAL	R	0x0	Status bit. Indicates whether I channel DC offset calibration is done. 0x0 = Neither Channel Done 1 I Channel Done 0x2 = Q Channel Done 0x3 = Both Channels Done
13-0	RESERVED	R	0x0	

7.6.31 R94 Register (Address = 0x5E) [reset = 0x8080]

R94 is shown in [Figure 82](#) and described in [Table 39](#).

Return to [Summary Table](#).

Figure 82. R94 Register

15	14	13	12	11	10	9	8
IMRR_GCAL_QCH							
R/W-0x80							
7	6	5	4	3	2	1	0
IMRR_GCAL_ICH							
R/W-0x80							

Table 39. R94 Register Field Descriptions

Bit	Field	Type	Reset	Description
15-8	IMRR_GCAL_QCH	R/W	0x80	IMRR gain control for the Q channel.
7-0	IMRR_GCAL_ICH	R/W	0x80	IMRR gain control for the I channel.

7.6.32 R95 Register (Address = 0x5F) [reset = X]

 R95 is shown in [Figure 83](#) and described in [Table 40](#).

 Return to [Summary Table](#).

Figure 83. R95 Register

7	6	5	4	3	2	1	0
RESERVED							
R-0x0							

Table 40. R95 Register Field Descriptions

Bit	Field	Type	Reset	Description
15	IMRR_PHCAL_POL	R/W	X	IMRR Phase polarity control using the phase interpolator.
14-9	IMRR_PHCAL	R/W	X	IMRR Phase control using the phase interpolator. Preferred method of the IMRR phase correction.
8	LODRV_IMRR_PHCAL_P OLCTRL	R/W	X	IMRR Phase polarity control using the slew control driver.
7-0	RESERVED	R	0x0	

7.6.33 R103 Register (Address = 0x67) [reset = X]

 R103 is shown in [Figure 84](#) and described in [Table 41](#).

 Return to [Summary Table](#).

Figure 84. R103 Register

7	6	5	4	3	2	1	0
RESERVED							
R-0x0							

Table 41. R103 Register Field Descriptions

Bit	Field	Type	Reset	Description
13-10	LO_POLY_MODE2	R/W	X	Selects configurations between Poly and DIV2 Mode
9-0	RESERVED	R	0x0	

7.6.34 R110 Register (Address = 0x6E) [reset = X]

 R110 is shown in [Figure 85](#) and described in [Table 42](#).

 Return to [Summary Table](#).

Figure 85. R110 Register

7	6	5	4	3	2	1	0
rb_VCO_SEL			RESERVED				
R-0x0			R-0x0				

Table 42. R110 Register Field Descriptions

Bit	Field	Type	Reset	Description
10-9	rb_LD_VTUNE	R	X	Readback word for the PLL lock status 0x0 = Unlock (Fvco Low) 0x1 = Invalid 0x2 = PLL Locked 0x3 = Unlock (Fvco High)
8	RESERVED	R	X	
7-5	rb_VCO_SEL	R	0x0	Reads back the VCO core selected. 0x0 = Invalid 0x1 = VCO1 0x2 = VCO2 0x3 = VCO3 0x4 = VCO4 0x5 = VCO5 0x6 = VCO6 0x7 = VCO7
4-0	RESERVED	R	0x0	

7.6.35 R111 Register (Address = 0x6F) [reset = 0x0]

R111 is shown in [Figure 86](#) and described in [Table 43](#).

Return to [Summary Table](#).

Figure 86. R111 Register

7	6	5	4	3	2	1	0
rb_VCO_CAPCTRL							
R-0x0							

Table 43. R111 Register Field Descriptions

Bit	Field	Type	Reset	Description
7-0	rb_VCO_CAPCTRL	R	0x0	Readback word for the actual value of VCO_CAPCTRL chosen by the VCO frequency calibration.

7.6.36 R112 Register (Address = 0x70) [reset = 0x0]

R112 is shown in [Figure 87](#) and described in [Table 44](#).

Return to [Summary Table](#).

Figure 87. R112 Register

7	6	5	4	3	2	1	0
rb_VCO_DACISSET							
R-0x0							

Table 44. R112 Register Field Descriptions

Bit	Field	Type	Reset	Description
8-0	rb_VCO_DACISSET	R	0x0	Readback word for the actual value of VCO_DACISSET chosen by the VCO amplitude calibration.

7.6.37 R121 Register (Address = 0x79) [reset = 0x0]

 R121 is shown in [Figure 88](#) and described in [Table 45](#).

 Return to [Summary Table](#).

Figure 88. R121 Register

7	6	5	4	3	2	1	0
RESERVED		BIAS_LNA_CUR_CONFIG_2		RESERVED			
R-0x0		R/W-0x0		R-0x0			

Table 45. R121 Register Field Descriptions

Bit	Field	Type	Reset	Description
7	RESERVED	R	0x0	
6-5	BIAS_LNA_CUR_CONFIG_2	R/W	0x0	
4-0	RESERVED	R	0x0	

7.6.38 R123 Register (Address = 0x7B) [reset = 0x3]

 R123 is shown in [Figure 89](#) and described in [Table 46](#).

 Return to [Summary Table](#).

Figure 89. R123 Register

7	6	5	4	3	2	1	0
RESERVED						EXTLO_INT_MATCH_RES	
R-0x0						R/W-0x3	

Table 46. R123 Register Field Descriptions

Bit	Field	Type	Reset	Description
7-2	RESERVED	R	0x0	
1-0	EXTLO_INT_MATCH_RES	R/W	0x3	Control internal resistor termination at EXTLO input pin 0x0 = No termination 0x1 = 200 Ohms differential termination 0x2 = Same as 1 0x3 = 100 Ohms differential termination

7.6.39 R126 Register (Address = 0x7E) [reset = X]

 R126 is shown in [Figure 90](#) and described in [Table 47](#).

 Return to [Summary Table](#).

Figure 90. R126 Register

7	6	5	4	3	2	1	0
RESERVED							
R-0x0							

Table 47. R126 Register Field Descriptions

Bit	Field	Type	Reset	Description
15	IMRR_PHCAL_EXTEND	R/W	X	Increase the range of the IMRR phase interpolator DAC by 2x
14-9	RESERVED	R	X	
8	DCOC_FSM_RST	R/W	X	Reset DC offset
7-0	RESERVED	R	0x0	

8 Application and Implementation

注

Information in the following applications sections is not part of the TI component specification, and TI does not warrant its accuracy or completeness. TI's customers are responsible for determining suitability of components for their purposes. Customers should validate and test their design implementation to confirm system functionality.

8.1 Application Information

Typical Application shows a typical usage of the LMX8410L with internal synthesizer and shows the basic components needed for the operation of the device. There is also guidance on how to design the loop external loop filter which is part of the LMX8410L synthesizer. The PLLatinum Sim is a tool that allows users to enter the information regarding the input reference and target LO frequency they need and simulate the expected phase noise and performance parameters for the synthesizer.

8.2 Typical Application



图 91. Typical Application Schematic

8.2.1 Design Requirements

The design of the loop filter is complex and is typically done with software. The PLLatinum Sim software is an excellent resource for doing this and the design is shown in the following figure. For those interested in the equations involved, the PLL Performance, Simulation, and Design Handbook listed in the end of this document goes into great detail as to theory and design of PLL loop filters. PLLatinum Sim does not model the mixers and LNAs in this device, but it can be used for the PLL. To use this tool, it can be modeled as the LMX2594 PLL.

Typical Application (接下页)

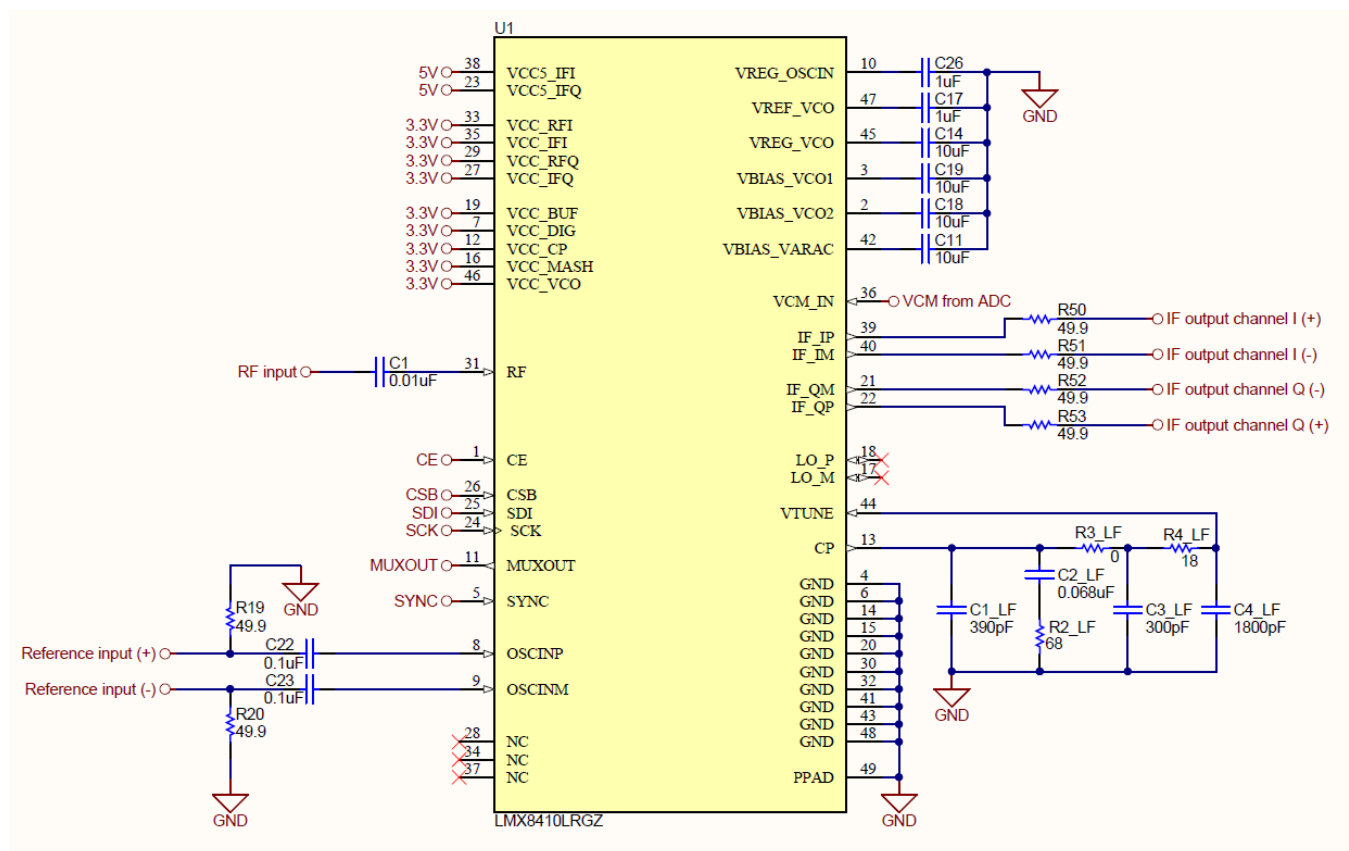
8.2.2 Detailed Design Procedure

The integration of phase noise over a certain bandwidth (jitter) is an performance specification that translates to signal-to-noise ratio. Phase noise inside the loop bandwidth is dominated by the PLL, while the phase noise outside the loop bandwidth is dominated by the VCO. Generally, jitter is lowest if loop bandwidth is designed to the point where the two intersect. A higher phase margin loop filter design has less peaking at the loop bandwidth and thus lower jitter. The tradeoff with this is that longer lock times and spurs must be considered in design as well.

As for software programming, it is highly recommended to use the TICSPRO software. In addition to simplifying the process, it also gives the user recommended programming default values for the undisclosed registers not mentioned in the datasheet.



图 92. PLLatinum Sim Design Example

Typical Application (接下页)

8.2.3 Application Curve

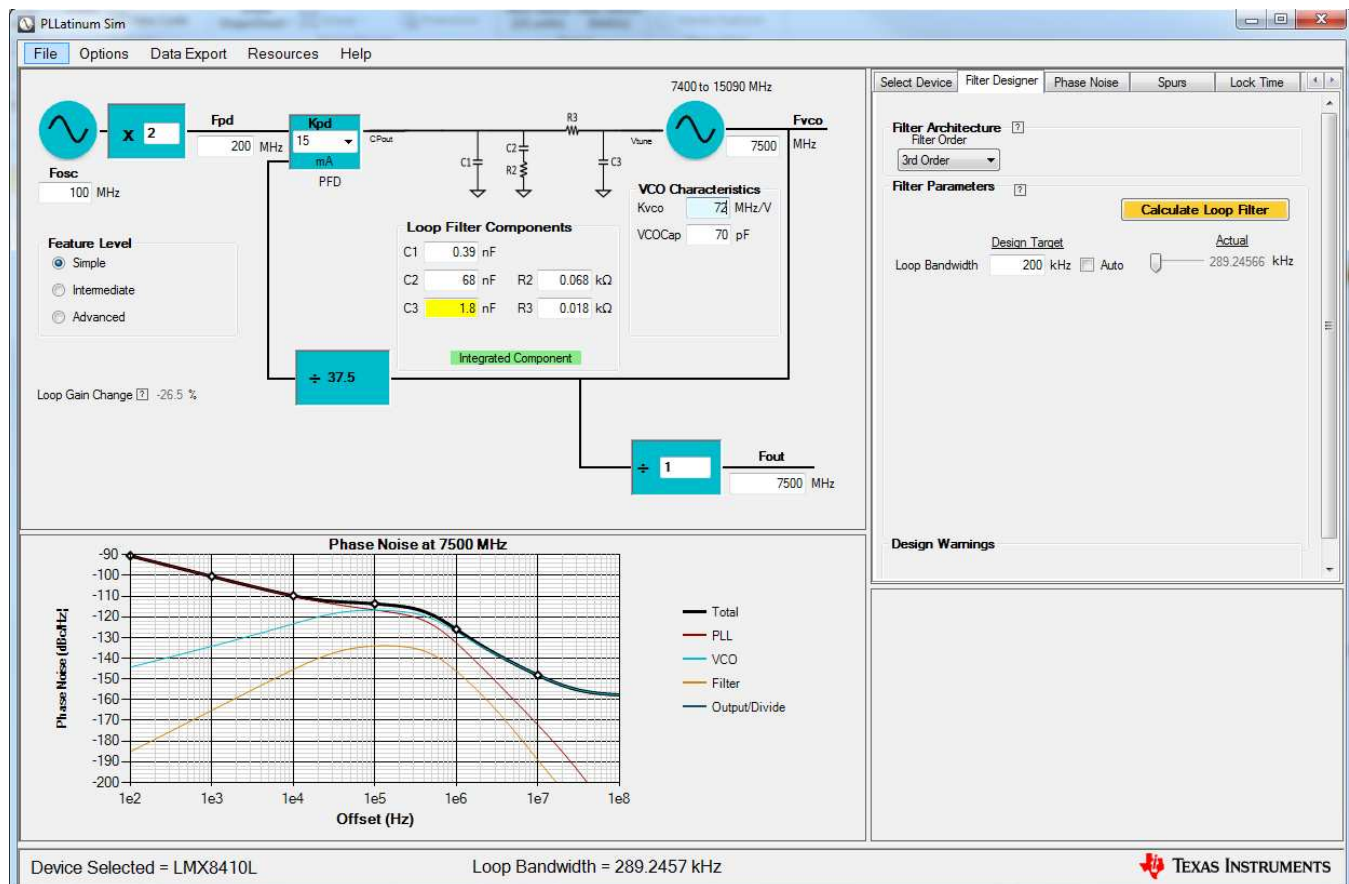
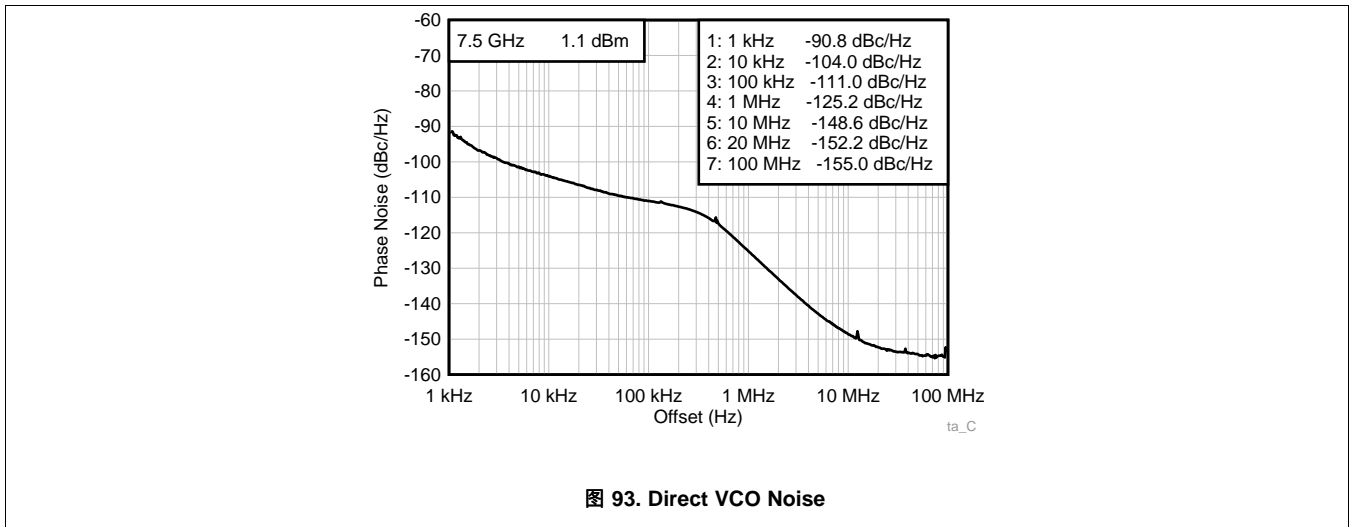

9 Power Supply Recommendations

1. Design 5-V supply to be capable of greater than 200 mA.
2. Design 3.3-V supply to be capable of greater than 800 mA.
3. Supply to channel I and Q sides must be well matched and isolated from one another. Recommend using ferrite beads in series to the pin. The I and Q supplies are for IF amplifier (at pin 38 and 23), for RF input (at pin 33 and 29), and for IF path circuitry (at pin 35 and 27).
4. Pins 7 and 16 are supplies for digital circuitry, and they can have extra isolation in this path (TI recommends using ferrite bead in series to the pin).
5. Pins 12, 19, and 46 are supplies for the internal synthesizer; designer must take care not to have noise sources that can couple to it nearby.
6. Typically use 0.1- μ F capacitors near the pins. Add extra capacitance values at specific frequencies if known interfering frequencies in system. See [Pin Configuration and Functions](#) for more recommendations on component value recommendations.

10 Layout

10.1 Layout Guidelines

Generally, there are two major focuses of layout guidelines: high frequency signals and power routing.

10.1.1 High Frequency Trace Routing

- Design all traces for matched impedance. The single-ended RF trace must be controlled for 50- Ω impedance, while the differential OSCIN, LO, and IF traces must be controlled for 100- Ω differential impedance.
- Run an uninterrupted ground plane beneath all impedance-controlled traces. No other currents should flow directly under the controlled impedance traces.
- Keep high-frequency traces as short as possible to minimize losses, or potential for cross-coupling.
- Controlled impedance can be challenging in materials not designed for RF applications. For example, standard FR-4 has a wide range of acceptable dielectric constants in practice. Although the constants seen in boards from the same panel or material lot code may match very well, this does not ensure that the constants match between different lots or different dielectric manufacturers. Furthermore, FR-4 has a high loss tangent compared to many other materials, which can result in much greater attenuation of high frequency signals across the same distances. TI recommends the use of materials designed specifically for high-frequency use, such as RO4350B or RO4003C from Rogers Corporation.
- The RF pin is surrounded on three sides by ground pins to assist in the creation of a coplanar waveguide structure. Design the coplanar waveguide to minimize current flow on the ground traces around the pins.
- The IF outputs are low impedance, and require resistors to set the output impedance.
- The LO pins are capacitively coupled as inputs, with internal 50- Ω termination. Use 50- Ω pullup resistors to VCC_BUF to bias these pins as inputs, if driven through external capacitors. The LO pins require 50- Ω pullup resistors to VCC_BUF as outputs.
- The LO pins are located very close to the Q-channel IF pins, and the LO buffer supply is located between these two ports. Placing a bypass capacitor as close as possible to the LO buffer is recommended for proper operation, but this presents a potential problem: vias to VCC and GND must be routed between the differential pairs. Because the high frequency currents in the bypass capacitor and the LO buffer circuit tend to follow the loop with the lowest inductance, and since the VCC via interrupts the path from capacitor ground to IC ground on the plane layer immediately below the top, ground currents tend to travel around this via, in the path of the LO and IF coupling to the plane layer. To maintain the signal integrity of both the LO and IF differential traces, no other currents should be flowing immediately below them on the plane layer. Therefore, the LO bypass capacitor ground via must not connect to the plane layer immediately below the capacitor. TI recommends connecting through the subsequent layer. See the Layout Example section on how this is done.

Layout Guidelines (接下页)

10.1.2 Power Trace Routing

- Regardless of whether the part is used in internal or external LO mode, all synthesizer VCC and GND pins must be connected properly. If VCC and GND pins are not connected on the synthesizer, the internal power-up procedure may not execute properly. Noise may also be coupled into the mixer from the synthesizer circuitry if power and ground are not properly connected.
- Place bypass capacitors, whenever possible, to minimize the inductance of the current loop formed by the capacitor and the IC. Placing the bypass capacitors on the same surface as the IC allows one terminal to be connected closely to the IC, minimizing this loop. The ground connection can also be made low-inductance by placing a ground via to a plane layer immediately below. Placing capacitors on the opposite surface substantially limits the effective frequencies they can bypass, since the current must travel through two vias. The loop area formed by placing a capacitor on the opposite surface is almost always larger than the loop area formed by placing a capacitor on the same surface.
- Consider the path that ground currents will take. For optimal performance, supply and bypass capacitor currents must not flow underneath high-frequency traces.
- Use as many ground vias as possible to connect the IC pad to the ground plane. This is required for optimal thermal performance.
- Connect ground pins back to the pad. Aside from routing convenience, the inductance through the bond wires tends to be very high, and the inductance through the ground pad tends to be very low.
- Avoid connecting different VCC pins in such a way that the current paths overlap. Overlapping current paths can inject common-mode noise into the supply pins, degrading performance.

10.2 Layout Examples



图 94. Top Layer

Layout Examples (接下页)



图 95. Ground Layer 1

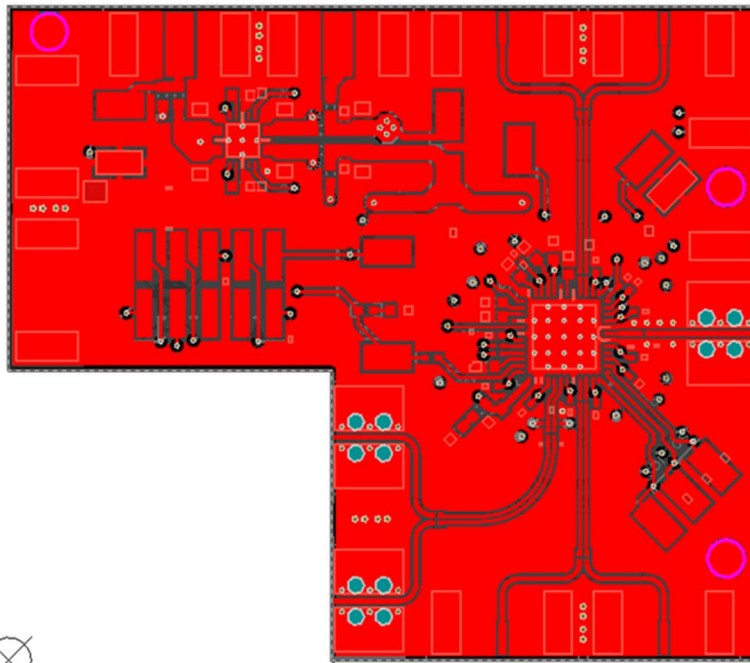

图 96. Mid Layer 1

Layout Examples (接下页)

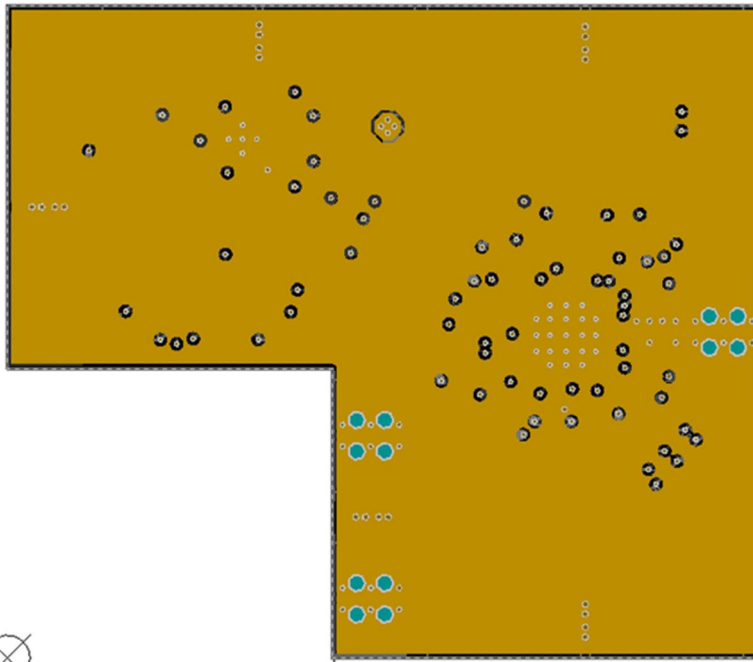

图 97. Mid Layer 2

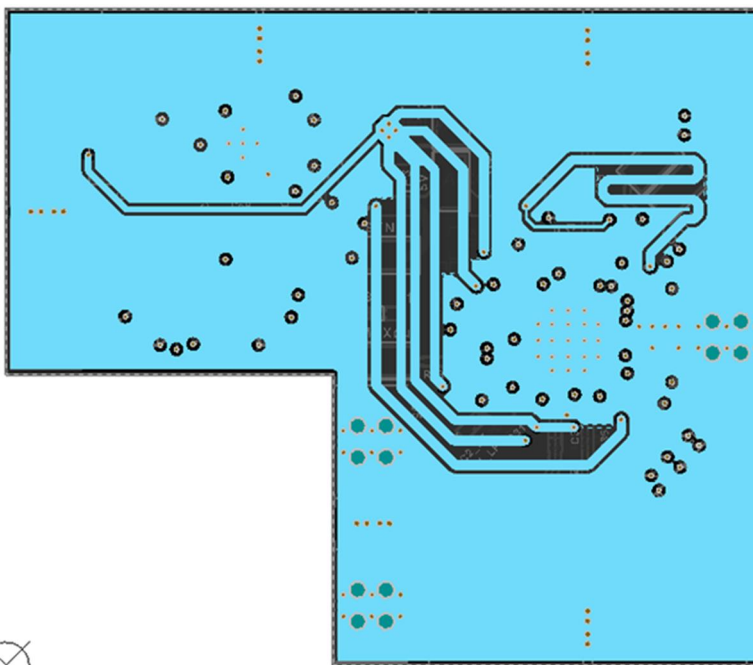

图 98. Mid Layer 3

Layout Examples (接下页)

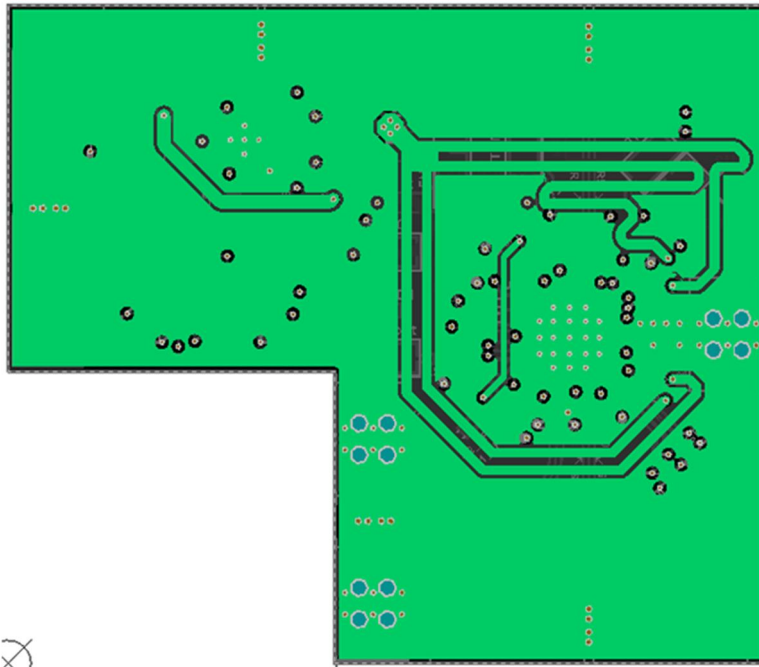

图 99. Bottom Layer

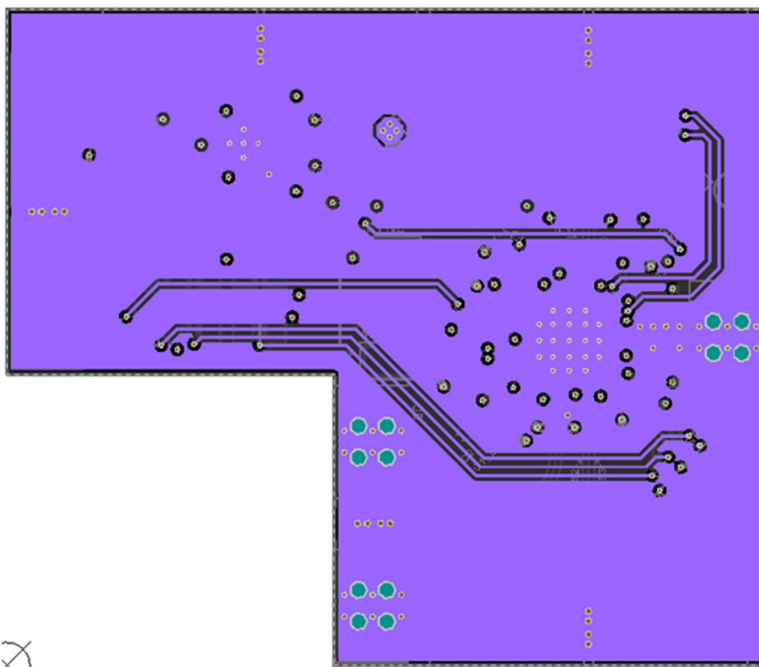
11 器件和文档支持

11.1 文档支持

11.1.1 相关文档

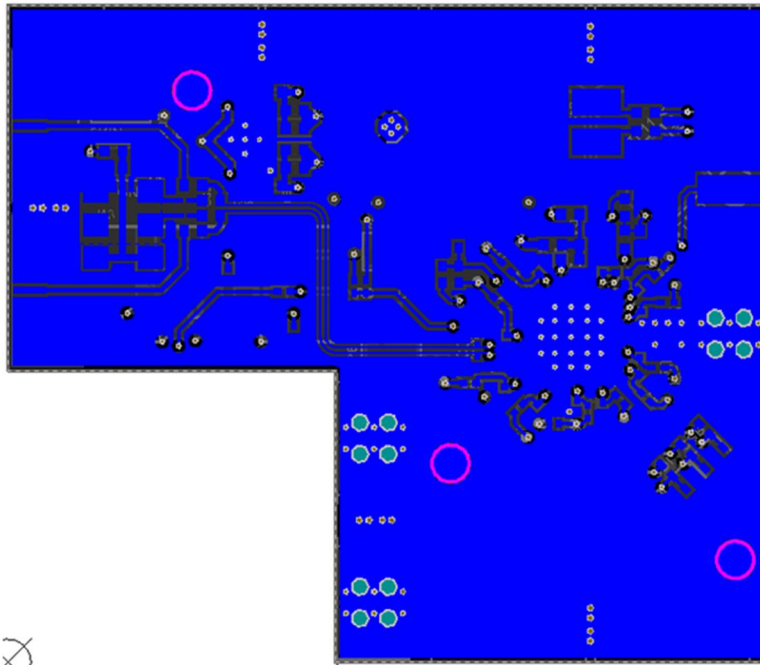
请参阅如下相关文档：

[《LMX8410LEVM 用户指南》](#)

11.2 接收文档更新通知

要接收文档更新通知，请导航至 TI.com.cn 上的器件产品文件夹。单击右上角的 [通知我](#) 进行注册，即可每周接收产品信息更改摘要。有关更改的详细信息，请查看任何已修订文档中包含的修订历史记录。

11.3 社区资源

下列链接提供到 TI 社区资源的连接。链接的内容由各个分销商“按照原样”提供。这些内容并不构成 TI 技术规范，并且不一定反映 TI 的观点；请参阅 TI 的 [《使用条款》](#)。

TI E2E™ 在线社区 [TI 的工程师对工程师 \(E2E\) 社区](#)。此社区的创建目的在于促进工程师之间的协作。在 e2e.ti.com 中，您可以咨询问题、分享知识、拓展思路并与同行工程师一道帮助解决问题。

设计支持 [TI 参考设计支持](#) 可帮助您快速查找有帮助的 E2E 论坛、设计支持工具以及技术支持的联系信息。

11.4 商标

E2E is a trademark of Texas Instruments.

Narda-MITEQ is a trademark of L3 Narda-MITEQ.

Mini-Circuits is a trademark of Mini-Circuits.

PPM-Test is a trademark of Pulse Power & Measurement Ltd..

All other trademarks are the property of their respective owners.

11.5 静电放电警告



ESD 可能会损坏该集成电路。德州仪器 (TI) 建议通过适当的预防措施处理所有集成电路。如果不遵守正确的处理措施和安装程序，可能会损坏集成电路。

ESD 的损坏小至导致微小的性能降级，大至整个器件故障。精密的集成电路可能更容易受到损坏，这是因为非常细微的参数更改都可能会导致器件与其发布的规格不相符。

11.6 术语表

[SLYZ022](#) — *TI 术语表*。

这份术语表列出并解释术语、缩写和定义。

12 机械、封装和可订购信息

以下页面包含机械、封装和可订购信息。这些信息是指定器件的最新可用数据。数据如有变更，恕不另行通知，且不会对此文档进行修订。如需获取此产品说明书的浏览器版本，请查阅左侧的导航栏。

PACKAGING INFORMATION

Orderable Device	Status (1)	Package Type	Package Drawing	Pins	Package Qty	Eco Plan (2)	Lead finish/ Ball material (6)	MSL Peak Temp (3)	Op Temp (°C)	Device Marking (4/5)	Samples
LMX8410RGZR	ACTIVE	VQFN	RGZ	48	1000	RoHS & Green	NIPDAUAG	Level-3-260C-168 HR	-40 to 85	LMX8410	Samples
LMX8410RGZT	ACTIVE	VQFN	RGZ	48	250	RoHS & Green	NIPDAUAG	Level-3-260C-168 HR	-40 to 85	LMX8410	Samples

(1) The marketing status values are defined as follows:

ACTIVE: Product device recommended for new designs.

LIFEBUY: TI has announced that the device will be discontinued, and a lifetime-buy period is in effect.

NRND: Not recommended for new designs. Device is in production to support existing customers, but TI does not recommend using this part in a new design.

PREVIEW: Device has been announced but is not in production. Samples may or may not be available.

OBSOLETE: TI has discontinued the production of the device.

(2) **RoHS:** TI defines "RoHS" to mean semiconductor products that are compliant with the current EU RoHS requirements for all 10 RoHS substances, including the requirement that RoHS substance do not exceed 0.1% by weight in homogeneous materials. Where designed to be soldered at high temperatures, "RoHS" products are suitable for use in specified lead-free processes. TI may reference these types of products as "Pb-Free".

RoHS Exempt: TI defines "RoHS Exempt" to mean products that contain lead but are compliant with EU RoHS pursuant to a specific EU RoHS exemption.

Green: TI defines "Green" to mean the content of Chlorine (Cl) and Bromine (Br) based flame retardants meet JS709B low halogen requirements of <=1000ppm threshold. Antimony trioxide based flame retardants must also meet the <=1000ppm threshold requirement.

(3) MSL, Peak Temp. - The Moisture Sensitivity Level rating according to the JEDEC industry standard classifications, and peak solder temperature.

(4) There may be additional marking, which relates to the logo, the lot trace code information, or the environmental category on the device.

(5) Multiple Device Markings will be inside parentheses. Only one Device Marking contained in parentheses and separated by a "~" will appear on a device. If a line is indented then it is a continuation of the previous line and the two combined represent the entire Device Marking for that device.

(6) Lead finish/Ball material - Orderable Devices may have multiple material finish options. Finish options are separated by a vertical ruled line. Lead finish/Ball material values may wrap to two lines if the finish value exceeds the maximum column width.

Important Information and Disclaimer:The information provided on this page represents TI's knowledge and belief as of the date that it is provided. TI bases its knowledge and belief on information provided by third parties, and makes no representation or warranty as to the accuracy of such information. Efforts are underway to better integrate information from third parties. TI has taken and continues to take reasonable steps to provide representative and accurate information but may not have conducted destructive testing or chemical analysis on incoming materials and chemicals. TI and TI suppliers consider certain information to be proprietary, and thus CAS numbers and other limited information may not be available for release.

In no event shall TI's liability arising out of such information exceed the total purchase price of the TI part(s) at issue in this document sold by TI to Customer on an annual basis.

TAPE AND REEL INFORMATION

QUADRANT ASSIGNMENTS FOR PIN 1 ORIENTATION IN TAPE

*All dimensions are nominal

Device	Package Type	Package Drawing	Pins	SPQ	Reel Diameter (mm)	Reel Width W1 (mm)	A0 (mm)	B0 (mm)	K0 (mm)	P1 (mm)	W (mm)	Pin1 Quadrant
LMX8410RGZR	VQFN	RGZ	48	1000	330.0	16.4	7.3	7.3	1.3	12.0	16.0	Q2
LMX8410RGZT	VQFN	RGZ	48	250	178.0	16.4	7.3	7.3	1.3	12.0	16.0	Q2

TAPE AND REEL BOX DIMENSIONS

*All dimensions are nominal

Device	Package Type	Package Drawing	Pins	SPQ	Length (mm)	Width (mm)	Height (mm)
LMX8410RGZR	VQFN	RGZ	48	1000	356.0	356.0	35.0
LMX8410RGZT	VQFN	RGZ	48	250	208.0	191.0	35.0

GENERIC PACKAGE VIEW

RGZ 48

VQFN - 1 mm max height

7 x 7, 0.5 mm pitch

PLASTIC QUADFLAT PACK- NO LEAD



Images above are just a representation of the package family, actual package may vary.
Refer to the product data sheet for package details.

4224671/A

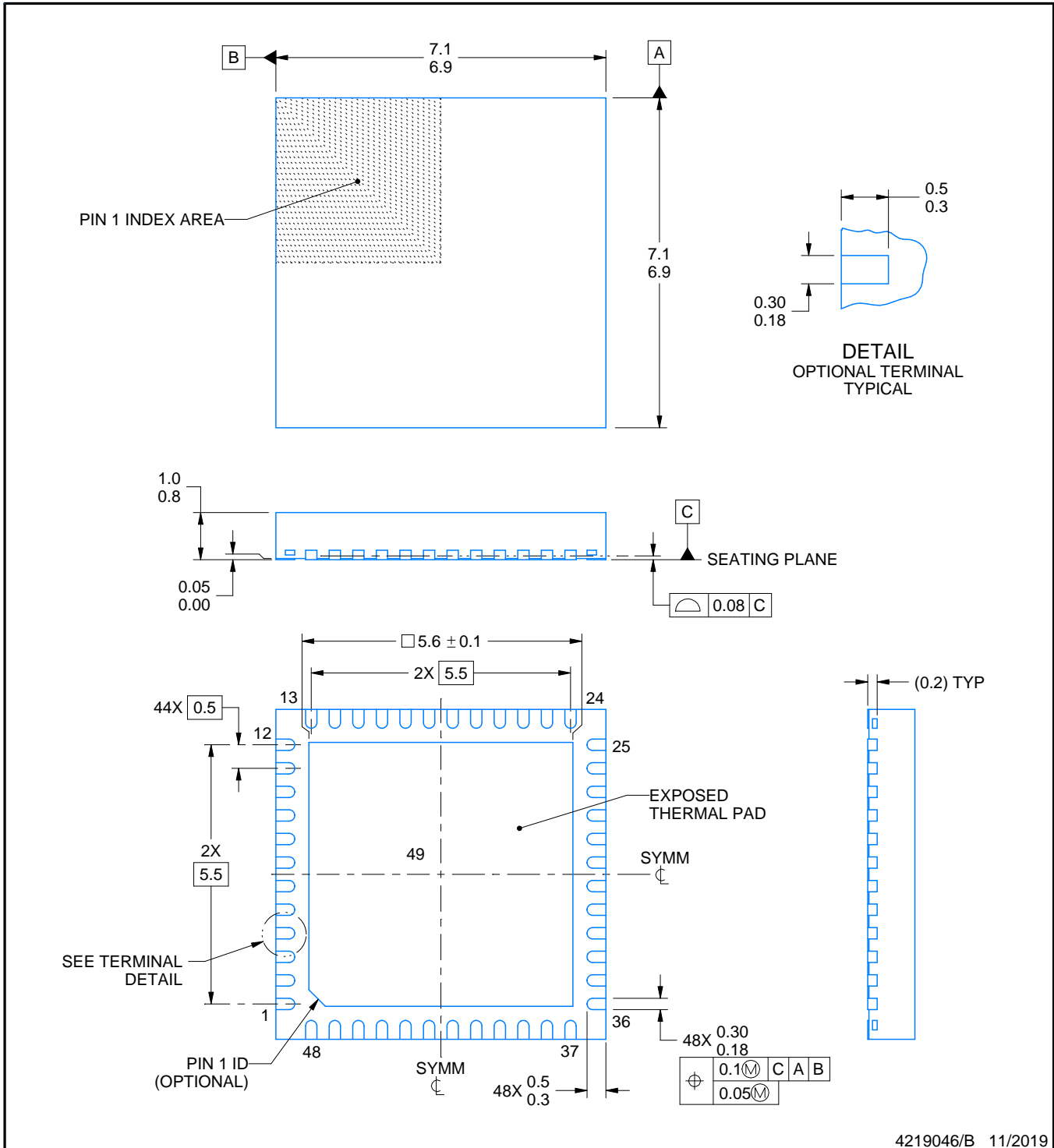
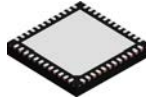

4219046/B 11/2019

NOTES:

1. All linear dimensions are in millimeters. Any dimensions in parenthesis are for reference only. Dimensioning and tolerancing per ASME Y14.5M.
2. This drawing is subject to change without notice.
3. The package thermal pad must be soldered to the printed circuit board for thermal and mechanical performance.

EXAMPLE BOARD LAYOUT

RGZ0048D

VQFN - 1 mm max height

PLASTIC QUAD FLATPACK - NO LEAD

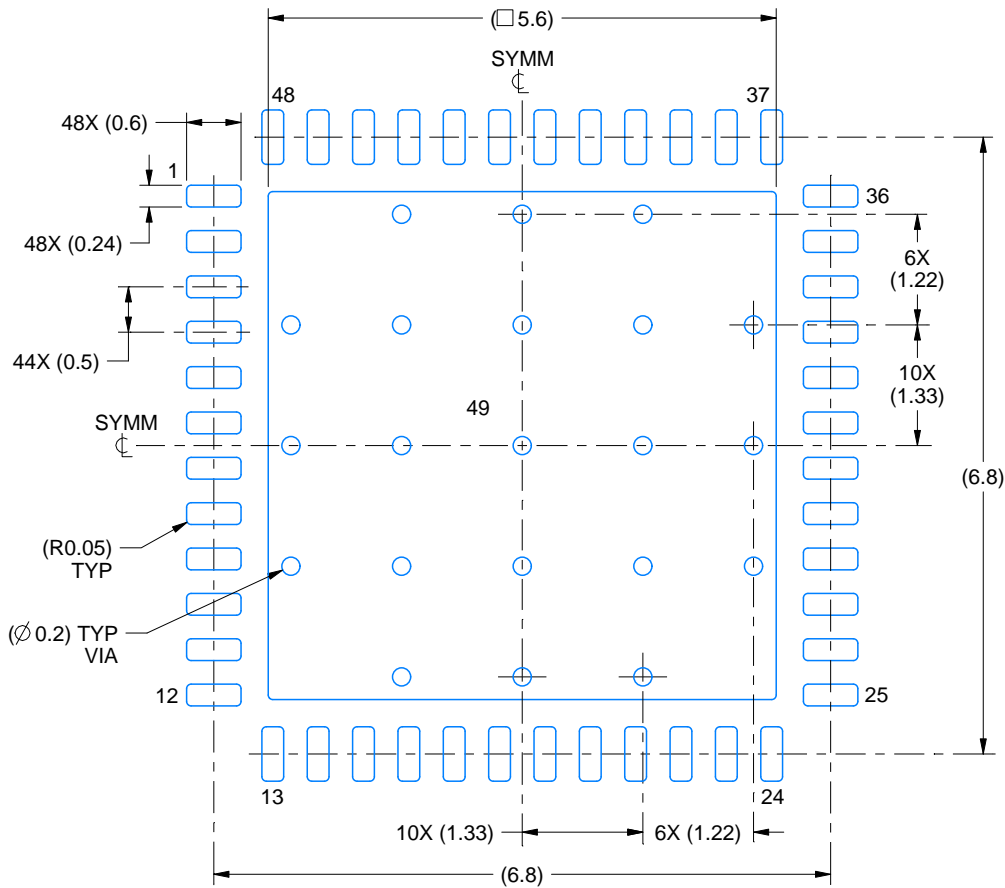

LAND PATTERN EXAMPLE
EXPOSED METAL SHOWN
SCALE:12X

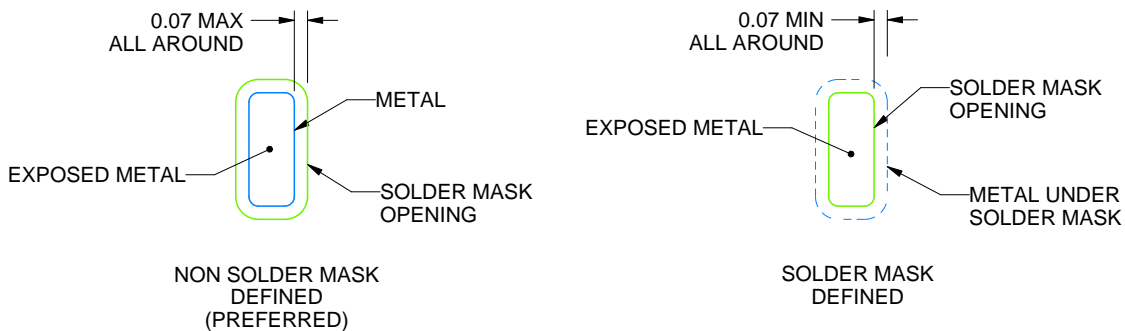

SOLDER MASK DETAILS

4219046/B 11/2019

NOTES: (continued)

- This package is designed to be soldered to a thermal pad on the board. For more information, see Texas Instruments literature number SLUA271 (www.ti.com/lit/sluea271).
- Vias are optional depending on application, refer to device data sheet. If any vias are implemented, refer to their locations shown on this view. It is recommended that vias under paste be filled, plugged or tented.

EXAMPLE STENCIL DESIGN

RGZ0048D

VQFN - 1 mm max height

PLASTIC QUAD FLATPACK - NO LEAD

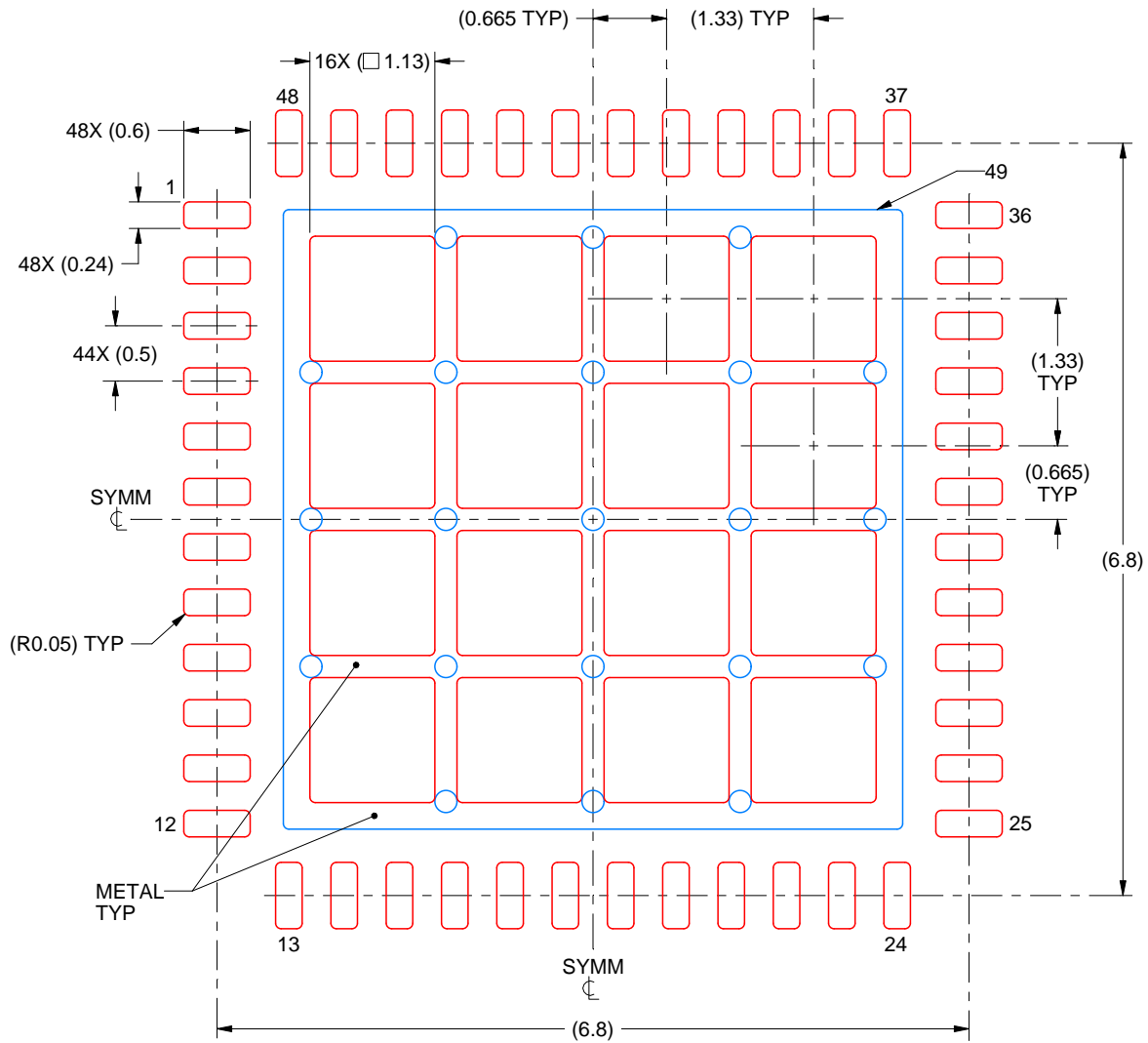

SOLDER PASTE EXAMPLE
 BASED ON 0.125 mm THICK STENCIL

EXPOSED PAD 49
 66% PRINTED SOLDER COVERAGE BY AREA UNDER PACKAGE
 SCALE:15X

4219046/B 11/2019

NOTES: (continued)

6. Laser cutting apertures with trapezoidal walls and rounded corners may offer better paste release. IPC-7525 may have alternate design recommendations.

重要声明和免责声明

TI“按原样”提供技术和可靠性数据（包括数据表）、设计资源（包括参考设计）、应用或其他设计建议、网络工具、安全信息和其他资源，不保证没有瑕疵且不做任何明示或暗示的担保，包括但不限于对适销性、某特定用途方面的适用性或不侵犯任何第三方知识产权的暗示担保。

这些资源可供使用 TI 产品进行设计的熟练开发人员使用。您将自行承担以下全部责任：(1) 针对您的应用选择合适的 TI 产品，(2) 设计、验证并测试您的应用，(3) 确保您的应用满足相应标准以及任何其他功能安全、信息安全、监管或其他要求。

这些资源如有变更，恕不另行通知。TI 授权您仅可将这些资源用于研发本资源所述的 TI 产品的应用。严禁对这些资源进行其他复制或展示。您无权使用任何其他 TI 知识产权或任何第三方知识产权。您应全额赔偿因在这些资源的使用中对 TI 及其代表造成的任何索赔、损害、成本、损失和债务，TI 对此概不负责。

TI 提供的产品受 [TI 的销售条款](#) 或 [ti.com](#) 上其他适用条款/TI 产品随附的其他适用条款的约束。TI 提供这些资源并不会扩展或以其他方式更改 TI 针对 TI 产品发布的适用的担保或担保免责声明。

TI 反对并拒绝您可能提出的任何其他或不同的条款。

邮寄地址：Texas Instruments, Post Office Box 655303, Dallas, Texas 75265

Copyright © 2022，德州仪器 (TI) 公司