

SN74LVC2G00 Dual 2-Input Positive-NAND Gate

1 Features

- Available in the Texas Instruments NanoFree™ Package
- Supports 5-V V_{CC} Operation
- Inputs Accept Voltages to 5.5 V
- Max t_{pd} of 4.3 ns at 3.3 V
- Low Power Consumption, 10- μ A Max I_{CC}
- ± 24 -mA Output Drive at 3.3 V
- Typical V_{OLP} (Output Ground Bounce) < 0.8 V at $V_{CC} = 3.3$ V, $T_A = 25^\circ\text{C}$
- Typical V_{OHV} (Output V_{OH} Undershoot) > 2 V at $V_{CC} = 3.3$ V, $T_A = 25^\circ\text{C}$
- I_{off} Supports Live Insertion, Partial Power Down Mode, and Back Drive Protection
- Latch-Up Performance Exceeds 100 mA Per JESD 78, Class II
- ESD Protection Exceeds JESD 22
 - 2000-V Human-Body Model
 - 1000-V Charged-Device Model

2 Applications

- IP Phones: Wired and Wireless
- Optical Modules
- Optical Networking: EPON and Video Over Fiber
- Point-to-Point Microwave Backhaul
- Power: Telecom DC/DC Module: Analog and Digital
- Private Branch Exchanges (PBX)
- TETRA Base Exchanges
- Telecom Base Band Units
- Telecom Shelters: Power Distribution Units (PDU), Power Monitoring Units (PMU), Wireless Battery Monitoring, Remote Electrical Tilt Units (RET), Remote Radio Units (RRU), Tower Mounted Amplifiers (TMA)
- Vector Signal Analyzers and Generators
- Video Conferencing: IP-Based HD
- WiMAX and Wireless Infrastructure Equipment
- Wireless Communications Testers and Wireless Repeaters
- xDSL Modems and DSLAM

3 Description

This dual 2-input positive-NAND gate is designed for 1.65-V to 5.5-V V_{CC} operation.

The SN74LVC2G00 device performs the Boolean function $Y = \overline{A \times B}$ or $Y = \overline{A} + \overline{B}$ in positive logic.

NanoFree™ package technology is a major breakthrough in IC packaging concepts, using the die as the package.

This device is fully specified for partial-power-down applications using I_{off} . The I_{off} circuitry disables the outputs, preventing damaging current backflow through the device when it is powered down.

Device Information⁽¹⁾

PART NUMBER	PACKAGE	BODY SIZE (NOM)
SN74LVC2G00	SM8 (8)	2.95 mm x 2.80 mm
	US8 (8)	2.30 mm x 2.00 mm
	DSBGA (8)	1.91 mm x 0.91 mm

(1) For all available packages, see the orderable addendum at the end of the data sheet.

4 Simplified Schematic

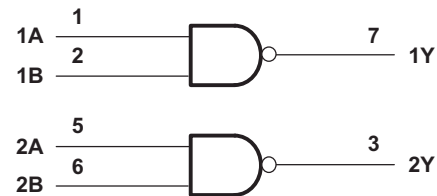

Table of Contents

1 Features	1	9 Detailed Description	9
2 Applications	1	9.1 Overview	9
3 Description	1	9.2 Functional Block Diagram	9
4 Simplified Schematic	1	9.3 Feature Description	9
5 Revision History	2	9.4 Device Functional Modes	9
6 Pin Configuration and Functions	3	10 Application and Implementation	10
7 Specifications	4	10.1 Application Information	10
7.1 Absolute Maximum Ratings	4	10.2 Typical Application	10
7.2 ESD Ratings	4	11 Power Supply Recommendations	11
7.3 Recommended Operating Conditions	5	12 Layout	12
7.4 Thermal Information	5	12.1 Layout Guidelines	12
7.5 Electrical Characteristics	6	12.2 Layout Example	12
7.6 Electrical Characteristics (Continued)	6	13 Device and Documentation Support	12
7.7 Switching Characteristics, -40°C to 85°C	6	13.1 Trademarks	12
7.8 Switching Characteristics, -40°C to 125°C	6	13.2 Electrostatic Discharge Caution	12
7.9 Typical Characteristics	7	13.3 Glossary	12
8 Parameter Measurement Information	8	14 Mechanical, Packaging, and Orderable Information	12

5 Revision History

Changes from Revision M (November 2013) to Revision N

Page

- Added *Applications*, *Device Information* table, *Pin Functions* table, *ESD Ratings* table, *Thermal Information* table, *Typical Characteristics*, *Feature Description* section, *Device Functional Modes*, *Application and Implementation* section, *Power Supply Recommendations* section, *Layout* section, *Device and Documentation Support* section, and *Mechanical, Packaging, and Orderable Information* section. 1
- Deleted *Ordering Information* table. 1

Changes from Revision L (January 2007) to Revision M

Page

- Updated document to new TI data sheet format. 1
- Updated operating temperature range in *Recommended Operating Conditions* table. 5
- Added ESD warning. 12

6 Pin Configuration and Functions

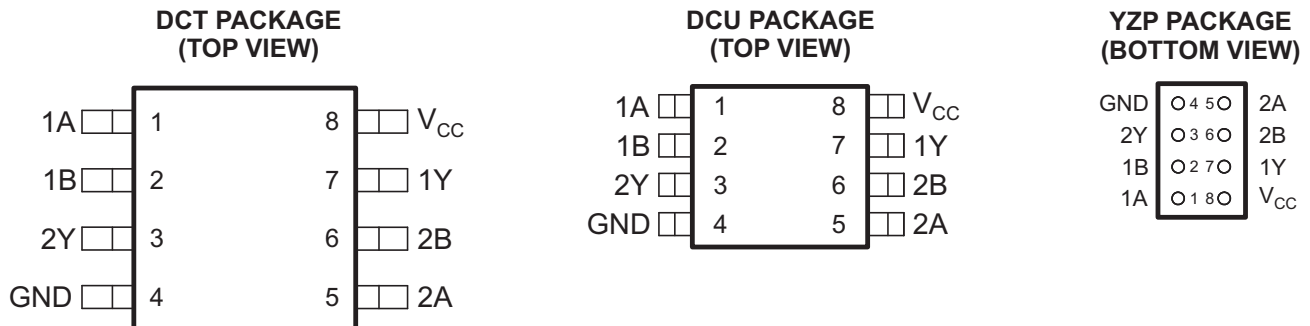

See mechanical drawings for dimensions.

Pin Functions

PIN		TYPE	DESCRIPTION
NAME	DCT, DCU, YZP		
1A	1	I	A input for gate 1
1B	2	I	B input for gate 1
2Y	3	O	Output for gate 2
GND	4	—	Ground
2A	5	I	A input for gate 2
2B	6	I	B input for gate 2
1Y	7	O	Output for gate 1
V _{CC}	8	I	Power input.

7 Specifications

7.1 Absolute Maximum Ratings

over operating free-air temperature range (unless otherwise noted)⁽¹⁾

		MIN	MAX	UNIT
V_{CC}	Supply voltage range	-0.5	6.5	V
V_I	Input voltage range ⁽²⁾	-0.5	6.5	V
V_O	Voltage range applied to any output in the high-impedance or power-off state ⁽²⁾	-0.5	6.5	V
V_O	Voltage range applied to any output in the high or low state ⁽²⁾⁽³⁾	-0.5	$V_{CC} + 0.5$	V
I_{IK}	Input clamp current	$V_I < 0$	-50	mA
I_{OK}	Output clamp current	$V_O < 0$	-50	mA
I_O	Continuous output current		±50	mA
	Continuous current through V_{CC} or GND		±100	mA
T_{stg}	Storage temperature range	-65	150	°C

- (1) Stresses beyond those listed under *Absolute Maximum Ratings* may cause permanent damage to the device. These are stress ratings only, and functional operation of the device at these or any other conditions beyond those indicated under *Recommended Operating Conditions* is not implied. Exposure to absolute-maximum-rated conditions for extended periods may affect device reliability.
- (2) The input negative-voltage and output voltage ratings may be exceeded if the input and output clamp-current ratings are observed.
- (3) The value of V_{CC} is provided in the *Recommended Operating Conditions* table.

7.2 ESD Ratings

		VALUE	UNIT
$V_{(ESD)}$	Electrostatic discharge	Human body model (HBM), per ANSI/ESDA/JEDEC JS-001, all pins ⁽¹⁾	2000
		Charged device model (CDM), per JEDEC specification JESD22-C101, all pins ⁽²⁾	1000

- (1) JEDEC document JEP155 states that 500-V HBM allows safe manufacturing with a standard ESD control process.
- (2) JEDEC document JEP157 states that 250-V CDM allows safe manufacturing with a standard ESD control process.

7.3 Recommended Operating Conditions

		MIN	MAX	UNIT	
V _{CC}	Supply voltage	Operating	1.65	5.5	V
		Data retention only	1.5		
V _{IH}	High-level input voltage	V _{CC} = 1.65 V to 1.95 V	0.65 × V _{CC}		V
		V _{CC} = 2.3 V to 2.7 V	1.7		
		V _{CC} = 3 V to 3.6 V	2		
		V _{CC} = 4.5 V to 5.5 V	0.7 × V _{CC}		
V _{IL}	Low-level input voltage	V _{CC} = 1.65 V to 1.95 V		0.35 × V _{CC}	V
		V _{CC} = 2.3 V to 2.7 V		0.7	
		V _{CC} = 3 V to 3.6 V		0.8	
		V _{CC} = 4.5 V to 5.5 V		0.3 × V _{CC}	
V _I	Input voltage	0	5.5	V	
V _O	Output voltage	0	V _{CC}	V	
I _{OH}	High-level output current	V _{CC} = 1.65 V		–4	mA
		V _{CC} = 2.3 V		–8	
		V _{CC} = 3 V		–16	
		V _{CC} = 4.5 V		–24	
I _{OL}	Low-level output current	V _{CC} = 1.65 V		4	mA
		V _{CC} = 2.3 V		8	
		V _{CC} = 3 V		16	
		V _{CC} = 4.5 V		24	
Δt/Δv	Input transition rise or fall rate	V _{CC} = 1.8 V ± 0.15 V, 2.5 V ± 0.2 V		20	ns/V
		V _{CC} = 3.3 V ± 0.3 V		10	
		V _{CC} = 5 V ± 0.5 V		5	
T _A	Operating free-air temperature	–40	125	°C	

(1) All unused inputs of the device must be held at V_{CC} or GND to ensure proper device operation. Refer to the TI application report, *Implications of Slow or Floating CMOS Inputs*, literature number [SCBA004](#).

7.4 Thermal Information

THERMAL METRIC ⁽¹⁾	SN74LVC1G00			UNIT	
	DCT	DCU	YZP		
	5 PINS	5 PINS	5 PINS		
R _{θJA}	Junction-to-ambient thermal resistance	220	227	102	°C/W

(1) For more information about traditional and new thermal metrics, see the *IC Package Thermal Metrics* application report, [SPRA953](#).

7.5 Electrical Characteristics

over recommended operating free-air temperature range (unless otherwise noted)

PARAMETER	TEST CONDITIONS	V _{CC}	–40°C to 85°C			–40°C to 125°C			UNIT
			MIN	TYP ⁽¹⁾	MAX	MIN	TYP ⁽¹⁾	MAX	
V _{OH}	I _{OH} = –100 μA	1.65 V to 5.5 V	V _{CC} – 0.1			V _{CC} – 0.1			V
	I _{OH} = –4 mA	1.65 V	1.2			1.2			
	I _{OH} = –8 mA	2.3 V	1.9			1.9			
	I _{OH} = –16 mA	3 V	2.4			2.4			
	I _{OH} = –24 mA		2.3			2.3			
	I _{OH} = –32 mA	4.5 V	3.8			3.8			
V _{OL}	I _{OL} = 100 μA	1.65 V to 5.5 V	0.1			0.1			V
	I _{OL} = 4 mA	1.65 V	0.45			0.45			
	I _{OL} = 8 mA	2.3 V	0.3			0.3			
	I _{OL} = 16 mA	3 V	0.4			0.4			
	I _{OL} = 24 mA		0.55			0.55			
	I _{OL} = 32 mA	4.5 V	0.55			0.55			
I _I	A or B inputs	V _I = 5.5 V or GND	0 to 5.5 V			±5			μA
I _{off}		V _I or V _O = 5.5 V	0			±10			μA
I _{CC}		V _I = 5.5 V or GND, I _O = 0	1.65 V to 5.5 V			10			μA
ΔI _{CC}		One input at V _{CC} – 0.6 V, Other inputs at V _{CC} or GND	3 V to 5.5 V			500			μA
C _I		V _I = V _{CC} or GND	3.3 V			5			pF

 (1) All typical values are at V_{CC} = 3.3 V, T_A = 25°C.

7.6 Electrical Characteristics (Continued)

 T_A = 25°C

PARAMETER	TEST CONDITIONS	V _{CC} = 1.8 V	V _{CC} = 2.5 V	V _{CC} = 3.3 V	V _{CC} = 5 V	UNIT	
		TYP	TYP	TYP	TYP		
C _{pd}	Power dissipation capacitance	f = 10 MHz	19	19	20	22	pF

7.7 Switching Characteristics, –40°C to 85°C

 over recommended operating free-air temperature range (unless otherwise noted) (see [Figure 3](#))

PARAMETER	FROM (INPUT)	TO (OUTPUT)	–40°C to 85°C								UNIT
			V _{CC} = 1.8 V ± 0.15 V		V _{CC} = 2.5 V ± 0.2 V		V _{CC} = 3.3 V ± 0.3 V		V _{CC} = 5 V ± 0.5 V		
			MIN	MAX	MIN	MAX	MIN	MAX	MIN	MAX	
t _{pd}	A or B	Y	3.7	8.6	1.6	4.8	1.1	4.3	1	3.3	ns

7.8 Switching Characteristics, –40°C to 125°C

 over recommended operating free-air temperature range (unless otherwise noted) (see [Figure 3](#))

PARAMETER	FROM (INPUT)	TO (OUTPUT)	–40°C to 125°C								UNIT
			V _{CC} = 1.8 V ± 0.15 V		V _{CC} = 2.5 V ± 0.2 V		V _{CC} = 3.3 V ± 0.3 V		V _{CC} = 5 V ± 0.5 V		
			MIN	MAX	MIN	MAX	MIN	MAX	MIN	MAX	
t _{pd}	A or B	Y	3.7	9.4	1.6	5.5	1.1	4.9	1	3.8	ns

7.9 Typical Characteristics

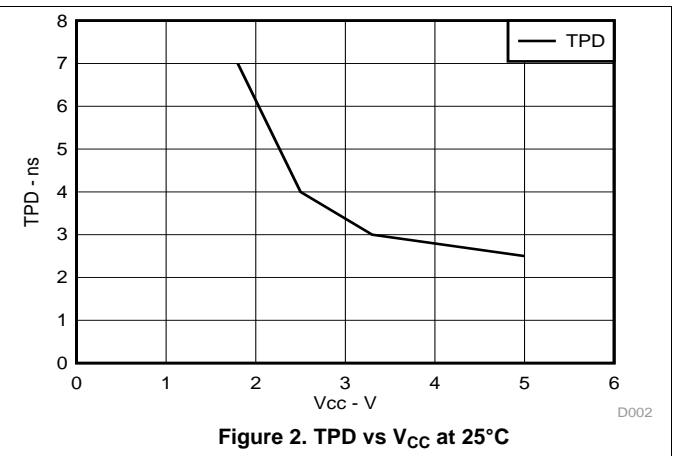
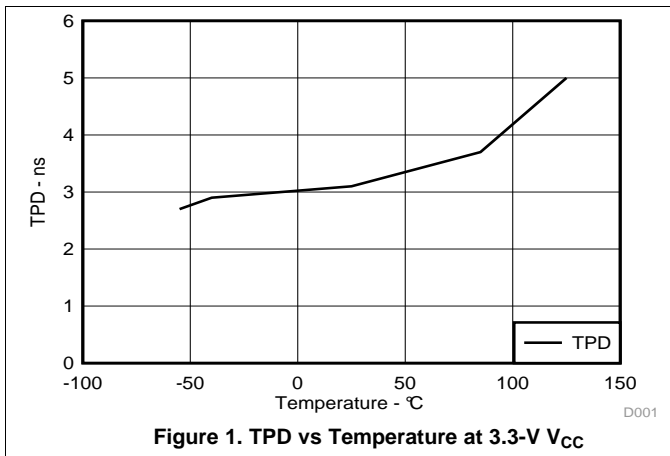

8 Parameter Measurement Information

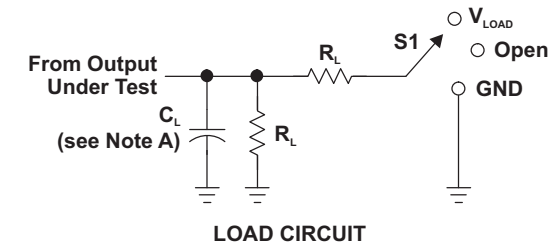

TEST	S1
t_{PLH}/t_{PHL}	Open
t_{PLZ}/t_{PZL}	V_{LOAD}
t_{PHZ}/t_{PZH}	GND

V_{CC}	INPUTS		V_M	V_{LOAD}	C_L	R_L	V_{Δ}
	V_i	t_i/t_r					
$1.8\text{ V} \pm 0.15\text{ V}$	V_{CC}	$\leq 2\text{ ns}$	$V_{CC}/2$	$2 \times V_{CC}$	30 pF	1 k Ω	0.15 V
$2.5\text{ V} \pm 0.2\text{ V}$	V_{CC}	$\leq 2\text{ ns}$	$V_{CC}/2$	$2 \times V_{CC}$	30 pF	500 Ω	0.15 V
$3.3\text{ V} \pm 0.3\text{ V}$	3 V	$\leq 2.5\text{ ns}$	1.5 V	6 V	50 pF	500 Ω	0.3 V
$5\text{ V} \pm 0.5\text{ V}$	V_{CC}	$\leq 2.5\text{ ns}$	$V_{CC}/2$	$2 \times V_{CC}$	50 pF	500 Ω	0.3 V

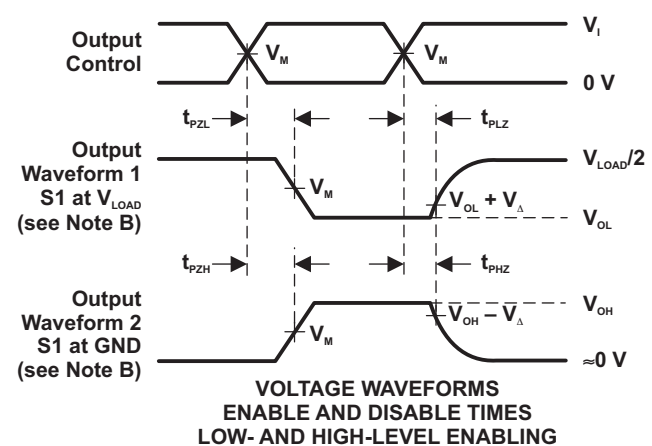
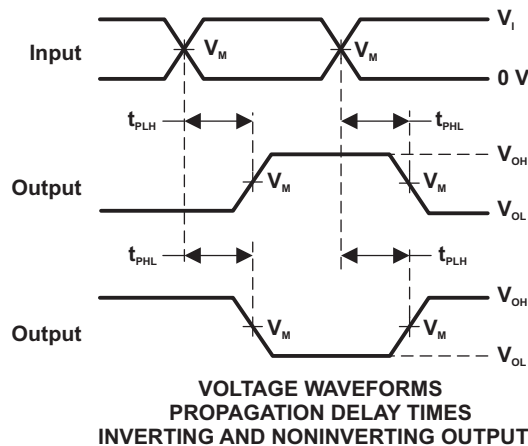
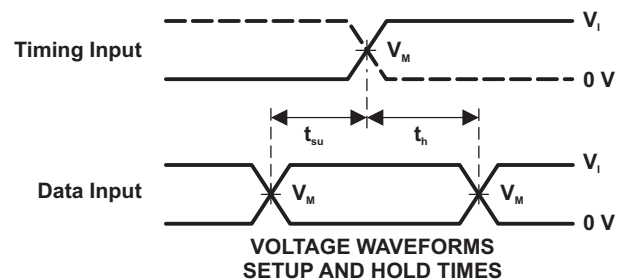
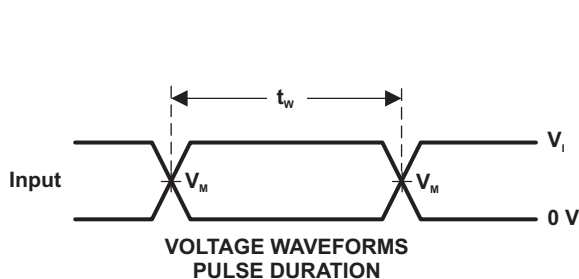

- NOTES: A. C_L includes probe and jig capacitance.
 B. Waveform 1 is for an output with internal conditions such that the output is low, except when disabled by the output control. Waveform 2 is for an output with internal conditions such that the output is high, except when disabled by the output control.
 C. All input pulses are supplied by generators having the following characteristics: PRR $\leq 10\text{ MHz}$, $Z_o = 50\ \Omega$.
 D. The outputs are measured one at a time, with one transition per measurement.
 E. t_{PLZ} and t_{PHZ} are the same as t_{dis} .
 F. t_{PZL} and t_{PZH} are the same as t_{en} .
 G. t_{PLH} and t_{PHL} are the same as t_{pd} .
 H. All parameters and waveforms are not applicable to all devices.

Figure 3. Load Circuit and Voltage Waveforms

9 Detailed Description

9.1 Overview

The SN74LVC2G00 device contains two 2-input positive-NAND gates and performs the Boolean function $Y = A \times B$ or $Y = \overline{A + B}$ on each gate. This device is fully specified for partial-power-down applications using I_{off} . The I_{off} circuitry disables the outputs, preventing damaging current backflow through the device when it is powered down.

9.2 Functional Block Diagram

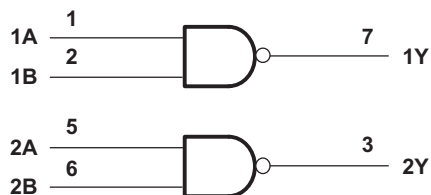

9.3 Feature Description

- Wide operating voltage range.
 - Operates from 1.65 V to 5.5 V
- Allows down voltage translation
 - Inputs accept voltages to 5.5 V
- I_{off} feature
 - Allows voltages on the inputs and outputs, when V_{CC} is 0 V

9.4 Device Functional Modes

Table 1. Function Table (Each Gate)

INPUTS		OUTPUT Y
A	B	
H	H	L
L	X	H
X	L	H

10 Application and Implementation

10.1 Application Information

SN74LVC2G00 is a high-drive CMOS device that can be used for implementing NAND logic with a high output drive, such as an LED application. It can produce 24 mA of drive current at 3.3 V, making it ideal for driving multiple outputs and good for high speed applications up to 100 MHz. The inputs are 5.5-V tolerant, allowing it to translate down to V_{CC} .

10.2 Typical Application

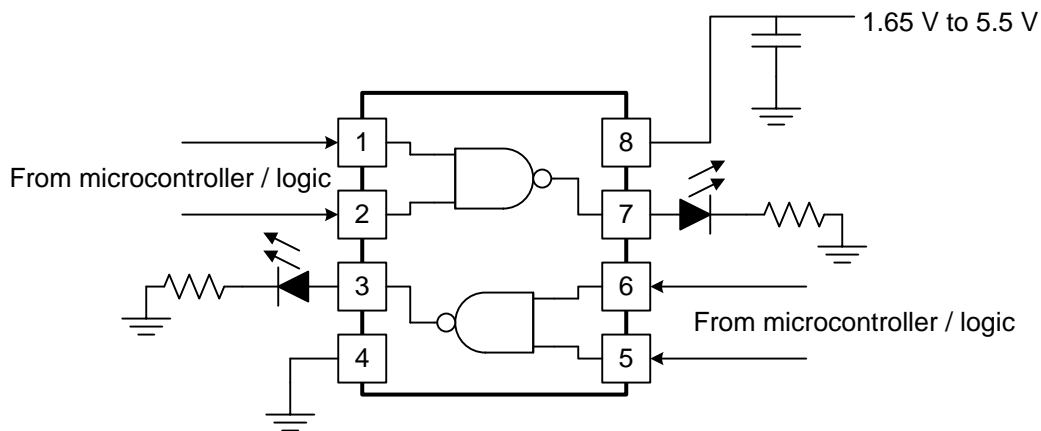

10.2.1 Design Requirements

This device uses CMOS technology and has balanced output drive. Care should be taken to avoid bus contention because it can drive currents that would exceed maximum limits. The high drive will also create fast edges into light loads so routing and load conditions should be considered to prevent ringing.

10.2.2 Detailed Design Procedure

1. Recommended Input Conditions
 - For rise time and fall time specifications, see $(\Delta t/\Delta V)$ in the [Recommended Operating Conditions](#) table.
 - For specified high and low levels, see $(V_{IH}$ and $V_{IL})$ in the [Recommended Operating Conditions](#) table.
 - Inputs are overvoltage tolerant allowing them to go as high as $(V_I \text{ max})$ in the [Recommended Operating Conditions](#) table at any valid V_{CC} .
2. Recommend Output Conditions
 - Load currents should not exceed $(I_O \text{ max})$ per output and should not exceed total current (continuous current through V_{CC} or GND) for the part. These limits are located in the [Absolute Maximum Ratings](#) table.
 - Outputs should not be pulled above V_{CC} .

Typical Application (continued)

10.2.3 Application Curves

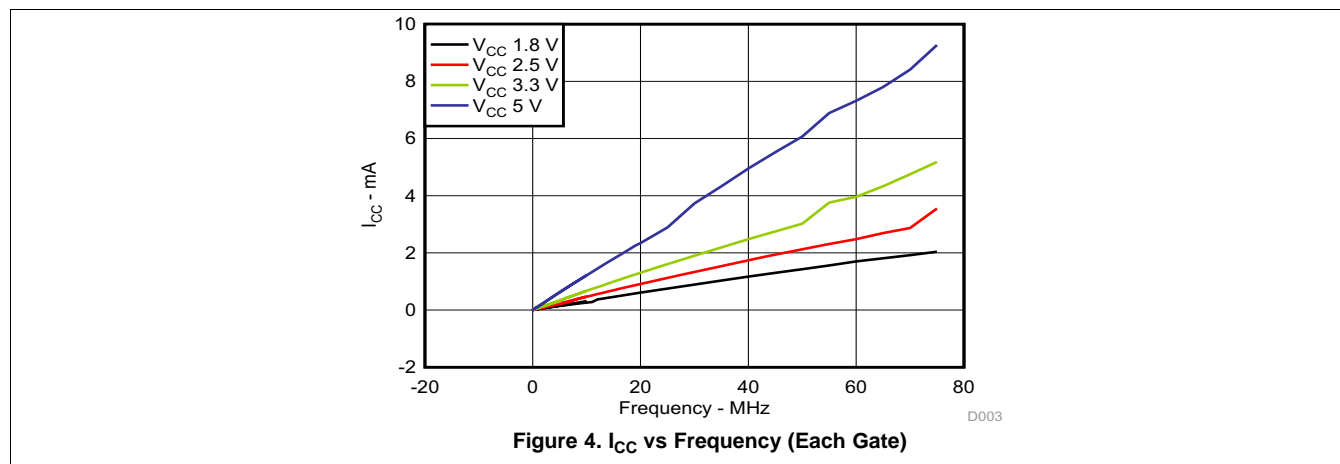

Figure 4. I_{CC} vs Frequency (Each Gate)

11 Power Supply Recommendations

The power supply can be any voltage between the min and max supply voltage rating located in the [Recommended Operating Conditions](#) table.

Each V_{CC} pin should have a good bypass capacitor to prevent power disturbance. For devices with a single supply a 0.1-μF capacitor is recommended and if there are multiple V_{CC} pins then a 0.01-μF or 0.022-μF capacitor is recommended for each power pin. It is ok to parallel multiple bypass caps to reject different frequencies of noise. 0.1-μF and 1-μF capacitors are commonly used in parallel. The bypass capacitor should be installed as close to the power pin as possible for best results.

12 Layout

12.1 Layout Guidelines

When using multiple bit logic devices, inputs should not float. In many cases, functions or parts of functions of digital logic devices are unused. Some examples are when only two inputs of a triple-input AND gate are used, or when only 3 of the 4 buffer gates are used. Such input pins should not be left unconnected because the undefined voltages at the outside connections result in undefined operational states.

Specified in Figure 5 are the rules that must be observed under all circumstances. All unused inputs of digital logic devices must be connected to a high or low bias to prevent them from floating. The logic level that should be applied to any particular unused input depends on the function of the device. Generally they will be tied to GND or V_{CC} , whichever makes more sense or is more convenient.

12.2 Layout Example

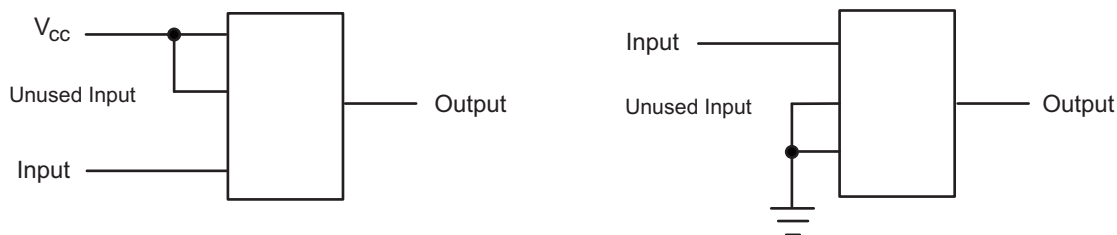

Figure 5. Layout Diagram

13 Device and Documentation Support

13.1 Trademarks

NanoFree is a trademark of Texas Instruments.
All other trademarks are the property of their respective owners.

13.2 Electrostatic Discharge Caution



These devices have limited built-in ESD protection. The leads should be shorted together or the device placed in conductive foam during storage or handling to prevent electrostatic damage to the MOS gates.

13.3 Glossary

[SLYZ022](#) — TI Glossary.

This glossary lists and explains terms, acronyms and definitions.

14 Mechanical, Packaging, and Orderable Information

The following pages include mechanical packaging and orderable information. This information is the most current data available for the designated devices. This data is subject to change without notice and revision of this document. For browser based versions of this data sheet, refer to the left hand navigation.

PACKAGING INFORMATION

Orderable Device	Status (1)	Package Type	Package Drawing	Pins	Package Qty	Eco Plan (2)	Lead finish/ Ball material (6)	MSL Peak Temp (3)	Op Temp (°C)	Device Marking (4/5)	Samples
SN74LVC2G00DCT3	ACTIVE	SM8	DCT	8	3000	RoHS & Non-Green	SNBI	Level-1-260C-UNLIM	-40 to 125	C00 Z	Samples
SN74LVC2G00DCTR	ACTIVE	SM8	DCT	8	3000	RoHS & Green	NIPDAU	Level-1-260C-UNLIM	-40 to 125	C00 (R, Z)	Samples
SN74LVC2G00DCTRE4	ACTIVE	SM8	DCT	8	3000	RoHS & Green	NIPDAU	Level-1-260C-UNLIM	-40 to 125	C00 (R, Z)	Samples
SN74LVC2G00DCUR	ACTIVE	VSSOP	DCU	8	3000	RoHS & Green	NIPDAU SN	Level-1-260C-UNLIM	-40 to 125	(C00J, C00Q, C00R)	Samples
SN74LVC2G00DCUT	ACTIVE	VSSOP	DCU	8	250	RoHS & Green	NIPDAU SN	Level-1-260C-UNLIM	-40 to 125	(C00J, C00Q, C00R)	Samples
SN74LVC2G00DCUTG4	ACTIVE	VSSOP	DCU	8	250	RoHS & Green	NIPDAU	Level-1-260C-UNLIM	-40 to 125	C00R	Samples
SN74LVC2G00YZPR	ACTIVE	DSBGA	YZP	8	3000	RoHS & Green	SNAGCU	Level-1-260C-UNLIM	-40 to 125	CAN	Samples

(1) The marketing status values are defined as follows:

ACTIVE: Product device recommended for new designs.

LIFEBUY: TI has announced that the device will be discontinued, and a lifetime-buy period is in effect.

NRND: Not recommended for new designs. Device is in production to support existing customers, but TI does not recommend using this part in a new design.

PREVIEW: Device has been announced but is not in production. Samples may or may not be available.

OBSELETE: TI has discontinued the production of the device.

(2) **RoHS:** TI defines "RoHS" to mean semiconductor products that are compliant with the current EU RoHS requirements for all 10 RoHS substances, including the requirement that RoHS substance do not exceed 0.1% by weight in homogeneous materials. Where designed to be soldered at high temperatures, "RoHS" products are suitable for use in specified lead-free processes. TI may reference these types of products as "Pb-Free".

RoHS Exempt: TI defines "RoHS Exempt" to mean products that contain lead but are compliant with EU RoHS pursuant to a specific EU RoHS exemption.

Green: TI defines "Green" to mean the content of Chlorine (Cl) and Bromine (Br) based flame retardants meet JS709B low halogen requirements of <=1000ppm threshold. Antimony trioxide based flame retardants must also meet the <=1000ppm threshold requirement.

(3) MSL, Peak Temp. - The Moisture Sensitivity Level rating according to the JEDEC industry standard classifications, and peak solder temperature.

(4) There may be additional marking, which relates to the logo, the lot trace code information, or the environmental category on the device.

(5) Multiple Device Markings will be inside parentheses. Only one Device Marking contained in parentheses and separated by a "~" will appear on a device. If a line is indented then it is a continuation of the previous line and the two combined represent the entire Device Marking for that device.

⁽⁶⁾ Lead finish/Ball material - Orderable Devices may have multiple material finish options. Finish options are separated by a vertical ruled line. Lead finish/Ball material values may wrap to two lines if the finish value exceeds the maximum column width.

Important Information and Disclaimer: The information provided on this page represents TI's knowledge and belief as of the date that it is provided. TI bases its knowledge and belief on information provided by third parties, and makes no representation or warranty as to the accuracy of such information. Efforts are underway to better integrate information from third parties. TI has taken and continues to take reasonable steps to provide representative and accurate information but may not have conducted destructive testing or chemical analysis on incoming materials and chemicals. TI and TI suppliers consider certain information to be proprietary, and thus CAS numbers and other limited information may not be available for release.

In no event shall TI's liability arising out of such information exceed the total purchase price of the TI part(s) at issue in this document sold by TI to Customer on an annual basis.

TAPE AND REEL INFORMATION

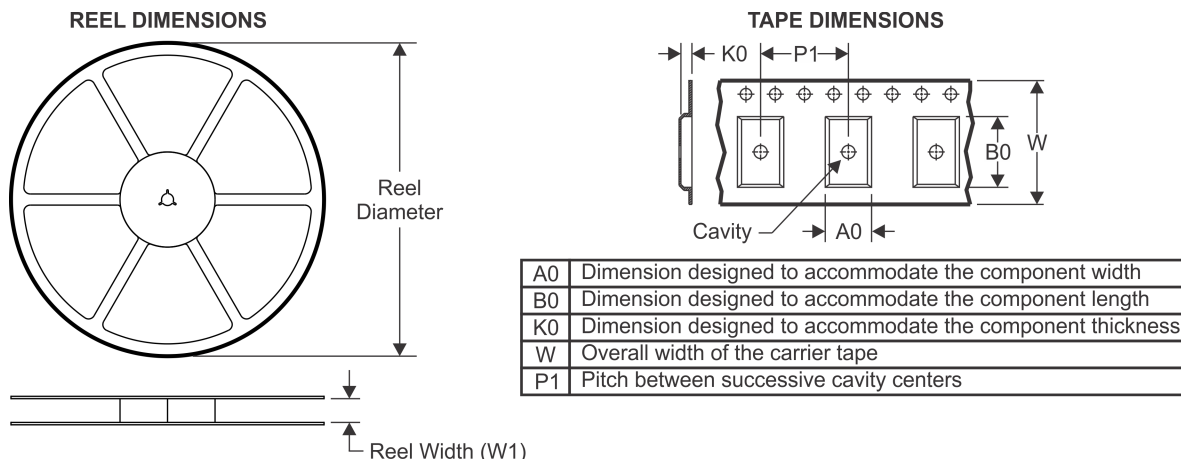

QUADRANT ASSIGNMENTS FOR PIN 1 ORIENTATION IN TAPE



*All dimensions are nominal

Device	Package Type	Package Drawing	Pins	SPQ	Reel Diameter (mm)	Reel Width W1 (mm)	A0 (mm)	B0 (mm)	K0 (mm)	P1 (mm)	W (mm)	Pin1 Quadrant
SN74LVC2G00DCT3	SM8	DCT	8	3000	180.0	13.0	3.35	4.5	1.55	4.0	12.0	Q3
SN74LVC2G00DCTR	SM8	DCT	8	3000	180.0	13.0	3.35	4.5	1.55	4.0	12.0	Q3
SN74LVC2G00DCTR	SM8	DCT	8	3000	177.8	12.4	3.45	4.4	1.45	4.0	12.0	Q3
SN74LVC2G00DCUR	VSSOP	DCU	8	3000	180.0	8.4	2.25	3.35	1.05	4.0	8.0	Q3
SN74LVC2G00DCUR	VSSOP	DCU	8	3000	178.0	9.0	2.25	3.35	1.05	4.0	8.0	Q3
SN74LVC2G00DCUR	VSSOP	DCU	8	3000	178.0	9.5	2.25	3.35	1.05	4.0	8.0	Q3
SN74LVC2G00DCUT	VSSOP	DCU	8	250	178.0	9.5	2.25	3.35	1.05	4.0	8.0	Q3
SN74LVC2G00DCUT	VSSOP	DCU	8	250	178.0	9.0	2.25	3.35	1.05	4.0	8.0	Q3
SN74LVC2G00DCUTG4	VSSOP	DCU	8	250	180.0	8.4	2.25	3.35	1.05	4.0	8.0	Q3
SN74LVC2G00YZPR	DSBGA	YZP	8	3000	178.0	9.2	1.02	2.02	0.63	4.0	8.0	Q1

TAPE AND REEL BOX DIMENSIONS

*All dimensions are nominal

Device	Package Type	Package Drawing	Pins	SPQ	Length (mm)	Width (mm)	Height (mm)
SN74LVC2G00DCT3	SM8	DCT	8	3000	182.0	182.0	20.0
SN74LVC2G00DCTR	SM8	DCT	8	3000	182.0	182.0	20.0
SN74LVC2G00DCTR	SM8	DCT	8	3000	183.0	183.0	20.0
SN74LVC2G00DCUR	VSSOP	DCU	8	3000	202.0	201.0	28.0
SN74LVC2G00DCUR	VSSOP	DCU	8	3000	180.0	180.0	18.0
SN74LVC2G00DCUR	VSSOP	DCU	8	3000	202.0	201.0	28.0
SN74LVC2G00DCUT	VSSOP	DCU	8	250	202.0	201.0	28.0
SN74LVC2G00DCUT	VSSOP	DCU	8	250	180.0	180.0	18.0
SN74LVC2G00DCUTG4	VSSOP	DCU	8	250	202.0	201.0	28.0
SN74LVC2G00YZPR	DSBGA	YZP	8	3000	220.0	220.0	35.0

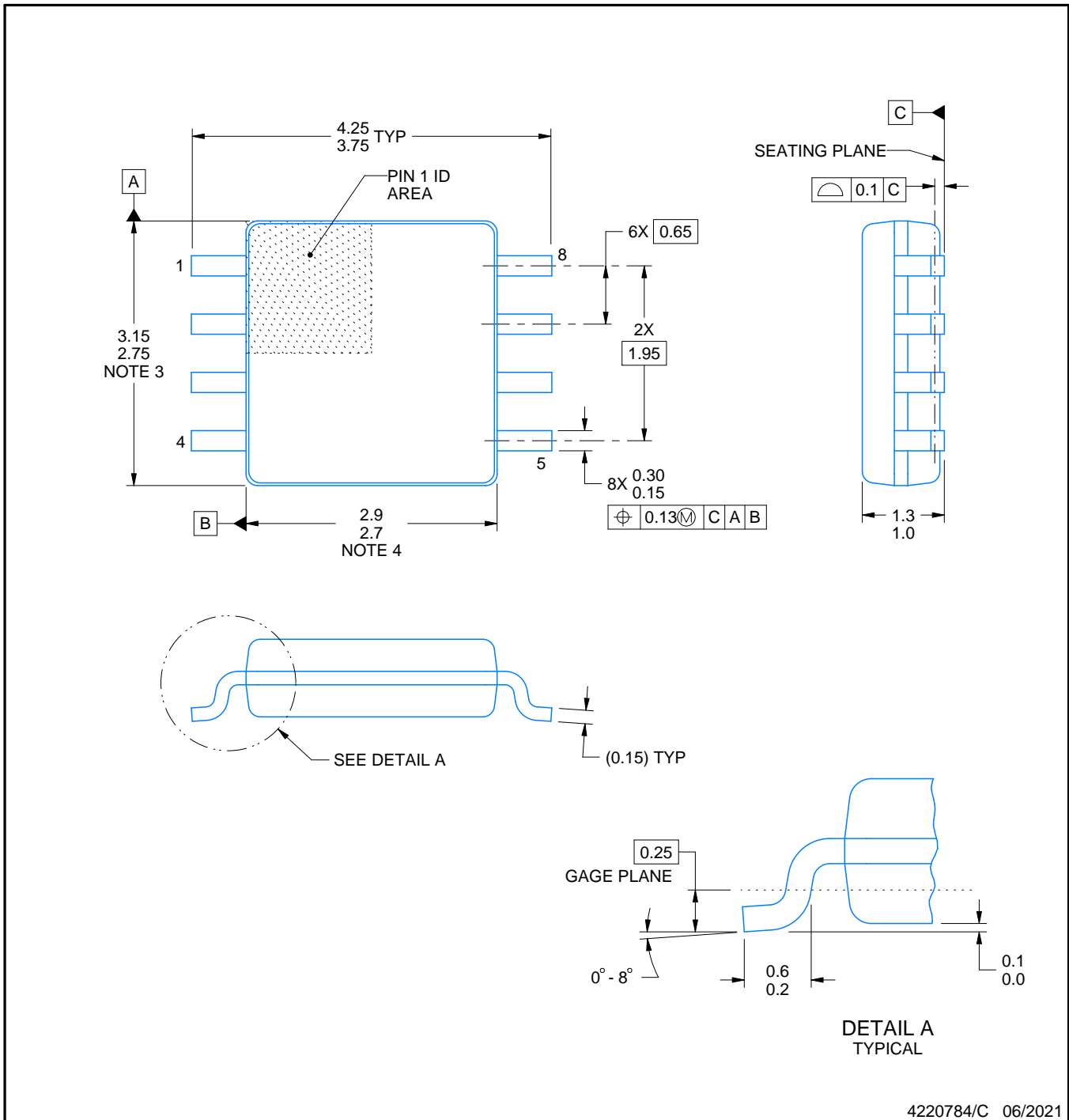
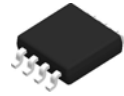

4220784/C 06/2021

EXAMPLE BOARD LAYOUT

DCT0008A

SSOP - 1.3 mm max height

SMALL OUTLINE PACKAGE

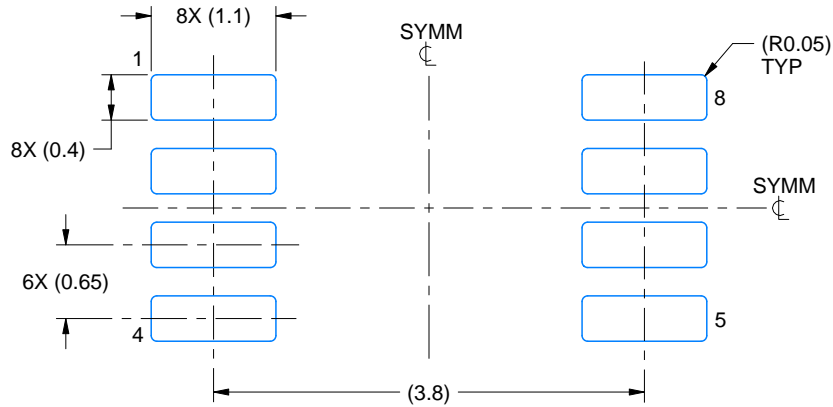

LAND PATTERN EXAMPLE
EXPOSED METAL SHOWN
SCALE:15X

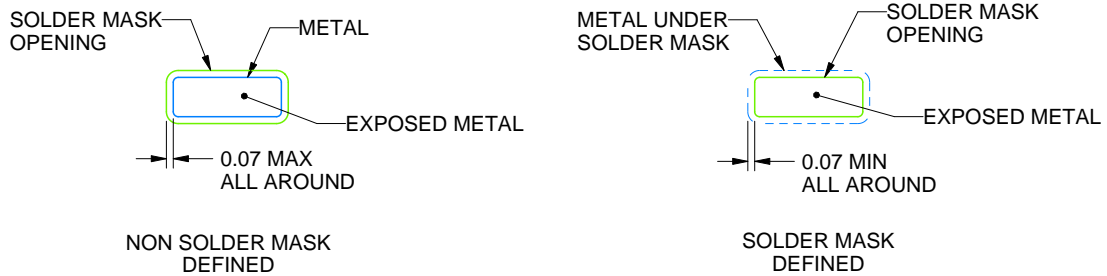

SOLDER MASK DETAILS

4220784/C 06/2021

NOTES: (continued)

- 5. Publication IPC-7351 may have alternate designs.
- 6. Solder mask tolerances between and around signal pads can vary based on board fabrication site.

EXAMPLE STENCIL DESIGN

DCT0008A

SSOP - 1.3 mm max height

SMALL OUTLINE PACKAGE

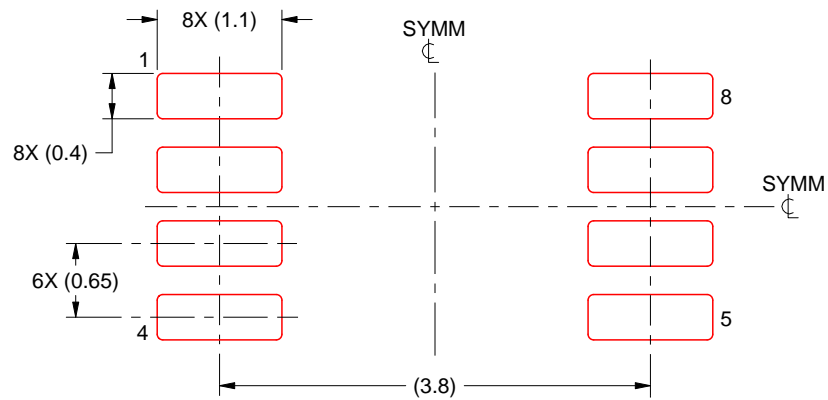

SOLDER PASTE EXAMPLE
BASED ON 0.125 mm THICK STENCIL
SCALE:15X

4220784/C 06/2021

NOTES: (continued)

7. Laser cutting apertures with trapezoidal walls and rounded corners may offer better paste release. IPC-7525 may have alternate design recommendations.
8. Board assembly site may have different recommendations for stencil design.

YZP0008

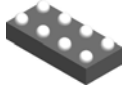

PACKAGE OUTLINE

DSBGA - 0.5 mm max height

DIE SIZE BALL GRID ARRAY

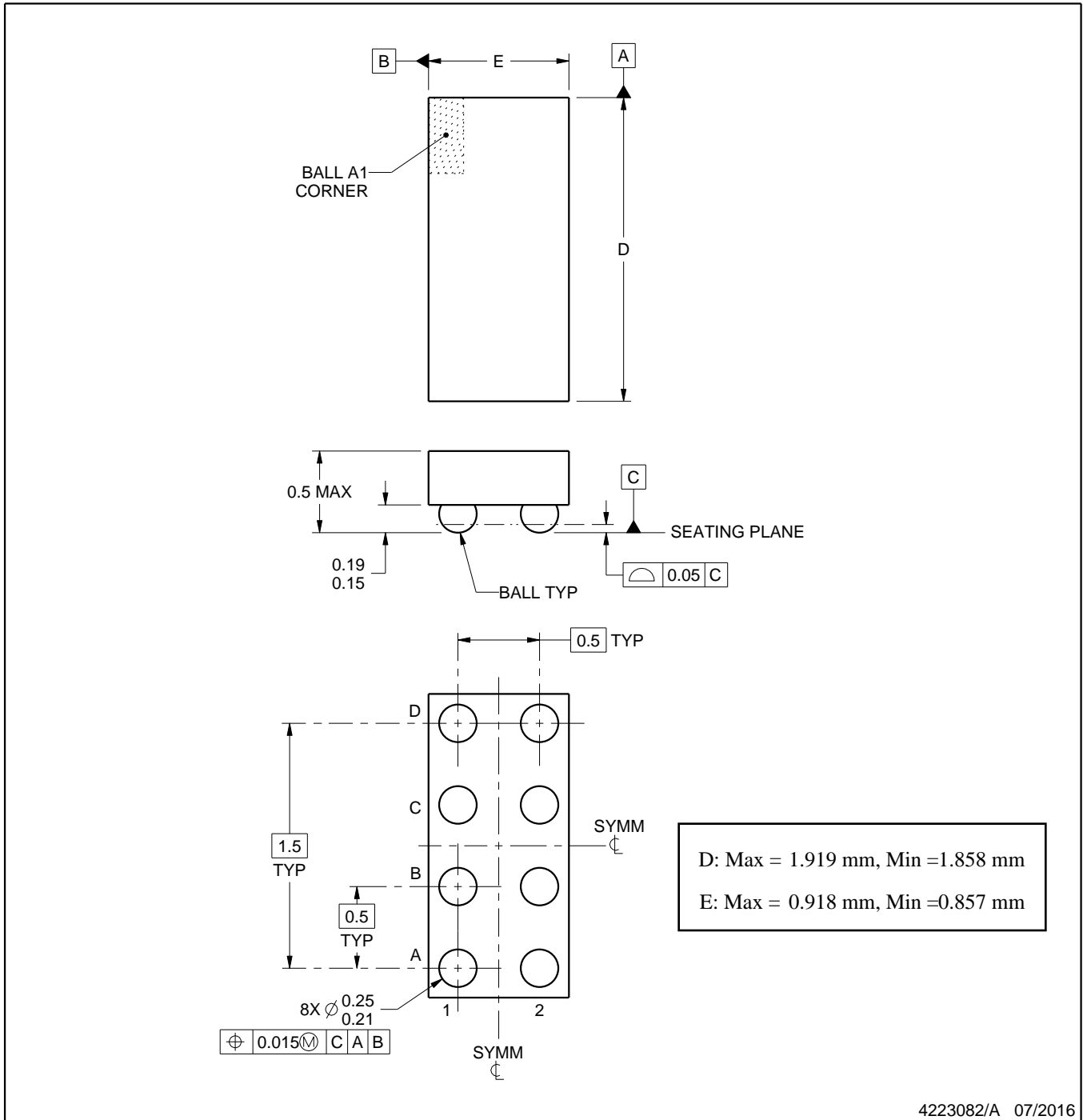

NOTES:

1. All linear dimensions are in millimeters. Any dimensions in parenthesis are for reference only. Dimensioning and tolerancing per ASME Y14.5M.
2. This drawing is subject to change without notice.

EXAMPLE BOARD LAYOUT

YZP0008

DSBGA - 0.5 mm max height

DIE SIZE BALL GRID ARRAY

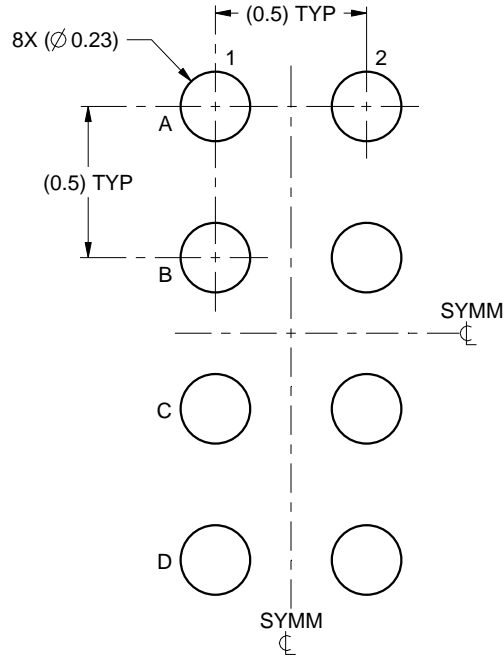

LAND PATTERN EXAMPLE
SCALE:40X

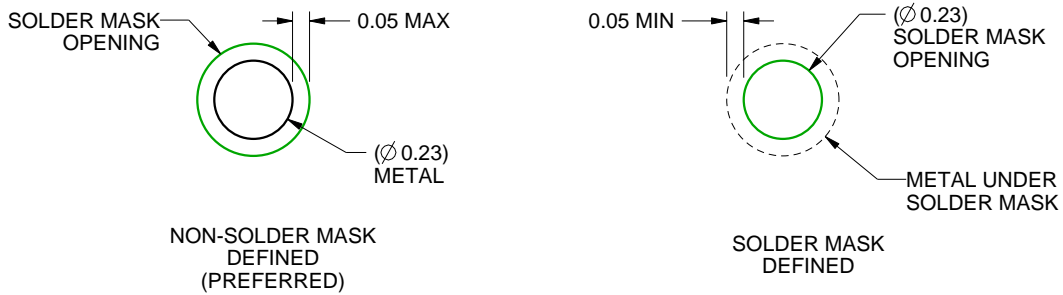

SOLDER MASK DETAILS
NOT TO SCALE

4223082/A 07/2016

NOTES: (continued)

3. Final dimensions may vary due to manufacturing tolerance considerations and also routing constraints. For more information, see Texas Instruments literature number SNVA009 (www.ti.com/lit/snva009).

EXAMPLE STENCIL DESIGN

YZP0008

DSBGA - 0.5 mm max height

DIE SIZE BALL GRID ARRAY

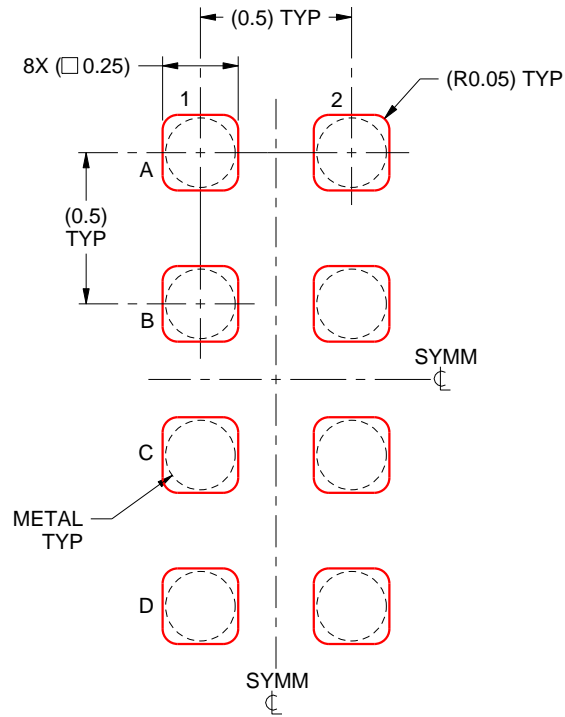

SOLDER PASTE EXAMPLE
BASED ON 0.1 mm THICK STENCIL
SCALE:40X

4223082/A 07/2016

NOTES: (continued)

4. Laser cutting apertures with trapezoidal walls and rounded corners may offer better paste release.

DCU0008A



PACKAGE OUTLINE

VSSOP - 0.9 mm max height

SMALL OUTLINE PACKAGE

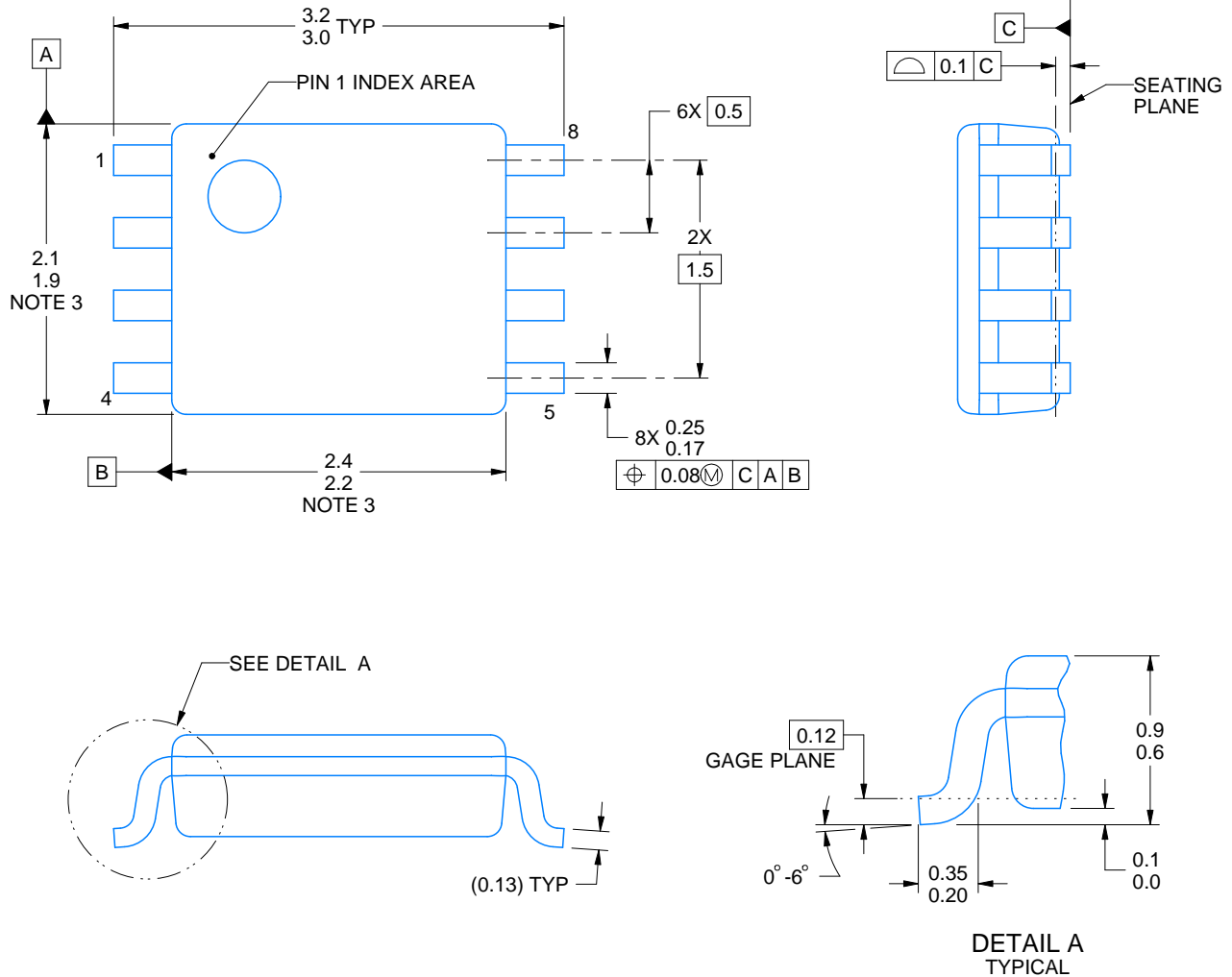

4225266/A 09/2014

NOTES:

1. All linear dimensions are in millimeters. Any dimensions in parenthesis are for reference only. Dimensioning and tolerancing per ASME Y14.5M.
2. This drawing is subject to change without notice.
3. This dimension does not include mold flash, protrusions, or gate burrs. Mold flash, protrusions, or gate burrs shall not exceed 0.15 mm per side.
4. Reference JEDEC registration MO-187 variation CA.

EXAMPLE BOARD LAYOUT

DCU0008A

VSSOP - 0.9 mm max height

SMALL OUTLINE PACKAGE

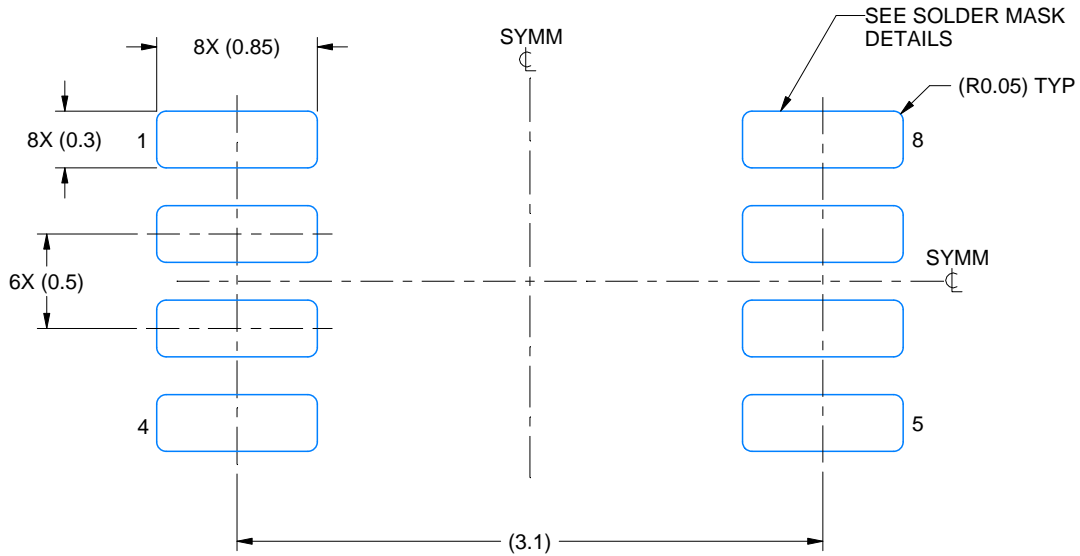

LAND PATTERN EXAMPLE
EXPOSED METAL SHOWN
SCALE: 25X

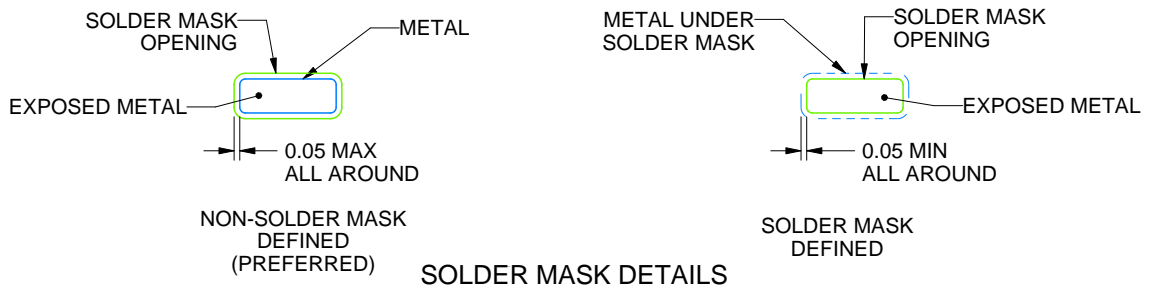

4225266/A 09/2014

NOTES: (continued)

- 5. Publication IPC-7351 may have alternate designs.
- 6. Solder mask tolerances between and around signal pads can vary based on board fabrication site.

EXAMPLE STENCIL DESIGN

DCU0008A

VSSOP - 0.9 mm max height

SMALL OUTLINE PACKAGE

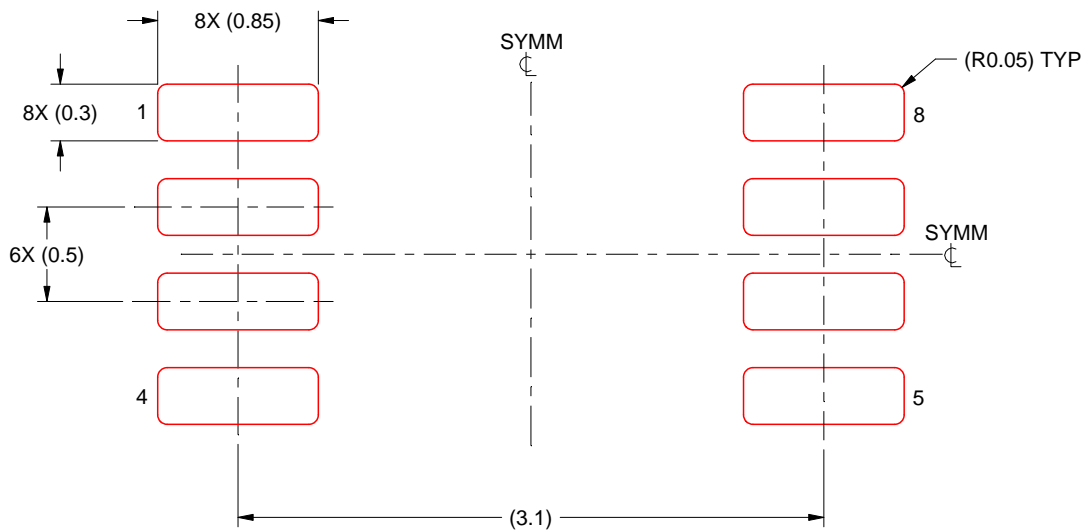

SOLDER PASTE EXAMPLE
BASED ON 0.125 mm THICK STENCIL
SCALE: 25X

4225266/A 09/2014

NOTES: (continued)

7. Laser cutting apertures with trapezoidal walls and rounded corners may offer better paste release. IPC-7525 may have alternate design recommendations.
8. Board assembly site may have different recommendations for stencil design.

IMPORTANT NOTICE AND DISCLAIMER

TI PROVIDES TECHNICAL AND RELIABILITY DATA (INCLUDING DATA SHEETS), DESIGN RESOURCES (INCLUDING REFERENCE DESIGNS), APPLICATION OR OTHER DESIGN ADVICE, WEB TOOLS, SAFETY INFORMATION, AND OTHER RESOURCES "AS IS" AND WITH ALL FAULTS, AND DISCLAIMS ALL WARRANTIES, EXPRESS AND IMPLIED, INCLUDING WITHOUT LIMITATION ANY IMPLIED WARRANTIES OF MERCHANTABILITY, FITNESS FOR A PARTICULAR PURPOSE OR NON-INFRINGEMENT OF THIRD PARTY INTELLECTUAL PROPERTY RIGHTS.

These resources are intended for skilled developers designing with TI products. You are solely responsible for (1) selecting the appropriate TI products for your application, (2) designing, validating and testing your application, and (3) ensuring your application meets applicable standards, and any other safety, security, regulatory or other requirements.

These resources are subject to change without notice. TI grants you permission to use these resources only for development of an application that uses the TI products described in the resource. Other reproduction and display of these resources is prohibited. No license is granted to any other TI intellectual property right or to any third party intellectual property right. TI disclaims responsibility for, and you will fully indemnify TI and its representatives against, any claims, damages, costs, losses, and liabilities arising out of your use of these resources.

TI's products are provided subject to [TI's Terms of Sale](#) or other applicable terms available either on [ti.com](https://www.ti.com) or provided in conjunction with such TI products. TI's provision of these resources does not expand or otherwise alter TI's applicable warranties or warranty disclaimers for TI products.

TI objects to and rejects any additional or different terms you may have proposed.

Mailing Address: Texas Instruments, Post Office Box 655303, Dallas, Texas 75265
Copyright © 2023, Texas Instruments Incorporated