

TMAG5124-Q1 汽车双线制、高精度、霍尔效应开关传感器

1 特性

- 具有符合 AEC-Q100 标准的下列特性：
 - 器件温度等级 0：-40°C 至 150°C 环境温度范围
- 带双线制接口的霍尔效应开关
- 低级电流输出选项：
 - TMAG5124A/B/C/D-Q1：3.5mA
 - TMAG5124E/F/G/H-Q1：6mA
- 磁性灵敏度：
 - TMAG5124A/E-Q1：4mT (典型值)
 - TMAG5124B/F-Q1：6mT (典型值)
 - TMAG5124C/G-Q1：10mT (典型值)
 - TMAG5124D/H-Q1：15mT (典型值)
- 快速感应带宽：40kHz
- 支持宽电压范围
 - 工作 V_{CC} 范围：2.7 V 至 38 V
 - 无需外部稳压器
- 保护特性：
 - 支持高达 40 V 的负载突降
 - 反极性保护
- SOT-23 封装选项

2 应用

- 座椅位置和舒适模块
- 车门把手模块
- 雨刮器模块
- 后备箱模块
- 天窗电机模块
- 制动系统
- 电动助力转向 (EPS)

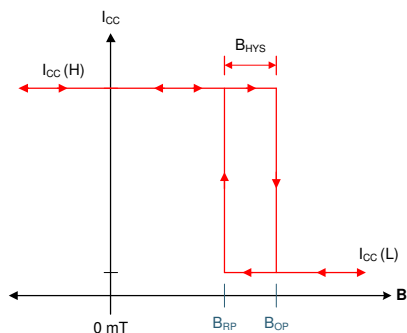

输出状态

3 说明

TMAG5124-Q1 器件是高精度霍尔效应传感器，可提供双线制接口，可用于汽车设计。

TMAG5124-Q1 集成了可在两个级别之间切换的电流源，具体取决于施加给器件的磁场值。较高值为固定值，较低值可从两个范围之间选择。此类接口支持传感器与控制器之间的稳定通信，可进行远距离传输，有助于检测断开连接的情况，可将接线数量限于两条。

该器件采用 3 引脚 SOT-23 封装。虽然封装上有 3 个引脚，但该器件只需要 VCC 和 GND 引脚即可运行。可从这两个引脚分别测量电流，实现高侧或低侧配置。

不同的产品型号可选择不同的磁性灵敏度水平，以满足应用的具体要求。

TMAG5124-Q1 的宽工作电压范围和反极性保护适用于各种汽车应用。

器件信息

器件型号	封装 ⁽¹⁾	封装尺寸 (标称值)
TMAG5124-Q1	SOT-23 (3)	2.92mm × 1.30mm

(1) 如需了解所有可用封装，请参阅数据表末尾的封装选项附录。

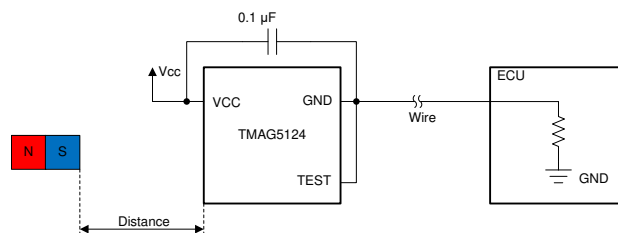

典型电路原理图



Table of Contents

1 特性	1	8.4 Device Functional Modes.....	16
2 应用	1	9 Application and Implementation	17
3 说明	1	9.1 Application Information.....	17
4 Revision History	2	9.2 Typical Applications.....	17
5 Device Comparison	3	10 Power Supply Recommendations	20
6 Pin Configuration and Functions	3	10.1 Power Derating.....	20
7 Specifications	4	11 Layout	21
7.1 Absolute Maximum Ratings.....	4	11.1 Layout Guidelines.....	21
7.2 ESD Ratings.....	4	11.2 Layout Example.....	21
7.3 Recommended Operating Conditions.....	4	12 Device and Documentation Support	22
7.4 Thermal Information.....	4	12.1 Documentation Support.....	22
7.5 Electrical Characteristics.....	5	12.2 接收文档更新通知.....	22
7.6 Magnetic Characteristics.....	5	12.3 支持资源.....	22
7.7 Typical Characteristics.....	6	12.4 Trademarks.....	22
8 Detailed Description	11	12.5 Electrostatic Discharge Caution.....	22
8.1 Overview.....	11	12.6 术语表.....	22
8.2 Functional Block Diagram.....	11	13 Mechanical, Packaging, and Orderable Information	22
8.3 Feature Description.....	11		

4 Revision History

注：以前版本的页码可能与当前版本的页码不同

DATE	REVISION	NOTES
November 2021	*	Initial Release

5 Device Comparison

表 5-1. Device Comparison

DEVICE	DEVICE OPTION	THRESHOLD LEVEL (BOP)	LOW-CURRENT LEVEL
TMAG5124-Q1	A1	4 mT	3.5 mA
	B1	6 mT	
	C1	10 mT	
	D1	15 mT	
	E1	4 mT	6 mA
	F1	6 mT	
	G1	10 mT	
	H1	15 mT	

6 Pin Configuration and Functions



图 6-1. DBZ Package 3-Pin SOT-23 Top View

表 6-1. Pin Functions

PIN		TYPE	DESCRIPTION
NO.	NAME		
1	VCC	Power supply	Power supply of 2.7 V to 38 V. Connect a ceramic capacitor with a value of at least 0.01 μ F between VCC and ground.
2	TEST	—	Must be connected to pin 3.
3	GND	Ground	Ground reference.

7 Specifications

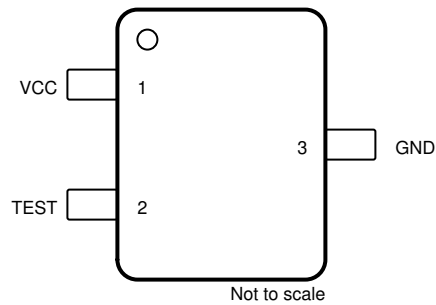
7.1 Absolute Maximum Ratings

over operating free-air temperature range (unless otherwise noted)⁽¹⁾

		MIN	MAX	UNIT
V _{CC}	Power supply voltage	- 20	40	V
Magnetic Flux Density, B _{MAX}		Unlimited		T
T _J	Junction temperature		170	°C
Storage temperature, T _{stg}		- 65	150	°C

- (1) Stresses beyond those listed under *Absolute Maximum Rating* may cause permanent damage to the device. These are stress ratings only, which do not imply functional operation of the device at these or any other conditions beyond those indicated under *Recommended Operating Condition*. Exposure to absolute-maximum-rated conditions for extended periods may affect device reliability.

7.2 ESD Ratings

			VALUE	UNIT
V _(ESD)	Electrostatic discharge	Human-body model (HBM), per AEC Q100-002 ⁽¹⁾ HBM ESD classification level 2	±2000	V
		Charged-device model (CDM), per AEC Q100-011 CDM ESD Classification level C4A	±500	

- (1) AEC Q100-002 indicates that HBM stressing shall be in accordance with the ANSI/ESDA/JEDEC JS-001 specification.

7.3 Recommended Operating Conditions

over operating free-air temperature range (unless otherwise noted)

		MIN	MAX	UNIT
V _{CC}	Power supply voltage	2.7	38	V
T _A	Ambient temperature	- 40	150	°C

7.4 Thermal Information

THERMAL METRIC ⁽¹⁾		TMAG5124	UNIT
		DBV (SOT-23)	
		3 PINS	
R _{θJA}	Junction-to-ambient thermal resistance	198.5	°C/W
R _{θJC(top)}	Junction-to-case (top) thermal resistance	88.9	°C/W
R _{θJB}	Junction-to-board thermal resistance	28	°C/W
Ψ _{JT}	Junction-to-top characterization parameter	4	°C/W
Ψ _{JB}	Junction-to-board characterization parameter	27.7	°C/W
R _{θJC(bot)}	Junction-to-case (bottom) thermal resistance	—	°C/W

- (1) For more information about traditional and new thermal metrics, see the [Semiconductor and IC Package Thermal Metrics](#) application report.

7.5 Electrical Characteristics

over operating free-air temperature range (unless otherwise noted)

PARAMETER		TEST CONDITIONS	MIN	TYP	MAX	UNIT
POWER SUPPLY						
$I_{CC(L1)}$	Low-level supply current option 1	$V_{CC} = 2.7\text{ V to }38\text{ V}$, $T_A = -40^\circ\text{C to }150^\circ\text{C}$	2	3.5	5	mA
$I_{CC(L2)}$	Low-level supply current option 2	$V_{CC} = 2.7\text{ V to }38\text{ V}$, $T_A = -40^\circ\text{C to }150^\circ\text{C}$	4.8	6	7.8	
$I_{CC(H)}$	High-level supply current	$V_{CC} = 2.7\text{ V to }38\text{ V}$, $T_A = -40^\circ\text{C to }150^\circ\text{C}$	10.5	14.5	18	
I_{RCC}	Reverse supply current	$V_{RCC} = -20\text{ V}$			-100	μA
t_{ON}	Power-on-time			62.5		μs
OUTPUT						
di/dt	Supply Current Slew Rate	$V_{CC} = 12\text{ V}$, $I_{CC(L)}$ to $I_{CC(H)}$, $I_{CC(H)}$ to $I_{CC(L)}$, $C_{BYP} = 0.01\mu\text{F}$		10		$\text{mA}/\mu\text{s}$
t_{PD}	Propagation delay time	Change in B field to change in output		12.5		μs
FREQUENCY RESPONSE						
f_{CHOP}	Chopping frequency			320		kHz
f_{BW}	Signal bandwidth			40		

7.6 Magnetic Characteristics

over operating free-air temperature range (unless otherwise noted)

PARAMETER		TEST CONDITIONS	MIN	TYP	MAX	UNIT
TMAG5124A, TMAG5124E						
B_{OP}	Magnetic field operating point	$V_{CC} = 2.7\text{ V to }38\text{ V}$, $T_A = -40^\circ\text{C to }150^\circ\text{C}$	3	4	5	mT
B_{RP}	Magnetic field release point		1	2	3	
B_{HYS}	Magnetic hysteresis $B_{OP} - B_{RP}$		0.6	2	3.4	
TMAG5124B, TMAG5124F						
B_{OP}	Magnetic field operating point	$V_{CC} = 2.7\text{ V to }38\text{ V}$, $T_A = -40^\circ\text{C to }150^\circ\text{C}$	5	6	7	mT
B_{RP}	Magnetic field release point		3	4	5	
B_{HYS}	Magnetic hysteresis $B_{OP} - B_{RP}$		0.6	2	3.4	
TMAG5124C, TMAG5124G						
B_{OP}	Magnetic field operating point	$V_{CC} = 2.7\text{ V to }38\text{ V}$, $T_A = -40^\circ\text{C to }150^\circ\text{C}$	8.8	10	11	mT
B_{RP}	Magnetic field release point		6.8	8	9.4	
B_{HYS}	Magnetic hysteresis $B_{OP} - B_{RP}$		0.6	2	3.4	
TMAG5124D, TMAG5124H						
B_{OP}	Magnetic field operating point	$V_{CC} = 2.7\text{ V to }38\text{ V}$, $T_A = -40^\circ\text{C to }150^\circ\text{C}$	13.6	15	16.1	mT
B_{RP}	Magnetic field release point		11.4	13	14.2	
B_{HYS}	Magnetic hysteresis $B_{OP} - B_{RP}$		0.6	2	3.4	

7.7 Typical Characteristics

7.7.1 TMAG5124A and TMAG5124E



图 7-1. B_{OP} vs. Temperature



图 7-2. B_{OP} vs. V_{CC}

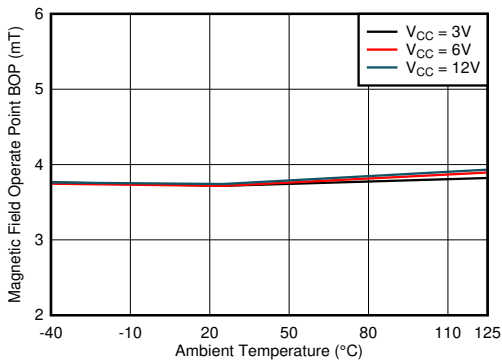

图 7-3. B_{RP} vs. Temperature

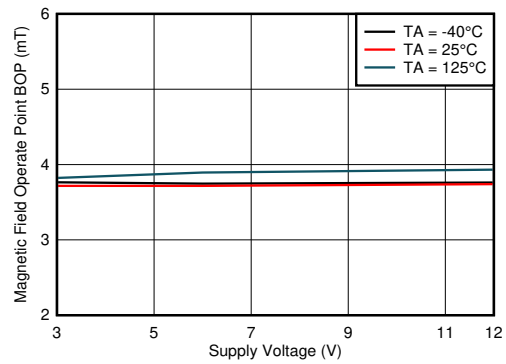

图 7-4. B_{RP} vs. V_{CC}

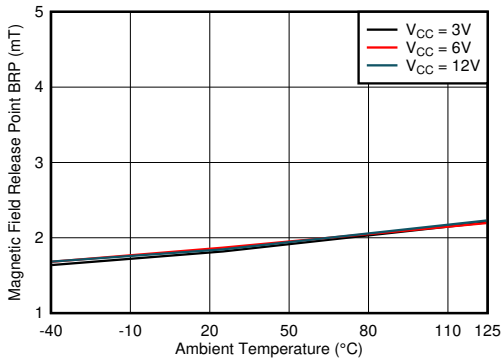

图 7-5. Hysteresis vs. Temperature

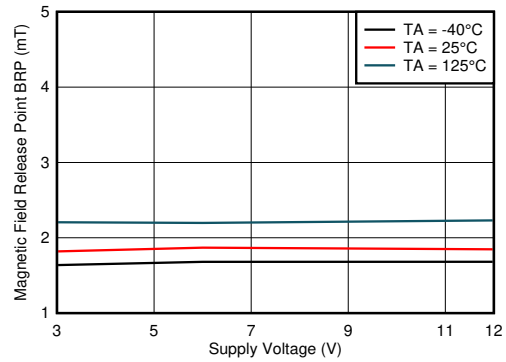

图 7-6. Hysteresis vs. V_{CC}

7.7.2 TMAG5124B and TMAG5124F

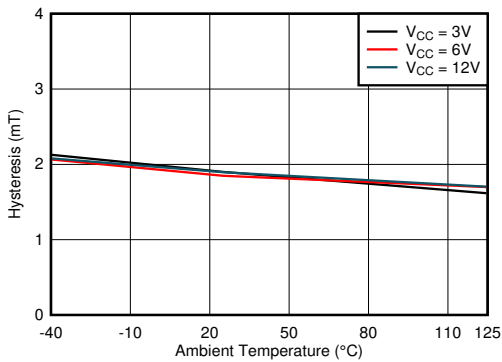

图 7-7. B_{OP} vs. Temperature

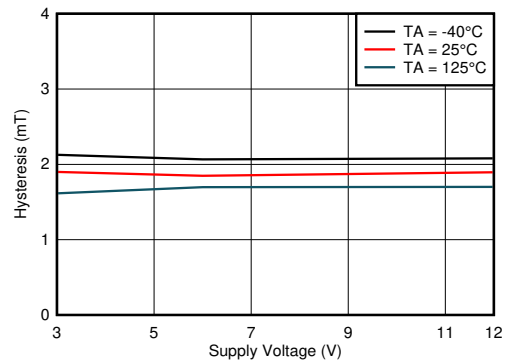

图 7-8. B_{OP} vs. V_{CC}

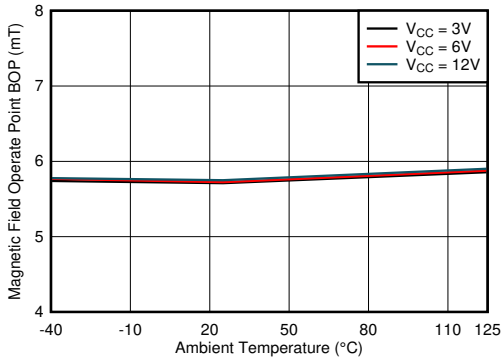

图 7-9. B_{RP} vs. Temperature

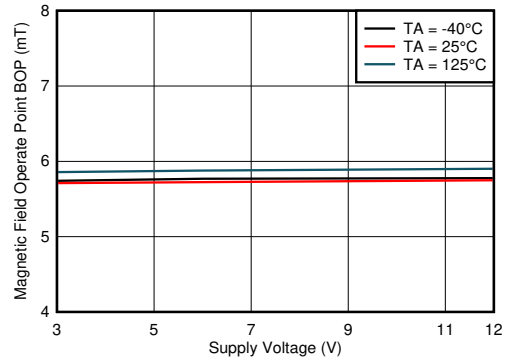

图 7-10. B_{RP} vs. V_{CC}

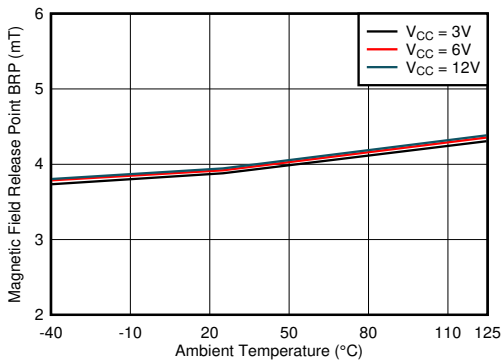

图 7-11. Hysteresis vs. Temperature

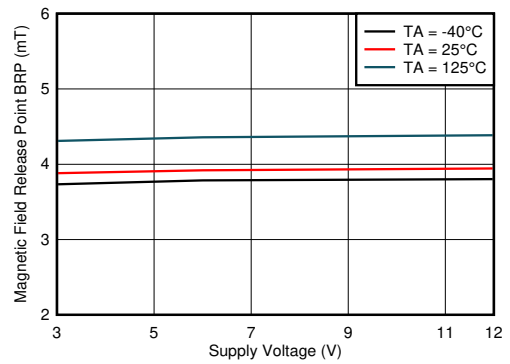

图 7-12. Hysteresis vs. V_{CC}

7.7.3 TMAG5124C and TMAG5124G

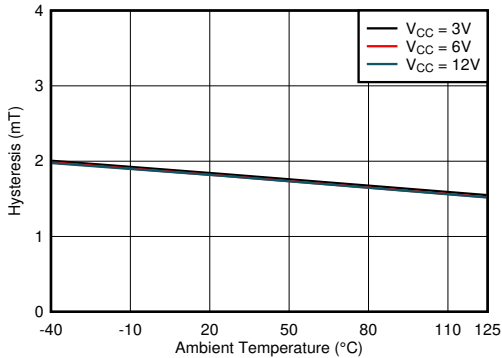

图 7-13. B_{OP} vs. Temperature

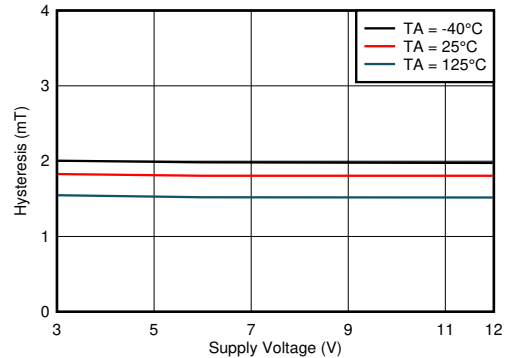

图 7-14. B_{OP} vs. V_{CC}

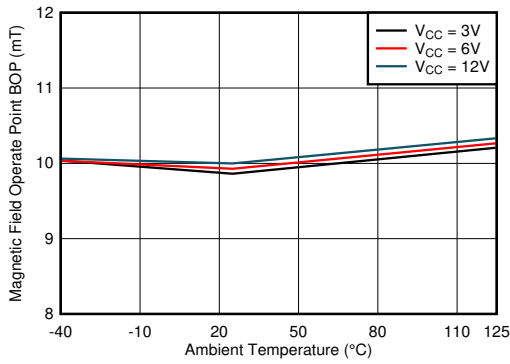

图 7-15. B_{RP} vs. Temperature

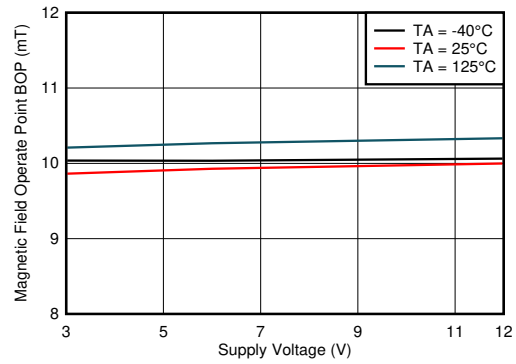

图 7-16. B_{RP} vs. V_{CC}

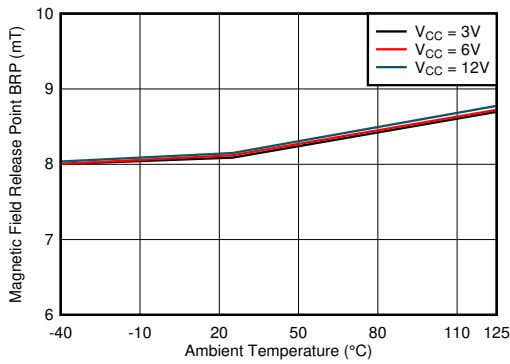

图 7-17. Hysteresis vs. Temperature

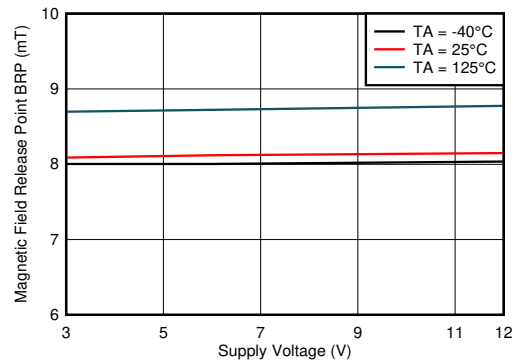

图 7-18. Hysteresis vs. V_{CC}

7.7.4 TMAG5124D and TMAG5124H

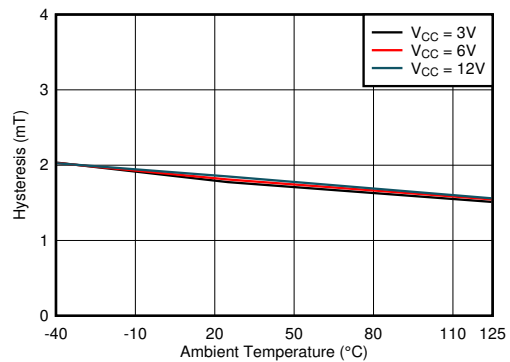

图 7-19. B_{OP} vs. Temperature

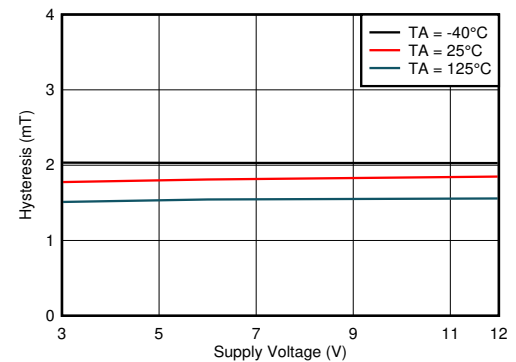

图 7-20. B_{OP} vs. V_{CC}

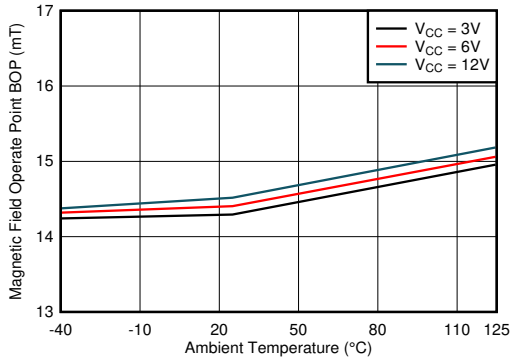

图 7-21. B_{RP} vs. Temperature

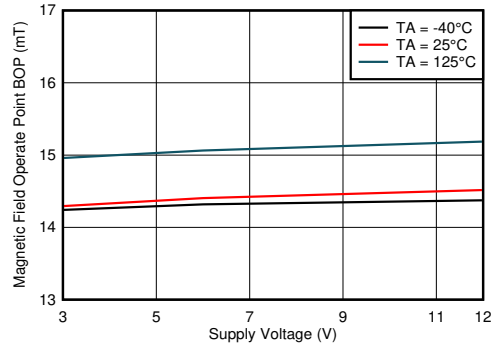

图 7-22. B_{RP} vs. V_{CC}

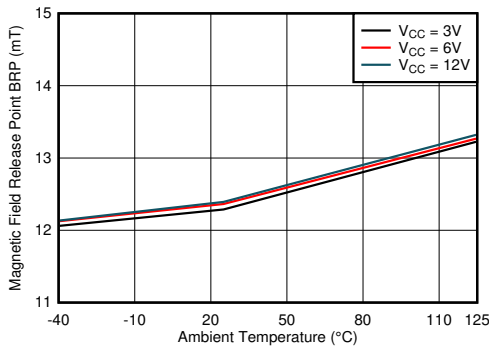

图 7-23. Hysteresis vs. Temperature

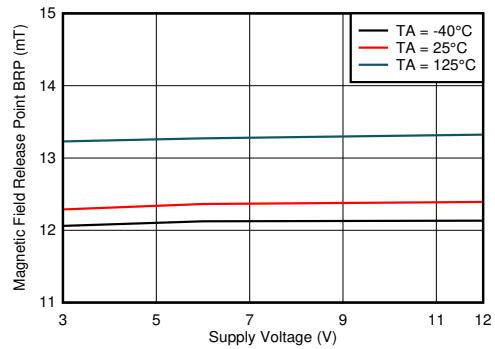

图 7-24. Hysteresis vs. V_{CC}

7.7.5 Current Output Level

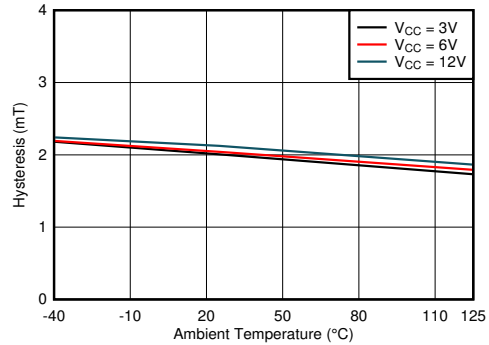
7.7.5.1 Low-Level Current Output for TMAG5124A/B/C/D

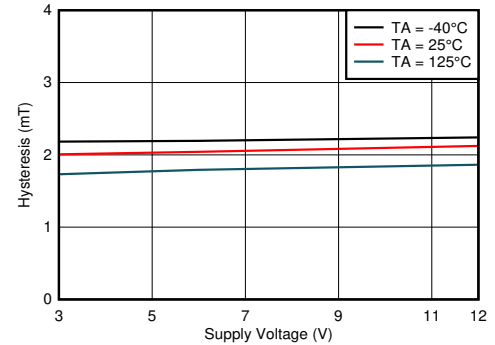
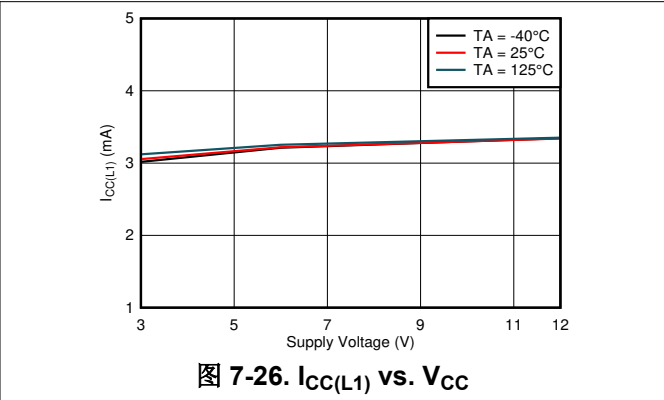
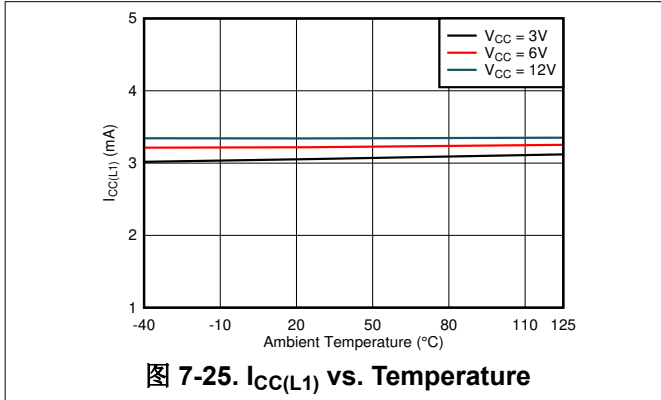

7.7.5.2 Low-Level Current Output for TMAG5124E/F/G/H

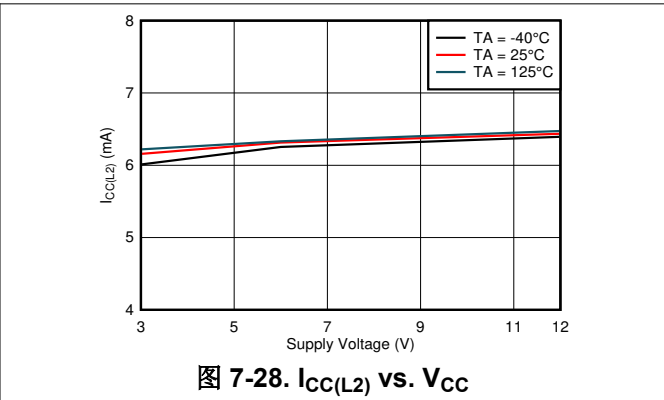
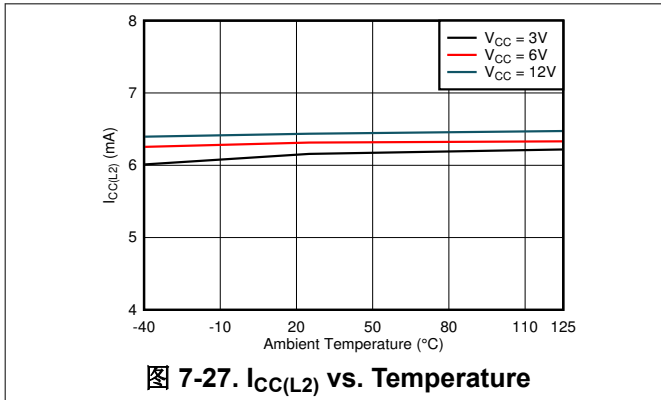

7.7.5.3 High-Level Current Output for Every Version

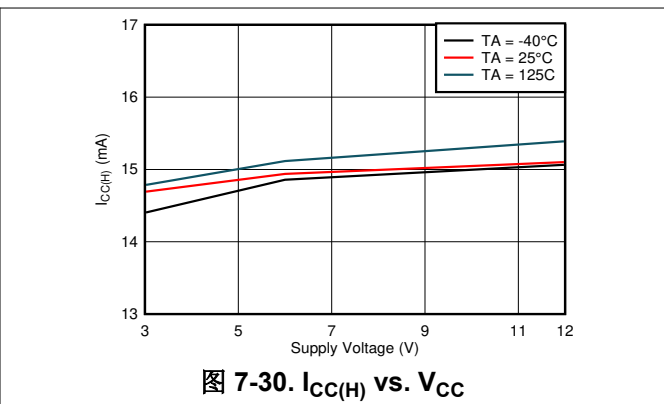
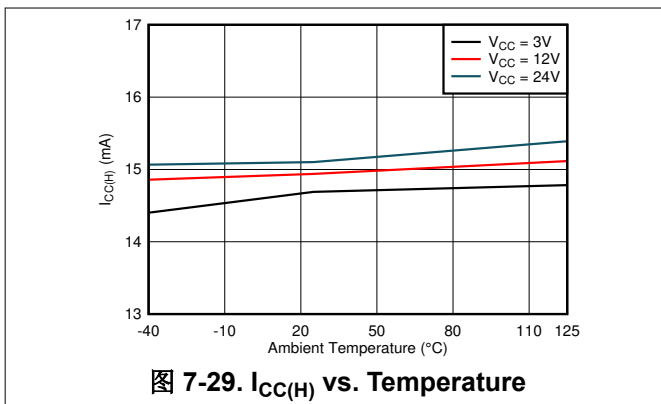

8 Detailed Description

8.1 Overview

The TMAG5124-Q1 is a magnetic sensor with a current interface, also called 2-wire interface, that indicates when the magnetic field threshold has been reached. A specific current level is generated depending on its status. All versions have a high-current level of 14.5 mA. Version A to D have a low-current level of 3.5 mA while version E to H have a low-current level of 6 mA.

The field polarity is defined as follows: a south pole near the marked side of the package has a positive magnetic field. A north pole near the marked side of the package has a negative magnetic field.

The unipolar south configuration allows the hall sensor to only respond to a south pole. A strong magnetic field of south polarity will cause the device to go into a low-current level (operate point, BOP), and a weaker magnetic field will cause the device to go into a high-current level (release point, BRP). Hysteresis is included in between the operate and release points, so magnetic field noise will not trip the device level accidentally.

The device does not have an output, therefore the magnitude of device supply current will indicate if the magnetic field exceeds the threshold or not. A resistor can be placed before the VCC pin or after the GND pin to transform the current into a voltage that can be read by a microcontroller. See [Application and Implementation](#) for more information.

8.2 Functional Block Diagram



图 8-1. Block Diagram

8.3 Feature Description

8.3.1 Field Direction Definition

图 8-2 shows that the TMAG5124-Q1 is sensitive to a south pole near the marked side of the package.

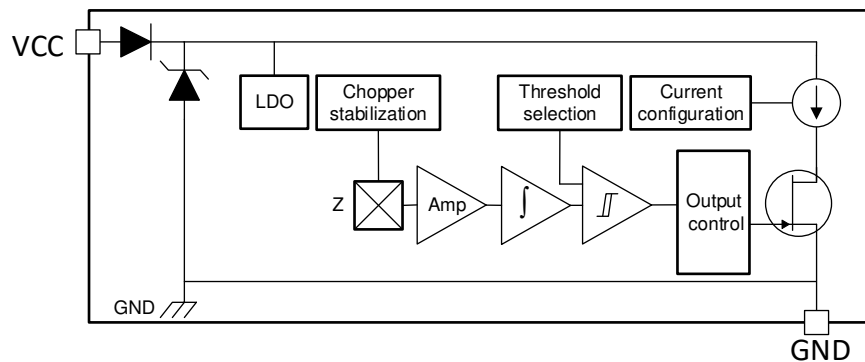

图 8-2. Field Direction Definition

8.3.2 Device Output

When the device is powered on and no magnetic field is applied, the output stays at $I_{CC(H)}$. If the magnetic field increases above the B_{OP} value, then the output turns to $I_{CC(L)}$. The output will remain at this value until the magnetic field decreases to a field value smaller than the B_{RP} threshold.

The $I_{CC(H)}$ for all TMAG5124x versions is between 12 mA to 17 mA. The $I_{CC(L)}$ option for the TMAG5124D versions is $I_{CC(L1)}$, which is typically 3.5 mA, while The $I_{CC(L)}$ for the TMAG5124H versions is $I_{CC(L2)}$ and is typically 6 mA.

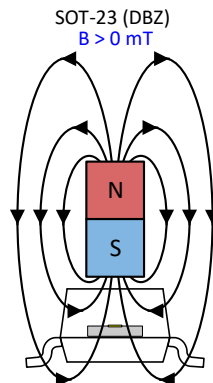

图 8-3. Unipolar Functionality

8.3.3 Protection Circuits

The TMAG5124-Q1 device is protected against load dump and reverse polarity conditions.

8.3.3.1 Load Dump Protection

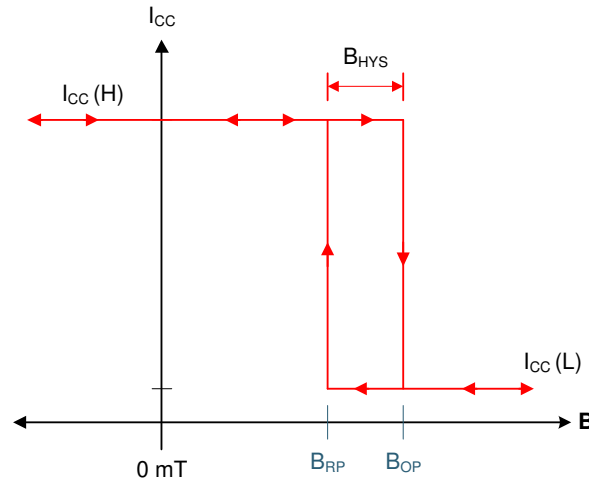
The TMAG5124-Q1 device operates at DC V_{CC} conditions up to 38 V nominally, and can additionally withstand $V_{CC} = 40 \text{ V}$. No current-limiting series resistor is required for this protection.

8.3.3.2 Reverse Polarity Protection

The TMAG5124-Q1 device is protected in the event that the VCC pin and the GND pin are reversed (up to -20 V).

8.3.4 Power-On Time

图 8-4 shows the behavior of the device after the V_{CC} voltage is applied and when the field is below the B_{OP} threshold. When the minimum value for V_{CC} is reached, the TMAG5124-Q1 will take time t_{ON} to power up and then time t_d to update the output to a high level.

图 8-5 shows the behavior of the device after the V_{CC} voltage is applied and when the field is above the B_{OP} threshold. When the minimum value for V_{CC} is reached, the TMAG5124-Q1 will take time t_{ON} to power up and then time t_d to update the output to a high level.

The output value during t_{ON} is unknown in both cases. The output value during t_d will be set at high.



图 8-4. Power-On Time When $B < B_{OP}$



图 8-5. Power-On Time When $B > B_{OP}$

8.3.5 Hall Element Location

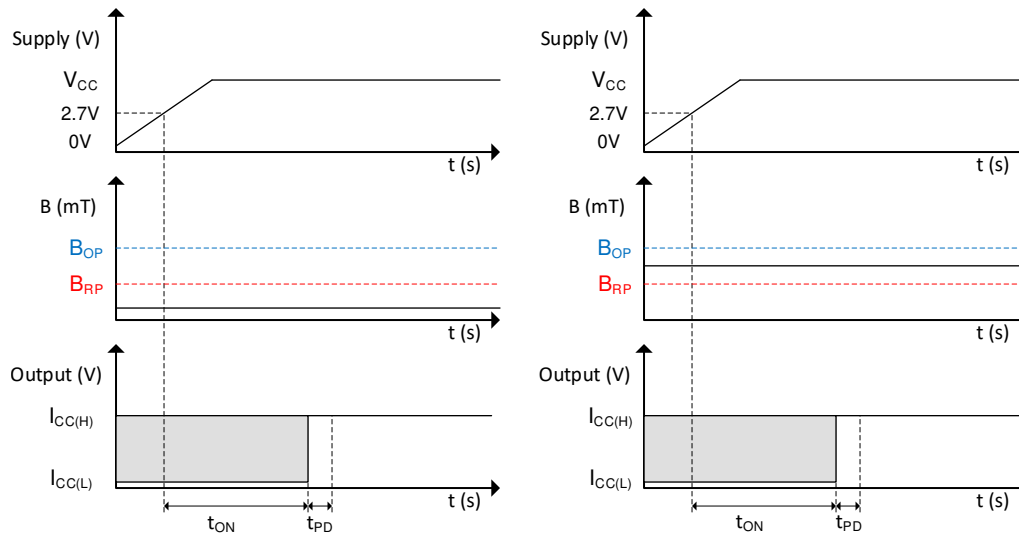
The sensing element inside the device is at the center of the package when viewed from the top. 图 8-6 shows the position of the sensor inside the package.

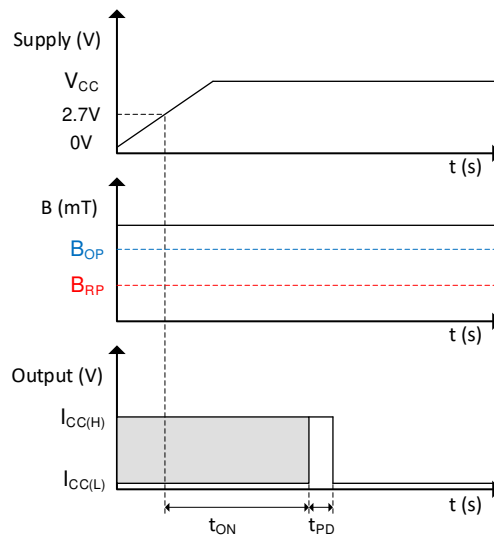

图 8-6. Hall Element Location

8.3.6 Propagation Delay

The TMAG5124-Q1 samples the Hall element at a nominal sampling interval of 12.5 μs to detect the presence of a magnetic south pole. Between each sampling interval, the device calculates the average magnetic field applied to the device. If this average value crosses the B_{OP} or B_{RP} threshold, the device changes the corresponding level as defined in 图 8-3. The hall sensor + magnet system is by nature asynchronous, therefore the propagation delay (t_d) will vary depending on when the magnetic field goes above the B_{OP} value. 图 8-7 shows that the output delay also depends on when the magnetic field goes above the B_{OP} value.

The first graph in 图 8-7 shows the typical case. The magnetic field goes above the B_{OP} value at the moment the output is updated. The part will only require one sampling period of 12.5 μs to update the output.

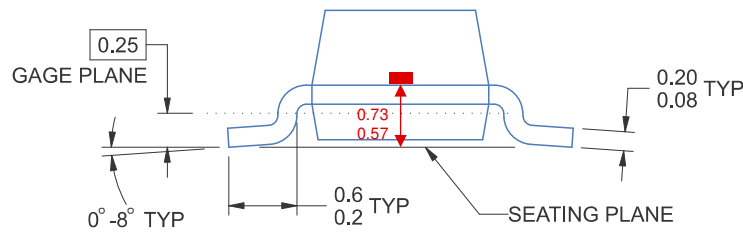
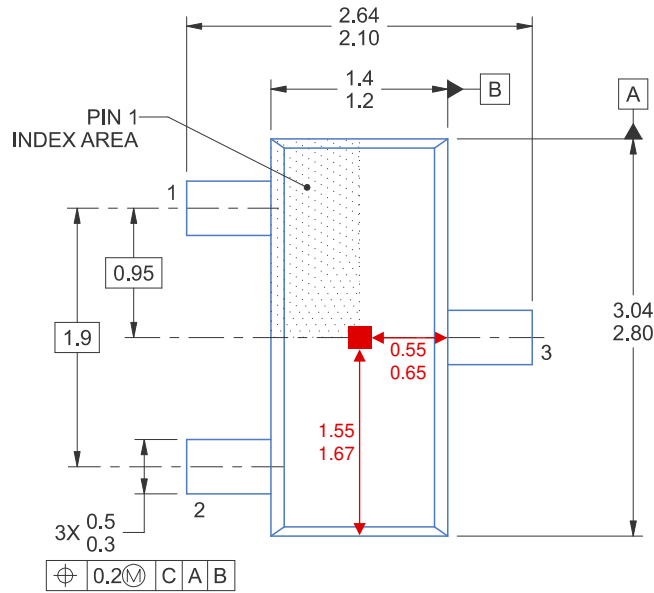
The second graph in 图 8-7 shows a magnetic field going above the B_{OP} value just before half of the sampling period. This is the best-case scenario where the output is updated in just half of the sampling period.

Finally, the third graph in 图 8-7 shows the worst-case scenario where the magnetic field goes above the B_{OP} value just after half of the sampling period. At the next output update, the device will still see the magnetic field under the B_{OP} threshold and will require a whole new sampling period to update the output.



图 8-7. Field Sampling Timing

图 8-8 shows the TMAG5124-Q1 propagation delay analysis when a magnetic south pole is applied. The Hall element of the TMAG5124-Q1 experiences an increasing magnetic field as a magnetic south pole approaches the device, as well as a decreasing magnetic field as a magnetic south pole moves away. At time t_1 , the magnetic field goes above the B_{OP} threshold. The output will then start to move after the propagation delay (t_d). This time will vary depending on when the sampling period is, as shown in 图 8-7. At t_2 , the output start pulling to the low current value. At t_3 , the output is completely pulled down to the lower current value. The same process happens on the other way when the magnetic value is going under the B_{RP} threshold.

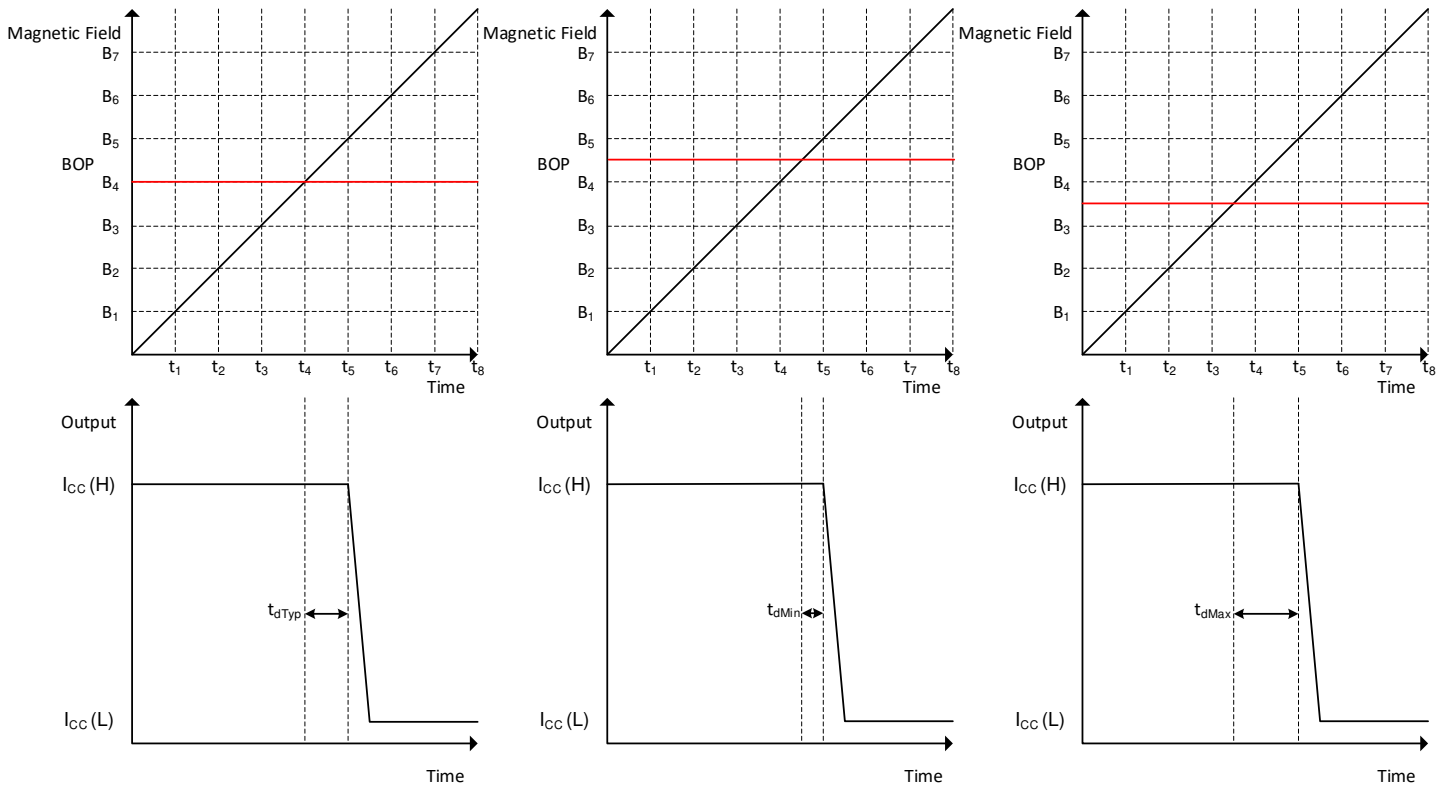

图 8-8. Propagation Delay

8.3.7 Chopper Stabilization

The Basic Hall-effect sensor consists of four terminals where a current is injected through two opposite terminals and a voltage is measured through the other opposite terminals. The voltage measured is proportional to the current injected and the magnetic field measured. By knowing the current injected, the device can then know the magnetic field strength. The problem is that the voltage generated is small in amplitude while the offset voltage generated is more significant. To create a precise sensor, the offset voltage must be minimized.

Chopper stabilization is one way to significantly minimize this offset. It is achieved by "spinning" the sensor and sequentially applying the bias current and measuring the voltage for each pair of terminals. This means that a measurement is completed once the spinning cycle is completed. The full cycle is completed after four measurements. The output of the sensor is connected to an amplifier and an integrator that will accumulate and filter out a voltage proportional to the magnetic field present. Finally, a comparator will switch the output if the voltage reaches either the BOP or BRP threshold (depending on which state the output voltage was previously in).

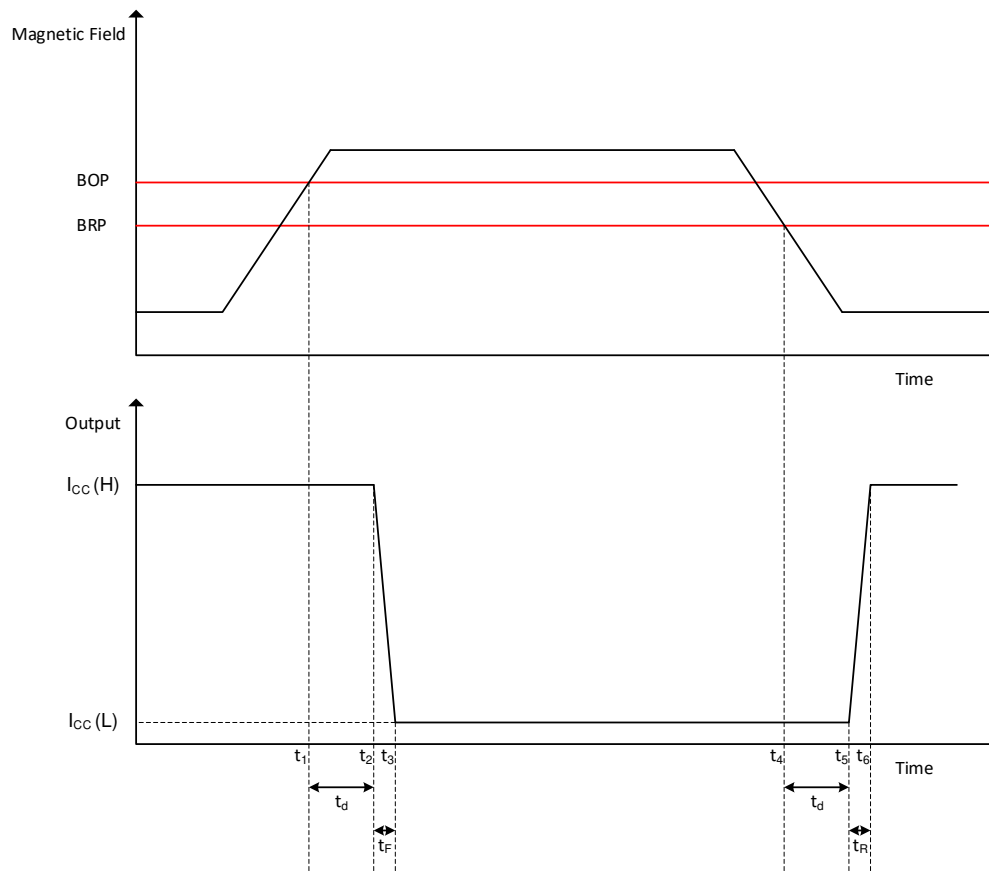
The frequency of each individual measurement is referred to as the Chopping frequency, or f_{CHOP} . The total conversion time is referred to as the Propagation delay time, t_{PD} , and is basically equal to $4/f_{\text{CHOP}}$. Finally, the Signal bandwidth, f_{BW} , represents the maximum value of the magnetic field frequency, and is equal to $(f_{\text{CHOP}}/4)/2$ as defined by the sampling theorem.

8.4 Device Functional Modes

The device operates in only one mode when operated within the *Recommended Operating Conditions*.

9 Application and Implementation

Note

以下应用部分中的信息不属于 TI 器件规格的范围，TI 不担保其准确性和完整性。TI 的客户应负责确定器件是否适用于其应用。客户应验证并测试其设计，以确保系统功能。

9.1 Application Information

The TMAG5124 is typically used in magnetic-field sensing applications to detect the proximity of a magnet. The magnet is often attached to a movable component in the system.

The TMAG5124 is a Hall sensor that uses current as the signal of interest. Unlike voltage signals, current signals are much more robust for common problems voltages face in electrical systems, such as voltage source fluctuations and source impedance. A major factor that often leads to the choice of a current signal device is immunity to loop impedance, meaning the signal is capable of being transmitted long distances with ease. To accomplish this, the device requires a termination resistor at the end of the path for interfacing the reconstructed voltage to an input, such as a comparator. Also, diagnostic tools are easily implemented, as disconnects in the loop are easily detected due to a lack of signal.

9.2 Typical Applications

9.2.1 High-Side and Low-Side Typical Application Diagrams



图 9-1. Typical High-Side Sensing Diagram



图 9-2. Typical Low-Side Sensing Diagram

9.2.1.1 Design Requirements

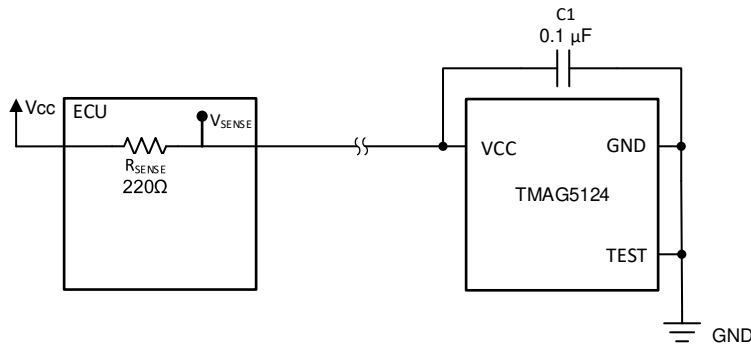
For this design example, use the parameters listed in 表 9-1.

表 9-1. Design Parameters

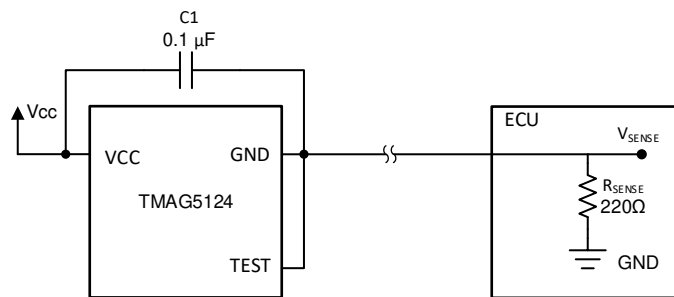
DESIGN PARAMETER	EXAMPLE VALUE
V _{CC}	12 V
TMAG5124 Device	TMAG5124A1
Magnet	1-cm Cube NdFeB (N45)
Minimum magnet distance	3 cm
Magnetic flux density at closest distance	5.0 mT
Magnetic flux density when magnet moves away	Close to 0 mT

9.2.1.2 Detailed Design Procedure

When designing a digital-switch magnetic sensing system, three variables should always be considered: the magnet, sensing distance, and threshold of the sensor.

The TMAG5124 device has a detection threshold specified by parameter B_{OP}, which is the amount of magnetic flux required to pass through the Hall sensor mounted inside the TMAG5124. To reliably activate the sensor, the magnet must apply a flux greater than the maximum specified B_{OP}. In such a system, the sensor typically detects the magnet before it has moved to the closest position, but designing to the maximum parameter ensures robust turn-on for all possible values of B_{OP}. When the magnet moves away from the sensor, it must apply less than the minimum specified B_{RP} to reliably release the sensor.

Magnets are made from various ferromagnetic materials that have tradeoffs in cost, drift with temperature, absolute maximum temperature ratings, remanence or residual induction (B_r), and coercivity (H_c). The B_r and the dimensions of a magnet determine the magnetic flux density (B) it produces in 3-dimensional space. For simple magnet shapes, such as rectangular blocks and cylinders, there are simple equations that solve B at a given distance centered with the magnet.



图 9-3. Rectangular Block and Cylinder Magnets

Use 方程式 1 for the rectangular block shown in 图 9-3:

$$\vec{B} = \frac{B_r}{\pi} \left(\arctan \left(\frac{WL}{2D\sqrt{4D^2 + W^2 + L^2}} \right) - \arctan \left(\frac{WL}{2(D+T)\sqrt{4(D+T)^2 + W^2 + L^2}} \right) \right) \quad (1)$$

Use 方程式 2 for the cylinder shown in 图 9-3:

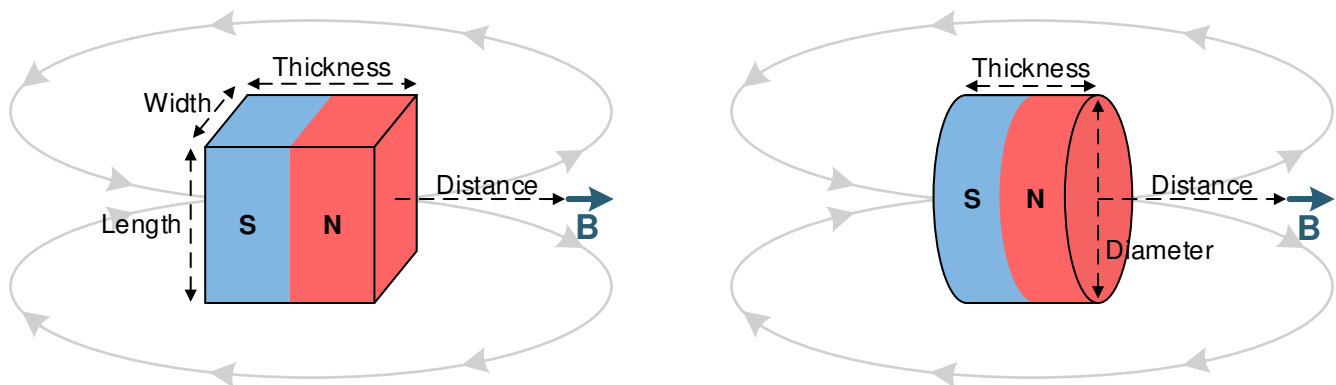
$$\vec{B} = \frac{B_r}{2} \left(\frac{D+T}{\sqrt{(0.5C)^2 + (D+T)^2}} - \frac{D}{\sqrt{(0.5C)^2 + D^2}} \right) \quad (2)$$

where

- W is width.
- L is length.
- T is thickness (the direction of magnetization).
- D is distance.
- C is diameter.

The *Hall Effect Switch Magnetic Field Calculator* is an online tool that uses these formulas available here: <http://www.ti.com/product/tmag5124>.

All magnetic materials generally have a lower B_r at higher temperatures. Systems should have margin to account for this, as well as for mechanical tolerances.

For the TMAG5124A1, the maximum B_{OP} is 5 mT. When choosing a 1-cm cube NdFeB N45 magnet, 方程式 1 shows that this point occurs at 3 cm. This means that the magnet will activate the sensor if the design places the magnet within 3 cm from the sensor during a "turn-on" event. If the magnet is pulled away from the device, the magnetic field will go below the minimum B_{RP} point and the device will return to its initial state.

9.2.1.3 Application Curve



图 9-4. Magnetic Profile of a 1-cm Cube NdFeB Magnet

10 Power Supply Recommendations

The TMAG5124-Q1 is powered from a DC power supply of 2.7 V to 38 V. A decoupling capacitor close to the device must be used to provide local energy with minimal inductance. TI recommends using a ceramic capacitor with a value of at least 0.01 μF .

10.1 Power Derating

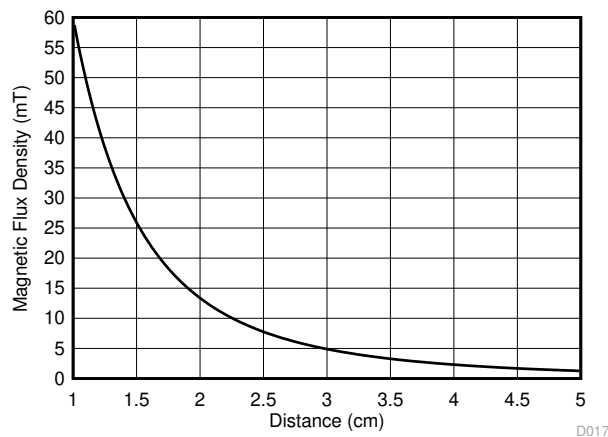
The device is specified from -40°C to 150°C for a voltage rating of 2.7 V to 38 V. The part drains at its maximum current of 17 mA, therefore the maximum voltage that can be applied to the device will depend on what maximum ambient temperature is acceptable for the application. The curve in [图 10-1](#) shows the maximum acceptable power supply voltage versus the maximum acceptable ambient temperature.

Use [方程式 3](#), [方程式 4](#), and [方程式 5](#) to populate the data shown in [图 10-1](#):

$$T_J = T_A + \Delta T \quad (3)$$

where

- T_J is the junction temperature.
- T_A is the ambient temperature.
- ΔT is the difference between the junction temperature and the ambient temperature.

$$\Delta T = P_D \times R_{\theta JA} \quad (4)$$

where

- P_D is the power dissipated by the part.
- $R_{\theta JA}$ is the junction to ambient thermal resistance.

$$P_D = V_{CC} \times I_{CC} \quad (5)$$

where

- V_{CC} is the voltage supply of the device.
- I_{CC} is the current consumption of the device.

Combining these equations gives [方程式 6](#), which can be used to determine the maximum voltage the part can handle in regards of the ambient temperature.

$$V_{CC \max} = \frac{T_{J \max} - T_A}{I_{CC \max} \times R_{\theta JA}} \quad (6)$$

For example, if an application must work under an ambient temperature maximum of 100°C , and the $T_{J \max}$, $R_{\theta JA}$ and $I_{CC \max}$ are the same values defined in the data sheet, then the maximum voltage allowed for this application is calculated in [方程式 7](#):

$$V_{CC \max} = \frac{170^{\circ}\text{C} - 120^{\circ}\text{C}}{17 \text{ mA} \times 198.5^{\circ}\text{C} / \text{W}} = 14.82 \text{ V} \quad (7)$$



图 10-1. Power Derating Curve

11 Layout

11.1 Layout Guidelines

The bypass capacitor should be placed near the TMAG5124-Q1 to reduce noise. The TEST pin must be connected directly to the GND pin. It is good practice to connect the pins under the package to reduce the connection length.

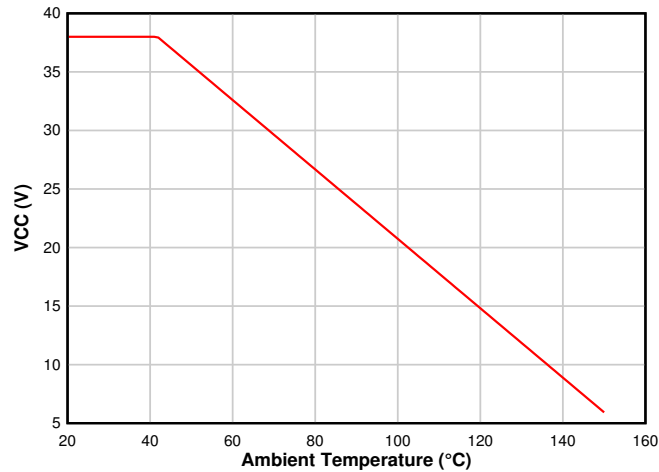
Generally, using PCB copper planes underneath the TMAG5124-Q1 device has no effect on magnetic flux and does not interfere with device performance. This is because copper is not a ferromagnetic material. However, if nearby system components contain iron or nickel, they may redirect magnetic flux in unpredictable ways.

11.2 Layout Example



图 11-1. TMAG5124-Q1 Layout Example

12 Device and Documentation Support

12.1 Documentation Support

12.2 接收文档更新通知

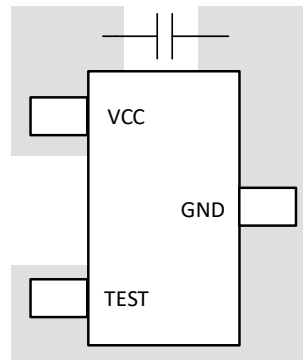
要接收文档更新通知，请导航至 [ti.com](https://www.ti.com) 上的器件产品文件夹。点击 [订阅更新](#) 进行注册，即可每周接收产品信息更改摘要。有关更改的详细信息，请查看任何已修订文档中包含的修订历史记录。

12.3 支持资源

[TI E2E™ 支持论坛](#) 是工程师的重要参考资料，可直接从专家获得快速、经过验证的解答和设计帮助。搜索现有解答或提出自己的问题可获得所需的快速设计帮助。

链接的内容由各个贡献者“按原样”提供。这些内容并不构成 TI 技术规范，并且不一定反映 TI 的观点；请参阅 TI 的《[使用条款](#)》。

12.4 Trademarks

TI E2E™ is a trademark of Texas Instruments.

所有商标均为其各自所有者的财产。

12.5 Electrostatic Discharge Caution



This integrated circuit can be damaged by ESD. Texas Instruments recommends that all integrated circuits be handled with appropriate precautions. Failure to observe proper handling and installation procedures can cause damage.

ESD damage can range from subtle performance degradation to complete device failure. Precision integrated circuits may be more susceptible to damage because very small parametric changes could cause the device not to meet its published specifications.

12.6 术语表

[TI 术语表](#) 本术语表列出并解释了术语、首字母缩略词和定义。

13 Mechanical, Packaging, and Orderable Information

The following pages include mechanical, packaging, and orderable information. This information is the most current data available for the designated devices. This data is subject to change without notice and revision of this document. For browser-based versions of this data sheet, refer to the left-hand navigation.

PACKAGING INFORMATION

Orderable Device	Status (1)	Package Type	Package Drawing	Pins	Package Qty	Eco Plan (2)	Lead finish/ Ball material (6)	MSL Peak Temp (3)	Op Temp (°C)	Device Marking (4/5)	Samples
TMAG5124A1CEDBZRQ1	ACTIVE	SOT-23	DBZ	3	3000	RoHS & Green	SN	Level-3-260C-168 HR	-40 to 150	4A1Z	Samples
TMAG5124B1CEDBZRQ1	ACTIVE	SOT-23	DBZ	3	3000	RoHS & Green	SN	Level-3-260C-168 HR	-40 to 150	4B1Z	Samples
TMAG5124C1CEDBZRQ1	ACTIVE	SOT-23	DBZ	3	3000	RoHS & Green	SN	Level-3-260C-168 HR	-40 to 150	4C1Z	Samples
TMAG5124D1CEDBZRQ1	ACTIVE	SOT-23	DBZ	3	3000	RoHS & Green	SN	Level-3-260C-168 HR	-40 to 150	4D1Z	Samples
TMAG5124E1CEDBZRQ1	ACTIVE	SOT-23	DBZ	3	3000	RoHS & Green	SN	Level-3-260C-168 HR	-40 to 150	4E1Z	Samples
TMAG5124F1CEDBZRQ1	ACTIVE	SOT-23	DBZ	3	3000	RoHS & Green	SN	Level-3-260C-168 HR	-40 to 150	4F1Z	Samples
TMAG5124G1CEDBZRQ1	ACTIVE	SOT-23	DBZ	3	3000	RoHS & Green	SN	Level-3-260C-168 HR	-40 to 150	4G1Z	Samples
TMAG5124H1CEDBZRQ1	ACTIVE	SOT-23	DBZ	3	3000	RoHS & Green	SN	Level-3-260C-168 HR	-40 to 150	4H1Z	Samples

(1) The marketing status values are defined as follows:

ACTIVE: Product device recommended for new designs.

LIFEBUY: TI has announced that the device will be discontinued, and a lifetime-buy period is in effect.

NRND: Not recommended for new designs. Device is in production to support existing customers, but TI does not recommend using this part in a new design.

PREVIEW: Device has been announced but is not in production. Samples may or may not be available.

OBSELETE: TI has discontinued the production of the device.

(2) **RoHS:** TI defines "RoHS" to mean semiconductor products that are compliant with the current EU RoHS requirements for all 10 RoHS substances, including the requirement that RoHS substance do not exceed 0.1% by weight in homogeneous materials. Where designed to be soldered at high temperatures, "RoHS" products are suitable for use in specified lead-free processes. TI may reference these types of products as "Pb-Free".

RoHS Exempt: TI defines "RoHS Exempt" to mean products that contain lead but are compliant with EU RoHS pursuant to a specific EU RoHS exemption.

Green: TI defines "Green" to mean the content of Chlorine (Cl) and Bromine (Br) based flame retardants meet JS709B low halogen requirements of <=1000ppm threshold. Antimony trioxide based flame retardants must also meet the <=1000ppm threshold requirement.

(3) MSL, Peak Temp. - The Moisture Sensitivity Level rating according to the JEDEC industry standard classifications, and peak solder temperature.

(4) There may be additional marking, which relates to the logo, the lot trace code information, or the environmental category on the device.

(5) Multiple Device Markings will be inside parentheses. Only one Device Marking contained in parentheses and separated by a "~" will appear on a device. If a line is indented then it is a continuation of the previous line and the two combined represent the entire Device Marking for that device.

⁽⁶⁾ Lead finish/Ball material - Orderable Devices may have multiple material finish options. Finish options are separated by a vertical ruled line. Lead finish/Ball material values may wrap to two lines if the finish value exceeds the maximum column width.

Important Information and Disclaimer:The information provided on this page represents TI's knowledge and belief as of the date that it is provided. TI bases its knowledge and belief on information provided by third parties, and makes no representation or warranty as to the accuracy of such information. Efforts are underway to better integrate information from third parties. TI has taken and continues to take reasonable steps to provide representative and accurate information but may not have conducted destructive testing or chemical analysis on incoming materials and chemicals. TI and TI suppliers consider certain information to be proprietary, and thus CAS numbers and other limited information may not be available for release.

In no event shall TI's liability arising out of such information exceed the total purchase price of the TI part(s) at issue in this document sold by TI to Customer on an annual basis.

OTHER QUALIFIED VERSIONS OF TMAG5124-Q1 :

- Catalog : [TMAG5124](#)

NOTE: Qualified Version Definitions:

- Catalog - TI's standard catalog product

TAPE AND REEL INFORMATION

QUADRANT ASSIGNMENTS FOR PIN 1 ORIENTATION IN TAPE

*All dimensions are nominal

Device	Package Type	Package Drawing	Pins	SPQ	Reel Diameter (mm)	Reel Width W1 (mm)	A0 (mm)	B0 (mm)	K0 (mm)	P1 (mm)	W (mm)	Pin1 Quadrant
TMAG5124A1CEDBZRQ1	SOT-23	DBZ	3	3000	178.0	9.0	3.15	2.77	1.22	4.0	8.0	Q3
TMAG5124B1CEDBZRQ1	SOT-23	DBZ	3	3000	178.0	9.0	3.15	2.77	1.22	4.0	8.0	Q3
TMAG5124C1CEDBZRQ1	SOT-23	DBZ	3	3000	178.0	9.0	3.15	2.77	1.22	4.0	8.0	Q3
TMAG5124D1CEDBZRQ1	SOT-23	DBZ	3	3000	178.0	9.0	3.15	2.77	1.22	4.0	8.0	Q3
TMAG5124E1CEDBZRQ1	SOT-23	DBZ	3	3000	178.0	9.0	3.15	2.77	1.22	4.0	8.0	Q3
TMAG5124F1CEDBZRQ1	SOT-23	DBZ	3	3000	178.0	9.0	3.15	2.77	1.22	4.0	8.0	Q3
TMAG5124G1CEDBZRQ1	SOT-23	DBZ	3	3000	178.0	9.0	3.15	2.77	1.22	4.0	8.0	Q3
TMAG5124H1CEDBZRQ1	SOT-23	DBZ	3	3000	178.0	9.0	3.15	2.77	1.22	4.0	8.0	Q3

TAPE AND REEL BOX DIMENSIONS

*All dimensions are nominal

Device	Package Type	Package Drawing	Pins	SPQ	Length (mm)	Width (mm)	Height (mm)
TMAG5124A1CEDBZRQ1	SOT-23	DBZ	3	3000	180.0	180.0	18.0
TMAG5124B1CEDBZRQ1	SOT-23	DBZ	3	3000	180.0	180.0	18.0
TMAG5124C1CEDBZRQ1	SOT-23	DBZ	3	3000	180.0	180.0	18.0
TMAG5124D1CEDBZRQ1	SOT-23	DBZ	3	3000	180.0	180.0	18.0
TMAG5124E1CEDBZRQ1	SOT-23	DBZ	3	3000	180.0	180.0	18.0
TMAG5124F1CEDBZRQ1	SOT-23	DBZ	3	3000	180.0	180.0	18.0
TMAG5124G1CEDBZRQ1	SOT-23	DBZ	3	3000	180.0	180.0	18.0
TMAG5124H1CEDBZRQ1	SOT-23	DBZ	3	3000	180.0	180.0	18.0

GENERIC PACKAGE VIEW

DBZ 3

SOT-23 - 1.12 mm max height

SMALL OUTLINE TRANSISTOR

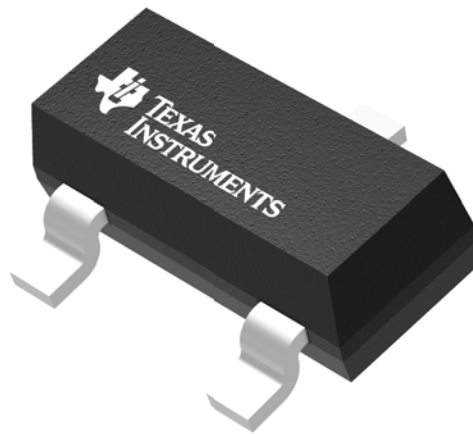

Images above are just a representation of the package family, actual package may vary.
Refer to the product data sheet for package details.

4203227/C

DBZ0003A

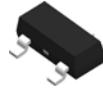

PACKAGE OUTLINE

SOT-23 - 1.12 mm max height

SMALL OUTLINE TRANSISTOR

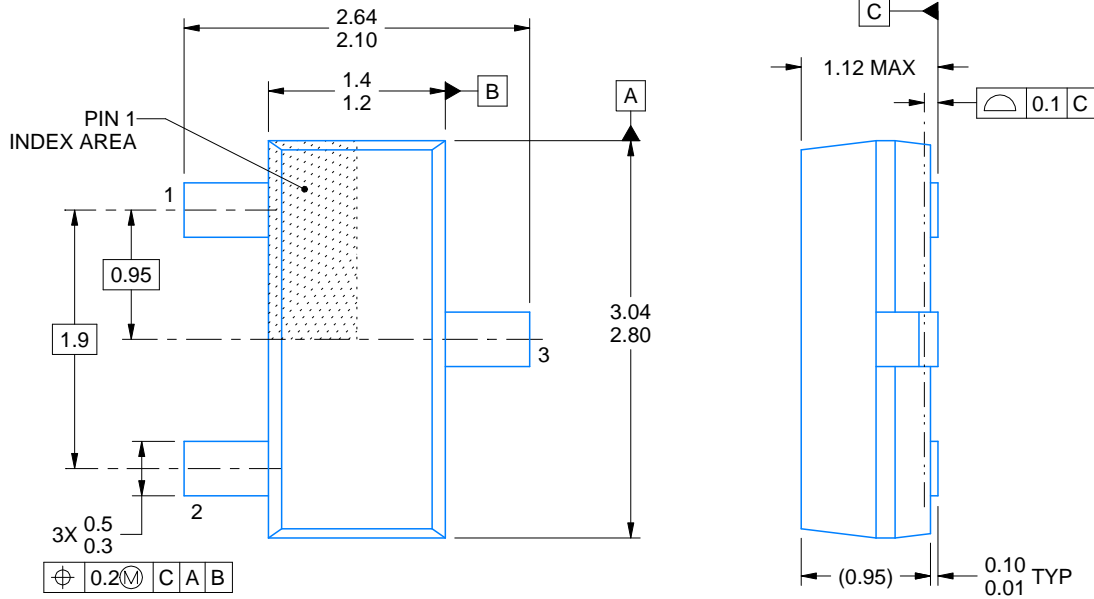

4214838/C 04/2017

NOTES:

1. All linear dimensions are in millimeters. Any dimensions in parenthesis are for reference only. Dimensioning and tolerancing per ASME Y14.5M.
2. This drawing is subject to change without notice.
3. Reference JEDEC registration TO-236, except minimum foot length.

EXAMPLE BOARD LAYOUT

DBZ0003A

SOT-23 - 1.12 mm max height

SMALL OUTLINE TRANSISTOR

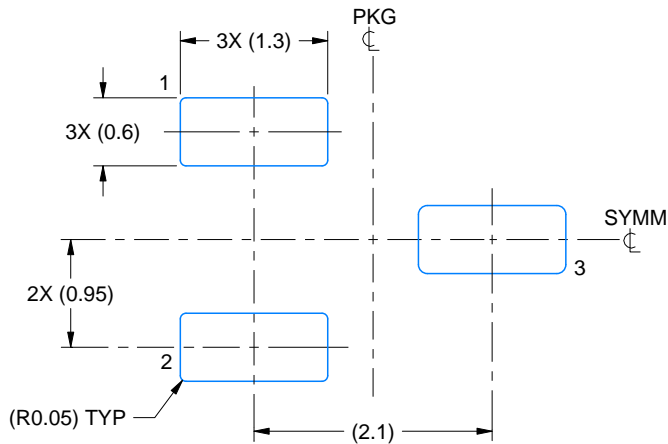

LAND PATTERN EXAMPLE
SCALE:15X

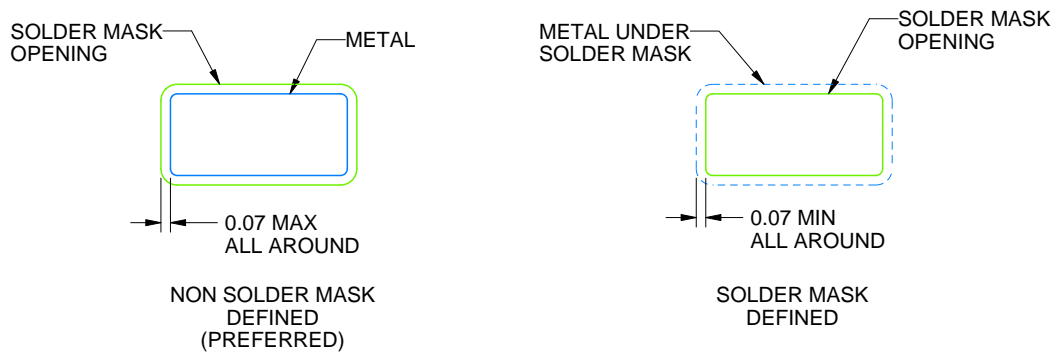

SOLDER MASK DETAILS

4214838/C 04/2017

NOTES: (continued)

4. Publication IPC-7351 may have alternate designs.
5. Solder mask tolerances between and around signal pads can vary based on board fabrication site.

EXAMPLE STENCIL DESIGN

DBZ0003A

SOT-23 - 1.12 mm max height

SMALL OUTLINE TRANSISTOR

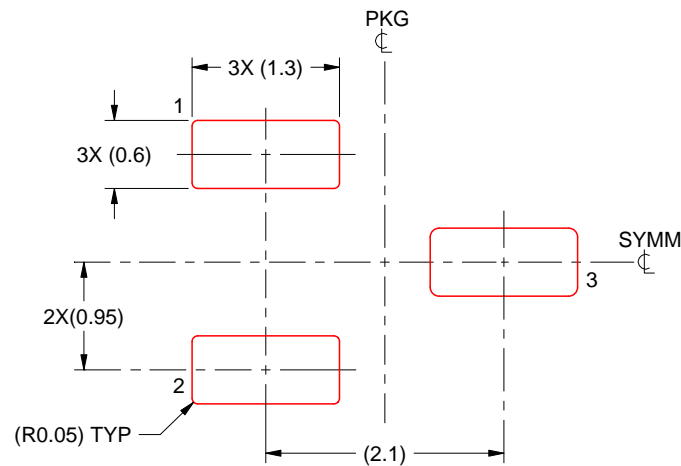

SOLDER PASTE EXAMPLE
BASED ON 0.125 THICK STENCIL
SCALE:15X

4214838/C 04/2017

NOTES: (continued)

6. Laser cutting apertures with trapezoidal walls and rounded corners may offer better paste release. IPC-7525 may have alternate design recommendations.
7. Board assembly site may have different recommendations for stencil design.

重要声明和免责声明

TI“按原样”提供技术和可靠性数据（包括数据表）、设计资源（包括参考设计）、应用或其他设计建议、网络工具、安全信息和其他资源，不保证没有瑕疵且不做任何明示或暗示的担保，包括但不限于对适销性、某特定用途方面的适用性或不侵犯任何第三方知识产权的暗示担保。

这些资源可供使用 TI 产品进行设计的熟练开发人员使用。您将自行承担以下全部责任：(1) 针对您的应用选择合适的 TI 产品，(2) 设计、验证并测试您的应用，(3) 确保您的应用满足相应标准以及任何其他功能安全、信息安全、监管或其他要求。

这些资源如有变更，恕不另行通知。TI 授权您仅可将这些资源用于研发本资源所述的 TI 产品的应用。严禁对这些资源进行其他复制或展示。您无权使用任何其他 TI 知识产权或任何第三方知识产权。您应全额赔偿因在这些资源的使用中对 TI 及其代表造成的任何索赔、损害、成本、损失和债务，TI 对此概不负责。

TI 提供的产品受 [TI 的销售条款](#) 或 [ti.com](#) 上其他适用条款/TI 产品随附的其他适用条款的约束。TI 提供这些资源并不会扩展或以其他方式更改 TI 针对 TI 产品发布的适用的担保或担保免责声明。

TI 反对并拒绝您可能提出的任何其他或不同的条款。

邮寄地址：Texas Instruments, Post Office Box 655303, Dallas, Texas 75265

Copyright © 2022，德州仪器 (TI) 公司