

TPSM82864A/TPSM82866A 具有集成电感器、采用 3.5mm × 4.0mm 薄超模压塑料 QFN 封装的 2.4V 至 5.5V 输入、4A/6A 降压电源模块

1 特性

- 效率高达 96%
- 优异的热性能
- 符合 CISPR-11 B 类标准
- 1% 的输出电压精度
- 可实现快速瞬态响应的 DCS-Control 拓扑
- 1.4mm 或 1.8mm 超薄型 QFN 封装
- 输入电压范围为 2.4V 至 5.5V
- 同一器件型号可提供：
 - 可调输出电压：0.6V 至 V_{IN}
 - 13 个集成式固定输出电压选项
- 具有窗口比较器的电源正常状态指示器
- 2.4MHz 开关频率
- 强制 PWM 或省电模式
- 4 μ A 工作静态电流
- 输出电压放电
- 100% 占空比模式
- 断续短路保护
- 热关断
- -40°C 至 125°C 工作温度范围
- 间距为 0.5mm 的 3.5mm × 4.0mm QFN 封装
- 35mm² 解决方案尺寸

2 应用

- 适用于 FPGA、CPU、ASIC 的内核电源
- 光学模块
- 医疗成像
- 工业运输
- 工厂自动化和控制
- 航天和国防

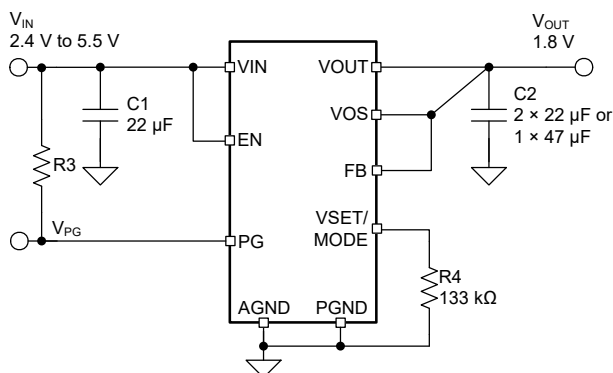

典型应用原理图 - 固定输出电压选项

3 说明

TPSM8286xA 器件系列包含 4A 和 6A 降压转换器电源模块，该电源模块经优化可实现小解决方案尺寸和高效率。该电源模块集成了同步降压转换器和电感器，可简化设计、减少外部元件并节省印刷电路板 (PCB) 面积。该器件采用紧凑的薄型封装，适用于通过标准表面贴装设备进行自动组装。

通过 DCS-Control 架构可实现严格的输出电压精度（即使与小型输出电容搭配工作时也是如此），以及出色的负载瞬态性能。该转换器在中高负载条件下以 PWM 模式运行，并在轻负载时自动进入省电模式运行，从而在整个负载电流范围内保持高效率。此类器件还可强制进入 PWM 模式运行，以实现超小的输出电压纹波。

器件的 EN 和 PG 引脚支持顺序配置，可带来灵活的系统设计。集成的软启动功能降低了输入电源需要提供的浪涌电流。过热保护和断续短路保护功能使得该解决方案稳健且可靠。

器件信息

器件型号	输出电流	封装 ⁽¹⁾	封装尺寸 (标称值)
TPSM82864A	4A	RDJ 或 RDM (B0QFN, 23)	3.50mm × 4.00mm
TPSM82866A	6A		

(1) 如需了解所有可用封装，请参阅数据表末尾的可订购产品附录。

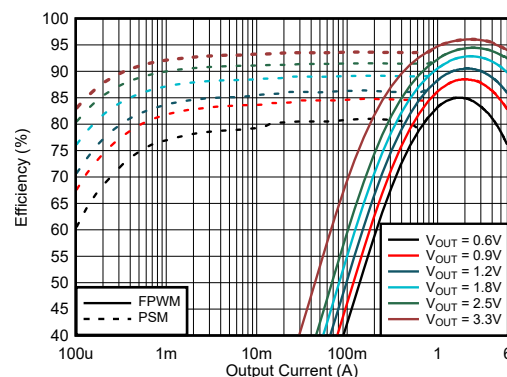

TPSM82866AA0HRDMR - 效率与输出电流间的关系曲线； $V_{IN} = 5.0V$



Table of Contents

1 特性	1	8.4 Device Functional Modes.....	12
2 应用	1	9 Application and Implementation	14
3 说明	1	9.1 Application Information.....	14
4 Revision History	2	9.2 Typical Application.....	14
5 Device Options	3	9.3 Power Supply Recommendations.....	21
6 Pin Configuration and Functions	3	9.4 Layout.....	21
7 Specifications	4	10 Device and Documentation Support	24
7.1 Absolute Maximum Ratings.....	4	10.1 Device Support.....	24
7.2 ESD Ratings.....	4	10.2 Documentation Support.....	24
7.3 Recommended Operating Conditions.....	4	10.3 接收文档更新通知.....	24
7.4 Thermal Information.....	5	10.4 支持资源.....	24
7.5 Electrical Characteristics.....	6	10.5 Trademarks.....	24
7.6 Typical Characteristics.....	7	10.6 Electrostatic Discharge Caution.....	24
8 Detailed Description	8	10.7 术语表.....	24
8.1 Overview.....	8	11 Mechanical, Packaging, and Orderable Information	24
8.2 Functional Block Diagram.....	8		
8.3 Feature Description.....	8		

4 Revision History

注：以前版本的页码可能与当前版本的页码不同

Changes from Revision A (December 2021) to Revision B (November 2022)	Page
• Added TPSM8286xAA0HRDM to the data sheet.....	3

Changes from Revision * (September 2021) to Revision A (December 2021)	Page
• 将文档状态从“预告信息”更改为“量产数据”.....	1

5 Device Options

ORDERABLE PART NUMBER	DEVICE HEIGHT	OUTPUT CURRENT
TPSM82864AA0SRDJR	1.4 mm	4 A
TPSM82864AA0HRDMR	1.8 mm	
TPSM82866AA0SRDJR	1.4 mm	6 A
TPSM82866AA0HRDMR	1.8 mm	

6 Pin Configuration and Functions



图 6-1. TPSM82864A, TPSM82866A - QFN (23 Pin)

表 6-1. Pin Functions

PIN		TYPE ⁽¹⁾	DESCRIPTION
NAME	NO.		
AGND	18	P	Analog ground pin. Must be connected to a common GND plane.
EN	1	I	Device enable pin. To enable the device, this pin must be pulled high. Pulling this pin low disables the device. Do not leave floating.
FB	17	I	Voltage feedback input. Connect the output voltage resistor divider to this pin. When using a fixed output voltage, connect directly to VOUT.
PG	2	O	Power-good open-drain output pin. The pullup resistor can be connected to voltages up to 5.5 V. If unused, leave this pin floating. This pin is pulled to GND when the device is in shutdown.
PGND	4, 5, 6, 8, 9, 10, 11, 19, 20	P	Power ground pin. Must be connected to common GND plane.
SW	7	O	Switch pin of the power stage. This pin can be left floating.
VIN	21, 22	P	Power supply input voltage pin
VOS	16	I	Output voltage sense pin. This pin must be directly connected to the output capacitor.
VOUT	12, 13, 14, 15	P	Output voltage pin
VSET/MODE	3	I	Connecting a resistor to GND selects one of the fixed output voltages. Tying the pin high or low selects an adjustable output voltage. After the device has started up, the pin operates as a MODE input. Applying a high level selects forced PWM mode operation and a low level selects power save mode operation.
Exposed Thermal Pad	23	P	Internally connected to PGND. Must be soldered to achieve appropriate power dissipation and mechanical reliability. Must be connected to common GND plane.

(1) I = Input, O = Output, P = Power

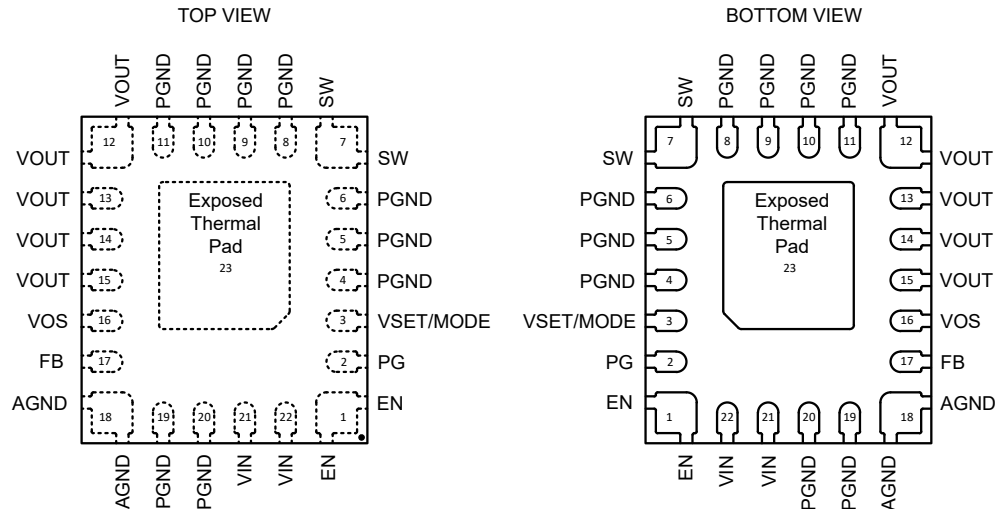
7 Specifications

7.1 Absolute Maximum Ratings

Over operating free-air temperature range (unless otherwise noted) ⁽¹⁾

		MIN	MAX	UNIT
Voltage ⁽²⁾	VIN, EN, VOS, FB, PG, VSET/MODE	- 0.3	6	V
	SW (DC), VOUT	- 0.3	VIN + 0.3	
	SW (AC, less than 10ns) ⁽³⁾	- 2.5	10	
ISINK_PG	Sink current at PG		2	mA
TJ	Junction temperature	- 40	125	°C
Tstg	Storage temperature	- 40	125	°C

- (1) Operation outside the Absolute Maximum Ratings may cause permanent device damage. Absolute Maximum Ratings do not imply functional operation of the device at these or any other conditions beyond those listed under Recommended Operating Conditions. If used outside the Recommended Operating Conditions but within the Absolute Maximum Ratings, the device may not be fully functional, and this may affect device reliability, functionality, performance, and shorten the device lifetime.
- (2) All voltage values are with respect to network ground terminal.
- (3) While switching.

7.2 ESD Ratings

			VALUE	UNIT
VESD)	Electrostatic discharge	Human body model (HBM), per ANSI/ESDA/JEDEC JS-001 ⁽¹⁾	±2000	V
		Charged-device model (CDM), per ANSI/ESDA/JEDEC JS-002 ⁽²⁾	±500	

- (1) JEDEC document JEP155 states that 500-V HBM allows safe manufacturing with a standard ESD control process.
- (2) JEDEC document JEP157 states that 250-V CDM allows safe manufacturing with a standard ESD control process.

7.3 Recommended Operating Conditions

		MIN	NOM	MAX	UNIT
VIN	Supply Voltage Range	2.4		5.5	V
VOUT	Output Voltage Range	0.6		VIN	V
tF_VIN	Falling transition time at VIN ⁽¹⁾			10	mV/μs
IOUT	Output current, TPSM82864A			4	A
	Output current, TPSM82866A			6	
RVSET	Nominal resistance range for external voltage selection resistor (E96 resistor series)	10		249	kΩ
	External voltage selection resistor tolerance			1%	
	External voltage selection resistor temperature coefficient			±200	ppm/°C
TJ	Junction temperature	- 40		125	°C

- (1) The falling slew rate of VIN should be limited if VIN goes below VUVLO (see [Power Supply Recommendations](#)).

7.4 Thermal Information

THERMAL METRIC ⁽¹⁾		TPSM8286x				UNIT
		23 PINS				
		RDM JEDEC 51-5	RDJ JEDEC 51-5	RDJ EVM	RDM EVM	
$R_{\theta JA}$	Junction-to-ambient thermal resistance	43.2	43.3	25.4	25.9	°C/W
$R_{\theta JC(top)}$	Junction-to-case (top) thermal resistance	42.5	34.3	n/a ⁽²⁾	n/a ⁽²⁾	°C/W
$R_{\theta JB}$	Junction-to-board thermal resistance	14.9	10.8	n/a ⁽²⁾	n/a ⁽²⁾	°C/W
Ψ_{JT}	Junction-to-top characterization parameter	6.8	3.6	2.4	3.7	°C/W
Ψ_{JB}	Junction-to-board characterization parameter	14.8	10.7	10.9	12.7	°C/W

(1) For more information about thermal metrics, see the [Semiconductor and IC Package Thermal Metrics](#) application report.

(2) Not applicable to an EVM.

7.5 Electrical Characteristics

$T_J = -40\text{ }^\circ\text{C}$ to $125\text{ }^\circ\text{C}$, and $V_{IN} = 2.4\text{ V}$ to 5.5 V . Typical values are at $T_J = 25\text{ }^\circ\text{C}$ and $V_{IN} = 5\text{ V}$, unless otherwise noted.

PARAMETER		TEST CONDITIONS	MIN	TYP	MAX	UNIT
SUPPLY						
I_{Q_VIN}	Quiescent current into VIN pin	EN = High, no load, device not switching		4	10	μA
I_{Q_VOS}	Quiescent current into VOS pin	EN = High, no load, device not switching, $V_{VOS} = 1.8\text{ V}$		8		μA
I_{SD}	Shutdown current	EN = Low, $T_J = -40\text{ }^\circ\text{C}$ to $85\text{ }^\circ\text{C}$		0.24	1	μA
V_{UVLO}	Under voltage lock out threshold	V_{IN} rising	2.2	2.3	2.4	V
		V_{IN} falling	2.1	2.2	2.3	V
T_{JSD}	Thermal shutdown threshold	T_J rising		150		$^\circ\text{C}$
	Thermal shutdown hysteresis	T_J falling		20		$^\circ\text{C}$
LOGIC INTERFACE						
V_{IH}	High-level input threshold voltage at EN and VSET/MODE		1.0			V
V_{IL}	Low-level input threshold voltage at EN and VSET/MODE				0.4	V
$I_{EN,LKG}$	Input leakage current into EN pin			0.01	0.1	μA
START-UP, POWER GOOD						
t_{Delay}	Enable delay time	Time from EN high to device starts switching with a 249-k Ω resistor connected between VSET/MODE and GND	420	650	1100	μs
t_{Ramp}	Output voltage ramp time	Time from device starts switching to power good	0.8	1	1.5	ms
$V_{PG(low)}$	Power good lower threshold	V_{FB} referenced to $V_{FB(nominal)}$	85	91	96	%
$V_{PG(high)}$	Power good upper threshold	V_{FB} referenced to $V_{FB(nominal)}$	103	111	120	%
$V_{PG,OL}$	Low-level output voltage	$I_{sink} = 1\text{ mA}$			0.4	V
$I_{PG,LKG}$	Input leakage current into PG pin	$V_{PG} = 5.0\text{ V}$		0.01	0.1	μA
$t_{PG,DLY}$	Power good delay	Rising and falling edges		34		μs
OUTPUT						
V_{OUT}	Output voltage accuracy	Fixed voltage operation, FPWM, no load, $T_J = 0\text{ }^\circ\text{C}$ to $85\text{ }^\circ\text{C}$	-	1		%
		Fixed voltage operation, FPWM, no load	-	2		%
V_{FB}	Feedback voltage	Adjustable voltage operation	594	600	606	mV
$I_{FB,LKG}$	Input leakage into FB pin	Adjustable voltage operation, $V_{FB} = 0.6\text{ V}$		0.01	0.4	μA
R_{DIS}	Output discharge resistor at VOS pin			3.5		Ω
	Load regulation	$V_{OUT} = 1.2\text{ V}$, FPWM		0.04		%/A
POWER SWITCH						
R_{DP}	Dropout resistance	TPSM8286xAA0SRDJ 100% mode. $V_{IN} = 3.3\text{ V}$, $T_J = 25\text{ }^\circ\text{C}$		28	35	$\text{m}\Omega$
		TPSM8286xAA0HRDM 100% mode. $V_{IN} = 3.3\text{ V}$, $T_J = 25\text{ }^\circ\text{C}$		24		$\text{m}\Omega$
I_{LIM}	High-side FET forward current limit	TPSM82864A	5	5.5	6	A
		TPSM82866A	7	7.9	8.5	A
	Low-side FET forward current limit	TPSM82864A		4.5		A
		TPSM82866A		6.5		A
Low-side FET negative current limit			-3		A	
f_{SW}	PWM switching frequency	$I_{OUT} = 1\text{ A}$, $V_{OUT} = 1.2\text{ V}$		2.4		MHz

7.6 Typical Characteristics



图 7-1. Quiescent Current into V_{IN} I_{Q_VIN}



图 7-2. Shutdown Current I_{SD}

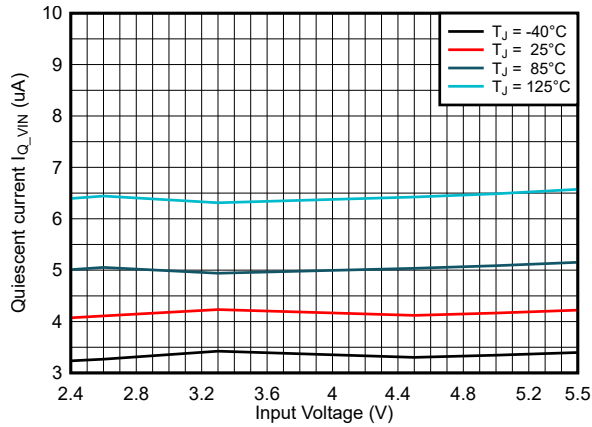

图 7-3. Output Discharge Resistance R_{DIS}

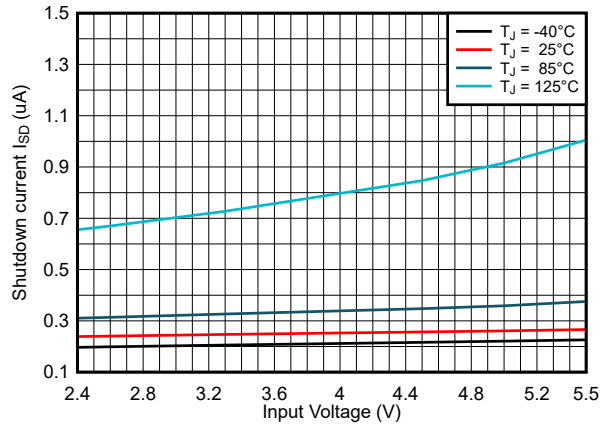

TPSM8286xAA0SRDJ

图 7-4. Dropout Resistance R_{DP}

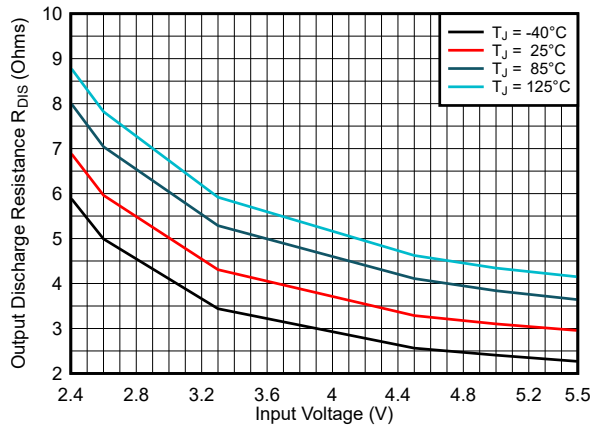
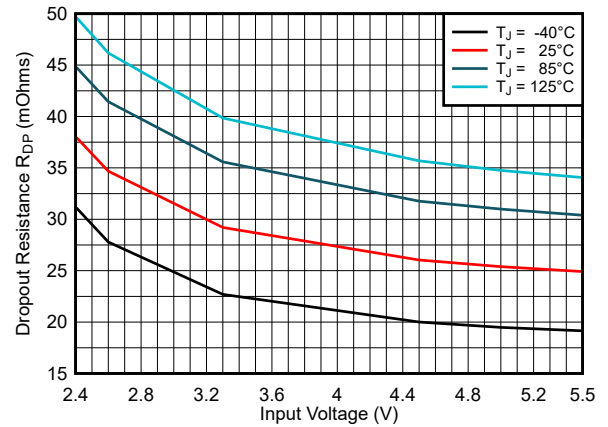
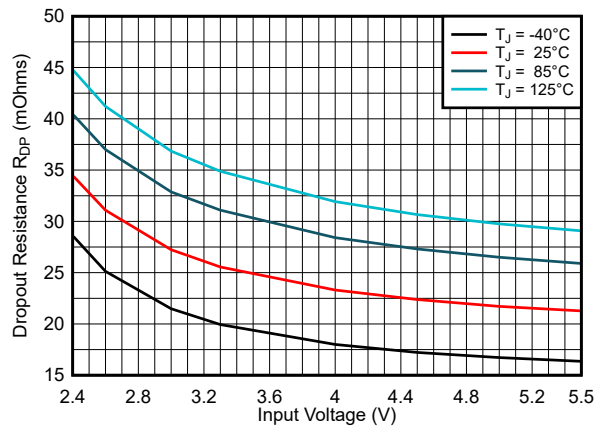

TPSM8286xAA0HRDM

图 7-5. Dropout Resistance R_{DP}

8 Detailed Description

8.1 Overview

The TPSM8286xA synchronous step-down converter power module is based on DCS-Control (Direct Control with Seamless transition into power save mode). This is an advanced regulation topology that combines the advantages of hysteretic, voltage, and current mode control. The DCS-Control topology operates in PWM (pulse width modulation) mode for medium-to-heavy load conditions and in PSM (power save mode) at light load currents. In PWM, the converter operates with its nominal switching frequency of 2.4 MHz, having a controlled frequency variation over the input voltage range. As the load current decreases, the converter enters power save mode, reducing the switching frequency and minimizing the quiescent current of the IC to achieve high efficiency over the entire load current range. DCS-Control supports both operation modes using a single building block and, therefore, has a seamless transition from PWM to PSM without effects on the output voltage. The TPSM8286xA offers excellent DC voltage regulation and load transient regulation, combined with low output voltage ripple, minimizing interference with RF circuits.

8.2 Functional Block Diagram

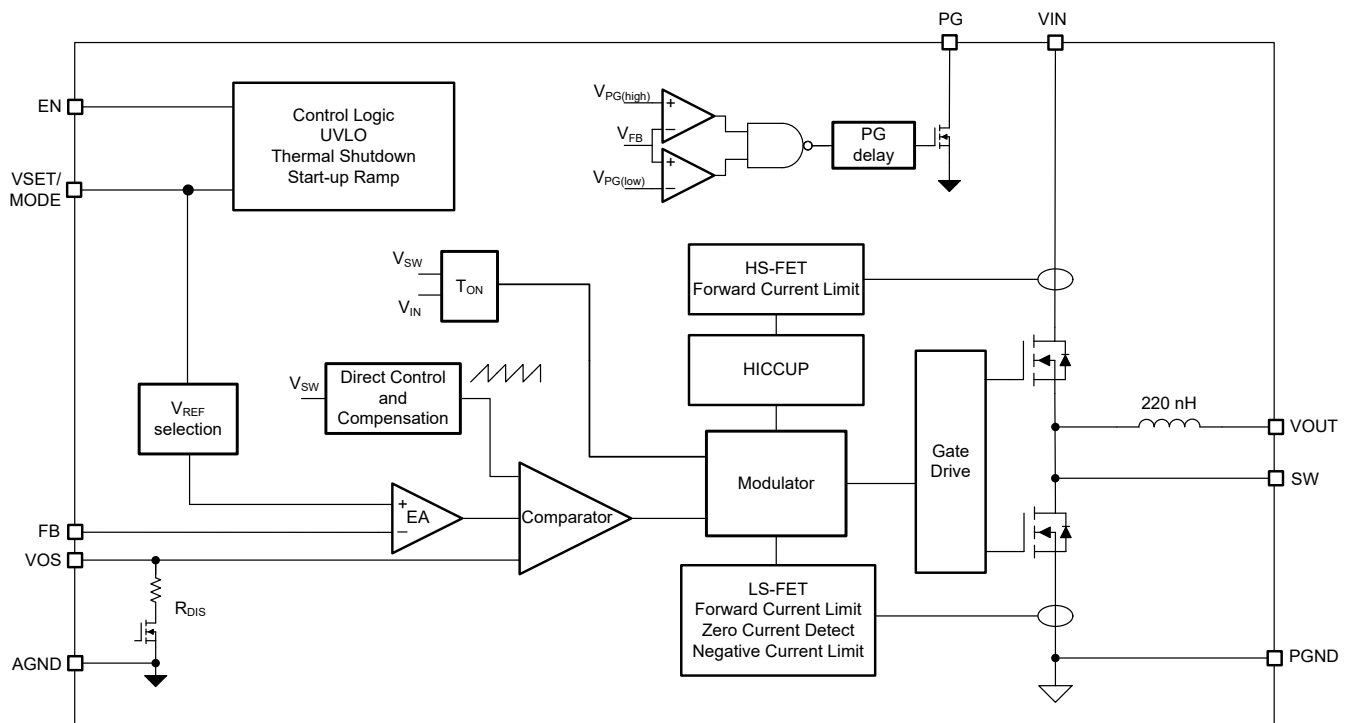

8.3 Feature Description

8.3.1 Power Save Mode

As the load current decreases, the device seamlessly enters power save mode (PSM) operation. In PSM, the converter operates with a reduced switching frequency and a minimum quiescent current to maintain high efficiency. Power save mode is based on a fixed on-time architecture, as shown in [方程式 1](#).

$$t_{ON} = \frac{V_{OUT}}{V_{IN}} \cdot 416\text{ns}$$

(1)

The switching frequency in PSM is estimated as:

$$f_{\text{PSM}} = \frac{2 \times I_{\text{OUT}}}{t_{\text{ON}}^2 \times \frac{V_{\text{IN}}}{V_{\text{OUT}}} \times \frac{V_{\text{IN}} - V_{\text{OUT}}}{220\text{nH}}} \quad (2)$$

The load current at which PSM is entered is at one half of the ripple current of the inductor and it can be estimated as:

$$I_{\text{Load(PSM-entry)}} = \frac{V_{\text{IN}} \times t_{\text{ON}}}{2} \times \frac{1 - \frac{V_{\text{OUT}}}{V_{\text{IN}}}}{220\text{nH}} \quad (3)$$

In power save mode, the output voltage rises slightly above the nominal output voltage. This effect is minimized by increasing the output capacitance.

8.3.2 Forced PWM Mode

After the device has powered up and ramped up V_{OUT}, the VSET/MODE pin acts as a digital input. With a high level on the VSET/MODE pin, the device enters forced PWM (FPWM) mode and operates with a constant switching frequency over the entire load range, even at very light loads. This reduces the output voltage ripple and allows simple filtering of the switching frequency for noise-sensitive applications but lowers efficiency at light loads.

8.3.3 Optimized Transient Performance from PWM to PSM Operation

For most converters, the load transient response in PWM mode is improved compared to PSM, because the converter reacts faster on the load step and actively sinks energy on the load release. As an additional feature, the TPSM8286xA automatically stays in PWM mode for 128 cycles after a heavy load release to bring the output voltage back to the regulation level faster. After these 128 cycles of PWM mode, it automatically returns to PSM (if VSET/MODE is low). See [图 8-1](#). Without this optimization, the output voltage overshoot is higher.



图 8-1. Optimized Transient Performance from PWM to PSM

8.3.4 Low Dropout Operation (100% Duty Cycle)

The device offers a low dropout operation by entering 100% duty cycle mode if the input voltage comes close to the target output voltage. In this mode, the high-side MOSFET switch is constantly turned on. This is particularly useful in battery-powered applications to achieve the longest operation time by taking full advantage of the whole battery voltage range. The minimum input voltage to maintain a minimum output voltage is given by:

$$V_{IN (min)} = V_{OUT (min)} + I_{OUT (max)} \times R_{DP} \quad (4)$$

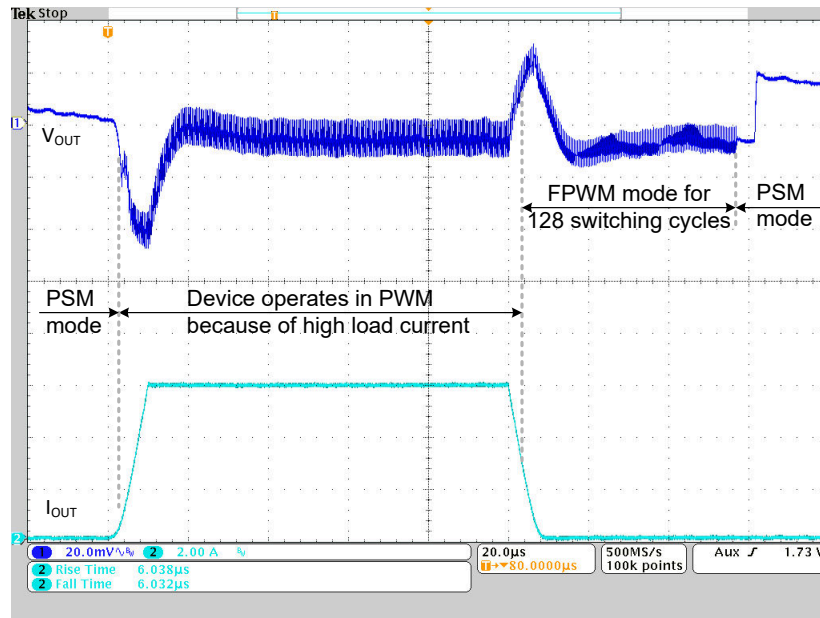
where

- $V_{OUT (min)}$ = Minimum output voltage the load can accept
- $I_{OUT (max)}$ = Maximum output current
- R_{DP} = Resistance from V_{IN} to V_{OUT} (high-side $R_{DS(on)}$ + R_{DC} of the inductor)

8.3.5 Soft Start

After enabling the device, there is a 650- μ s enable delay (t_{Delay}) before the device starts switching. The t_{Delay} time varies with the VSET/MODE resistor used and is longest with a resistance of 249 k or higher. After the enable delay, an internal soft-start circuit ramps up the output voltage in 1 ms (t_{Ramp}). This action avoids excessive inrush current and creates a smooth output voltage ramp up. This action also prevents excessive voltage drops of batteries that have a high internal impedance. 图 8-2 shows the start-up sequence.



图 8-2. Start-Up Sequence

The device is able to start into a pre-biased output capacitor. The device starts with the applied bias voltage and ramps the output voltage to its nominal value.

8.3.6 Switch Current Limit and HICCUP Short-Circuit Protection

The switch current limit prevents the device from high inductor current and from drawing excessive current from the battery or input voltage rail. Excessive current can occur with a heavy load or shorted output circuit condition. If the inductor current reaches the threshold I_{LIM} , cycle by cycle, the high-side MOSFET is turned off and the low-side MOSFET is turned on until the inductor current ramps down to the low-side MOSFET current limit.

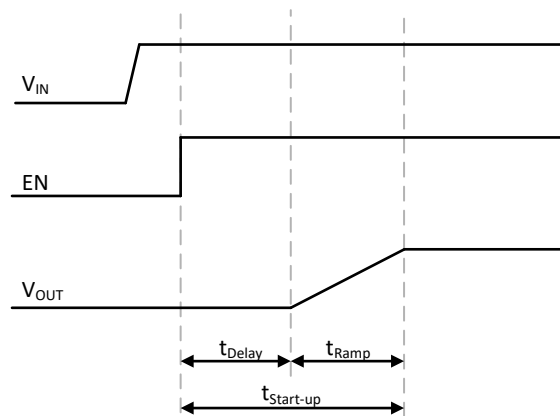
When the high-side MOSFET current limit is triggered 256 times, the device stops switching. The device then automatically re-starts with soft start after a typical delay time of 16 ms has passed. The device repeats this mode until the high load condition disappears. This HICCUP short-circuit protection reduces the current consumed from the input supply because the device only draws input current approximately 10% of the time during an overload condition. 图 9-29 shows the hiccup short-circuit protection.

The low-side MOSFET also contains a negative current limit to prevent excessive current from flowing back through the inductor to the input. If the low-side sinking current limit is exceeded, the low-side MOSFET is turned off. In this scenario, both MOSFETs are off until the start of the next cycle. The negative current limit is only active in forced PWM mode.

8.3.7 Undervoltage Lockout

To avoid mis-operation of the device at low input voltages, undervoltage lockout (UVLO) disables the device when the input voltage is lower than V_{UVLO} . When the input voltage recovers, the device automatically returns to operation with soft start.

8.3.8 Thermal Shutdown

When the junction temperature exceeds T_{JSD} , the device goes into thermal shutdown, stops switching, and activates the output voltage discharge. When the device temperature falls below the threshold by the hysteresis, the device returns to normal operation automatically with soft start.

8.4 Device Functional Modes

8.4.1 Enable and Disable (EN)

The device is enabled by setting the EN pin to a logic high. Accordingly, shutdown mode is forced if the EN pin is pulled low. In shutdown mode, the internal power switches as well as the entire control circuitry are turned off. An internal switch smoothly discharges the output through the VOS pin in shutdown mode. Do not leave the EN pin floating.

The typical enable threshold value of the EN pin is 0.66 V for rising input signals and the typical shutdown threshold is 0.52 V for falling input signals.

8.4.2 Output Discharge

The purpose of the output discharge function is to ensure a defined down-ramp of the output voltage when the device is disabled and to keep the output voltage close to 0 V. The output discharge is active when the EN pin is set to a logic low and during thermal shutdown. The discharge is active down to an input voltage of 1.6 V (typical).

8.4.3 Power Good (PG)

The device has an open-drain power-good pin, which is specified to sink up to 2 mA. The power-good output requires a pullup resistor connected to any voltage rail less than 5.5 V. The PG signal can be used for sequencing of multiple rails by connecting it to the EN pin of other converters. Leave the PG pin unconnected when not used. 表 8-1 shows the typical PG pin logic.

表 8-1. PG Pin Logic

DEVICE CONDITIONS		LOGIC STATUS	
		HIGH IMPEDANCE	LOW
Enable	$0.9 \times V_{OUT_NOM} \leq V_{VOUT} \leq 1.1 \times V_{OUT_NOM}$	✓	
	$V_{VOUT} < 0.9 \times V_{OUT_NOM}$ or $V_{VOUT} > 1.1 \times V_{OUT_NOM}$		✓
Shutdown	EN = low		✓
Thermal shutdown	$T_J > T_{JSD}$		✓
UVLO	$1.8 \text{ V} < V_{IN} < V_{UVLO}$		✓
Power supply removal	$V_{IN} < 1.8 \text{ V}$	undefined	

The PG pin has a 34- μs delay time on the falling edge and a 34- μs delay before PG goes high. See 图 8-3.



图 8-3. Power-Good Transient and Delay Behavior

8.4.4 Output Voltage and Mode Selection (VSET/MODE)

The TPSM8286xA family devices are configurable as either an adjustable output voltage or a fixed output voltage, depending on the needs of each individual application. This feature simplifies the logistics during mass production, as one part number offers several fixed output voltage options as well as an adjustable output voltage option. During the enable delay (t_{Delay}), the device configuration is set by an external resistor connected to the VSET/MODE pin through an internal R2D (resistor to digital) converter. This configures the V_{REF} input to the error amplifier (EA) to be either the V_{FB} voltage (0.6-V typical) or the selected output voltage. 表 8-2 shows the options.

表 8-2. Output Voltage Selection Table

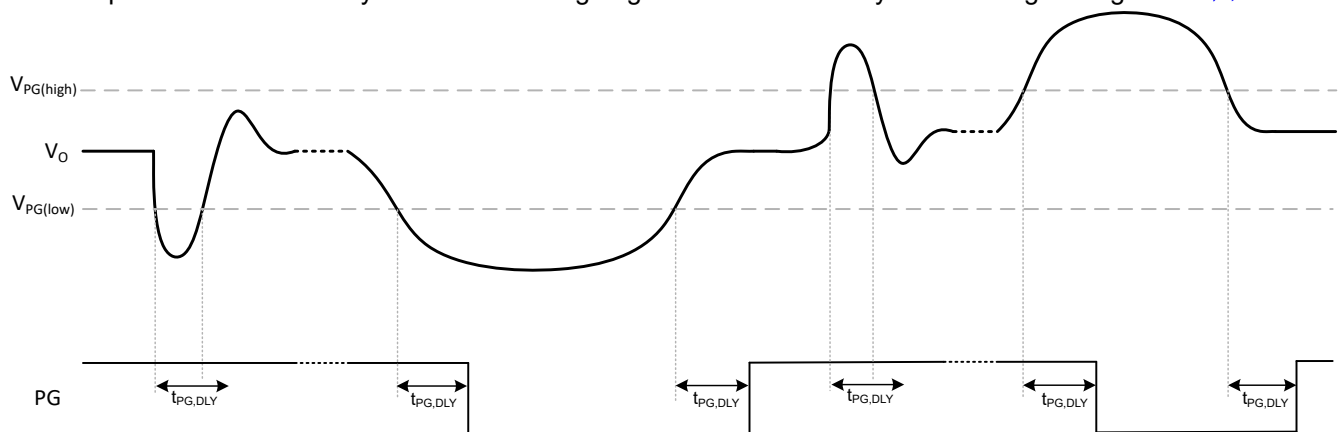
RESISTOR AT VSET/MODE PIN (E96 SERIES, ±1% ACCURACY, 200 ppm OR BETTER)	FIXED OR ADJUSTABLE OUTPUT VOLTAGE
249 k or logic high	Adjustable (through a resistive divider on the FB pin)
205 k	3.30 V
162 k	2.50 V
133 k	1.80 V
105 k	1.50 V
68.1 k	1.35 V
56.2 k	1.20 V
44.2 k	1.10 V
36.5 k	1.05 V
28.7 k	1.00 V
23.7 k	0.95 V
18.7 k	0.90 V
15.4 k	0.85 V
12.1 k	0.80 V
10 k or logic low	Adjustable (through a resistive divider on the FB pin)

The R2D converter has an internal current source, which applies current through the external resistor, and an internal ADC, which reads back the resulting voltage level. Depending on the detected resistance, the output voltage is set. After this R2D conversion is finished, the current source is turned off to avoid current flowing through the external resistor. Make sure that the additional leakage current path is less than 20 nA and the capacitance is not greater than 30 pF from this pin to GND during R2D conversion, otherwise a false V_{OUT} value is set. For more details, refer to the [Benefits of a Resistor-to-Digital Converter in Ultra-Low Power Supplies White Paper](#). When the device is set to a fixed output voltage, the FB pin must be connected to the output directly. See 图 8-4.



图 8-4. Fixed Output Voltage Application Circuit

After the start-up period ($t_{Start-up}$), a different operation mode can be selected. When VSET/MODE is set to high, the device is in **forced PWM mode**. Otherwise, the device is in **power save mode**.

9 Application and Implementation

备注

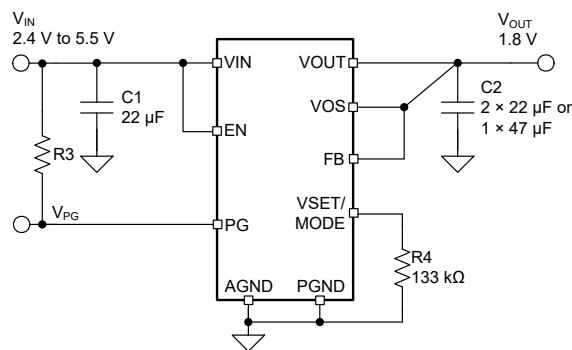
以下应用部分中的信息不属于 TI 器件规格的范围，TI 不担保其准确性和完整性。TI 的客户应负责确定器件是否适用于其应用。客户应验证并测试其设计，以确保系统功能。

9.1 Application Information

The TPSM8286xA is a synchronous step-down converter power module family. The following section discusses the selection of the external components to complete the power supply design. The required power inductor is integrated inside the TPSM8286xA. The integrated shielded inductor has a value of 0.22 μH with a $\pm 20\%$ tolerance. The TPSM82864A and TPSM82866A are pin-to-pin and BOM-to-BOM compatible. The TPSM8286xAA0HRDMR devices give a higher efficiency than the TPSM8286xAA0SRDJR devices due to their increased height. For a given package height (RDM or RDJ), the 4A and 6A version give the same efficiency and performance and are different only in their rated output current.

9.2 Typical Application



图 9-1. Typical Application

9.2.1 Design Requirements

For this design example, use 表 9-1 as the input parameters.

表 9-1. Design Parameters

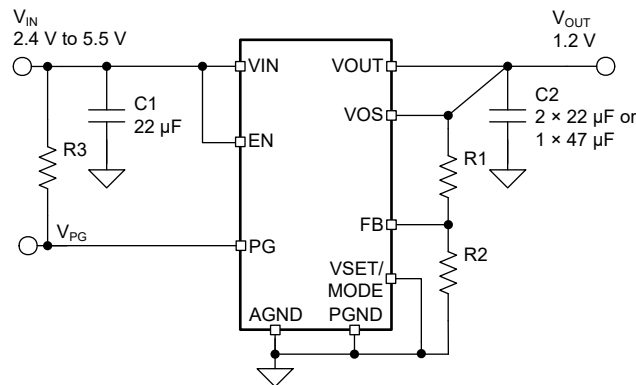
DESIGN PARAMETER	EXAMPLE VALUE
Input voltage	2.4 V to 5.5 V
Output voltage	1.2 V
Maximum output current	6 A

表 9-2 lists the components used for the example.

表 9-2. List of Components

REFERENCE	DESCRIPTION	MANUFACTURER ⁽¹⁾
C1	22 μF , Ceramic capacitor, 6.3 V, X7R, size 0805, GRM21BZ70J226ME44	Murata
C2	47 μF , Ceramic capacitor, 6.3 V, X6S, size 0805, JMK212BC6476MG-T	Taiyo Yuden
R1	Depending on the output voltage, Chip resistor, 1/16 W, 1%	Std
R2	100 k Ω , Chip resistor, 1/16 W, 1%	Std
R3	100 k Ω , Chip resistor, 1/16 W, 1%	Std

(1) See the [Third-party Products](#) disclaimer.

9.2.2 Detailed Design Procedure

9.2.2.1 Setting The Output Voltage

With the VSET/MODE pin set high or low, an adjustable output voltage is set by an external resistor divider according to [方程式 5](#):

$$R1 = R2 \times \left(\frac{V_{OUT}}{V_{FB}} - 1 \right) = R2 \times \left(\frac{V_{OUT}}{0.6V} - 1 \right) \quad (5)$$

To keep the feedback (FB) net robust from noise, set R2 equal to or lower than 100 k Ω to have at least 6 μ A of current in the voltage divider. Lower values of FB resistors achieve better noise immunity but lower light-load efficiency, as explained in the [Design Considerations for a Resistive Feedback Divider in a DC/DC Converter Technical Brief](#).

When a fixed output voltage is selected, connect the FB pin directly to the output. R1 and R2 are not needed, as V_{OUT} is set through a resistor on the VSET/MODE pin. Select the recommended resistor value from the list in [表 8-2](#).

9.2.2.2 Input and Output Capacitor Selection

For the best output and input voltage filtering, low-ESR ceramic capacitors are required. The input capacitor minimizes input voltage ripple, suppresses input voltage spikes, and provides a stable system rail for the device. The input capacitor must be placed between VIN and PGND as close as possible to those pins. For most applications, 22 μ F is sufficient, though a larger value reduces input current ripple. The input capacitor plays an important role in the EMI performance of the system as explained in the [Simplify Low EMI Design With Power Modules White Paper](#).

The architecture of the device allows the use of tiny ceramic output capacitors with low equivalent series resistance (ESR). These capacitors provide low output voltage ripple and are recommended. The capacitor value can range from 2 \times 22 μ F up to 150 μ F. The recommended typical output capacitors are 2 \times 22 μ F or 1 \times 47 μ F with an X5R or better dielectric. Values over 150 μ F can degrade the loop stability of the converter.

Ceramic capacitors have a DC-Bias effect, which has a strong influence on the final effective capacitance. Choose the right capacitor carefully in combination with considering its package size and voltage rating. Make sure that the effective input capacitance is at least 10 μ F and the effective output capacitance is at least 22 μ F.

9.2.3 Application Curves

$V_{IN} = 5.0\text{ V}$, $V_{OUT} = 1.2\text{ V}$, $T_A = 25^\circ\text{C}$, BOM = 表 9-2, unless otherwise noted. Solid lines show the FPWM mode and dashed lines show PSM.



图 9-2. Efficiency $V_{IN} = 5.0\text{ V}$ and $T_A = 25^\circ\text{C}$



图 9-3. Efficiency $V_{IN} = 5.0\text{ V}$ and $T_A = 85^\circ\text{C}$

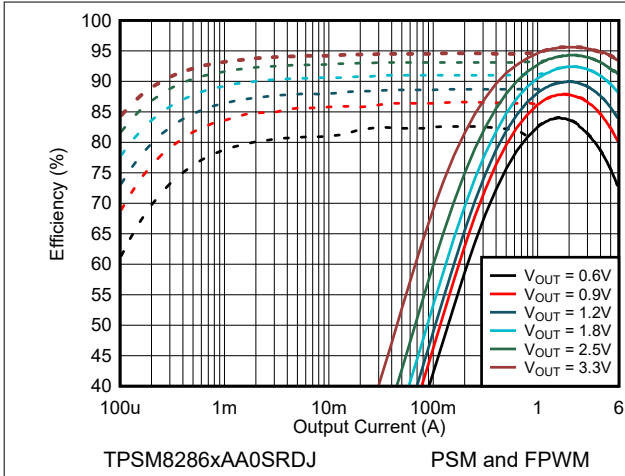

图 9-4. Efficiency $V_{IN} = 3.3\text{ V}$ and $T_A = 25^\circ\text{C}$

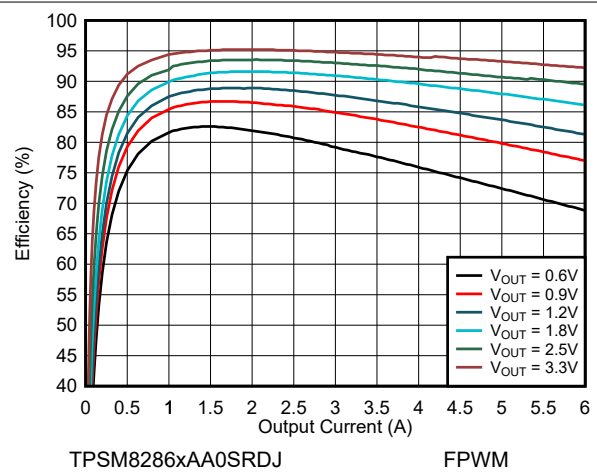

图 9-5. Efficiency $V_{IN} = 3.3\text{ V}$ and $T_A = 85^\circ\text{C}$

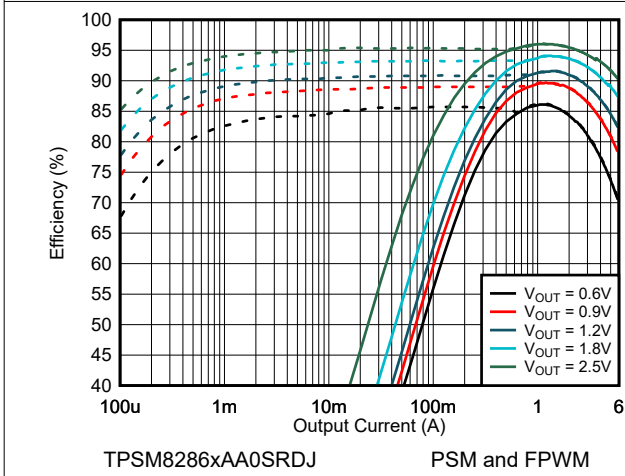

图 9-6. Efficiency $V_{IN} = 2.8\text{ V}$ and $T_A = 25^\circ\text{C}$

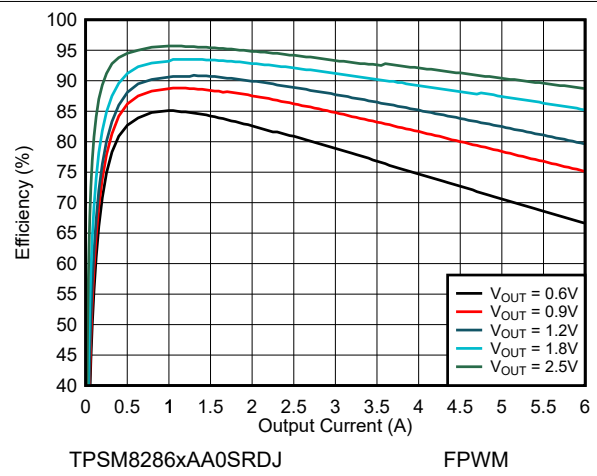

图 9-7. Efficiency $V_{IN} = 2.8\text{ V}$ and $T_A = 85^\circ\text{C}$

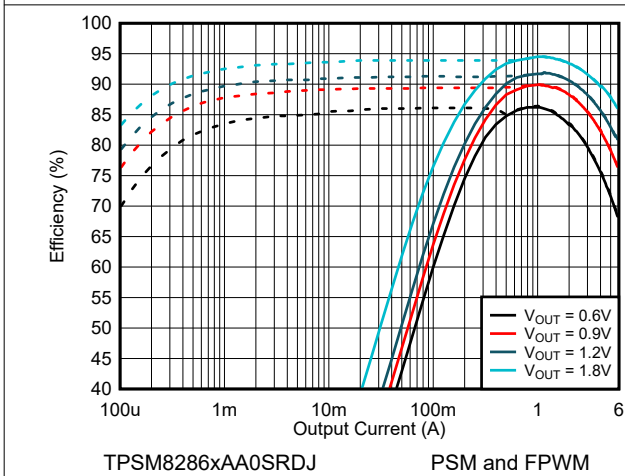

图 9-8. Efficiency $V_{IN} = 5.0\text{ V}$ and $T_A = 25^\circ\text{C}$

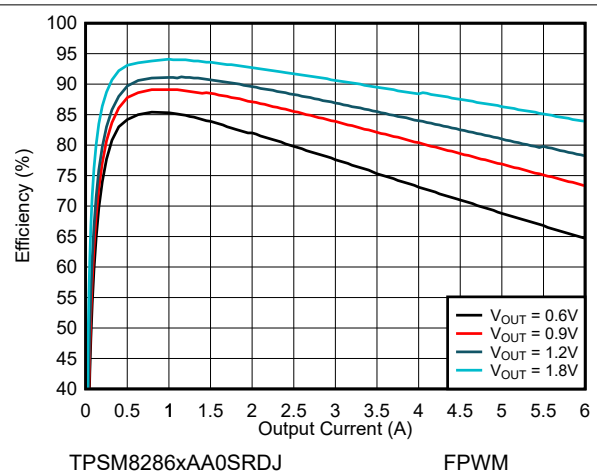

图 9-9. Efficiency $V_{IN} = 5.0\text{ V}$ and $T_A = 85^\circ\text{C}$

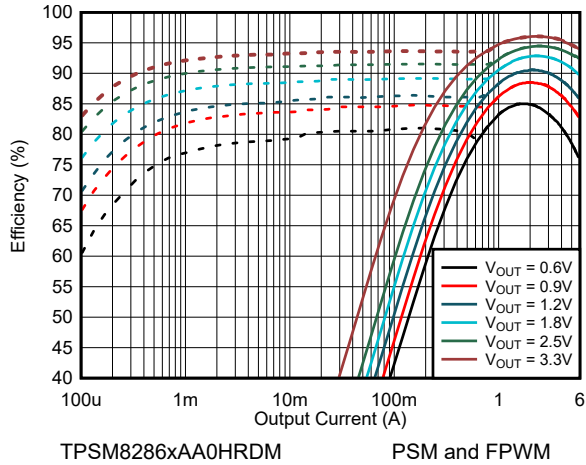

图 9-10. Efficiency $V_{IN} = 3.3\text{ V}$ and $T_A = 25^\circ\text{C}$

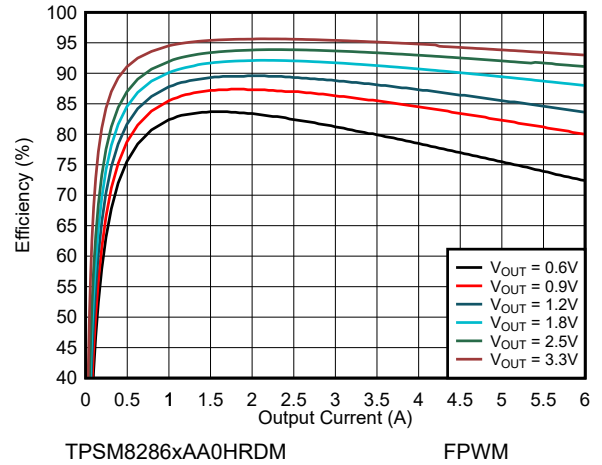

图 9-11. Efficiency $V_{IN} = 3.3\text{ V}$ and $T_A = 85^\circ\text{C}$

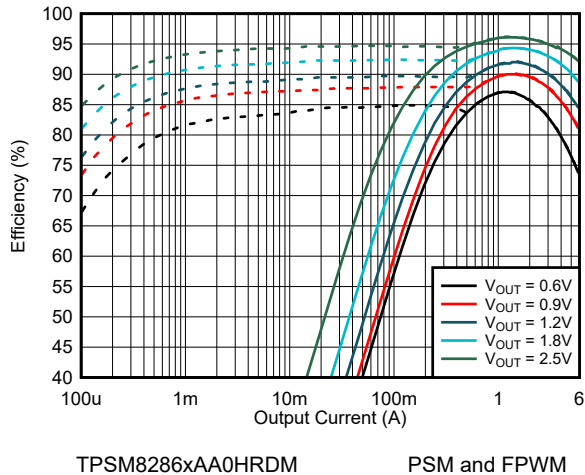

图 9-12. Efficiency $V_{IN} = 2.8\text{ V}$ and $T_A = 25^\circ\text{C}$

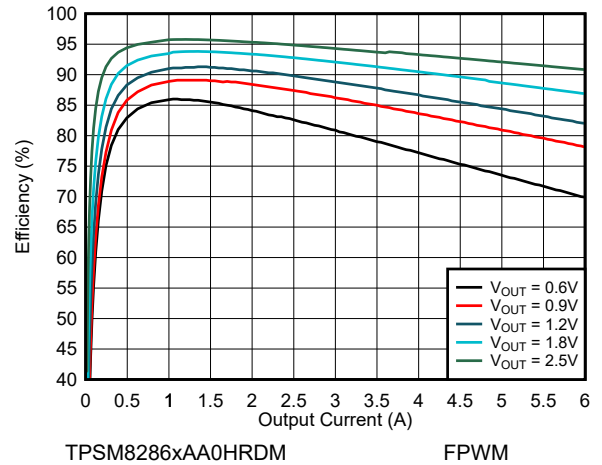

图 9-13. Efficiency $V_{IN} = 2.8\text{ V}$ and $T_A = 85^\circ\text{C}$

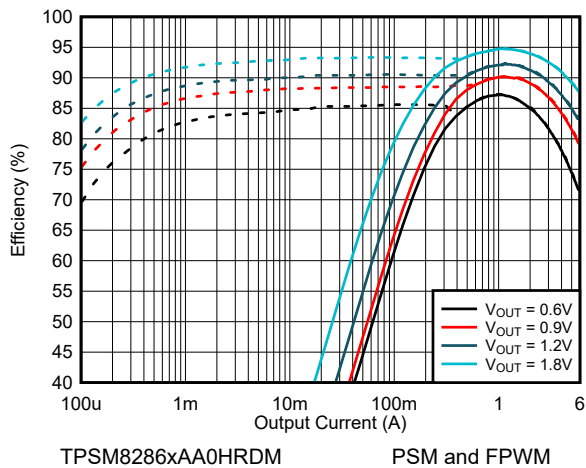

9-14. Load Regulation $V_{IN} = 5.0$ V and PSM

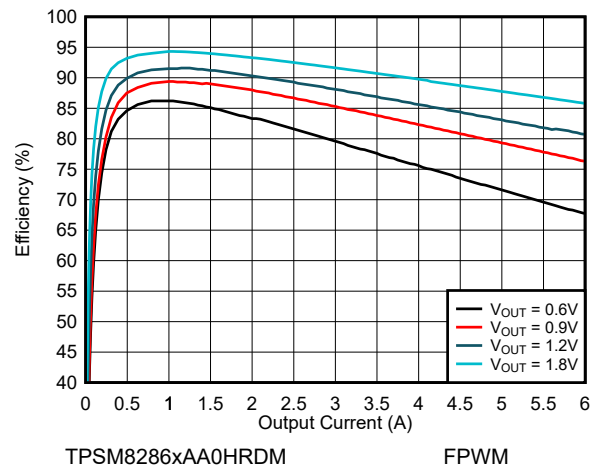
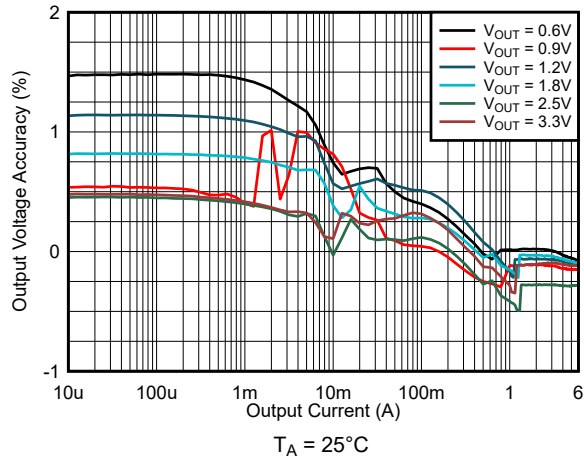
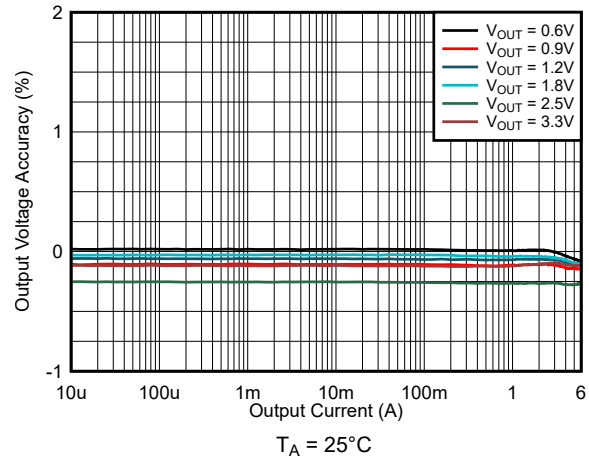

9-15. Load Regulation $V_{IN} = 5.0$ V and FPWM

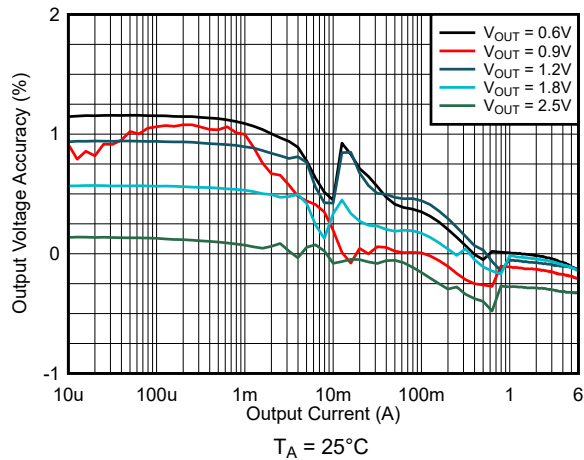

9-16. Load Regulation $V_{IN} = 3.3$ V and PSM

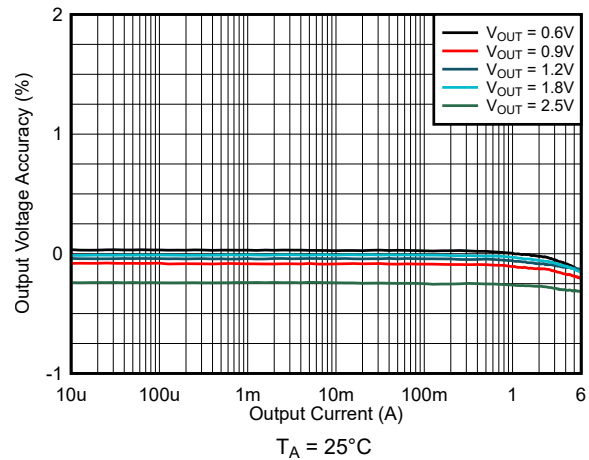

9-17. Load Regulation $V_{IN} = 3.3$ V and FPWM

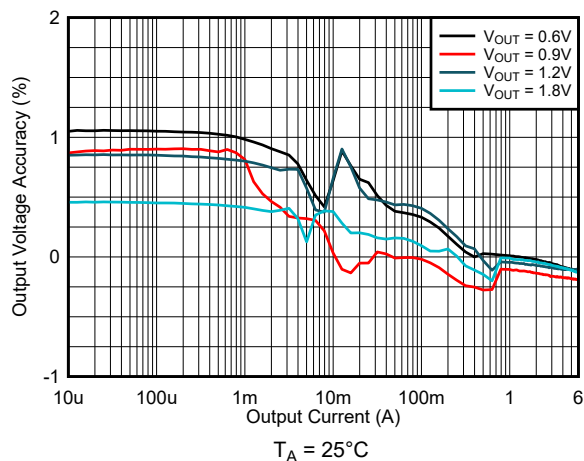

9-18. Load Regulation $V_{IN} = 2.8$ V and PSM

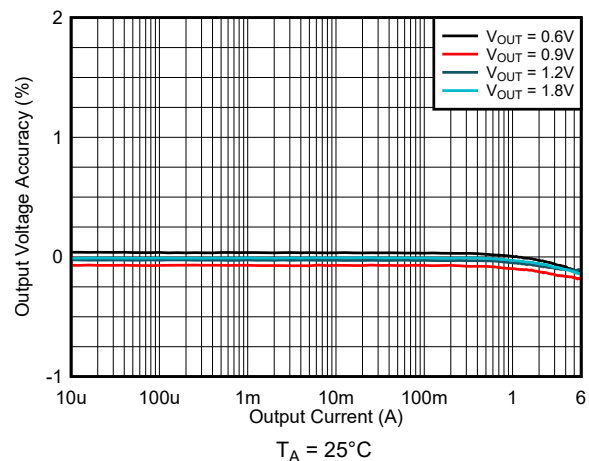

9-19. Load Regulation $V_{IN} = 2.8$ V and FPWM

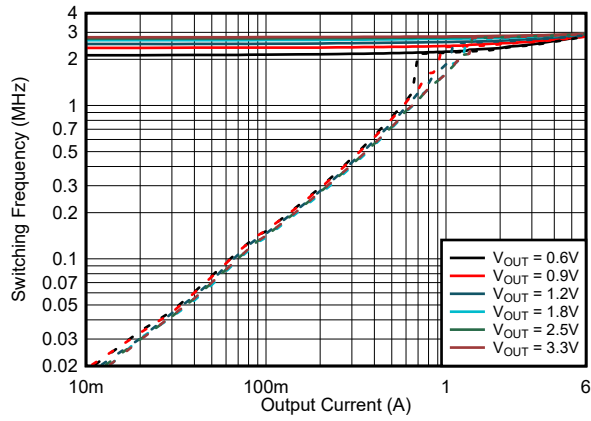

PSM and FPWM $T_A = 25^\circ\text{C}$

图 9-20. Switching Frequency $V_{IN} = 5.0\text{ V}$

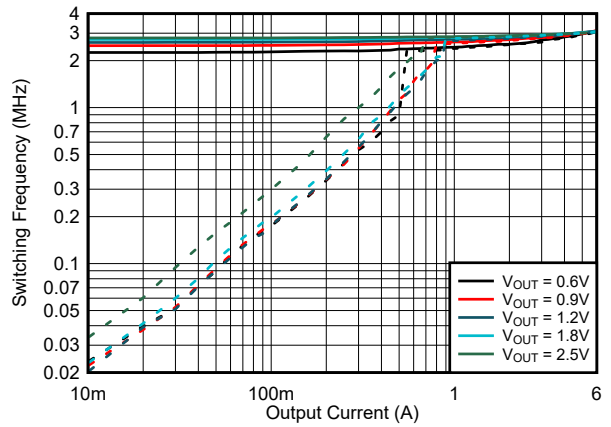

PSM and FPWM $T_A = 25^\circ\text{C}$

图 9-21. Switching Frequency $V_{IN} = 3.3\text{ V}$

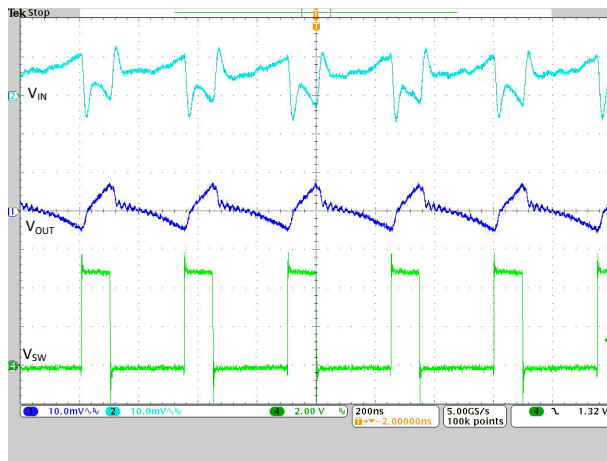

$V_{IN} = 5.0\text{ V}$ $V_{OUT} = 1.2\text{ V}$ $T_A = 25^\circ\text{C}$

图 9-22. FPWM Operation $I_{OUT} = 6\text{ A}$

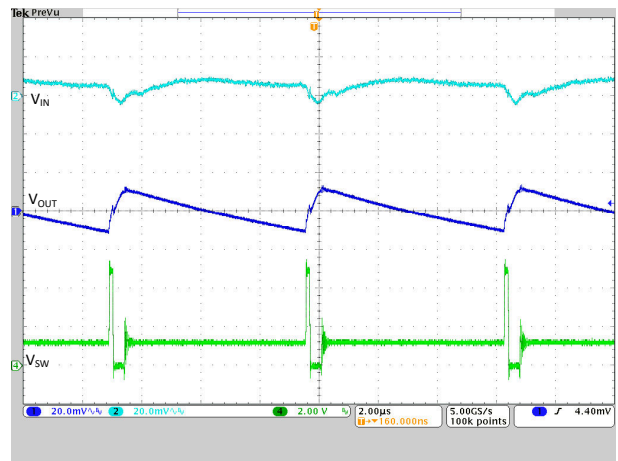

$V_{IN} = 5.0\text{ V}$ $V_{OUT} = 1.2\text{ V}$ $T_A = 25^\circ\text{C}$

图 9-23. PSM Operation $I_{OUT} = 0.1\text{ A}$

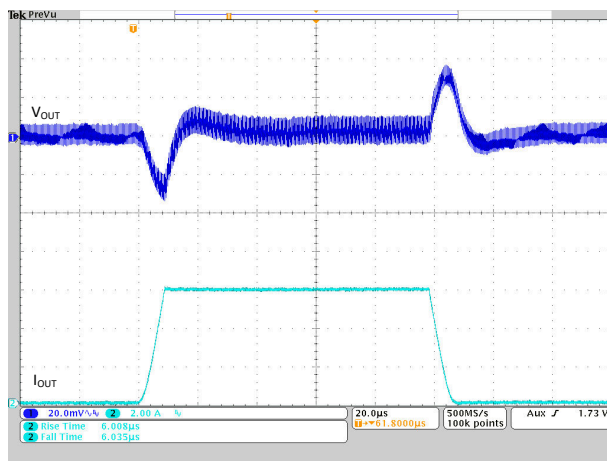

$V_{IN} = 5.0\text{ V}$ $V_{OUT} = 1.2\text{ V}$ $T_A = 25^\circ\text{C}$

图 9-24. Load Transient FPWM $I_{OUT} = 0\text{ A} \rightarrow 6\text{ A}$

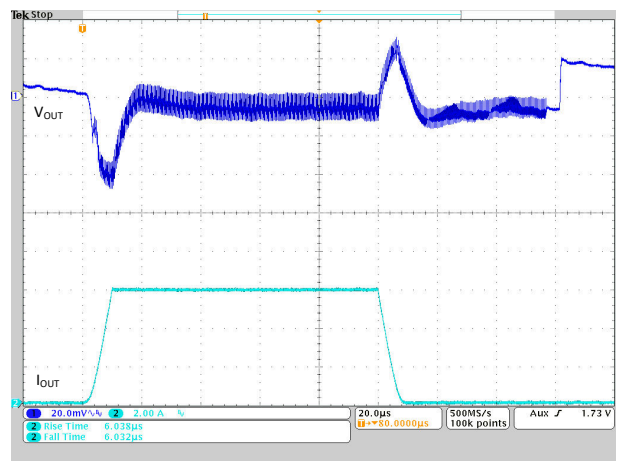

$V_{IN} = 5.0\text{ V}$ $V_{OUT} = 1.2\text{ V}$ $T_A = 25^\circ\text{C}$

图 9-25. Load Transient PSM $I_{OUT} = 0\text{ A} \rightarrow 6\text{ A}$

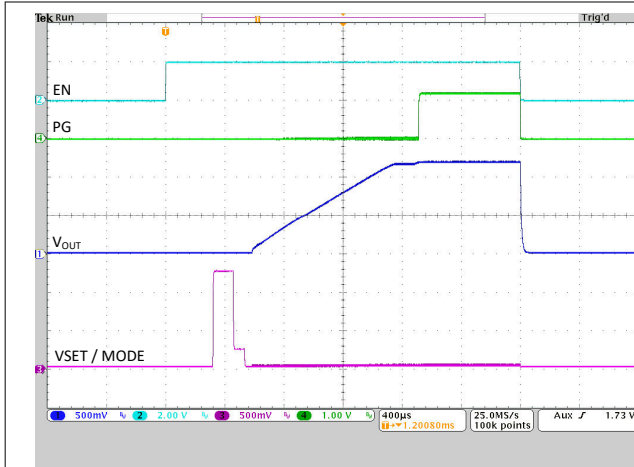

$R_{VSET} = 56.2 \text{ k}\Omega$ $I_{OUT} = 6.0 \text{ A}$

图 9-26. Start-Up into Full Load



$R_{VSET} = 56.2 \text{ k}\Omega$ $I_{OUT} = 0 \text{ A}$

图 9-27. Start-Up with No Load

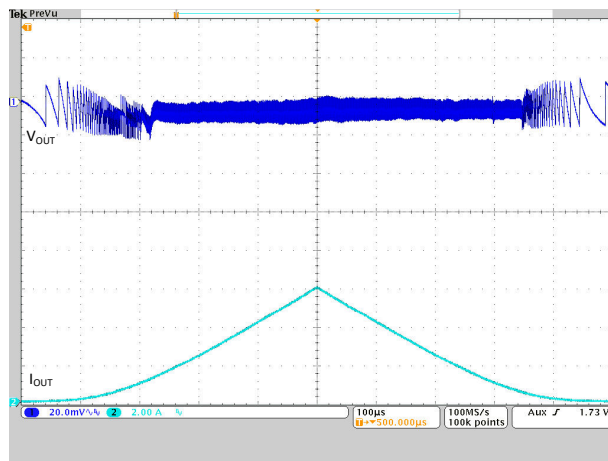

$V_{IN} = 5.0 \text{ V}$ $V_{OUT} = 1.2 \text{ V}$ $T_A = 25^\circ\text{C}$

图 9-28. Load Sweep $I_{OUT} = 20 \text{ mA} \rightarrow 6 \text{ A}$

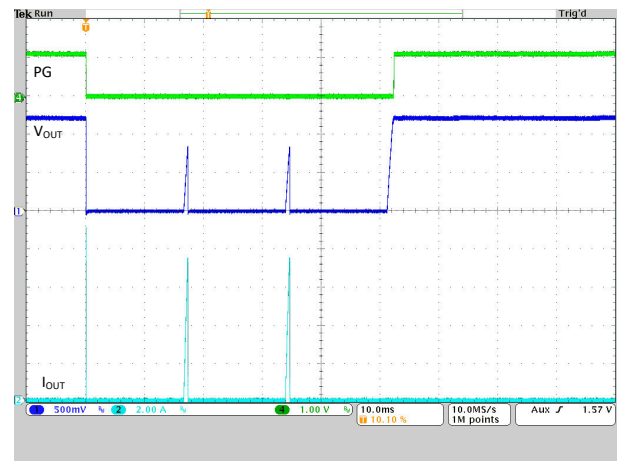

$R_{LOAD} = 100 \text{ m}\Omega$ (during overload)

图 9-29. HICCUP Short-Circuit Protection

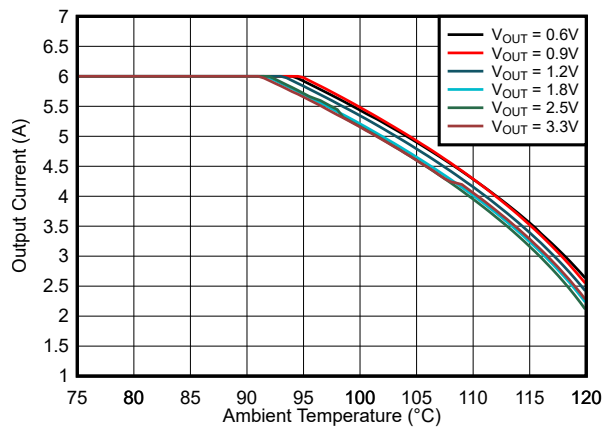

$R_{\theta JA} = 25.4^\circ\text{C/W}$ $T_{Jmax} = 125^\circ\text{C}$

图 9-30. Safe Operating Area $V_{IN} = 5.0\text{V}$
TPSM82866AA0HRDMR

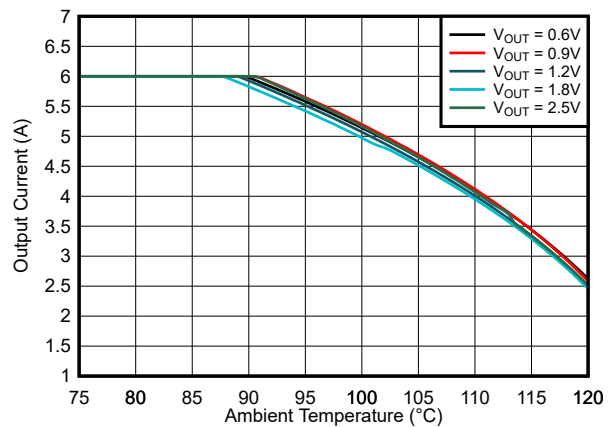

$R_{\theta JA} = 25.4^\circ\text{C/W}$ $T_{Jmax} = 125^\circ\text{C}$

图 9-31. Safe Operating Area $V_{IN} = 3.3\text{V}$
TPSM82866AA0HRDMR

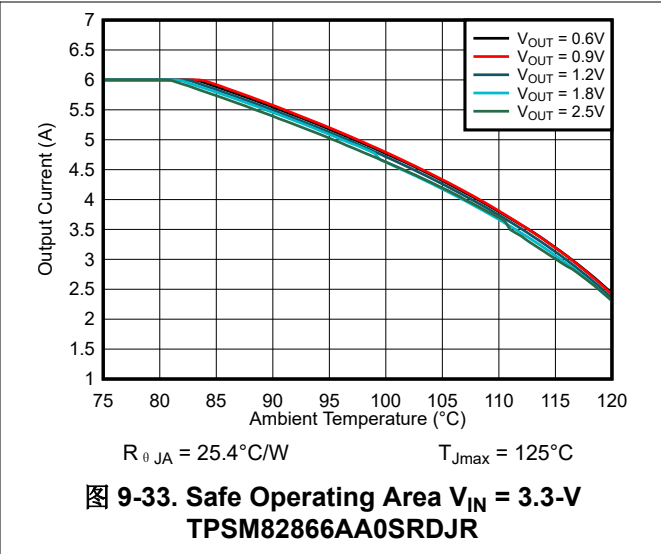
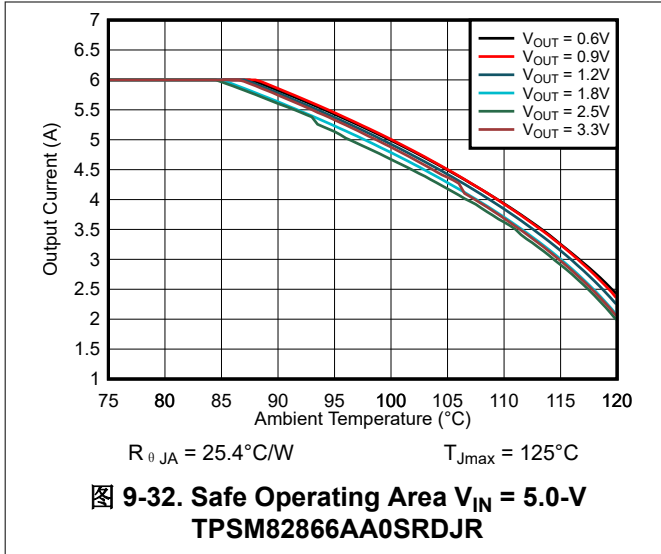

9.3 Power Supply Recommendations

The device is designed to operate from an input voltage supply range from 2.4 V to 5.5 V. The average input current of the TPSM8286xA is calculated as:

$$I_{IN} = \frac{1}{\eta} \times \frac{V_{OUT} \times I_{OUT}}{V_{IN}} \quad (6)$$

Make sure that the input power supply has a sufficient current rating for the application. The power supply must avoid a fast ramp down. The falling ramp speed must be slower than 10 mV/μs if the input voltage drops below V_{UVLO} .

9.4 Layout

9.4.1 Layout Guidelines

A proper layout is critical for the operation of any switched mode power supply, especially at high switching frequencies. Therefore, the PCB layout of the TPSM8286xA demands careful attention to ensure best performance. A poor layout can lead to issues like the following:

- Bad line and load regulation
- Instability
- Increased EMI radiation
- Noise sensitivity

Refer to the [Five Steps to a Great PCB Layout for a Step-Down Converter Technical Brief](#) for a detailed discussion of general best practices. The following are specific recommendations for the TPSM8286xA:

- Place the input capacitor as close as possible to the VIN and PGND pins of the device. This placement is the most critical component placement. Route the input capacitor directly to the VIN and PGND pins avoiding vias.
- Place the output capacitor close to the VOUT and PGND pins and route it directly avoiding vias.
- Place the FB resistors R1 and R2 close to the FB and AGND pins and place R4 close to the VSET/MODE pin to minimize noise pickup.
- The sense traces connected to the VOS pin is a signal trace. Take special care to avoid noise being induced. Keep the trace away from SW.
- To improve thermal performance, use GND vias under the exposed thermal pad. Directly connect the AGND and PGND pins to the exposed thermal pad with copper on the top PCB layer.

TPSM82864A, TPSM82866A

ZHCSMK6B – SEPTEMBER 2021 – REVISED NOVEMBER 2022

- Refer to [图 9-34](#) for an example of component placement, routing, and thermal design.
- The recommended land pattern for the TPSM8286xA is shown at the end of this data sheet. For best manufacturing results, create the pads as solder mask defined (SMD) when some pins (such as VIN, VOUT, and PGND) are connected to large copper planes. Using SMD pads keeps each pad the same size and avoids solder pulling the device during reflow.

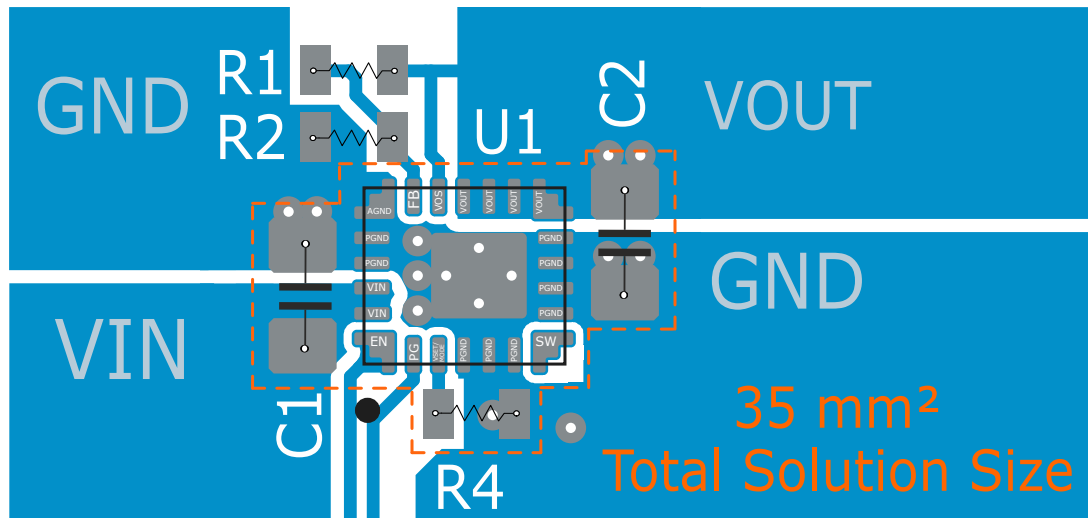
9.4.2 Layout Example

图 9-34. Layout Example

9.4.2.1 Thermal Considerations

The TPSM8286xA power module temperature must be kept less than the maximum rating of 125°C. The following are three basic approaches for enhancing thermal performance:

- Improve the power dissipation capability of the PCB design.
- Improve the thermal coupling of the component to the PCB.
- Introduce airflow into the system.

To estimate the approximate module temperature of the TPSM8286xA, apply the typical efficiency stated in this data sheet to the desired application condition to compute the power dissipation of the module. Then, calculate the module temperature rise by multiplying the power dissipation by its thermal resistance. Using this method to compute the maximum device temperature, the Safe Operating Area (SOA) graphs demonstrate the required derating in maximum output current at high ambient temperatures. For more details on how to use the thermal parameters in real applications, see the [Thermal Characteristics of Linear and Logic Packages Using JEDEC PCB Designs Application Report](#) and [Semiconductor and IC Package Thermal Metrics Application Report](#).

10 Device and Documentation Support

10.1 Device Support

10.1.1 第三方产品免责声明

TI 发布的与第三方产品或服务有关的信息，不能构成与此类产品或服务或保修的适用性有关的认可，不能构成此类产品或服务单独或与任何 TI 产品或服务一起的表示或认可。

10.2 Documentation Support

10.2.1 Related Documentation

For related documentation, see the following:

- Texas Instruments, [Thermal Characteristics of Linear and Logic Packages Using JEDEC PCB Designs Application Report](#)
- Texas Instruments, [Semiconductor and IC Package Thermal Metrics Application Report](#)
- Texas Instruments, [Benefits of a Resistor-to-Digital Converter in Ultra-Low Power Supplies White Paper](#)
- Texas Instruments, [Design Considerations for a Resistive Feedback Divider in a DC/DC Converter Technical Brief](#)
- Texas Instruments, [Simplify Low EMI Design With Power Modules White Paper](#)

10.3 接收文档更新通知

要接收文档更新通知，请导航至 [ti.com](https://www.ti.com) 上的器件产品文件夹。点击 [订阅更新](#) 进行注册，即可每周接收产品信息更改摘要。有关更改的详细信息，请查看任何已修订文档中包含的修订历史记录。

10.4 支持资源

TI E2E™ [支持论坛](#) 是工程师的重要参考资料，可直接从专家获得快速、经过验证的解答和设计帮助。搜索现有解答或提出自己的问题可获得所需的快速设计帮助。

链接的内容由各个贡献者“按原样”提供。这些内容并不构成 TI 技术规范，并且不一定反映 TI 的观点；请参阅 TI 的 [《使用条款》](#)。

10.5 Trademarks

TI E2E™ is a trademark of Texas Instruments.

所有商标均为其各自所有者的财产。

10.6 Electrostatic Discharge Caution



This integrated circuit can be damaged by ESD. Texas Instruments recommends that all integrated circuits be handled with appropriate precautions. Failure to observe proper handling and installation procedures can cause damage.

ESD damage can range from subtle performance degradation to complete device failure. Precision integrated circuits may be more susceptible to damage because very small parametric changes could cause the device not to meet its published specifications.

10.7 术语表

[TI 术语表](#) 本术语表列出并解释了术语、首字母缩略词和定义。

11 Mechanical, Packaging, and Orderable Information

The following pages include mechanical, packaging, and orderable information. This information is the most current data available for the designated devices. This data is subject to change without notice and revision of this document. For browser-based versions of this data sheet, refer to the left-hand navigation.

PACKAGING INFORMATION

Orderable Device	Status (1)	Package Type	Package Drawing	Pins	Package Qty	Eco Plan (2)	Lead finish/ Ball material (6)	MSL Peak Temp (3)	Op Temp (°C)	Device Marking (4/5)	Samples
TPSM82864AA0HRDMR	ACTIVE	B0QFN	RDM	23	3000	RoHS & Green	NIPDAU	Level-3-260C-168 HR	-40 to 125	TM864AA0H	Samples
TPSM82864AA0SRDJR	ACTIVE	B0QFN	RDJ	23	3000	RoHS & Green	NIPDAU	Level-3-260C-168 HR	-40 to 125	TM864AA0S	Samples
TPSM82866AA0HRDMR	ACTIVE	B0QFN	RDM	23	3000	RoHS & Green	NIPDAU	Level-3-260C-168 HR	-40 to 125	TM866AA0H	Samples
TPSM82866AA0SRDJR	ACTIVE	B0QFN	RDJ	23	3000	RoHS & Green	NIPDAU	Level-3-260C-168 HR	-40 to 125	TM866AA0S	Samples

(1) The marketing status values are defined as follows:

ACTIVE: Product device recommended for new designs.

LIFEBUY: TI has announced that the device will be discontinued, and a lifetime-buy period is in effect.

NRND: Not recommended for new designs. Device is in production to support existing customers, but TI does not recommend using this part in a new design.

PREVIEW: Device has been announced but is not in production. Samples may or may not be available.

OBSOLETE: TI has discontinued the production of the device.

(2) **RoHS:** TI defines "RoHS" to mean semiconductor products that are compliant with the current EU RoHS requirements for all 10 RoHS substances, including the requirement that RoHS substance do not exceed 0.1% by weight in homogeneous materials. Where designed to be soldered at high temperatures, "RoHS" products are suitable for use in specified lead-free processes. TI may reference these types of products as "Pb-Free".

RoHS Exempt: TI defines "RoHS Exempt" to mean products that contain lead but are compliant with EU RoHS pursuant to a specific EU RoHS exemption.

Green: TI defines "Green" to mean the content of Chlorine (Cl) and Bromine (Br) based flame retardants meet JS709B low halogen requirements of <=1000ppm threshold. Antimony trioxide based flame retardants must also meet the <=1000ppm threshold requirement.

(3) MSL, Peak Temp. - The Moisture Sensitivity Level rating according to the JEDEC industry standard classifications, and peak solder temperature.

(4) There may be additional marking, which relates to the logo, the lot trace code information, or the environmental category on the device.

(5) Multiple Device Markings will be inside parentheses. Only one Device Marking contained in parentheses and separated by a "~" will appear on a device. If a line is indented then it is a continuation of the previous line and the two combined represent the entire Device Marking for that device.

(6) Lead finish/Ball material - Orderable Devices may have multiple material finish options. Finish options are separated by a vertical ruled line. Lead finish/Ball material values may wrap to two lines if the finish value exceeds the maximum column width.

Important Information and Disclaimer:The information provided on this page represents TI's knowledge and belief as of the date that it is provided. TI bases its knowledge and belief on information provided by third parties, and makes no representation or warranty as to the accuracy of such information. Efforts are underway to better integrate information from third parties. TI has taken and

continues to take reasonable steps to provide representative and accurate information but may not have conducted destructive testing or chemical analysis on incoming materials and chemicals. TI and TI suppliers consider certain information to be proprietary, and thus CAS numbers and other limited information may not be available for release.

In no event shall TI's liability arising out of such information exceed the total purchase price of the TI part(s) at issue in this document sold by TI to Customer on an annual basis.

TAPE AND REEL INFORMATION

QUADRANT ASSIGNMENTS FOR PIN 1 ORIENTATION IN TAPE



*All dimensions are nominal

Device	Package Type	Package Drawing	Pins	SPQ	Reel Diameter (mm)	Reel Width W1 (mm)	A0 (mm)	B0 (mm)	K0 (mm)	P1 (mm)	W (mm)	Pin1 Quadrant
TPSM82864AA0HRDMR	B0QFN	RDM	23	3000	330.0	17.6	3.8	4.3	2.0	8.0	12.0	Q1
TPSM82864AA0SRDJR	B0QFN	RDJ	23	3000	330.0	17.6	3.8	4.3	2.0	8.0	12.0	Q1
TPSM82866AA0HRDMR	B0QFN	RDM	23	3000	330.0	17.6	3.8	4.3	2.0	8.0	12.0	Q1
TPSM82866AA0SRDJR	B0QFN	RDJ	23	3000	330.0	17.6	3.8	4.3	2.0	8.0	12.0	Q1

TAPE AND REEL BOX DIMENSIONS

*All dimensions are nominal

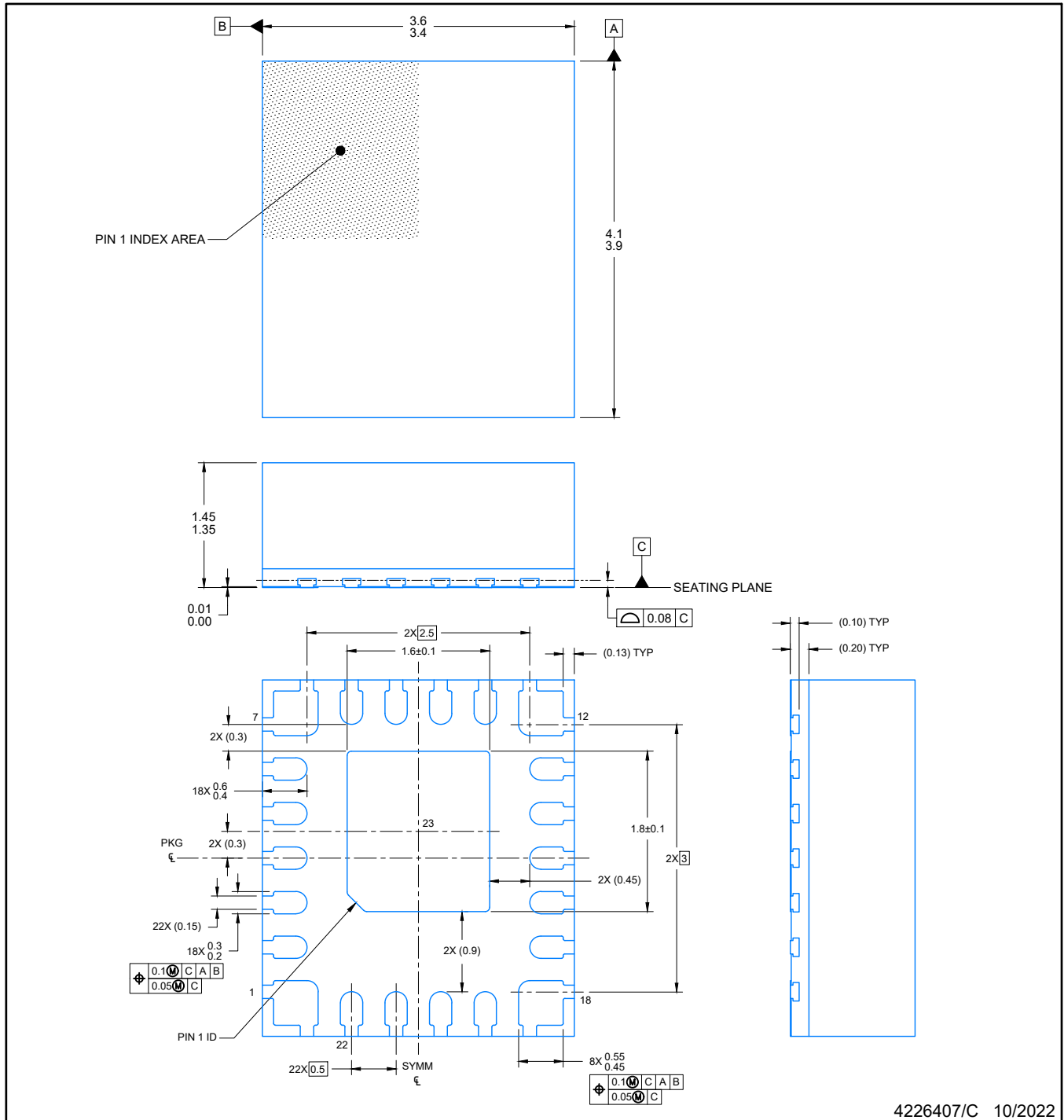
Device	Package Type	Package Drawing	Pins	SPQ	Length (mm)	Width (mm)	Height (mm)
TPSM82864AA0HRDMR	BOQFN	RDM	23	3000	336.0	336.0	48.0
TPSM82864AA0SRDJR	BOQFN	RDJ	23	3000	336.0	336.0	48.0
TPSM82866AA0HRDMR	BOQFN	RDM	23	3000	336.0	336.0	48.0
TPSM82866AA0SRDJR	BOQFN	RDJ	23	3000	336.0	336.0	48.0



4226407/C 10/2022

NOTES:

1. All linear dimensions are in millimeters. Any dimensions in parenthesis are for reference only. Dimensioning and tolerancing per ASME Y14.5M.
2. This drawing is subject to change without notice.
3. The package thermal pad must be soldered to the printed circuit board for optimal thermal and mechanical performance.

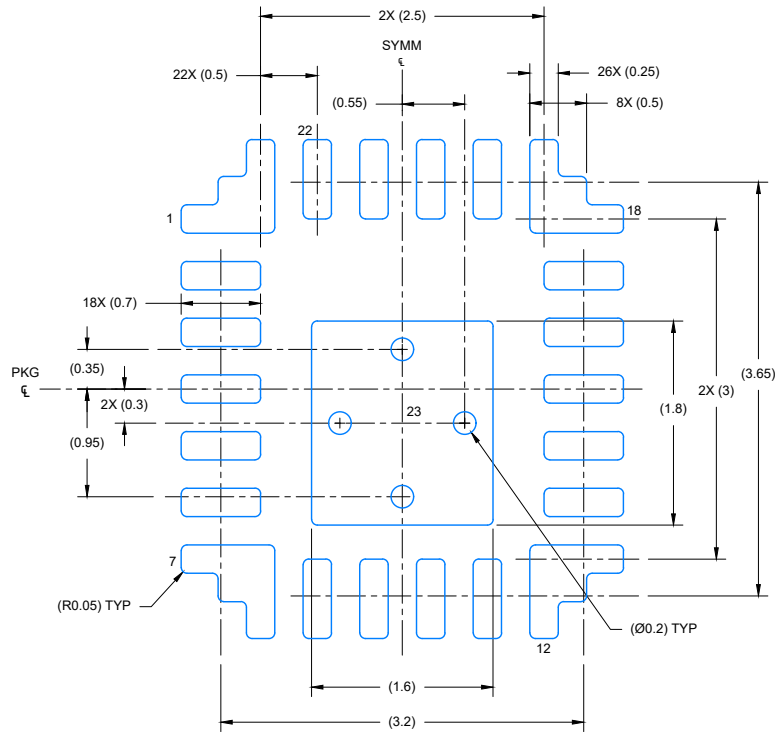

LAND PATTERN EXAMPLE
EXPOSED METAL SHOWN
SCALE: 15X

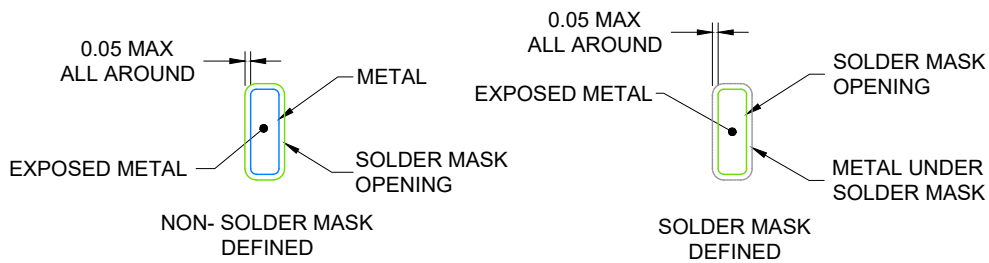

SOLDER MASK DETAILS

4226407/C 10/2022

NOTES: (continued)

4. This package is designed to be soldered to a thermal pad on the board. For more information, see Texas Instruments literature number SLUA271 (www.ti.com/lit/sluea271).
5. Vias are optional depending on application, refer to device data sheet. If any vias are implemented, refer to their locations shown on this view. It is recommended that vias under paste be filled, plugged or tented.

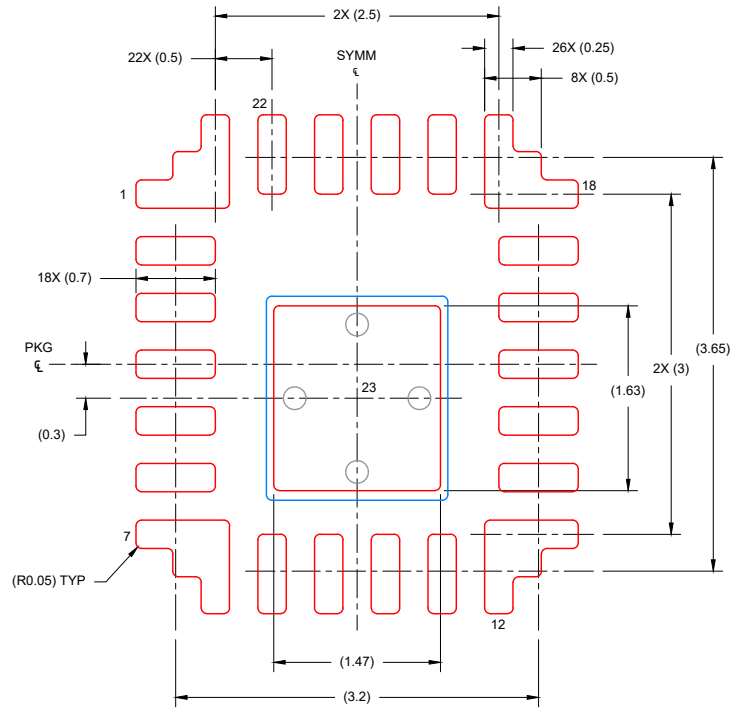

SOLDER PASTE EXAMPLE
 BASED ON 0.1 mm THICK STENCIL

EXPOSED PAD:
 83% PRINTED SOLDER COVERAGE BY AREA

SCALE: 15X

4226407/C 10/2022

NOTES: (continued)

6. Laser cutting apertures with trapezoidal walls and rounded corners may offer better paste release. IPC-7525 may have alternate design recommendations.

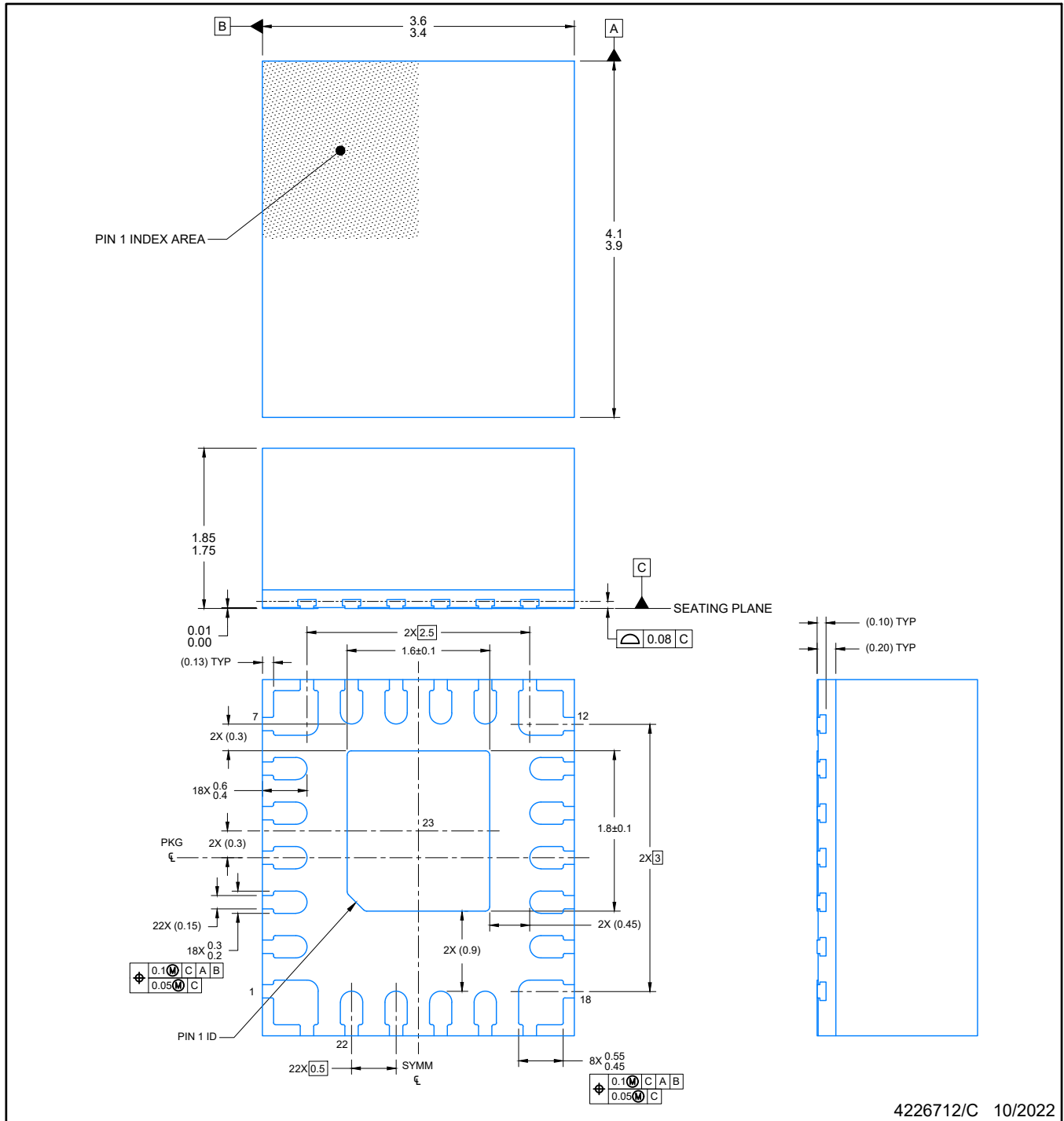

4226712/C 10/2022

NOTES:

1. All linear dimensions are in millimeters. Any dimensions in parenthesis are for reference only. Dimensioning and tolerancing per ASME Y14.5M.
2. This drawing is subject to change without notice.
3. The package thermal pad must be soldered to the printed circuit board for optimal thermal and mechanical performance.

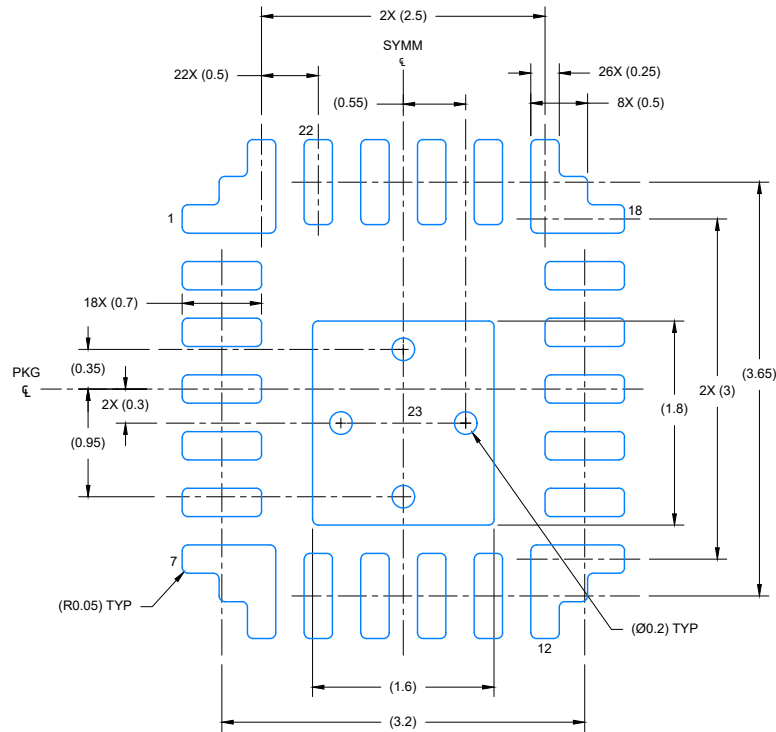

LAND PATTERN EXAMPLE
EXPOSED METAL SHOWN
SCALE: 15X

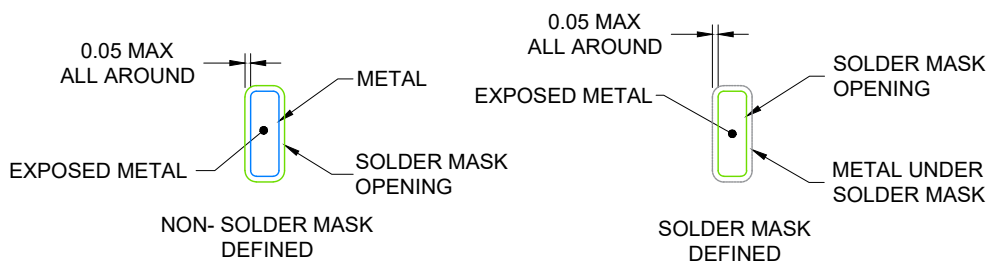

SOLDER MASK DETAILS

4226712/C 10/2022

NOTES: (continued)

4. This package is designed to be soldered to a thermal pad on the board. For more information, see Texas Instruments literature number SLUA271 (www.ti.com/lit/slua271).
5. Vias are optional depending on application, refer to device data sheet. If any vias are implemented, refer to their locations shown on this view. It is recommended that vias under paste be filled, plugged or tented.

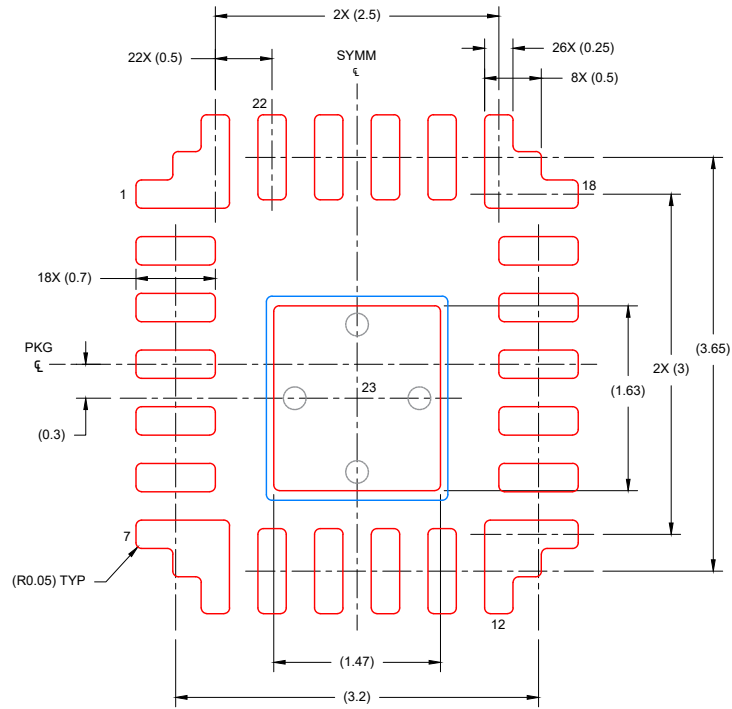

SOLDER PASTE EXAMPLE
 BASED ON 0.1 mm THICK STENCIL

EXPOSED PAD:
 83% PRINTED SOLDER COVERAGE BY AREA

SCALE: 15X

4226712/C 10/2022

NOTES: (continued)

6. Laser cutting apertures with trapezoidal walls and rounded corners may offer better paste release. IPC-7525 may have alternate design recommendations.

重要声明和免责声明

TI“按原样”提供技术和可靠性数据（包括数据表）、设计资源（包括参考设计）、应用或其他设计建议、网络工具、安全信息和其他资源，不保证没有瑕疵且不做任何明示或暗示的担保，包括但不限于对适销性、某特定用途方面的适用性或不侵犯任何第三方知识产权的暗示担保。

这些资源可供使用 TI 产品进行设计的熟练开发人员使用。您将自行承担以下全部责任：(1) 针对您的应用选择合适的 TI 产品，(2) 设计、验证并测试您的应用，(3) 确保您的应用满足相应标准以及任何其他功能安全、信息安全、监管或其他要求。

这些资源如有变更，恕不另行通知。TI 授权您仅可将这些资源用于研发本资源所述的 TI 产品的应用。严禁对这些资源进行其他复制或展示。您无权使用任何其他 TI 知识产权或任何第三方知识产权。您应全额赔偿因在这些资源的使用中对 TI 及其代表造成的任何索赔、损害、成本、损失和债务，TI 对此概不负责。

TI 提供的产品受 [TI 的销售条款](#) 或 [ti.com](#) 上其他适用条款/TI 产品随附的其他适用条款的约束。TI 提供这些资源并不会扩展或以其他方式更改 TI 针对 TI 产品发布的适用的担保或担保免责声明。

TI 反对并拒绝您可能提出的任何其他或不同的条款。

邮寄地址：Texas Instruments, Post Office Box 655303, Dallas, Texas 75265

Copyright © 2022，德州仪器 (TI) 公司