

## 具有 PWM 输出的DRV5057-Q1汽车类线性霍尔效应传感器

### 1 特性

- 具有符合面向汽车 标准
  - 温度等级 0:  $-40^{\circ}\text{C}$  至  $150^{\circ}\text{C}$
- PWM 输出线性霍尔效应磁传感器
- 由 3.3V 和 5V 电源供电
- 2kHz 时钟输出, 静态占空比为 50%
- 磁性灵敏度选项 ( $V_{CC} = 5\text{V}$  时):
  - A1: 2%D/mT,  $\pm 21\text{mT}$  范围
  - A2: 1%D/mT,  $\pm 42\text{mT}$  范围
  - A3: 0.5%D/mT,  $\pm 84\text{mT}$  范围
  - A4: 0.25%D/mT,  $\pm 168\text{mT}$  范围
- 开漏输出, 具有 20mA 灌电流能力
- 磁体温度漂移补偿
- 行业标准封装:
  - 表面贴装 SOT-23

### 2 应用

- 汽车位置检测
- 制动踏板、油门踏板、离合器踏板
- 扭矩传感器、换挡器
- 节气门位置、高度找平
- 动力传动系统和变速器组件
- 绝对值角度编码
- 电流检测

### 3 说明

DRV5057-Q1 是一款线性霍尔效应传感器, 可按比例响应磁通量密度。该器件可用于进行精确的位置检测, 应用范围广泛。

该器件由 3.3V 或 5V 电源供电。当不存在磁场时, 输出产生占空比为 50% 的时钟。输出占空比会随施加的磁通量密度呈线性变化, 四个灵敏度选项可以根据所需的感应范围最大限度扩大输出动态范围。南北磁极产生唯一的输出。典型的脉宽调制 (PWM) 载波频率为 2kHz。

它可检测垂直于封装顶部的磁通量, 而且两个封装选项提供不同的检测方向。

由于 PWM 信号基于边沿到边沿定时, 因此当存在电压噪声或接地电势失配时, 可保持信号完整性。该信号适合嘈杂环境中的远距离传输, 始终存在的时钟使得系统控制器能够确认具备良好的互连。此外, 该器件还具有磁体温度补偿功能, 可以抵消磁体漂移, 在  $-40^{\circ}\text{C}$  至  $+150^{\circ}\text{C}$  的宽温度范围内实现线性特性。

#### 器件信息<sup>(1)</sup>

器件型号	封装	封装尺寸 (标称值)
DRV5057-Q1	SOT-23 (3)	2.92mm × 1.30mm

(1) 如需了解所有可用封装, 请参阅数据表末尾的封装选项附录。

典型原理图

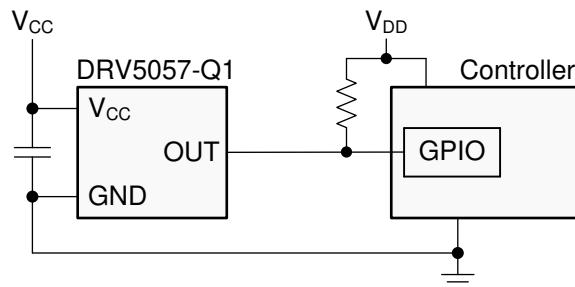

磁响应

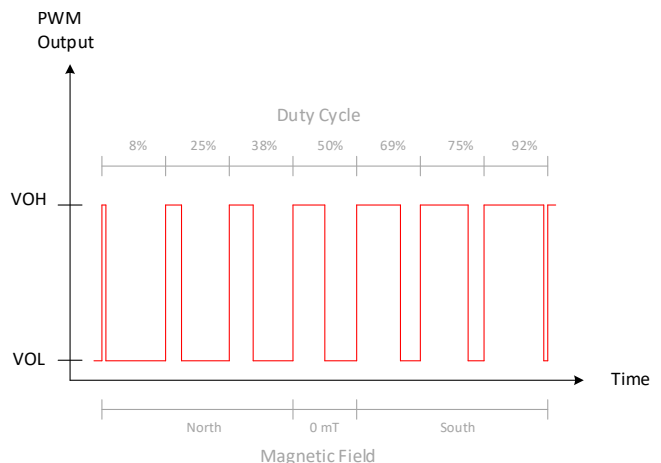

## 目录

<b>1</b>	特性 .....	1	7.4	Device Functional Modes.....	11
<b>2</b>	应用 .....	1	<b>8</b>	<b>Application and Implementation</b> .....	12
<b>3</b>	说明 .....	1	8.1	Application Information.....	12
<b>4</b>	修订历史记录 .....	2	8.2	Typical Applications .....	14
<b>5</b>	<b>Pin Configuration and Functions</b> .....	3	8.3	What to Do and What Not to Do .....	20
<b>6</b>	<b>Specifications</b> .....	4	<b>9</b>	<b>Power Supply Recommendations</b> .....	21
6.1	Absolute Maximum Ratings .....	4	<b>10</b>	<b>Layout</b> .....	21
6.2	ESD Ratings.....	4	10.1	Layout Guidelines .....	21
6.3	Recommended Operating Conditions.....	4	10.2	Layout Example .....	21
6.4	Thermal Information .....	4	<b>11</b>	<b>器件和文档支持</b> .....	22
6.5	Electrical Characteristics.....	5	11.1	文档支持 .....	22
6.6	Magnetic Characteristics.....	5	11.2	接收文档更新通知 .....	22
6.7	Typical Characteristics .....	6	11.3	社区资源 .....	22
<b>7</b>	<b>Detailed Description</b> .....	8	11.4	商标 .....	22
7.1	Overview .....	8	11.5	静电放电警告 .....	22
7.2	Functional Block Diagram .....	8	11.6	Glossary .....	22
7.3	Feature Description.....	8	<b>12</b>	<b>机械、封装和可订购信息</b> .....	22

## 4 修订历史记录

日期	修订版本	说明
2019 年 8 月	*	初始发行版。

## 5 Pin Configuration and Functions

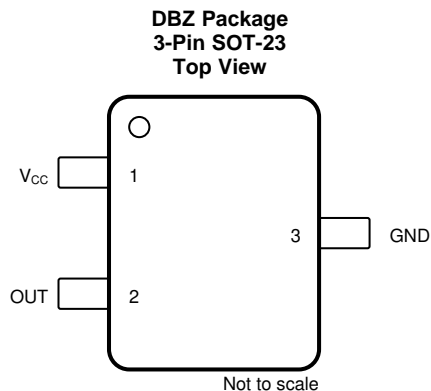

### Pin Functions

PIN		TYPE	DESCRIPTION
NAME	NO.		
GND	3	Ground	Ground reference
OUT	2	Output	Analog output
V <sub>CC</sub>	1	Power	Power supply. Connect this pin to a ceramic capacitor to ground with a value of at least 0.01 $\mu$ F.

## 6 Specifications

### 6.1 Absolute Maximum Ratings

over operating free-air temperature range (unless otherwise noted)<sup>(1)</sup>

			MIN	MAX	UNIT
V <sub>CC</sub>	Power supply voltage	V <sub>CC</sub>	-0.3	7	V
	Output voltage	OUT	-0.3	6	V
	Output current	OUT		30	mA
B	Magnetic flux density		Unlimited		T
T <sub>J</sub>	Operating junction temperature		-40	170	°C
T <sub>stg</sub>	Storage temperature		-65	150	°C

- (1) Stresses beyond those listed under *Absolute Maximum Ratings* may cause permanent damage to the device. These are stress ratings only, which do not imply functional operation of the device at these or any other conditions beyond those indicated under *Recommended Operating Conditions*. Exposure to absolute-maximum-rated conditions for extended periods may affect device reliability.

### 6.2 ESD Ratings

			VALUE	UNIT
V <sub>(ESD)</sub>	Electrostatic discharge	Human body model (HBM), per AEC Q100-002 <sup>(1)</sup> HBM ESD classification level 2	±3000	V
		Charged device model (CDM), per AEC Q100-011 CDM ESD classification level C5	±750	

- (1) AEC Q100-002 indicates that HBM stressing shall be in accordance with the ANSI/ESDA/JEDEC JS-001 specification.

### 6.3 Recommended Operating Conditions

over operating free-air temperature range (unless otherwise noted)

			MIN	MAX	UNIT
V <sub>CC</sub>	Power-supply voltage <sup>(1)</sup>		3	3.63	V
			4.5	5.5	
V <sub>O</sub>	Output pullup voltage		0	5.5	V
I <sub>O</sub>	Output continuous current		0	20	mA
T <sub>A</sub>	Operating ambient temperature <sup>(2)</sup>		-40	150	°C

- (1) There are two isolated operating V<sub>CC</sub> ranges. For more information see the [Operating V<sub>CC</sub> Ranges](#) section.  
 (2) Power dissipation and thermal limits must be observed.

### 6.4 Thermal Information

THERMAL METRIC <sup>(1)</sup>		DRV5057-Q1	UNIT
		SOT-23 (DBZ)	
		3 PINS	
R <sub>θJA</sub>	Junction-to-ambient thermal resistance	170	°C/W
R <sub>θJC(top)</sub>	Junction-to-case (top) thermal resistance	66	°C/W
R <sub>θJB</sub>	Junction-to-board thermal resistance	49	°C/W
Ψ <sub>JT</sub>	Junction-to-top characterization parameter	1.7	°C/W
Ψ <sub>JB</sub>	Junction-to-board characterization parameter	48	°C/W

- (1) For more information about traditional and new thermal metrics, see the [Semiconductor and IC Package Thermal Metrics](#) application report.

## 6.5 Electrical Characteristics

for  $V_{CC} = 3\text{ V}$  to  $3.63\text{ V}$  and  $4.5\text{ V}$  to  $5.5\text{ V}$ , over operating free-air temperature range (unless otherwise noted)

PARAMETER		TEST CONDITIONS	MIN	TYP	MAX	UNIT
$I_{CC}$	Operating supply current			6	10	mA
$t_{ON}$	Power-on time (see <a href="#">图 15</a> ) <sup>(1)</sup>	$B^{(2)} = 0\text{ mT}$ , no load on OUT		0.6	0.9	ms
$f_{PWM}$	PWM carrier frequency		1.8	2.0	2.2	kHz
$D_J$	Duty cycle peak-to-peak jitter	From change in B to change in OUT		$\pm 0.1$		%D <sup>(3)</sup>
$I_{OZ}$	High-impedance output leakage current	$V_{CC} = 5\text{ V}$			100	nA
$V_{OL}$	Low-level output voltage	$I_{OUT} = 20\text{ mA}$		0.15	0.4	V

(1)  $t_{ON}$  is the time from when  $V_{CC}$  goes above  $3\text{ V}$  until the first rising edge of the first valid pulse.

(2) B is the applied magnetic flux density.

(3) This unit is a percentage of duty cycle.

## 6.6 Magnetic Characteristics

for  $V_{CC} = 3\text{ V}$  to  $3.63\text{ V}$  and  $4.5\text{ V}$  to  $5.5\text{ V}$ , over operating free-air temperature range (unless otherwise noted)

PARAMETER		TEST CONDITIONS	MIN	TYP	MAX	UNIT	
$D_L$	Linear duty cycle range		8		92	%D <sup>(1)</sup>	
$D_{CL}$	Clamped-low duty cycle	$B^{(2)} < -250\text{ mT}$	5.3	6	6.7	%D	
$D_{CH}$	Clamped-high duty cycle	$B > 250\text{ mT}$	93.3	94	94.7	%D	
$D_Q$	Quiescent duty cycle <sup>(3)</sup>	$B = 0\text{ mT}$ , $T_A = 25^\circ\text{C}$ , $V_{CC} = 3.3\text{ V}$ or $5\text{ V}$	43	50	57	%D	
$V_{Q\Delta L}$	Quiescent duty cycle lifetime drift	High-temperature operating stress for 1000 hours		< 0.5		%	
S	Sensitivity	$V_{CC} = 5\text{ V}$ , $T_A = 25^\circ\text{C}$	DRV5057A1-Q1	1.88	2	2.12	%D/mT
			DRV5057A2-Q1	0.94	1	1.06	
			DRV5057A3-Q1	0.47	0.5	0.53	
			DRV5057A4-Q1	0.23	0.25	0.27	
		$V_{CC} = 3.3\text{ V}$ , $T_A = 25^\circ\text{C}$	DRV5057A1-Q1	1.13	1.2	1.27	
			DRV5057A2-Q1	0.56	0.6	0.64	
			DRV5057A3-Q1	0.28	0.3	0.32	
			DRV5057A4-Q1	0.138	0.15	0.162	
$B_L$	Linear magnetic flux density sensing range <sup>(3)(4)</sup>	$V_{CC} = 5\text{ V}$ , $T_A = 25^\circ\text{C}$	DRV5057A1-Q1		$\pm 21$	mT	
			DRV5057A2-Q1		$\pm 42$		
			DRV5057A3-Q1		$\pm 84$		
			DRV5057A4-Q1		$\pm 168$		
$S_{TC}$	Sensitivity temperature compensation for magnets <sup>(5)</sup>			0.12		%/ $^\circ\text{C}$	
$S_{LE}$	Sensitivity linearity error <sup>(3)</sup>	Output duty cycle is within $D_L$		$\pm 1$		%	
$R_{SE}$	Sensitivity error over operating VCC range	Output duty cycle is within $D_L$		$\pm 1$		%	
$S_{\Delta L}$	Quiescent error over operating VCC range			< 0.5		%	

(1) This unit is a percentage of duty cycle.

(2) B is the applied magnetic flux density.

(3) See the [Sensitivity Linearity](#) section.

(4)  $B_L$  describes the minimum linear sensing range at  $25^\circ\text{C}$  taking into account the maximum  $V_Q$  and sensitivity tolerances.

(5)  $S_{TC}$  describes the rate the device increases Sensitivity with temperature. For more information, see the [Sensitivity Temperature Compensation for Magnets](#) section and [图 4](#) to [图 11](#).

### 6.7 Typical Characteristics

for  $T_A = 25^\circ\text{C}$  (unless otherwise noted)



图 1. Sensitivity vs Supply Voltage



图 2. Sensitivity vs Supply Voltage

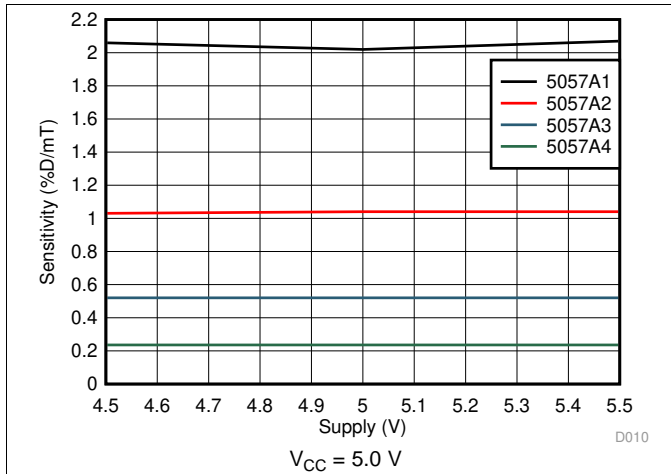

图 3. Supply Current vs Temperature

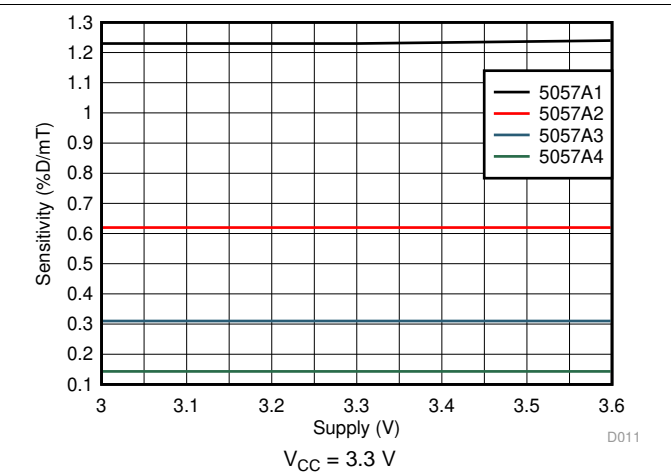

DRV5057A1-Q1,  $V_{CC} = 5.0\text{ V}$

图 4. Sensitivity vs Temperature

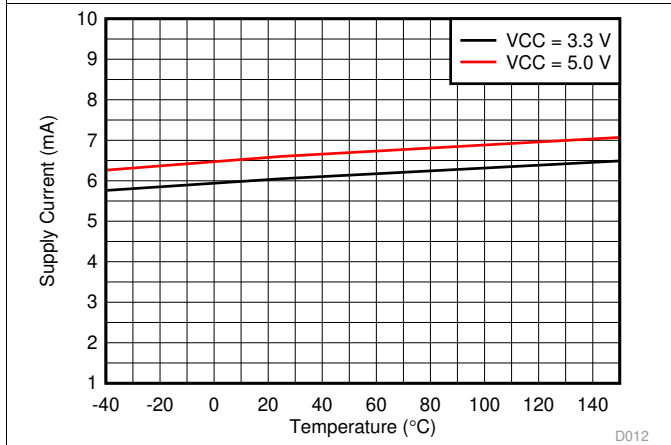
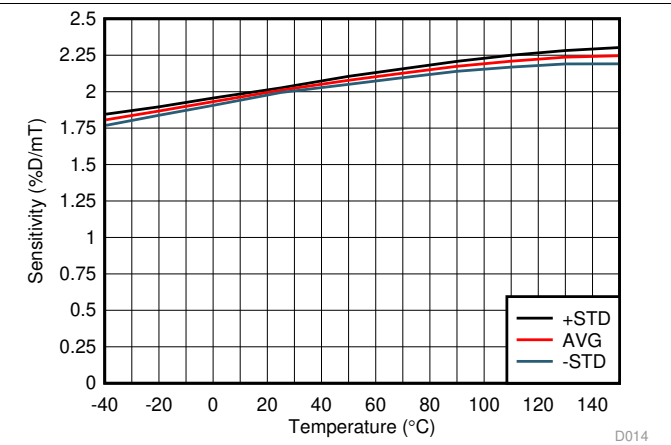
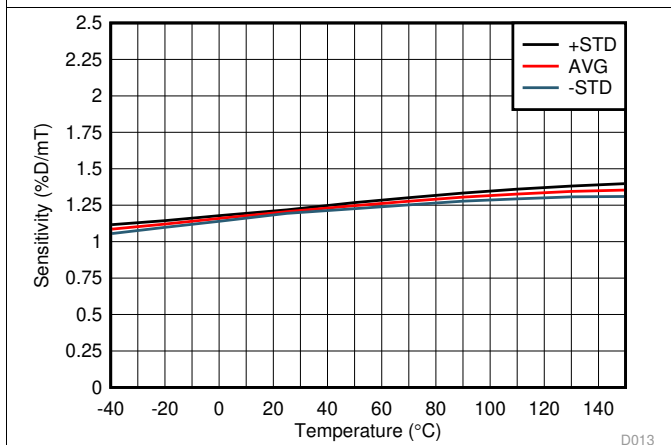

DRV5057A1-Q1,  $V_{CC} = 3.3\text{ V}$

图 5. Sensitivity vs Temperature

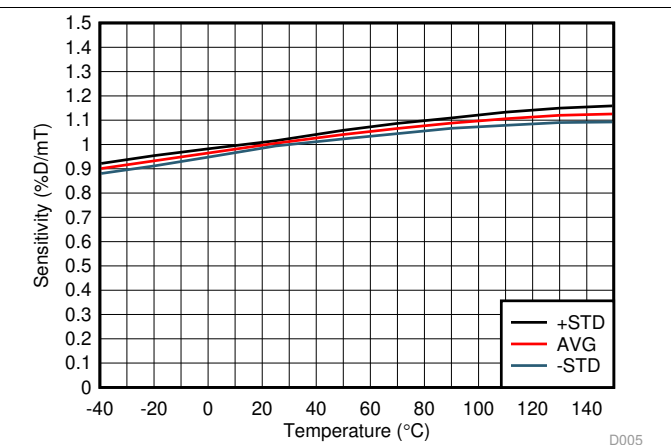

DRV5057A2-Q1,  $V_{CC} = 5.0\text{ V}$

图 6. Sensitivity vs Temperature

Typical Characteristics (接下页)

for  $T_A = 25^\circ\text{C}$  (unless otherwise noted)

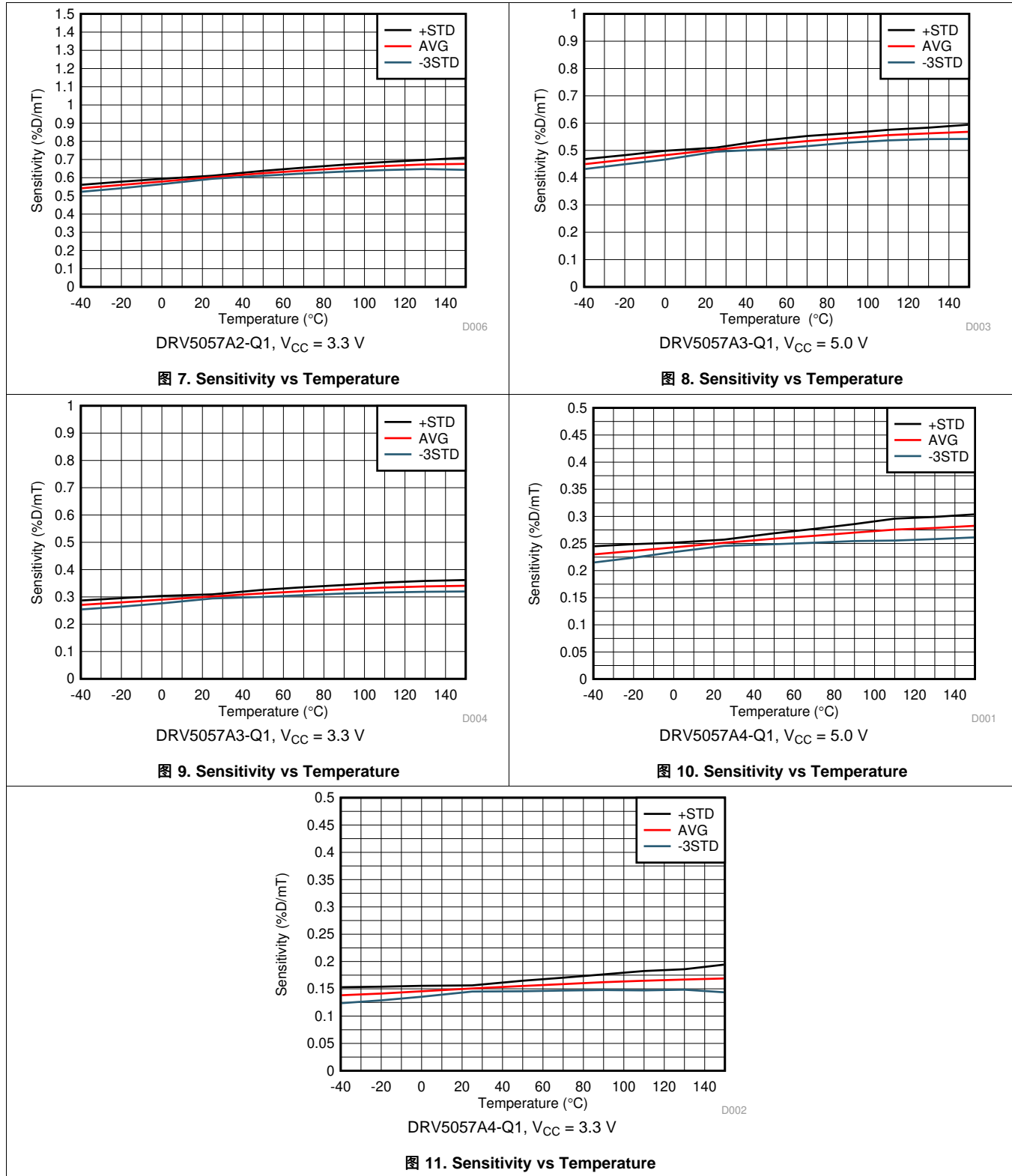

## 7 Detailed Description

### 7.1 Overview

The DRV5057-Q1 is a 3-pin pulse-width modulation (PWM) output Hall effect sensor with fully integrated signal conditioning, temperature compensation circuits, mechanical stress cancellation, and amplifiers. The device operates from 3.3-V and 5-V ( $\pm 10\%$ ) power supplies, measures magnetic flux density, and outputs a pulse-width modulated, 2-kHz digital signal.

### 7.2 Functional Block Diagram

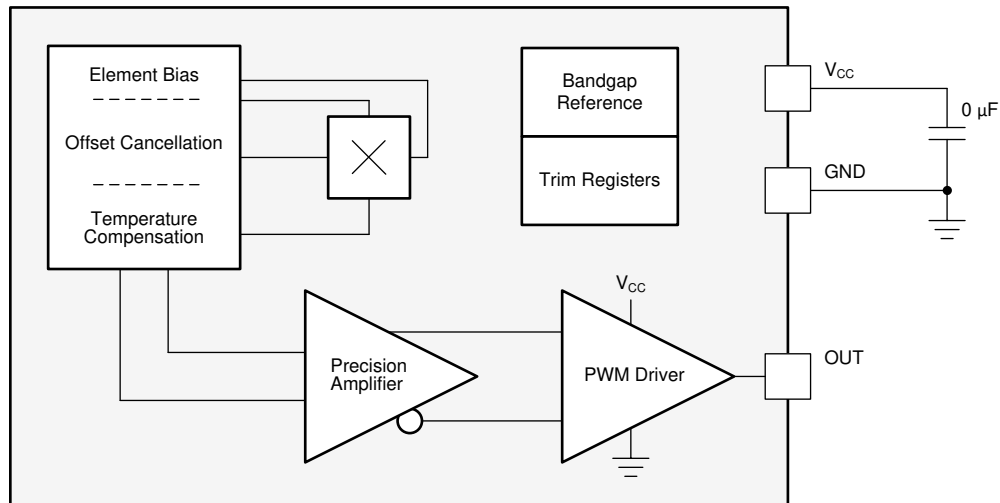

### 7.3 Feature Description

#### 7.3.1 Magnetic Flux Direction

As shown in [图 12](#), the DRV5057-Q1 is sensitive to the magnetic field component that is perpendicular to the top of the package.

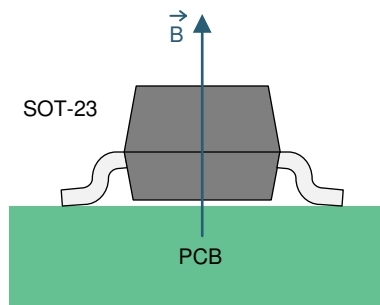

**图 12. Direction of Sensitivity**



### Feature Description (接下页)

Magnetic flux that travels from the bottom to the top of the package is considered positive in this document. This condition exists when a south magnetic pole is near the top (marked-side) of the package. Magnetic flux that travels from the top to the bottom of the package results in negative millitesla values. 图 13 shows flux direction.



图 13. Flux Direction for Positive B

### 7.3.2 Sensitivity Linearity

The device produces a pulse-width modulated digital signal output. As shown in 图 14, the duty-cycle of the PWM output signal is proportional to the magnetic field detected by the Hall element of the device. If there is no magnetic field present, the duty cycle is 50%. The DRV5057-Q1 can detect both magnetic north and south poles. The output duty cycle maintains a linear relationship with the input magnetic field from 8% to 92%.

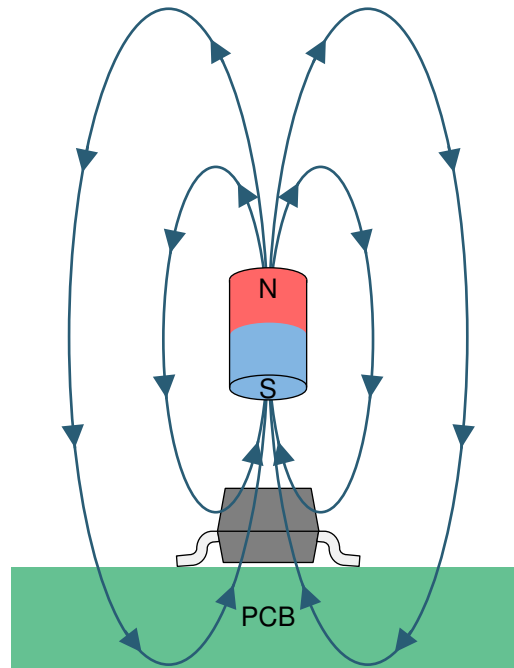

图 14. Magnetic Response

## Feature Description (接下页)

### 7.3.3 Operating $V_{CC}$ Ranges

The DRV5057-Q1 has two recommended operating  $V_{CC}$  ranges: 3 V to 3.63 V and 4.5 V to 5.5 V. When  $V_{CC}$  is in the middle region between 3.63 V to 4.5 V, the device continues to function but sensitivity is less known because there is a crossover threshold near 4 V that adjusts device characteristics.

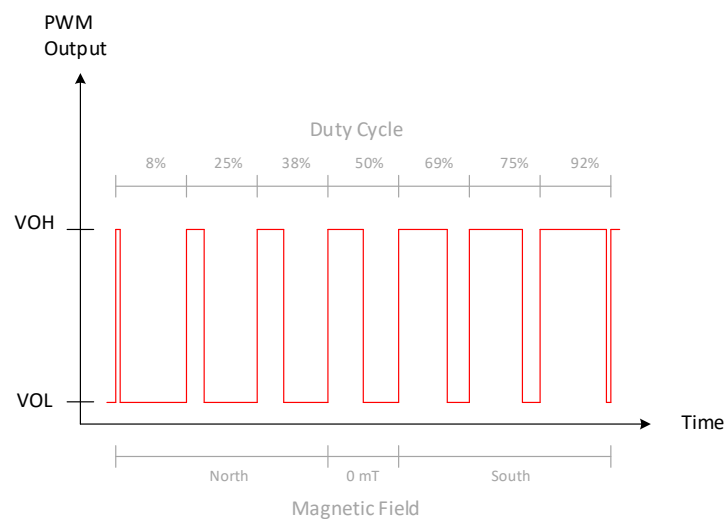
### 7.3.4 Sensitivity Temperature Compensation for Magnets

Magnets generally produce weaker fields as temperature increases. The DRV5057-Q1 has a temperature compensation feature that is designed to directly compensate the average drift of neodymium (NdFeB) magnets and partially compensate ferrite magnets. The residual induction ( $B_r$ ) of a magnet typically reduces by 0.12%/°C for NdFeB, and 0.20%/°C for ferrite. When the operating temperature of a system is reduced, temperature drift errors are also reduced.

### 7.3.5 Power-On Time

After the  $V_{CC}$  voltage is applied, the DRV5057-Q1 requires a short initialization time before the output is set. The parameter  $t_{ON}$  describes the time from when  $V_{CC}$  crosses 3 V until OUT is within 5% of  $V_Q$ , with 0 mT applied and no load attached to OUT. 图 15 shows this timing diagram.



图 15.  $t_{ON}$  Definition

## Feature Description (接下页)

### 7.3.6 Hall Element Location

图 16 shows the location of the sensing element inside each package option.

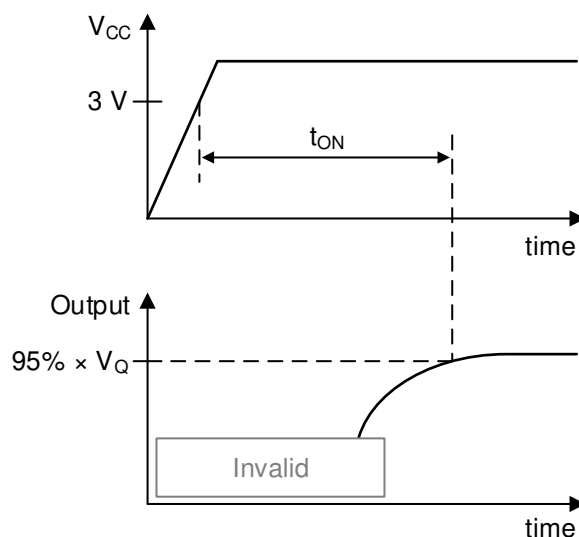

图 16. Hall Element Location

## 7.4 Device Functional Modes

The DRV5057-Q1 has one mode of operation that applies when the *Recommended Operating Conditions* are met.

## 8 Application and Implementation

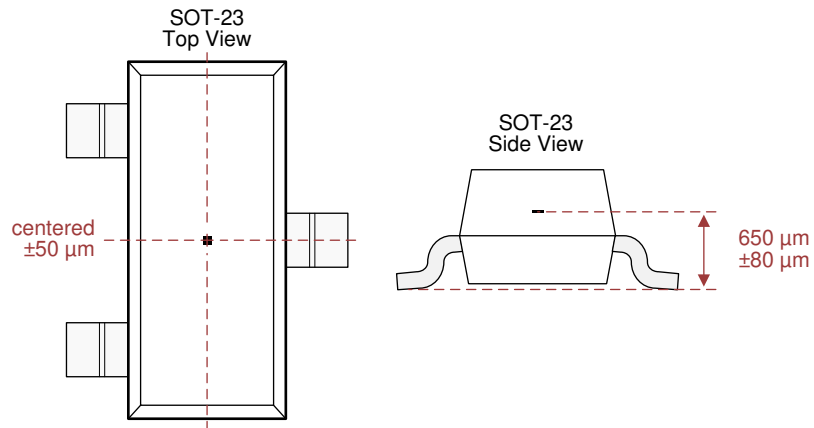
### 注

Information in the following applications sections is not part of the TI component specification, and TI does not warrant its accuracy or completeness. TI's customers are responsible for determining suitability of components for their purposes. Customers should validate and test their design implementation to confirm system functionality.

### 8.1 Application Information

#### 8.1.1 Selecting the Sensitivity Option

Select the highest DRV5057-Q1 sensitivity option that can measure the required range of magnetic flux density so that the output voltage swing is maximized.

Larger-sized magnets and farther sensing distances can generally enable better positional accuracy than very small magnets at close distances, because magnetic flux density increases exponentially with the proximity to a magnet. TI created an online tool to help with simple magnet calculations on the [DRV5057-Q1 product folder](#).

#### 8.1.2 Decoding a PWM

A PWM output helps system designers drive signals for long distances in noisy environments, with the ability to retrieve the signal accurately. A decoder is employed at the load to retrieve the analog magnetic signal. Two different methods of decoding are discussed in this section.

##### 8.1.2.1 Decoding a PWM (Digital)

###### 8.1.2.1.1 Capture and Compare Timer Interrupt

Many microcontrollers have a capture and compare timer mode that can simplify the PWM decoding process. Use the timer in capture and compare mode with an interrupt that triggers on both the rising and falling edges of the signal to obtain both the relative high (on) and low (off) time of the PWM. Make sure that the timer period is significantly faster than the period of the PWM, based on the desired resolution. Calculate the percent duty cycle (%D) of the PWM with [公式 1](#) by using the relative on and off time of the signal.

$$\%D = \frac{\text{OnTime}}{\text{OnTime} + \text{OffTime}} \times 100 \quad (1)$$

###### 8.1.2.1.2 Oversampling and Counting With a Timer Interrupt

If a capture and compare timer is not available, a standard timer interrupt and a counter can be used. Configure the timer interrupt to be significantly faster than the period of the PWM, based on the desired resolution. Count how many times the timer interrupts while the signal is high (OnTime), then count how many times the timer interrupts while the signal is low (OffTime). Then use [公式 1](#) to calculate the duty cycle.

###### 8.1.2.1.3 Accuracy and Resolution

The accuracy and resolution for the methods described in the [Capture and Compare Timer Interrupt](#) and [Oversampling and Counting With a Timer Interrupt](#) sections depends significantly on the timer sampling frequency. [公式 2](#) calculates the least significant bit of the duty cycle (%D<sub>LSB</sub>) based on the chosen timer sampling frequency.

$$\%D_{\text{LSB}} = \frac{\text{PWM}_{\text{frequency}}}{\text{TIMER}_{\text{frequency}}} \times 100 \quad (2)$$

For example, with a 2-kHz PWM and a 400-kHz sampling frequency, the %D<sub>LSB</sub> is:

$$(2 \text{ kHz} / 400 \text{ kHz}) \times 100 = 0.5\%D_{\text{LSB}}$$

If the sampling frequency is increased to 2-MHz, the %D<sub>LSB</sub> is improved to be:

$$(2 \text{ MHz} / 400 \text{ kHz}) \times 100 = 0.1\%D_{\text{LSB}}$$

However, accuracy and resolution are still subject to noise and sensitivity.

## Application Information (接下页)

### 8.1.2.2 Decoding a PWM (Analog)

If an analog signal is needed at the end of a large travel distance, first use a microcontroller to digitally decode the PWM, then use a DAC to produce the analog signal. If an analog signal is needed after a short signal travel distance, use an analog output device, such as the [DRV5055-Q1](#).

If an analog signal is needed at the end of a large travel distance and a microcontroller is unavailable, use a low-pass filter to convert the PWM signal into an analog voltage, as shown in [图 17](#). When using this method, note the following:

- A ripple appears at the analog voltage output, causing a decrease in accuracy. The ripple intensity and frequency depend on the values chosen for R and C in the filter.
- The minimum and maximum voltages of the PWM must be known to calculate the magnetic field strength from the analog voltage. Thus, if the signal is traveling a large distance, then the minimum and maximum values must be either measured or buffered back to a known value.



图 17. Low-Pass RC Filter

## 8.2 Typical Applications

The DRV5057-Q1 is a very robust linear position sensor for applications such as throttle positions, brakes, and clutch pedals. In linear position applications, depending on the mechanical placement and design limitations, two common types of magnet orientations are selected: full-swing and half-swing.

### 8.2.1 Full-Swing Orientation Example

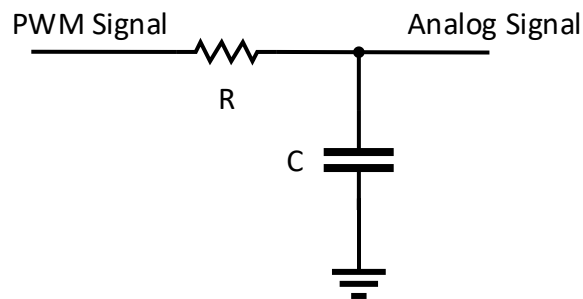
In the full-swing orientation, a magnet travels in parallel to the DRV5057-Q1 surface. In this case, the magnetic range extends from south polarity to north polarity, and allows the DRV5057-Q1 to use the full linear magnetic flux density sensing range.



图 18. Full-Swing Orientation Example

#### 8.2.1.1 Design Requirements

Use the parameters listed in 表 1 for this design example.

表 1. Design Parameters

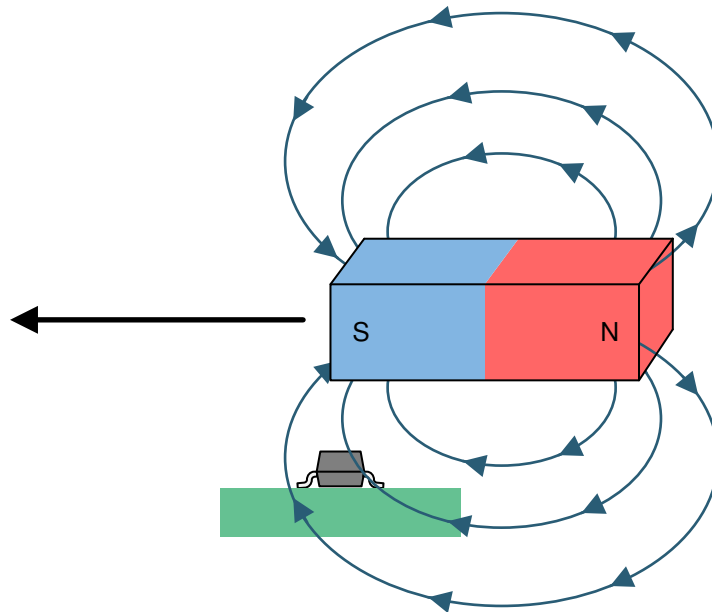
DESIGN PARAMETER	EXAMPLE VALUE
Device	DRV5057-Q1
$V_{CC}$	5 V
Magnet	Cylinder: 4.7625-mm diameter, 12.7-mm thick, neodymium N52, $B_r = 1480$ mT
Travel distance	10 mm
Desired accuracy	< 0.1 mm

### 8.2.1.2 Detailed Design Procedure

Linear Hall effect sensors provide flexibility in mechanical design because many possible magnet orientations and movements produce a usable response from the sensor. 图 18 illustrates one of the most common orientations that uses the full north to south range of the sensor and causes a close-to-linear change in magnetic flux density as the magnet moves across the sensor. 图 19 illustrates the close-to-linear change in magnetic field present at the sensor as the magnet moves a given distance across the sensor. The usable linear region is close to but less than the length (thickness) of the magnet.

When designing a linear magnetic sensing system, always consider these three variables: the magnet, sensing distance, and the range of the sensor. Select the DRV5057-Q1 with the highest sensitivity possible based on the system distance requirements without railing the sensor PWM output. To determine the magnetic flux density the sensor receives at the various positions of the magnet, use a magnetic field calculator or simulation software, referring to magnet specifications, and testing.

Determine if the desired accuracy is met by comparing the maximum allowed duty cycle least significant bit (%D<sub>LSBmax</sub>) with the noise level (PWM jitter) of the device. 公式 3 calculates the %D<sub>LSBmax</sub> by taking into account the used length of the linear region (travel distance), the desired resolution, and the output PWM swing (within the linear duty cycle range).

$$\%D_{LSBmax} = \frac{\%D_{swing}}{\text{Travel Distance}} \times \text{Resolution} \quad (3)$$

Thus, with this example (and a linear duty cycle range of 8%D to 92%D), using 公式 3 gives (92 – 8) / (10) × 0.1 = 0.84%D<sub>LSBmax</sub>. This value is larger than the 0.1%D jitter, and therefore the desired accuracy can be achieved by using 公式 2 to select a %D<sub>LSB</sub> that is equal to or less than 0.84. Then, simply calibrate the magnet position to align the sensor output along the movement path.

### 8.2.1.3 Application Curve

图 19 shows the magnetic field present at the sensor as the magnet passes by as described in 图 18. The change in distance from the trough to the peak is approximately the length (thickness) of the magnet. B changes based on the strength of the magnet and how close the magnet is to the sensor.



图 19. Magnetic Field vs Distance

## 8.2.2 Half-Swing Orientation Example

In the half-swing orientation, a magnet travels perpendicular to the DRV5057-Q1 surface. In this case, the magnetic range extends only to either the south or north pole, using only half of the DRV5057-Q1 linear magnetic flux density sensing range.

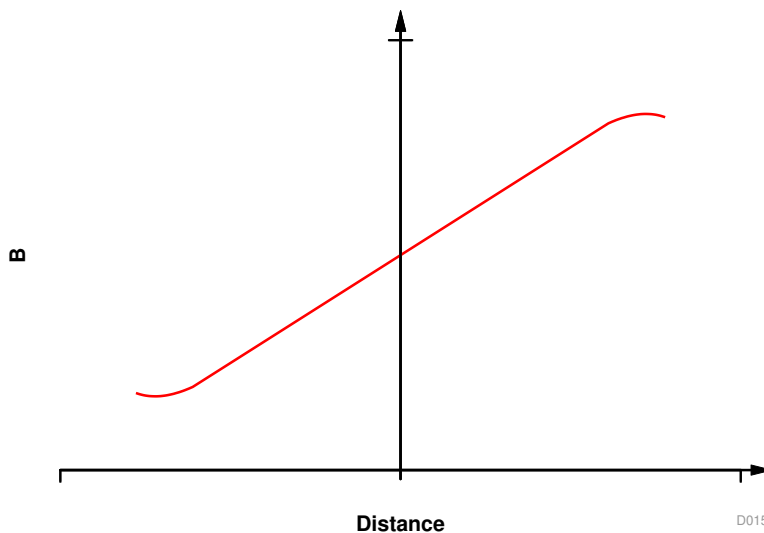

图 20. Half-Swing Orientation Example

### 8.2.2.1 Design Requirements

Use the parameters listed in 表 2 for this design example.

表 2. Design Parameters

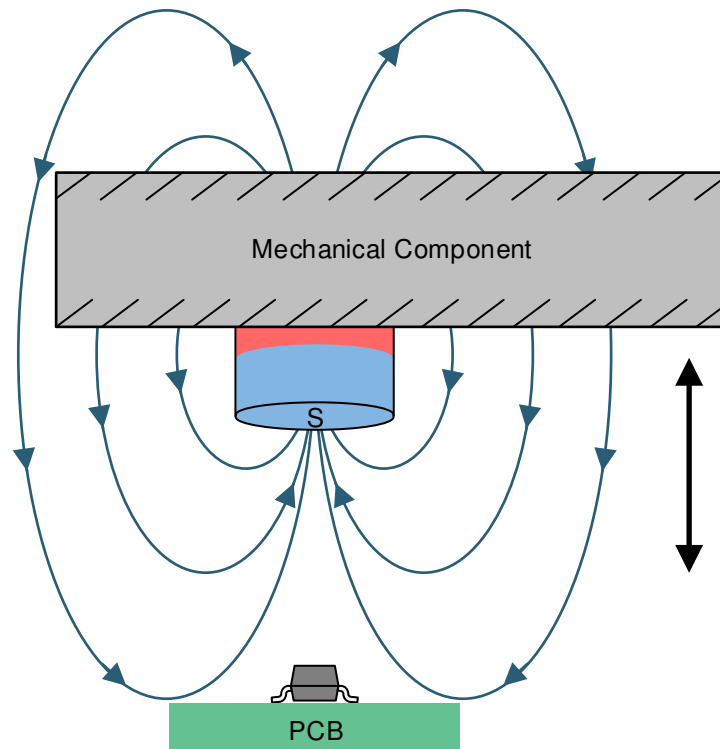
DESIGN PARAMETER	EXAMPLE VALUE
Device	DRV5057-Q1
$V_{CC}$	5 V
Magnet	Cylinder: 4.7625 mm diameter, 12.7 mm thick, Neodymium N52, $B_r = 1480$ mT
Travel distance	5 mm
Desired accuracy	< 0.1 mm

### 8.2.2.2 Detailed Design Procedure

As illustrated in 图 20, this design example consists of a mechanical component that moves back and forth, an embedded magnet with the south pole facing the printed-circuit board, and a DRV5057-Q1. The DRV5057-Q1 outputs a PWM that describes the precise position of the component. The component must not contain ferromagnetic materials such as iron, nickel, and cobalt because these materials change the magnetic flux density at the sensor.

When designing a linear magnetic sensing system, always consider these three variables: the magnet, sensing distance, and the range of the sensor. Select the DRV5057-Q1 with the highest sensitivity possible based on the system distance requirements without railing the sensor PWM output. To determine the magnetic flux density the sensor receives at the various positions of the magnet, use a magnetic field calculator or simulation software, referring to magnet specifications, and testing.



Magnets are made from various ferromagnetic materials that have tradeoffs in cost, drift with temperature, absolute maximum temperature ratings, remanence or residual induction ( $B_r$ ), and coercivity ( $H_c$ ). The  $B_r$  and the dimensions of a magnet determine the magnetic flux density ( $B$ ) produced in 3-dimensional space. For simple magnet shapes, such as rectangular blocks and cylinders, there are simple equations that solve  $B$  at a given distance centered with the magnet. 图 21 shows diagrams for 公式 4 and 公式 5.



图 21. Rectangular Block and Cylinder Magnets

Use 公式 4 for the rectangular block shown in 图 21:

$$\vec{B} = \frac{B_r}{\pi} \left( \arctan\left(\frac{WL}{2D\sqrt{4D^2 + W^2 + L^2}}\right) - \arctan\left(\frac{WL}{2(D+T)\sqrt{4(D+T)^2 + W^2 + L^2}}\right) \right) \quad (4)$$

Use 公式 5 for the cylinder illustrated in 图 21:

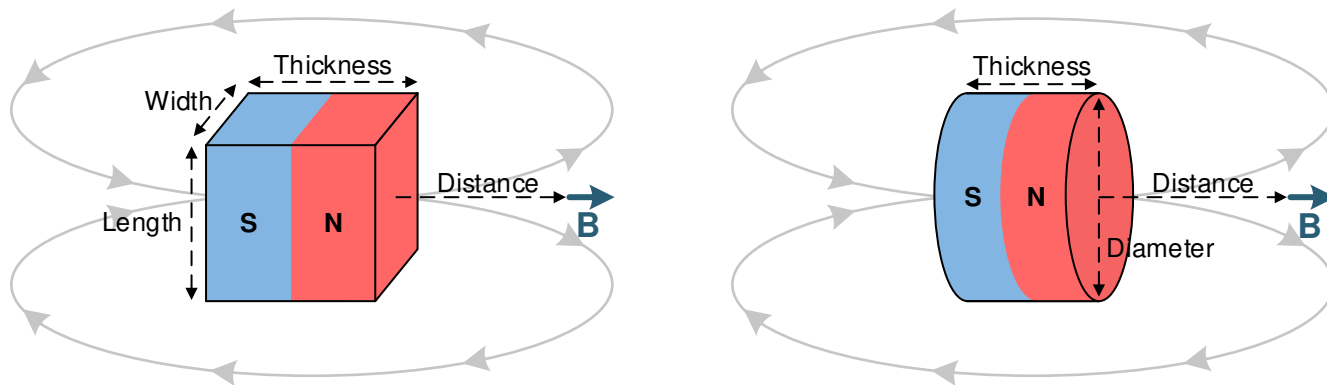
$$\vec{B} = \frac{B_r}{2} \left( \frac{D+T}{\sqrt{(0.5C)^2 + (D+T)^2}} - \frac{D}{\sqrt{(0.5C)^2 + D^2}} \right)$$

where:

- W is width
- L is length
- T is thickness (the direction of magnetization)
- D is distance
- C is diameter

(5)

This example uses a cylinder magnet; therefore, 公式 5 can be used to create a lookup table for the distances from a specific magnet based on a magnetic field strength. 图 22 shows a magnetic field from 0 mm to 16 mm with the magnet defined in 表 2 as  $C = 4.7625$  mm,  $T = 12.7$  mm, and  $B_r = 1480$  mT.



图 22. Magnetic Field vs Distance

In this setup, each gain version of the sensor produces the corresponding duty cycle shown in 图 23 for 0 mm to 16 mm.



图 23. %D vs South Pole Distance (All Gains)

With a desired 5-mm movement swing, select the DRV5057-Q1 with the largest possible sensitivity that fits the system requirements for the magnet distance to the sensor. Assume that for this example, because of mechanical restrictions, the magnet at the nearest point to the sensor must be selected to be within 5 mm to 8 mm. The largest sensitivity option (A1) does not work in this situation because the device output is railed at the farthest allowed distance of 8 mm. The A2 version is not railed at this point, and is therefore the sensor selected for this example. Choose the closest point of the magnet to the sensor to be a distance that allows the magnet to get as close to the sensor as possible without railing but stays within the selectable 5-mm to 8-mm allowed range. Because the A2 version rails at approximately 6 mm, choose a closest distance of 6.5 mm to allow for a little bit of margin. With this choice, 图 24 shows the %D response at the sensor across the full movement range.

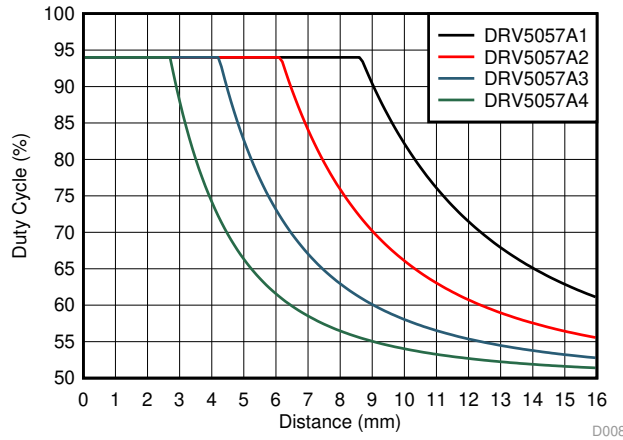

图 24. %D vs South Pole Distance (Gain A2)

The magnetic field strength is calculated using 公式 6, where a negative number represents the opposite pole (in this example a south pole is over the sensor, causing the results to be a positive number).

$$B = \frac{(\%D - 50)}{\text{Gain}} \quad (6)$$

For example, if the A2 version of the DRV5057-Q1 measured a duty cycle of %D = 74.6% using 公式 1, then the magnetic field strength present at the sensor is  $(74.6 - 50) / 1 = 24.6$  mT.

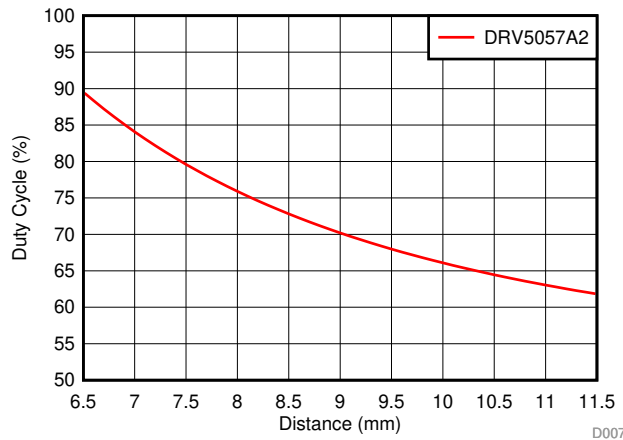
Using the lookup table that was used to create the plot in 图 22, the distance from the magnet at 24.6 mT is  $D \approx 8.2$  mm.

For more accurate results, the lookup table can be calibrated along the movement path of the magnet. Additionally, instead of using the calibrated lookup table for each measurement, consider using a best-fit polynomial equation from the curve for the desired movement range to calculate D in terms of B.

The curve in 图 24 is not linear; therefore, the achievable accuracy varies for each position along the movement path. The location with the worst accuracy is where there is the smallest change in output for a given amount of movement, which in this example is where the magnet is farthest from the sensor (at 11.5 mm). Determine if the desired accuracy is met by checking if the needed %D<sub>LSB</sub> at this location for the specified accuracy is greater than the noise level (PWM jitter) of 0.1%D. Thus, with a desired accuracy of 0.1 mm, the needed %D<sub>LSB</sub> is the change in %D between 11.4 mm and 11.5 mm. Using the lookup table to find B and then solving for %D in 公式 6, at 11.5 mm,  $B = 11.815$  mT (which equates to 61.815%D), and at 11.4 mm  $B = 12.048$  mT (which equates to 62.048%D). The difference in %D between these two points is  $62.048 - 61.815 = 0.223\%D_{LSB}$ . This value is larger than the 0.1%D jitter, so the desired accuracy can be met as long as a %D<sub>LSB</sub> is selected that is equal to or less than 0.223 using 公式 2.

### 8.3 What to Do and What Not to Do

The Hall element is sensitive to magnetic fields that are perpendicular to the top of the package. Therefore, to correctly detect the magnetic field, make sure to use the correct magnet orientation for the sensor. 图 25 shows correct and incorrect orientation.



图 25. Correct and Incorrect Magnet Orientation

## 9 Power Supply Recommendations

Use a decoupling capacitor placed close to the device to provide local energy with minimal inductance. Use a ceramic capacitor with a value of at least 0.01  $\mu\text{F}$ .

## 10 Layout

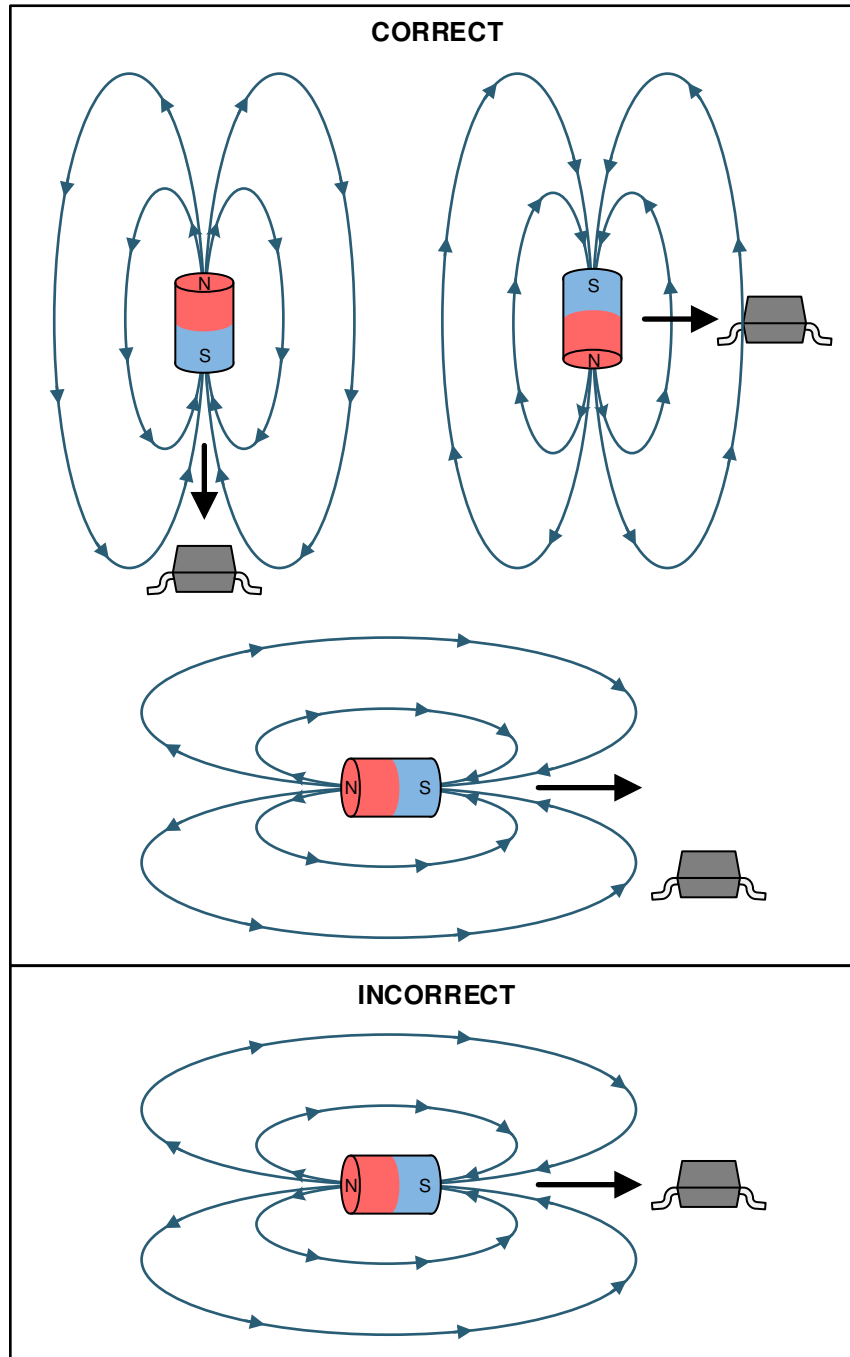
### 10.1 Layout Guidelines

Magnetic fields pass through most nonferromagnetic materials with no significant disturbance. Embedding Hall effect sensors within plastic or aluminum enclosures and sensing magnets on the outside is common practice. Magnetic fields also easily pass through most printed-circuit boards, which makes placing the magnet on the opposite side possible.

### 10.2 Layout Example



图 26. Layout Example

## 11 器件和文档支持

### 11.1 文档支持

#### 11.1.1 相关文档

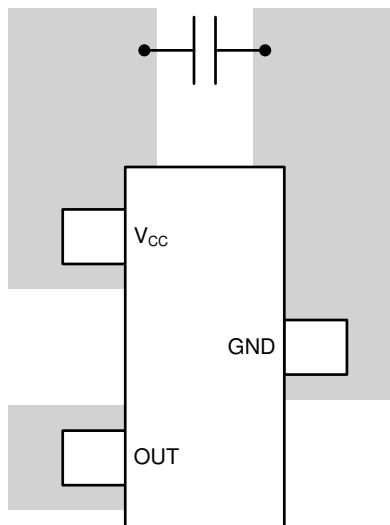
请参阅如下相关文档：

- 德州仪器 (TI), [利用线性霍尔效应传感器测量角度技术手册](#)
- 德州仪器 (TI), [增量旋转编码器设计注意事项技术手册](#)
- 德州仪器 (TI), [DRV5055 比例式线性霍尔效应传感器数据表](#)

### 11.2 接收文档更新通知

要接收文档更新通知，请导航至 [TI.com.cn](#) 上的器件产品文件夹。单击右上角的 [通知我](#) 进行注册，即可每周接收产品信息更改摘要。有关更改的详细信息，请查看任何已修订文档中包含的修订历史记录。

### 11.3 社区资源

The following links connect to TI community resources. Linked contents are provided "AS IS" by the respective contributors. They do not constitute TI specifications and do not necessarily reflect TI's views; see TI's [Terms of Use](#).

**TI E2E™ Online Community** *TI's Engineer-to-Engineer (E2E) Community*. Created to foster collaboration among engineers. At [e2e.ti.com](#), you can ask questions, share knowledge, explore ideas and help solve problems with fellow engineers.

**Design Support** *TI's Design Support* Quickly find helpful E2E forums along with design support tools and contact information for technical support.

### 11.4 商标

E2E is a trademark of Texas Instruments.

All other trademarks are the property of their respective owners.

### 11.5 静电放电警告



ESD 可能会损坏该集成电路。德州仪器 (TI) 建议通过适当的预防措施处理所有集成电路。如果不遵守正确的处理措施和安装程序，可能会损坏集成电路。

ESD 的损坏小至导致微小的性能降级，大至整个器件故障。精密的集成电路可能更容易受到损坏，这是因为非常细微的参数更改都可能会导致器件与其发布的规格不相符。

### 11.6 Glossary

[SLYZ022](#) — *TI Glossary*.

This glossary lists and explains terms, acronyms, and definitions.

## 12 机械、封装和可订购信息

以下页面包含机械、封装和可订购信息。这些信息是指定器件的最新可用数据。数据如有变更，恕不另行通知，且不会对此文档进行修订。如需获取此数据表的浏览器版本，请查阅左侧的导航栏。

## 重要声明和免责声明

TI 均以“原样”提供技术性数据（包括数据表）、设计资源（包括参考设计）、应用或其他设计建议、网络工具、安全信息和其他资源，不保证其中不含任何瑕疵，且不做任何明示或暗示的担保，包括但不限于对适销性、适合某特定用途或不侵犯任何第三方知识产权的暗示担保。

所述资源可供专业开发人员应用TI 产品进行设计使用。您将对以下行为独自承担全部责任：(1) 针对您的应用选择合适的TI 产品；(2) 设计、验证并测试您的应用；(3) 确保您的应用满足相应标准以及任何其他安全、安保或其他要求。所述资源如有变更，恕不另行通知。TI 对您使用所述资源的授权仅限于开发资源所涉及TI 产品的相关应用。除此之外不得复制或展示所述资源，也不提供其它TI 或任何第三方的知识产权授权许可。如因使用所述资源而产生任何索赔、赔偿、成本、损失及债务等，TI 对此概不负责，并且您须赔偿由此对TI 及其代表造成的损害。

TI 所提供产品均受TI 的销售条款 (<http://www.ti.com.cn/zh-cn/legal/termsofsale.html>) 以及ti.com.cn上或随附TI产品提供的其他可适用条款的约束。TI提供所述资源并不扩展或以其他方式更改TI 针对TI 产品所发布的可适用的担保范围或担保免责声明。

邮寄地址：上海市浦东新区世纪大道 1568 号中建大厦 32 楼，邮政编码：200122  
Copyright © 2020 德州仪器半导体技术（上海）有限公司

**PACKAGING INFORMATION**

Orderable Device	Status (1)	Package Type	Package Drawing	Pins	Package Qty	Eco Plan (2)	Lead finish/ Ball material (6)	MSL Peak Temp (3)	Op Temp (°C)	Device Marking (4/5)	Samples
DRV5057A1EDBZRQ1	ACTIVE	SOT-23	DBZ	3	3000	RoHS & Green	SN	Level-3-260C-168 HR	-40 to 150	57A1Z	<a href="#">Samples</a>
DRV5057A2EDBZRQ1	ACTIVE	SOT-23	DBZ	3	3000	RoHS & Green	SN	Level-3-260C-168 HR	-40 to 150	57A2Z	<a href="#">Samples</a>
DRV5057A3EDBZRQ1	ACTIVE	SOT-23	DBZ	3	3000	RoHS & Green	SN	Level-3-260C-168 HR	-40 to 150	57A3Z	<a href="#">Samples</a>
DRV5057A4EDBZRQ1	ACTIVE	SOT-23	DBZ	3	3000	RoHS & Green	SN	Level-3-260C-168 HR	-40 to 150	57A4Z	<a href="#">Samples</a>

(1) The marketing status values are defined as follows:

**ACTIVE:** Product device recommended for new designs.

**LIFEBUY:** TI has announced that the device will be discontinued, and a lifetime-buy period is in effect.

**NRND:** Not recommended for new designs. Device is in production to support existing customers, but TI does not recommend using this part in a new design.

**PREVIEW:** Device has been announced but is not in production. Samples may or may not be available.

**OBSOLETE:** TI has discontinued the production of the device.

(2) **RoHS:** TI defines "RoHS" to mean semiconductor products that are compliant with the current EU RoHS requirements for all 10 RoHS substances, including the requirement that RoHS substance do not exceed 0.1% by weight in homogeneous materials. Where designed to be soldered at high temperatures, "RoHS" products are suitable for use in specified lead-free processes. TI may reference these types of products as "Pb-Free".

**RoHS Exempt:** TI defines "RoHS Exempt" to mean products that contain lead but are compliant with EU RoHS pursuant to a specific EU RoHS exemption.

**Green:** TI defines "Green" to mean the content of Chlorine (Cl) and Bromine (Br) based flame retardants meet JS709B low halogen requirements of <=1000ppm threshold. Antimony trioxide based flame retardants must also meet the <=1000ppm threshold requirement.

(3) MSL, Peak Temp. - The Moisture Sensitivity Level rating according to the JEDEC industry standard classifications, and peak solder temperature.

(4) There may be additional marking, which relates to the logo, the lot trace code information, or the environmental category on the device.

(5) Multiple Device Markings will be inside parentheses. Only one Device Marking contained in parentheses and separated by a "-" will appear on a device. If a line is indented then it is a continuation of the previous line and the two combined represent the entire Device Marking for that device.

(6) Lead finish/Ball material - Orderable Devices may have multiple material finish options. Finish options are separated by a vertical ruled line. Lead finish/Ball material values may wrap to two lines if the finish value exceeds the maximum column width.

**Important Information and Disclaimer:**The information provided on this page represents TI's knowledge and belief as of the date that it is provided. TI bases its knowledge and belief on information provided by third parties, and makes no representation or warranty as to the accuracy of such information. Efforts are underway to better integrate information from third parties. TI has taken and



continues to take reasonable steps to provide representative and accurate information but may not have conducted destructive testing or chemical analysis on incoming materials and chemicals. TI and TI suppliers consider certain information to be proprietary, and thus CAS numbers and other limited information may not be available for release.

In no event shall TI's liability arising out of such information exceed the total purchase price of the TI part(s) at issue in this document sold by TI to Customer on an annual basis.

## TAPE AND REEL INFORMATION



### QUADRANT ASSIGNMENTS FOR PIN 1 ORIENTATION IN TAPE



\*All dimensions are nominal

Device	Package Type	Package Drawing	Pins	SPQ	Reel Diameter (mm)	Reel Width W1 (mm)	A0 (mm)	B0 (mm)	K0 (mm)	P1 (mm)	W (mm)	Pin1 Quadrant
DRV5057A1EDBZRQ1	SOT-23	DBZ	3	3000	180.0	8.4	3.15	2.77	1.22	4.0	8.0	Q3
DRV5057A2EDBZRQ1	SOT-23	DBZ	3	3000	180.0	8.4	3.15	2.77	1.22	4.0	8.0	Q3
DRV5057A3EDBZRQ1	SOT-23	DBZ	3	3000	180.0	8.4	3.15	2.77	1.22	4.0	8.0	Q3
DRV5057A4EDBZRQ1	SOT-23	DBZ	3	3000	180.0	8.4	3.15	2.77	1.22	4.0	8.0	Q3

## TAPE AND REEL BOX DIMENSIONS



\*All dimensions are nominal

Device	Package Type	Package Drawing	Pins	SPQ	Length (mm)	Width (mm)	Height (mm)
DRV5057A1EDBZRQ1	SOT-23	DBZ	3	3000	213.0	191.0	35.0
DRV5057A2EDBZRQ1	SOT-23	DBZ	3	3000	213.0	191.0	35.0
DRV5057A3EDBZRQ1	SOT-23	DBZ	3	3000	213.0	191.0	35.0
DRV5057A4EDBZRQ1	SOT-23	DBZ	3	3000	213.0	191.0	35.0

## GENERIC PACKAGE VIEW

**DBZ 3**

**SOT-23 - 1.12 mm max height**

SMALL OUTLINE TRANSISTOR



Images above are just a representation of the package family, actual package may vary.  
Refer to the product data sheet for package details.

4203227/C

DBZ0003A



# PACKAGE OUTLINE

SOT-23 - 1.12 mm max height

SMALL OUTLINE TRANSISTOR

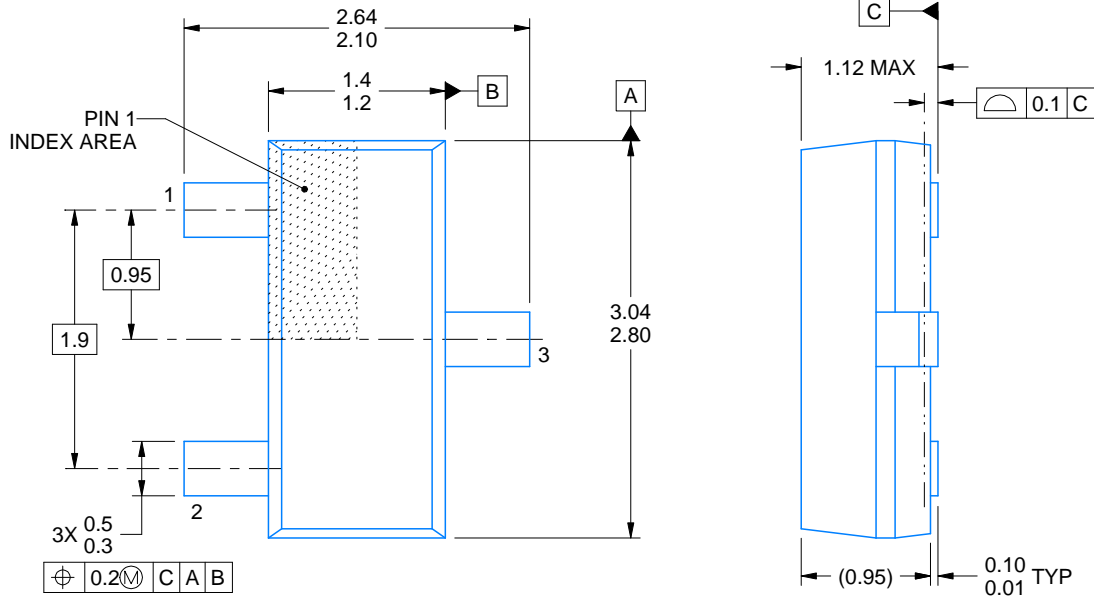

4214838/C 04/2017

NOTES:

1. All linear dimensions are in millimeters. Any dimensions in parenthesis are for reference only. Dimensioning and tolerancing per ASME Y14.5M.
2. This drawing is subject to change without notice.
3. Reference JEDEC registration TO-236, except minimum foot length.

# EXAMPLE BOARD LAYOUT

DBZ0003A

SOT-23 - 1.12 mm max height

SMALL OUTLINE TRANSISTOR

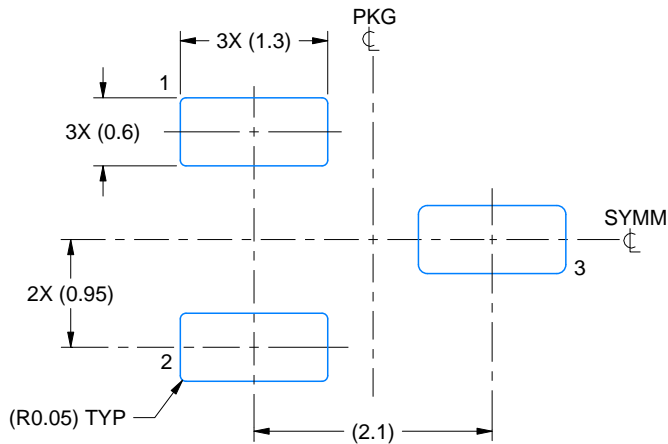

LAND PATTERN EXAMPLE  
SCALE:15X



SOLDER MASK DETAILS

4214838/C 04/2017

NOTES: (continued)

4. Publication IPC-7351 may have alternate designs.
5. Solder mask tolerances between and around signal pads can vary based on board fabrication site.

# EXAMPLE STENCIL DESIGN

DBZ0003A

SOT-23 - 1.12 mm max height

SMALL OUTLINE TRANSISTOR

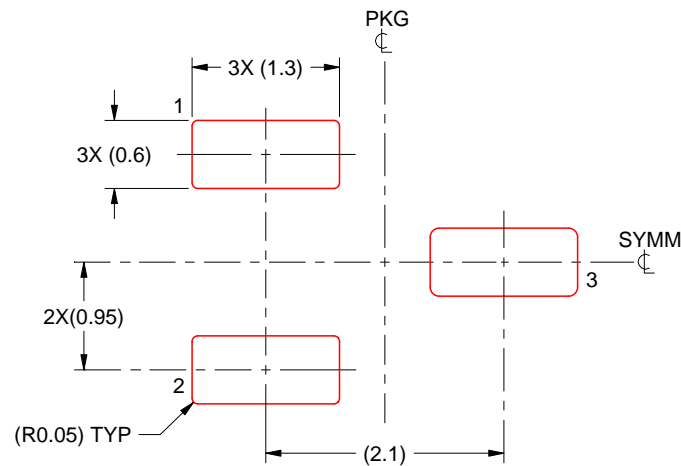

SOLDER PASTE EXAMPLE  
BASED ON 0.125 THICK STENCIL  
SCALE:15X

4214838/C 04/2017

NOTES: (continued)

6. Laser cutting apertures with trapezoidal walls and rounded corners may offer better paste release. IPC-7525 may have alternate design recommendations.
7. Board assembly site may have different recommendations for stencil design.

## 重要声明和免责声明

TI 均以“原样”提供技术性及其可靠性数据（包括数据表）、设计资源（包括参考设计）、应用或其他设计建议、网络工具、安全信息和其他资源，不保证其中不含任何瑕疵，且不做任何明示或暗示的担保，包括但不限于对适销性、适合某特定用途或不侵犯任何第三方知识产权的暗示担保。

所述资源可供专业开发人员应用TI 产品进行设计使用。您将对以下行为独自承担全部责任：(1) 针对您的应用选择合适的TI 产品；(2) 设计、验证并测试您的应用；(3) 确保您的应用满足相应标准以及任何其他安全、安保或其他要求。所述资源如有变更，恕不另行通知。TI 对您使用所述资源的授权仅限于开发资源所涉及TI 产品的相关应用。除此之外不得复制或展示所述资源，也不提供其它TI 或任何第三方的知识产权授权许可。如因使用所述资源而产生任何索赔、赔偿、成本、损失及债务等，TI 对此概不负责，并且您须赔偿由此对TI 及其代表造成的损害。

TI 所提供产品均受TI 的销售条款 (<http://www.ti.com.cn/zh-cn/legal/termsofsale.html>) 以及ti.com.cn上或随附TI产品提供的其他可适用条款的约束。TI提供所述资源并不扩展或以其他方式更改TI 针对TI 产品所发布的可适用的担保范围或担保免责声明。

邮寄地址：上海市浦东新区世纪大道 1568 号中建大厦 32 楼，邮政编码：200122

Copyright © 2020 德州仪器半导体技术（上海）有限公司