

## LM3643 具有 1.5A 高侧电流源的同步升压双 LED 闪光灯驱动器

### 1 特性

- 工作期间允许的总 LED 电流为 1.5A ( $I_{LED1} + I_{LED2} = 1.5A$ )
- 两个可独立编程的 LED 电流源
- 准确的可编程 LED 电流范围为 1.4mA 到 1.5A
- 优化了低电量条件下的闪存 LED 电流（输入电压闪存监控器 (IVFM)）
- 手电筒模式（100mA 时）和闪存模式（1A 至 1.5A 时）的效率超过 85%
- 支持阴极接地 LED 操作，改进了热管理
- 小型解决方案尺寸：< 16mm<sup>2</sup>
- 硬件选通使能 (STROBE)
- 射频功率放大器脉冲事件的同步输入 (TX)
- 硬件火炬使能 (TORCH/TEMP)
- 远程 NTC 监控 (TORCH/TEMP)
- 400kHz I<sup>2</sup>C 兼容接口
  - LM3643 (I<sup>2</sup>C 地址 = 0x63)
  - LM3643A (I<sup>2</sup>C 地址 = 0x67)

### 2 应用

可拍照手机白色 LED 闪光灯

### 3 说明

LM3643 是一款双 LED 闪存驱动器，能够以较小的解决方案尺寸提供高度可调节性。LM3643 采用 2MHz 或 4MHz 固定频率同步升压转换器为 1.5A 恒流 LED 源供电。LM3643 升压闪存驱动器可提供的总 LED 电流为 1.5A ( $I_{LED1} + I_{LED2}$ )。两个 128 级电流源可灵活调整 LED1 与 LED2 之间的电流比，每个驱动器最多能够提供 1.5A 电流（例如： $I_{LED1} = 1.5A$  和  $I_{LED2} = 0FF$ ； $I_{LED1} = 0FF$  和  $I_{LED2} = 1.5A$ ；或者电流低于 1.5A 的电流配置： $I_{LED1} = 950mA$ ， $I_{LED2} = 250mA$ ）。自适应调节方法可确保电流源保持可调节状态，并且最大限度地提升效率。

LM3643 的功能由兼容 I<sup>2</sup>C 的接口控制。这些功能包括：硬件闪光灯和硬件手电筒引脚（STROBE 和 TORCH/TEMP）、TX 中断和负温度系数 (NTC) 热敏电阻监视器。器件在每个输出引脚均提供了可独立编程的电流，以便在闪存模式或录像（手电筒）模式条件下驱动 LED。

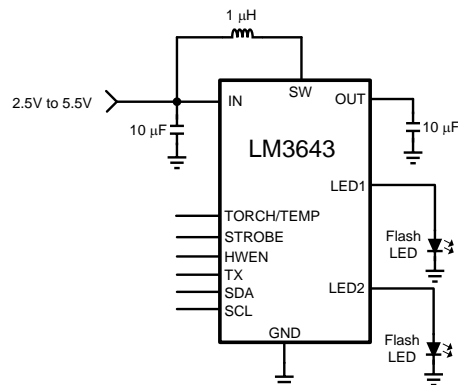
该器件的开关频率选项为 2MHz 或 4MHz，具备过压保护 (OVP) 和可调节限流功能，因此可采用微型超薄电感和 10μF 陶瓷电容。该器件的工作环境温度范围为 -40°C 至 +85°C。

#### 器件信息<sup>(1)</sup>

器件型号	封装	封装尺寸（最大值）
LM3643	芯片级球状引脚栅格阵列 (DSBGA) (12)	1.69mm x 1.31mm

(1) 要了解所有可用封装，请见数据表末尾的可订购产品附录。

#### 简化电路原理图



## 目录

<p><b>1</b> 特性 ..... 1</p> <p><b>2</b> 应用 ..... 1</p> <p><b>3</b> 说明 ..... 1</p> <p><b>4</b> 修订历史记录 ..... 2</p> <p><b>5</b> <b>Device Comparison Table</b> ..... 2</p> <p><b>6</b> <b>Pin Configuration and Functions</b> ..... 3</p> <p><b>7</b> <b>Specifications</b> ..... 4</p> <p style="padding-left: 20px;">7.1 Absolute Maximum Ratings ..... 4</p> <p style="padding-left: 20px;">7.2 ESD Ratings ..... 4</p> <p style="padding-left: 20px;">7.3 Recommended Operating Conditions ..... 4</p> <p style="padding-left: 20px;">7.4 Thermal Information ..... 4</p> <p style="padding-left: 20px;">7.5 Electrical Characteristics ..... 5</p> <p style="padding-left: 20px;">7.6 Timing Requirements ..... 6</p> <p style="padding-left: 20px;">7.7 Switching Characteristics ..... 6</p> <p style="padding-left: 20px;">7.8 Typical Characteristics ..... 6</p> <p><b>8</b> <b>Detailed Description</b> ..... 11</p> <p style="padding-left: 20px;">8.1 Overview ..... 11</p> <p style="padding-left: 20px;">8.2 Functional Block Diagram ..... 12</p>	<p style="padding-left: 20px;">8.3 Feature Description ..... 12</p> <p style="padding-left: 20px;">8.4 Device Functioning Modes ..... 14</p> <p style="padding-left: 20px;">8.5 Programming ..... 18</p> <p style="padding-left: 20px;">8.6 Register Descriptions ..... 20</p> <p><b>9</b> <b>Applications and Implementation</b> ..... 24</p> <p style="padding-left: 20px;">9.1 Application Information ..... 24</p> <p style="padding-left: 20px;">9.2 Typical Application ..... 24</p> <p><b>10</b> <b>Power Supply Recommendations</b> ..... 30</p> <p><b>11</b> <b>Layout</b> ..... 30</p> <p style="padding-left: 20px;">11.1 Layout Guidelines ..... 30</p> <p style="padding-left: 20px;">11.2 Layout Example ..... 31</p> <p><b>12</b> <b>器件和文档支持</b> ..... 32</p> <p style="padding-left: 20px;">12.1 器件支持 ..... 32</p> <p style="padding-left: 20px;">12.2 相关文档 ..... 32</p> <p style="padding-left: 20px;">12.3 商标 ..... 32</p> <p style="padding-left: 20px;">12.4 静电放电警告 ..... 32</p> <p style="padding-left: 20px;">12.5 术语表 ..... 32</p> <p><b>13</b> <b>机械、封装和可订购信息</b> ..... 32</p>
---	--

## 4 修订历史记录

### Changes from Original (August 2014) to Revision A

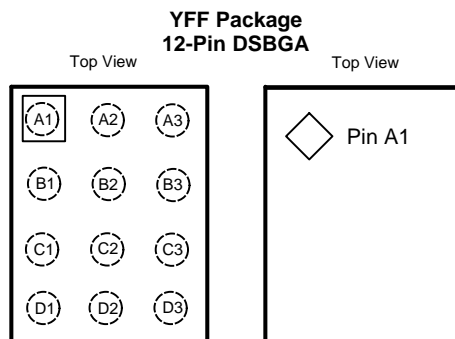
Page

• 已添加 有关 LM3643A 的信息 .....	1
• Changed '011' to '000' - typo .....	23

## 5 Device Comparison Table

ORDERING PART NUMBER	I <sup>2</sup> C ADDRESS
LM3643YFFR	0x63
LM3643AYFFR	0x67

## 6 Pin Configuration and Functions



### Pin Functions

PIN		DESCRIPTION
NUMBER	NAME	
A1	GND	Input voltage connection. Connect IN to the input supply and bypass to GND with a 10- $\mu$ F or larger ceramic capacitor.
A2	IN	Serial data input/output in the I <sup>2</sup> C Mode on LM3643.
A3	SDA	Drain Connection for Internal NMOS and Synchronous PMOS Switches.
B1	SW	Active high hardware flash enable. Drive STROBE high to turn on Flash pulse. Internal pulldown resistor of 300 k $\Omega$ between STROBE and GND.
B2	STROBE	Serial clock input for LM3643.
B3	SCL	Step-up DC-DC converter output. Connect a 10- $\mu$ F ceramic capacitor between this terminal and GND.
C1	OUT	Active high enable pin. High = Standby, Low = Shutdown/Reset. Internal pulldown resistor of 300 k $\Omega$ between HWEN and GND.
C2	HWEN	Torch terminal input or threshold detector for NTC temperature sensing and current scale back.
C3	TORCH/TE MP	High-side current source output for flash LED.
D1	LED2	Configurable dual polarity power amplifier synchronization input. Internal pulldown resistor of 300 k $\Omega$ between TX and GND.
D2	TX	High-side current source output for flash LED.
D3	LED1	

## 7 Specifications

### 7.1 Absolute Maximum Ratings

over operating free-air temperature range (unless otherwise noted)<sup>(1)(2)</sup>

	MIN	MAX	UNIT
IN, SW, OUT, LED1, LED2	-0.3	6	V
SDA, SCL, TX, TORCH/TEMP, HWEN, STROBE	-0.3 to the lesser of (V <sub>IN</sub> +0.3) w/ 6 V max		V
Continuous power dissipation <sup>(3)</sup>	Internally limited		
Junction temperature (T <sub>J-MAX</sub> )		150	°C
Maximum lead temperature (soldering)	See <sup>(4)</sup>		
Storage temperature, T <sub>stg</sub>	-65	150	°C

- (1) Stresses beyond those listed under *Absolute Maximum Ratings* may cause permanent damage to the device. These are stress ratings only, which do not imply functional operation of the device at these or any other conditions beyond those indicated under *Recommended Operating Conditions*. Exposure to absolute-maximum-rated conditions for extended periods may affect device reliability.
- (2) All voltages are with respect to the potential at the GND terminal.
- (3) Internal thermal shutdown circuitry protects the device from permanent damage. Thermal shutdown engages at T<sub>J</sub> = 150°C (typical) and disengages at T<sub>J</sub> = 135°C (typical). Thermal shutdown is ensured by design.
- (4) For detailed soldering specifications and information, please refer to TI Application Note *DSBGA Wafer Level Chip Scale Package (SNVA009)*.

### 7.2 ESD Ratings

		VALUE	UNIT
V <sub>(ESD)</sub>	Electrostatic discharge	Human-body model (HBM), per ANSI/ESDA/JEDEC JS-001 <sup>(1)</sup>	±2500
		Charged-device model (CDM), per JEDEC specification JESD22-C101 <sup>(2)</sup>	±1500

- (1) JEDEC document JEP155 states that 500-V HBM allows safe manufacturing with a standard ESD control process.
- (2) JEDEC document JEP157 states that 250-V CDM allows safe manufacturing with a standard ESD control process.

### 7.3 Recommended Operating Conditions

over operating free-air temperature range (unless otherwise noted)<sup>(1)(2)</sup>

	MIN	MAX	UNIT
V <sub>IN</sub>	2.5	5.5	V
Junction temperature (T <sub>J</sub> )	-40	125	°C
Ambient temperature (T <sub>A</sub> ) <sup>(3)</sup>	-40	85	

- (1) Stresses beyond those listed under *absolute maximum ratings* may cause permanent damage to the device. These are stress ratings only, and functional operation of the device at these or any other conditions beyond those indicated under *recommended operating conditions* is not implied. Exposure to absolute-maximum-rated conditions for extended periods may affect device reliability.
- (2) All voltages are with respect to the potential at the GND terminal.
- (3) In applications where high power dissipation and/or poor package thermal resistance is present, the maximum ambient temperature may have to be derated. Maximum ambient temperature (T<sub>A-MAX</sub>) is dependent on the maximum operating junction temperature (T<sub>J-MAX-OP</sub> = 125°C), the maximum power dissipation of the device in the application (P<sub>D-MAX</sub>), and the junction-to-ambient thermal resistance of the part/package in the application (R<sub>θJA</sub>), as given by the following equation: T<sub>A-MAX</sub> = T<sub>J-MAX-OP</sub> - (R<sub>θJA</sub> × P<sub>D-MAX</sub>).

### 7.4 Thermal Information

THERMAL METRIC <sup>(1)</sup>		LM3643 DSBGA 12 PINS	UNIT
R <sub>θJA</sub>	Junction-to-ambient thermal resistance	90.2	°C/W
R <sub>θJC(top)</sub>	Junction-to-case (top) thermal resistance	0.5	
R <sub>θJB</sub>	Junction-to-board thermal resistance	40.0	
Ψ <sub>JT</sub>	Junction-to-top characterization parameter	3.0	
Ψ <sub>JB</sub>	Junction-to-board characterization parameter	39.2	

- (1) For more information about traditional and new thermal metrics, see the *IC Package Thermal Metrics* application report, [SPRA953](http://www.ti.com/lit/an/spra953).

## 7.5 Electrical Characteristics

Typical limits tested at  $T_A = 25^\circ\text{C}$ . Minimum and maximum limits apply over the full operating ambient temperature range ( $-40^\circ\text{C} \leq T_A \leq 85^\circ\text{C}$ ). Unless otherwise specified,  $V_{IN} = 3.6\text{ V}$ ,  $\text{HWEN} = V_{IN}$ .<sup>(1)(2)</sup>

PARAMETER		TEST CONDITIONS		MIN	TYP	MAX	UNIT
<b>CURRENT SOURCE SPECIFICATIONS</b>							
$I_{LED1/2}$	Current source accuracy	$V_{OUT} = 4\text{ V}$ , flash code = 0x7F = 1.5 A flash		-7%	1.5	7%	A
		$V_{OUT} = 4\text{ V}$ , torch code = 0x3F = 89.3 mA torch or		-10%	89.3	10%	mA
$V_{HR}$	LED1 and LED2 current source regulation voltage	$I_{LED1/2} = 729\text{ mA}$	Flash	290		mV	
		$I_{LED1/2} = 179\text{ mA}$	Torch	158			
$V_{OVP}$		ON threshold		4.86	5	5.1	V
		OFF threshold		4.75	4.88	4.99	
<b>STEP-UP DC/DC CONVERTER SPECIFICATIONS</b>							
$R_{PMOS}$	PMOS switch on-resistance			86		mΩ	
$R_{NMOS}$	NMOS switch on-resistance			65		mΩ	
$I_{CL}$	Switch current limit	Reg 0x07, bit[0] = 0		-12%	1.9	12%	A
		Reg 0x07, bit[0] = 1		-12%	2.8	12%	
$UVLO$	Undervoltage lockout threshold	Falling $V_{IN}$		-2%	2.5	2%	V
$V_{TRIP}$	NTC comparator trip threshold	Reg 0x09, bits[3:1] = '100'		-5%	0.6	5%	V
$I_{NTC}$	NTC current			-6%	50	6%	μA
$V_{IVFM}$	Input voltage flash monitor trip threshold	Reg 0x02, bits[5:3] = '000'		-3%	2.9	3%	V
$I_Q$	Quiescent supply current	Device not switching pass mode		0.3		0.75	mA
$I_{SD}$	Shutdown supply current	Device disabled, $\text{HWEN} = 0\text{ V}$ $2.5\text{ V} \leq V_{IN} \leq 5.5\text{ V}$		0.1		4	μA
$I_{SB}$	Standby supply current	Device disabled, $\text{HWEN} = 1.8\text{ V}$ $2.5\text{ V} \leq V_{IN} \leq 5.5\text{ V}$		2.5		10	μA
<b>HWEN, TORCH/TEMP, STROBE, TX VOLTAGE SPECIFICATIONS</b>							
$V_{IL}$	Input logic low	$2.5\text{ V} \leq V_{IN} \leq 5.5\text{ V}$		0	0.4		V
$V_{IH}$	Input logic high			1.2	$V_{IN}$		V
<b>I<sup>2</sup>C-COMPATIBLE INTERFACE SPECIFICATIONS (SCL, SDA)</b>							
$V_{IL}$	Input logic low	$2.5\text{ V} \leq V_{IN} \leq 4.2\text{ V}$		0	0.4		V
$V_{IH}$	Input logic high			1.2	$V_{IN}$		V
$V_{OL}$	Output logic low	$I_{LOAD} = 3\text{ mA}$		400		mV	

- (1) Minimum (Min) and Maximum (Max) limits are specified by design, test, or statistical analysis. Typical (typ.) numbers are not verified, but do represent the most likely norm. Unless otherwise specified, conditions for typical specifications are:  $V_{IN} = 3.6\text{ V}$  and  $T_A = 25^\circ\text{C}$ .
- (2) All voltages are with respect to the potential at the GND pin.

### 7.6 Timing Requirements

		MIN	NOM	MAX	UNIT
$t_1$	SCL clock period	2.4			$\mu\text{s}$
$t_2$	Data in set-up time to SCL high	100			ns
$t_3$	Data out stable After SCL low	0			ns
$t_4$	SDA low set-up time to SCL Low (start)	100			ns
$t_5$	SDA high hold time after SCL high (stop)	100			ns

### 7.7 Switching Characteristics

over operating free-air temperature range (unless otherwise noted)

PARAMETER	TEST CONDITIONS	MIN	TYP	MAX	UNIT
$f_{\text{sw}}$	Switching frequency	$2.5\text{ V} \leq V_{\text{IN}} \leq 5.5\text{ V}$	4	6%	MHz

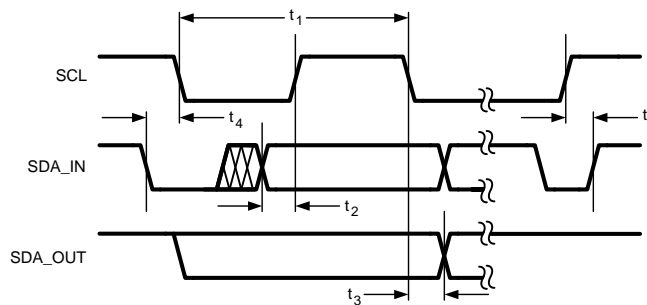


Figure 1. I<sup>2</sup>C-Compatible Interface Specifications

### 7.8 Typical Characteristics

Ambient temperature is 25°C, input voltage is 3.6 V, HWEN =  $V_{\text{IN}}$ ,  $C_{\text{IN}} = C_{\text{OUT}} = 2 \times 10\ \mu\text{F}$  and  $L = 1\ \mu\text{H}$ , unless otherwise noted .

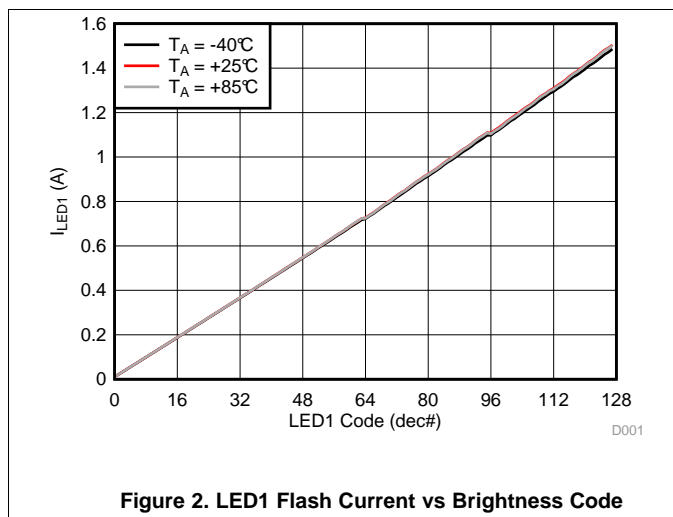


Figure 2. LED1 Flash Current vs Brightness Code

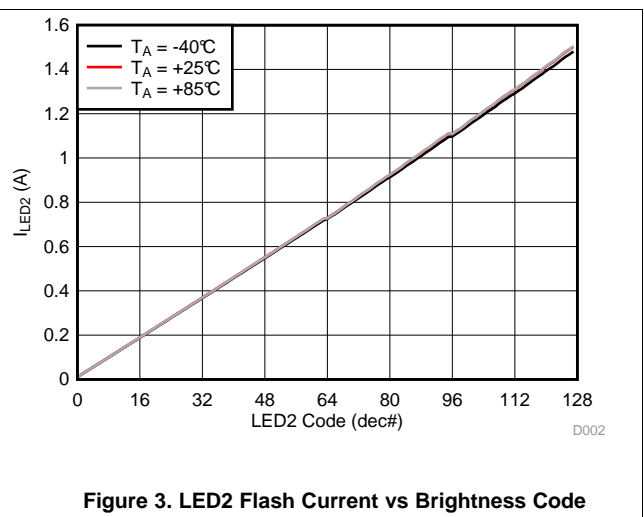


Figure 3. LED2 Flash Current vs Brightness Code

Typical Characteristics (continued)

Ambient temperature is 25°C, input voltage is 3.6 V, HWEN = V<sub>IN</sub>, C<sub>IN</sub> = C<sub>OUT</sub> = 2 × 10 μF and L = 1 μH, unless otherwise noted .

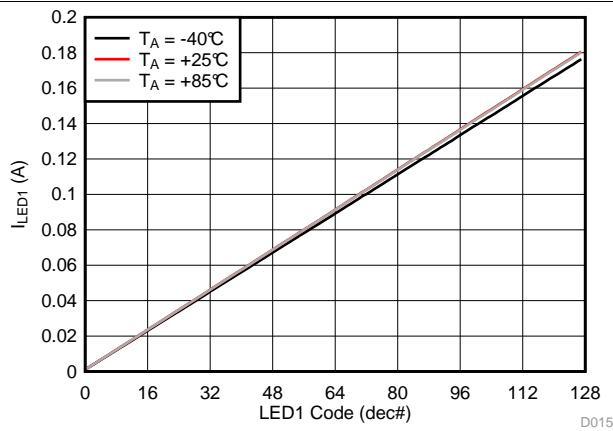


Figure 4. LED1 Torch Current vs Brightness Code

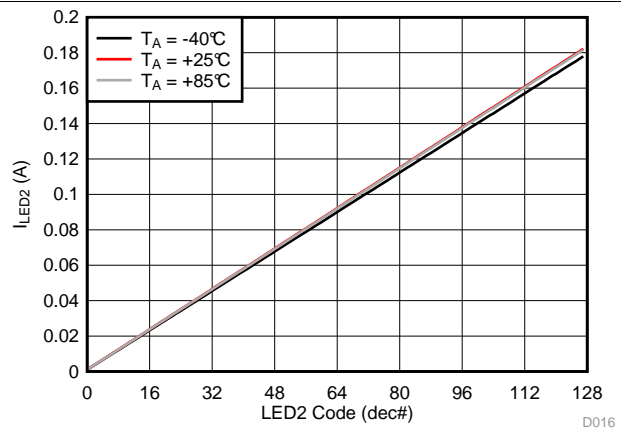


Figure 5. LED2 Torch Current vs Brightness Code

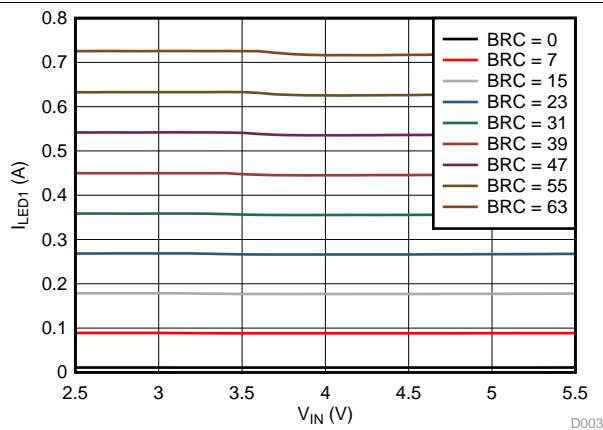


Figure 6. LED1 Current vs Input Voltage

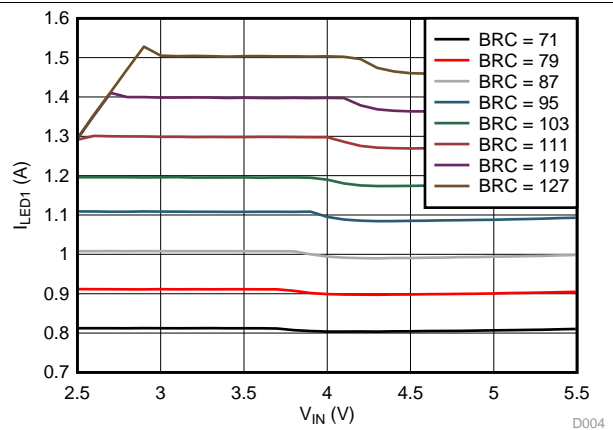


Figure 7. LED1 Current vs Input Voltage

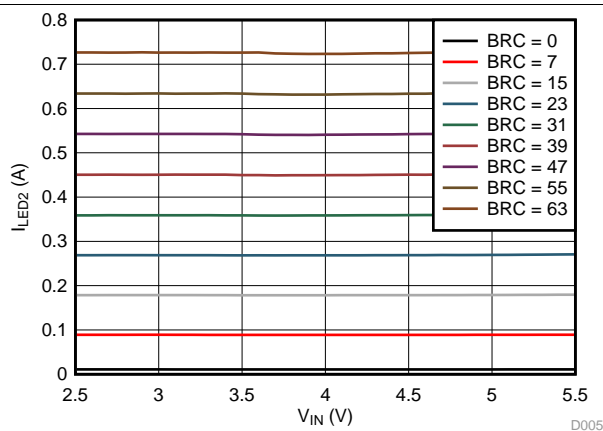


Figure 8. LED2 Current vs Input Voltage

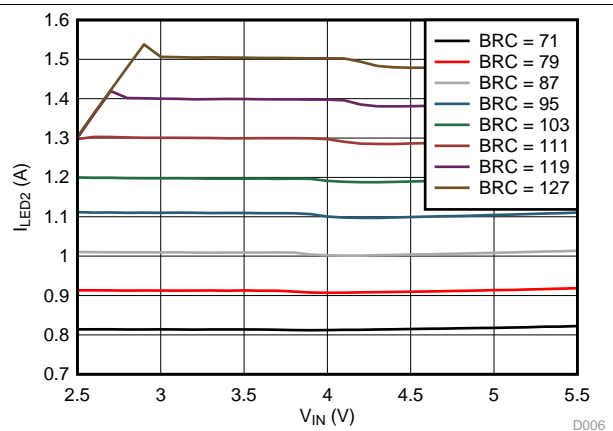


Figure 9. LED2 Current vs Input Voltage

### Typical Characteristics (continued)

Ambient temperature is 25°C, input voltage is 3.6 V, HWEN = V<sub>IN</sub>, C<sub>IN</sub> = C<sub>OUT</sub> = 2 × 10 μF and L = 1 μH, unless otherwise noted.

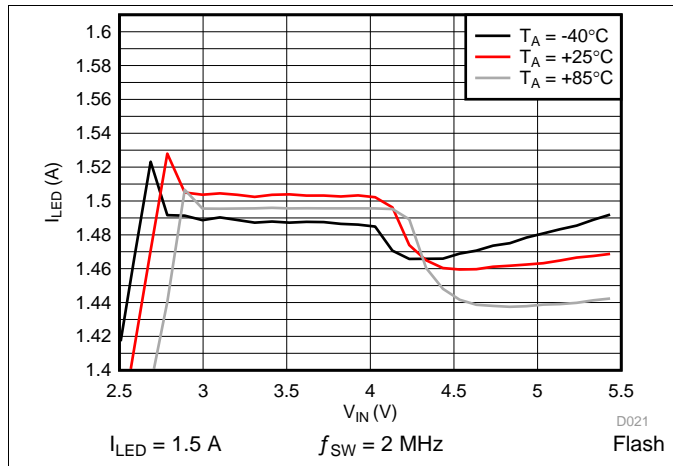


Figure 10. LED1/2 Current vs Input Voltage

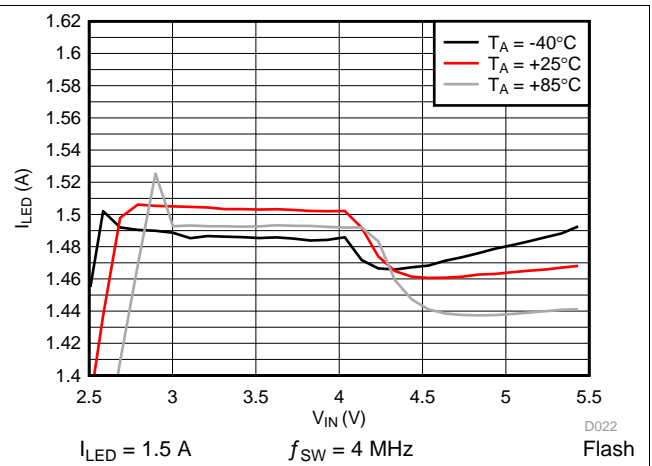


Figure 11. LED1/2 Current vs Input Voltage

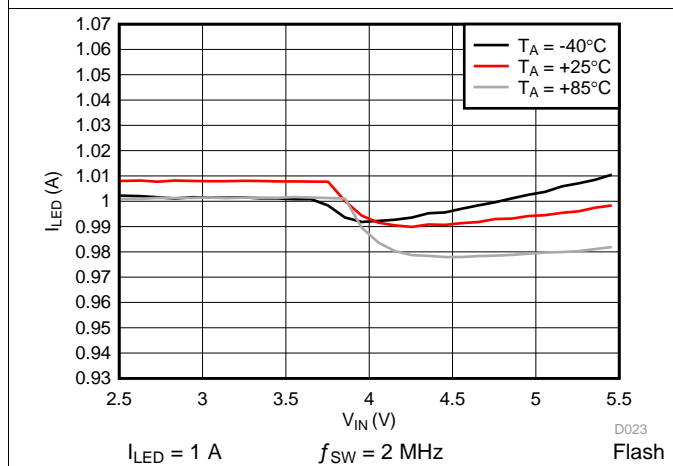


Figure 12. LED1/2 Current vs Input Voltage

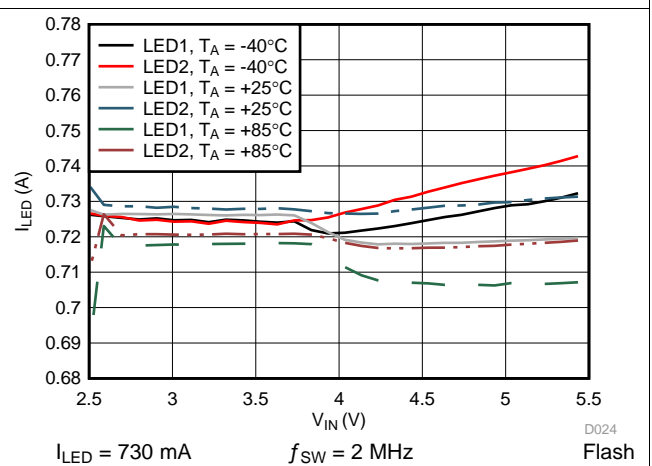


Figure 13. LED1 and LED2 Current vs Input Voltage

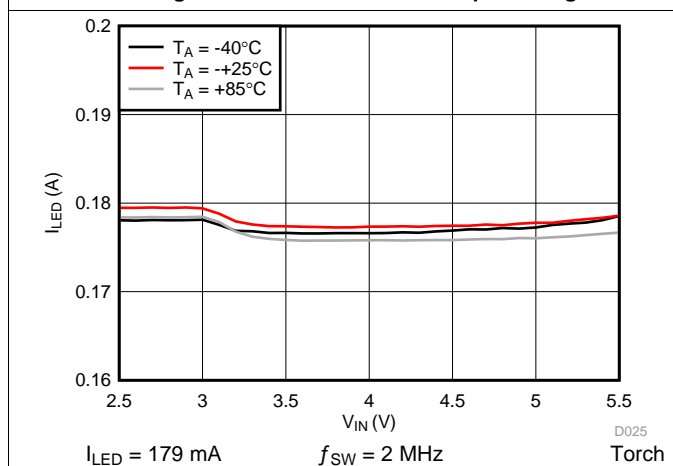


Figure 14. LED Current vs Input Voltage

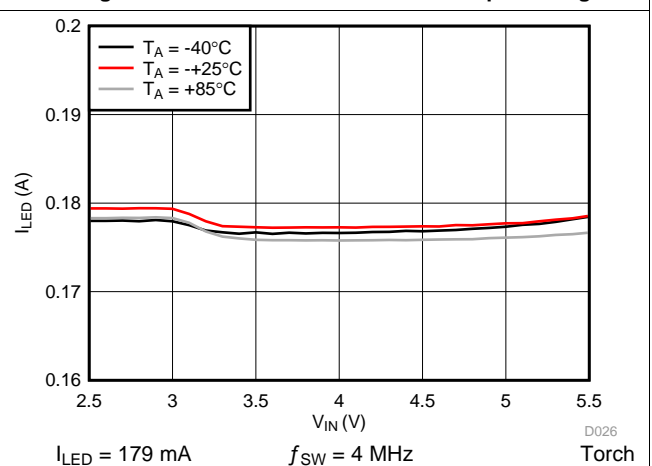


Figure 15. LED Current vs Input Voltage



Typical Characteristics (continued)

Ambient temperature is 25°C, input voltage is 3.6 V, HWEN = V<sub>IN</sub>, C<sub>IN</sub> = C<sub>OUT</sub> = 2 × 10 μF and L = 1 μH, unless otherwise noted .

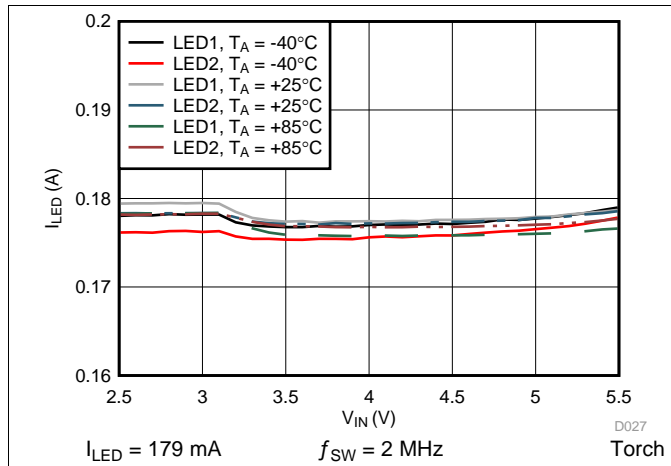


Figure 16. LED1 and LED2 Current vs Input Voltage

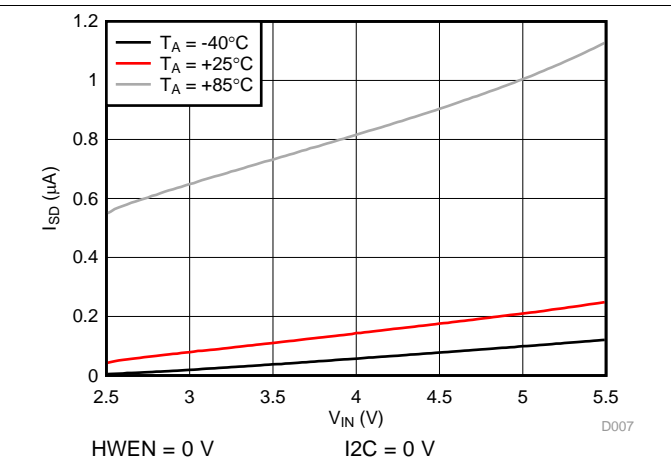


Figure 17. Shutdown Current vs Input Voltage

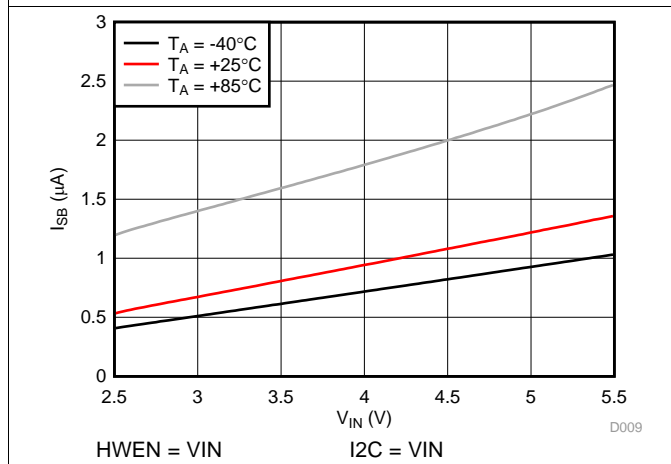


Figure 18. Standby Current vs Input Voltage

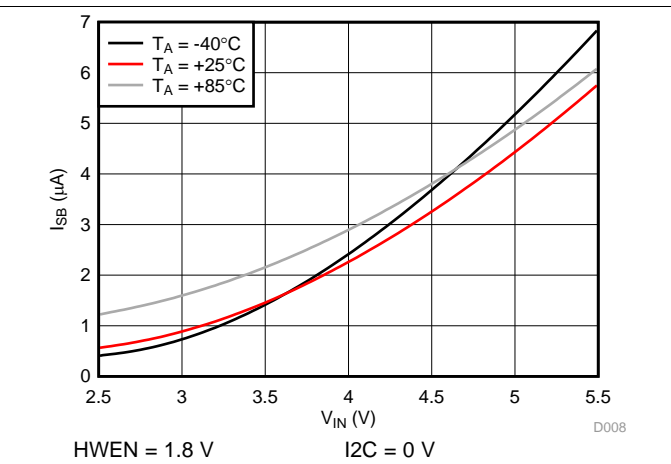


Figure 19. Standby Current vs Input Voltage

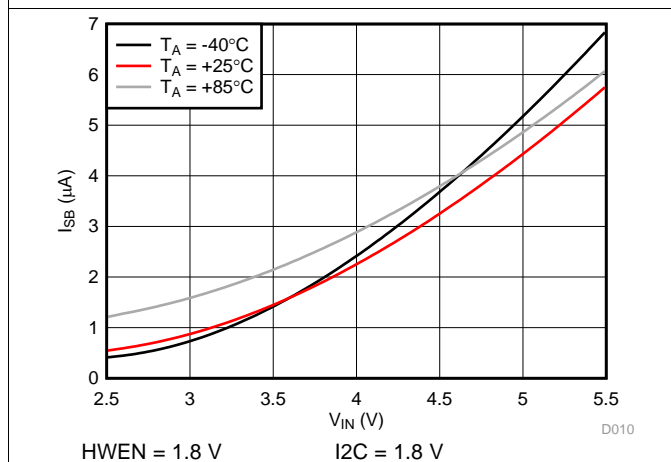


Figure 20. Standby Current vs Input Voltage

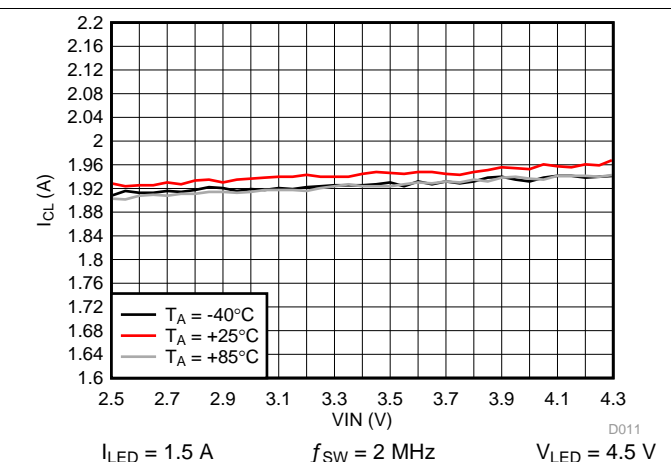


Figure 21. Inductor Current Limit vs Input Voltage

### Typical Characteristics (continued)

Ambient temperature is 25°C, input voltage is 3.6 V, HWEN = V<sub>IN</sub>, C<sub>IN</sub> = C<sub>OUT</sub> = 2 × 10 μF and L = 1 μH, unless otherwise noted .

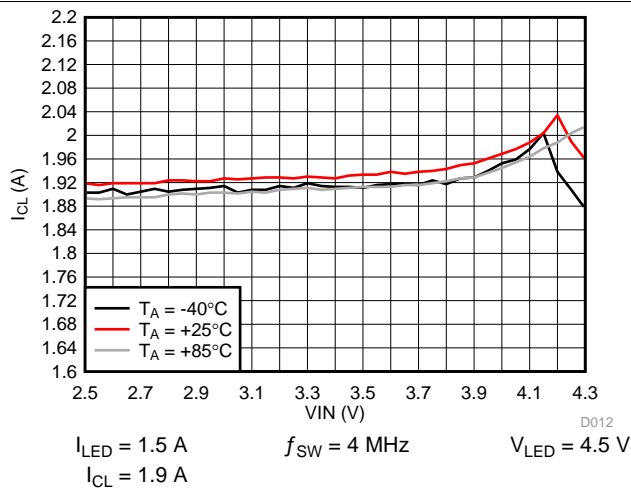


Figure 22. Inductor Current Limit vs Input Voltage

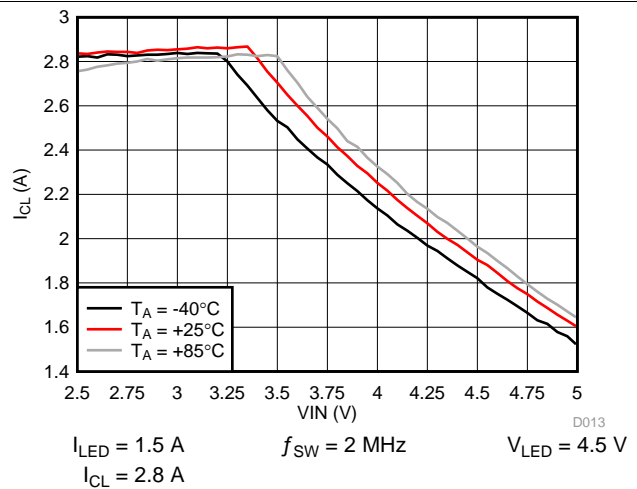


Figure 23. Inductor Current Limit vs Input Voltage

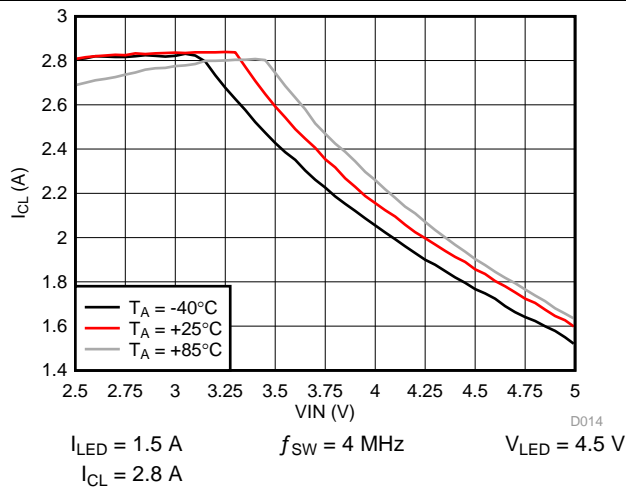


Figure 24. Inductor Current Limit vs Input Voltage

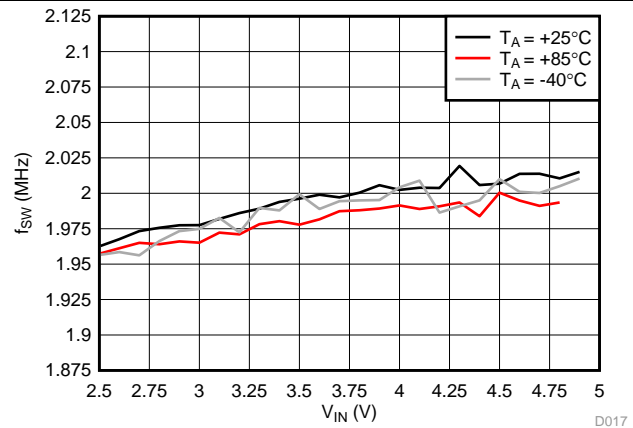


Figure 25. 2-MHz Switching Frequency vs Input Voltage

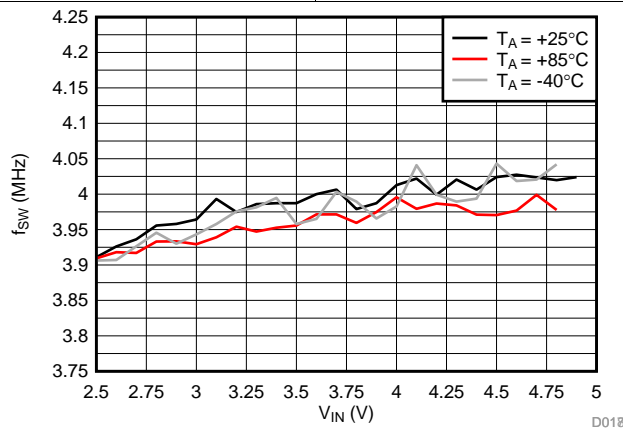


Figure 26. 4-MHz Switching Frequency vs Input Voltage

## 8 Detailed Description

### 8.1 Overview

The LM3643 is a high-power white LED flash driver capable of delivering up to 1.5 A in either of the two parallel LEDs. The total allowed LED current during operation of the LM3643 ( $I_{LED1} + I_{LED2}$ ) is 1.5 A. The device incorporates a 2-MHz or 4-MHz constant frequency-synchronous current-mode PWM boost converter and dual high-side current sources to regulate the LED current over the 2.5-V to 5.5-V input voltage range.

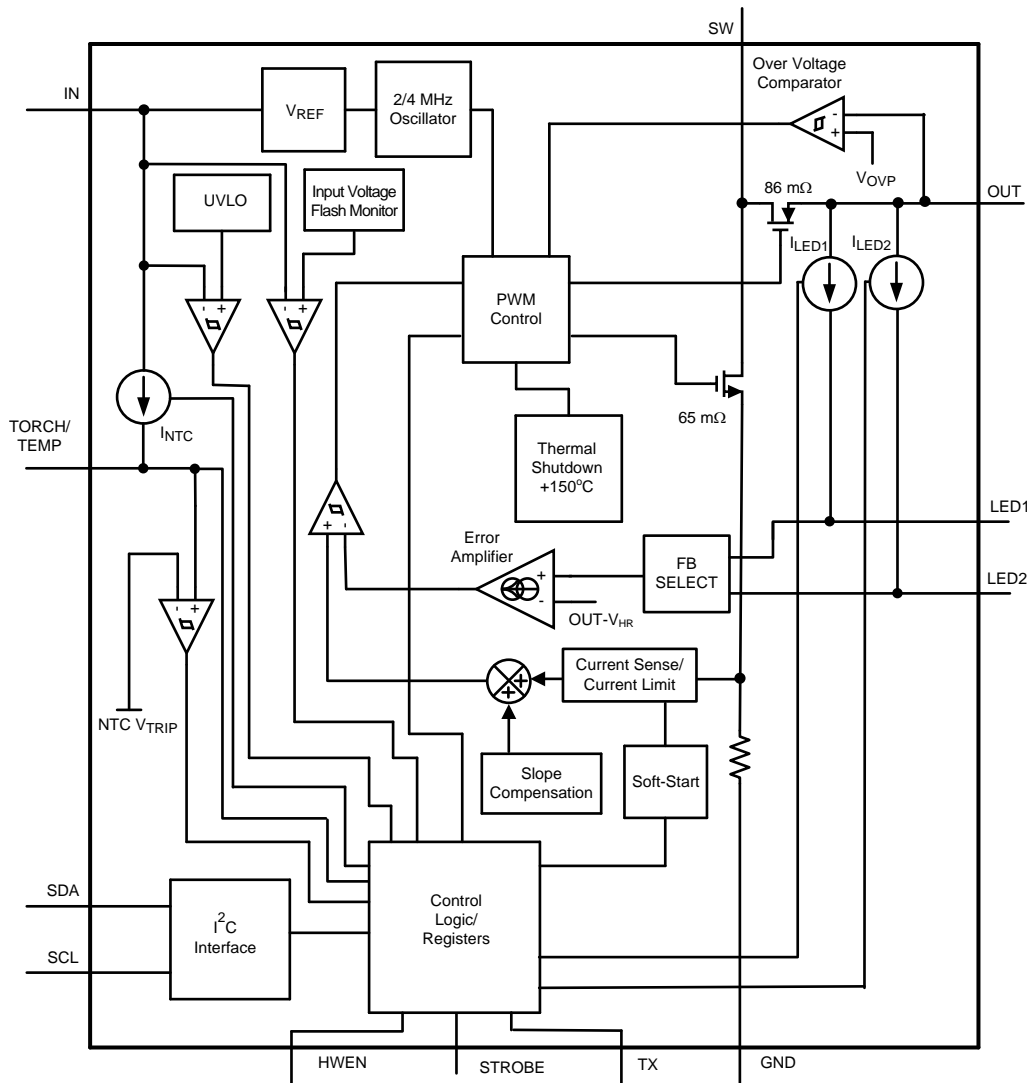
The LM3643 PWM DC-DC boost converter switches and boosts the output to maintain at least  $V_{HR}$  across each of the current sources (LED1/2). This minimum headroom voltage ensures that both current sources remain in regulation. If the input voltage is above the LED voltage + current source headroom voltage the device does not switch, but turns the PFET on continuously (Pass mode). In Pass mode the difference between ( $V_{IN} - I_{LED} \times R_{PMOS}$ ) and the voltage across the LED is dropped across the current source.

The LM3643 has three logic inputs including a hardware Flash Enable (STROBE), a hardware Torch Enable (TORCH/TEMP, TORCH = default), and a Flash Interrupt input (TX) designed to interrupt the flash pulse during high battery-current conditions. These logic inputs have internal 300-k $\Omega$  (typical) pulldown resistors to GND.

Additional features of the LM3643 include an internal comparator for LED thermal sensing via an external NTC thermistor and an input voltage monitor that can reduce the Flash current during low  $V_{IN}$  conditions. It also has a Hardware Enable (HWEN) pin that can be used to reset the state of the device and the registers by pulling the HWEN pin to ground.

Control is done via an I<sup>2</sup>C-compatible interface. This includes adjustment of the Flash and Torch current levels, changing the Flash Timeout Duration, and changing the switch current limit. Additionally, there are flag and status bits that indicate flash current time-out, LED overtemperature condition, LED failure (open/short), device thermal shutdown, TX interrupt, and  $V_{IN}$  undervoltage conditions.

## 8.2 Functional Block Diagram



## 8.3 Feature Description

### 8.3.1 Flash Mode

In Flash Mode, the LED current sources (LED1/2) provide 128 target current levels from 10.9 mA to 1500 mA. **The total allowed LED current during operation is 1.5 A ( $I_{LED1} + I_{LED2} = 1.5 \text{ A}$ ).** Once the Flash sequence is activated the current source (LED) ramps up to the programmed Flash current by stepping through all current steps until the programmed current is reached. The headroom in the two current sources can be regulated to provide 10.9 mA to 1.5 A on each of the two output legs. There is an option in the register settings to keep the two currents in the output leg the same.

When the device is enabled in Flash Mode through the Enable Register, all mode bits in the Enable Register are cleared after a flash time-out event.

## Feature Description (continued)

### 8.3.2 Torch Mode

In Torch mode, the LED current sources (LED1/2) provide 128 target current levels from 0.977 mA to 179 mA . The Torch currents are adjusted via the LED1 and LED2 LED Torch Brightness Registers. Torch mode is activated by the Enable Register (setting M1, M0 to '10'), or by pulling the TORCH/TEMP pin HIGH when the pin is enabled (Enable Register) and set to Torch Mode. Once the TORCH sequence is activated the active current sources (LED1/2) ramps up to the programmed Torch current by stepping through all current steps until the programmed current is reached. The rate at which the current ramps is determined by the value chosen in the Timing Register.

Torch Mode is not affected by Flash Timeout or by a TX Interrupt event.

### 8.3.3 IR Mode

In IR Mode, the target LED current is equal to the value stored in the LED1/2 Flash Brightness Registers. When IR mode is enabled (setting M1, M0 to '01'), the boost converter turns on and set the output equal to the input (pass-mode). At this point, toggling the STROBE pin enables and disables the LED1/2 current sources (if enabled). The strobe pin can only be set to be Level sensitive, meaning all timing of the IR pulse is externally controlled. In IR Mode, the current sources do not ramp the LED outputs to the target. The current transitions immediately from off to on and then on to off.

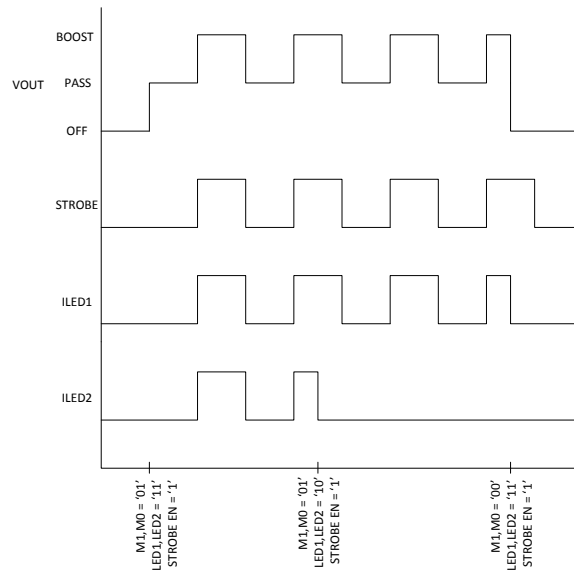
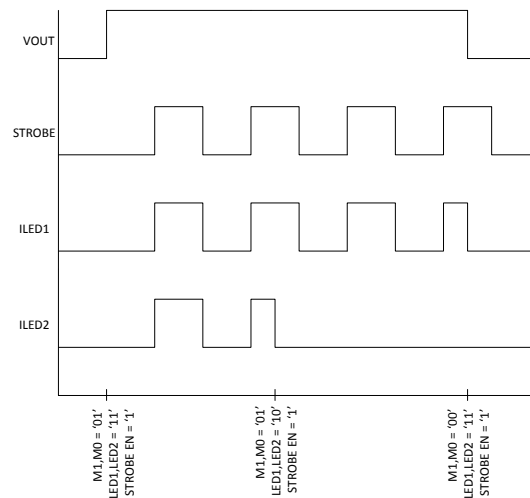
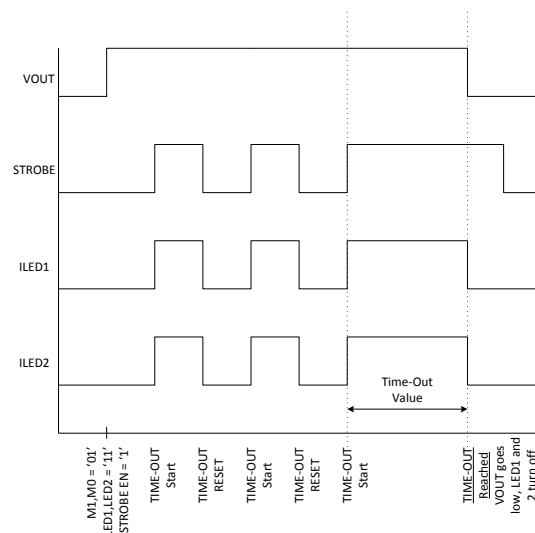


Figure 27. IR Mode with Boost

**Feature Description (continued)**

**Figure 28. IR Mode Pass Only**

**Figure 29. IR Mode Timeout**
**8.4 Device Functioning Modes**
**8.4.1 Start-Up (Enabling The Device)**

Turn on of the LM3643 Torch and Flash modes can be done through the Enable Register. On start-up, when  $V_{OUT}$  is less than  $V_{IN}$  the internal synchronous PFET turns on as a current source and delivers 200 mA (typical) to the output capacitor. During this time the current source (LED) is off. When the voltage across the output capacitor reaches 2.2 V (typical) the current source turns on. At turnon the current source steps through each FLASH or TORCH level until the target LED current is reached. This gives the device a controlled turnon and limits inrush current from the  $V_{IN}$  supply.

## Device Functioning Modes (continued)

### 8.4.2 Pass Mode

The LM3643 starts up in Pass Mode and stays there until Boost Mode is needed to maintain regulation. If the voltage difference between  $V_{OUT}$  and  $V_{LED}$  falls below  $V_{HR}$ , the device switches to Boost Mode. In Pass Mode the boost converter does not switch, and the synchronous PFET turns fully on bringing  $V_{OUT}$  up to  $V_{IN} - I_{LED} \times R_{PMOS}$ . In Pass Mode the inductor current is not limited by the peak current limit.

### 8.4.3 Power Amplifier Synchronization (TX)

The TX pin is a Power Amplifier Synchronization input. This is designed to reduce the flash LED current and thus limit the battery current during high battery current conditions such as PA transmit events. When the LM3643 is engaged in a Flash event, and the TX pin is pulled high, the LED current is forced into Torch Mode at the programmed Torch current setting. If the TX pin is then pulled low before the Flash pulse terminates, the LED current returns to the previous Flash current level. At the end of the Flash time-out, whether the TX pin is high or low, the LED current turns off.

### 8.4.4 Input Voltage Flash Monitor (IVFM)

The LM3643 has the ability to adjust the flash current based upon the voltage level present at the IN pin utilizing the Input Voltage Flash Monitor (IVFM). The adjustable threshold IVFM-D ranges from 2.9 V to 3.6 V in 100-mV steps, with three different usage modes (Stop and Hold, Adjust Down Only, Adjust Up and Down). The Flags2 Register has the IVFM flag bit set when the input voltage crosses the IVFM-D value. Additionally, the IVFM-D threshold sets the input voltage boundary that forces the LM3643 to either stop ramping the flash current during start-up (Stop and Hold Mode) or to start decreasing the LED current during the flash (Down Adjust Only and Up and Down Adjust). In Adjust Up and Down mode, the IVFM-D value plus the hysteresis voltage threshold set the input voltage boundary that forces the LM3643 to start ramping the flash current back up towards the target.

Device Functioning Modes (continued)

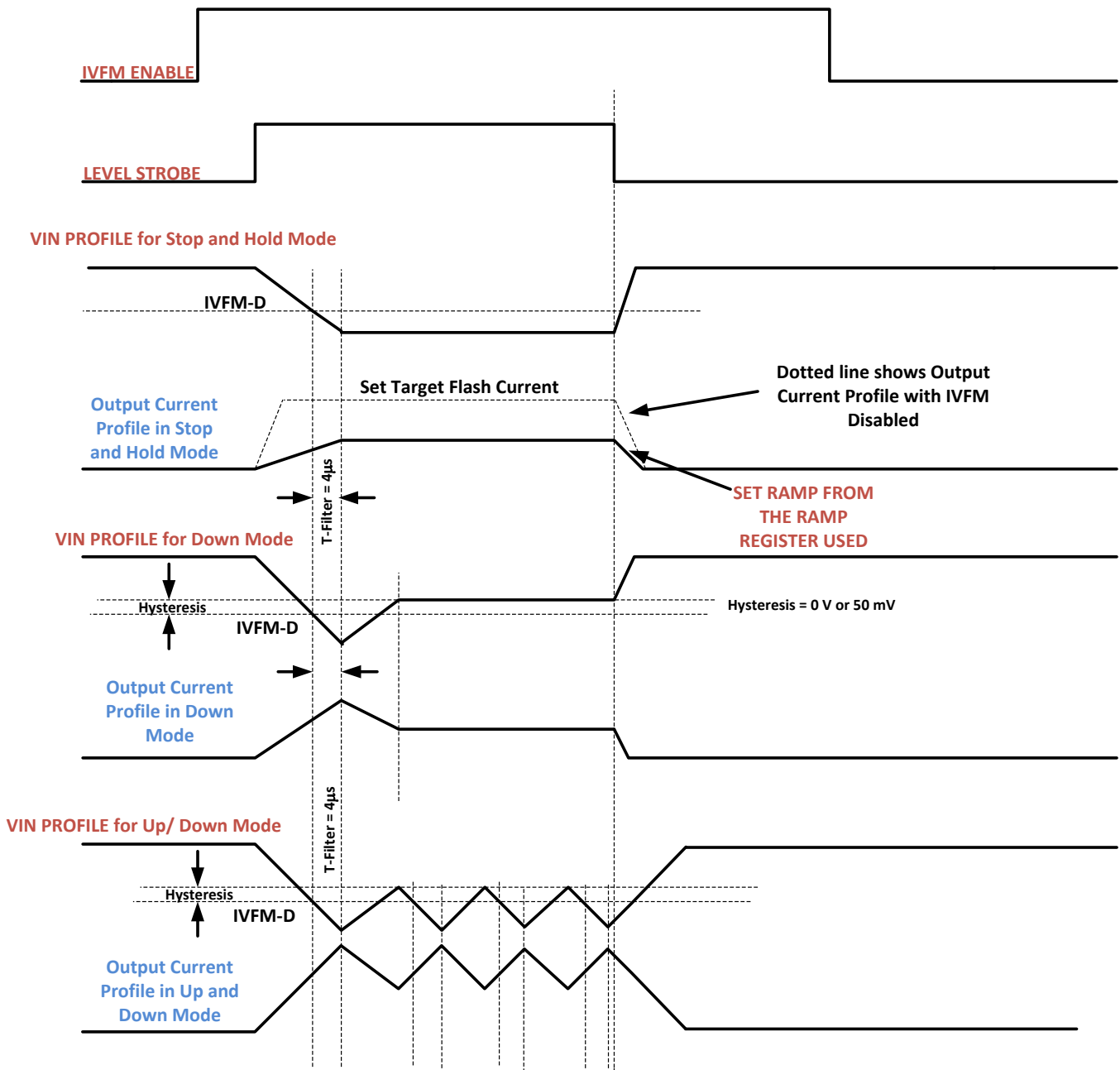


Figure 30. IVFM Modes



## Device Functioning Modes (continued)

### 8.4.5 Fault/Protections

#### 8.4.5.1 Fault Operation

If the LM3643 enters a fault condition, the device sets the appropriate flag in the Flags1 and Flags2 Registers (0x0A and 0x0B), and place the device into standby by clearing the Mode Bits ([1],[0]) in the Enable Register. The LM3643 remains in standby until an I<sup>2</sup>C read of the Flags1 and Flags2 Registers are completed. Upon clearing the flags/faults, the device can be restarted (Flash, Torch, IR, etc.). If the fault is still present, the LM3643 re-enters the fault state and enters standby again.

#### 8.4.5.2 Flash Time-Out

The Flash Time-Out period sets the amount of time that the Flash Current is being sourced from the current sources (LED1/2). The LM3643 has 16 timeout levels ranging from 10 ms to 400 ms (see [Timing Configuration Register \(0x08\)](#) for more detail).

#### 8.4.5.3 Overvoltage Protection (OVP)

The output voltage is limited to typically 5 V (see  $V_{OVP}$  spec in the [Electrical Characteristics](#)). In situations such as an open LED, the LM3643 raises the output voltage in order to try and keep the LED current at its target value. When  $V_{OUT}$  reaches 5 V (typical) the overvoltage comparator trips and turns off the internal NFET. When  $V_{OUT}$  falls below the “ **$V_{OVP}$  Off Threshold**”, the LM3643 begins switching again. The mode bits are cleared, and the OVP flag is set, when an OVP condition is present for three rising OVP edges. This prevents momentary OVP events from forcing the device to shut down.

#### 8.4.5.4 Current Limit

The LM3643 features two selectable inductor current limits that are programmable through the I<sup>2</sup>C-compatible interface. When the inductor current limit is reached, the LM3643 terminates the charging phase of the switching cycle. Switching resumes at the start of the next switching period. If the overcurrent condition persists, the device operates continuously in current limit.

Since the current limit is sensed in the NMOS switch, there is no mechanism to limit the current when the device operates in Pass Mode (current does not flow through the NMOS in pass mode). In Boost mode or Pass mode if  $V_{OUT}$  falls below 2.3 V, the device stops switching, and the PFET operates as a current source limiting the current to 200 mA. This prevents damage to the LM3643 and excessive current draw from the battery during output short-circuit conditions. The mode bits are not cleared upon a Current Limit event, but a flag is set.

#### 8.4.5.5 NTC Thermistor Input (Torch/Temp)

The TORCH/TEMP pin, when set to TEMP mode, serves as a threshold detector and bias source for negative temperature coefficient (NTC) thermistors. When the voltage at TEMP goes below the programmed threshold, the LM3643 is placed into standby mode. The NTC threshold voltage is adjustable from 200 mV to 900 mV in 100-mV steps. The NTC bias current is set to 50  $\mu$ A. The NTC detection circuitry can be enabled or disabled via the Enable Register. If enabled, the NTC block turns on and off during the start and stop of a Flash/Torch event.

Additionally, the NTC input looks for an open NTC connection and a shorted NTC connection. If the NTC input falls below 100 mV, the NTC short flag is set, and the device is disabled. If the NTC input rises above 2.3 V, the NTC Open flag is set, and the device is disabled. These fault detections can be individually disabled/enabled via the NTC Open Fault Enable bit and the NTC Short Fault Enable bit.

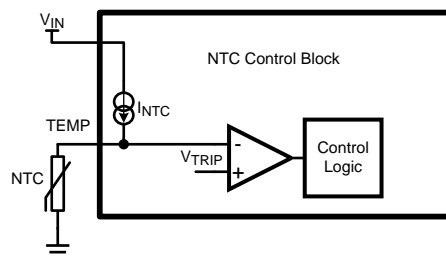


Figure 31. Temp Detection Diagram

## Device Functioning Modes (continued)

### 8.4.5.6 Undervoltage Lockout (UVLO)

The LM3643 has an internal comparator that monitors the voltage at IN and forces the LM3643 into standby if the input voltage drops to 2.5 V. If the UVLO monitor threshold is tripped, the UVLO flag bit is set in the Flags1 Register (0x0A). If the input voltage rises above 2.5 V, the LM3643 is not available for operation until there is an I<sup>2</sup>C read of the Flags1 Register (0x0A). Upon a read, the Flags1 register is cleared, and normal operation can resume if the input voltage is greater than 2.5 V.

### 8.4.5.7 Thermal Shutdown (TSD)

When the LM3643 die temperature reaches 150°C, the thermal shutdown detection circuit trips, forcing the LM3643 into standby and writing a '1' to the corresponding bit of the Flags1 Register (0x0A) (Thermal Shutdown bit). The LM3643 is only allowed to restart after the Flags1 Register (0x0A) is read, clearing the fault flag. Upon restart, if the die temperature is still above 150°C, the LM3643 resets the Fault flag and re-enters standby.

### 8.4.5.8 LED and/or V<sub>OUT</sub> Short Fault

The LED Fault flags read back a '1' if the device is active in Flash or Torch mode and either active LED output experiences a short condition. The Output Short Fault flag reads back a '1' if the device is active in Flash or Torch mode and the boost output experiences a short condition. An LED short condition is determined if the voltage at LED1 or LED2 goes below 500 mV (typ.) while the device is in Torch or Flash mode. There is a deglitch time of 256 μs before the LED Short flag is valid and a deglitch time of 2.048 ms before the V<sub>OUT</sub> Short flag is valid. The LED Short Faults can be reset to '0' by removing power to the LM3643, setting HWEN to '0', setting the SW RESET bit to a '1', or by reading back the Flags1 Register (0x0A on LM3643). The mode bits are cleared upon an LED and/or V<sub>OUT</sub> short fault.

## 8.5 Programming

### 8.5.1 Control Truth Table

MODE1	MODE0	STROBE EN	TORCH EN	STROBE PIN	TORCH PIN	ACTION
0	0	0	0	X	X	Standby
0	0	0	1	X	pos edge	Ext Torch
0	0	1	0	pos edge	X	Ext Flash
0	0	1	1	0	pos edge	Standalone Torch
0	0	1	1	pos edge	0	Standalone Flash
0	0	1	1	pos edge	pos edge	Standalone Flash
1	0	X	X	X	X	Int Torch
1	1	X	X	X	X	Int Flash
0	1	0	X	X	X	IRLED Standby
0	1	1	X	0	X	IRLED Standby
0	1	1	X	pos edge	X	IRLED enabled

## 8.5.2 I<sup>2</sup>C-Compatible Interface

### 8.5.2.1 Data Validity

The data on SDA must be stable during the HIGH period of the clock signal (SCL). In other words, the state of the data line can only be changed when SCL is LOW.

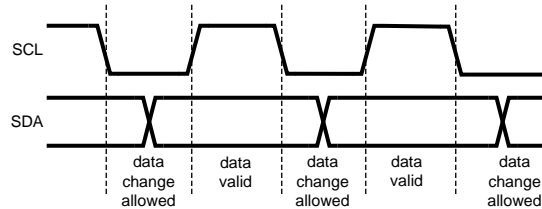


Figure 32. Data Validity Data

A pullup resistor between the controller's VIO line and SDA must be greater than  $[(VIO - V_{OL}) / 3 \text{ mA}]$  to meet the  $V_{OL}$  requirement on SDA. Using a larger pullup resistor results in lower switching current with slower edges, while using a smaller pullup results in higher switching currents with faster edges.

### 8.5.2.2 Start and Stop Conditions

START and STOP conditions classify the beginning and the end of the I<sup>2</sup>C session. A START condition is defined as the SDA signal transitioning from HIGH to LOW while SCL line is HIGH. A STOP condition is defined as the SDA transitioning from LOW to HIGH while SCL is HIGH. The I<sup>2</sup>C master always generates START and STOP conditions. The I<sup>2</sup>C bus is considered busy after a START condition and free after a STOP condition. During data transmission, the I<sup>2</sup>C master can generate repeated START conditions. First START and repeated START conditions are equivalent, function-wise.

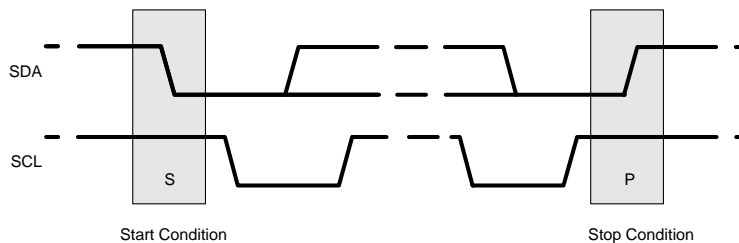
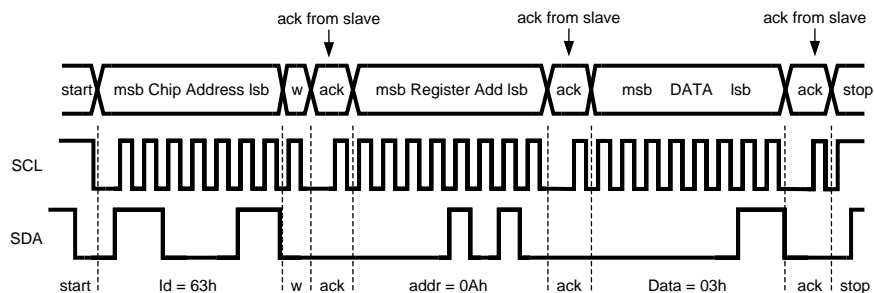


Figure 33. Start and Stop Conditions

### 8.5.2.3 Transferring Data

Every byte put on the SDA line must be eight bits long, with the most significant bit (MSB) transferred first. Each byte of data has to be followed by an acknowledge bit. The acknowledge related clock pulse is generated by the master. The master releases the SDA line (HIGH) during the acknowledge clock pulse. The LM3643 pulls down the SDA line during the 9th clock pulse, signifying an acknowledge. The LM3643 generates an acknowledge after each byte is received. There is no acknowledge created after data is read from the device.

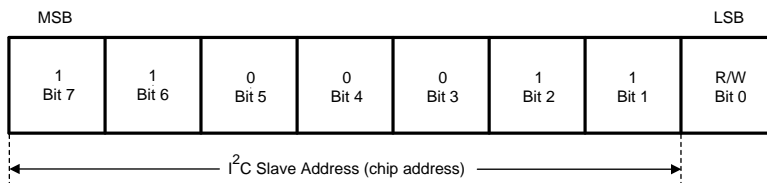
After the START condition, the I<sup>2</sup>C master sends a chip address. This address is seven bits long followed by an eighth bit which is a data direction bit (R/W). The LM3643 7-bit address is 0x63. The device address for the LM3643A is 0x67. For the eighth bit, a '0' indicates a WRITE and a '1' indicates a READ. The second byte selects the register to which the data is written. The third byte contains data to write to the selected register.



**Figure 34. Write Cycle W = Write (SDA = "0") R = Read (SDA = "1") Ack = Acknowledge (SDA Pulled Down by Either Master or Slave) ID = Chip Address, 63h for LM3643**

### 8.5.2.4 I<sup>2</sup>C-Compatible Chip Address

The device address for the LM3643 is 1100011 (0x63). The device address for the LM3643A is 1100111 (0x67). After the START condition, the I<sup>2</sup>C-compatible master sends the 7-bit address followed by an eighth read or write bit (R/W). R/W = 0 indicates a WRITE and R/W = 1 indicates a READ. The second byte following the device address selects the register address to which the data is written. The third byte contains the data for the selected register.



**Figure 35. I<sup>2</sup>C-Compatible Chip Address**

## 8.6 Register Descriptions

REGISTER NAME	INTERNAL HEX ADDRESS	POWER ON/RESET VALUE LM3643
Enable Register	0x01	0x80
IVFM Register	0x02	0x01
LED1 Flash Brightness Register	0x03	0xBF
LED2 Flash Brightness Register	0x04	0x3F
LED1 Torch Brightness Register	0x05	0xBF
LED2 Torch Brightness Register	0x06	0x3F
Boost Configuration Register	0x07	0x09
Timing Configuration Register	0x08	0x1A
TEMP Register	0x09	0x08
Flags1 Register	0x0A	0x00
Flags2 Register	0x0B	0x00
Device ID Register	0x0C	0x02
Last Flash Register	0x0D	0x00

### 8.6.1 Enable Register (0x01)

Bit 7	Bit 6	Bit 5	Bit 4	Bit 3	Bit 2	Bit 1	Bit 0
<b>TX Pin Enable</b> 0 = Disabled 1 = Enabled (Default)	<b>Strobe Type</b> 0 = Level Triggered (Default) 1 = Edge Triggered	<b>Strobe Enable</b> 0 = Disabled (Default) 1 = Enabled	<b>TORCH/TEMP Pin Enable</b> 0 = Disabled (Default) 1 = Enabled	<b>Mode Bits: M1, M0</b> 00 = Standby (Default) 01 = IR Drive 10 = Torch 11 = Flash		<b>LED2 Enable</b> 0 = OFF (Default) 1 = ON	<b>LED1 Enable</b> 0 = OFF (Default) 1 = ON

#### NOTE

Edge Strobe Mode is not valid in IR MODE. Switching between Level and Edge Strobe Types while the device is enabled is not recommended.

In Edge or Level Strobe Mode, it is recommended that the trigger pulse width be set greater than 1 ms to ensure proper turn-on of the device.

### 8.6.2 IVFM Register (0x02)

Bit 7	Bit 6	Bit 5	Bit 4	Bit 3	Bit 2	Bit 1	Bit 0
RFU	<b>UVLO Circuitry (Default)</b> 0 = Disabled (Default) 1 = Enabled	<b>IVFM Levels</b> 000 = 2.9 V (Default) 001 = 3 V 010 = 3.1 V 011 = 3.2 V 100 = 3.3 V 101 = 3.4 V 110 = 3.5 V 111 = 3.6 V			<b>IVFM Hysteresis</b> 0 = 0 mV (Default) 1 = 50 mV	<b>IVFM Selection</b> 00 = Disabled 01 = Stop and Hold Mode (Default) 10 = Down Mode 11 = Up and Down Mode	

#### NOTE

IVFM Mode Bits are static once the LM3643 is enabled in Torch, Flash or IR modes. If the IVFM mode needs to be updated, disable the device and then change the mode bits to the desired state.

### 8.6.3 LED1 Flash Brightness Register (0x03)

Bit 7	Bit 6	Bit 5	Bit 4	Bit 3	Bit 2	Bit 1	Bit 0
<b>LED2 Flash Current Override</b> 0 = LED2 Flash Current is not set to LED1 Flash Current 1 = LED2 Flash Current is set to LED1 Flash Current (Default)	<b>LED1 Flash Brightness Level</b> $I_{FLASH1/2} \text{ (mA)} \approx (\text{Brightness Code} \times 11.725 \text{ mA}) + 10.9 \text{ mA}$ 0000000 = 10.9 mA ..... 0111111 = 729 mA (Default) ..... 1111111 = 1.5 A						

### 8.6.4 LED2 Flash Brightness Register (0x04)

Bit 7	Bit 6	Bit 5	Bit 4	Bit 3	Bit 2	Bit 1	Bit 0
RFU	<b>LED2 Flash Brightness Levels</b> $I_{FLASH1/2} \text{ (mA)} \approx (\text{Brightness Code} \times 11.725 \text{ mA}) + 10.9 \text{ mA}$ 0000000 = 10.9 mA ..... 0111111 = 729 mA (Default) ..... 1111111 = 1.5 A						

**8.6.5 LED1 Torch Brightness Register (0x05)**

Bit 7	Bit 6	Bit 5	Bit 4	Bit 3	Bit 2	Bit 1	Bit 0
<b>LED2 Torch Current Override</b> 0 = LED2 Torch Current is not set to LED1 Torch Current 1 = LED2 Torch Current is set to LED1 Torch Current (Default)	<b>LED1 Torch Brightness Levels</b> $I_{TORCH1/2} \text{ (mA)} \approx (\text{Brightness Code} \times 1.4 \text{ mA}) + 0.977 \text{ mA}$ 0000000 = 0.977 mA ..... 0111111 = 89.3 mA (Default) ..... 1111111 = 179 mA						

**8.6.6 LED2 Torch Brightness Register (0x06)**

Bit 7	Bit 6	Bit 5	Bit 4	Bit 3	Bit 2	Bit 1	Bit 0
RFU	<b>LED2 Torch Brightness Levels</b> $I_{TORCH1/2} \text{ (mA)} \approx (\text{Brightness Code} \times 1.4 \text{ mA}) + 0.977 \text{ mA}$ 0000000 = 0.977 mA ..... 0111111 = 89.3 mA (Default) ..... 1111111 = 179 mA						

**8.6.7 Boost Configuration Register (0x07)**

Bit 7	Bit 6	Bit 5	Bit 4	Bit 3	Bit 2	Bit 1	Bit 0
<b>Software Reset Bit</b> 0 = Not Reset (Default) 1 = Reset	RFU	RFU	RFU	<b>LED Pin Short Fault Detect</b> 0 = Disabled 1 = Enabled (Default)	<b>Boost Mode</b> 0 = Normal (Default) 1 = Pass Mode Only	<b>Boost Frequency Select</b> 0 = 2 MHz (Default) 1 = 4 MHz	<b>Boost Current Limit Setting</b> 0 = 1.9 A 1 = 2.8 A (Default)

**8.6.8 Timing Configuration Register (0x08)**

Bit 7	Bit 6	Bit 5	Bit 4	Bit 3	Bit 2	Bit 1	Bit 0
RFU	<b>Torch Current Ramp Time</b> 000 = No Ramp 001 = 1 ms (Default) 010 = 32 ms 011 = 64 ms 100 = 128 ms 101 = 256 ms 110 = 512 ms 111 = 1024 ms			<b>Flash Time-Out Duration</b> 0000 = 10 ms 0001 = 20 ms 0010 = 30 ms 0011 = 40 ms 0100 = 50 ms 0101 = 60 ms 0110 = 70 ms 0111 = 80 ms 1000 = 90 ms 1001 = 100 ms 1010 = 150 ms (Default) 1011 = 200 ms 1100 = 250 ms 1101 = 300 ms 1110 = 350 ms 1111 = 400 ms			

### 8.6.9 TEMP Register (0x09)

Bit 7	Bit 6	Bit 5	Bit 4	Bit 3	Bit 2	Bit 1	Bit 0
RFU	<b>TORCH Polarity</b> 0 = Active High (Default) (Pull-down Resistor Enabled) 1 = Active Low (Pull-down Resistor Disabled)	<b>NTC Open Fault Enable</b> 0 = Disabled (Default) 1 = Enable	<b>NTC Short Fault Enable</b> 0 = Disabled (Default) 1 = Enable	<b>TEMP Detect Voltage Threshold</b> 000 = 0.2 V 001 = 0.3 V 010 = 0.4 V 011 = 0.5 V 100 = 0.6 V (Default) 101 = 0.7 V 110 = 0.8 V 111 = 0.9 V		<b>TORCH/TEMP Function Select</b> 0 = TORCH (Default) 1 = TEMP	

#### NOTE

The Torch Polarity bit is static once the LM3643 is enabled in Torch, Flash or IR modes. If the Torch Polarity bit needs to be updated, disable the device and then change the Torch Polarity bit to the desired state.

### 8.6.10 Flags1 Register (0x0A)

Bit 7	Bit 6	Bit 5	Bit 4	Bit 3	Bit 2	Bit 1	Bit 0
TX Flag	V <sub>OUT</sub> Short Fault	VLED1 Short Fault	VLED2 Short Fault	Current Limit Flag	Thermal Shutdown (TSD) Fault	UVLO Fault	Flash Time-Out Flag

### 8.6.11 Flags2 Register (0x0B)

Bit 7	Bit 6	Bit 5	Bit 4	Bit 3	Bit 2	Bit 1	Bit 0
RFU	RFU	RFU	NTC Short Fault	NTC Open Fault	IVFM Trip Flag	OVP Fault	TEMP Trip Fault

### 8.6.12 Device ID Register (0x0C)

Bit 7	Bit 6	Bit 5	Bit 4	Bit 3	Bit 2	Bit 1	Bit 0
RFU	RFU	Device ID '000'			Silicon Revision Bits '010'		

### 8.6.13 Last Flash Register (0x0D)

Bit 7	Bit 6	Bit 5	Bit 4	Bit 3	Bit 2	Bit 1	Bit 0
RFU	The value stored is always the last current value the IVFM detection block set. $I_{LED} = I_{FLASH - TARGET} \times ((Code + 1) / 128)$						

## 9 Applications and Implementation

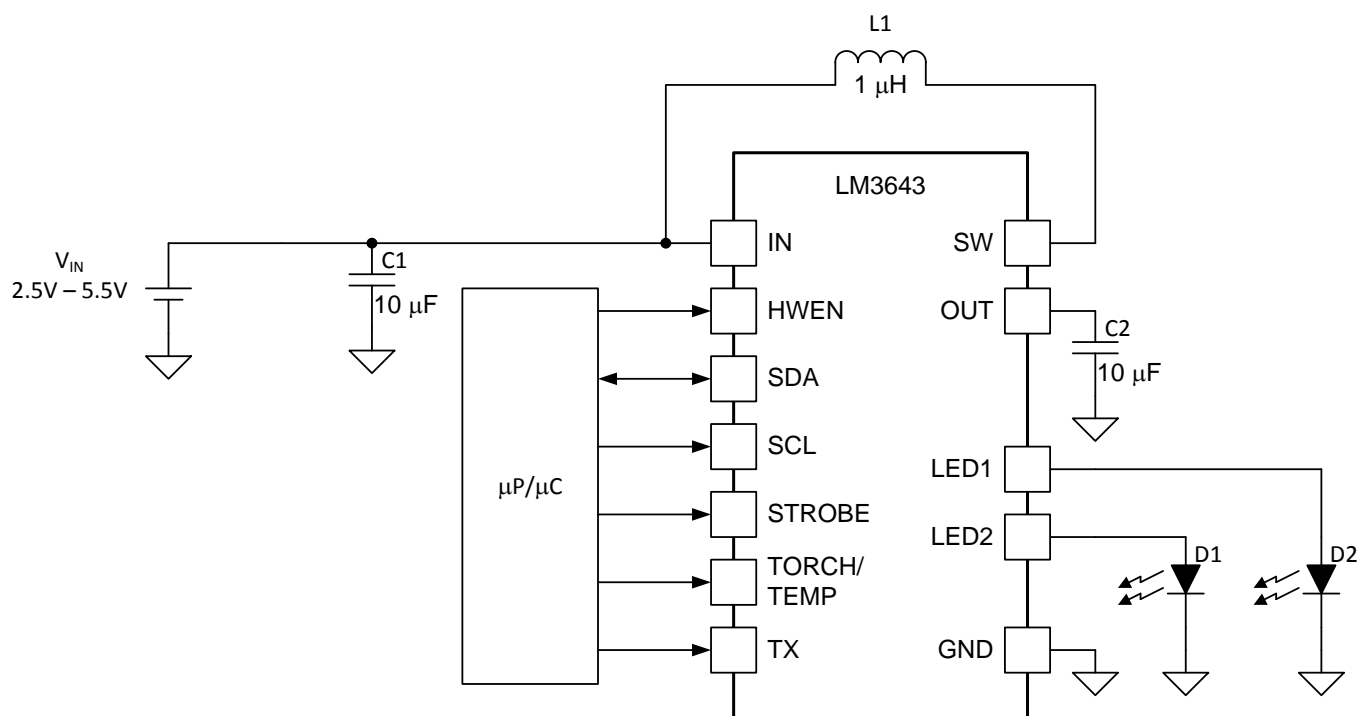
### NOTE

Information in the following applications sections is not part of the TI component specification, and TI does not warrant its accuracy or completeness. TI's customers are responsible for determining suitability of components for their purposes. Customers should validate and test their design implementation to confirm system functionality.

### 9.1 Application Information

The LM3643 can drive two flash LEDs at currents up to 1.5 A per LED. The total LED current the LM3643 boost can deliver is 1.5 A ( $I_{LED1} + I_{LED2}$ ). The 2-MHz/4-MHz DC-DC boost regulator allows for the use of small value discrete external components.

### 9.2 Typical Application



**Figure 36. LM3643 Typical Application**

#### 9.2.1 Design Requirements

Example requirements based on default register values:

DESIGN PARAMETER	EXAMPLE VALUE
Input voltage range	2.5 V to 5.5 V
Brightness control	I <sup>2</sup> C Register
LED configuration	2 parallel flash LEDs
Boost switching frequency	2 MHz (4 MHz selectable)
Flash brightness	750 mA per LED



## 9.2.2 Detailed Design Procedure

### 9.2.2.1 Output Capacitor Selection

The LM3643 is designed to operate with a 10- $\mu$ F ceramic output capacitor. When the boost converter is running, the output capacitor supplies the load current during the boost converter on-time. When the NMOS switch turns off, the inductor energy is discharged through the internal PMOS switch, supplying power to the load and restoring charge to the output capacitor. This causes a sag in the output voltage during the on-time and a rise in the output voltage during the off-time. The output capacitor is therefore chosen to limit the output ripple to an acceptable level depending on load current and input/output voltage differentials and also to ensure the converter remains stable.

Larger capacitors such as a 22- $\mu$ F or capacitors in parallel can be used if lower output voltage ripple is desired. To estimate the output voltage ripple considering the ripple due to capacitor discharge ( $\Delta V_Q$ ) and the ripple due to the capacitors ESR ( $\Delta V_{ESR}$ ) use the following equations:

For continuous conduction mode, the output voltage ripple due to the capacitor discharge is:

$$\Delta V_Q = \frac{I_{LED} \times (V_{OUT} - V_{IN})}{f_{SW} \times V_{OUT} \times C_{OUT}} \quad (1)$$

The output voltage ripple due to the output capacitors ESR is found by:

$$\Delta V_{ESR} = R_{ESR} \times \left( \frac{I_{LED} \times V_{OUT}}{V_{IN}} + \Delta I_L \right)$$

where

$$\Delta I_L = \frac{V_{IN} \times (V_{OUT} - V_{IN})}{2 \times f_{SW} \times L \times V_{OUT}} \quad (2)$$

In ceramic capacitors the ESR is very low so the assumption is that 80% of the output voltage ripple is due to capacitor discharge and 20% from ESR. [Table 1](#) lists different manufacturers for various output capacitors and their case sizes suitable for use with the LM3643.

### 9.2.2.2 Input Capacitor Selection

Choosing the correct size and type of input capacitor helps minimize the voltage ripple caused by the switching of the LM3643 boost converter and reduce noise on the boost converter's input pin that can feed through and disrupt internal analog signals. In the typical application circuit a 10- $\mu$ F ceramic input capacitor works well. It is important to place the input capacitor as close as possible to the LM3643 input (IN) pin. This reduces the series resistance and inductance that can inject noise into the device due to the input switching currents. [Table 1](#) lists various input capacitors recommended for use with the LM3643.

**Table 1. Recommended Input/Output Capacitors (X5R/X7R Dielectric)**

MANUFACTURER	PART NUMBER	VALUE	CASE SIZE	VOLTAGE RATING
TDK Corporation	C1608JB0J106M	10 $\mu$ F	0603 (1.6 mm $\times$ 0.8 mm $\times$ 0.8 mm)	6.3 V
TDK Corporation	C2012JB1A106M	10 $\mu$ F	0805 (2.0 mm $\times$ 1.25 mm $\times$ 1.25 mm)	10 V
Murata	GRM188R60J106M	10 $\mu$ F	0603 (1.6 mm $\times$ 0.8 mm $\times$ 0.8 mm)	6.3 V
Murata	GRM21BR61A106KE19	10 $\mu$ F	0805 (2.0 mm $\times$ 1.25 mm $\times$ 1.25 mm)	10 V

### 9.2.2.3 Inductor Selection

The LM3643 is designed to use a 0.47- $\mu$ H or 1- $\mu$ H inductor. [Table 2](#) lists various inductors and their manufacturers that work well with the LM3643. When the device is boosting ( $V_{OUT} > V_{IN}$ ) the inductor is typically the largest area of efficiency loss in the circuit. Therefore, choosing an inductor with the lowest possible series resistance is important. Additionally, the saturation rating of the inductor should be greater than the maximum operating peak current of the LM3643. This prevents excess efficiency loss that can occur with inductors that operate in saturation. For proper inductor operation and circuit performance, ensure that the inductor saturation and the peak current limit setting of the LM3643 are greater than  $I_{PEAK}$  in the following calculation:

$$I_{PEAK} = \frac{I_{LOAD}}{\eta} \times \frac{V_{OUT}}{V_{IN}} + \Delta I_L \quad \text{where} \quad \Delta I_L = \frac{V_{IN} \times (V_{OUT} - V_{IN})}{2 \times f_{SW} \times L \times V_{OUT}}$$

where

- $f_{SW} = 2$  or  $4$  MHz

(3)

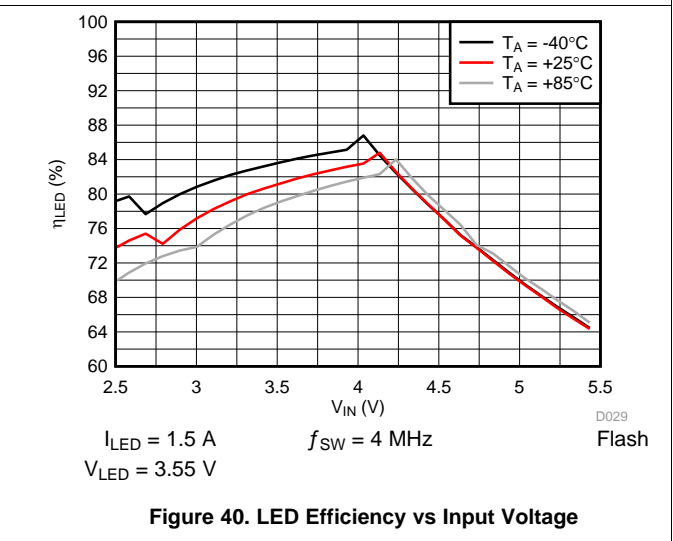
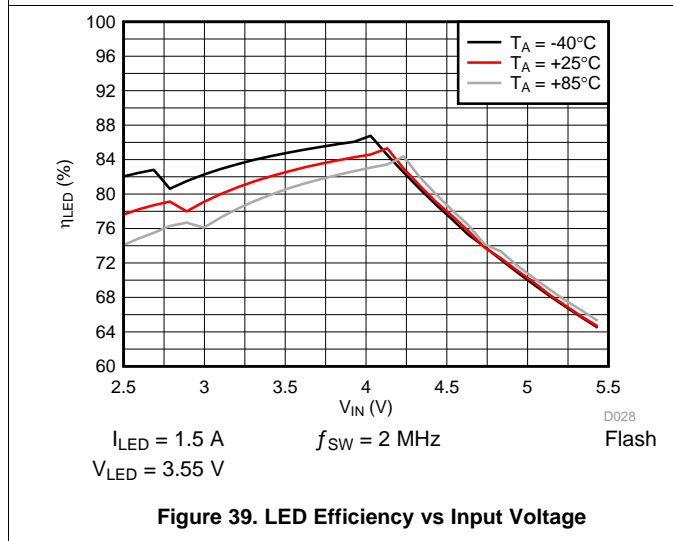
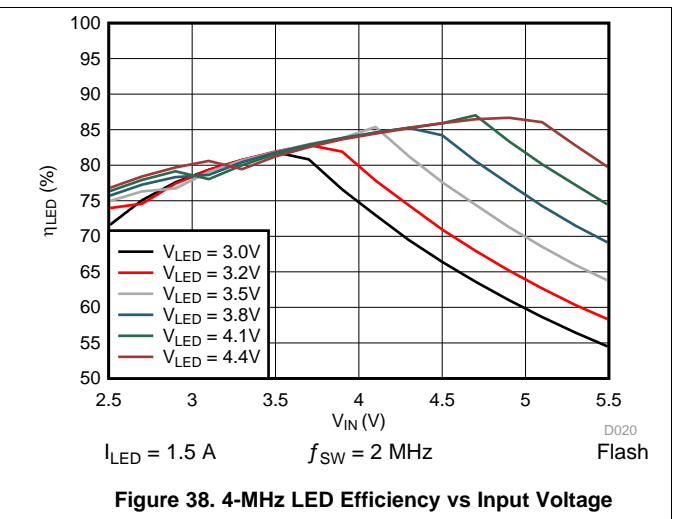
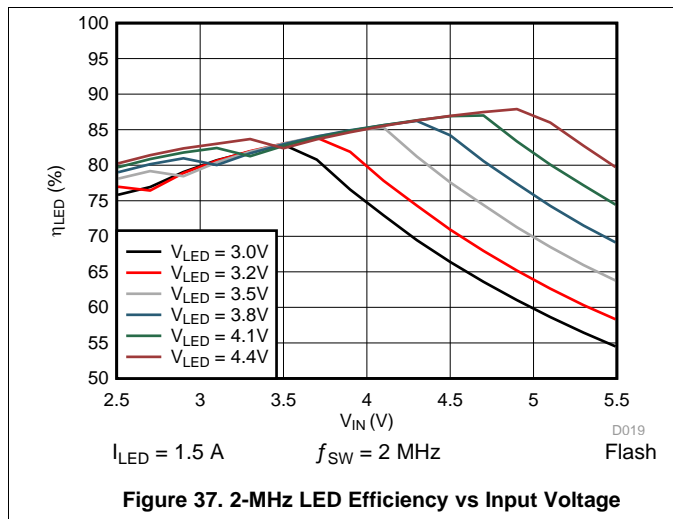
Efficiency details can be found in the [Application Curves](#).

**Table 2. Recommended Inductors**

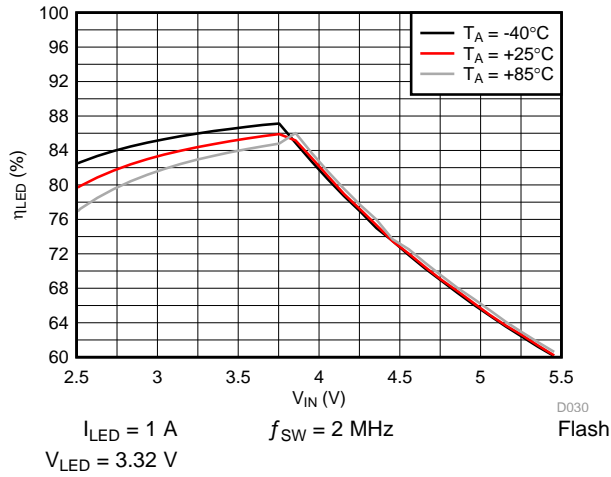
MANUFACTURER	L	PART NUMBER	DIMENSIONS (LxWxH)	I <sub>SAT</sub>	R <sub>DC</sub>
TOKO	0.47 μH	DFE201610P-R470M	2.0 mm x 1.6 mm x 1.0 mm	4.1 A	32 mΩ
TOKO	1 μH	DFE201610P-1R0M	2.0 mm x 1.6 mm x 1.0 mm	3.7 A	58 mΩ

### 9.2.3 Application Curves

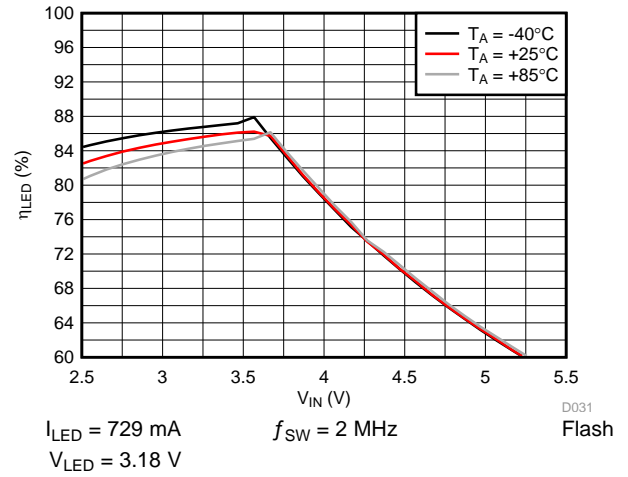
Ambient temperature is 25°C, input voltage is 3.6 V, HWEN = V<sub>IN</sub>, C<sub>IN</sub> = 2 × 10 μF, C<sub>OUT</sub> = 2 × 10 μF and L = 1 μH, unless otherwise noted.



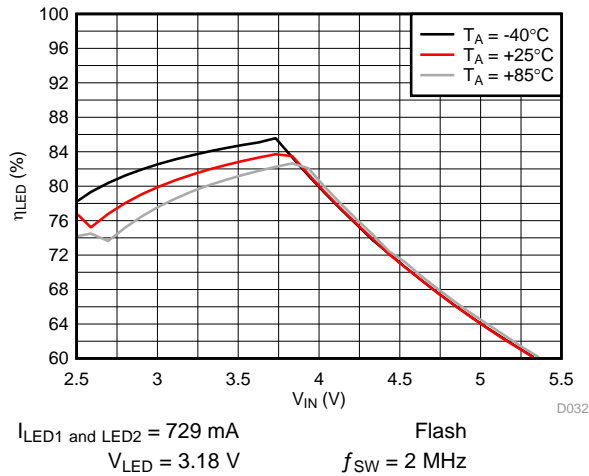
Ambient temperature is 25°C, input voltage is 3.6 V,  $I_{LED} = V_{IN}$ ,  $C_{IN} = 2 \times 10 \mu\text{F}$ ,  $C_{OUT} = 2 \times 10 \mu\text{F}$  and  $L = 1 \mu\text{H}$ , unless otherwise noted.



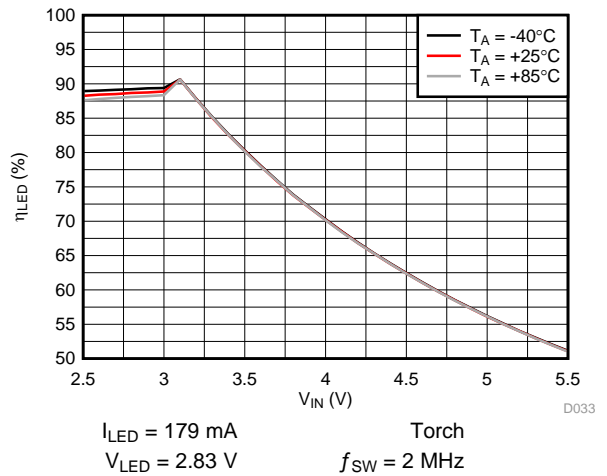
**Figure 41. LED Efficiency vs Input Voltage**



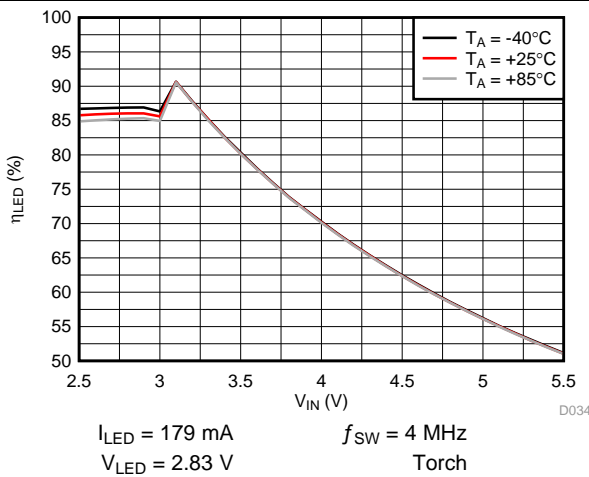
**Figure 42. LED Efficiency vs Input Voltage**



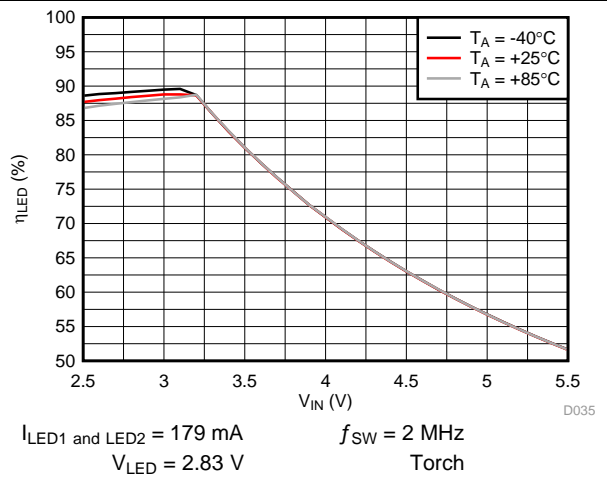
**Figure 43. LED Efficiency vs Input Voltage**



**Figure 44. LED Efficiency vs Input Voltage**

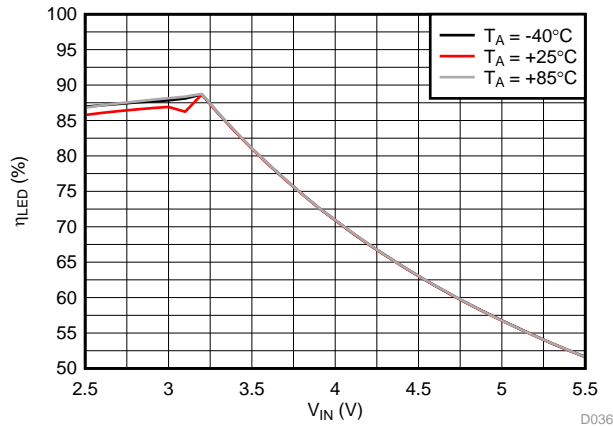


**Figure 45. LED Efficiency vs Input Voltage**



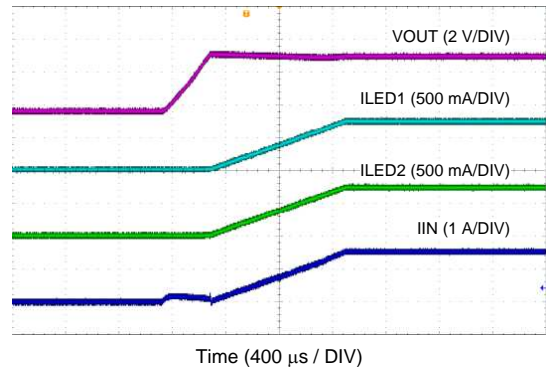
**Figure 46. LED Efficiency vs Input Voltage**

Ambient temperature is 25°C, input voltage is 3.6 V, HWEN = V<sub>IN</sub>, C<sub>IN</sub> = 2 × 10 μF, C<sub>OUT</sub> = 2 × 10 μF and L = 1 μH, unless otherwise noted.



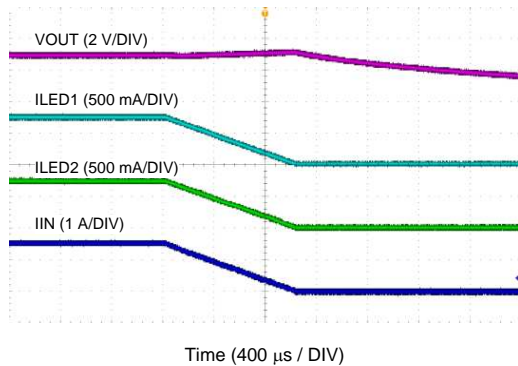
$I_{LED1}$  and  $I_{LED2}$  = 179 mA       $f_{SW}$  = 4 MHz  
 $V_{LED}$  = 2.83 V      Torch

**Figure 47. LED Efficiency vs Input Voltage**



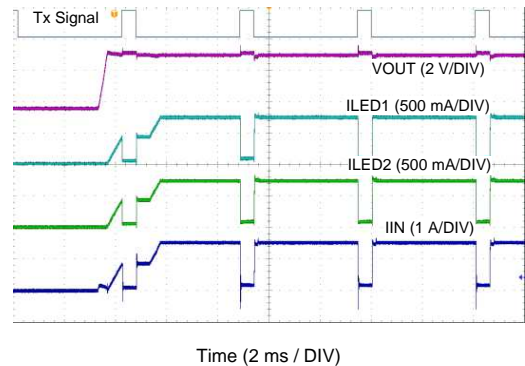
$I_{LED1}$  =  $I_{LED2}$  = 730 mA       $f_{SW}$  = 2 MHz  
 $V_{LED}$  = 3.18 V

**Figure 48. Start-Up**



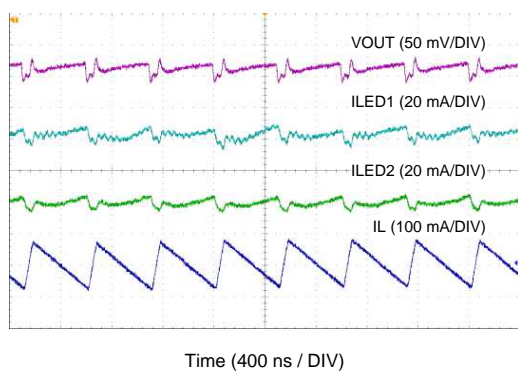
$I_{LED1}$  =  $I_{LED2}$  = 730 mA       $f_{SW}$  = 2 MHz  
 $V_{LED}$  = 3.18 V

**Figure 49. Ramp Down**



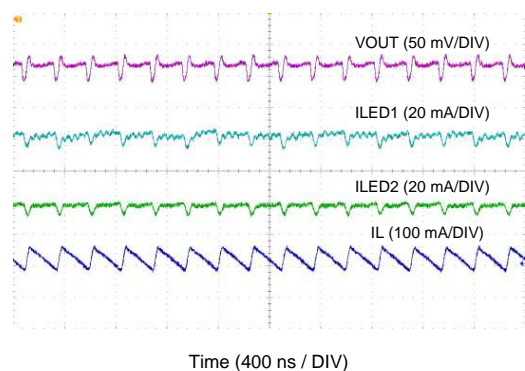
$I_{LED1}$  =  $I_{LED2}$  = 730 mA       $f_{SW}$  = 2 MHz  
 $V_{LED}$  = 3.18 V

**Figure 50. TX Interrupt**



$I_{LED1}$  =  $I_{LED2}$  = 730 mA       $f_{SW}$  = 2 MHz  
 $V_{LED}$  = 3.18 V

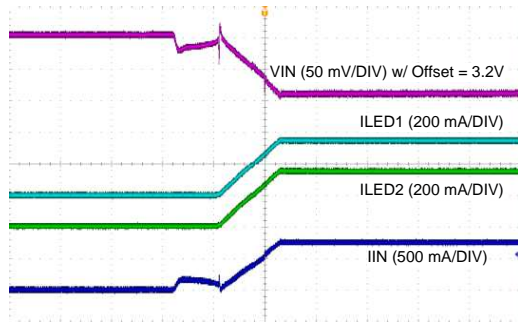
**Figure 51. Ripple @ 2 MHz**



$I_{LED1}$  =  $I_{LED2}$  = 730 mA       $f_{SW}$  = 4 MHz  
 $V_{LED}$  = 3.18 V

**Figure 52. Ripple @ 4 MHz**

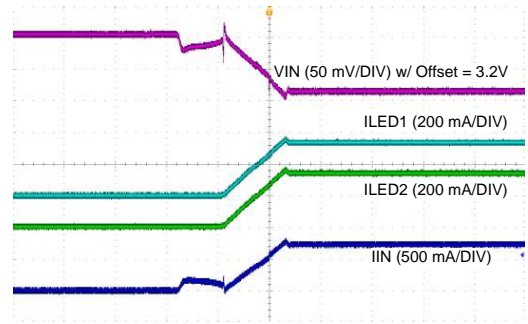
Ambient temperature is 25°C, input voltage is 3.6 V, HWEN = V<sub>IN</sub>, C<sub>IN</sub> = 2 × 10 μF, C<sub>OUT</sub> = 2 × 10 μF and L = 1 μH, unless otherwise noted.



Time (400 μs / DIV)

$I_{LED1} = I_{LED2} = 730 \text{ mA}$   
 $V_{LED} = 3.18 \text{ V}$   
 $f_{SW} = 2 \text{ MHz}$   
 $V_{IVFM} = 3.2 \text{ V}$

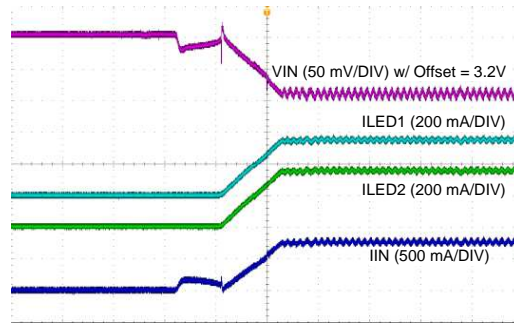
Figure 53. IVFM - Ramp and Hold



Time (400 μs / DIV)

$I_{LED1} = I_{LED2} = 730 \text{ mA}$   
 $V_{LED} = 3.18 \text{ V}$   
 $f_{SW} = 2 \text{ MHz}$   
 $V_{IVFM} = 3.2 \text{ V}$

Figure 54. IVFM - Down Adjust Only



Time (400 μs / DIV)

$I_{LED1} = I_{LED2} = 730 \text{ mA}$   
 $V_{LED} = 3.18 \text{ V}$   
 $f_{SW} = 2 \text{ MHz}$   
 $V_{IVFM} = 3.2 \text{ V}$

Figure 55. IVFM - Up and Down Adjust

## 10 Power Supply Recommendations

The LM3643 is designed to operate from an input voltage supply range between 2.5 V and 5.5 V. This input supply must be well regulated and capable to supply the required input current. If the input supply is located far from the LM3643 additional bulk capacitance may be required in addition to the ceramic bypass capacitors.

## 11 Layout

### 11.1 Layout Guidelines

The high switching frequency and large switching currents of the LM3643 make the choice of layout important. The following steps should be used as a reference to ensure the device is stable and maintains proper LED current regulation across its intended operating voltage and current range.

1. Place  $C_{IN}$  on the top layer (same layer as the LM3643) and as close to the device as possible. The input capacitor conducts the driver currents during the low-side MOSFET turn-on and turn-off and can detect current spikes over 1 A in amplitude. Connecting the input capacitor through short, wide traces to both the IN and GND pins reduces the inductive voltage spikes that occur during switching which can corrupt the  $V_{IN}$  line.
2. Place  $C_{OUT}$  on the top layer (same layer as the LM3643) and as close as possible to the OUT and GND pin. The returns for both  $C_{IN}$  and  $C_{OUT}$  should come together at one point, as close to the GND pin as possible. Connecting  $C_{OUT}$  through short, wide traces reduce the series inductance on the OUT and GND pins that can corrupt the  $V_{OUT}$  and GND lines and cause excessive noise in the device and surrounding circuitry.
3. Connect the inductor on the top layer close to the SW pin. There should be a low-impedance connection from the inductor to SW due to the large DC inductor current, and at the same time the area occupied by the SW node should be small so as to reduce the capacitive coupling of the high  $dV/dT$  present at SW that can couple into nearby traces.
4. Avoid routing logic traces near the SW node so as to avoid any capacitively coupled voltages from SW onto any high-impedance logic lines such as TORCH/TEMP, STROBE, HWEN, SDA, and SCL. A good approach is to insert an inner layer GND plane underneath the SW node and between any nearby routed traces. This creates a shield from the electric field generated at SW.
5. Terminate the Flash LED cathodes directly to the GND pin of the LM3643. If possible, route the LED returns with a dedicated path so as to keep the high amplitude LED currents out of the GND plane. For Flash LEDs that are routed relatively far away from the LM3643, a good approach is to sandwich the forward and return current paths over the top of each other on two layers. This helps reduce the inductance of the LED current paths.

## 11.2 Layout Example

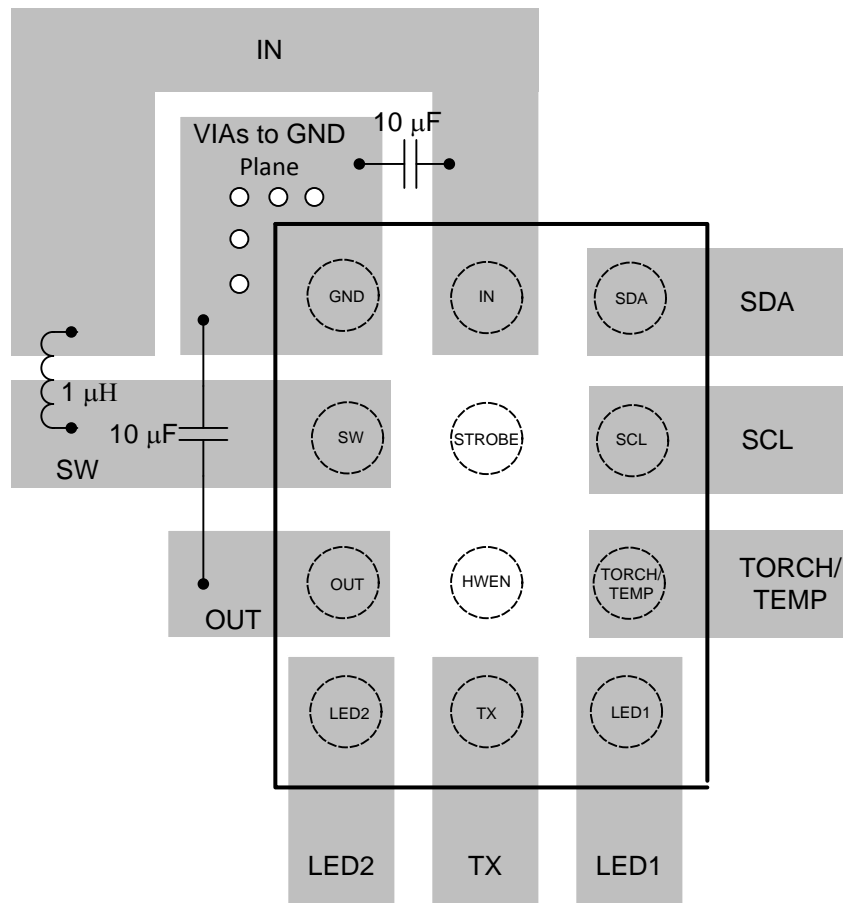


Figure 56. Layout Example

## 12 器件和文档支持

### 12.1 器件支持

#### 12.1.1 Third-Party Products Disclaimer

TI'S PUBLICATION OF INFORMATION REGARDING THIRD-PARTY PRODUCTS OR SERVICES DOES NOT CONSTITUTE AN ENDORSEMENT REGARDING THE SUITABILITY OF SUCH PRODUCTS OR SERVICES OR A WARRANTY, REPRESENTATION OR ENDORSEMENT OF SUCH PRODUCTS OR SERVICES, EITHER ALONE OR IN COMBINATION WITH ANY TI PRODUCT OR SERVICE.

### 12.2 相关文档

#### 12.2.1 相关链接

表 3 列出了快速访问链接。范围包括技术文档、支持与社区资源、工具和软件，以及样片或购买的快速访问。

表 3. 相关链接

器件	产品文件夹	样片与购买	技术文档	工具与软件	支持与社区
LM3643	<a href="#">请单击此处</a>	<a href="#">请单击此处</a>	<a href="#">请单击此处</a>	<a href="#">请单击此处</a>	<a href="#">请单击此处</a>
LM3643A	<a href="#">请单击此处</a>	<a href="#">请单击此处</a>	<a href="#">请单击此处</a>	<a href="#">请单击此处</a>	<a href="#">请单击此处</a>

### 12.3 商标

### 12.4 静电放电警告



ESD 可能会损坏该集成电路。德州仪器 (TI) 建议通过适当的预防措施处理所有集成电路。如果不遵守正确的处理措施和安装程序，可能会损坏集成电路。

ESD 的损坏小至导致微小的性能降级，大至整个器件故障。精密的集成电路可能更容易受到损坏，这是因为非常细微的参数更改都可能会导致器件与其发布的规格不相符。

### 12.5 术语表

[SLYZ022](#) — TI 术语表。

这份术语表列出并解释术语、缩写和定义。

## 13 机械、封装和可订购信息

以下页中包括机械、封装和可订购信息。这些信息是针对指定器件可提供的最新数据。这些数据会在无通知且不对本文档进行修订的情况下发生改变。欲获得该数据表的浏览器版本，请查阅左侧的导航栏。



## 重要声明

德州仪器(TI)及其下属子公司有权根据 JESD46 最新标准,对所提供的产品和服务进行更正、修改、增强、改进或其它更改,并有权根据 JESD48 最新标准中止提供任何产品和服务。客户在下订单前应获取最新的相关信息,并验证这些信息是否完整且是最新的。所有产品的销售都遵循在订单确认时所提供的TI 销售条款与条件。

TI 保证其所销售的组件的性能符合产品销售时 TI 半导体产品销售条件与条款的适用规范。仅在 TI 保证的范围内,且 TI 认为有必要时才会使用测试或其它质量控制技术。除非适用法律做出了硬性规定,否则没有必要对每种组件的所有参数进行测试。

TI 对应用帮助或客户产品设计不承担任何义务。客户应对其使用 TI 组件的产品和应用自行负责。为尽量减小与客户产品和应用相关的风险,客户应提供充分的设计与操作安全措施。

TI 不对任何 TI 专利权、版权、屏蔽作品权或其它与使用了 TI 组件或服务的组合设备、机器或流程相关的 TI 知识产权中授予的直接或隐含权限作出任何保证或解释。TI 所发布的与第三方产品或服务有关的信息,不能构成从 TI 获得使用这些产品或服务的许可、授权、或认可。使用此类信息可能需要获得第三方的专利权或其它知识产权方面的许可,或是 TI 的专利权或其它知识产权方面的许可。

对于 TI 的产品手册或数据表中 TI 信息的重要部分,仅在没有对内容进行任何篡改且带有相关授权、条件、限制和声明的情况下才允许进行复制。TI 对此类篡改过的文件不承担任何责任或义务。复制第三方的信息可能需要服从额外的限制条件。

在转售 TI 组件或服务时,如果对该组件或服务参数的陈述与 TI 标明的参数相比存在差异或虚假成分,则会失去相关 TI 组件或服务的所有明示或暗示授权,且这是不正当的、欺诈性商业行为。TI 对任何此类虚假陈述均不承担任何责任或义务。

客户认可并同意,尽管任何应用相关信息或支持仍可能由 TI 提供,但他们将独立负责满足与其产品及其在应用中使用的 TI 产品相关的所有法律、法规和安全相关要求。客户声明并同意,他们具备制定与实施安全措施所需的全部专业技术和知识,可预见故障的危险后果、监测故障及其后果、降低有可能造成人身伤害的故障的发生机率并采取适当的补救措施。客户将全额赔偿因在此类安全关键应用中使用任何 TI 组件而对 TI 及其代理造成的任何损失。

在某些场合中,为了推进安全相关应用有可能对 TI 组件进行特别的促销。TI 的目标是利用此类组件帮助客户设计和创立其特有的可满足适用的功能安全性标准和要求的终端产品解决方案。尽管如此,此类组件仍然服从这些条款。

TI 组件未获得用于 FDA Class III (或类似的生命攸关医疗设备)的授权许可,除非各方授权官员已经达成了专门管控此类使用的特别协议。

只有那些 TI 特别注明属于军用等级或“增强型塑料”的 TI 组件才是设计或专门用于军事/航空应用或环境的。购买者认可并同意,对并非指定面向军事或航空航天用途的 TI 组件进行军事或航空航天方面的应用,其风险由客户单独承担,并且由客户独立负责满足与此类使用相关的所有法律和法规要求。

TI 已明确指定符合 ISO/TS16949 要求的产品,这些产品主要用于汽车。在任何情况下,因使用非指定产品而无法达到 ISO/TS16949 要求, TI 不承担任何责任。

	产品		应用
数字音频	<a href="http://www.ti.com.cn/audio">www.ti.com.cn/audio</a>	通信与电信	<a href="http://www.ti.com.cn/telecom">www.ti.com.cn/telecom</a>
放大器和线性器件	<a href="http://www.ti.com.cn/amplifiers">www.ti.com.cn/amplifiers</a>	计算机及周边	<a href="http://www.ti.com.cn/computer">www.ti.com.cn/computer</a>
数据转换器	<a href="http://www.ti.com.cn/dataconverters">www.ti.com.cn/dataconverters</a>	消费电子	<a href="http://www.ti.com.cn/consumer-apps">www.ti.com.cn/consumer-apps</a>
DLP® 产品	<a href="http://www.dlp.com">www.dlp.com</a>	能源	<a href="http://www.ti.com.cn/energy">www.ti.com.cn/energy</a>
DSP - 数字信号处理器	<a href="http://www.ti.com.cn/dsp">www.ti.com.cn/dsp</a>	工业应用	<a href="http://www.ti.com.cn/industrial">www.ti.com.cn/industrial</a>
时钟和计时器	<a href="http://www.ti.com.cn/clockandtimers">www.ti.com.cn/clockandtimers</a>	医疗电子	<a href="http://www.ti.com.cn/medical">www.ti.com.cn/medical</a>
接口	<a href="http://www.ti.com.cn/interface">www.ti.com.cn/interface</a>	安防应用	<a href="http://www.ti.com.cn/security">www.ti.com.cn/security</a>
逻辑	<a href="http://www.ti.com.cn/logic">www.ti.com.cn/logic</a>	汽车电子	<a href="http://www.ti.com.cn/automotive">www.ti.com.cn/automotive</a>
电源管理	<a href="http://www.ti.com.cn/power">www.ti.com.cn/power</a>	视频和影像	<a href="http://www.ti.com.cn/video">www.ti.com.cn/video</a>
微控制器 (MCU)	<a href="http://www.ti.com.cn/microcontrollers">www.ti.com.cn/microcontrollers</a>		
RFID 系统	<a href="http://www.ti.com.cn/rfidsys">www.ti.com.cn/rfidsys</a>		
OMAP应用处理器	<a href="http://www.ti.com.cn/omap">www.ti.com.cn/omap</a>		
无线连通性	<a href="http://www.ti.com.cn/wirelessconnectivity">www.ti.com.cn/wirelessconnectivity</a>	德州仪器在线技术支持社区	<a href="http://www.deyisupport.com">www.deyisupport.com</a>

邮寄地址: 上海市浦东新区世纪大道1568号, 中建大厦32楼邮政编码: 200122  
Copyright © 2016, 德州仪器半导体技术(上海)有限公司

**PACKAGING INFORMATION**

Orderable Device	Status (1)	Package Type	Package Drawing	Pins	Package Qty	Eco Plan (2)	Lead finish/ Ball material (6)	MSL Peak Temp (3)	Op Temp (°C)	Device Marking (4/5)	Samples
LM3643AYFFR	ACTIVE	DSBGA	YFF	12	3000	RoHS & Green	SNAGCU	Level-1-260C-UNLIM	-40 to 85	ZAAI	<a href="#">Samples</a>
LM3643YFFR	ACTIVE	DSBGA	YFF	12	3000	RoHS & Green	SNAGCU	Level-1-260C-UNLIM	-40 to 85	3643	<a href="#">Samples</a>

(1) The marketing status values are defined as follows:

**ACTIVE:** Product device recommended for new designs.

**LIFEBUY:** TI has announced that the device will be discontinued, and a lifetime-buy period is in effect.

**NRND:** Not recommended for new designs. Device is in production to support existing customers, but TI does not recommend using this part in a new design.

**PREVIEW:** Device has been announced but is not in production. Samples may or may not be available.

**OBSOLETE:** TI has discontinued the production of the device.

(2) **RoHS:** TI defines "RoHS" to mean semiconductor products that are compliant with the current EU RoHS requirements for all 10 RoHS substances, including the requirement that RoHS substance do not exceed 0.1% by weight in homogeneous materials. Where designed to be soldered at high temperatures, "RoHS" products are suitable for use in specified lead-free processes. TI may reference these types of products as "Pb-Free".

**RoHS Exempt:** TI defines "RoHS Exempt" to mean products that contain lead but are compliant with EU RoHS pursuant to a specific EU RoHS exemption.

**Green:** TI defines "Green" to mean the content of Chlorine (Cl) and Bromine (Br) based flame retardants meet JS709B low halogen requirements of <=1000ppm threshold. Antimony trioxide based flame retardants must also meet the <=1000ppm threshold requirement.

(3) MSL, Peak Temp. - The Moisture Sensitivity Level rating according to the JEDEC industry standard classifications, and peak solder temperature.

(4) There may be additional marking, which relates to the logo, the lot trace code information, or the environmental category on the device.

(5) Multiple Device Markings will be inside parentheses. Only one Device Marking contained in parentheses and separated by a "~" will appear on a device. If a line is indented then it is a continuation of the previous line and the two combined represent the entire Device Marking for that device.

(6) Lead finish/Ball material - Orderable Devices may have multiple material finish options. Finish options are separated by a vertical ruled line. Lead finish/Ball material values may wrap to two lines if the finish value exceeds the maximum column width.

**Important Information and Disclaimer:**The information provided on this page represents TI's knowledge and belief as of the date that it is provided. TI bases its knowledge and belief on information provided by third parties, and makes no representation or warranty as to the accuracy of such information. Efforts are underway to better integrate information from third parties. TI has taken and continues to take reasonable steps to provide representative and accurate information but may not have conducted destructive testing or chemical analysis on incoming materials and chemicals. TI and TI suppliers consider certain information to be proprietary, and thus CAS numbers and other limited information may not be available for release.

In no event shall TI's liability arising out of such information exceed the total purchase price of the TI part(s) at issue in this document sold by TI to Customer on an annual basis.



**TAPE AND REEL INFORMATION**

**QUADRANT ASSIGNMENTS FOR PIN 1 ORIENTATION IN TAPE**


\*All dimensions are nominal

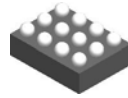
Device	Package Type	Package Drawing	Pins	SPQ	Reel Diameter (mm)	Reel Width W1 (mm)	A0 (mm)	B0 (mm)	K0 (mm)	P1 (mm)	W (mm)	Pin1 Quadrant
LM3643AYFFR	DSBGA	YFF	12	3000	180.0	8.4	1.36	1.76	0.77	4.0	8.0	Q1
LM3643YFFR	DSBGA	YFF	12	3000	180.0	8.4	1.36	1.76	0.77	4.0	8.0	Q1

**TAPE AND REEL BOX DIMENSIONS**


\*All dimensions are nominal

Device	Package Type	Package Drawing	Pins	SPQ	Length (mm)	Width (mm)	Height (mm)
LM3643AYFFR	DSBGA	YFF	12	3000	182.0	182.0	20.0
LM3643YFFR	DSBGA	YFF	12	3000	182.0	182.0	20.0

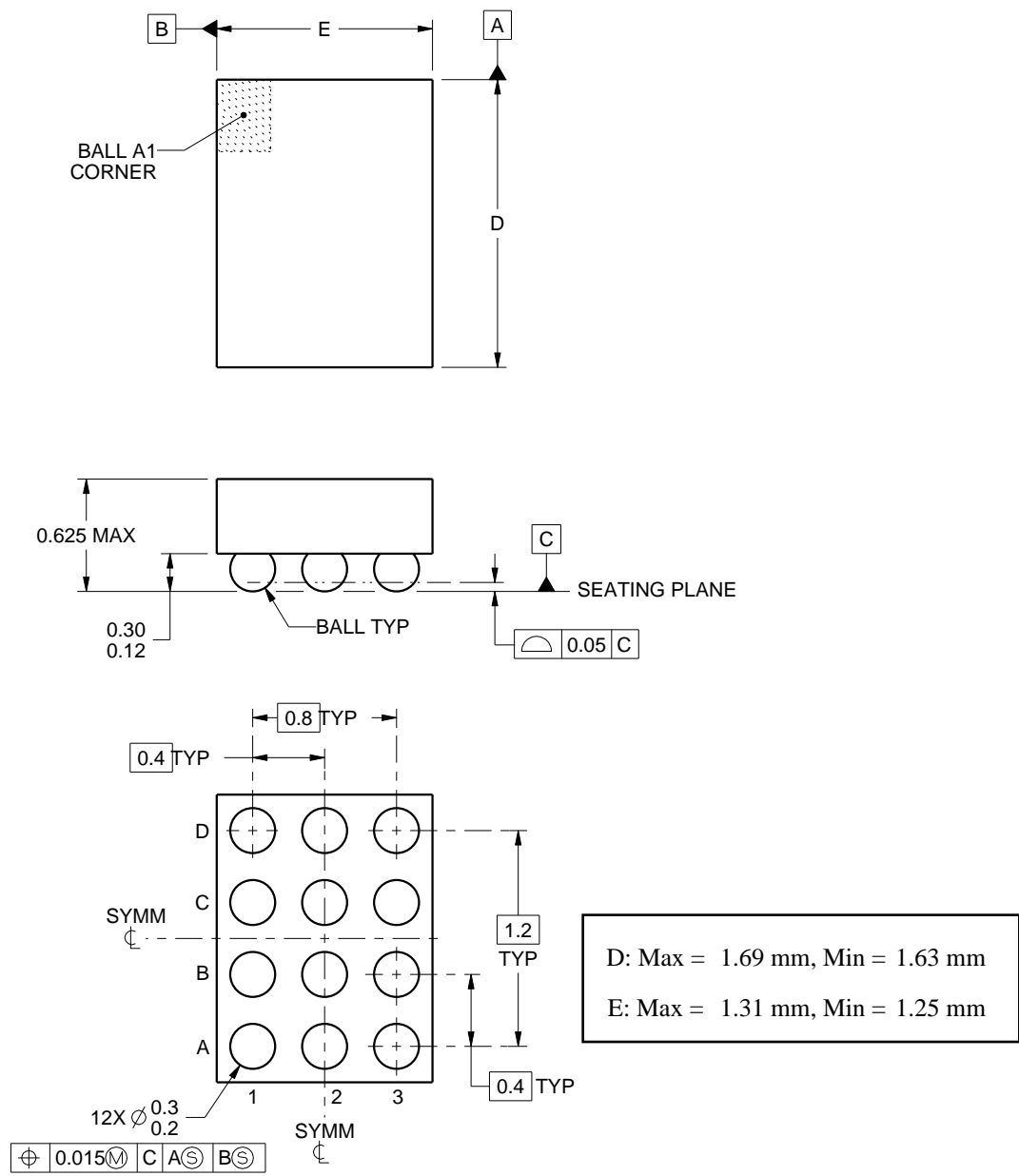
YFF0012



PACKAGE OUTLINE

DSBGA - 0.625 mm max height

DIE SIZE BALL GRID ARRAY



4222191/A 07/2015

NOTES:

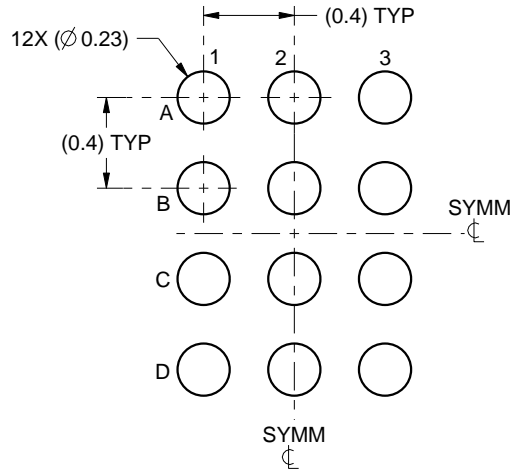
1. All linear dimensions are in millimeters. Any dimensions in parenthesis are for reference only. Dimensioning and tolerancing per ASME Y14.5M.
2. This drawing is subject to change without notice.

# EXAMPLE BOARD LAYOUT

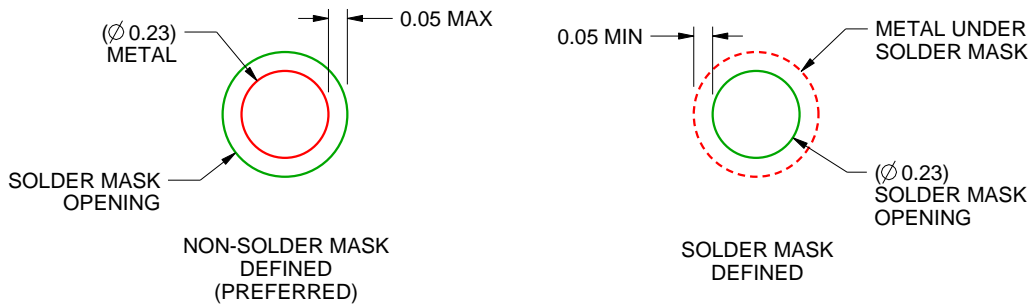
YFF0012

DSBGA - 0.625 mm max height

DIE SIZE BALL GRID ARRAY



LAND PATTERN EXAMPLE  
SCALE:30X



SOLDER MASK DETAILS  
NOT TO SCALE

4222191/A 07/2015

NOTES: (continued)

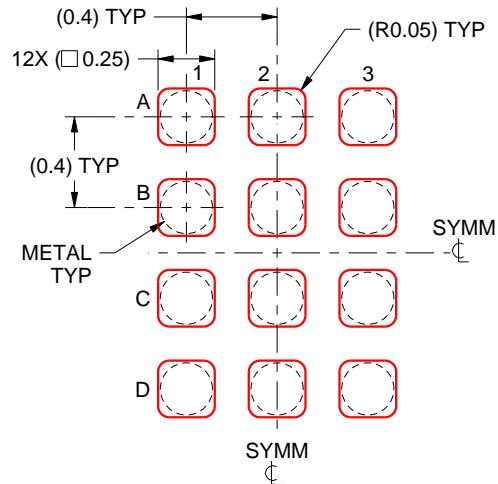
3. Final dimensions may vary due to manufacturing tolerance considerations and also routing constraints. For more information, see Texas Instruments literature number SNVA009 ([www.ti.com/lit/snva009](http://www.ti.com/lit/snva009)).

# EXAMPLE STENCIL DESIGN

YFF0012

DSBGA - 0.625 mm max height

DIE SIZE BALL GRID ARRAY



SOLDER PASTE EXAMPLE  
BASED ON 0.1 mm THICK STENCIL  
SCALE:30X

4222191/A 07/2015

NOTES: (continued)

4. Laser cutting apertures with trapezoidal walls and rounded corners may offer better paste release.



## 重要声明和免责声明

TI 提供技术和可靠性数据（包括数据表）、设计资源（包括参考设计）、应用或其他设计建议、网络工具、安全信息和其他资源，不保证没有瑕疵且不做任何明示或暗示的担保，包括但不限于对适销性、某特定用途方面的适用性或不侵犯任何第三方知识产权的暗示担保。

这些资源可供使用 TI 产品进行设计的熟练开发人员使用。您将自行承担以下全部责任：(1) 针对您的应用选择合适的 TI 产品，(2) 设计、验证并测试您的应用，(3) 确保您的应用满足相应标准以及任何其他安全、安保或其他要求。这些资源如有变更，恕不另行通知。TI 授权您仅可将这些资源用于研发本资源所述的 TI 产品的应用。严禁对这些资源进行其他复制或展示。您无权使用任何其他 TI 知识产权或任何第三方知识产权。您应全额赔偿因在这些资源的使用中对 TI 及其代表造成的任何索赔、损害、成本、损失和债务，TI 对此概不负责。

TI 提供的产品受 TI 的销售条款 (<https://www.ti.com.cn/zh-cn/legal/termsofsale.html>) 或 [ti.com.cn](https://www.ti.com.cn) 上其他适用条款/TI 产品随附的其他适用条款的约束。TI 提供这些资源并不会扩展或以其他方式更改 TI 针对 TI 产品发布的适用的担保或担保免责声明。

邮寄地址：上海市浦东新区世纪大道 1568 号中建大厦 32 楼，邮政编码：200122  
Copyright © 2021 德州仪器半导体技术（上海）有限公司