

TLC2274-HT 高级 LinCMOS™ 轨到轨运算放大器

1 特性

- 符合汽车应用要求
- 符合 AEC-Q100 标准
- 输出摆幅包括两个电源轨
- 低噪声 $f = 1\text{kHz}$ 时典型值为 $9\text{nV}/\sqrt{\text{Hz}}$
- 低输入偏置电流：典型值 1pA
- 完全符合单电源及分离电源操作的要求
- 共模输入电压范围包括负轨
- 高增益带宽：典型值 2.2MHz
- 高转换率：典型值 $3.6\text{V}/\mu\text{s}$
- $T_A = 25^\circ\text{C}$ 时低输入偏移电压最大为 $2500\mu\text{V}$
- 包含宏观模型

2 应用

- 支持极限温度应用：
 - 受控基线
 - 同一组装和测试场所
 - 同一制造场所
 - 在极限 (-40°C 至 150°C) 温度范围内可用 ⁽¹⁾
 - 延长的产品生命周期
 - 延长的产品变更通知
 - 产品可追溯性
 - 德州仪器 (TI) 高温产品利用高度优化的硅 (芯片) 解决方案, 通过设计和制造工艺方面的改进, 能够在广泛的温度范围内最大限度提升性能。所有器件在最高额定温度下均可连续正常运行 1000 小时。

(1) 可定制工作温度范围

3 说明

TLC2274 是一款由德州仪器 (TI) 生产的四通道运算放大器。此器件在单电源或分离电源应用中表现出优异的轨到轨输出性能, 能够进一步扩大动态范围。

TLC2274 带宽为 2MHz , 转换率为 $3\text{V}/\mu\text{s}$, 适用于高速应用。这些器件能够提供出色的交流性能, 其噪声、输入偏移电压和功耗均低于现有 CMOS 运算放大器。TLC2274 的电压噪声为 $9\text{nV}/\sqrt{\text{Hz}}$, 是竞争对手解决方案的二分之一。

TLC2274 放大器具有高输入阻抗和低噪声特性, 是用于高阻抗源 (如压电传感器) 小信号调节的绝佳选择。该器件属于低功耗级别, 因此手持式监控和遥感应用中运转良好。此外, 该器件的单电源或分离电源具有轨到轨输出特性, 是与模数转换器 (ADC) 对接的理想选择。该器件系列的额定工作电压为 5V 或 $\pm 5\text{V}$ 。

它可提供更大的输出动态范围, 更低的电压噪声和更小的输入偏移电压。凭借这一系列增强特性, 该器件能够用于更广泛的应用。

器件信息⁽¹⁾

器件型号	封装	封装尺寸 (标称值)
TLC2274-HT	TSSOP (14)	6.60mm x 5.10mm

(1) 要了解所有可用封装, 请见数据表末尾的可订购产品附录。

最大峰峰值输出电压 与电源电压

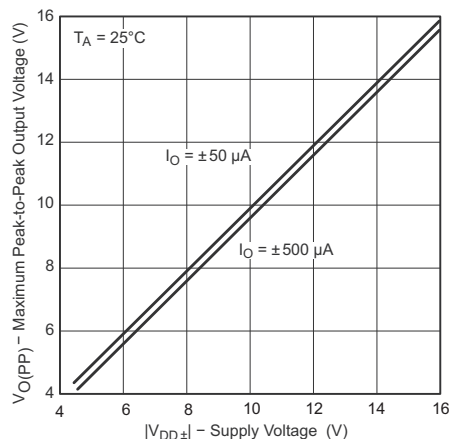

目录

1	特性	1	7.1	Overview	17
2	应用	1	7.2	Functional Block Diagram	17
3	说明	1	7.3	Feature Description	17
4	修订历史记录	2	8	Application and Implementation	18
5	Pin Configuration and Functions	3	8.1	Application Information.....	18
6	Specifications	4	8.2	Typical Application	19
6.1	Absolute Maximum Ratings	4	9	Power Supply Recommendations	22
6.2	ESD Ratings.....	4	10	Layout	22
6.3	Recommended Operating Conditions	4	10.1	Layout Guidelines	22
6.4	Thermal Information	4	10.2	Layout Example	22
6.5	Electrical Characteristics, $V_{DD} = 5\text{ V}$	5	11	器件和文档支持	23
6.6	Operating Characteristics, $V_{DD} = 5\text{ V}$	6	11.1	商标.....	23
6.7	Electrical Characteristics, $V_{DD\pm} = \pm 5\text{ V}$	7	11.2	静电放电警告.....	23
6.8	Operating Characteristics, $V_{DD\pm} = \pm 5\text{ V}$	8	11.3	术语表	23
6.9	Typical Characteristics	10	12	机械封装和可订购信息	23
7	Detailed Description	17			

4 修订历史记录

日期	修订版本	注释
2015 年 1 月	*	最初发布。

5 Pin Configuration and Functions

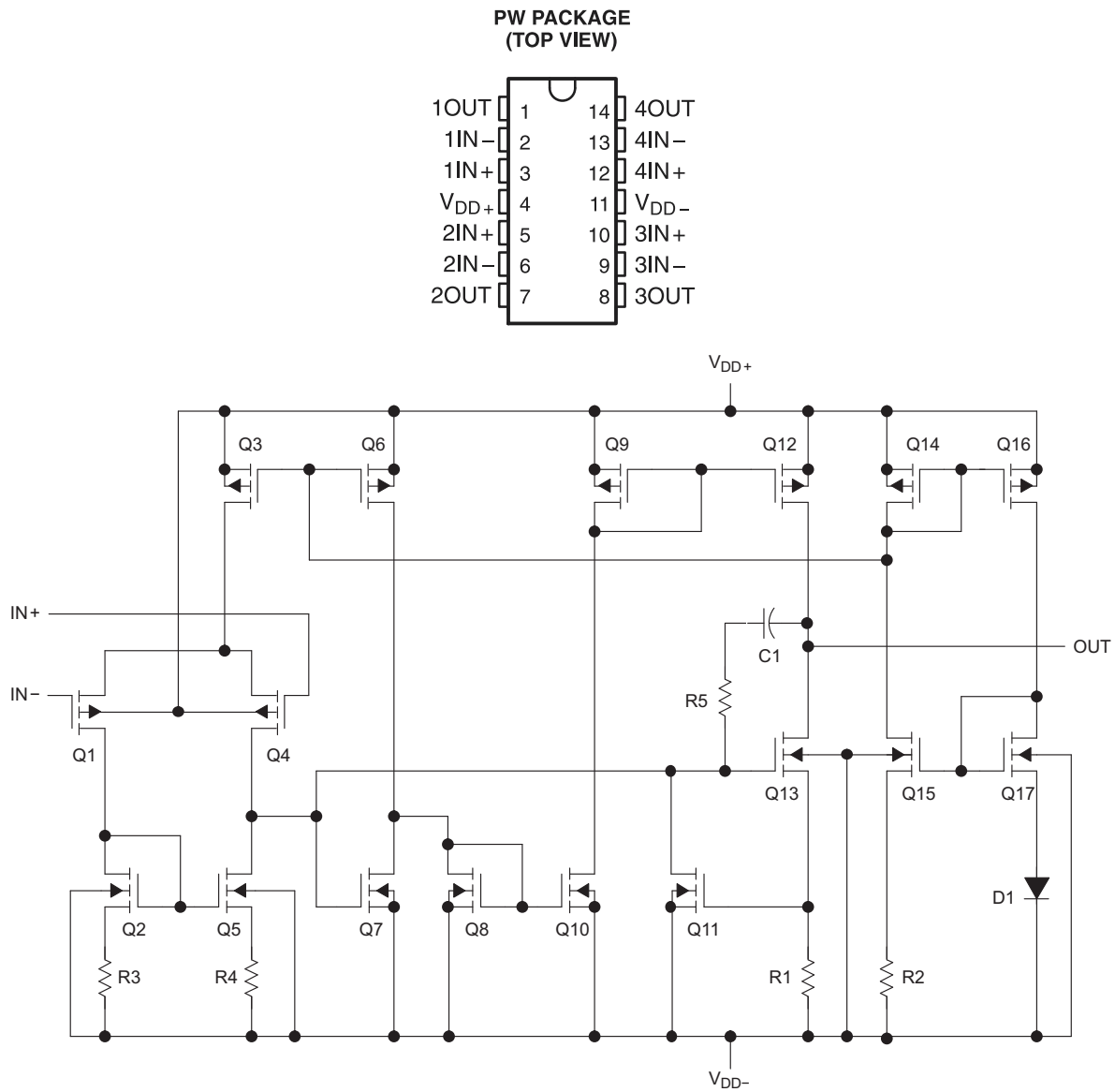

Figure 1. Equivalent Schematic (Each Amplifier)

Table 1. Actual Device Component Count⁽¹⁾

COMPONENT	TLC2274
Transistors	76
Resistors	52
Diodes	18
Capacitors	6

(1) Includes both amplifiers and all ESD, bias, and trim circuitry

6 Specifications

6.1 Absolute Maximum Ratings⁽¹⁾

over operating free-air temperature range (unless otherwise noted)

		MIN	MAX	UNIT	
V_{DD+}	Supply voltage ⁽²⁾		8	V	
V_{DD-}	Supply voltage ⁽²⁾		-8	V	
V_{ID}	Differential input voltage ⁽³⁾	-16	16	V	
V_I	Input voltage ⁽²⁾	Any input	$V_{DD-} - 0.3$	V_{DD+}	V
I_I	Input current	Any input	-5	5	mA
I_O	Output current		-50	50	mA
	Total current into V_{DD+}		-50	50	mA
	Total current out of V_{DD-}		-50	50	mA
	Duration of short-circuit current at (or below) 25°C ⁽⁴⁾		Unlimited		
T_A	Operating free-air temperature	-40	150	°C	
	Lead temperature 1.6 mm (1/16 inch) from case for 10 s		260	°C	
T_{stg}	Storage temperature	-65	150	°C	

- (1) Stresses beyond those listed under “absolute maximum ratings” may cause permanent damage to the device. These are stress ratings only, and functional operation of the device at these or any other conditions beyond those indicated under “recommended operating conditions” is not implied. Exposure to absolute-maximum-rated conditions for extended periods may affect device reliability.
- (2) All voltage values, except differential voltages, are with respect to the midpoint between V_{DD+} and V_{DD-} .
- (3) Differential voltages are at I_{N+} with respect to I_{N-} . Excessive current will flow if input is brought below $V_{DD-} - 0.3$ V.
- (4) The output may be shorted to either supply. Temperature and/or supply voltages must be limited to ensure that the maximum dissipation rating is not exceeded.

6.2 ESD Ratings

			VALUE	UNIT
$V_{(ESD)}$	Electrostatic discharge	Human-body model (HBM), per AEC Q100-002 ⁽¹⁾	±2500	V
		Charged-device model (CDM), per AEC Q100-011	All pins	

- (1) AEC Q100-002 indicates that HBM stressing shall be in accordance with the ANSI/ESDA/JEDEC JS-001 specification.

6.3 Recommended Operating Conditions

over operating free-air temperature range (unless otherwise noted)

		MIN	MAX	UNIT
$V_{DD±}$	Supply voltage	±2.2	±8	V
V_I	Input voltage	V_{DD-}	$V_{DD+} - 1.5$	V
V_{IC}	Common-mode input voltage	V_{DD-}	$V_{DD+} - 1.5$	V
T_A	Operating free-air temperature	-40	150	°C

6.4 Thermal Information

THERMAL METRIC ⁽¹⁾		TLC2274	UNIT
		PW	
		14 PINS	
$R_{\theta JA}$	Junction-to-ambient thermal resistance	106.0	°C/W
$R_{\theta JC(top)}$	Junction-to-case (top) thermal resistance	35.5	
$R_{\theta JB}$	Junction-to-board thermal resistance	47.6	
Ψ_{JT}	Junction-to-top characterization parameter	2.4	
Ψ_{JB}	Junction-to-board characterization parameter	47.1	

- (1) For more information about traditional and new thermal metrics, see the *IC Package Thermal Metrics* application report, [SPRA953](#).

6.5 Electrical Characteristics, $V_{DD} = 5\text{ V}$

at specified free-air temperature, $V_{DD} = 5\text{ V}$ (unless otherwise noted)

PARAMETER		TEST CONDITIONS		T_A ⁽¹⁾	MIN	TYP	MAX	UNIT
V_{IO}	Input offset voltage	$V_{IC} = 0\text{ V},$ $V_O = 0\text{ V},$ $V_{DD\pm} = \pm 2.5\text{ V},$ $R_S = 50\ \Omega$		25°C		300	2500	μV
				Full range			3000	
αV_{IO}	Temperature coefficient of input offset voltage			25°C to 125°C		2		$\mu\text{V}/^\circ\text{C}$
	Input offset voltage long-term drift ⁽²⁾			25°C		0.002		$\mu\text{V}/\text{mo}$
I_{IO}	Input offset current			25°C		0.5	60	pA
				Full range			7000	
I_{IB}	Input bias current	25°C		1		pA		
		Full range						
V_{ICR}	Common-mode input voltage range	$R_S = 50\ \Omega$	$ V_{IO} \leq 5\text{ mV}$	25°C	0 to 4	-0.3 to 4.2	V	
				Full range	0 to 3.5			
V_{OH}	High-level output voltage			25°C		4.99	V	
				$I_{OH} = -20\ \mu\text{A}$	25°C	4.85		4.93
				$I_{OH} = -200\ \mu\text{A}$	Full range	4.84		
				$I_{OH} = -1\text{ mA}$	25°C	4.25		4.65
V_{OL}	Low-level output voltage			25°C		0.01	V	
				$V_{IC} = 2.5\text{ V},$ $I_{OL} = 50\ \mu\text{A}$	25°C	0.09		0.15
				$V_{IC} = 2.5\text{ V},$ $I_{OL} = 500\ \mu\text{A}$	Full range			0.16
				$V_{IC} = 2.5\text{ V},$ $I_{OL} = 5\text{ mA}$	25°C	0.9		1.5
A_{VD}	Large-signal differential voltage amplification	$V_{IC} = 2.5\text{ V},$ $V_O = 1\text{ V to }4\text{ V},$		$R_L = 10\text{ k}\Omega$ ⁽³⁾	25°C	10	35	V/mV
				Full range		8		
				$R_L = 1\text{ M}\Omega$ ⁽³⁾	25°C		175	
r_{id}	Differential input resistance			25°C		10^{12}	Ω	
r_i	Common-mode input resistance			25°C		10^{12}	Ω	
C_i	Common-mode input capacitance	$f = 10\text{ kHz},$	N package	25°C		8	pF	
Z_o	Closed-loop output impedance	$f = 1\text{ MHz},$	$A_V = 10$	25°C		140	Ω	
CMRR	Common-mode rejection ratio	$V_{IC} = 0\text{ V to }2.7\text{ V},$ $V_O = 2.5\text{ V},$		25°C	70	75	dB	
				Full range	69			
k_{SVR}	Supply voltage rejection ratio ($\Delta V_{DD}/\Delta V_{IO}$)	$V_{DD} = 4.4\text{ V to }16\text{ V},$ $V_{IC} = V_{DD}/2,$ No load		25°C	80	95	dB	
				Full range	80			
I_{DD}	Supply current	$V_O = 2.5\text{ V},$ No load		25°C		4.4	6	mA
				Full range			6	

(1) Full range is -40°C to 150°C for this part.

(2) Typical values are based on the input offset voltage shift observed through 168 hours of operating life test at $T_A = 150^\circ\text{C}$ extrapolated to $T_A = 25^\circ\text{C}$ using the Arrhenius equation and assuming an activation energy of 0.96 eV.

(3) Referenced to 2.5 V

6.6 Operating Characteristics, $V_{DD} = 5\text{ V}$

 at specified free-air temperature, $V_{DD} = 5\text{ V}$ (unless otherwise noted)

PARAMETER		TEST CONDITIONS		$T_A^{(1)}$	MIN	TYP	MAX	UNIT
SR	Slew rate at unity gain	$V_O = 0.5\text{ V to } 2.5\text{ V},$ $C_L = 100\text{ pF}^{(2)}$		$R_L = 10\text{ k}\Omega^{(2)}$	25°C	2.3	3.6	V/ μs
					Full range	1.2		
V_n	Equivalent input noise voltage	$f = 10\text{ Hz}$		25°C	50		nV/ $\sqrt{\text{Hz}}$	
		$f = 1\text{ kHz}$		25°C	9			
$V_{N(pp)}$	Peak-to-peak equivalent input noise voltage	$f = 0.1\text{ to } 1\text{ Hz}$		25°C	1		μV	
		$f = 0.1\text{ to } 10\text{ Hz}$		25°C	1.4			
I_n	Equivalent input noise current			25°C	0.6		fA/ $\sqrt{\text{Hz}}$	
THD + N	Total harmonic distortion plus noise	$V_O = 0.5\text{ V to } 2.5\text{ V},$ $R_L = 10\text{ k}\Omega,$ $f = 20\text{ kHz}^{(2)}$		25°C	$A_V = 1$		0.0013%	
					$A_V = 10$		0.004%	
					$A_V = 100$		0.03%	
Gain-bandwidth product		$f = 10\text{ kHz},$ $C_L = 100\text{ pF}^{(2)}$	$R_L = 10\text{ k}\Omega^{(2)}$	25°C	2.18		MHz	
B_{OM}	Maximum output-swing bandwidth	$V_{O(pp)} = 2\text{ V},$ $R_L = 10\text{ k}\Omega^{(2)}$	$A_V = 1,$ $C_L = 100\text{ pF}^{(2)}$	25°C	1		MHz	
t_s	Settling time	$A_V = -1,$ Step = 0.5V to 2.5V, $R_L = 10\text{ k}\Omega^{(2)}$ $C_L = 100\text{ pF}^{(2)}$		25°C	To 0.1%		1.5	μs
					To 0.01%		2.6	
ϕ_m	Phase margin at unity gain	$R_L = 10\text{ k}\Omega$	$C_L = 100\text{ pF}^{(2)}$	25°C	50°			
	Gain margin			25°C	10		dB	

 (1) Full range is -40°C to 150°C for this part.

(2) Referenced to 2.5 V

6.7 Electrical Characteristics, $V_{DD\pm} = \pm 5\text{ V}$

at specified free-air temperature, $V_{DD\pm} = \pm 5\text{ V}$ (unless otherwise noted)

PARAMETER		TEST CONDITIONS		$T_A^{(1)}$	MIN	TYP	MAX	UNIT
V_{IO}	Input offset voltage	$V_{IC} = 0\text{ V},$ $R_S = 50\ \Omega$ $V_O = 0\text{ V}$		25°C		300	2500	μV
				Full range			3000	
αV_{IO}	Temperature coefficient of input offset voltage			25°C to 125°C		2		$\mu\text{V}/^\circ\text{C}$
				25°C		0.002		$\mu\text{V}/\text{mo}$
I_{IO}	Input offset current	25°C		0.5	60	pA		
		Full range			7000			
I_{IB}	Input bias current	25°C		1	60	pA		
		Full range			7000			
V_{ICR}	Common-mode input voltage range	$R_S = 50\ \Omega$	$ V_{IO} \leq 5\text{ mV}$	25°C	-5 to 4	-5.3 to 4.2		V
				Full range		-5 to 3.5		
V_{OM+}	Maximum positive peak output voltage			25°C		4.99		V
				25°C		4.85	4.93	
				Full range		4.84		
				25°C		4.25	4.65	
V_{OM-}	Maximum negative peak output voltage			25°C		-4.99		V
				25°C		-4.85	-4.91	
				Full range		-4.85		
				25°C		-3.5	-4.1	
A_{VD}	Large-signal differential voltage amplification	$V_O = \pm 4\text{ V},$	$R_L = 10\text{ k}\Omega$	25°C	20	50		V/mV
				Full range	16			
			$R_L = 1\text{ M}\Omega$	25°C		300		
				Full range				
r_{id}	Differential input resistance			25°C		10^{12}	Ω	
r_i	Common-mode input resistance			25°C		10^{12}	Ω	
c_i	Common-mode input capacitance	$f = 10\text{ kHz},$	N package	25°C		8	pF	
z_o	Closed-loop output impedance	$f = 1\text{ MHz},$	$AV = 10$	25°C		130	Ω	
CMRR	Common-mode rejection ratio	$V_{IC} = -5\text{ V to } 2.7\text{ V},$ $V_O = 0\text{ V},$ $R_S = 50\ \Omega$		25°C	75	80		dB
				Full range	73			
k_{SVR}	Supply voltage rejection ratio ($\Delta V_{DD}/\Delta V_{IO}$)	$V_{DD} = \pm 2.2\text{ V to } \pm 8\text{ V},$ $V_{IC} = 0\text{ V},$ No load		25°C	80	95		dB
				Full range	80			
I_{DD}	Supply current	$V_O = 0\text{ V},$ No load		25°C		4.4	6	mA
				Full range			6	

(1) Full range is -40°C to 150°C for this part.

(2) Typical values are based on the input offset voltage shift observed through 168 hours of operating life test at $T_A = 150^\circ\text{C}$ extrapolated to $T_A = 25^\circ\text{C}$ using the Arrhenius equation and assuming an activation energy of 0.96 eV.

6.8 Operating Characteristics, $V_{DD\pm} = \pm 5\text{ V}$

at specified free-air temperature, $V_{DD\pm} = \pm 5\text{ V}$ (unless otherwise noted)

PARAMETER		TEST CONDITIONS		$T_A^{(1)}$	MIN	TYP	MAX	UNIT
SR	Slew rate at unity gain	$V_O = \pm 2.3\text{ V}$, $R_L = 10\text{ k}\Omega$	$C_L = 100\text{ pF}$	25°C	2.3	3.6		V/ μs
				Full range	1.2			
V_n	Equivalent input noise voltage			25°C		50		nV/ $\sqrt{\text{Hz}}$
				25°C		9		
$V_{N(pp)}$	Peak-to-peak equivalent input noise voltage			25°C		1		μV
				25°C		1.4		
I_n	Equivalent input noise current			25°C		0.6		fA/ $\sqrt{\text{Hz}}$
THD + N	Total harmonic distortion plus noise	$V_O = \pm 2.3\text{ V}$, $f = 20\text{ kHz}$, $R_L = 10\text{ k}\Omega$		25°C	0.0011%			
					0.004%			
					0.03%			
	Gain-bandwidth product	$f = 10\text{ kHz}$, $C_L = 100\text{ pF}$	$R_L = 10\text{ k}\Omega$	25°C		2.25		MHz
B_{OM}	Maximum output-swing bandwidth	$V_{O(pp)} = 4.6\text{ V}$, $R_L = 10\text{ k}\Omega$	$A_V = 1$, $C_L = 100\text{ pF}$	25°C		0.54		MHz
t_s	Settling time	$A_V = -1$, Step = -2.3 V to 2.3 V, $R_L = 10\text{ k}\Omega$, $C_L = 100\text{ pF}$		25°C	1.5			μs
					3.2			
Φ_m	Phase margin at unity gain	$R_L = 10\text{ k}\Omega$,	$C_L = 100\text{ pF}$	25°C		52°		
	Gain margin			25°C		10		dB

(1) Full range is -40°C to 150°C for this part.

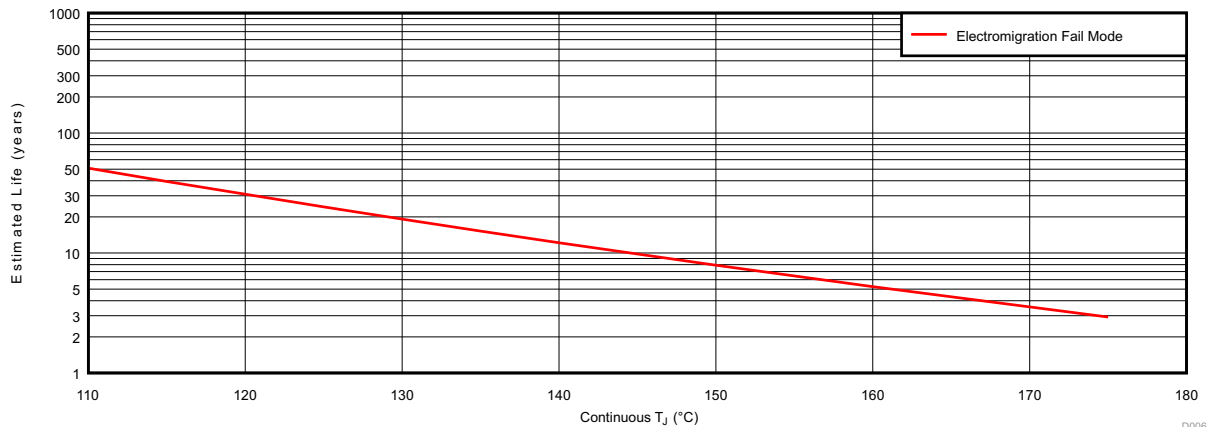

- A. See data sheet for *Absolute Maximum Ratings* and minimum *Recommended Operating Conditions*.
- B. Silicon operating life design goal is 10 years at 105°C junction temperature (does not include package interconnect life).

Figure 2. TLC2274EPWRQ1 Operating Life Derating Chart

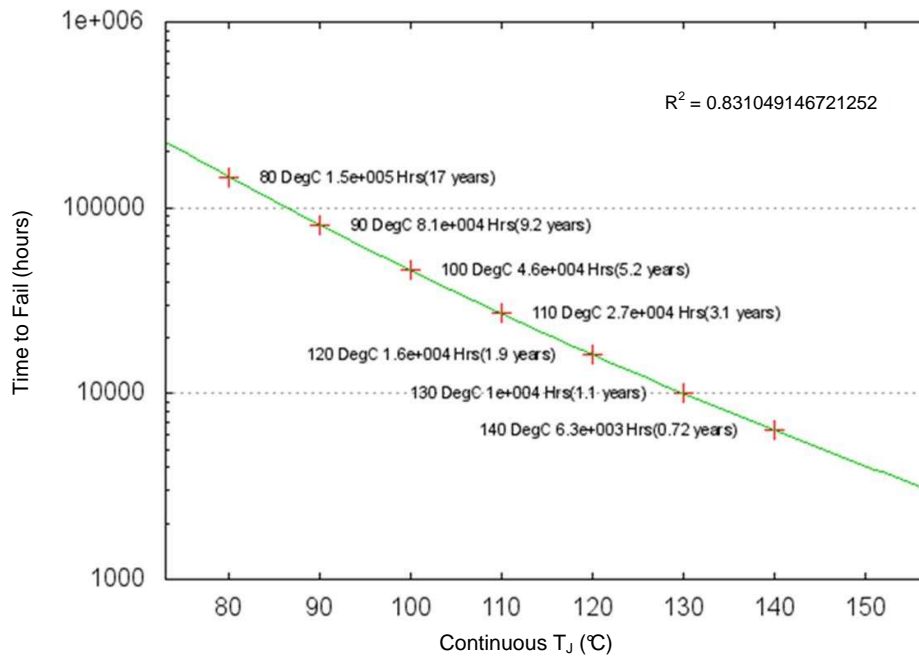

Figure 3. Estimated Wire Bond Life

6.9 Typical Characteristics

Data at high and low temperatures are applicable only within the rated operating free-air temperature ranges of the devices.

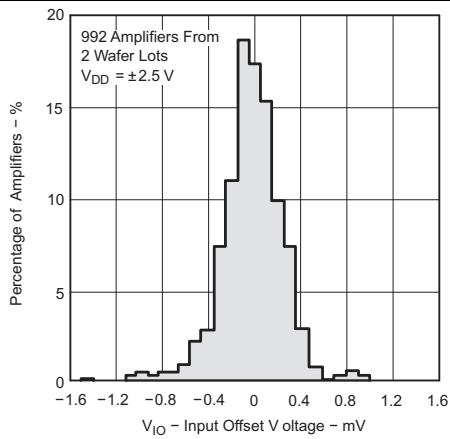

Figure 4. Distribution of TLC2274 Input Offset Voltage

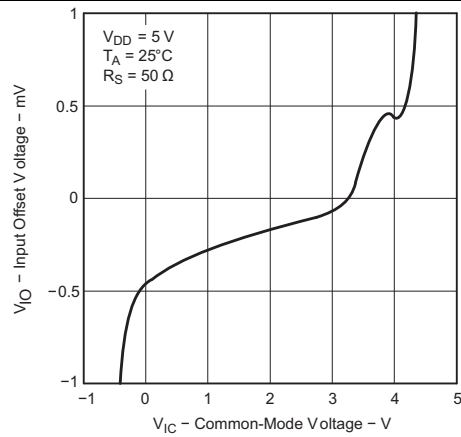

Figure 5. Input Offset Voltage vs Common-Mode Voltage

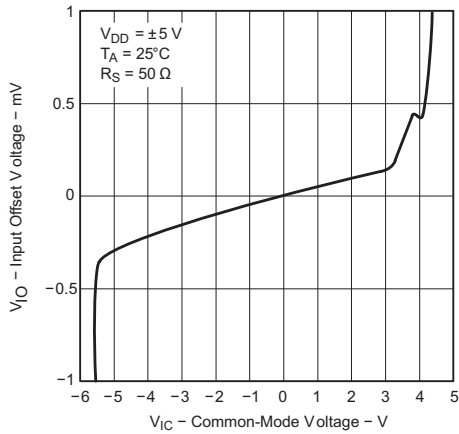

Figure 6. Input Offset Voltage vs Common-Mode Voltage

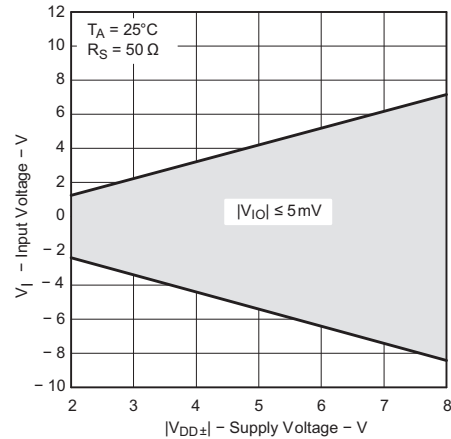

Figure 7. Input Voltage vs Supply Voltage

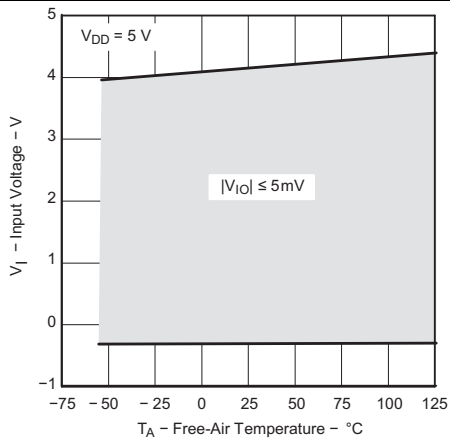

Figure 8. Input Voltage vs Free-Air Temperature

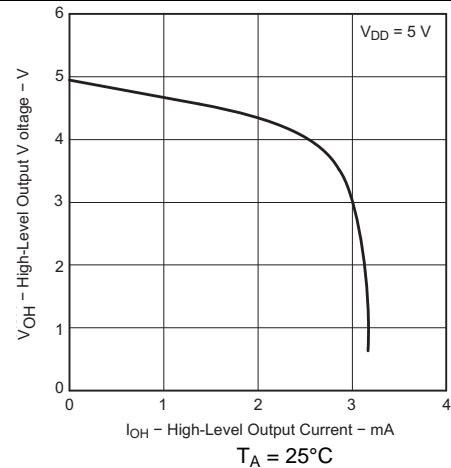

Figure 9. High-Level Output Voltage vs High-Level Output Current

Typical Characteristics (continued)

Data at high and low temperatures are applicable only within the rated operating free-air temperature ranges of the devices.

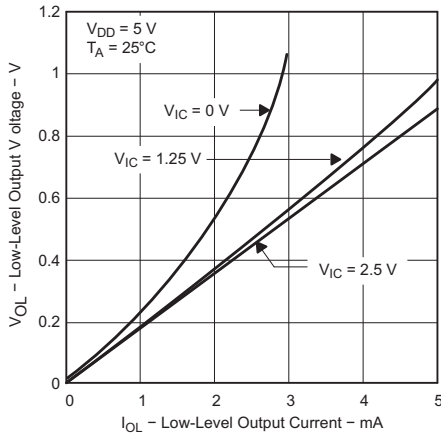

Figure 10. Low-Level Output Voltage vs Low-Level Output Current

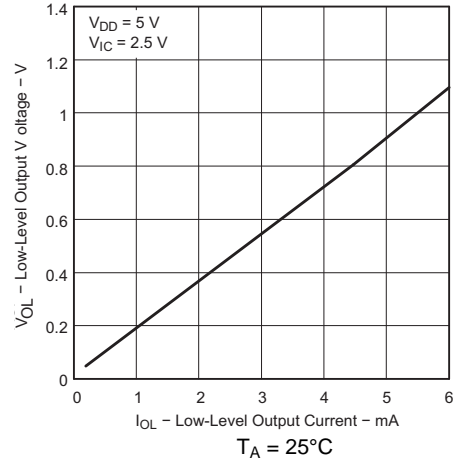

Figure 11. Low-Level Output Voltage vs Low-Level Output Current

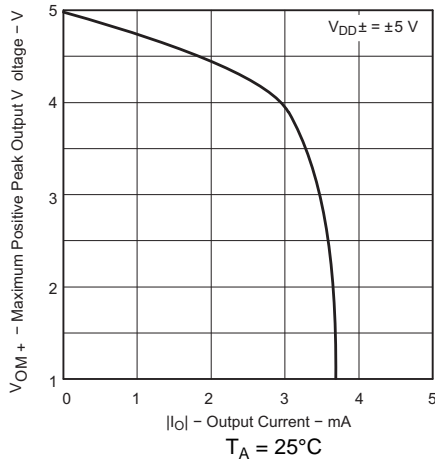

Figure 12. Maximum Positive Peak Output Voltage vs Output Current

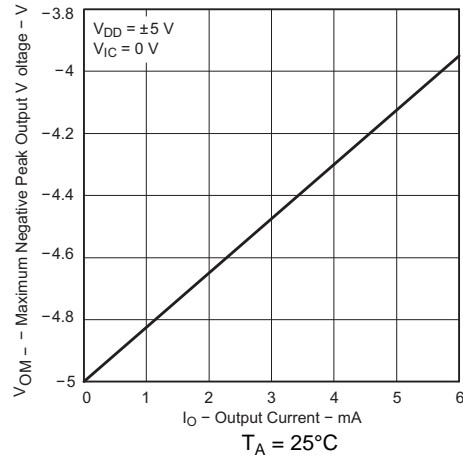

Figure 13. Maximum Negative Peak Output Voltage vs Output Current

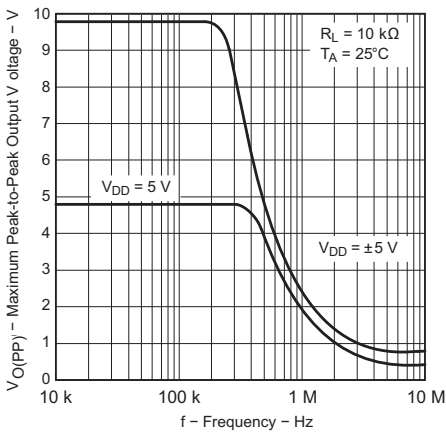

Figure 14. Maximum Peak-to-Peak Output Voltage vs Frequency

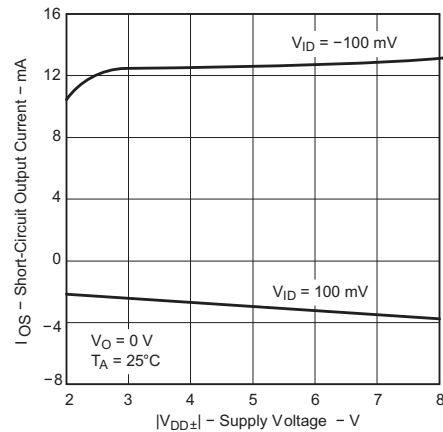

Figure 15. Short-Circuit Output Current vs Supply Voltage

Typical Characteristics (continued)

Data at high and low temperatures are applicable only within the rated operating free-air temperature ranges of the devices.

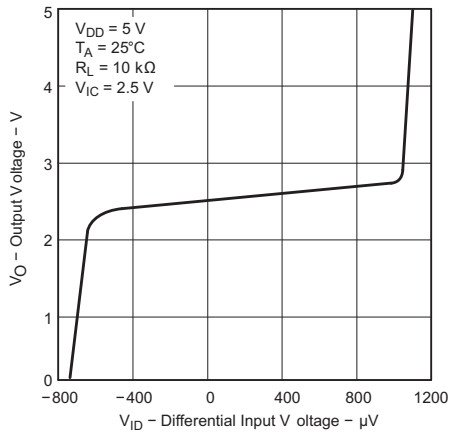

Figure 16. Output Voltage vs Differential Input Voltage

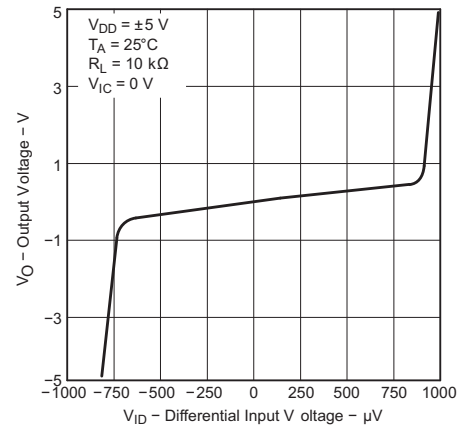

Figure 17. Output Voltage vs Differential Input Voltage

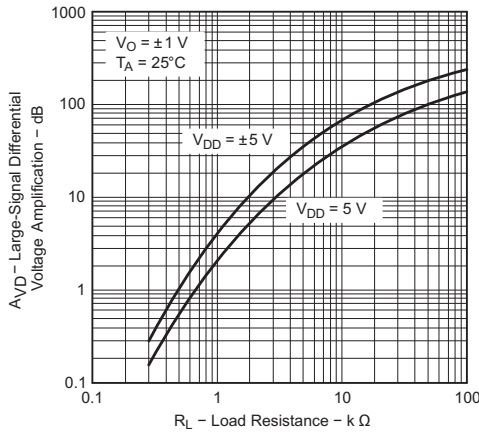

Figure 18. Large-Signal Differential Voltage Amplification vs Load Resistance

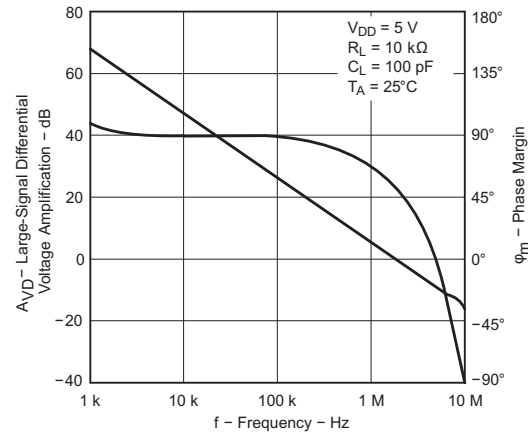

Figure 19. Large-Signal Differential Voltage Amplification and Phase Margin vs Frequency

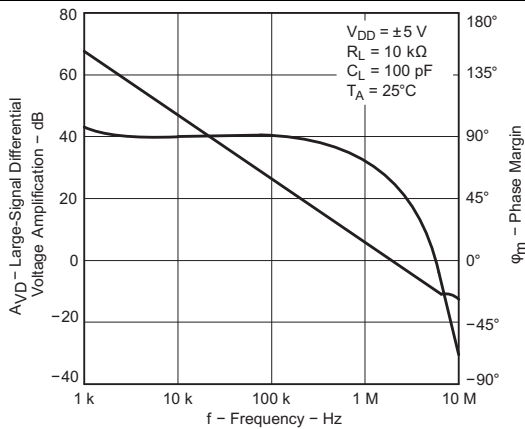

Figure 20. Large-Signal Differential Voltage Amplification and Phase Margin vs Frequency

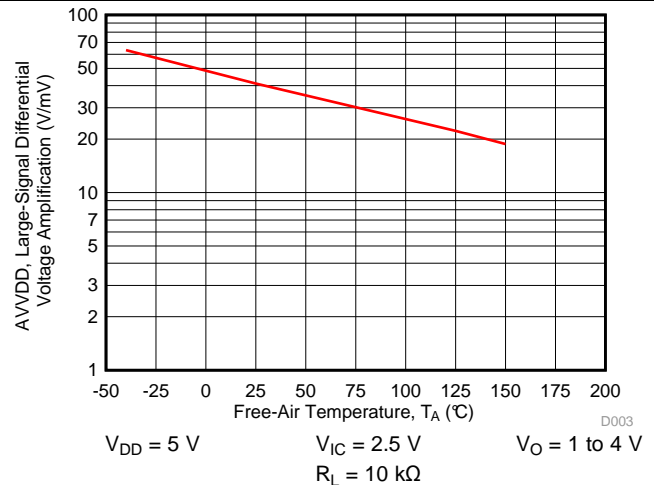

Figure 21. Large-Signal Differential Voltage Amplification vs Free-Air Temperature

Typical Characteristics (continued)

Data at high and low temperatures are applicable only within the rated operating free-air temperature ranges of the devices.

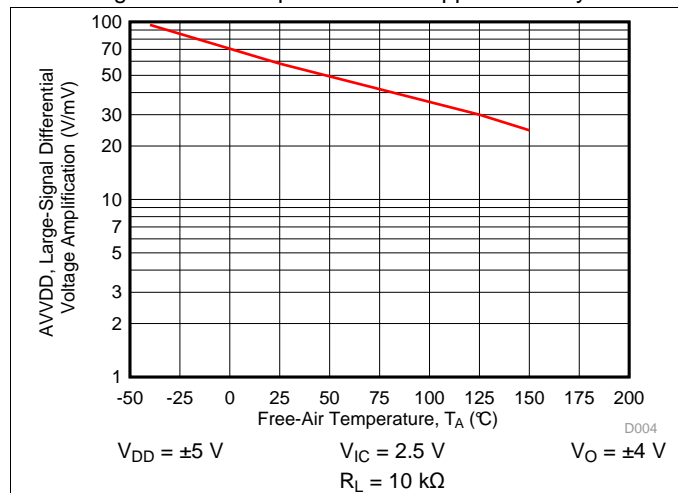

Figure 22. Large-Signal Differential Voltage Amplification vs Free-Air Temperature

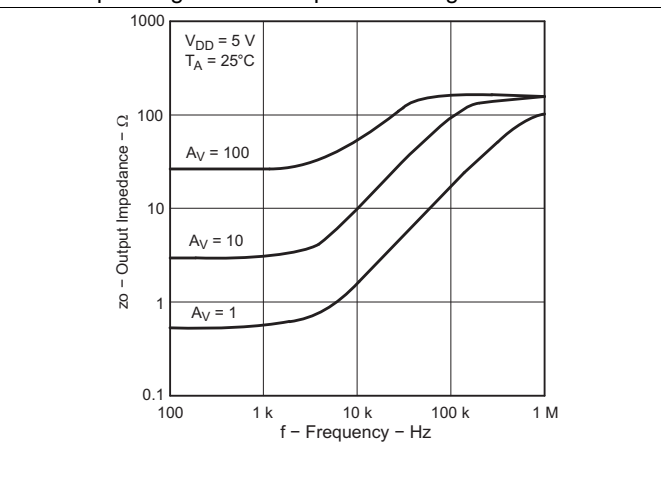

Figure 23. Output Impedance vs Frequency

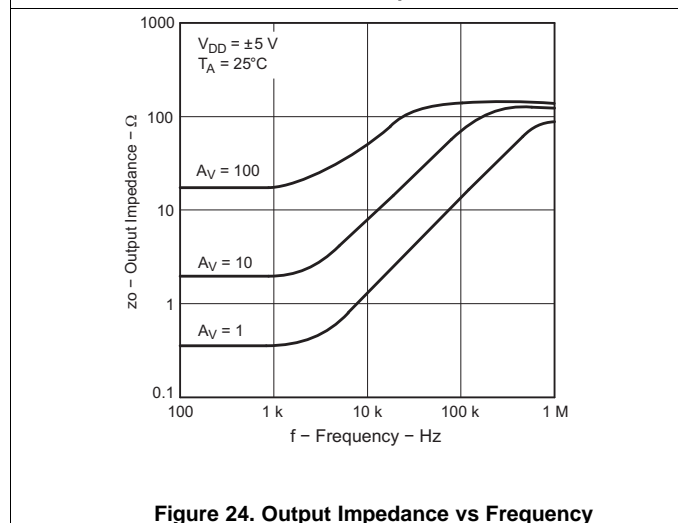

Figure 24. Output Impedance vs Frequency

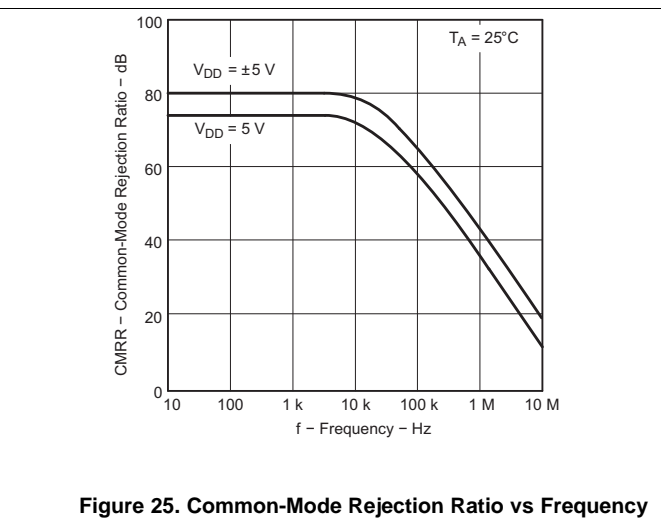

Figure 25. Common-Mode Rejection Ratio vs Frequency

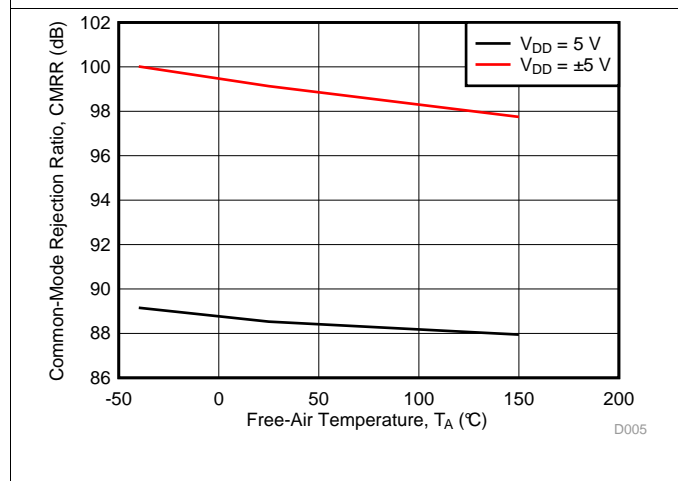

Figure 26. Common-Mode Rejection Ratio vs Free-Air Temperature

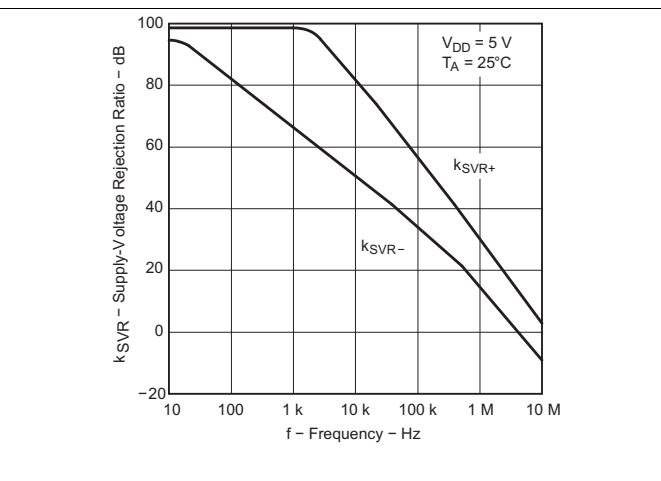

Figure 27. Supply-Voltage Rejection Ratio vs Frequency

Typical Characteristics (continued)

Data at high and low temperatures are applicable only within the rated operating free-air temperature ranges of the devices.

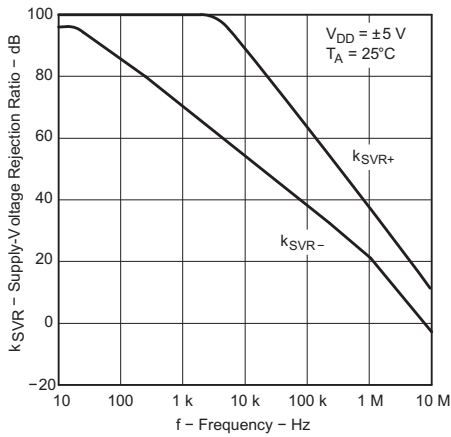

Figure 28. Supply-Voltage Rejection Ratio vs Frequency

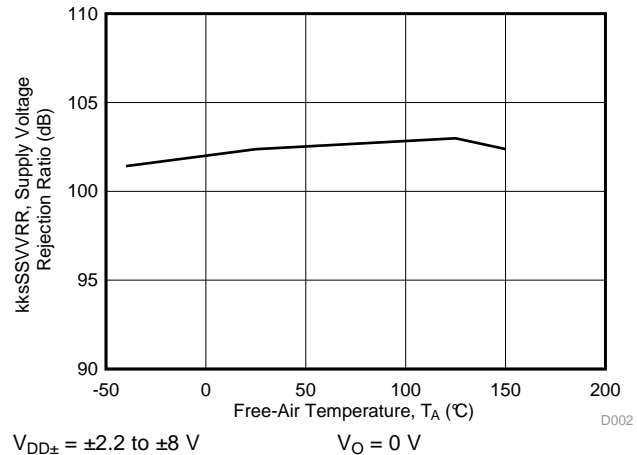

Figure 29. Supply-Voltage Rejection Ratio vs Free-Air Temperature

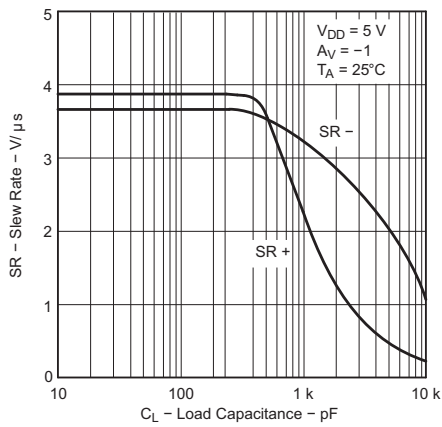

Figure 30. Slew Rate vs Load Capacitance

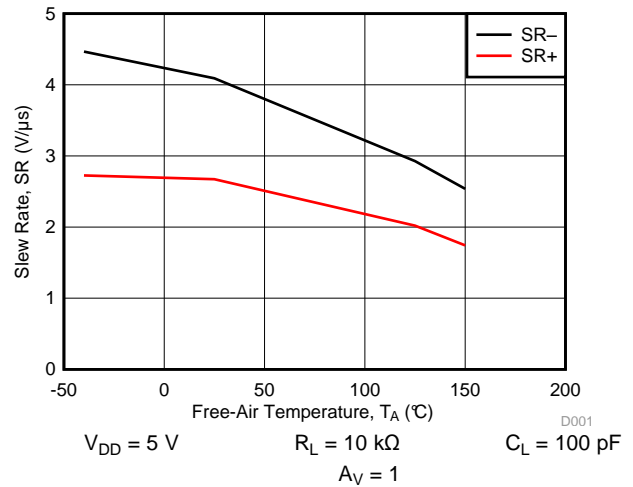

Figure 31. Slew Rate vs Free-Air Temperature

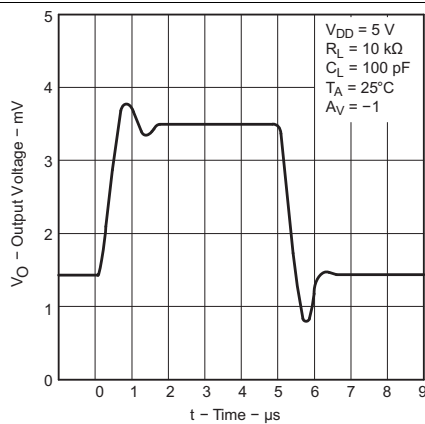

Figure 32. Inverting Large-Signal Pulse Response

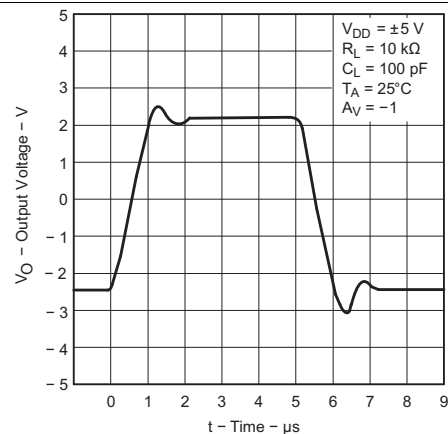

Figure 33. Inverting Large-Signal Pulse Response

Typical Characteristics (continued)

Data at high and low temperatures are applicable only within the rated operating free-air temperature ranges of the devices.

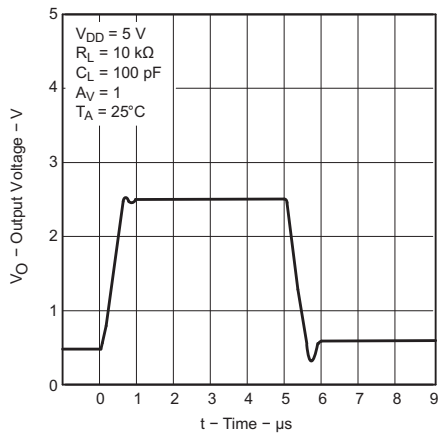

Figure 34. Voltage-Follower Large-Signal Pulse Response

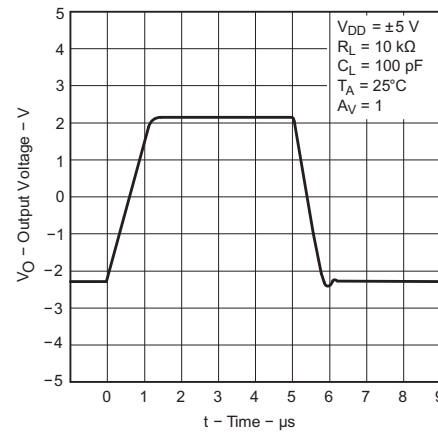

Figure 35. Voltage-Follower Large-Signal Pulse Response

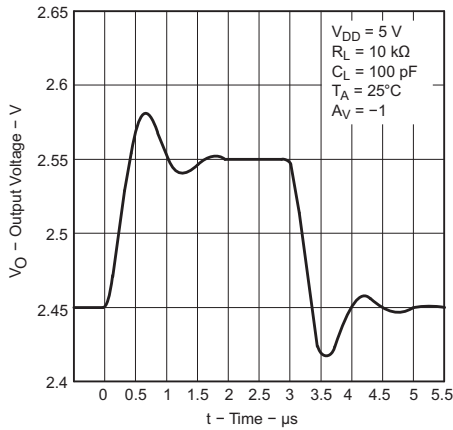

Figure 36. Inverting Small-Signal Pulse Response

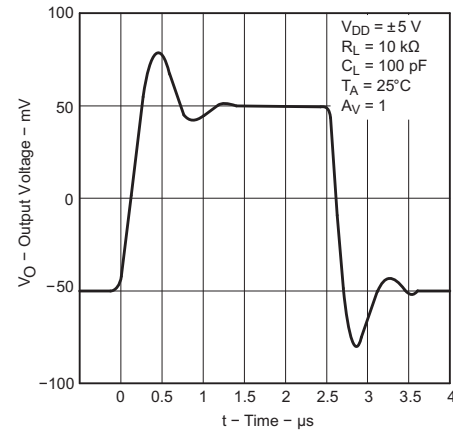

Figure 37. Inverting Small-Signal Pulse Response

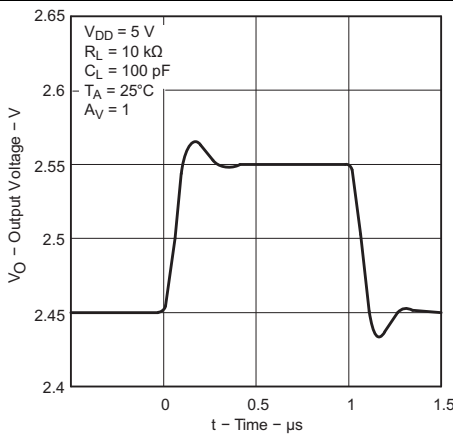

Figure 38. Voltage-Follower Small-Signal Pulse Response

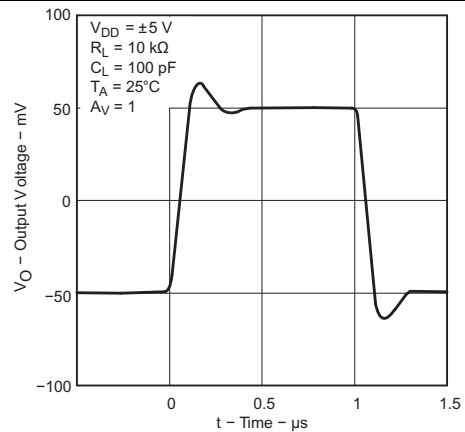

Figure 39. Voltage-Follower Small-Signal Pulse Response

Typical Characteristics (continued)

Data at high and low temperatures are applicable only within the rated operating free-air temperature ranges of the devices.

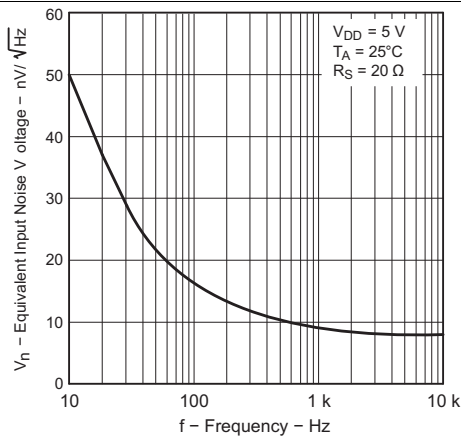

Figure 40. Equivalent Input Noise Voltage vs Frequency

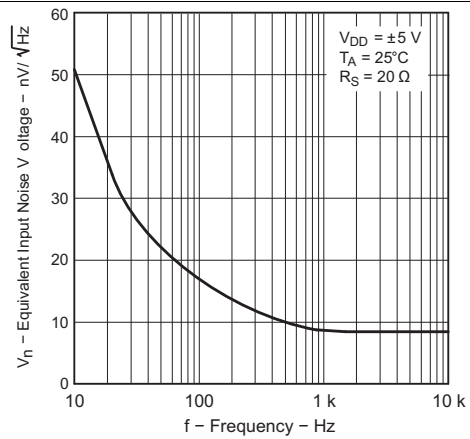

Figure 41. Equivalent Input Noise Voltage vs Frequency

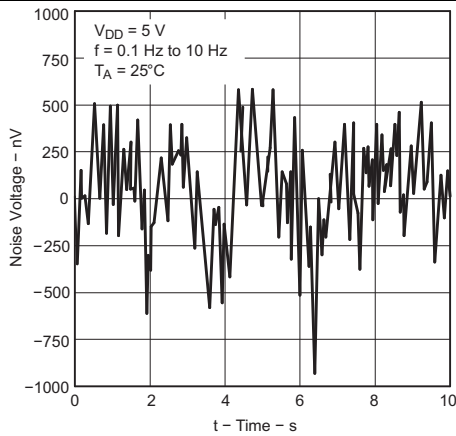

Figure 42. Noise Voltage Over a 10-s Period

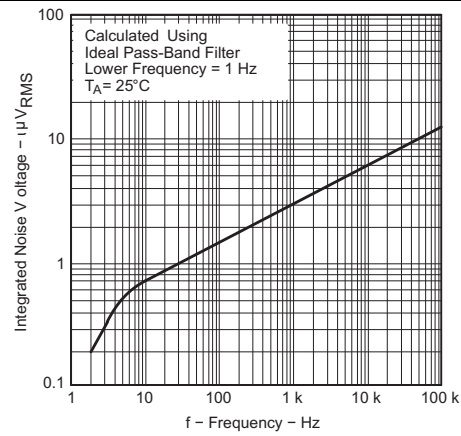

Figure 43. Integrated Noise Voltage vs Frequency

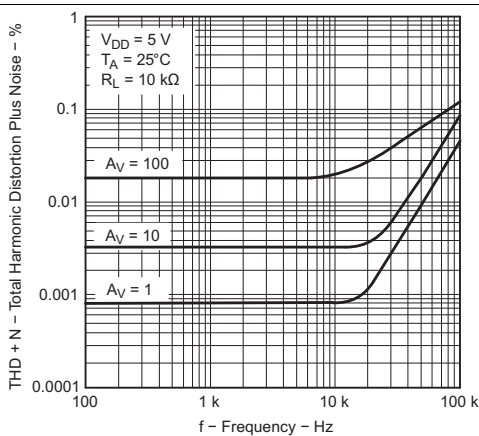

Figure 44. Total Harmonic Distortion Plus Noise vs Frequency

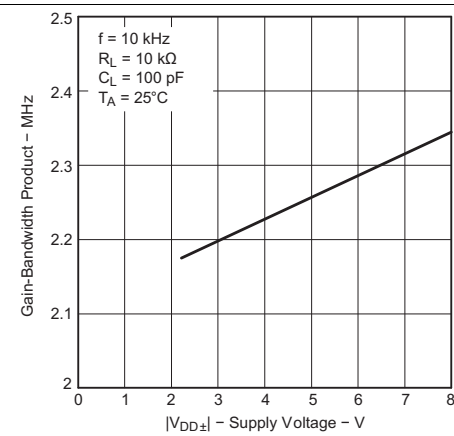

Figure 45. Gain-Bandwidth Product vs Supply Voltage

7 Detailed Description

7.1 Overview

The TLC2274 device exhibits rail-to-rail output performance for increased dynamic range in single- or split - supply applications. These device offers comparable ac performance while having better noise, input offset voltage and power dissipation than existing CMOS operational amplifiers. The TLC2274 device, exhibiting high input impedance and low noise, is excellent for small signal conditioning for high-impedance sources, such as piezoelectric transducers. It offers increased output dynamic range, lower noise voltage, and lower input offset voltage. This enhanced feature set allows the device to be used in a wider range of applications.

7.2 Functional Block Diagram

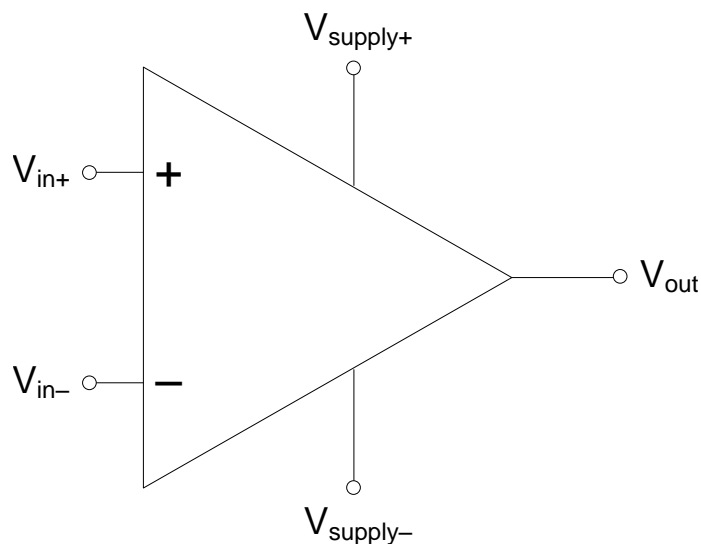

7.3 Feature Description

These devices use the Texas Instruments silicon gate LinCMOS™ process, giving them stable input offset voltages, very high input impedances, and extremely low input offset and bias currents. In addition, the rail-to-rail output feature with single- or split-supplies, makes this device a great choice when interfacing with analog-to-digital converters (ADCs).

8 Application and Implementation

NOTE

Information in the following applications sections is not part of the TI component specification, and TI does not warrant its accuracy or completeness. TI's customers are responsible for determining suitability of components for their purposes. Customers should validate and test their design implementation to confirm system functionality.

8.1 Application Information

8.1.1 Macromodel Information

Macromodel information provided was derived using Microsim Parts, the model generation software used with Microsim PSpice. The Boyle macromodel ⁽¹⁾ and subcircuit in [Figure 46](#) are generated using the TLC227x typical electrical and operating characteristics at $T_A = 25^\circ\text{C}$. Using this information, output simulations of the following key parameters can be generated to a tolerance of 20% (in most cases):

- Maximum positive output voltage swing
- Maximum negative output voltage swing
- Slew rate
- Quiescent power dissipation
- Input bias current
- Open-loop voltage amplification
- Unity-gain frequency
- Common-mode rejection ratio
- Phase margin
- DC output resistance
- AC output resistance
- Short-circuit output current limit

(1) G. R. Boyle, B. M. Cohn, D. O. Pederson, and J. E. Solomon, "Macromodeling of Integrated Circuit Operational Amplifiers", IEEE Journal of Solid-State Circuits, SC-9, 353 (1974).

Application Information (continued)

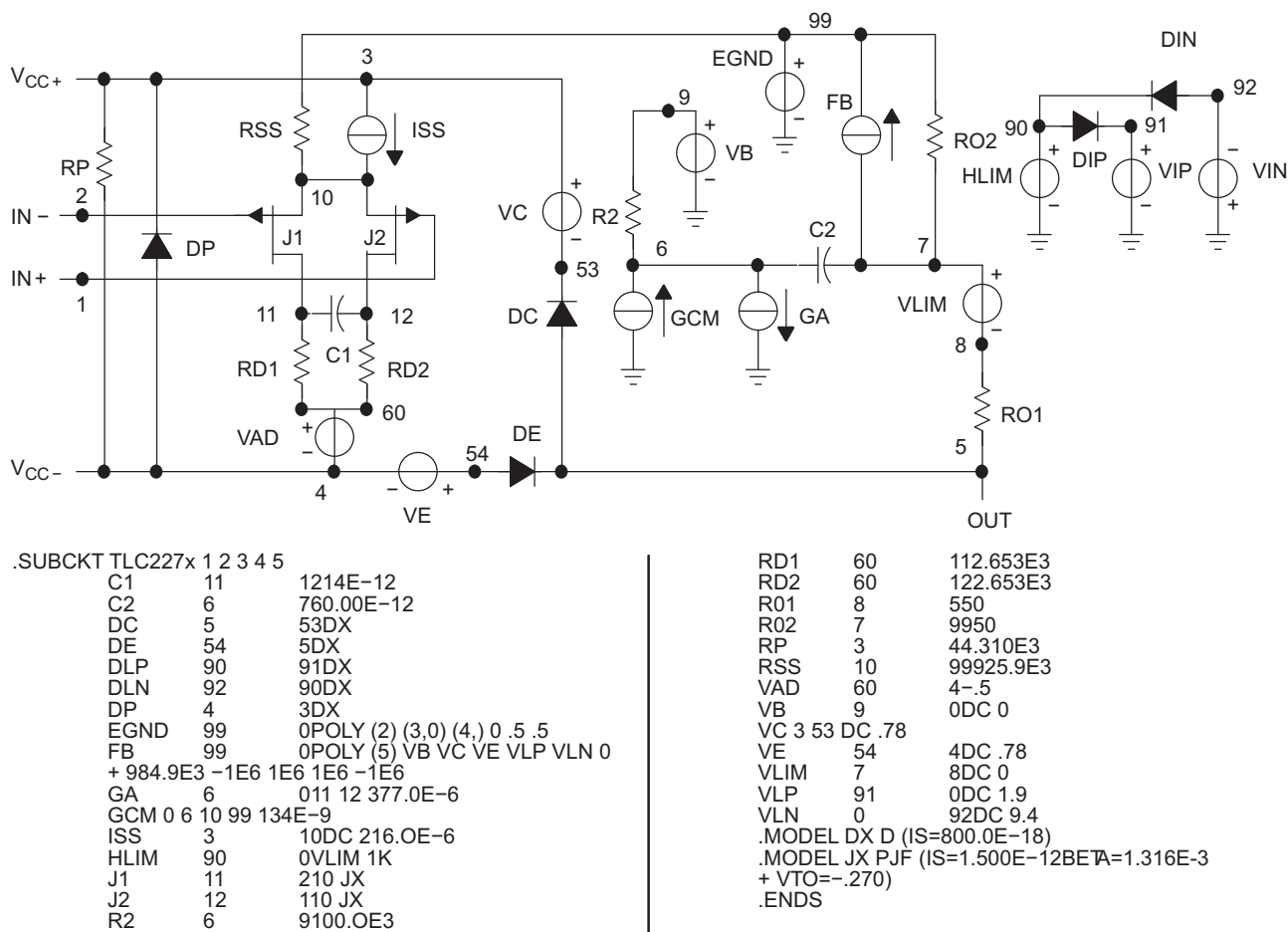

Figure 46. Boyle Macromodels and Subcircuit

8.2 Typical Application

The TLC2274 is designed to drive larger capacitive loads than most CMOS operational amplifiers. Figure 48 and Figure 49 show its ability to drive loads up to 1000 pF while maintaining good gain and phase margins (Rnull = 0).

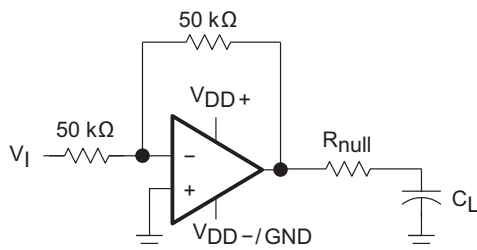

Figure 47. Typical Application Schematic

Typical Application (continued)

8.2.1 Design Requirements

As per Equation 1:

Table 2. Design Parameters

Improvement in Phase Margin	UGBW (kHz)	R null (Ω)	CL (pF)
0	1000	0	1000
7.15	1000	20	1000
17.43	1000	50	1000
32.12	1000	100	1000

8.2.2 Detailed Design Procedure

A smaller series resistor (R_{null}) at the output of the device (see Figure 47) improves the gain and phase margins when driving large capacitive loads. Figure 48 and Figure 49 show the effects of adding series resistances of 10 Ω, 50 Ω, 100 Ω, 200 Ω, and 500 Ω. The addition of this series resistor has two effects: the first is that it adds a zero to the transfer function and the second is that it reduces the frequency of the pole associated with the output load in the transfer function.

The zero introduced to the transfer function is equal to the series resistance times the load capacitance. To calculate the improvement in phase margin, Equation 1 can be used.

$$\Delta\phi_{m1} = \tan^{-1} (2 \times \pi \times \text{UGBW} \times R_{null} \times C_L)$$

where

- $\Delta\phi_{m1}$ = Improvement in phase margin
- UGBW = Unity-gain bandwidth frequency
- R_{null} = Output series resistance
- C_L = Load capacitance

(1)

The unity-gain bandwidth (UGBW) frequency decreases as the capacitive load increases (see Figure 47). To use equation 1, UGBW must be approximated from Figure 47. Using Equation 1 alone overestimates the improvement in phase margin, as illustrated in Figure 51. The overestimation is caused by the decrease in the frequency of the pole associated with the load, thus providing additional phase shift and reducing the overall improvement in phase margin. Using Figure 47, with Equation 1 enables the designer to choose the appropriate output series resistance to optimize the design of circuits driving large capacitance loads.

8.2.3 Application Curves

$T_A = 25^\circ\text{C}$

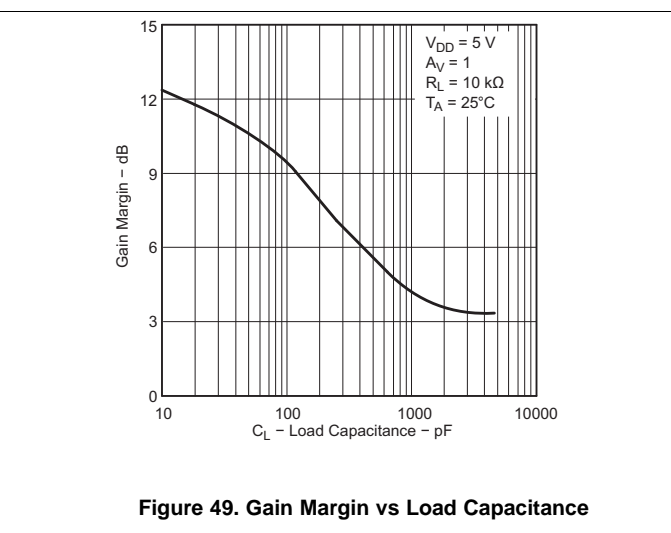
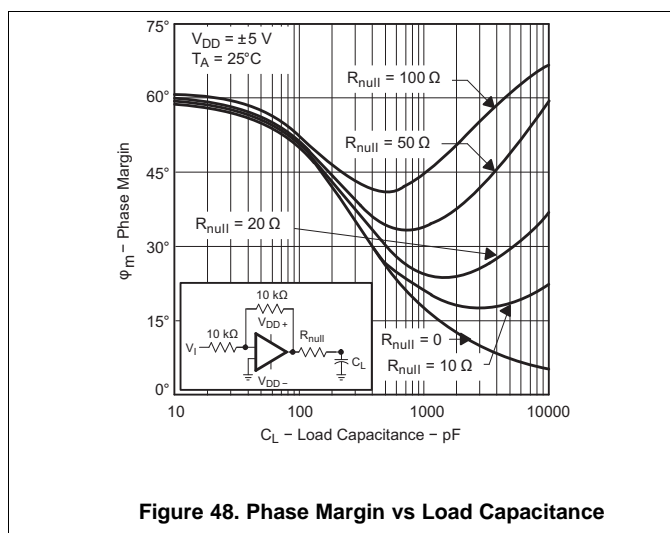

$T_A = 25^\circ\text{C}$

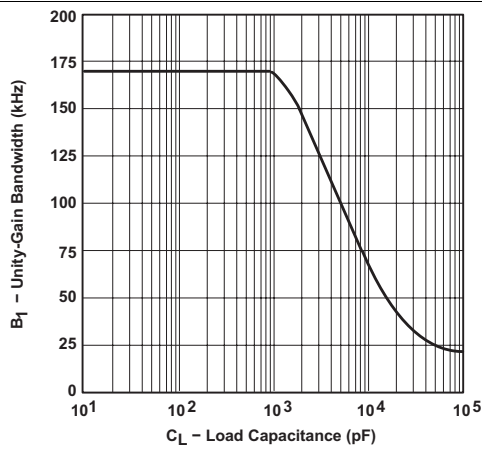

Figure 50. Unity-Gain Bandwidth vs Load Capacitance

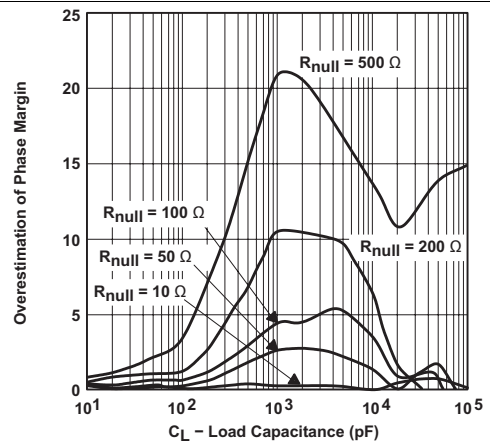

Figure 51. Overestimation of Phase Margin vs Load Capacitance

9 Power Supply Recommendations

TLC2274 operates from ± 2.2 - to ± 8 -V. In addition, key parameters are assured over the specified temperature range, -55°C to 125°C . Parameters which vary significantly with operating voltage or temperature are shown in the *Typical Characteristics*.

10 Layout

10.1 Layout Guidelines

The TLC2274 has very-low offset voltage and drift. To achieve highest performance, optimize circuit layout and mechanical conditions. Offset voltage and drift can be degraded by small thermoelectric potentials at the operational amplifier inputs. Connections of dissimilar metals generate thermal potential, which can degrade the ultimate performance of the TLC2274. Cancel these thermal potentials by assuring that they are equal in both input terminals.

- Keep the thermal mass of the connections made to the two input terminals similar.
- Locate heat sources as far as possible from the critical input circuitry.
- Shield operational amplifier and input circuitry from air currents such as cooling fans.

10.2 Layout Example

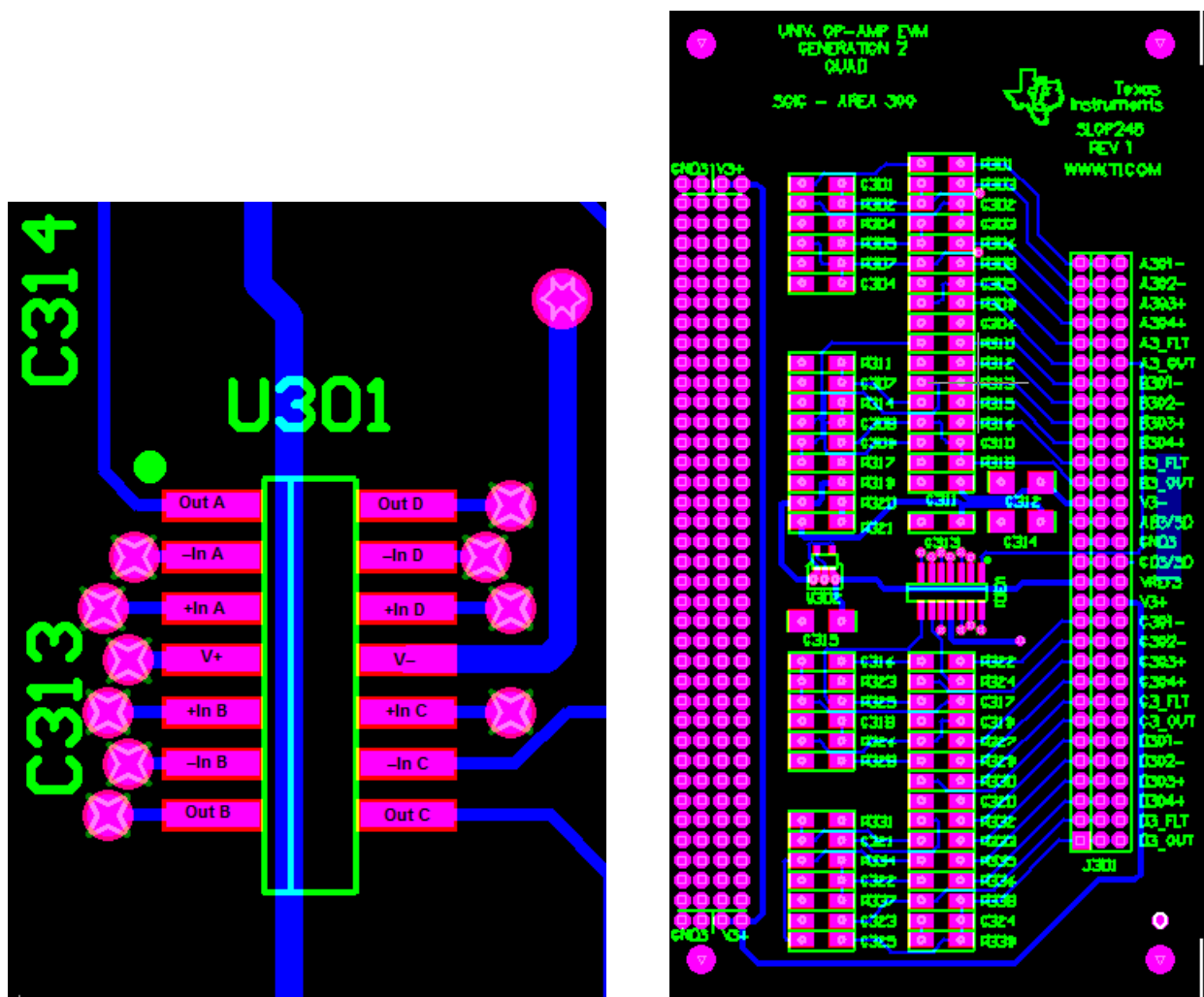

Figure 52. Board Layout Example

11 器件和文档支持

11.1 商标

LinCMOS is a trademark of Texas Instruments.
All other trademarks are the property of their respective owners.

11.2 静电放电警告



这些装置包含有限的内置 ESD 保护。存储或装卸时，应将导线一起截短或将装置放置于导电泡棉中，以防止 MOS 门极遭受静电损伤。

11.3 术语表

[SLYZ022](#) — *TI* 术语表。

这份术语表列出并解释术语、首字母缩略词和定义。

12 机械封装和可订购信息

以下页中包括机械封装和可订购信息。 这些信息是针对指定器件可提供的最新数据。 这些数据会在无通知且不对本文档进行修订的情况下发生改变。 欲获得该数据表的浏览器版本，请查阅左侧的导航栏。

重要声明

德州仪器(TI)及其下属子公司有权根据 JESD46 最新标准,对所提供的产品和服务进行更正、修改、增强、改进或其它更改,并有权根据 JESD48 最新标准中止提供任何产品和服务。客户在下订单前应获取最新的相关信息,并验证这些信息是否完整且是最新的。所有产品的销售都遵循在订单确认时所提供的TI 销售条款与条件。

TI 保证其所销售的组件的性能符合产品销售时 TI 半导体产品销售条件与条款的适用规范。仅在 TI 保证的范围内,且 TI 认为有必要时才会使用测试或其它质量控制技术。除非适用法律做出了硬性规定,否则没有必要对每种组件的所有参数进行测试。

TI 对应用帮助或客户产品设计不承担任何义务。客户应对其使用 TI 组件的产品和应用自行负责。为尽量减小与客户产品和应用相关的风险,客户应提供充分的设计与操作安全措施。

TI 不对任何 TI 专利权、版权、屏蔽作品权或其它与使用了 TI 组件或服务的组合设备、机器或流程相关的 TI 知识产权中授予的直接或隐含权限作出任何保证或解释。TI 所发布的与第三方产品或服务有关的信息,不能构成从 TI 获得使用这些产品或服务的许可、授权、或认可。使用此类信息可能需要获得第三方的专利权或其它知识产权方面的许可,或是 TI 的专利权或其它知识产权方面的许可。

对于 TI 的产品手册或数据表中 TI 信息的重要部分,仅在没有对内容进行任何篡改且带有相关授权、条件、限制和声明的情况下才允许进行复制。TI 对此类篡改过的文件不承担任何责任或义务。复制第三方的信息可能需要服从额外的限制条件。

在转售 TI 组件或服务时,如果对该组件或服务参数的陈述与 TI 标明的参数相比存在差异或虚假成分,则会失去相关 TI 组件或服务的所有明示或暗示授权,且这是不正当的、欺诈性商业行为。TI 对任何此类虚假陈述均不承担任何责任或义务。

客户认可并同意,尽管任何应用相关信息或支持仍可能由 TI 提供,但他们将独立负责满足与其产品及其在应用中使用的 TI 产品相关的所有法律、法规和安全相关要求。客户声明并同意,他们具备制定与实施安全措施所需的全部专业技术和知识,可预见故障的危险后果、监测故障及其后果、降低有可能造成人身伤害的故障的发生机率并采取适当的补救措施。客户将全额赔偿因在此类安全关键应用中使用任何 TI 组件而对 TI 及其代理造成的任何损失。

在某些场合中,为了推进安全相关应用有可能对 TI 组件进行特别的促销。TI 的目标是利用此类组件帮助客户设计和创立其特有的可满足适用的功能安全性标准和要求的终端产品解决方案。尽管如此,此类组件仍然服从这些条款。

TI 组件未获得用于 FDA Class III (或类似的生命攸关医疗设备)的授权许可,除非各方授权官员已经达成了专门管控此类使用的特别协议。

只有那些 TI 特别注明属于军用等级或“增强型塑料”的 TI 组件才是设计或专门用于军事/航空应用或环境的。购买者认可并同意,对并非指定面向军事或航空航天用途的 TI 组件进行军事或航空航天方面的应用,其风险由客户单独承担,并且由客户独立负责满足与此类使用相关的所有法律和法规要求。

TI 已明确指定符合 ISO/TS16949 要求的产品,这些产品主要用于汽车。在任何情况下,因使用非指定产品而无法达到 ISO/TS16949 要求, TI 不承担任何责任。

	产品		应用
数字音频	www.ti.com.cn/audio	通信与电信	www.ti.com.cn/telecom
放大器和线性器件	www.ti.com.cn/amplifiers	计算机及周边	www.ti.com.cn/computer
数据转换器	www.ti.com.cn/dataconverters	消费电子	www.ti.com.cn/consumer-apps
DLP® 产品	www.dlp.com	能源	www.ti.com.cn/energy
DSP - 数字信号处理器	www.ti.com.cn/dsp	工业应用	www.ti.com.cn/industrial
时钟和计时器	www.ti.com.cn/clockandtimers	医疗电子	www.ti.com.cn/medical
接口	www.ti.com.cn/interface	安防应用	www.ti.com.cn/security
逻辑	www.ti.com.cn/logic	汽车电子	www.ti.com.cn/automotive
电源管理	www.ti.com.cn/power	视频和影像	www.ti.com.cn/video
微控制器 (MCU)	www.ti.com.cn/microcontrollers		
RFID 系统	www.ti.com.cn/rfidsys		
OMAP应用处理器	www.ti.com/omap		
无线连通性	www.ti.com.cn/wirelessconnectivity	德州仪器在线技术支持社区	www.deyisupport.com

邮寄地址: 上海市浦东新区世纪大道1568号, 中建大厦32楼邮政编码: 200122
Copyright © 2015, 德州仪器半导体技术(上海)有限公司

PACKAGING INFORMATION

Orderable Device	Status (1)	Package Type	Package Drawing	Pins	Package Qty	Eco Plan (2)	Lead finish/ Ball material (6)	MSL Peak Temp (3)	Op Temp (°C)	Device Marking (4/5)	Samples
TLC2274EPWRQ1	ACTIVE	TSSOP	PW	14	2000	RoHS & Green	NIPDAU	Level-2-260C-1 YEAR	-40 to 150	2274EQ1	Samples

(1) The marketing status values are defined as follows:

ACTIVE: Product device recommended for new designs.

LIFEBUY: TI has announced that the device will be discontinued, and a lifetime-buy period is in effect.

NRND: Not recommended for new designs. Device is in production to support existing customers, but TI does not recommend using this part in a new design.

PREVIEW: Device has been announced but is not in production. Samples may or may not be available.

OBSOLETE: TI has discontinued the production of the device.

(2) **RoHS:** TI defines "RoHS" to mean semiconductor products that are compliant with the current EU RoHS requirements for all 10 RoHS substances, including the requirement that RoHS substance do not exceed 0.1% by weight in homogeneous materials. Where designed to be soldered at high temperatures, "RoHS" products are suitable for use in specified lead-free processes. TI may reference these types of products as "Pb-Free".

RoHS Exempt: TI defines "RoHS Exempt" to mean products that contain lead but are compliant with EU RoHS pursuant to a specific EU RoHS exemption.

Green: TI defines "Green" to mean the content of Chlorine (Cl) and Bromine (Br) based flame retardants meet JS709B low halogen requirements of <=1000ppm threshold. Antimony trioxide based flame retardants must also meet the <=1000ppm threshold requirement.

(3) MSL, Peak Temp. - The Moisture Sensitivity Level rating according to the JEDEC industry standard classifications, and peak solder temperature.

(4) There may be additional marking, which relates to the logo, the lot trace code information, or the environmental category on the device.

(5) Multiple Device Markings will be inside parentheses. Only one Device Marking contained in parentheses and separated by a "-" will appear on a device. If a line is indented then it is a continuation of the previous line and the two combined represent the entire Device Marking for that device.

(6) Lead finish/Ball material - Orderable Devices may have multiple material finish options. Finish options are separated by a vertical ruled line. Lead finish/Ball material values may wrap to two lines if the finish value exceeds the maximum column width.

Important Information and Disclaimer:The information provided on this page represents TI's knowledge and belief as of the date that it is provided. TI bases its knowledge and belief on information provided by third parties, and makes no representation or warranty as to the accuracy of such information. Efforts are underway to better integrate information from third parties. TI has taken and continues to take reasonable steps to provide representative and accurate information but may not have conducted destructive testing or chemical analysis on incoming materials and chemicals. TI and TI suppliers consider certain information to be proprietary, and thus CAS numbers and other limited information may not be available for release.

In no event shall TI's liability arising out of such information exceed the total purchase price of the TI part(s) at issue in this document sold by TI to Customer on an annual basis.

MECHANICAL DATA

PW (R-PDSO-G14)

PLASTIC SMALL OUTLINE

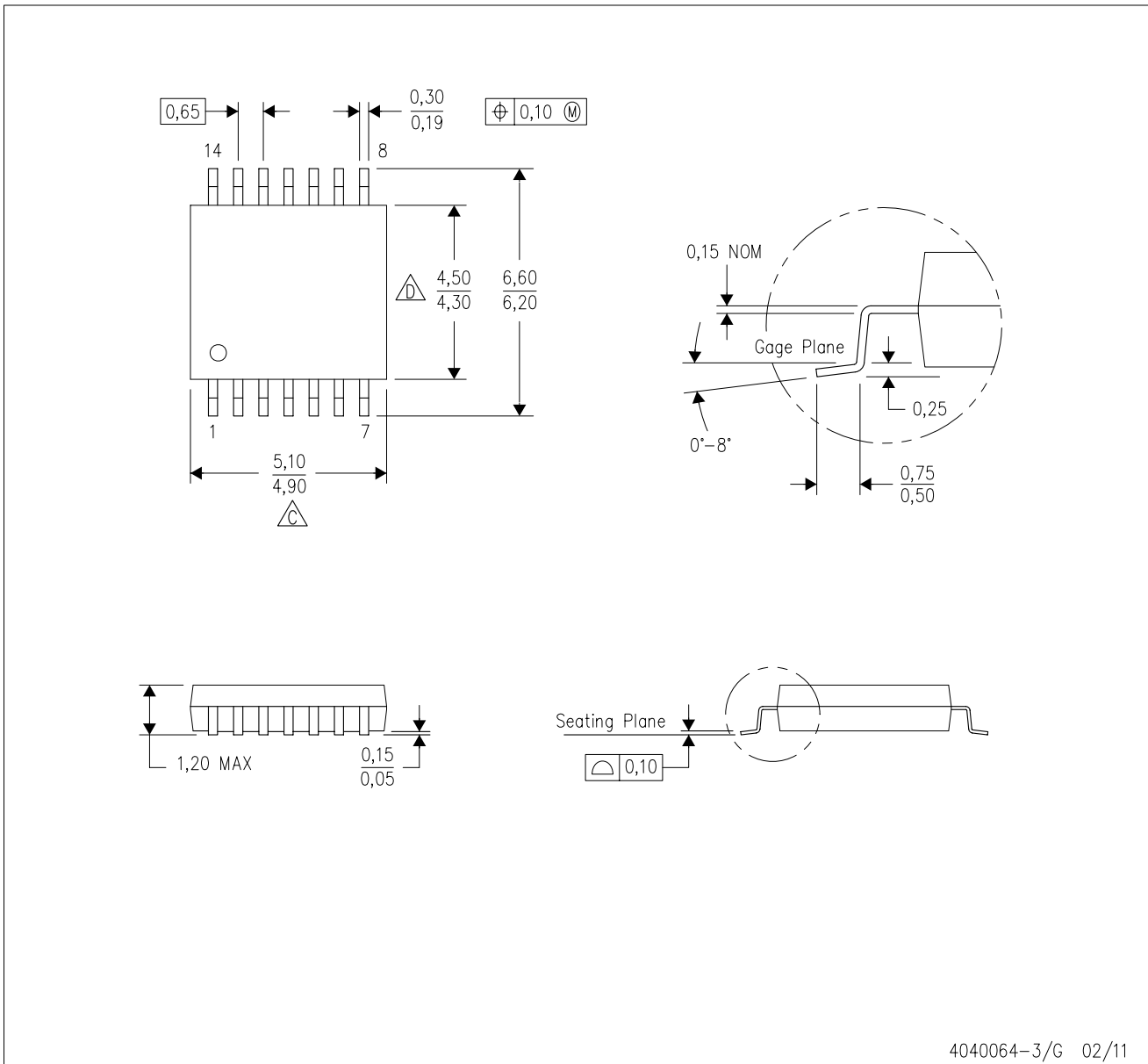

- NOTES:
- A. All linear dimensions are in millimeters. Dimensioning and tolerancing per ASME Y14.5M-1994.
 - B. This drawing is subject to change without notice.
 - C. Body length does not include mold flash, protrusions, or gate burrs. Mold flash, protrusions, or gate burrs shall not exceed 0,15 each side.
 - D. Body width does not include interlead flash. Interlead flash shall not exceed 0,25 each side.
 - E. Falls within JEDEC MO-153

重要声明和免责声明

TI 均以“原样”提供技术性及其可靠性数据（包括数据表）、设计资源（包括参考设计）、应用或其他设计建议、网络工具、安全信息和其他资源，不保证其中不含任何瑕疵，且不做任何明示或暗示的担保，包括但不限于对适销性、适合某特定用途或不侵犯任何第三方知识产权的暗示担保。

所述资源可供专业开发人员应用TI 产品进行设计使用。您将对以下行为独自承担全部责任：(1) 针对您的应用选择合适的TI 产品；(2) 设计、验证并测试您的应用；(3) 确保您的应用满足相应标准以及任何其他安全、安保或其他要求。所述资源如有变更，恕不另行通知。TI 对您使用所述资源的授权仅限于开发资源所涉及TI 产品的相关应用。除此之外不得复制或展示所述资源，也不提供其它TI 或任何第三方的知识产权授权许可。如因使用所述资源而产生任何索赔、赔偿、成本、损失及债务等，TI 对此概不负责，并且您须赔偿由此对TI 及其代表造成的损害。

TI 所提供产品均受TI 的销售条款 (<http://www.ti.com.cn/zh-cn/legal/termsofsale.html>) 以及ti.com.cn上或随附TI产品提供的其他可适用条款的约束。TI提供所述资源并不扩展或以其他方式更改TI 针对TI 产品所发布的可适用的担保范围或担保免责声明。

邮寄地址：上海市浦东新区世纪大道 1568 号中建大厦 32 楼，邮政编码：200122
Copyright © 2020 德州仪器半导体技术（上海）有限公司