

HIGH OUTPUT RS-485 TRANSCEIVERS

 Check for Samples: [SN65HVD05](#), [SN65HVD06](#), [SN75HVD05](#), [SN65HVD07](#), [SN75HVD06](#), [SN75HVD07](#)

FEATURES

- Minimum Differential Output Voltage of 2.5 V Into a 54-Ω Load
- Open-Circuit, Short-Circuit, and Idle-Bus Failsafe Receiver
- 1/8th Unit-Load Option Available (Up to 256 Nodes on the Bus)
- Bus-Pin ESD Protection Exceeds 16 kV HBM
- Driver Output Slew Rate Control Options
- Electrically Compatible With ANSI TIA/EIA-485-A Standard
- Low-Current Standby Mode: 1 μA Typical
- Glitch-Free Power-Up and Power-Down Protection for Hot-Plugging Applications
- Pin Compatible With Industry Standard SN75176

APPLICATIONS

- Data Transmission Over Long or Lossy Lines or Electrically Noisy Environments
- Profibus Line Interface
- Industrial Process Control Networks
- Point-of-Sale (POS) Networks
- Electric Utility Metering
- Building Automation
- Digital Motor Control

DESCRIPTION

The SN65HVD05, SN75HVD05, SN65HVD06, SN75HVD06, SN65HVD07, and SN75HVD07 combine a 3-state differential line driver and differential line receiver. They are designed for balanced data transmission and interoperate with ANSI TIA/EIA-485-A and ISO 8482E standard-compliant devices. The driver is designed to provide a differential output voltage greater than that required by these standards for increased noise margin. The drivers and receivers have active-high and active-low enables respectively, which can be externally connected together to function as direction control.

The driver differential outputs and receiver differential inputs connect internally to form a differential input/output (I/O) bus port that is designed to offer minimum loading to the bus whenever the driver is disabled or not powered. These devices feature wide positive and negative common-mode voltage ranges, making them suitable for party-line applications.

D OR P PACKAGE
(TOP VIEW)

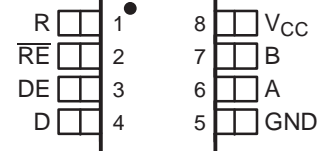

LOGIC DIAGRAM
(POSITIVE LOGIC)

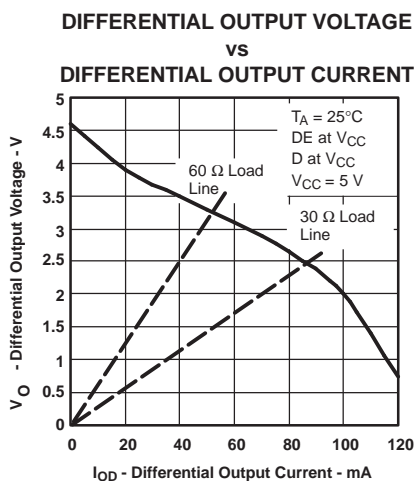
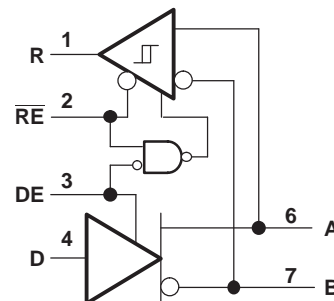

Please be aware that an important notice concerning availability, standard warranty, and use in critical applications of Texas Instruments semiconductor products and disclaimers thereto appears at the end of this data sheet.



These devices have limited built-in ESD protection. The leads should be shorted together or the device placed in conductive foam during storage or handling to prevent electrostatic damage to the MOS gates.

ORDERING INFORMATION⁽¹⁾

SIGNALING RATE	UNIT LOAD	DRIVER OUTPUT SLOPE CONTROL	T _A	PART NUMBER ⁽²⁾		MARKED AS	
						PLASTIC DUAL-IN-LINE PACKAGE (PDIP)	SMALL OUTLINE IC (SOIC) PACKAGE
40 Mbps	1/2	No	–40°C to 85°C	SN65HVD05D	SN65HVD05P	65HVD05	VP05
10 Mbps	1/8	Yes		SN65HVD06D	SN65HVD06P	65HVD06	VP06
1 Mbps	1/8	Yes		SN65HVD07D	SN65HVD07P	65HVD07	VP07
40 Mbps	1/2	No	0°C to 70°C	SN75HVD05D	SN75HVD05P	75HVD05	VN05
10 Mbps	1/8	Yes		SN75HVD06D	SN75HVD06P	75HVD06	VN06
1 Mbps	1/8	Yes		SN75HVD07D	SN75HVD07P	75HVD07	VN07

(1) For the most current package and ordering information, see the Package Option Addendum at the end of this document, or see the TI web site at www.ti.com.

(2) The D package is available taped and reeled. Add an R suffix to the device type (i.e., SN65HVD05DR).

PACKAGE DISSIPATION RATINGS

(See [Figure 12](#) and [Figure 13](#))

PACKAGE	T _A ≤ 25°C POWER RATING	DERATING FACTOR ⁽¹⁾ ABOVE T _A = 25°C	T _A = 70°C POWER RATING	T _A = 85°C POWER RATING
D ⁽²⁾	710 mW	5.7 mW/°C	455 mW	369 mW
D ⁽³⁾	1282 mW	10.3 mW/°C	821 mW	667 mW
P	1000 mW	8.0 mW/°C	640 mW	520 mW

(1) This is the inverse of the junction-to-ambient thermal resistance when board-mounted and with no air flow.

(2) Tested in accordance with the Low-K thermal metric definitions of EIA/JESD51-3

(3) Tested in accordance with the High-K thermal metric definitions of EIA/JESD51-7

ABSOLUTE MAXIMUM RATINGS

over operating free-air temperature range unless otherwise noted^{(1) (2)}

			SN65HVD05, SN65HVD06, SN65HVD07 SN75HVD05, SN75HVD06, SN75HVD07
Supply voltage range, V _{CC}			–0.3 V to 6 V
Voltage range at A or B			–9 V to 14 V
Input voltage range at D, DE, R or \overline{RE}			–0.5 V to V _{CC} + 0.5 V
Voltage input range, transient pulse, A and B, through 100 Ω (see Figure 11)			–50 V to 50 V
Receiver output current, I _O			–11 mA to 11mA
Electrostatic discharge	Human body model ⁽³⁾	A, B, and GND	16 kV
		All pins	4 kV
	Charged-device model ⁽⁴⁾	All pins	1 kV
Continuous total power dissipation			See Dissipation Rating Table

(1) Stresses beyond those listed under "absolute maximum ratings" may cause permanent damage to the device. These are stress ratings only, and functional operation of the device at these or any other conditions beyond those indicated under "recommended operating conditions" is not implied. Exposure to absolute-maximum-rated conditions for extended periods may affect device reliability.

(2) All voltage values, except differential I/O bus voltages, are with respect to network ground terminal.

(3) Tested in accordance with JEDEC Standard 22, Test Method A114-A.

(4) Tested in accordance with JEDEC Standard 22, Test Method C101.

RECOMMENDED OPERATING CONDITIONS

		MIN	NOM	MAX	UNIT
Supply voltage, V_{CC}		4.5		5.5	V
Voltage at any bus terminal (separately or common mode) V_I or V_{IC}		-7 ⁽¹⁾		12	V
High-level input voltage, V_{IH}	D, DE, \overline{RE}	2			V
Low-level input voltage, V_{IL}	D, DE, \overline{RE}			0.8	V
Differential input voltage, V_{ID} (see Figure 7)		-12		12	V
High-level output current, I_{OH}	Driver	-100			mA
	Receiver	-8			
Low-level output current, I_{OL}	Driver			100	mA
	Receiver			8	
Operating free-air temperature, T_A	SN65HVD05	-40		85	°C
	SN65HVD06				
	SN65HVD07				
	SN75HVD05	0		70	°C
	SN75HVD06				
	SN75HVD07				

(1) The algebraic convention, in which the least positive (most negative) limit is designated as minimum is used in this data sheet.

DRIVER ELECTRICAL CHARACTERISTICS

over operating free-air temperature range unless otherwise noted

PARAMETER		TEST CONDITIONS		MIN	TYP ⁽¹⁾	MAX	UNIT
V_{IK}	Input clamp voltage	$I_I = -18$ mA		-1.5			V
$ V_{OD} $	Differential output voltage	No Load				V_{CC}	V
		$R_L = 54 \Omega$, See Figure 4		2.5			
		$V_{test} = -7$ V to 12 V, See Figure 2		2.2			
$\Delta V_{OD} $	Change in magnitude of differential output voltage	See Figure 4 and Figure 2		-0.2		0.2	V
$V_{OC(SS)}$	Steady-state common-mode output voltage	See Figure 3		2.2		3.3	V
$\Delta V_{OC(SS)}$	Change in steady-state common-mode output voltage	See Figure 3		-0.1		0.1	V
$V_{OC(PP)}$	Peak-to-peak common-mode output voltage	HVD05	See Figure 3			600	mV
		HVD06		500			
		HVD07		900			
I_{OZ}	High-impedance output current	See receiver input currents					
I_I	Input current	D		-100		0	μ A
		DE		0		100	
I_{OS}	Short-circuit output current	-7 V $\leq V_O \leq 12$ V		-250		250	mA
$C_{(diff)}$	Differential output capacitance	$V_{ID} = 0.4 \sin(4E6\pi t) + 0.5$ V, DE at 0 V			16		pF
I_{CC}	Supply current	\overline{RE} at V_{CC} , D and DE at V_{CC} , No load	Receiver disabled and driver enabled		9	15	mA
		\overline{RE} at V_{CC} , D at V_{CC} DE at 0 V, No load	Receiver disabled and driver disabled (standby)		1	5	μ A
		\overline{RE} at 0 V, D and DE at V_{CC} , No load	Receiver enabled and driver enabled		9	15	mA

(1) All typical values are at 25°C and with a 5-V supply.

DRIVER SWITCHING CHARACTERISTICS

over operating free-air temperature range unless otherwise noted

PARAMETER		TEST CONDITIONS	MIN	TYP ⁽¹⁾	MAX	UNIT
t _{PLH}	Propagation delay time, low-to-high-level output	HVD05		6.5	11	ns
		HVD06		27	40	
		HVD07		250	400	
t _{PHL}	Propagation delay time, high-to-low-level output	HVD05		6.5	11	ns
		HVD06		27	40	
		HVD07		250	400	
t _r	Differential output signal rise time	HVD05		2.7	3.6	ns
		HVD06		18	28	
		HVD07		150	300	
t _f	Differential output signal fall time	HVD05	R _L = 54 Ω, C _L = 50 pF, See Figure 4	2.7	3.6	ns
		HVD06		18	28	
		HVD07		150	300	
t _{sk(p)}	Pulse skew (t _{PHL} - t _{PLH})	HVD05			2	ns
		HVD06			2.5	
		HVD07			10	
t _{sk(pp)} ⁽²⁾	Part-to-part skew	HVD05			3.5	ns
		HVD06			14	
		HVD07			100	
t _{PZH1}	Propagation delay time, high-impedance-to-high-level output	HVD05			25	ns
		HVD06			45	
		HVD07			250	
t _{PHZ}	Propagation delay time, high-level-to-high-impedance output	HVD05	\overline{RE} at 0 V, R _L = 110 Ω, See Figure 5		25	ns
		HVD06			60	
		HVD07			250	
t _{PZL1}	Propagation delay time, high-impedance-to-low-level output	HVD05			15	ns
		HVD06			45	
		HVD07			200	
t _{PLZ}	Propagation delay time, low-level-to-high-impedance output	HVD05	\overline{RE} at 0 V, R _L = 110 Ω, See Figure 6		14	ns
		HVD06			90	
		HVD07			550	
t _{PZH2}	Propagation delay time, standby-to-high-level output		R _L = 110 Ω, \overline{RE} at 3 V, See Figure 5		6	μs
t _{PZL2}	Propagation delay time, standby-to-low-level output		R _L = 110 Ω, \overline{RE} at 3 V, See Figure 6		6	μs

(1) All typical values are at 25°C and with a 5-V supply.

(2) t_{sk(pp)} is the magnitude of the difference in propagation delay times between any specified terminals of two devices when both devices operate with the same supply voltages, at the same temperature, and have identical packages and test circuits.

RECEIVER ELECTRICAL CHARACTERISTICS

over operating free-air temperature range unless otherwise noted

PARAMETER		TEST CONDITIONS		MIN	TYP ⁽¹⁾	MAX	UNIT	
V_{IT+}	Positive-going input threshold voltage	$I_O = -8 \text{ mA}$				-0.01	V	
V_{IT-}	Negative-going input threshold voltage	$I_O = 8 \text{ mA}$		-0.2				
V_{hys}	Hysteresis voltage ($V_{IT+} - V_{IT-}$)				35		mV	
V_{IK}	Enable-input clamp voltage	$I_I = -18 \text{ mA}$		-1.5			V	
V_{OH}	High-level output voltage	$V_{ID} = 200 \text{ mV}$,	$I_{OH} = -8 \text{ mA}$,	See Figure 7		4	V	
V_{OL}	Low-level output voltage	$V_{ID} = -200 \text{ mV}$,	$I_{OL} = 8 \text{ mA}$,	See Figure 7		0.4	V	
I_{OZ}	High-impedance-state output current	$V_O = 0 \text{ or } V_{CC}$	\overline{RE} at V_{CC}	-1		1	μA	
I_I	Bus input current	HVD05	Other input at 0 V	$V_A \text{ or } V_B = 12 \text{ V}$		0.23	0.5	mA
				$V_A \text{ or } V_B = 12 \text{ V}$, $V_{CC} = 0 \text{ V}$		0.3	0.5	
				$V_A \text{ or } V_B = -7 \text{ V}$		-0.4	0.13	
				$V_A \text{ or } V_B = -7 \text{ V}$, $V_{CC} = 0 \text{ V}$		-0.4	0.15	
		HVD06 HVD07	Other input at 0 V	$V_A \text{ or } V_B = 12 \text{ V}$		0.06	0.1	mA
				$V_A \text{ or } V_B = 12 \text{ V}$, $V_{CC} = 0 \text{ V}$		0.08	0.13	
				$V_A \text{ or } V_B = -7 \text{ V}$		-0.1	0.05	
				$V_A \text{ or } V_B = -7 \text{ V}$, $V_{CC} = 0 \text{ V}$		-0.05	0.03	
I_{IH}	High-level input current, \overline{RE}	$V_{IH} = 2 \text{ V}$		-60	26.4		μA	
I_{IL}	Low-level input current, \overline{RE}	$V_{IL} = 0.8 \text{ V}$		-60	27.4		μA	
$C_{(diff)}$	Differential input capacitance	$V_I = 0.4 \sin(4E6\pi t) + 0.5 \text{ V}$, DE at 0 V			16		pF	
I_{CC}	Supply current	\overline{RE} at 0 V, D and DE at 0 V, No load	Receiver enabled and driver disabled	5	10		mA	
		\overline{RE} at V_{CC} , DE at 0 V, D at V_{CC} , No load	Receiver disabled and driver disabled (standby)	1	5		μA	
		\overline{RE} at 0 V, D and DE at V_{CC} , No load	Receiver enabled and driver enabled	9	15		mA	

(1) All typical values are at 25°C and with a 5-V supply.

RECEIVER SWITCHING CHARACTERISTICS

over operating free-air temperature range unless otherwise noted

PARAMETER		TEST CONDITIONS	MIN	TYP ⁽¹⁾	MAX	UNIT	
t_{PLH}	Propagation delay time, low-to-high-level output 1/2 UL	HVD05		14.6	25	ns	
t_{PHL}	Propagation delay time, high-to-low-level output 1/2 UL	HVD05		14.6	25	ns	
t_{PLH}	Propagation delay time, low-to-high-level output 1/8 UL	HVD06		55	70	ns	
		HVD07		55	70		
t_{PHL}	Propagation delay time, high-to-low-level output 1/8 UL	HVD06	$V_{ID} = -1.5\text{ V to }1.5\text{ V},$ $C_L = 15\text{ pF},$ See Figure 8	55	70	ns	
		HVD07		55	70		
$t_{sk(p)}$	Pulse skew ($t_{PHL} - t_{PLH}$)	HVD05				2	ns
		HVD06				4.5	
		HVD07			4.5		
$t_{sk(pp)}$ ⁽²⁾	Part-to-part skew	HVD05			6.5	ns	
		HVD06			14		
		HVD07			14		
t_r	Output signal rise time	$C_L = 15\text{ pF},$ See Figure 8		2	3	ns	
t_f	Output signal fall time			2	3		
t_{PZH1}	Output enable time to high level	$C_L = 15\text{ pF},$ DE at 3 V, See Figure 9			10	ns	
t_{PZL1}	Output enable time to low level				10		
t_{PHZ}	Output disable time from high level				15		
t_{PLZ}	Output disable time from low level				15		
t_{PZH2}	Propagation delay time, standby-to-high-level output	$C_L = 15\text{ pF},$ DE at 0, See Figure 10			6	μs	
t_{PZL2}	Propagation delay time, standby-to-low-level output				6		

(1) All typical values are at 25°C and with a 5-V supply.

(2) $t_{sk(pp)}$ is the magnitude of the difference in propagation delay times between any specified terminals of two devices when both devices operate with the same supply voltages, at the same temperature, and have identical packages and test circuits.

PARAMETER MEASUREMENT INFORMATION

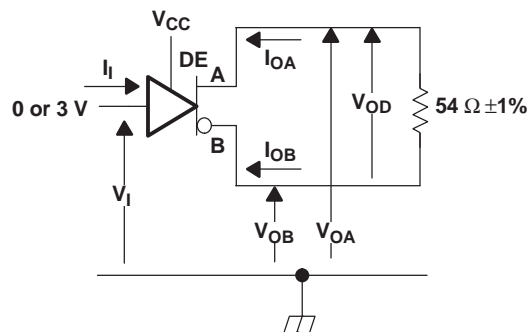

Figure 1. Driver V_{OD} Test Circuit and Voltage and Current Definitions

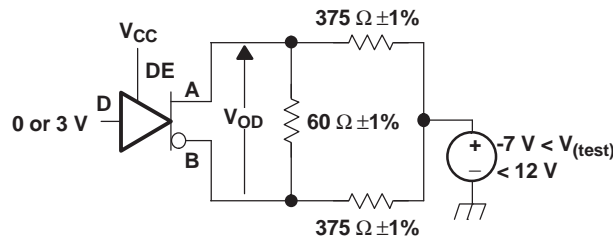
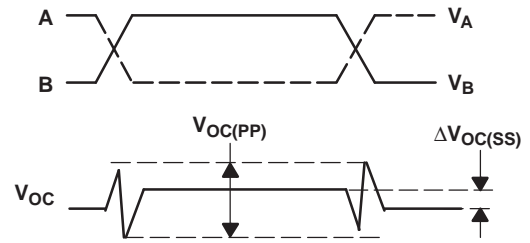
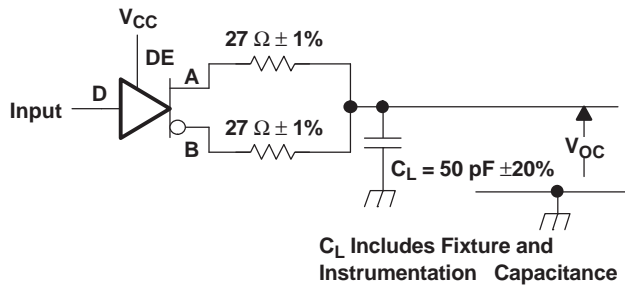
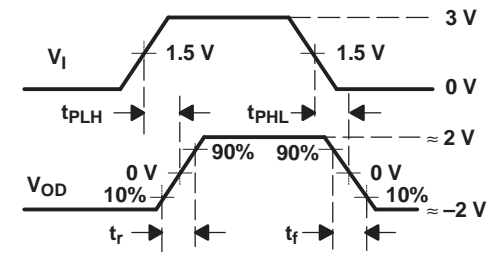
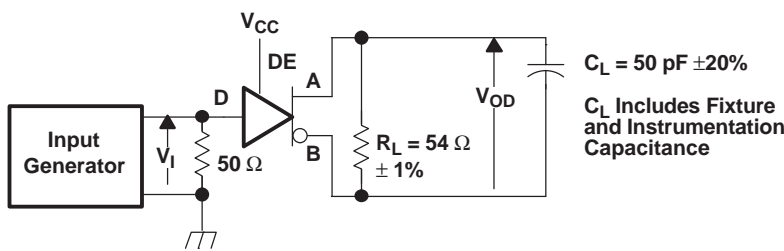

Figure 2. Driver V_{OD} With Common-Mode Loading Test Circuit



Input: PRR = 500 kHz, 50% Duty Cycle, $t_r < 6$ ns, $t_f < 6$ ns, $Z_O = 50 \Omega$

Figure 3. Test Circuit and Definitions for the Driver Common-Mode Output Voltage



Generator: PRR = 500 kHz, 50% Duty Cycle, $t_r < 6$ ns, $t_f < 6$ ns, $Z_O = 50 \Omega$

Figure 4. Driver Switching Test Circuit and Voltage Waveforms

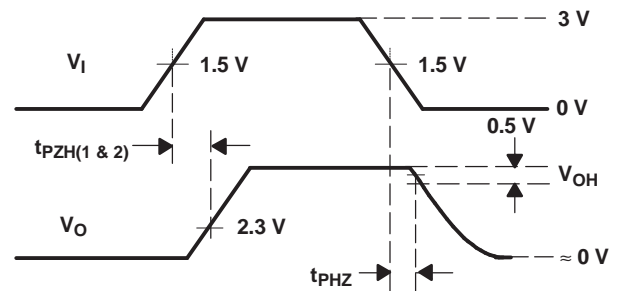
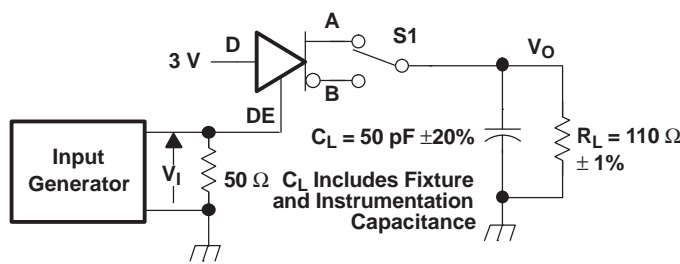

Generator: PRR = 100 kHz, 50% Duty Cycle, $t_r < 6$ ns, $t_f < 6$ ns, $Z_O = 50 \Omega$

Figure 5. Driver High-Level Enable and Disable Time Test Circuit and Voltage Waveforms

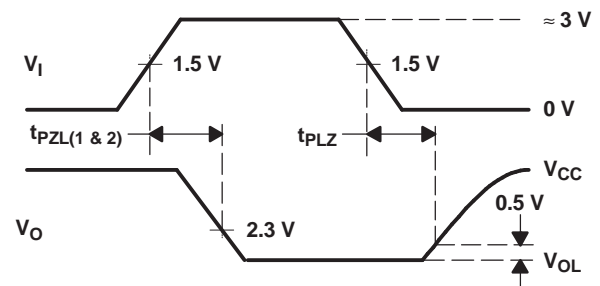
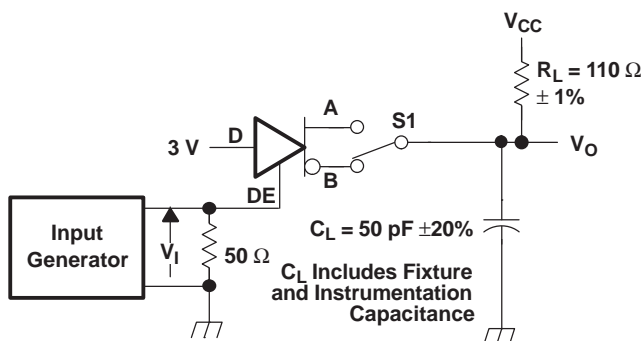

Generator: PRR = 100 kHz, 50% Duty Cycle, $t_r < 6$ ns, $t_f < 6$ ns, $Z_O = 50 \Omega$

Figure 6. Driver Low-Level Output Enable and Disable Time Test Circuit and Voltage Waveforms

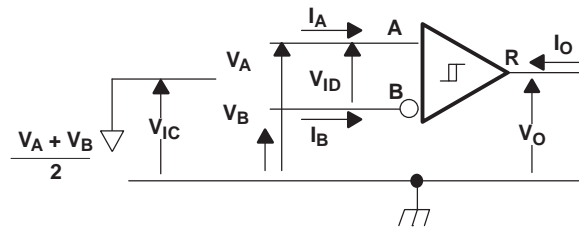

Figure 7. Receiver Voltage and Current Definitions

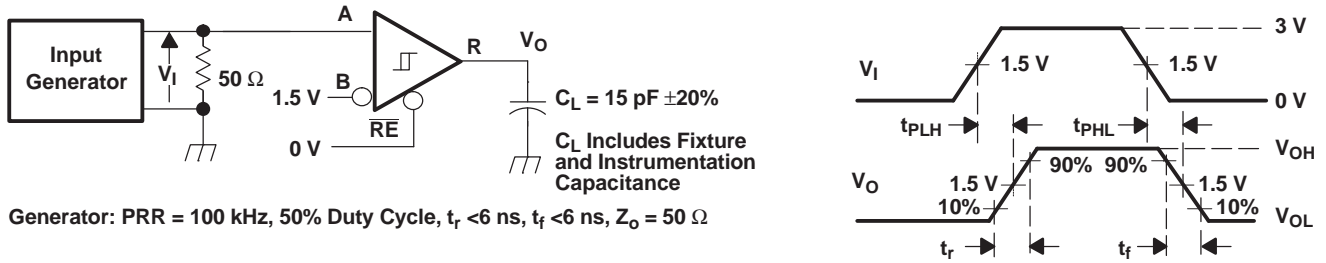

Figure 8. Receiver Switching Test Circuit and Voltage Waveforms

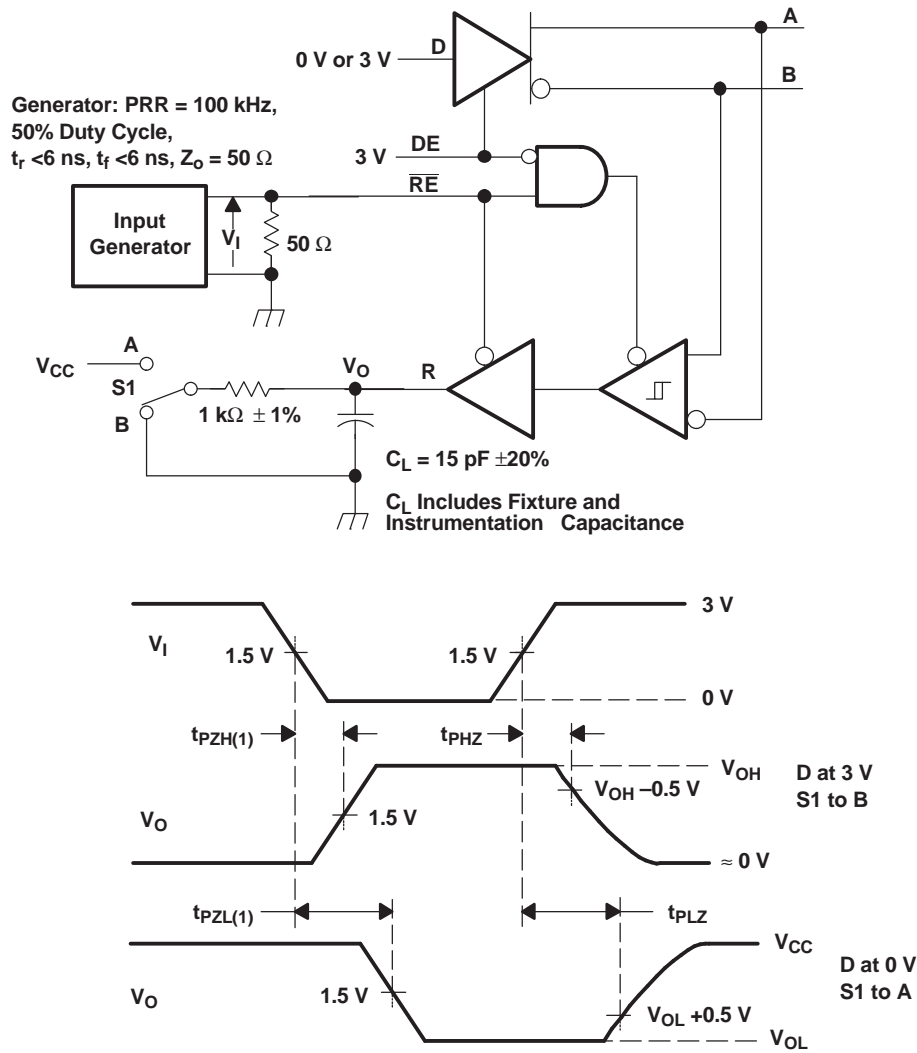

Figure 9. Receiver Enable and Disable Time Test Circuit and Voltage Waveforms With Drivers Enabled

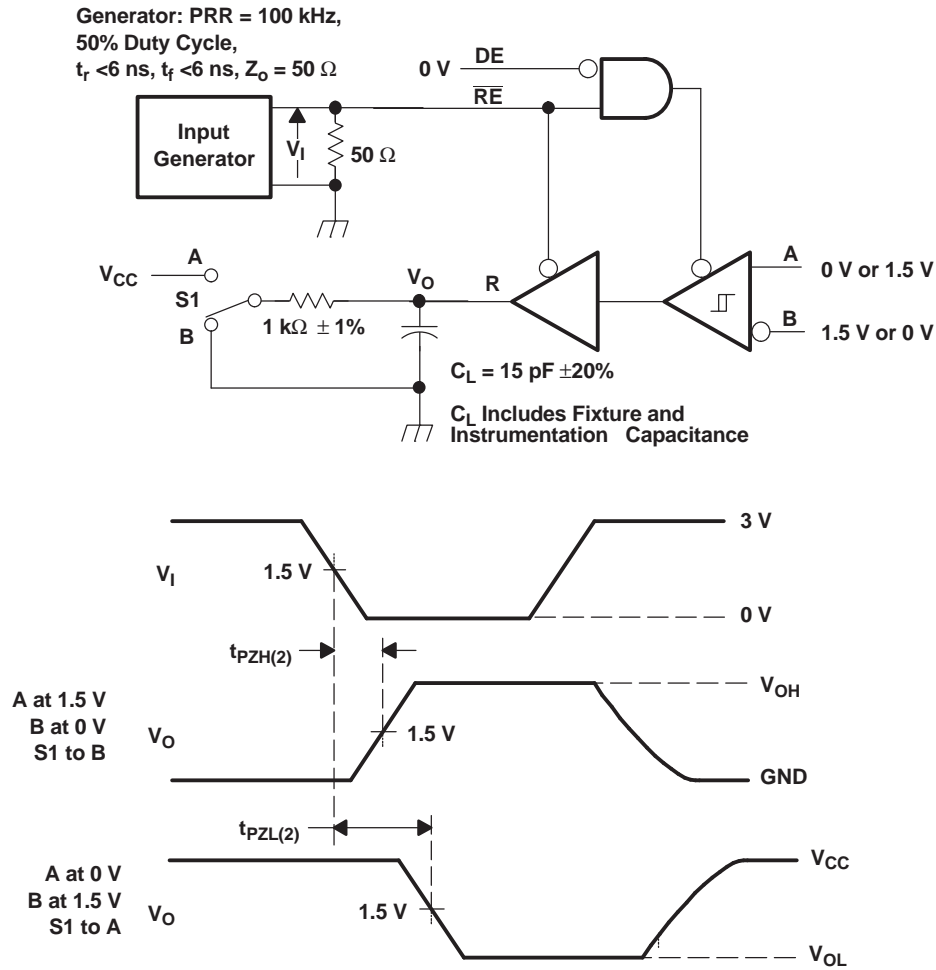
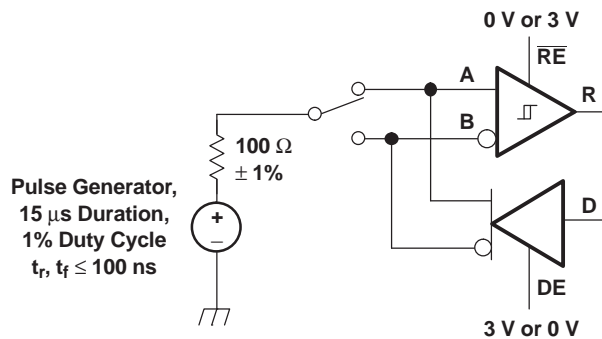

Figure 10. Receiver Enable Time From Standby (Driver Disabled)



NOTE: This test is conducted to test survivability only. Data stability at the R output is not specified.

Figure 11. Test Circuit, Transient Over Voltage Test

FUNCTION TABLES

Table 1. DRIVER

INPUT D	ENABLE	OUTPUTS	
	DE	A	B
H	H	H	L
L	H	L	H
X	L	Z	Z
Open	H	H	L
X	Open	Z	Z

Table 2. RECEIVER⁽¹⁾

DIFFERENTIAL INPUTS $V_{ID} = V_A - V_B$	ENABLE \overline{RE}	OUTPUT R
$V_{ID} \leq -0.2$ V	L	L
-0.2 V < $V_{ID} < -0.01$ V	L	?
-0.01 V $\leq V_{ID}$	L	H
X	H	Z
Open Circuit	L	H
Short Circuit	L	H
IDLE Bus	L	H
X	Open	Z

(1) H = high level; L = low level; Z = high impedance; X = irrelevant;
? = indeterminate

Receiver Failsafe

The differential receiver is “failsafe” to invalid bus states caused by:

- open bus conditions such as a disconnected connector,
- shorted bus conditions such as cable damage shorting the twisted-pair together, or
- idle bus conditions that occur when no driver on the bus is actively driving

In any of these cases, the differential receiver outputs a failsafe logic High state, so that the output of the receiver is not indeterminate.

Receiver failsafe is accomplished by offsetting the receiver thresholds so that the “input indeterminate” range does not include zero volts differential. To comply with the RS-422 and RS-485 standards, the receiver output *must* output a High when the differential input V_{ID} is more positive than +200 mV, and *must* output a Low when the V_{ID} is more negative than -200 mV. The receiver parameters which determine the failsafe performance are V_{IT+} and V_{IT-} and V_{HYS} . As seen in the [Receiver Electrical Characteristics](#) table, differential signals more negative than -200 mV will always cause a Low receiver output. Similarly, differential signals more positive than +200 mV will *always* cause a High receiver output.

When the differential input signal is close to zero, it will still be above the V_{IT+} threshold, and the receiver output is High. Only when the differential input is more negative than V_{IT-} will the receiver output transition to a Low state. So, the noise immunity of the receiver inputs during a bus fault condition includes the receiver hysteresis value V_{HYS} (the separation between V_{IT+} and V_{IT-} .) as well as the value of V_{IT+} .

EQUIVALENT INPUT AND OUTPUT SCHEMATIC DIAGRAMS

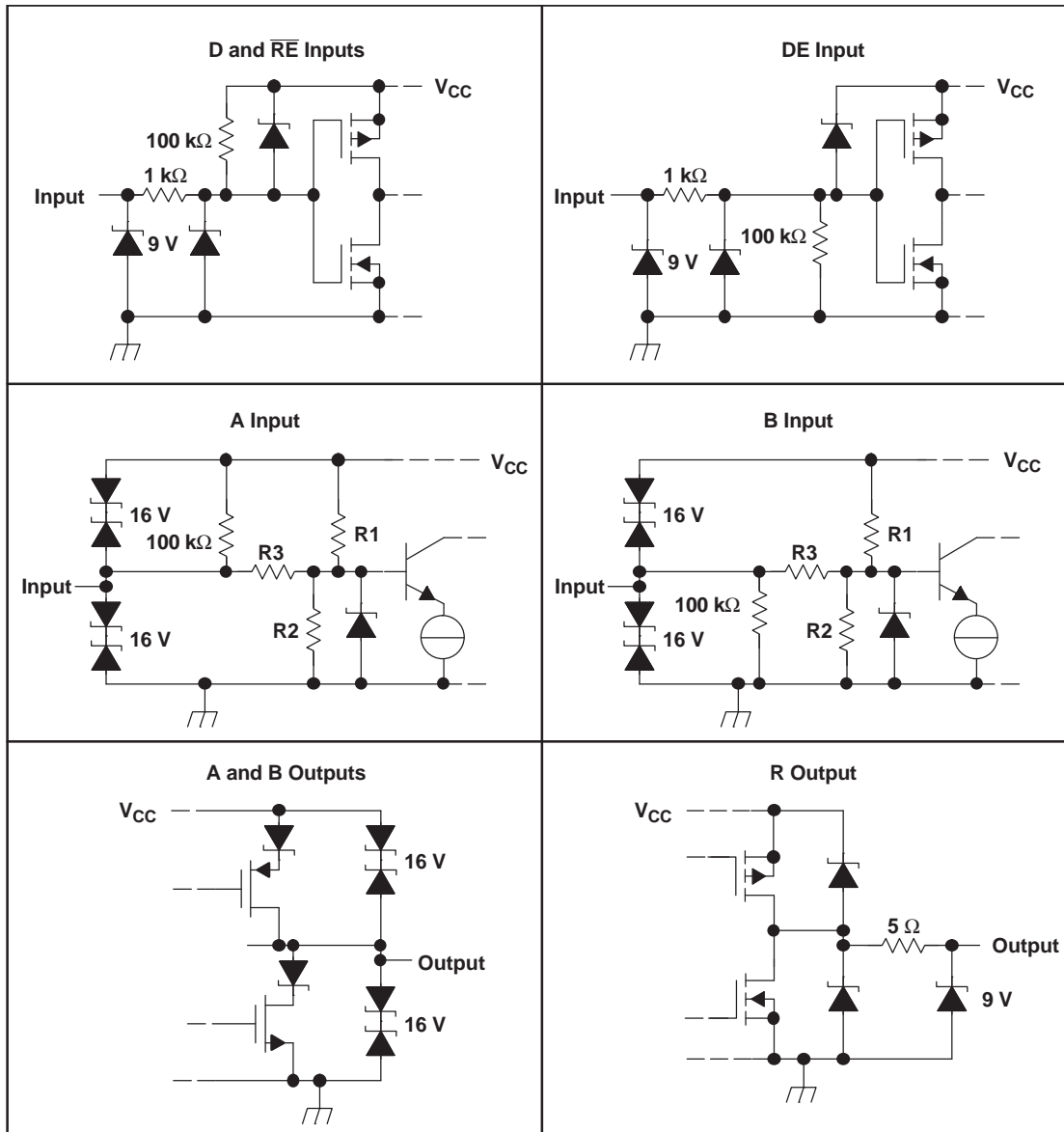

	R1/R2	R3
SN65HVD05	9 kΩ	45 kΩ
SN65HVD06	36 kΩ	180 kΩ
SN65HVD07	36 kΩ	180 kΩ

TYPICAL CHARACTERISTICS

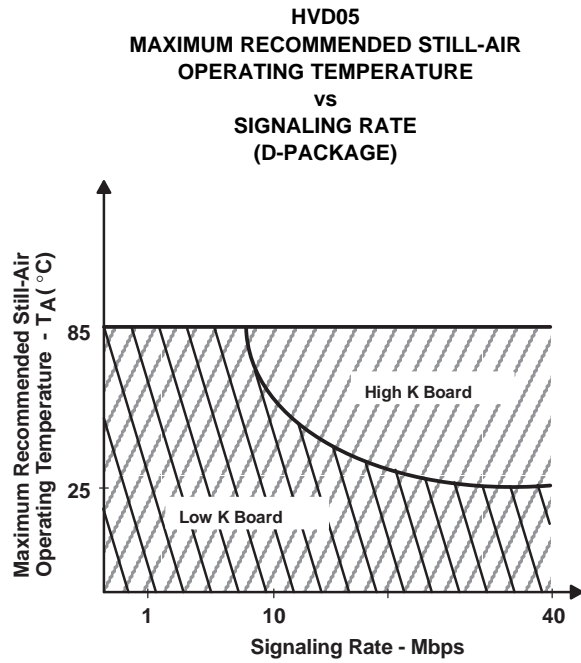

Figure 12.

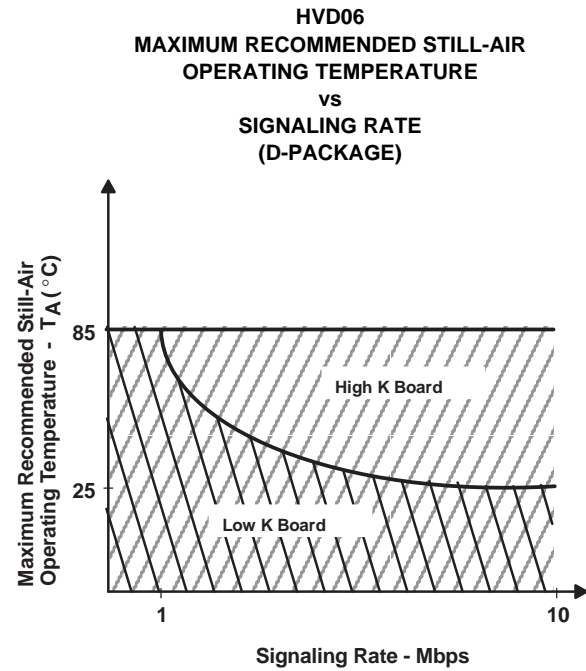

Figure 13.

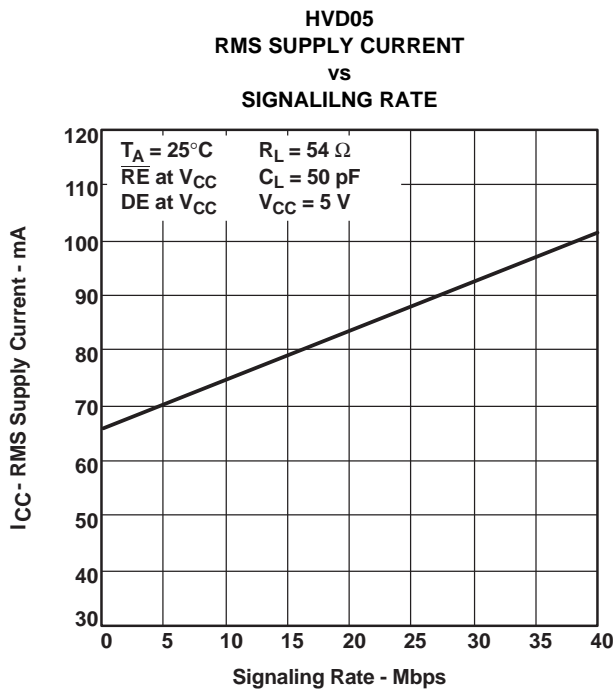

Figure 14.

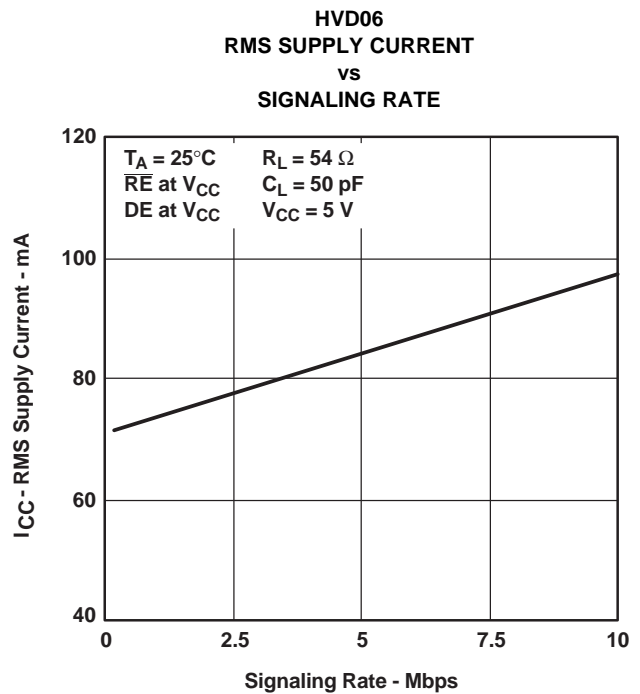

Figure 15.

TYPICAL CHARACTERISTICS (continued)

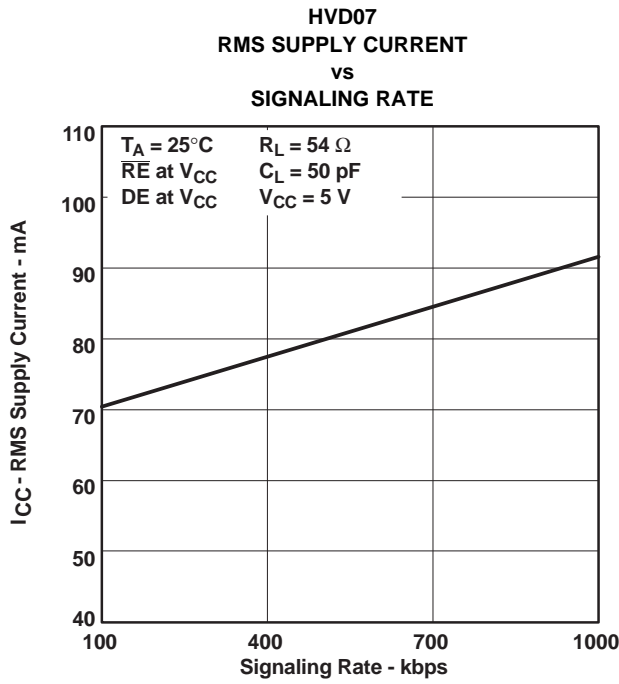

Figure 16.

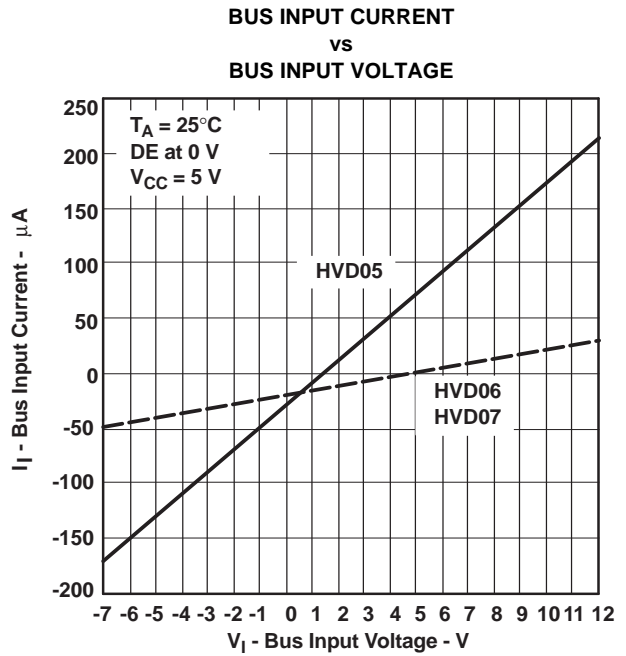

Figure 17.

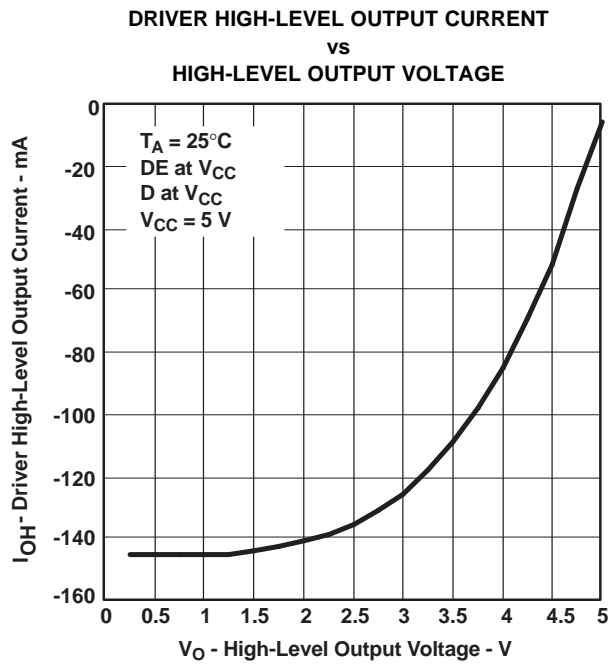

Figure 18.

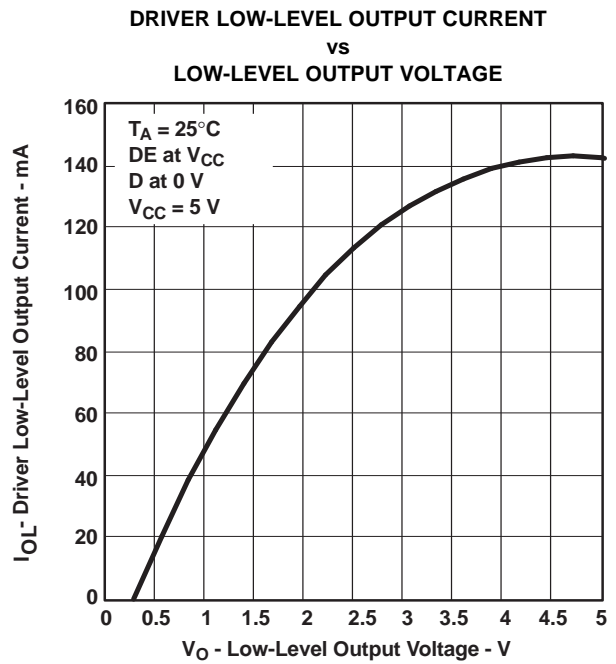
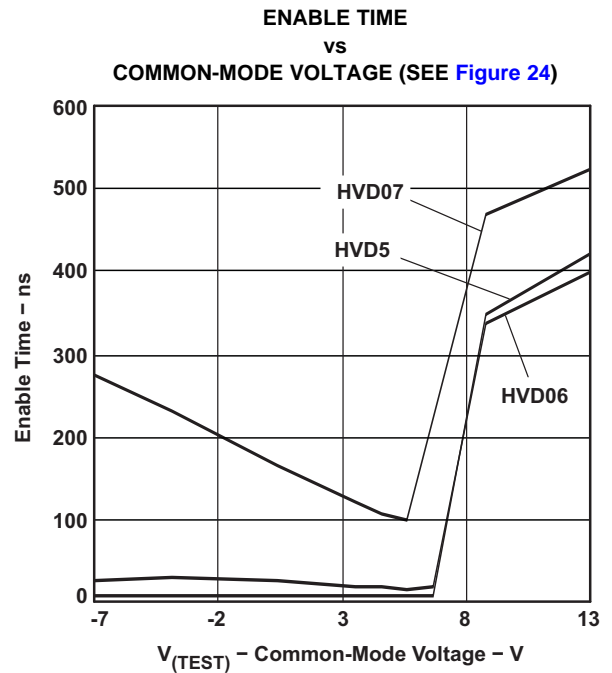
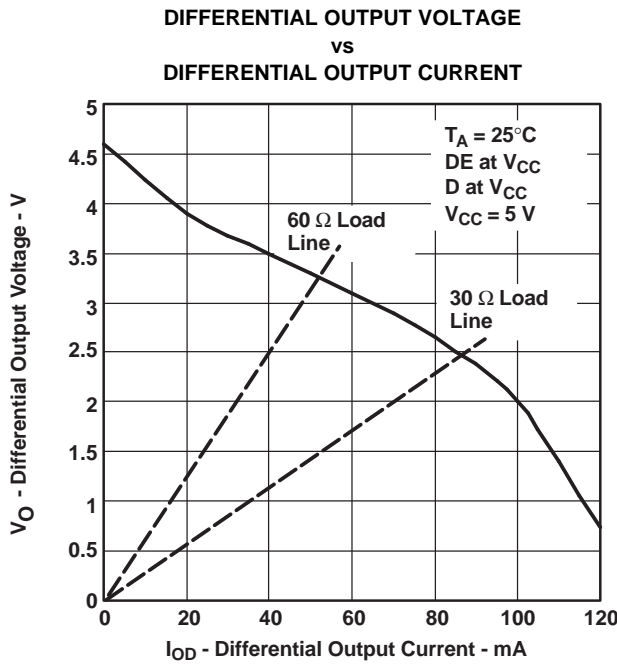
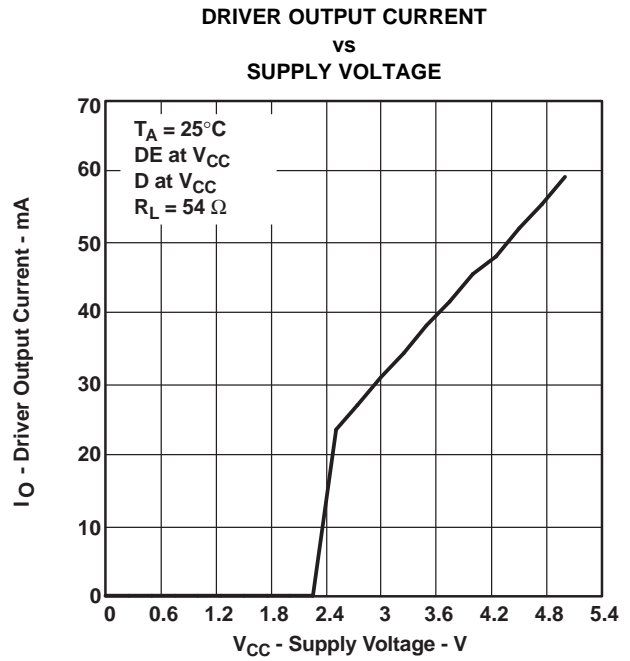
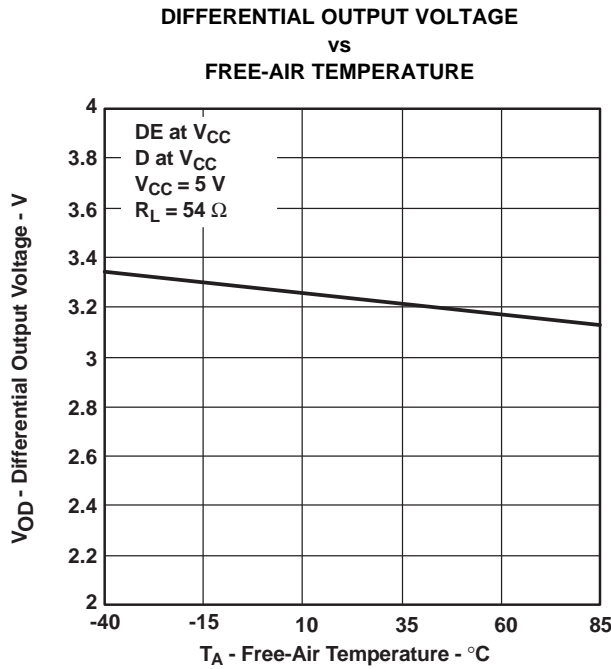

Figure 19.

TYPICAL CHARACTERISTICS (continued)



TYPICAL CHARACTERISTICS (continued)

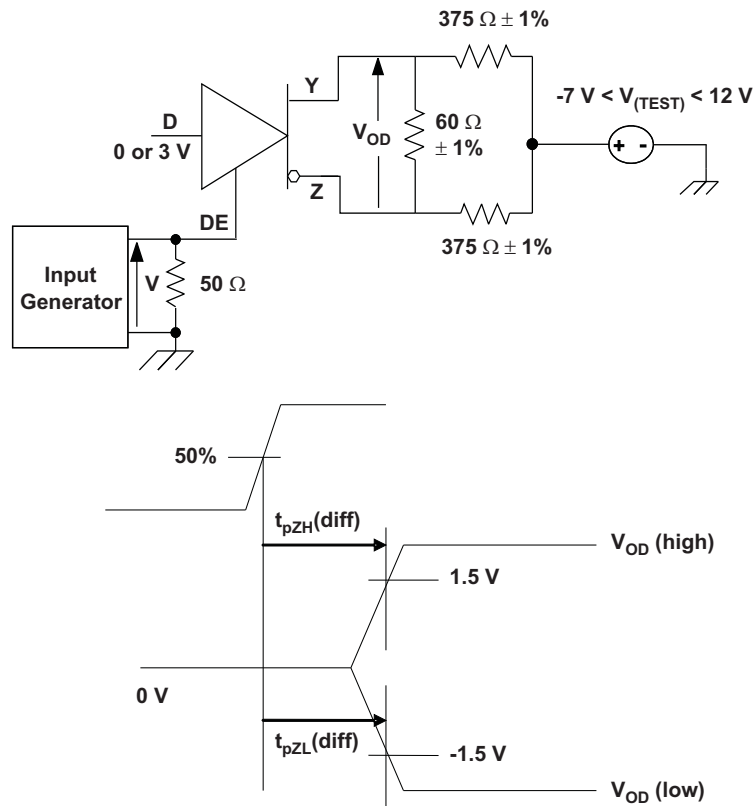
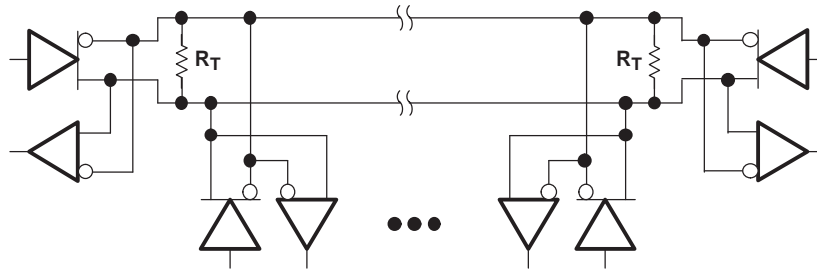

Figure 24. Driver Enable Time From DE to V_{OD}

The time t_{pZL(x)} is the measure from DE to V_{OD(x)}. V_{OD} is valid when it is greater than 1.5 V.

APPLICATION INFORMATION



Device	Number of Devices on Bus
HVD05	64
HVD06	256
HVD07	256

NOTE: The line should be terminated at both ends with its characteristic impedance ($R_T = Z_0$).
Stub lengths off the main line should be kept as short as possible.

Figure 25. Typical Application Circuit

REVISION HISTORY

Changes from Revision D (July 2006) to Revision E	Page
• Added IDLE Bus to the Receivers Function Table	11
• Added the Receiver Failsafe paragraph.	11

PACKAGING INFORMATION

Orderable Device	Status (1)	Package Type	Package Drawing	Pins	Package Qty	Eco Plan (2)	Lead finish/ Ball material (6)	MSL Peak Temp (3)	Op Temp (°C)	Device Marking (4/5)	Samples
SN65HVD05D	ACTIVE	SOIC	D	8	75	RoHS & Green	NIPDAU	Level-1-260C-UNLIM	-40 to 85	VP05	Samples
SN65HVD05DR	ACTIVE	SOIC	D	8	2500	RoHS & Green	NIPDAU	Level-1-260C-UNLIM	-40 to 85	VP05	Samples
SN65HVD05P	ACTIVE	PDIP	P	8	50	RoHS & Green	NIPDAU	N / A for Pkg Type	-40 to 85	65HVD05	Samples
SN65HVD06D	ACTIVE	SOIC	D	8	75	RoHS & Green	NIPDAU	Level-1-260C-UNLIM	-40 to 85	VP06	Samples
SN65HVD06DG4	ACTIVE	SOIC	D	8	75	RoHS & Green	NIPDAU	Level-1-260C-UNLIM	-40 to 85	VP06	Samples
SN65HVD06DR	ACTIVE	SOIC	D	8	2500	RoHS & Green	NIPDAU	Level-1-260C-UNLIM	-40 to 85	VP06	Samples
SN65HVD06P	ACTIVE	PDIP	P	8	50	RoHS & Green	NIPDAU	N / A for Pkg Type	-40 to 85	65HVD06	Samples
SN65HVD07D	ACTIVE	SOIC	D	8	75	RoHS & Green	NIPDAU	Level-1-260C-UNLIM	-40 to 85	VP07	Samples
SN65HVD07DR	ACTIVE	SOIC	D	8	2500	RoHS & Green	NIPDAU	Level-1-260C-UNLIM	-40 to 85	VP07	Samples
SN65HVD07P	ACTIVE	PDIP	P	8	50	RoHS & Green	NIPDAU	N / A for Pkg Type	-40 to 85	65HVD07	Samples
SN75HVD05D	ACTIVE	SOIC	D	8	75	RoHS & Green	NIPDAU	Level-1-260C-UNLIM	0 to 70	VN05	Samples
SN75HVD05P	ACTIVE	PDIP	P	8	50	RoHS & Green	NIPDAU	N / A for Pkg Type	0 to 70	75HVD05	Samples
SN75HVD06D	ACTIVE	SOIC	D	8	75	RoHS & Green	NIPDAU	Level-1-260C-UNLIM	0 to 70	VN06	Samples
SN75HVD06DR	ACTIVE	SOIC	D	8	2500	RoHS & Green	NIPDAU	Level-1-260C-UNLIM	0 to 70	VN06	Samples
SN75HVD07D	ACTIVE	SOIC	D	8	75	RoHS & Green	NIPDAU	Level-1-260C-UNLIM	0 to 70	VN07	Samples
SN75HVD07DR	ACTIVE	SOIC	D	8	2500	RoHS & Green	NIPDAU	Level-1-260C-UNLIM	0 to 70	VN07	Samples
SN75HVD07P	ACTIVE	PDIP	P	8	50	RoHS & Green	NIPDAU	N / A for Pkg Type	0 to 70	75HVD07	Samples

(1) The marketing status values are defined as follows:

ACTIVE: Product device recommended for new designs.

LIFEBUY: TI has announced that the device will be discontinued, and a lifetime-buy period is in effect.

NRND: Not recommended for new designs. Device is in production to support existing customers, but TI does not recommend using this part in a new design.

PREVIEW: Device has been announced but is not in production. Samples may or may not be available.

OBSOLETE: TI has discontinued the production of the device.

(2) RoHS: TI defines "RoHS" to mean semiconductor products that are compliant with the current EU RoHS requirements for all 10 RoHS substances, including the requirement that RoHS substance do not exceed 0.1% by weight in homogeneous materials. Where designed to be soldered at high temperatures, "RoHS" products are suitable for use in specified lead-free processes. TI may reference these types of products as "Pb-Free".

RoHS Exempt: TI defines "RoHS Exempt" to mean products that contain lead but are compliant with EU RoHS pursuant to a specific EU RoHS exemption.

Green: TI defines "Green" to mean the content of Chlorine (Cl) and Bromine (Br) based flame retardants meet JS709B low halogen requirements of ≤ 1000 ppm threshold. Antimony trioxide based flame retardants must also meet the ≤ 1000 ppm threshold requirement.

(3) MSL, Peak Temp. - The Moisture Sensitivity Level rating according to the JEDEC industry standard classifications, and peak solder temperature.

(4) There may be additional marking, which relates to the logo, the lot trace code information, or the environmental category on the device.

(5) Multiple Device Markings will be inside parentheses. Only one Device Marking contained in parentheses and separated by a "~" will appear on a device. If a line is indented then it is a continuation of the previous line and the two combined represent the entire Device Marking for that device.

(6) Lead finish/Ball material - Orderable Devices may have multiple material finish options. Finish options are separated by a vertical ruled line. Lead finish/Ball material values may wrap to two lines if the finish value exceeds the maximum column width.

Important Information and Disclaimer: The information provided on this page represents TI's knowledge and belief as of the date that it is provided. TI bases its knowledge and belief on information provided by third parties, and makes no representation or warranty as to the accuracy of such information. Efforts are underway to better integrate information from third parties. TI has taken and continues to take reasonable steps to provide representative and accurate information but may not have conducted destructive testing or chemical analysis on incoming materials and chemicals. TI and TI suppliers consider certain information to be proprietary, and thus CAS numbers and other limited information may not be available for release.

In no event shall TI's liability arising out of such information exceed the total purchase price of the TI part(s) at issue in this document sold by TI to Customer on an annual basis.

TAPE AND REEL INFORMATION

QUADRANT ASSIGNMENTS FOR PIN 1 ORIENTATION IN TAPE



*All dimensions are nominal

Device	Package Type	Package Drawing	Pins	SPQ	Reel Diameter (mm)	Reel Width W1 (mm)	A0 (mm)	B0 (mm)	K0 (mm)	P1 (mm)	W (mm)	Pin1 Quadrant
SN65HVD05DR	SOIC	D	8	2500	330.0	12.4	6.4	5.2	2.1	8.0	12.0	Q1
SN65HVD06DR	SOIC	D	8	2500	330.0	12.4	6.4	5.2	2.1	8.0	12.0	Q1
SN65HVD07DR	SOIC	D	8	2500	330.0	12.4	6.4	5.2	2.1	8.0	12.0	Q1
SN75HVD06DR	SOIC	D	8	2500	330.0	12.4	6.4	5.2	2.1	8.0	12.0	Q1
SN75HVD07DR	SOIC	D	8	2500	330.0	12.4	6.4	5.2	2.1	8.0	12.0	Q1

TAPE AND REEL BOX DIMENSIONS

*All dimensions are nominal

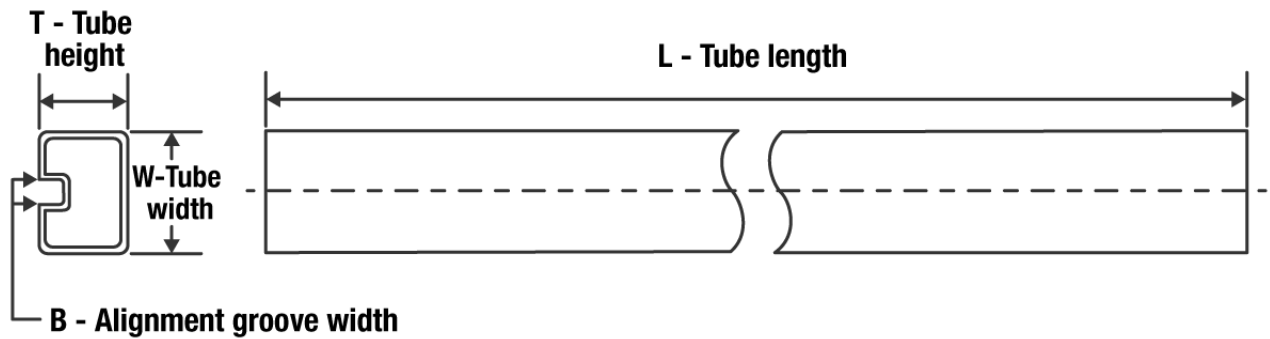
Device	Package Type	Package Drawing	Pins	SPQ	Length (mm)	Width (mm)	Height (mm)
SN65HVD05DR	SOIC	D	8	2500	340.5	336.1	25.0
SN65HVD06DR	SOIC	D	8	2500	340.5	336.1	25.0
SN65HVD07DR	SOIC	D	8	2500	340.5	336.1	25.0
SN75HVD06DR	SOIC	D	8	2500	340.5	336.1	25.0
SN75HVD07DR	SOIC	D	8	2500	340.5	336.1	25.0

TUBE

*All dimensions are nominal

Device	Package Name	Package Type	Pins	SPQ	L (mm)	W (mm)	T (μm)	B (mm)
SN65HVD05D	D	SOIC	8	75	507	8	3940	4.32
SN65HVD05P	P	PDIP	8	50	506	13.97	11230	4.32
SN65HVD06D	D	SOIC	8	75	507	8	3940	4.32
SN65HVD06DG4	D	SOIC	8	75	507	8	3940	4.32
SN65HVD06P	P	PDIP	8	50	506	13.97	11230	4.32
SN65HVD07D	D	SOIC	8	75	507	8	3940	4.32
SN65HVD07P	P	PDIP	8	50	506	13.97	11230	4.32
SN75HVD05D	D	SOIC	8	75	507	8	3940	4.32
SN75HVD05P	P	PDIP	8	50	506	13.97	11230	4.32
SN75HVD06D	D	SOIC	8	75	507	8	3940	4.32
SN75HVD07D	D	SOIC	8	75	507	8	3940	4.32
SN75HVD07P	P	PDIP	8	50	506	13.97	11230	4.32



D0008A

PACKAGE OUTLINE

SOIC - 1.75 mm max height

SMALL OUTLINE INTEGRATED CIRCUIT



4214825/C 02/2019

NOTES:

1. Linear dimensions are in inches [millimeters]. Dimensions in parenthesis are for reference only. Controlling dimensions are in inches. Dimensioning and tolerancing per ASME Y14.5M.
2. This drawing is subject to change without notice.
3. This dimension does not include mold flash, protrusions, or gate burrs. Mold flash, protrusions, or gate burrs shall not exceed .006 [0.15] per side.
4. This dimension does not include interlead flash.
5. Reference JEDEC registration MS-012, variation AA.

EXAMPLE BOARD LAYOUT

D0008A

SOIC - 1.75 mm max height

SMALL OUTLINE INTEGRATED CIRCUIT



LAND PATTERN EXAMPLE
EXPOSED METAL SHOWN
SCALE:8X



SOLDER MASK DETAILS

4214825/C 02/2019

NOTES: (continued)

6. Publication IPC-7351 may have alternate designs.

7. Solder mask tolerances between and around signal pads can vary based on board fabrication site.

EXAMPLE STENCIL DESIGN

D0008A

SOIC - 1.75 mm max height

SMALL OUTLINE INTEGRATED CIRCUIT



SOLDER PASTE EXAMPLE
BASED ON .005 INCH [0.125 MM] THICK STENCIL
SCALE:8X

4214825/C 02/2019

NOTES: (continued)

8. Laser cutting apertures with trapezoidal walls and rounded corners may offer better paste release. IPC-7525 may have alternate design recommendations.
9. Board assembly site may have different recommendations for stencil design.

P (R-PDIP-T8)

PLASTIC DUAL-IN-LINE PACKAGE

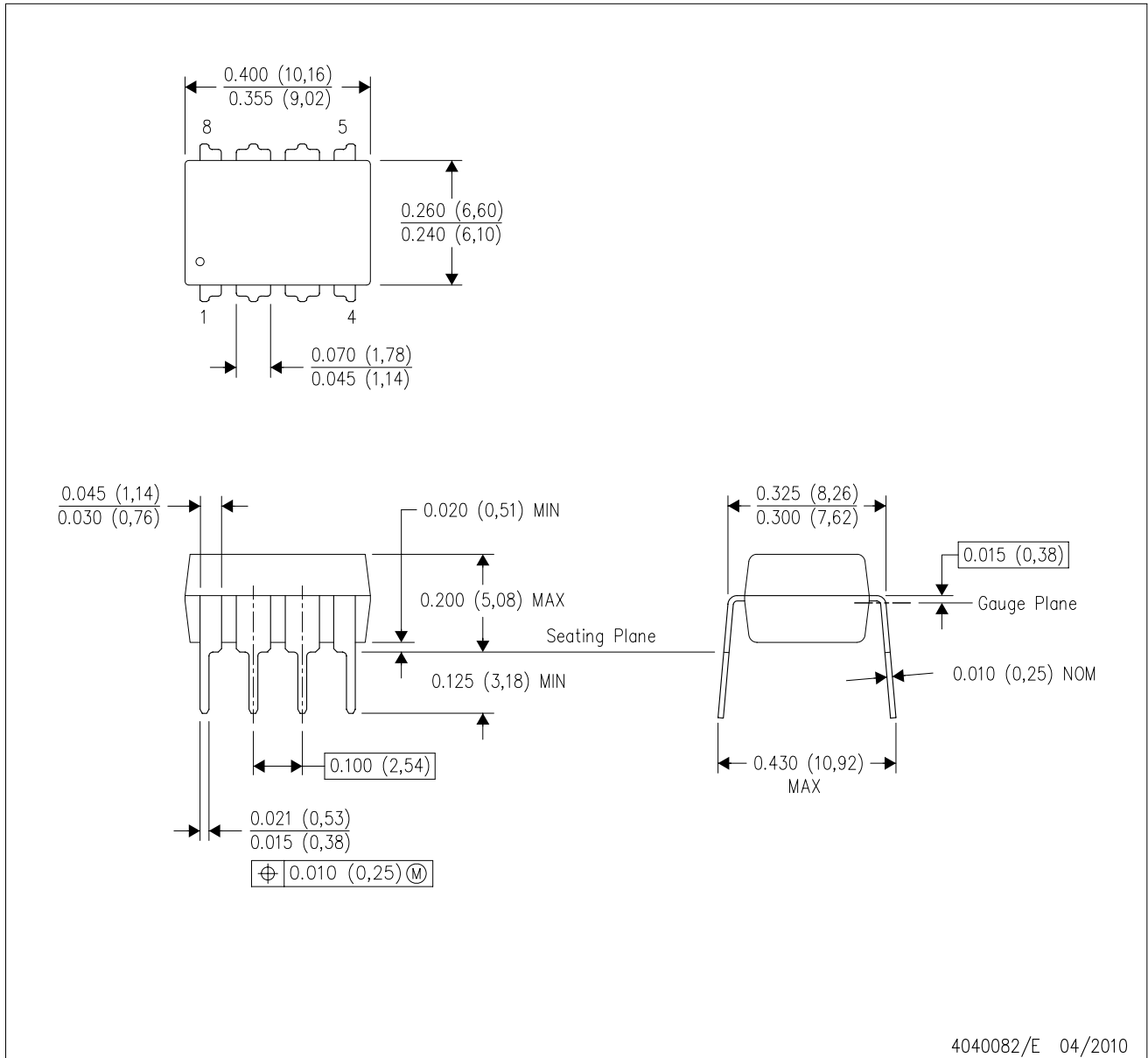

- NOTES:
- A. All linear dimensions are in inches (millimeters).
 - B. This drawing is subject to change without notice.
 - C. Falls within JEDEC MS-001 variation BA.

IMPORTANT NOTICE AND DISCLAIMER

TI PROVIDES TECHNICAL AND RELIABILITY DATA (INCLUDING DATA SHEETS), DESIGN RESOURCES (INCLUDING REFERENCE DESIGNS), APPLICATION OR OTHER DESIGN ADVICE, WEB TOOLS, SAFETY INFORMATION, AND OTHER RESOURCES "AS IS" AND WITH ALL FAULTS, AND DISCLAIMS ALL WARRANTIES, EXPRESS AND IMPLIED, INCLUDING WITHOUT LIMITATION ANY IMPLIED WARRANTIES OF MERCHANTABILITY, FITNESS FOR A PARTICULAR PURPOSE OR NON-INFRINGEMENT OF THIRD PARTY INTELLECTUAL PROPERTY RIGHTS.

These resources are intended for skilled developers designing with TI products. You are solely responsible for (1) selecting the appropriate TI products for your application, (2) designing, validating and testing your application, and (3) ensuring your application meets applicable standards, and any other safety, security, regulatory or other requirements.

These resources are subject to change without notice. TI grants you permission to use these resources only for development of an application that uses the TI products described in the resource. Other reproduction and display of these resources is prohibited. No license is granted to any other TI intellectual property right or to any third party intellectual property right. TI disclaims responsibility for, and you will fully indemnify TI and its representatives against, any claims, damages, costs, losses, and liabilities arising out of your use of these resources.

TI's products are provided subject to [TI's Terms of Sale](#) or other applicable terms available either on ti.com or provided in conjunction with such TI products. TI's provision of these resources does not expand or otherwise alter TI's applicable warranties or warranty disclaimers for TI products.

TI objects to and rejects any additional or different terms you may have proposed.

Mailing Address: Texas Instruments, Post Office Box 655303, Dallas, Texas 75265
Copyright © 2022, Texas Instruments Incorporated