

TPD1E10B09-Q1 采用 0402 封装、电容为 10pF 且击穿电压为 9V 的单通道静电放电 (ESD)

1 特性

- 符合 AEC-Q101
- IEC 61000-4-2 4 级 ESD 保护
 - ±20kV 接触放电
 - ±20kV 气隙放电
- ISO 10605 (330pF, 330Ω) ESD 保护
 - ±8kV 接触放电
 - ±15kV 气隙放电
- IEC 61000-4-5 浪涌保护
 - 4.5A (8/20μs)
- I/O 电容: 10pF (典型值)
- R_{DYN}: 0.5Ω (典型值)
- 直流击穿电压: ±9.5V (最小值)
- 超低泄漏电流: 100nA (最大值)
- 钳位电压: 13V (I_{PP} = 1A 时的典型值)
- 工业温度范围: -40°C 至 +125°C
- 节省空间的 0402 封装

2 应用

- 终端设备:
 - 音响主机
 - 高级音频设备
 - 外部放大器
 - 车身控制模块
 - 网关
 - 车载信息服务系统
 - 摄像机模块
- 接口:
 - 音频线路
 - 按钮
 - 存储器接口
 - 通用输入/输出 (GPIO)

3 说明

TPD1E10B09-Q1 器件是一款采用小型 0402 工业标准封装的双向静电放电 (ESD) 瞬态电压抑制 (TVS) 二极管。该 TVS 保护二极管便于将元件安装到空间受限的应用中，并具有较低的 R_{DYN} 和较高的 IEC 额定值。TPD1E10B09-Q1 的额定 ESD 冲击消散值高于 IEC 61000-4-2 4 级国际标准中规定的最高水平，可以提供 ±20kV 接触放电和 ±20kV IEC 气隙保护。ESD 电压可轻松达到 5kV，并且在极端条件下，这些电压能够显著升高，从而对许多集成电路造成损坏。例如，在湿度较低的环境下，电压可超过 20kV。

低动态电阻 (0.5Ω) 和低钳位电压 (1A IPP 时为 13V) 可确保提供系统级瞬变事件保护，从而为暴露于 ESD 事件下的设计提供强有力的保护。该器件还具有一个 10pF IO 电容，因此非常适用于音频线路、按钮、存储器接口或 GPIO。

该器件还具有一款非汽车类应用型号: [TPD1E10B09](#)。

器件信息⁽¹⁾

| 器件型号 | 封装 | 封装尺寸 (标称值) |
|---|-----------|-----------------|
| TPD1E10B09-Q1 | X1SON (2) | 0.60mm x 1.00mm |
| TPD1E10B09 ⁽²⁾ | X1SON (2) | 0.60mm x 1.00mm |

(1) 要了解所有可用封装，请见数据表末尾的可订购产品附录。

(2) 该器件不属于 TPD1E10B09-Q1 数据表，有关所有电气参数和器件特性的信息，请参见 [TPD1E10B09](#)。

应用电路原理图

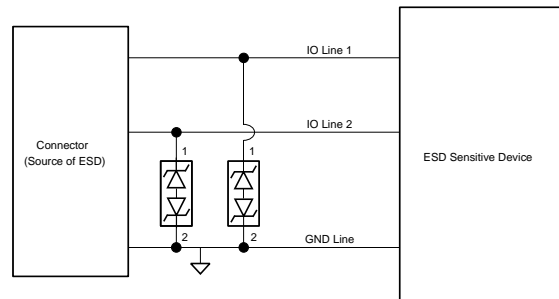

Copyright © 2016, Texas Instruments Incorporated



目录

| | | | | | |
|----------|--|----------|-----------|---|-----------|
| 1 | 特性 | 1 | 7.3 | Feature Description | 8 |
| 2 | 应用 | 1 | 7.4 | Device Functional Modes | 9 |
| 3 | 说明 | 1 | 8 | Application and Implementation | 10 |
| 4 | 修订历史记录 | 2 | 8.1 | Application Information | 10 |
| 5 | Pin Configuration and Functions | 3 | 8.2 | Typical Application | 10 |
| 6 | Specifications | 4 | 9 | Power Supply Recommendations | 12 |
| 6.1 | Absolute Maximum Ratings | 4 | 10 | Layout | 12 |
| 6.2 | ESD Ratings—AEC Specification | 4 | 10.1 | Layout Guidelines | 12 |
| 6.3 | ESD Ratings—IEC Specification | 4 | 10.2 | Layout Example | 12 |
| 6.4 | ESD Ratings—ISO Specification | 4 | 11 | 器件和文档支持 | 13 |
| 6.5 | Recommended Operating Conditions | 4 | 11.1 | 文档支持 | 13 |
| 6.6 | Thermal Information | 4 | 11.2 | 接收文档更新通知 | 13 |
| 6.7 | Electrical Characteristics | 5 | 11.3 | 社区资源 | 13 |
| 6.8 | Typical Characteristics | 6 | 11.4 | 商标 | 13 |
| 7 | Detailed Description | 8 | 11.5 | 静电放电警告 | 13 |
| 7.1 | Overview | 8 | 11.6 | Glossary | 13 |
| 7.2 | Functional Block Diagram | 8 | 12 | 机械、封装和可订购信息 | 14 |

4 修订历史记录

Changes from Original (August 2016) to Revision A

Page

| | |
|------------------------------|---|
| • 已更改 器件状态，从产品预览改为量产数据 | 1 |
|------------------------------|---|

5 Pin Configuration and Functions

**DPY Package
2-Pin X1SON
Top View**

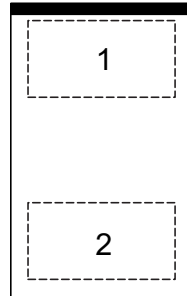

Pin Functions

| PIN | | I/O | DESCRIPTION |
|-----|------|--------|---------------------------|
| NO. | NAME | | |
| 1 | IO | I/O | ESD protected I/O |
| 2 | GND | Ground | Ground. Connect to ground |

6 Specifications

6.1 Absolute Maximum Ratings

over operating free-air temperature range (unless otherwise noted)⁽¹⁾

| | MIN | MAX | UNIT |
|---|-----|-----|------|
| I _{PP} Peak pulse current (tp = 8/20 μs, positive) | | 5.5 | A |
| I _{PP} Peak pulse current (tp = 8/20 μs, negative) | | 4.5 | A |
| P _{PP} Peak pulse power (tp = 8/20 μs) | | 90 | W |
| P Power Dissipation ⁽²⁾ | | 162 | mW |
| Operating temperature | −40 | 125 | °C |
| T _{stg} Storage temperature | −65 | 155 | °C |

- Stresses beyond those listed under *Absolute Maximum Ratings* may cause permanent damage to the device. These are stress ratings only, which do not imply functional operation of the device at these or any other conditions beyond those indicated under *Recommended Operating Conditions*. Exposure to absolute-maximum-rated conditions for extended periods may affect device reliability.
- Max junction temperature: 125°C; power dissipation calculated at 25°C ambient temperature using JEDEC High K board Standard. Not to be used for steady state power dissipation in the breakdown region.

6.2 ESD Ratings—AEC Specification

| | VALUE | UNIT |
|--|---|-------|
| V _(ESD) Electrostatic discharge | Human-body model (HBM), per AEC Q100-002 ⁽¹⁾ | ±2500 |
| | Charged-device model (CDM), per AEC Q100-011 | ±1000 |

- AEC Q100-002 indicates that HBM stressing shall be in accordance with the ANSI/ESDA/JEDEC JS-001 specification.

6.3 ESD Ratings—IEC Specification

| | VALUE | UNIT |
|--|---------------------------------|--------|
| V _(ESD) Electrostatic discharge | IEC 61000-4-2 Contact Discharge | ±20000 |
| | IEC 61000-4-2 Air-Gap Discharge | ±20000 |

6.4 ESD Ratings—ISO Specification

| | VALUE | UNIT |
|--|---|--------|
| V _(ESD) Electrostatic discharge | ISO 10605 (330 pF, 330 Ω) Contact Discharge | ±8000 |
| | ISO 10605 (330 pF, 330 Ω) Air-Gap Discharge | ±15000 |

6.5 Recommended Operating Conditions

over operating free-air temperature range (unless otherwise noted)

| | MIN | MAX | UNIT |
|---|-----|-----|------|
| T _A Operating free-air temperature | −40 | 125 | °C |
| Operating voltage | −9 | 9 | V |

6.6 Thermal Information

| THERMAL METRIC ⁽¹⁾ | TPD1E10B09-Q1 | UNIT |
|---|---------------|------|
| | DPY (X1SON) | |
| | 2 PINS | |
| R _{θJA} Junction-to-ambient thermal resistance | 615.5 | °C/W |
| R _{θJC(top)} Junction-to-case (top) thermal resistance | 404.8 | °C/W |
| R _{θJB} Junction-to-board thermal resistance | 493.3 | °C/W |
| ψ _{JT} Junction-to-top characterization parameter | 127.7 | °C/W |
| ψ _{JB} Junction-to-board characterization parameter | 493.3 | °C/W |

- For more information about traditional and new thermal metrics, see the [Semiconductor and IC Package Thermal Metrics](#) application report.

6.7 Electrical Characteristics

over operating free-air temperature range (unless otherwise noted)

| PARAMETER | | TEST CONDITION | MIN | TYP | MAX | UNIT |
|----------------|--|---|-----|-----|-----|----------|
| V_{RWM} | Reverse stand-off voltage | Pin 1 to 2 or pin 2 to 1 | | | 9 | V |
| I_{LEAK} | Leakage current | Pin 1 = 5 V, pin 2 = 0 V | | | 100 | nA |
| $V_{Clamp1,2}$ | Clamp voltage with ESD strike on pin 1, pin 2 grounded | $I_{PP} = 1\text{ A}$, $t_p = 8/20\ \mu\text{s}^{(1)}$ | | 13 | | V |
| | | $I_{PP} = 5\text{ A}$, $t_p = 8/20\ \mu\text{s}^{(1)}$ | | 17 | | |
| $V_{Clamp2,1}$ | Clamp voltage with ESD strike on pin 2, pin 1 grounded | $I_{PP} = 1\text{ A}$, $t_p = 8/20\ \mu\text{s}^{(1)}$ | | 13 | | V |
| | | $I_{PP} = 4.5\text{ A}$, $t_p = 8/20\ \mu\text{s}^{(1)}$ | | 20 | | |
| R_{DYN} | Dynamic resistance | Pin 1 to pin 2 ⁽²⁾ | | 0.5 | | Ω |
| | | Pin 2 to pin 1 ⁽²⁾ | | 0.5 | | |
| C_{IO} | I/O capacitance | $V_{IO} = 2.5\text{ V}$; $f = 1\text{ MHz}$ | | 10 | | pF |
| $V_{BR1,2}$ | Break-down voltage, pin 1 to pin 2 | $I_{IO} = 1\text{ mA}$ | 9.5 | | | V |
| $V_{BR2,1}$ | Break-down voltage, pin 2 to pin 1 | $I_{IO} = 1\text{ mA}$ | 9.5 | | | V |

- (1) Non-repetitive current pulse 8/20 μs exponentially decaying waveform according to IEC 61000-4-5.
 (2) Extraction of R_{DYN} using least squares fit of TLP characteristics from $I_{PP} = 10\text{ A}$ to $I_{PP} = 20\text{ A}$.

6.8 Typical Characteristics

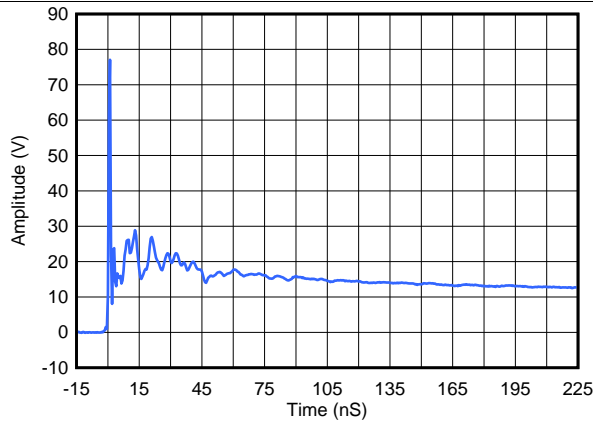

Figure 1. ESD Clamp Voltage 8-kV Contact ESD

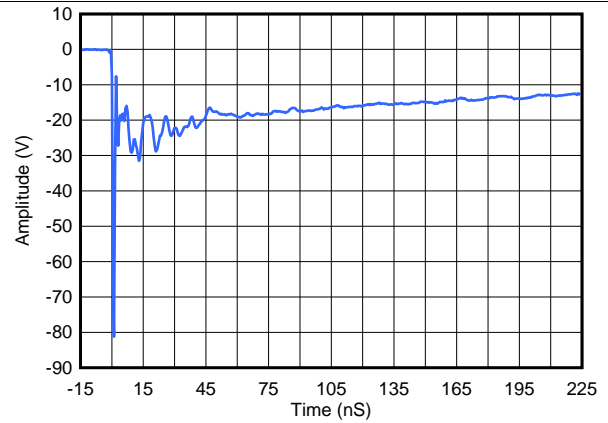

Figure 2. ESD Clamp Voltage -8-kV Contact ESD

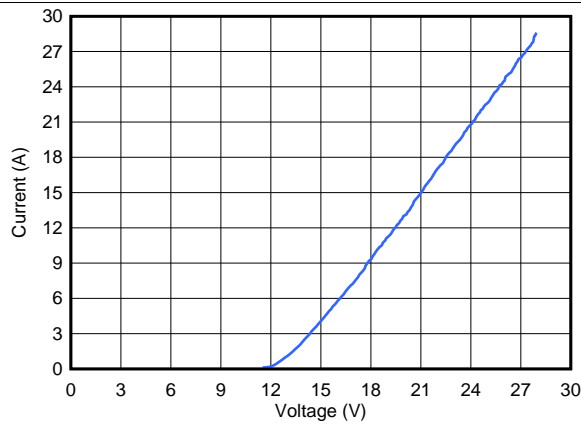

Figure 3. Transmission Line Pulse (TLP) Waveform Pin 1 to Pin 2

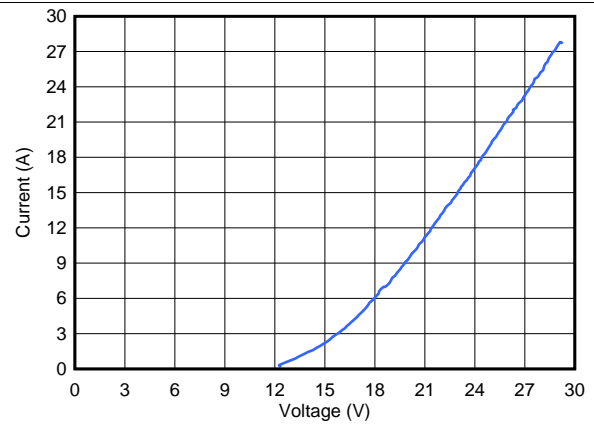

Figure 4. Transmission Line Pulse (TLP) Waveform Pin 2 to Pin 1

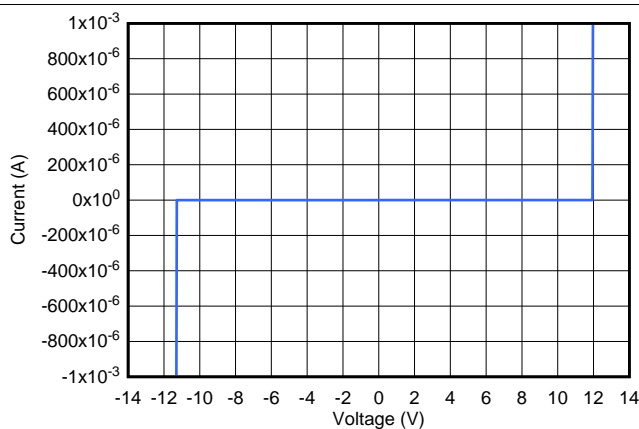

Figure 5. IV Curve

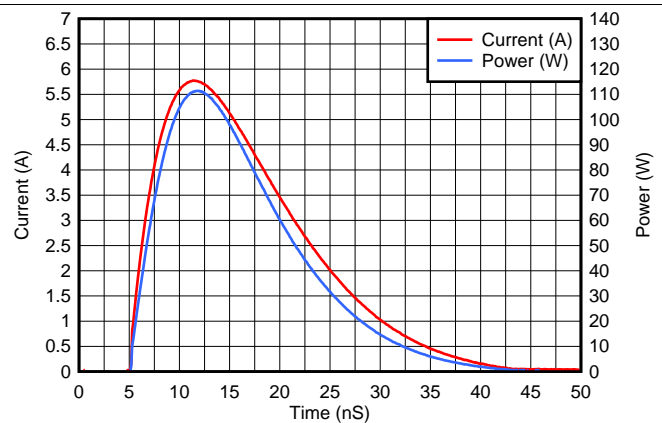
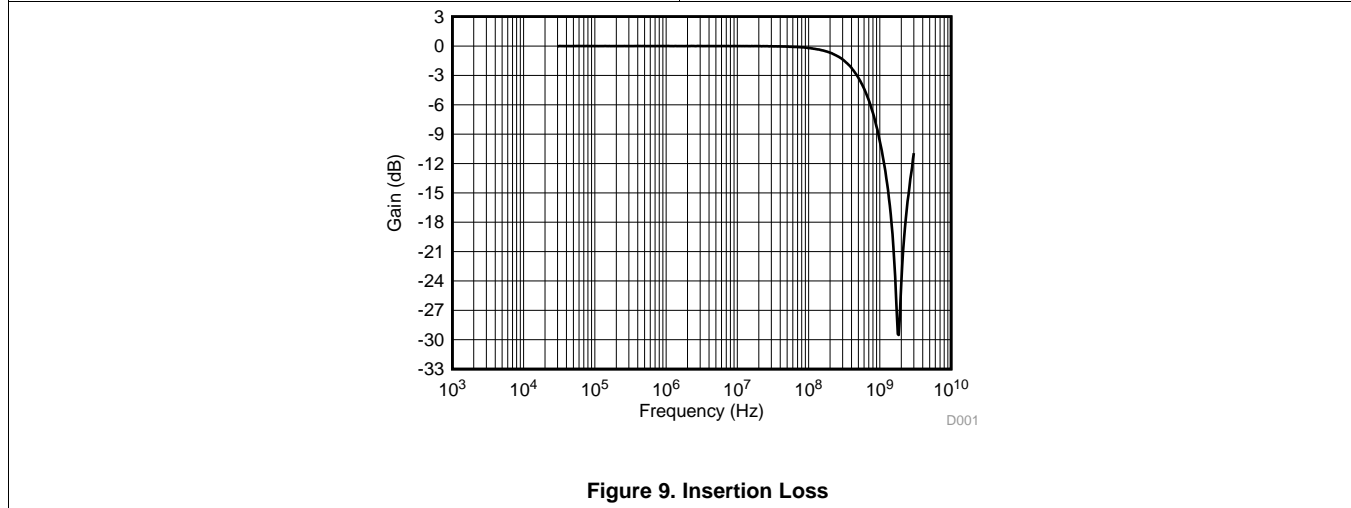
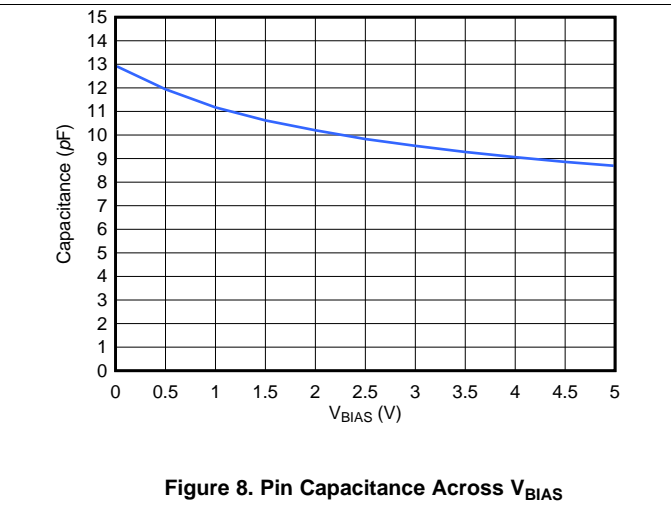
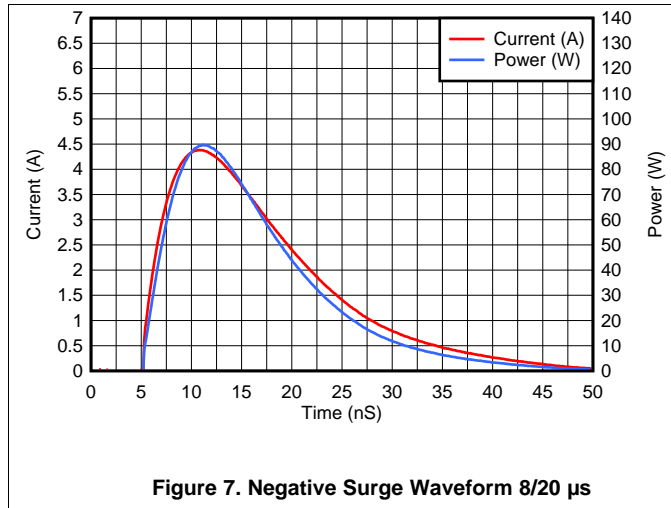

Figure 6. Positive Surge Waveform 8/20 μs

Typical Characteristics (continued)



7 Detailed Description

7.1 Overview

The TPD1E10B09-Q1 is a single-channel ESD TVS that provides ± 20 -kV IEC 61000-4-2 (Level 4) contact and air-gap ESD protection. The 10-pF back-to-back diode architecture is suitable for signals that range from -9 V to 9 V and supports data rates up to 500 Mbps. The industry-standard 0402 package is convenient for placement in applications with limited space.

7.2 Functional Block Diagram



Copyright © 2016, Texas Instruments Incorporated

7.3 Feature Description

The TPD1E10B09-Q1 is a bidirectional TVS with high ESD protection level. This device protects circuit from ESD strikes up to ± 20 -kV contact and ± 20 -kV air-gap specified in the IEC 61000-4-2 level 4 international standard. The device can also handle up to 4.5-A surge current (IEC 61000-4-5 8/20 μ s). The I/O capacitance of 10 pF supports a data rate up to 500 Mbps. This clamping device has a small dynamic resistance of 0.5 Ω typically. This makes the clamping voltage low when the device is actively protecting other circuits. For example, the clamping voltage is only 13 V when the device is taking 1-A transient current. The breakdown is bidirectional so that this protection device is a good fit for GPIO, especially audio lines which carry bidirectional signals. Low leakage allows the diode to conserve power when working below the V_{RWM} . The industrial temperature range of -40°C to $+125^{\circ}\text{C}$ makes this ESD device work at extensive temperatures in most environments. The space-saving 0402 package can fit into small electronic devices like mobile equipment and wearables.

7.3.1 AEC-Q101 Qualified

This device is qualified to AEC-Q101 standards and is qualified to operate from -40°C to $+125^{\circ}\text{C}$.

7.3.2 IEC 61000-4-2 ESD Protection

The I/O pins can withstand ESD events up to ± 20 -kV contact and ± 20 -kV air according to the IEC 61000-4-2 standard. An ESD-surge clamp diverts the current to ground.

7.3.3 ISO 10605 ESD Protection

The I/O pins can withstand ESD events at least ± 8 -kV contact and ± 15 -kV air according to the ISO 10605 (330 pF, 330 Ω) standard. An ESD-surge clamp diverts the current to ground.

7.3.4 IEC 61000-4-5 Surge Protection

The IO pins can withstand surge events up to 5.5 A positive and 4.5 A negative (8/20 μ s waveform). An ESD-surge clamp diverts this current to ground.

7.3.5 IO Capacitance

The capacitance between the I/O pins 10 pF. This capacitance support data rates up to 500 Mbps.

Feature Description (continued)

7.3.6 Dynamic Resistance

The IO pins feature an ESD clamp that has a low R_{DYN} of $0.50\ \Omega$ which prevents system damage during ESD events.

7.3.7 DC Breakdown Voltage

The DC breakdown voltage between the IO pins is a minimum of 9.5 V. This ensures that sensitive equipment is protected from surges above the reverse standoff voltage of 9 V.

7.3.8 Ultra Low Leakage Current

The IO pins feature an ultra-low leakage current of 100 nA (maximum) with a bias of 5 V.

7.3.9 Clamping Voltage

The IO pins feature an ESD clamp that is capable of clamping the voltage to 13 V ($I_{PP} = 1\text{ A}$) and 17 V ($I_{PP} = 5\text{ A}$).

7.3.10 Industrial Temperature Range

This device features an industrial operating range of -40°C to $+125^{\circ}\text{C}$.

7.3.11 Space-Saving Footprint

This device features a space-saving, industry standard 0402 footprint.

7.4 Device Functional Modes

The TPD1E10B09-Q1 is a passive clamp that has low leakage during normal operation when the voltage between pin 1 and pin 2 is below V_{RWM} and activates when the voltage between pin 1 and pin 2 goes above V_{BR} . During IEC ESD events, transient voltages as high as $\pm 20\text{ kV}$ can be clamped between the two pins. When the voltages on the protected lines fall below the trigger voltage, the device reverts back to the low leakage passive state.

8 Application and Implementation

NOTE

Information in the following applications sections is not part of the TI component specification, and TI does not warrant its accuracy or completeness. TI's customers are responsible for determining suitability of components for their purposes. Customers should validate and test their design implementation to confirm system functionality.

8.1 Application Information

The The TPD1E10B09-Q1 is a single-channel back-to-back diode that protects one bidirectional signal line from electrostatic discharge and surge pulses. Because the diode is bidirectional, the TPD1E10B09-Q1 protects signals that have positive or negative polarity. During normal operation, the diode behaves as a 10-pF capacitance to ground. Board layout is critical for optimal performance of any diode.

Placement: The diode must be placed very close to the external connector for optimal performance. Ideally, the diode must be placed on the line that it is protecting.

Layout: Pin 1 of the diode must be right over the protected signal line. There must a thick and short trace from pin 2 to ground. An example is shown in the [Layout](#) section.

8.2 Typical Application

A system with a human interface is vulnerable to large system-level ESD strikes that standard ICs cannot survive. TVS ESD protection diodes are typically used to suppress ESD at these connectors. The TPD1E10B09-Q1 is a single-channel ESD protection device containing back-to-back TVS diodes, which is typically used to provide a path to ground for dissipating ESD events on bidirectional signal lines between a human interface connector and a system. As the current from ESD passes through the device, only a small voltage drop is present across the diode structure. This is the voltage presented to the protected IC. The low R_{DYN} of the triggered TVS holds this voltage, V_{CLAMP} , to a tolerable level to the protected IC.

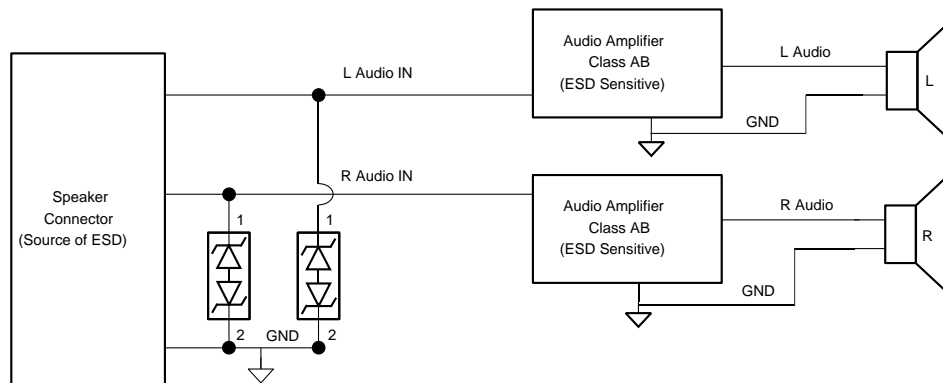

Copyright © 2016, Texas Instruments Incorporated

Figure 10. Typical Application Schematic

8.2.1 Design Requirements

For this design example, two TPD1E10B09-Q1s are used to protect left and right audio channels. [Table 1](#) lists the known system parameters for this audio application.

Table 1. Design Parameters

| DESIGN PARAMETER | VALUE |
|---------------------------------------|--------------------------------|
| Audio amplifier class | AB |
| Audio signal voltage range | -8 V to 8 V |
| Audio frequency content | 20 Hz to 20 kHz |
| Required IEC 61000-4-2 ESD protection | ±15-kV Contact, ±15-kV Air-Gap |

8.2.2 Detailed Design Procedure

To begin the design process, some parameters must be decided upon; the designer must make sure:

- The voltage range on the protected line does not exceed the reverse standoff voltage of the TVS diode(s) (V_{RWM}).
- The operating frequency is supported by the I/O capacitance, C_{IO} , of the TVS diode.
- The IEC 61000-4-2 protection requirement is covered by the IEC performance of the TVS diode.

For this application, the audio signal voltage range is -8 V to 8 V . The V_{RWM} for the TVS is -9.5 V to 9.5 V ; therefore, the bidirectional TVS does not break down during normal operation, and normal operation of the audio signal is not affected due to the signal voltage range. In this application, a bidirectional TVS like the TPD1E10B09-Q1 is required.

Next, consider the frequency content of this audio signal. In this application with the class AB amplifier, the frequency content is from 20 Hz to 20 kHz ; ensure that the TVS I/O capacitance does not distort this signal by filtering it. With the TPD1E10B09-Q1 typical capacitance of 10 pF , which leads to a typical cutoff frequency of just under 500 MHz , this diode has sufficient bandwidth to pass the audio signal without distorting it.

Finally, the human interface in this application requires protection for $\pm 15\text{-kV}$ Contact and $\pm 15\text{-kV}$ Air-Gap ESD, which is above the standard Level 4 IEC 61000-4-2 system-level ESD protection. A standard TVS cannot survive this level of IEC ESD stress. However, the TPD1E10B09-Q1 can survive at least $\pm 20\text{-kV}$ Contact and $\pm 20\text{-kV}$ Air-Gap ESD. Therefore, the device can provide sufficient ESD protection for the interface, even though the requirements are stringent. For any TVS diode to provide its full range of ESD protection capabilities, as well as to minimize the noise and EMI disturbances the board will see during ESD events, it is crucial that a system designer uses proper board layout of their TVS ESD protection diodes. See the [Layout](#) section for instructions on properly laying out the TPD1E10B09-Q1.

8.2.3 Application Curves

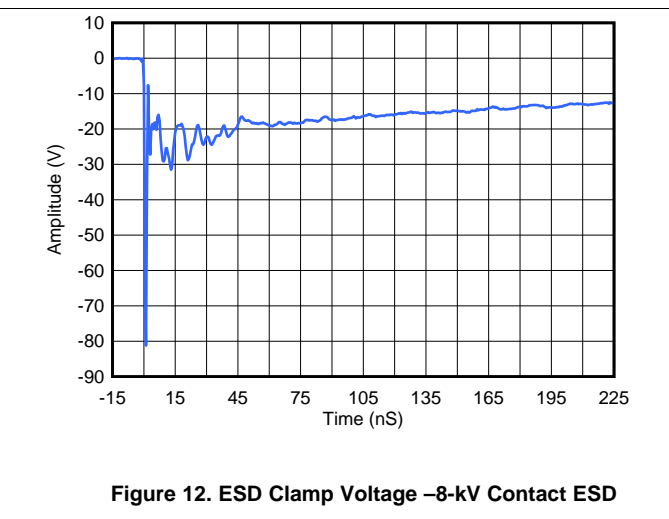
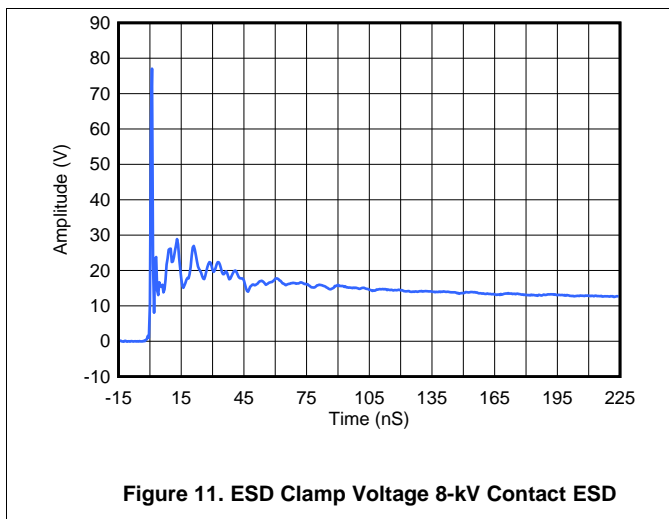

9 Power Supply Recommendations

This device is a passive TVS diode-based ESD protection device, so there is no need to power it. Do not violate the maximum specifications for each pin.

10 Layout

10.1 Layout Guidelines

- The optimum placement is as close to the connector as possible.
 - EMI during an ESD event can couple from the trace being struck to other nearby unprotected traces, resulting in early system failures.
 - The PCB designer must minimize the possibility of EMI coupling by keeping any unprotected traces away from the protected traces which are between the TVS and the connector.
- Route the protected traces as straight as possible.
- Use rounded corners with the largest radii possible on the protected traces between the TVS and the connector, thus eliminating any sharp corners.
 - Electric fields tend to build up on corners, increasing EMI coupling.
- If pin 1 or pin 2 is connected to ground, use a thick and short trace for this return path.

10.2 Layout Example

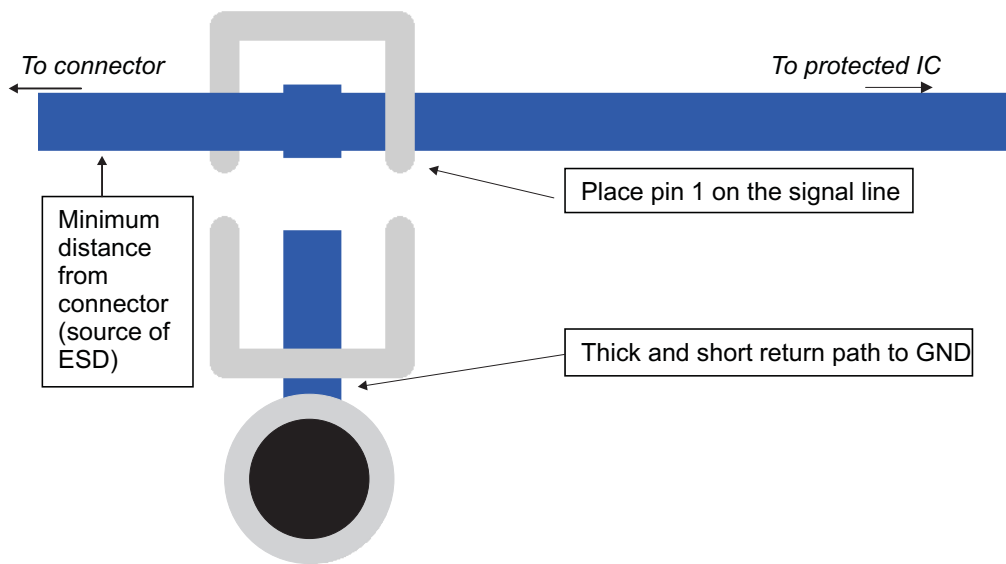

Figure 13. Layout Example

11 器件和文档支持

11.1 文档支持

11.1.1 相关文档

相关文档如下:

- 《TPD1E10B09-Q1 评估模块》
- [阅读和理解 ESD 保护数据表](#)
- 《ESD 布局指南》
- 《ESD 保护二极管 EVM》

11.2 接收文档更新通知

如需接收文档更新通知, 请访问 [ti.com](#) 上的器件产品文件夹。点击右上角的 **提醒我 (Alert me)** 注册后, 即可每周定期收到已更改的产品信息。有关更改的详细信息, 请查阅已修订文档中包含的修订历史记录。

11.3 社区资源

The following links connect to TI community resources. Linked contents are provided "AS IS" by the respective contributors. They do not constitute TI specifications and do not necessarily reflect TI's views; see TI's [Terms of Use](#).

TI E2E™ Online Community *TI's Engineer-to-Engineer (E2E) Community*. Created to foster collaboration among engineers. At [e2e.ti.com](#), you can ask questions, share knowledge, explore ideas and help solve problems with fellow engineers.

Design Support *TI's Design Support* Quickly find helpful E2E forums along with design support tools and contact information for technical support.

11.4 商标

E2E is a trademark of Texas Instruments.

All other trademarks are the property of their respective owners.

11.5 静电放电警告



ESD 可能会损坏该集成电路。德州仪器 (TI) 建议通过适当的预防措施处理所有集成电路。如果不遵守正确的处理措施和安装程序, 可能会损坏集成电路。

ESD 的损坏小至导致微小的性能降级, 大至整个器件故障。精密的集成电路可能更容易受到损坏, 这是因为非常细微的参数更改都可能会导致器件与其发布的规格不相符。

11.6 Glossary

SLYZ022 — *TI Glossary*.

This glossary lists and explains terms, acronyms, and definitions.

12 机械、封装和可订购信息

以下页中包括机械封装和可订购信息。这些信息是针对指定器件可提供的最新数据。这些数据会在无通知且不对本文档进行修订的情况下发生改变。欲获得该数据表的浏览器版本，请查阅左侧的导航栏。

PACKAGING INFORMATION

| Orderable Device | Status (1) | Package Type | Package Drawing | Pins | Package Qty | Eco Plan (2) | Lead finish/ Ball material (6) | MSL Peak Temp (3) | Op Temp (°C) | Device Marking (4/5) | Samples |
|-------------------|---------------|--------------|-----------------|------|-------------|-----------------|--------------------------------------|----------------------|--------------|-------------------------|---------|
| TPD1E10B09QDPYRQ1 | ACTIVE | X1SON | DPY | 2 | 10000 | RoHS & Green | NIPDAU | Level-1-260C-UNLIM | -40 to 125 | 4N | Samples |

(1) The marketing status values are defined as follows:

ACTIVE: Product device recommended for new designs.

LIFEBUY: TI has announced that the device will be discontinued, and a lifetime-buy period is in effect.

NRND: Not recommended for new designs. Device is in production to support existing customers, but TI does not recommend using this part in a new design.

PREVIEW: Device has been announced but is not in production. Samples may or may not be available.

OBSOLETE: TI has discontinued the production of the device.

(2) **RoHS:** TI defines "RoHS" to mean semiconductor products that are compliant with the current EU RoHS requirements for all 10 RoHS substances, including the requirement that RoHS substance do not exceed 0.1% by weight in homogeneous materials. Where designed to be soldered at high temperatures, "RoHS" products are suitable for use in specified lead-free processes. TI may reference these types of products as "Pb-Free".

RoHS Exempt: TI defines "RoHS Exempt" to mean products that contain lead but are compliant with EU RoHS pursuant to a specific EU RoHS exemption.

Green: TI defines "Green" to mean the content of Chlorine (Cl) and Bromine (Br) based flame retardants meet JS709B low halogen requirements of <=1000ppm threshold. Antimony trioxide based flame retardants must also meet the <=1000ppm threshold requirement.

(3) MSL, Peak Temp. - The Moisture Sensitivity Level rating according to the JEDEC industry standard classifications, and peak solder temperature.

(4) There may be additional marking, which relates to the logo, the lot trace code information, or the environmental category on the device.

(5) Multiple Device Markings will be inside parentheses. Only one Device Marking contained in parentheses and separated by a "-" will appear on a device. If a line is indented then it is a continuation of the previous line and the two combined represent the entire Device Marking for that device.

(6) Lead finish/Ball material - Orderable Devices may have multiple material finish options. Finish options are separated by a vertical ruled line. Lead finish/Ball material values may wrap to two lines if the finish value exceeds the maximum column width.

Important Information and Disclaimer:The information provided on this page represents TI's knowledge and belief as of the date that it is provided. TI bases its knowledge and belief on information provided by third parties, and makes no representation or warranty as to the accuracy of such information. Efforts are underway to better integrate information from third parties. TI has taken and continues to take reasonable steps to provide representative and accurate information but may not have conducted destructive testing or chemical analysis on incoming materials and chemicals. TI and TI suppliers consider certain information to be proprietary, and thus CAS numbers and other limited information may not be available for release.

In no event shall TI's liability arising out of such information exceed the total purchase price of the TI part(s) at issue in this document sold by TI to Customer on an annual basis.

TAPE AND REEL INFORMATION



QUADRANT ASSIGNMENTS FOR PIN 1 ORIENTATION IN TAPE



*All dimensions are nominal

| Device | Package Type | Package Drawing | Pins | SPQ | Reel Diameter (mm) | Reel Width W1 (mm) | A0 (mm) | B0 (mm) | K0 (mm) | P1 (mm) | W (mm) | Pin1 Quadrant |
|-------------------|--------------|-----------------|------|-------|--------------------|--------------------|---------|---------|---------|---------|--------|---------------|
| TPD1E10B09QDPYRQ1 | X1SON | DPY | 2 | 10000 | 180.0 | 9.5 | 0.73 | 1.13 | 0.5 | 2.0 | 8.0 | Q1 |

TAPE AND REEL BOX DIMENSIONS

*All dimensions are nominal

| Device | Package Type | Package Drawing | Pins | SPQ | Length (mm) | Width (mm) | Height (mm) |
|-------------------|--------------|-----------------|------|-------|-------------|------------|-------------|
| TPD1E10B09QDPYRQ1 | X1SON | DPY | 2 | 10000 | 189.0 | 185.0 | 36.0 |

DPY (R-PX1SON-N2)

PLASTIC SMALL OUTLINE NO-LEAD

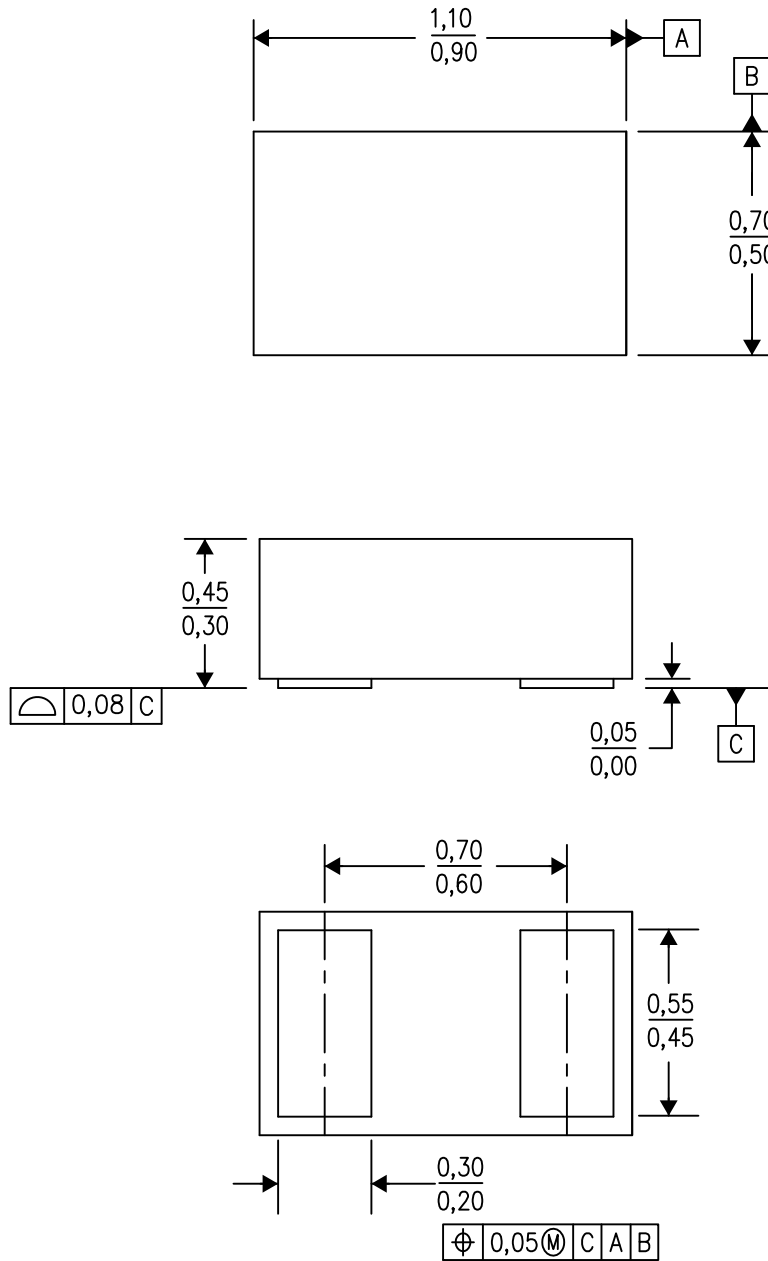

4211012/D 08/14

- NOTES:
- A. All linear dimensions are in millimeters. Dimensioning and tolerancing per ASME Y14.5-1994.
 - B. This drawing is subject to change without notice.
 - C. SON (Small Outline No-Lead) package configuration.

DPY0002A

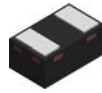

PACKAGE OUTLINE
X1SON - 0.45 mm max height

PLASTIC SMALL OUTLINE - NO LEAD

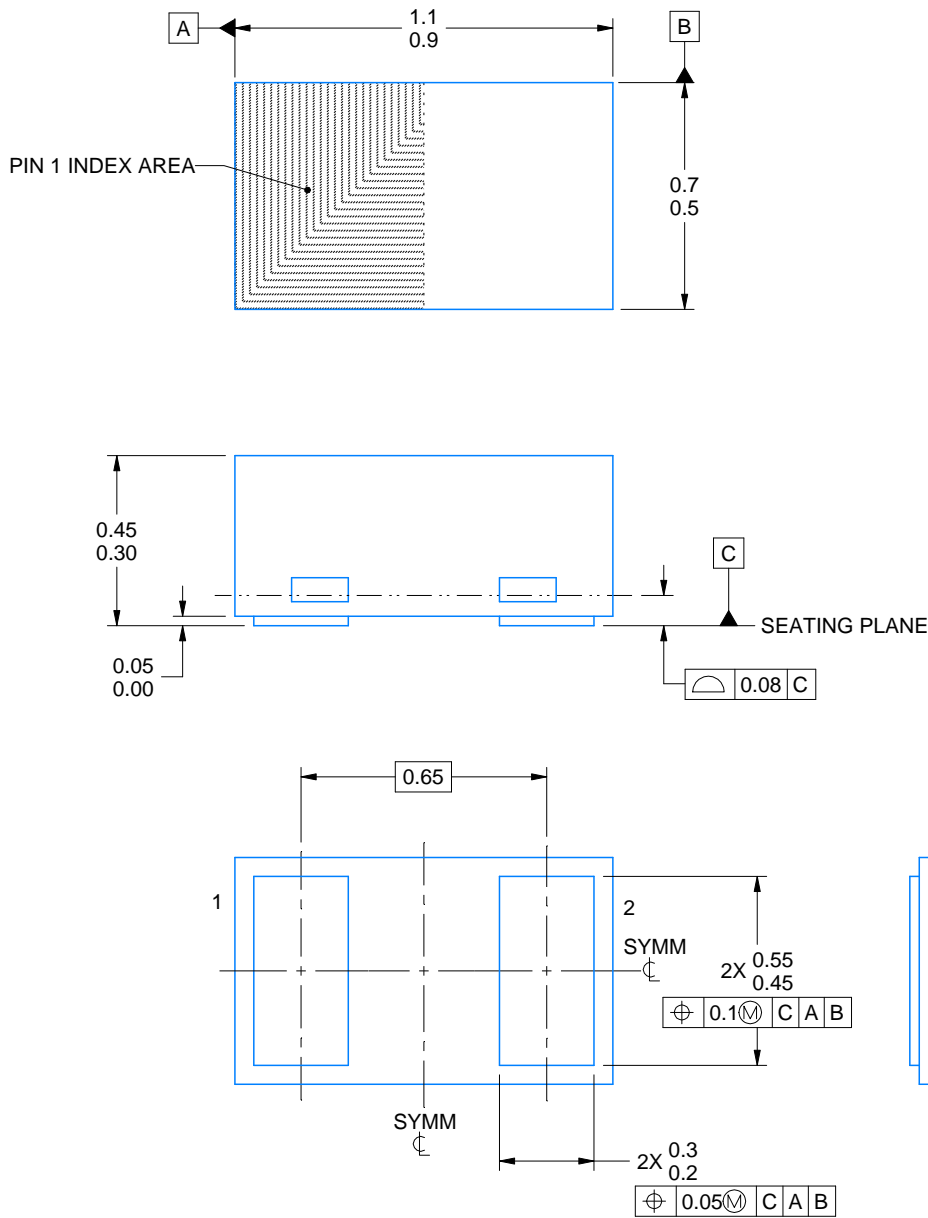

4224561/B 03/2021

NOTES:

1. All linear dimensions are in millimeters. Any dimensions in parenthesis are for reference only. Dimensioning and tolerancing per ASME Y14.5M
2. This drawing is subject to change without notice.

EXAMPLE BOARD LAYOUT

DPY0002A

X1SON - 0.45 mm max height

PLASTIC SMALL OUTLINE - NO LEAD

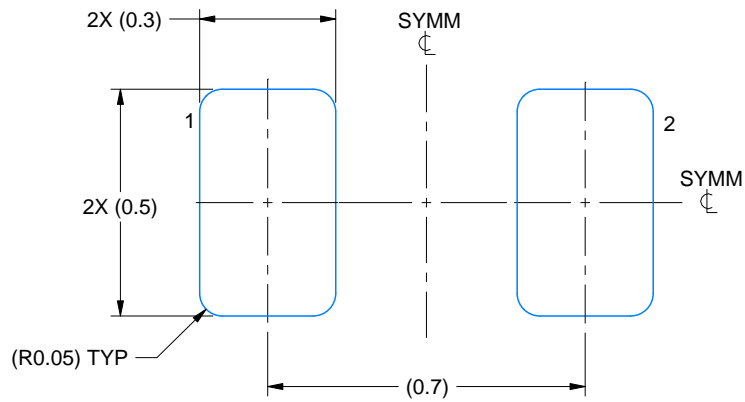

LAND PATTERN EXAMPLE
EXPOSED METAL SHOWN
SCALE:60X

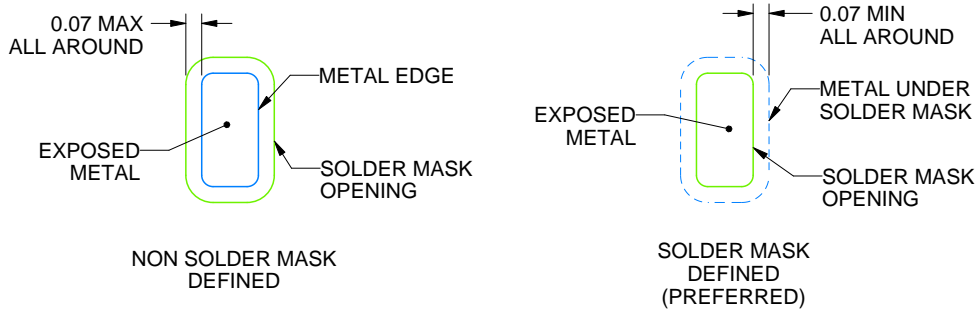

SOLDER MASK DETAILS

4224561/B 03/2021

NOTES: (continued)

3. For more information, see Texas Instruments literature number SLUA271 (www.ti.com/lit/slue271).
4. Vias are optional depending on application, refer to device data sheet. If any vias are implemented, refer to their locations shown on this view. It is recommended that vias under paste be filled, plugged or tented.

EXAMPLE STENCIL DESIGN

DPY0002A

X1SON - 0.45 mm max height

PLASTIC SMALL OUTLINE - NO LEAD

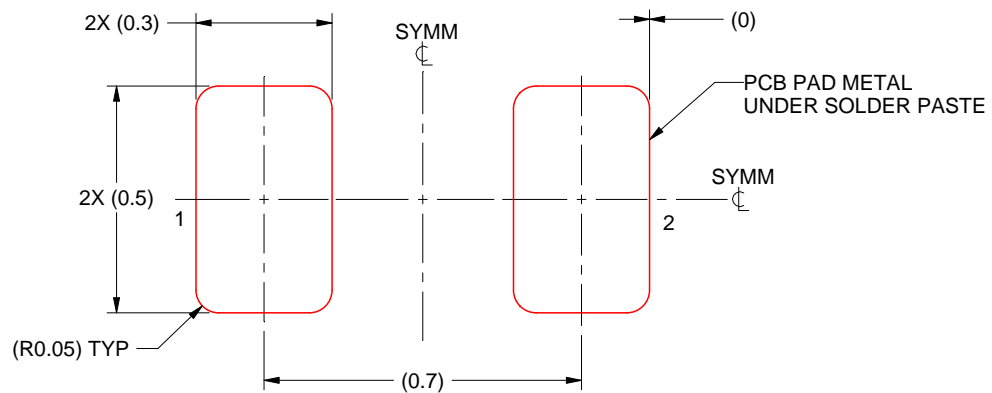

SOLDER PASTE EXAMPLE
BASED ON 0.1 mm THICK STENCIL
SCALE:60X

4224561/B 03/2021

NOTES: (continued)

5. Laser cutting apertures with trapezoidal walls and rounded corners may offer better paste release. IPC-7525 may have alternate design recommendations.

重要声明和免责声明

TI 提供技术和可靠性数据（包括数据表）、设计资源（包括参考设计）、应用或其他设计建议、网络工具、安全信息和其他资源，不保证没有瑕疵且不做任何明示或暗示的担保，包括但不限于对适销性、某特定用途方面的适用性或不侵犯任何第三方知识产权的暗示担保。

这些资源可供使用 TI 产品进行设计的熟练开发人员使用。您将自行承担以下全部责任：(1) 针对您的应用选择合适的 TI 产品，(2) 设计、验证并测试您的应用，(3) 确保您的应用满足相应标准以及任何其他安全、安保或其他要求。这些资源如有变更，恕不另行通知。TI 授权您仅可将这些资源用于研发本资源所述的 TI 产品的应用。严禁对这些资源进行其他复制或展示。您无权使用任何其他 TI 知识产权或任何第三方知识产权。您应全额赔偿因在这些资源的使用中对 TI 及其代表造成的任何索赔、损害、成本、损失和债务，TI 对此概不负责。

TI 提供的产品受 TI 的销售条款 (<https://www.ti.com.cn/zh-cn/legal/termsofsale.html>) 或 [ti.com.cn](https://www.ti.com.cn) 上其他适用条款/TI 产品随附的其他适用条款的约束。TI 提供这些资源并不会扩展或以其他方式更改 TI 针对 TI 产品发布的适用的担保或担保免责声明。

邮寄地址：上海市浦东新区世纪大道 1568 号中建大厦 32 楼，邮政编码：200122

Copyright © 2021 德州仪器半导体技术（上海）有限公司