

采用 DCS-Control™ 技术的 TPS6213xA-Q1 3V 至 17V 3A 降压转换器

1 特性

- DCS-Control™ 拓扑
- Qualified for Automotive 标准
- 具有符合 AEC-Q100 标准的下列结果：
 - 器件温度等级：-40°C 至 125°C 的运行结温范围
 - Device HBM ESD Classification Level 2
 - Device CDM ESD Classification Level C4B
- 输入电压范围：3V 至 17V
- 从 0.9V 至 6V 的可调节输出电压范围
- 引脚可选输出电压（标称值，+5%）
- 可编程软启动和跟踪
- 无缝省电模式转换
- 17 μ A 的静态电流（典型值）
- 可选运行频率
- 电源正常输出
- 100% 占空比模式
- 短路保护
- 过热保护
- 与 TPS62150A-Q1 引脚对引脚兼容
- 采用 3mm x 3mm VQFN-16 封装
- 借助 WEBENCH® 电源设计器并使用 TPS62130A-Q1 创建定制设计方案

2 应用

- 汽车负载点 (POL) 电源
- 信息娱乐系统、CAN、USB 电源
- 嵌入式系统、
- 低压降稳压器 (LDO) 替代产品

典型应用电路原理图

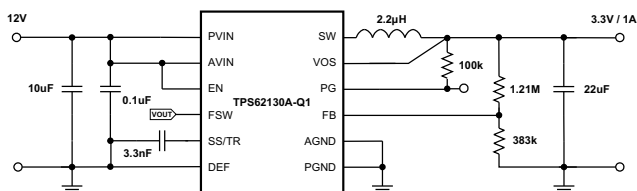

Copyright © 2017, Texas Instruments Incorporated

3 说明

TPS6213XA-Q1 器件是一款易于使用的同步降压直流/直流转换器，针对应用进行了优化。通常为 2.5MHz 的高开关频率允许使用小型电感器，并且通过使用 DCS-Control™ 拓扑技术提供快速瞬态响应以及高输出电压精度。

借助 3V 至 17V 的宽运行输入电压范围，该器件非常适合由中间总线电源轨供电的系统。该器件在输出电压介于 0.9V 至 6V 之间时支持高达 3A 的持续输出电流（使用 100% 占空比模式时）。输出电压启动斜率由软启动引脚控制，从而实现作为独立电源或者在跟踪配置下的运行。通过配置使能和开漏电源正常引脚也有可能实现电源排序。

在节能模式下，该器件可根据 V_{IN} 生成约 17 μ A 的静态电流。如果负载较小，则自动且无缝进入省电模式，并在整个负载范围内保持高效率。在关断模式下，该器件处于关断状态，期间的电流消耗低于 2 μ A。该器件采用 3 x 3mm (RGT) 16 引脚 VQFN 封装。

器件信息(1)

器件型号	PACKAGE	BODY SIZE (NOM)
TPS62130A-Q1	VQFN (16)	3.00mm x 3.00mm
TPS62133A-Q1		
TPS6213013A-Q1		

(1) 要了解所有可用封装，请见数据表末尾的可订购产品附录。

效率与输出电流

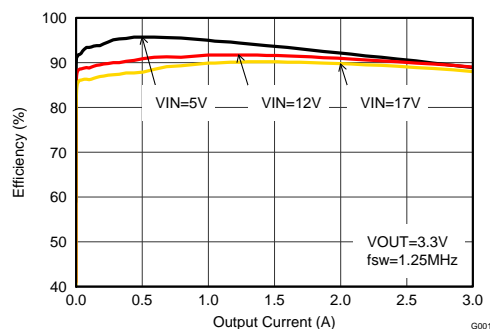

目录

1 特性	1	9.4 Device Functional Modes	13
2 应用	1	10 Application and Implementation	15
3 说明	1	10.1 Application Information	15
4 修订历史记录	2	10.2 Typical Application	15
5 Device Comparison Table	4	10.3 System Examples	27
6 Pin Configuration and Functions	4	11 Power Supply Recommendations	31
7 Specifications	5	12 Layout	32
7.1 Absolute Maximum Ratings	5	12.1 Layout Guidelines	32
7.2 ESD Ratings	5	12.2 Layout Example	32
7.3 Recommended Operating Conditions	5	13 器件和文档支持	33
7.4 Thermal Information	5	13.1 器件支持	33
7.5 Electrical Characteristics	6	13.2 相关链接	33
7.6 Typical Characteristics	7	13.3 Receiving Notification of Documentation Updates	33
8 Parameter Measurement Information	8	13.4 Community Resources	33
9 Detailed Description	9	13.5 商标	33
9.1 Overview	9	13.6 静电放电警告	33
9.2 Functional Block Diagram	9	13.7 Glossary	33
9.3 Feature Description	10	14 机械、封装和可订购信息	34

4 修订历史记录

注：之前版本的页码可能与当前版本有所不同。

Changes from Revision C (July 2017) to Revision D	Page
• Changed pin 7 from "LOG" to "FSW" in the Pin Functions table for clarification	4
• Deleted extra text string "...or 1.25 MHz, selectable with the FSW" after 1st paragraph of Pulse Width Modulation (PWM) Operation section.	10
• Deleted extra text "...with FSW=Low" preceding Equation 1	11

Changes from Revision B (October 2016) to Revision C	Page
• 已添加 整篇文档的 WEBENCH® 链接	1
• Changed "LOG" pin to "FSW" pin on the <i>Pin Configuration</i> drawing, and added FSW description throughout the document.	4
• Added SW (AC) spec to the Absolute Maximum Ratings⁽¹⁾ table.	5
• Added Power Good Pin Logic Table table and Frequency Selection (FSW) section regarding pin control.	13

Changes from Revision A (October 2016) to Revision B	Page
• 已删除 TPS6213013A-Q1 器件的“产品预览”状态	1
• Added text to Frequency Selection (FSW) section regarding pin control	13
• 已添加 Receiving Notification of Documentation Updates 和 Community Resources 部分	33

Changes from Original (May 2014) to Revision A	Page
• 已添加 TPS6213013A-Q1 器件	1
• Added TPS6213013A-Q1 to <i>Device Comparison Table</i>	4
• Moved Storage temperature spec., T_{stg} to Absolute Maximum Ratings table, and re-named Handling Ratings table to ESD Ratings	5
• Corrected <i>Thermal Information</i> table	5
• Added Figure 27 , Figure 28 , Figure 31 , and Figure 32	23
• Added Figure 33 , Figure 34	24
• Added Figure 52	30
• Changed Figure 55	32

5 Device Comparison Table

PART NUMBER	OUTPUT VOLTAGE	PACKAGE MARKING
TPS62130A-Q1	adjustable	PA6IQ
TPS62133A-Q1	5 V	PA6JQ
TPS6213013A-Q1	1.3 V	13013Q

6 Pin Configuration and Functions

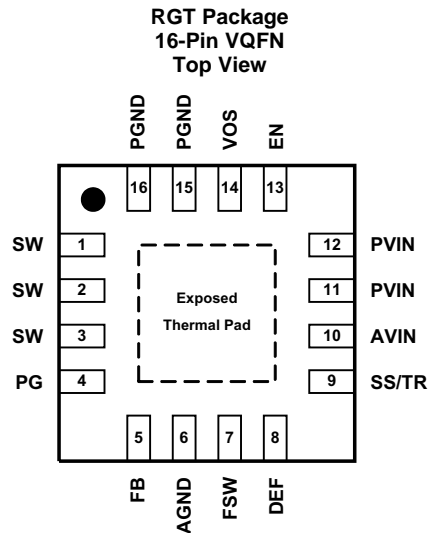

Pin Functions

PIN ⁽¹⁾		I/O	DESCRIPTION
NO.	NAME		
1,2,3	SW	O	Switch node, which is connected to the internal MOSFET switches. Connect inductor between SW and output capacitor.
4	PG	O	Output power good (High = V_{OUT} ready, Low = V_{OUT} below nominal regulation) ; open drain (requires pull-up resistor)
5	FB	I	Voltage feedback of adjustable version. Connect resistive voltage divider to this pin. It is recommended to connect FB to AGND on fixed output voltage versions for improved thermal performance.
6	AGND		Analog Ground. Must be connected directly to the Exposed Thermal Pad and common ground plane.
7	FSW	I	Switching Frequency Select (Low=2.5MHz, High=1.25MHz for typical operation) ⁽²⁾
8	DEF	I	Output Voltage Scaling (Low = nominal, High = nominal + 5%) ⁽²⁾
9	SS/TR	I	Soft-Start / Tracking Pin. An external capacitor connected to this pin sets the internal voltage reference rise time. It can be used for tracking and sequencing.
10	AVIN	I	Supply voltage for control circuitry. Connect to same source as PVIN.
11,12	PVIN	I	Supply voltage for power stage. Connect to same source as AVIN.
13	EN	I	Enable input (High = enabled, Low = disabled) ⁽²⁾
14	VOS	I	Output voltage sense pin and connection for the control loop circuitry.
15,16	PGND		Power Ground. Must be connected directly to the Exposed Thermal Pad and common ground plane.
Exposed Thermal Pad		–	Must be connected to AGND (pin 6), PGND (pin 15,16) and common ground plane ⁽³⁾ . Must be soldered to achieve appropriate power dissipation and mechanical reliability.

(1) For more information about connecting pins, see [Detailed Description](#) and [Application and Implementation](#) sections.

(2) An internal pull-down resistor keeps logic level low, if pin is floating.

(3) See [Figure 55](#).

7 Specifications

7.1 Absolute Maximum Ratings⁽¹⁾

		MIN	MAX	UNIT
Pin voltage ⁽²⁾	AVIN, PVIN	-0.3	20	V
	EN, SS/TR, SW (DC)	-0.3	V _{IN} +0.3	
	SW (AC), less than 10ns ⁽³⁾	-2	24.5	
	DEF, FSW, FB, PG, VOS	-0.3	7	V
Power Good sink current	PG		10	mA
Temperature	Operating junction temperature, T _J	-40	150	°C
Storage temperature	T _{stg}	-65	150	°C

- (1) Stresses beyond those listed under *Absolute Maximum Ratings* may cause permanent damage to the device. These are stress ratings only, which do not imply functional operation of the device at these or any other conditions beyond those indicated under *Recommended Operating Conditions*. Exposure to absolute-maximum-rated conditions for extended periods may affect device reliability.
- (2) All voltages are with respect to network ground terminal.
- (3) While switching.

7.2 ESD Ratings

			VALUE	UNIT
V _(ESD) ⁽¹⁾	Electrostatic discharge	Human body model (HBM), per AEC Q100-002 ⁽²⁾	±2000	V
		Charged device model (CDM), per AEC Q100-011	±500	

- (1) Electrostatic discharge (ESD) measures device sensitivity and immunity to damage caused by assembly line electrostatic discharges into the device.
- (2) AEC Q100-002 indicates HBM stressing is done in accordance with the ANSI/ESDA/JEDEC JS-001 specification.

7.3 Recommended Operating Conditions

			MIN	TYP	MAX	UNIT
V _{IN}	Supply Voltage	at AVIN and PVIN	3		17	V
V _{OUT}	Output Voltage Range	TPS62130A-Q1	0.9		6	V
T _J	Operating junction temperature		-40		125	°C

7.4 Thermal Information

THERMAL METRIC ⁽¹⁾		TPS6213xA-Q1			
		RGT			UNIT
		16 PINS			
R _{θJA}	Junction-to-ambient thermal resistance	45			°C/W
R _{θJC(top)}	Junction-to-case (top) thermal resistance	53.6			°C/W
R _{θJB}	Junction-to-board thermal resistance	17.4			°C/W
ψ _{JT}	Junction-to-top characterization parameter	1.1			°C/W
ψ _{JB}	Junction-to-board characterization parameter	17.4			°C/W
R _{θJC(bot)}	Junction-to-case (bottom) thermal resistance	4.5			°C/W

- (1) For more information about traditional and new thermal metrics, see the *IC Package Thermal Metrics* application report, [SPRA953](#).

7.5 Electrical Characteristics

 over junction temperature range ($T_J = -40^{\circ}\text{C}$ to $+125^{\circ}\text{C}$), typical values at $V_{IN} = 12\text{V}$ and $T_A = 25^{\circ}\text{C}$ (unless otherwise noted)

PARAMETER		TEST CONDITIONS	MIN	TYP	MAX	UNIT	
SUPPLY							
V_{IN}	Input voltage range		3		17	V	
I_Q	Operating quiescent current	EN=High, $I_{OUT}=0\text{mA}$, device not switching		17	30	μA	
I_{SD}	Shutdown current ⁽¹⁾	EN=Low		1.5	25	μA	
V_{UVLO}	Undervoltage lockout threshold	Falling Input Voltage (PWM mode operation)	2.6	2.7	2.8	V	
		Hysteresis		200		mV	
T_{SD}	Thermal shutdown temperature			160		$^{\circ}\text{C}$	
	Thermal shutdown hysteresis			20			
CONTROL (EN, DEF, FSW, SS/TR, PG)							
V_H	High level input threshold voltage (EN, DEF, FSW)		0.9			V	
V_L	Low level input threshold voltage (EN, DEF, FSW)				0.3	V	
I_{LKG}	Input leakage current (EN, DEF, FSW)	EN= V_{IN} or GND; DEF, FSW=GND		0.01	1	μA	
V_{TH_PG}	Power good threshold voltage	Rising ($\%V_{OUT}$)	92%	95%	98%		
		Falling ($\%V_{OUT}$)	87%	90%	94%		
V_{OL_PG}	Power good output low	$I_{PG}=-2\text{mA}$		0.07	0.3	V	
I_{LKG_PG}	Input leakage current (PG)	$V_{PG}=1.8\text{V}$		1	400	nA	
$I_{SS/TR}$	SS/TR pin source current		2.3	2.5	2.7	μA	
POWER SWITCH							
$R_{DS(ON)}$	High-side MOSFET ON-resistance	$V_{IN} \geq 6\text{V}$		90	170	m Ω	
		$V_{IN} = 3\text{V}$		120			
	Low-side MOSFET ON-resistance	$V_{IN} \geq 6\text{V}$		40	70	m Ω	
		$V_{IN} = 3\text{V}$		50			
I_{LIMF}	High-side MOSFET forward current limit	$V_{IN} = 12\text{V}$, $T_A = 25^{\circ}\text{C}$	3.6	4.2	4.9	A	
OUTPUT							
V_{REF}	Internal reference voltage			0.8		V	
I_{LKG_FB}	Input leakage current (FB)	$V_{FB}=0.8\text{V}$		1	100	nA	
V_{OUT}	Output voltage range (TPS62130A-Q1)	$V_{IN} \geq V_{OUT}$	0.9		6.0	V	
	DEF (Output voltage programming)	DEF=0 (GND)		V_{OUT}			
		DEF=1 (V_{OUT})		$V_{OUT}+5\%$			
	Output voltage accuracy ⁽²⁾	PWM mode operation, $V_{IN} \geq V_{OUT} + 1\text{V}$		-1.8%		1.8%	
		Power Save Mode operation, $C_{OUT}=22\mu\text{F}$		-2.3%		2.8%	
	Load regulation	$V_{IN}=12\text{V}$, $V_{OUT}=3.3\text{V}$, PWM mode operation			0.05		%/A
Line regulation	$3\text{V} \leq V_{IN} \leq 17\text{V}$, $V_{OUT}=3.3\text{V}$, $I_{OUT}=1\text{A}$, PWM mode operation			0.02		%/V	

(1) Current into AVIN+PVIN pin.

(2) This is the regulation accuracy of the voltage at the FB pin (adjustable version) and of the output voltage (fixed version).

7.6 Typical Characteristics

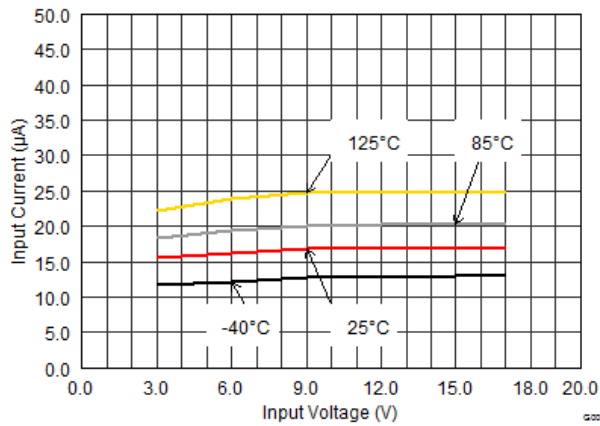

Figure 1. Quiescent Current

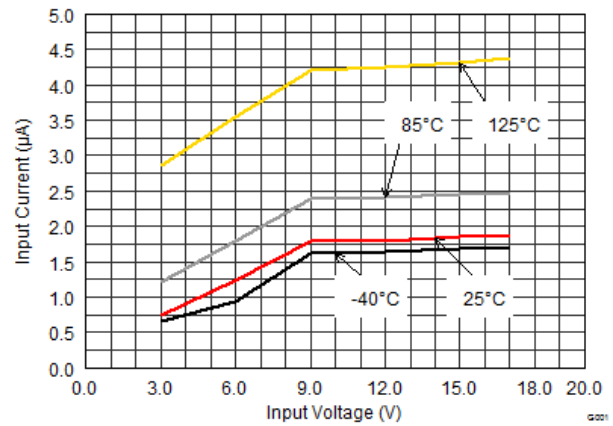

Figure 2. Shutdown Current

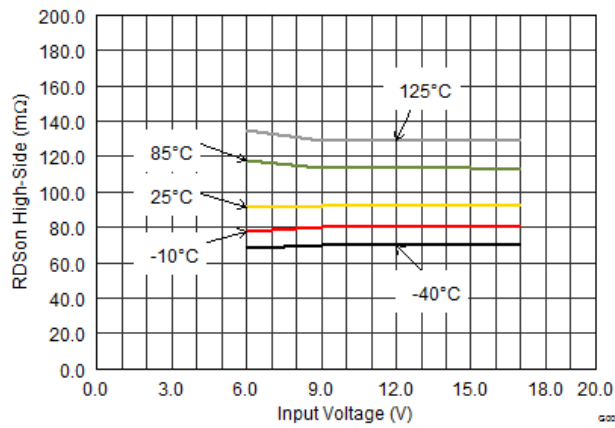

Figure 3. High-side Switch Resistance

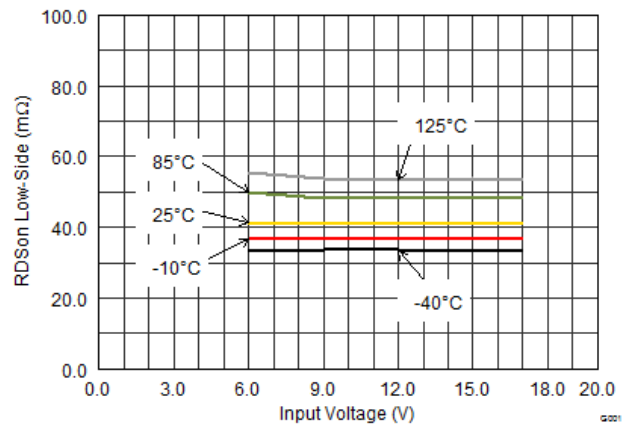

Figure 4. Low-Side Switch Resistance

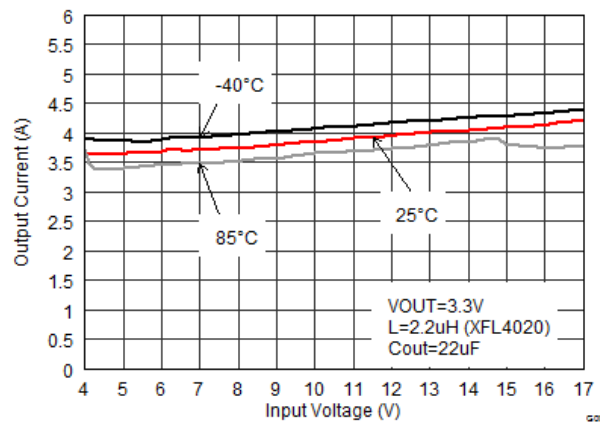
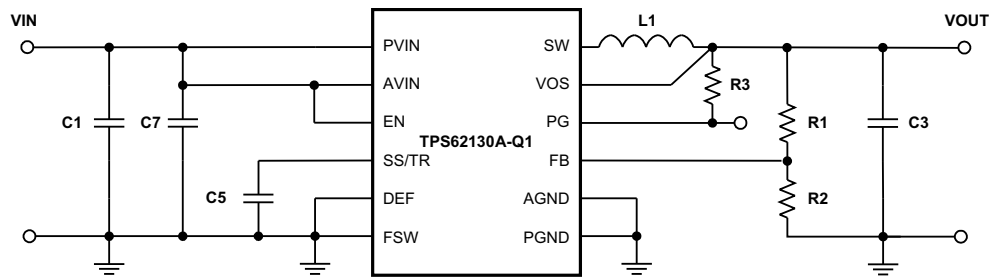

Figure 5. Maximum Output Current

8 Parameter Measurement Information

Table 1. List of Components

REFERENCE	DESCRIPTION	MANUFACTURER
IC	17V, 3A Step-Down Converter, QFN	TPS62130AQRGT, Texas Instruments
L1	2.2μH, 0.165 x 0.165 in	XFL4020-222MEB, Coilcraft
C1	10μF, 25V, Ceramic, 1210	Standard
C3	22μF, 6.3V, Ceramic, 0805	Standard
C5	3300pF, 25V, Ceramic, 0603	Standard
C7	0.1μF, 25V, Ceramic, 0603	Standard
R1	depending on V_{OUT}	
R2	depending on V_{OUT}	
R3	100kΩ, Chip, 0603, 1/16W, 1%	Standard



Copyright © 2017, Texas Instruments Incorporated

Figure 6. Measurement Setup (High Switching Frequency)

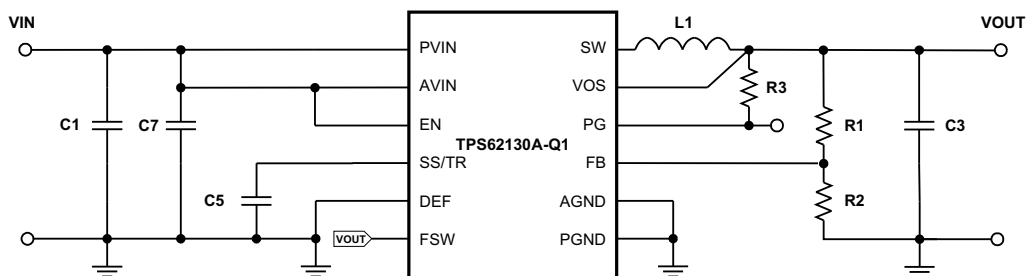

Copyright © 2017, Texas Instruments Incorporated

Figure 7. Measurement Setup (Low Switching Frequency)

9 Detailed Description

9.1 Overview

The TPS6213xA-Q1 synchronous switched mode power converters are based on DCS-Control™ (Direct Control with Seamless Transition into Power Save Mode), an advanced regulation topology, that combines the advantages of hysteretic, voltage mode and current mode control including an AC loop directly associated to the output voltage. This control loop takes information about output voltage changes and feeds it directly to a fast comparator stage. It sets the switching frequency, which is constant for steady state operating conditions, and provides immediate response to dynamic load changes. To get accurate DC load regulation, a voltage feedback loop is used. The internally compensated regulation network achieves fast and stable operation with small external components and low ESR capacitors.

The DCS-Control™ topology supports PWM (Pulse Width Modulation) mode for medium and heavy load conditions and a Power Save Mode at light loads. During PWM, it operates at its nominal switching frequency in continuous conduction mode. This frequency is typically about 2.5 MHz or 1.25MHz with a controlled frequency variation depending on the input voltage. If the load current decreases, the converter enters Power Save Mode to sustain high efficiency down to very light loads. In Power Save Mode the switching frequency decreases linearly with the load current. Since DCS-Control™ supports both operation modes within one single building block, the transition from PWM to Power Save Mode is seamless without effects on the output voltage.

9.2 Functional Block Diagram

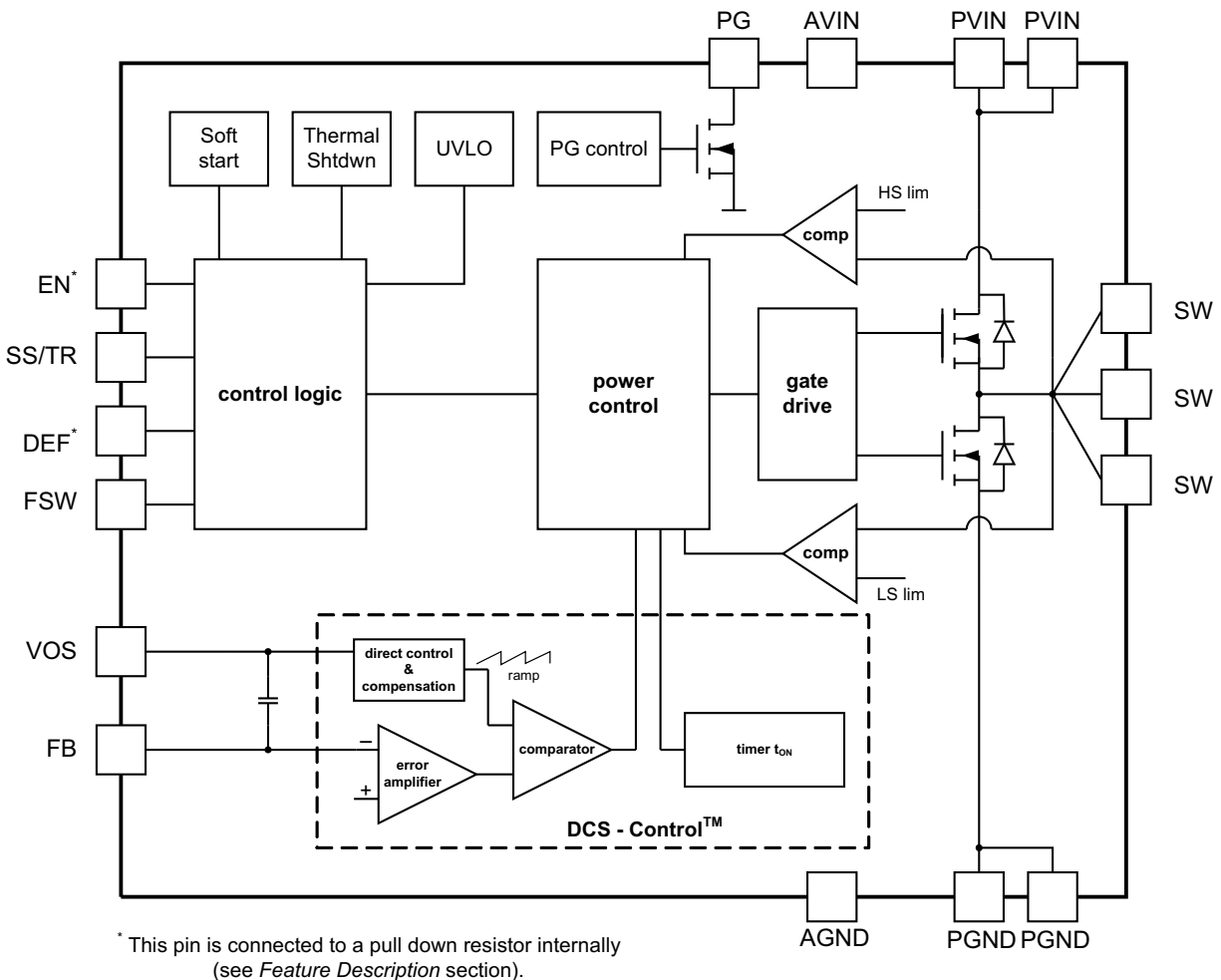

Copyright © 2017, Texas Instruments Incorporated

Figure 8. TPS62130A-Q1 (Adjustable Output Voltage)

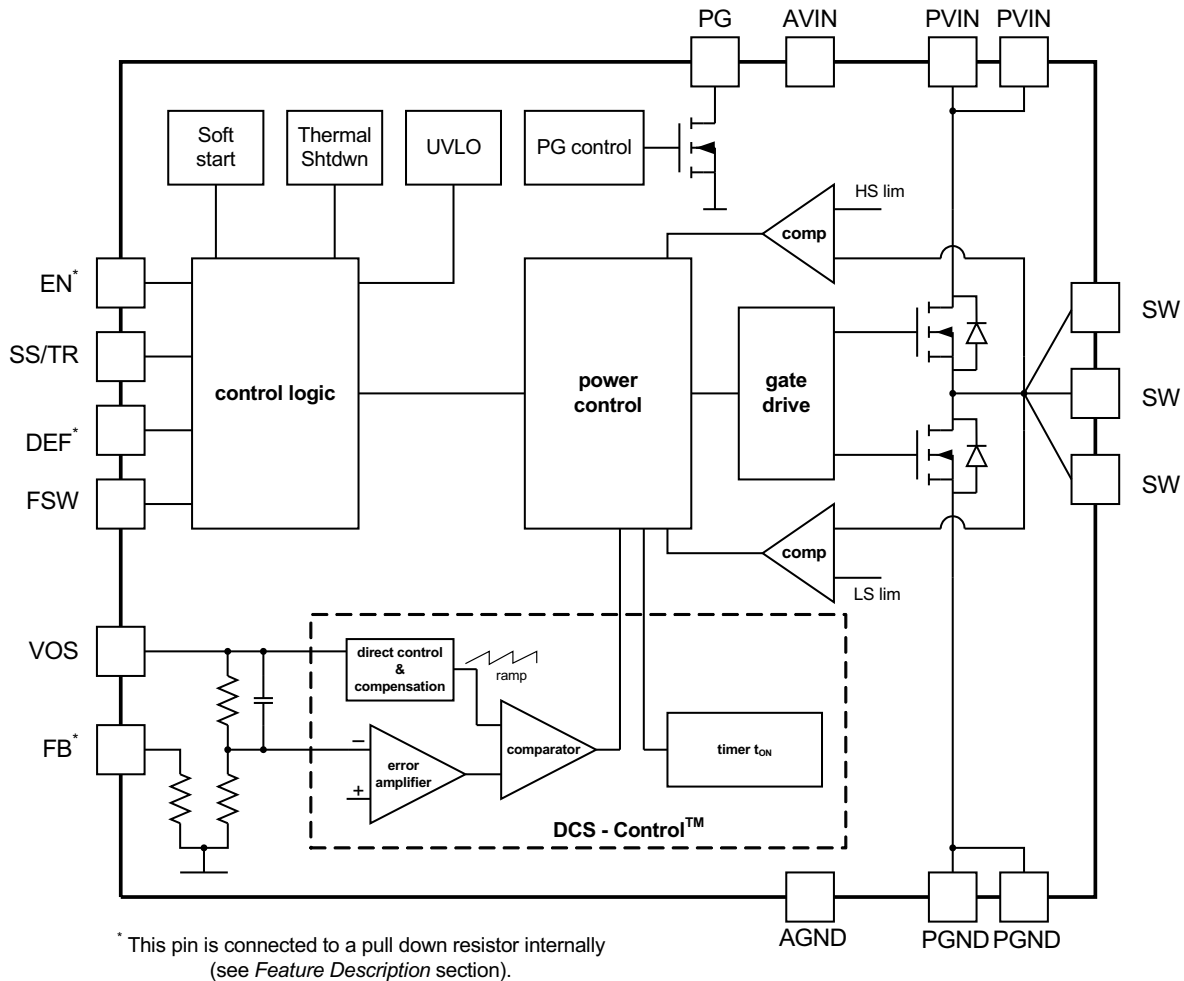
Functional Block Diagram (continued)

Copyright © 2017, Texas Instruments Incorporated

Figure 9. TPS6213013A-Q1 and TPS62133A-Q1 (Fixed output Voltage)

9.3 Feature Description

9.3.1 Pulse Width Modulation (PWM) Operation

The TPS6213xA-Q1 operate with pulse width modulation in continuous conduction mode (CCM) with a nominal switching frequency of 2.5 MHz or 1.25 MHz, selectable with the FSW pin. The frequency variation in PWM is controlled and depends on V_{IN} , V_{OUT} and the inductance. The device operates in PWM mode as long the output current is higher than half the inductor's ripple current. To maintain high efficiency at light loads, the device enters Power Save Mode at the boundary to discontinuous conduction mode (DCM). PSM operation occurs if the output current becomes smaller than half the inductor's ripple current.

9.3.2 Power Save Mode Operation

The built in Power Save Mode of the TPS6213xA-Q1 is entered seamlessly, if the load current decreases. This secures a high efficiency in light load operation. The device remains in Power Save Mode as long as the inductor current is discontinuous.

In Power Save Mode, the switching frequency decreases linearly with the load current maintaining high efficiency. The transition into and out of Power Save Mode happens within the entire regulation scheme and is seamless in both directions.

Feature Description (continued)

TPS6213xA-Q1 includes a fixed on-time circuitry. This on-time, in steady-state operation with FSW=Low, can be estimated as:

$$t_{ON} = \frac{V_{OUT}}{V_{IN}} \cdot 400ns \quad (1)$$

For very small output voltages, an absolute minimum on-time of about 80ns is kept to limit switching losses. The operating frequency is thereby reduced from its nominal value, keeping efficiency high. Also the off-time can reach its minimum value at high duty cycles. The output voltage remains regulated in such case. Using t_{ON} , the typical peak inductor current in Power Save Mode can be approximated by:

$$I_{LPSM(peak)} = \frac{(V_{IN} - V_{OUT})}{L} \cdot t_{ON} \quad (2)$$

When V_{IN} decreases to typically 15% above V_{OUT} , the TPS6213xA-Q1 does not enter Power Save Mode, regardless of the load current. The device maintains output regulation in PWM mode.

9.3.3 100% Duty-Cycle Operation

The duty cycle of the buck converter is given by $D=V_{OUT}/V_{IN}$ and increases as the input voltage comes close to the output voltage. In this case, the device starts 100% duty cycle operation turning on the high-side switch 100% of the time. The high-side switch stays turned on as long as the output voltage is below the internal set point. This allows the conversion of small input to output voltage differences, e.g. for longest operation time of battery-powered applications. In 100% duty cycle mode, the low-side FET is switched off.

The minimum input voltage to maintain output voltage regulation, depending on the load current and the output voltage level, can be calculated as:

$$V_{IN(min)} = V_{OUT(min)} + I_{OUT} (R_{DS(on)} + R_L)$$

where:

- I_{OUT} is the output current,
- $R_{DS(on)}$ is the $R_{DS(on)}$ of the high-side FET and
- R_L is the DC resistance of the inductor used.

(3)

9.3.4 Enable / Shutdown (EN)

When Enable (EN) is set High, the device starts operation. Shutdown is forced if EN is pulled Low with a shutdown current of typically 1.5µA. During shutdown, the internal power MOSFETs as well as the entire control circuitry are turned off. The internal resistive divider pulls down the output voltage smoothly. The EN signal must be set externally to High or Low. The typical threshold values are 0.65V (rising) and 0.45V (falling). An internal pull-down resistor of about 400kΩ is connected and keeps EN logic low, if Low is set initially and then the pin gets floating. It is disconnected if the pin is set High.

Connecting the EN pin to an appropriate output signal of another power rail provides sequencing of multiple power rails.

Feature Description (continued)

9.3.5 Soft Start / Tracking (SS/TR)

The internal soft start circuitry controls the output voltage slope during startup, avoiding excessive inrush current and ensures a controlled output voltage rise time. It also prevents unwanted voltage drops from high-impedance power sources or batteries. When EN is set to start device operation, the device starts switching after a delay of about 50µs and V_{OUT} rises with a slope controlled by an external capacitor connected to the SS/TR pin. See [Figure 41](#) and [Figure 42](#) for typical startup operation.

Using a very small capacitor (or leaving SS/TR pin un-connected) provides fastest startup behavior. The TPS6213xA-Q1 can start into a pre-biased output. During monotonic pre-biased startup, both of the power MOSFETs are not allowed to turn on until the device's internal ramp sets an output voltage above the pre-bias voltage. As long as the output is below about 0.5V, a reduced current limit of typically 1.6A is set internally. If the device is set to shutdown (EN=GND), undervoltage lockout or thermal shutdown, an internal resistor pulls the SS/TR pin down to ensure a proper low level. Returning from those states causes a new startup sequence as set by the SS/TR connection.

A voltage supplied to SS/TR can be used for tracking a master voltage. The output voltage will follow this voltage in both directions up and down (see [Application and Implementation](#)).

9.3.6 Current Limit And Short Circuit Protection

The TPS6213xA-Q1 is protected against heavy load and short circuit events. If a short circuit is detected (V_{OUT} drops below 0.5V), the current limit is reduced to 1.6A typically. If the output voltage rises above 0.5V, the device runs in normal operation again. At heavy loads, the current limit determines the maximum output current. If the current limit is reached, the high-side FET turns off. Avoiding shoot through current, the low-side FET switches on to allow the inductor current to decrease. The low-side current limit is typically 3.5A. The high-side FET turns on again, only if the current in the low-side FET has decreased below the low-side current limit threshold.

The output current of the device is limited by the current limit (see [Electrical Characteristics](#)). Due to internal propagation delay, the actual current can exceed the static current limit during that time. The dynamic current limit can be calculated as follows:

$$I_{peak(typ)} = I_{LIMF} + \frac{V_L}{L} \cdot t_{PD}$$

where

- I_{LIMF} is the static current limit, specified in the [Electrical Characteristics](#),
 - L is the inductor value,
 - V_L is the voltage across the inductor (V_{IN} - V_{OUT}) and
 - t_{PD} is the internal propagation delay.
- (4)

The current limit can exceed static values, especially if the input voltage is high and very small inductances are used. The dynamic high side switch peak current can be calculated as follows:

$$I_{peak(typ)} = I_{LIMF} + \frac{(V_{IN} - V_{OUT})}{L} \cdot 30ns$$
(5)

9.3.7 Power Good (PG)

The TPS6213xA-Q1 has a built in power good (PG) function to indicate whether the output voltage has reached its appropriate level or not. The PG signal can be used for startup sequencing of multiple rails. The PG pin is an open-drain output that requires a pull-up resistor (to any voltage below 7V). It can sink 2mA of current and maintain its specified logic low level. TPS6213xA-Q1 features PG=Low when the device is turned off due to EN, UVLO or thermal shutdown and can be used to actively discharge V_{OUT} (see [Figure 46](#)). V_{IN} must remain present for the PG pin to stay Low. If unused, the PG pin may be left floating.

Feature Description (continued)

Table 2. Power Good Pin Logic Table

Device State		PG Logic Status	
		High Impedance	Low
Enable (EN=High)	$V_{FB} \geq V_{TH_PG}$	√	
	$V_{FB} \leq V_{TH_PG}$		√
Shutdown (EN=Low)			√
UVLO	$0.7\text{ V} < V_{IN} < V_{UVLO}$		√
Thermal Shutdown	$T_J > T_{SD}$		√
Power Supply Removal	$V_{IN} < 0.7\text{ V}$	√	

9.3.8 Pin-Selectable Output Voltage (DEF)

The output voltage of the TPS6213xA-Q1 can be increased by 5% above the nominal voltage by setting the DEF pin to High ⁽¹⁾. When DEF is Low, the device regulates to the nominal output voltage. Increasing the nominal voltage allows adapting the power supply voltage to the variations of the application hardware. More detailed information on voltage margining using TPS6213xA-Q1 can be found in [SLVA489](#). A pull down resistor of about 400kOhm is internally connected to the pin, to ensure a proper logic level if the pin is high impedance or floating after initially set to Low. The resistor is disconnected if the pin is set High.

9.3.9 Frequency Selection (FSW)

To get high power density with very small solution size, a high switching frequency allows the use of small external components for the output filter. However switching losses increase with the switching frequency. If efficiency is the key parameter, more than solution size, the switching frequency can be set to half (1.25 MHz typ.) by pulling FSW to High. Running with lower frequency a higher efficiency, but also a higher output voltage ripple, is achieved. Pull FSW to Low for high frequency operation (2.5 MHz typ.). To get low ripple and full output current at the lower switching frequency, it's recommended to use an inductor of at least 2.2uH. The switching frequency can be changed during operation, if needed. A pull down resistor of about 400kOhm is internally connected to the pin, acting the same way as at the DEF Pin (see above).

9.3.10 Under Voltage Lockout (UVLO)

If the input voltage drops, the under voltage lockout prevents misoperation of the device by switching off both the power FETs. The under voltage lockout threshold is set typically to 2.7V. The device is fully operational for voltages above the UVLO threshold and turns off if the input voltage trips the threshold. The converter starts operation again once the input voltage exceeds the threshold by a hysteresis of typically 200mV.

9.3.11 Thermal Shutdown

The junction temperature (T_J) of the device is monitored by an internal temperature sensor. If T_J exceeds 160°C (typ), the device goes into thermal shutdown. Both the high-side and low-side power FETs are turned off and PG goes Low. When T_J decreases below the hysteresis amount, the converter resumes normal operation, beginning with Soft Start. To avoid unstable conditions, a hysteresis of typically 20°C is implemented on the thermal shutdown temperature.

9.4 Device Functional Modes

9.4.1 Operation Above $T_J=125^\circ\text{C}$

The operating junction temperature of the device is specified up to 125°C. In power supplying circuits, the self heating effect causes, that the junction temperature, T_J , is even higher than the ambient temperature T_A (see [Figure 43](#)). Depending on T_A and the load current, the maximum operating T_J can be exceeded. However, the electrical characteristics are specified up to a T_J of 125°C only. The device operates as long as thermal shutdown threshold is not triggered.

(1) Maximum allowed voltage is 7V. Therefore it's recommended to connect it to V_{OUT} , not V_{IN} .

Device Functional Modes (continued)

9.4.2 Operation with $V_{IN} < 3V$

The device is functional for supply voltages below 3V and above the UVLO threshold. Parameters may differ from specified values. The minimum V_{IN} value of 3V is not violated by UVLO threshold and hysteresis variations.

9.4.3 Operation with Separate EN Control

The EN pin can be connected to V_{IN} or be controlled separately. While the EN control voltage level can be lower than the actual V_{IN} value, it must not exceed V_{IN} to avoid damage of the device. This might happen at low V_{IN} , during startup or power sequencing.

10 Application and Implementation

10.1 Application Information

TPS62130xA-Q1 are synchronous switch mode step-down converters, able to convert a 3V to 17V input voltage into a lower, 0.9V to 6V, output voltage, providing up to 3A load current. The following section gives guidance on choosing external components to complete the power supply design. [Application Curves](#) are included for the typical application shown here.

10.2 Typical Application

10.2.1 TPS62130A-Q1 Point-Of-Load Step Down Converter

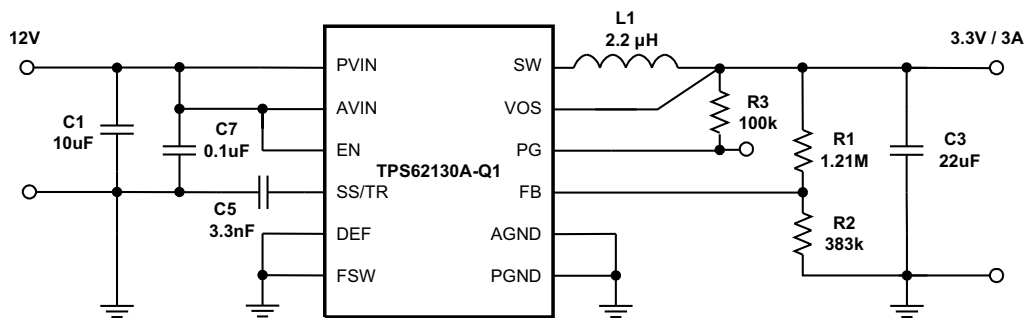

Copyright © 2017, Texas Instruments Incorporated

Figure 10. Typical Schematic for 3.3 V Step-Down Converter

10.2.1.1 Design Requirements

The step-down converter design can be adapted to different output voltage and load current needs by choosing external components appropriate. The following design procedure is adequate for whole V_{IN} , V_{OUT} and load current range of TPS62130A-Q1. Using [Table 3](#), the design procedure needs minimum effort.

10.2.1.2 Detailed Design Procedure

10.2.1.2.1 Custom Design With WEBENCH® Tools

[Click here](#) to create a custom design using the TPS62130A-Q1 device with the WEBENCH® Power Designer.

1. Start by entering the input voltage (V_{IN}), output voltage (V_{OUT}), and output current (I_{OUT}) requirements.
2. Optimize the design for key parameters such as efficiency, footprint, and cost using the optimizer dial.
3. Compare the generated design with other possible solutions from Texas Instruments.

The WEBENCH Power Designer provides a customized schematic along with a list of materials with real-time pricing and component availability.

In most cases, these actions are available:

- Run electrical simulations to see important waveforms and circuit performance
- Run thermal simulations to understand board thermal performance
- Export customized schematic and layout into popular CAD formats
- Print PDF reports for the design, and share the design with colleagues

Get more information about WEBENCH tools at www.ti.com/WBENCH.

Typical Application (continued)

10.2.1.2.2 Programming The Output Voltage

The TPS6213xA-Q1 can be programmed for output voltages from 0.9V to 6V by using a resistive divider from VOUT to AGND. The voltage at the FB pin is regulated to 800mV. The value of the output voltage is set by the selection of the resistive divider from [Equation 6](#) (see [Figure 10](#)). It is recommended to choose resistor values which allow a current of at least 2uA, meaning the value of R2 shouldn't exceed 400kΩ. Lower resistor values are recommended for highest accuracy and most robust design. For applications requiring lowest current consumption, the use of fixed output voltage versions is recommended.

$$R_1 = R_2 \left(\frac{V_{OUT}}{0.8V} - 1 \right) \quad (6)$$

In case the FB pin gets opened, the device clamps the output voltage at the VOS pin internally to about 7.4V.

10.2.1.2.3 External Component Selection

The external components have to fulfill the needs of the application, but also the stability criteria of the device's control loop. The TPS6213xA-Q1 is optimized to work within a range of external components. The LC output filter's inductance and capacitance must be considered together, creating a double pole, responsible for the corner frequency of the converter (see [Output Filter And Loop Stability](#)). [Table 3](#) can be used to simplify the output filter component selection.

Table 3. Recommended LC Output Filter Combinations⁽¹⁾

	4.7μF	10μF	22μF	47μF	100μF	200μF	400μF
0.47μH							
1μH			√	√	√	√	
2.2μH		√	√ ⁽²⁾	√	√	√	
3.3μH		√	√	√	√		
4.7μH							

(1) The values in the table are nominal values.

(2) This LC combination is the standard value and recommended for most applications.

The TPS6213xA-Q1 can be run with an inductor as low as 1μH. FSW should be set Low in this case. However, for applications running with the low frequency setting (FSW=High) or with low input voltages, 2.2μH is recommended.

More detailed information on further LC combinations can be found in [SLVA463](#).

10.2.1.2.4 Inductor Selection

The inductor selection is affected by several effects like inductor ripple current, output ripple voltage, PWM-to-PSM transition point and efficiency. In addition, the inductor selected has to be rated for appropriate saturation current and DC resistance (DCR). [Equation 7](#) and [Equation 8](#) calculate the maximum inductor current under static load conditions.

$$I_{L(max)} = I_{OUT(max)} + \frac{\Delta I_{L(max)}}{2} \quad (7)$$

$$\Delta I_{L(\max)} = V_{OUT} \cdot \left(\frac{1 - \frac{V_{OUT}}{V_{IN(\max)}}}{L_{(\min)} \cdot f_{SW}} \right)$$

where:

- $I_L(\max)$ is the maximum inductor current,
- ΔI_L is the Peak to Peak Inductor Ripple Current,
- $L(\min)$ is the minimum effective inductor value and
- f_{SW} is the actual PWM Switching Frequency.

(8)

Calculating the maximum inductor current using the actual operating conditions gives the minimum saturation current of the inductor needed. A margin of about 20% is recommended to add. A larger inductor value is also useful to get lower ripple current, but increases the transient response time and solution size as well. The following inductors have been used with the TPS6213xA-Q1 and are recommended for use:

Table 4. List of Inductors⁽¹⁾

Type	Inductance [μH]	Current [A] ⁽²⁾	Dimensions [LxBxH] mm	MANUFACTURER
XFL4020-102ME_	1.0 μH, ±20%	4.7	4 x 4 x 2.1	Coilcraft
XFL4020-152ME_	1.5 μH, ±20%	4.2	4 x 4 x 2.1	Coilcraft
XFL4020-222ME_	2.2 μH, ±20%	3.8	4 x 4 x 2.1	Coilcraft
IHLP1212BZ-11	1.0 μH, ±20%	4.5	3 x 3.6 x 2	Vishay
IHLP1212BZ-11	2.2 μH, ±20%	3.0	3 x 3.6 x 2	Vishay
SRP4020-3R3M	3.3μH, ±20%	3.3	4.8 x 4 x 2	Bourns
VLC5045T-3R3N	3.3μH, ±30%	4.0	5 x 5 x 4.5	TDK

(1) See [Third-Party Products Disclaimer](#).

(2) Lower of I_{RMS} at 40°C rise or I_{SAT} at 30% drop.

The inductor value also determines the load current at which Power Save Mode is entered:

$$I_{load(PSM)} = \frac{1}{2} \Delta I_L$$

(9)

Using [Equation 8](#), this current level can be adjusted by changing the inductor value.

10.2.1.2.5 Output Capacitor

The recommended value for the output capacitor is 22μF. The architecture of the TPS6213xA-Q1 allows the use of tiny ceramic output capacitors with low equivalent series resistance (ESR). These capacitors provide low output voltage ripple and are recommended. To keep its low resistance up to high frequencies and to get narrow capacitance variation with temperature, it's recommended to use an X7R or X5R dielectric. Using a higher value can have some advantages like smaller voltage ripple and a tighter DC output accuracy in Power Save Mode (see [SLVA463](#)).

Note: In power save mode, the output voltage ripple depends on the output capacitance, its ESR and the peak inductor current. Using ceramic capacitors provides small ESR and low ripple.

10.2.1.2.6 Input Capacitor

For most applications, 10µF is sufficient and is recommended, though a larger value reduces input current ripple further. The input capacitor buffers the input voltage during transient events and also decouples the converter from the supply. A low ESR multilayer ceramic capacitor is recommended for best filtering and should be placed between PVIN and PGND as close as possible to those pins. Even though AVIN and PVIN must be supplied from the same input source, it's required to place a capacitance of 0.1µF from AVIN to AGND, to avoid potential noise coupling. An RC, low-pass filter from PVIN to AVIN may be used but is not required.

10.2.1.2.7 Soft Start Capacitor

A capacitance connected between SS/TR pin and AGND allows a user programmable start-up slope of the output voltage. A constant current source supports 2.5µA to charge the external capacitance. The capacitor required for a given soft-start ramp time for the output voltage is given by:

$$C_{SS} = t_{SS} \cdot \frac{2.5\mu A}{1.25V} [F]$$

where:

- C_{SS} is the capacitance (F) required at the SS/TR pin and
- t_{SS} is the desired soft-start ramp time (s). (10)

NOTE

DC Bias effect: High capacitance ceramic capacitors have a DC Bias effect, which will have a strong influence on the final effective capacitance. Therefore the right capacitor value has to be chosen carefully. Package size and voltage rating in combination with dielectric material are responsible for differences between the rated capacitor value and the effective capacitance.

10.2.1.2.8 Tracking Function

If a tracking function is desired, the SS/TR pin can be used for this purpose by connecting it to an external tracking voltage. The output voltage tracks that voltage. If the tracking voltage is between 50mV and 1.2V, the FB pin tracks the SS/TR pin voltage as described in [Equation 11](#) and shown in [Figure 11](#).

$$V_{FB} \approx 0.64 \cdot V_{SS/TR} \tag{11}$$

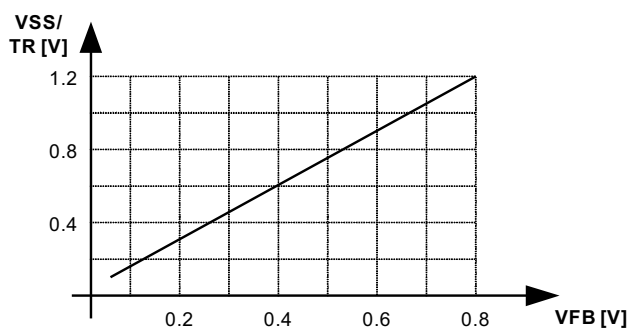
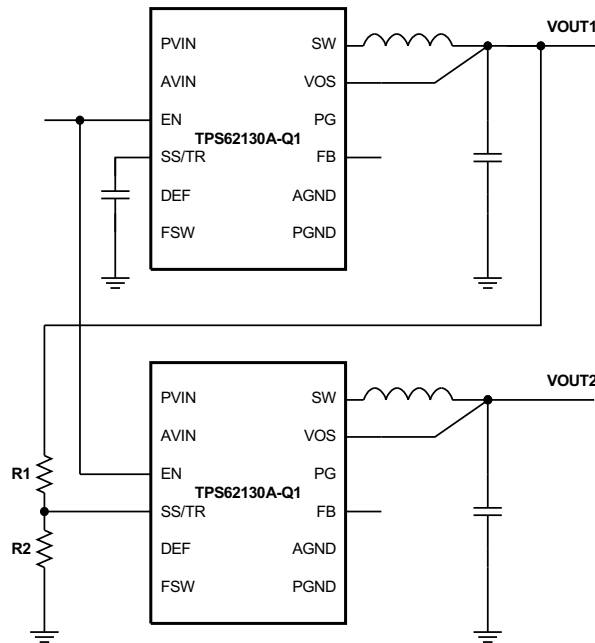

Figure 11. Voltage Tracking Relationship

Once the SS/TR pin voltage reaches about 1.2V, the internal voltage is clamped to the internal feedback voltage and device goes to normal regulation. This works for rising and falling tracking voltages with the same behavior, as long as the input voltage is inside the recommended operating conditions. For decreasing SS/TR pin voltage, the device doesn't sink current from the output. So, the resulting decrease of the output voltage may be slower than the SS/TR pin voltage if the load is light. When driving the SS/TR pin with an external voltage, do not exceed the voltage rating of the SS/TR pin which is $V_{IN}+0.3V$.

If the input voltage drops into undervoltage lockout or even down to zero, the output voltage will go to zero, independent of the tracking voltage. Figure 12 shows how to connect devices to get ratiometric and simultaneous sequencing by using the tracking function.



Copyright © 2017, Texas Instruments Incorporated

Figure 12. Sequence for Ratiometric and Simultaneous Startup

The resistive divider of R1 and R2 can be used to change the ramp rate of VOUT2 faster, slower or the same as VOUT1.

A sequential startup is achieved by connecting the PG pin of VOUT1 to the EN pin of VOUT2. Ratiometric start up sequence happens if both supplies are sharing the same soft start capacitor. Equation 10 calculates the soft start time, though the SS/TR current has to be doubled. Details about these and other tracking and sequencing circuits are found in SLVA470.

Note: If the voltage at the FB pin is below its typical value of 0.8V, the output voltage accuracy may have a wider tolerance than specified.

10.2.1.2.9 Output Filter And Loop Stability

The devices of the TPS6213xA-Q1 family are internally compensated to be stable with L-C filter combinations corresponding to a corner frequency to be calculated with Equation 12:

$$f_{LC} = \frac{1}{2\pi\sqrt{L \cdot C}} \quad (12)$$

Proven nominal values for inductance and ceramic capacitance are given in [Table 3](#) and are recommended for use. Different values may work, but care has to be taken on the loop stability which is affected. More information including a detailed LC stability matrix can be found in [SLVA463](#).

The TPS6213xA-Q1 includes an internal 25pF feedforward capacitor, connected between the VOS and FB pins. This capacitor impacts the frequency behavior and sets a pole and zero in the control loop with the resistors of the feedback divider, per equation [Equation 13](#) and [Equation 14](#):

$$f_{zero} = \frac{1}{2\pi \cdot R_1 \cdot 25 pF} \quad (13)$$

$$f_{pole} = \frac{1}{2\pi \cdot 25 pF} \cdot \left(\frac{1}{R_1} + \frac{1}{R_2} \right) \quad (14)$$

Though the TPS6213xA-Q1 is stable without the pole and zero being in a particular location, adjusting their location to the specific needs of the application can provide better performance in Power Save mode and/or improved transient response. An external feedforward capacitor can also be added. A more detailed discussion on the optimization for stability vs. transient response can be found in [SLVA289](#) and [SLVA466](#).

10.2.1.3 Application Curves

At $V_{IN}=12V$, $V_{OUT}=3.3V$ and $T_A=25^\circ C$, FSW=Low, (unless otherwise noted)

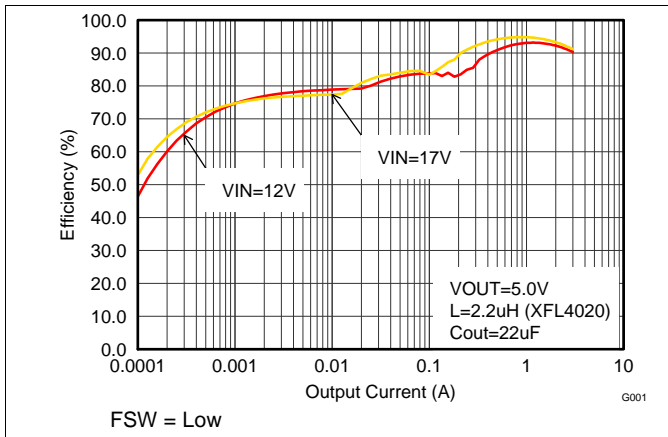

Figure 13. Efficiency vs. Output Current

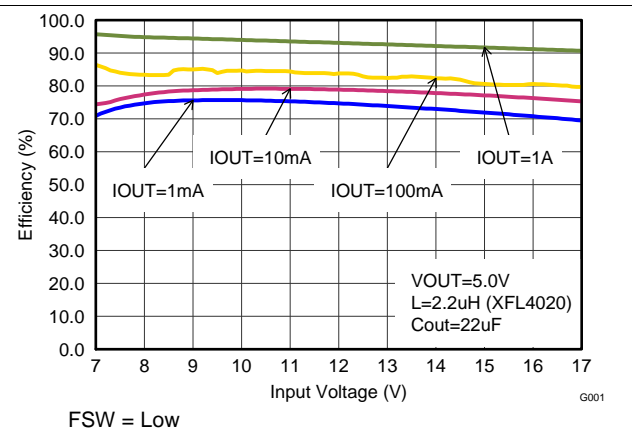

Figure 14. Efficiency vs. Input Voltage

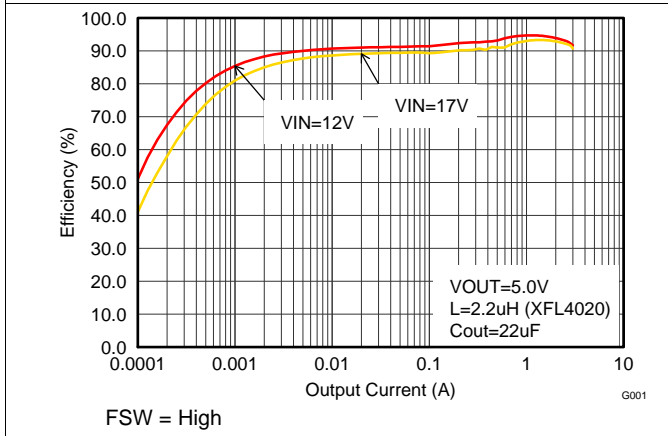

Figure 15. Efficiency vs. Output Current

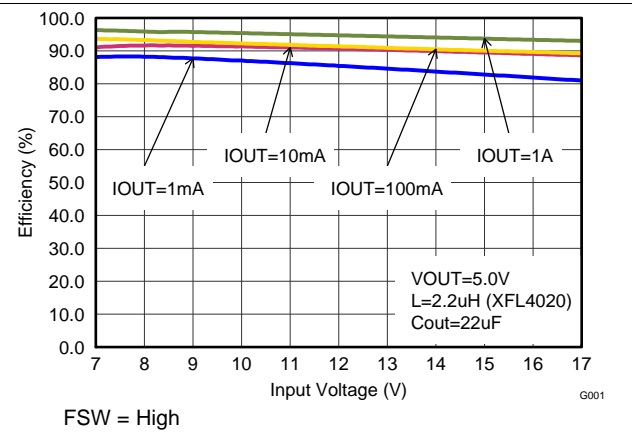

Figure 16. Efficiency vs. Input Voltage

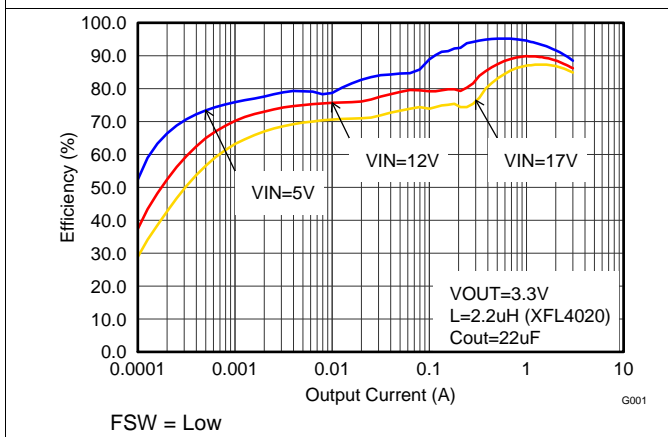

Figure 17. Efficiency vs. Output Current

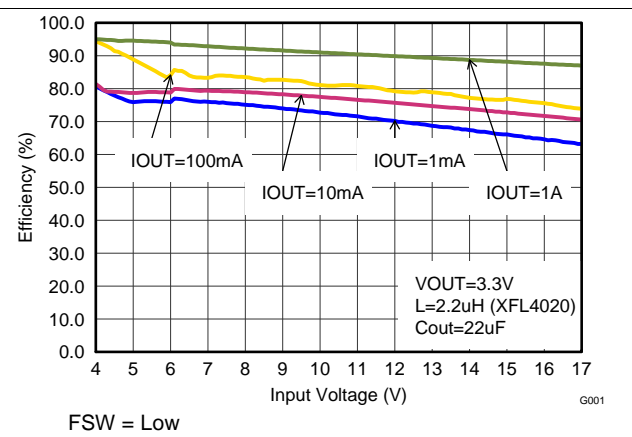

Figure 18. Efficiency vs. Input Voltage

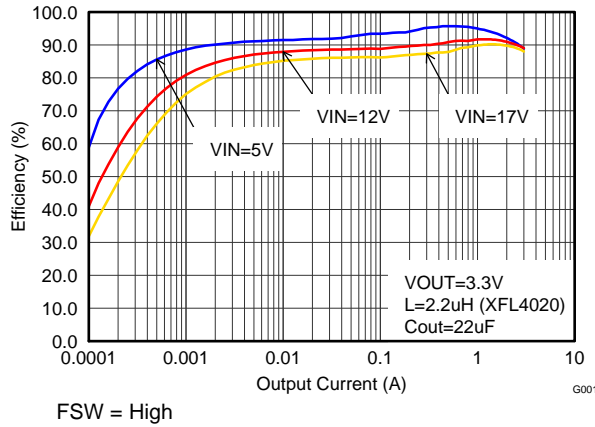

Figure 19. Efficiency vs. Output Current

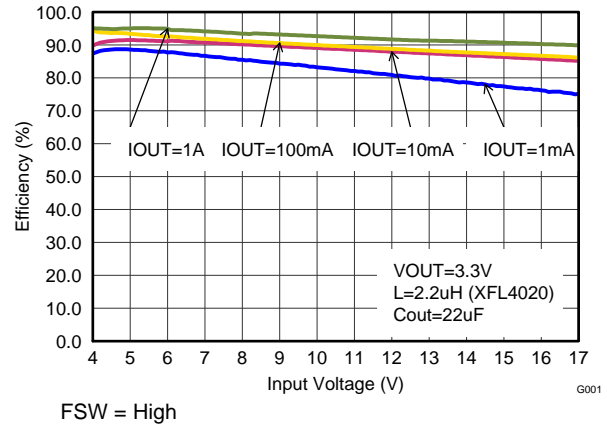

Figure 20. Efficiency vs. Input Voltage

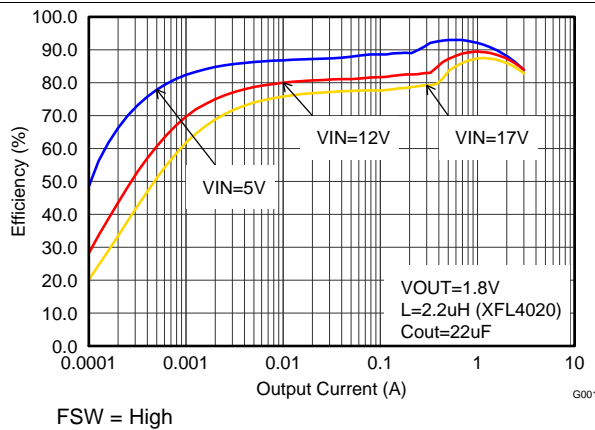

Figure 21. Efficiency vs. Output Current

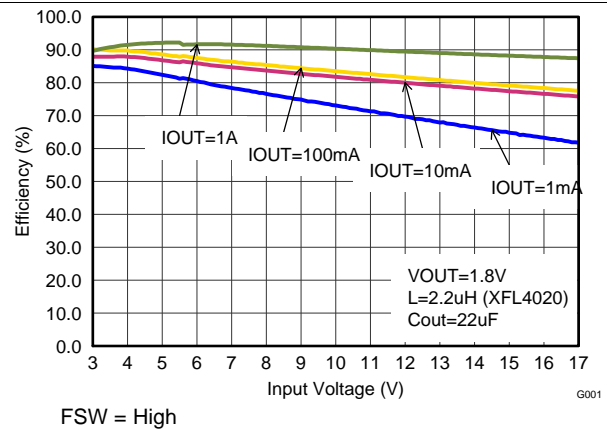

Figure 22. Efficiency vs. Input Voltage

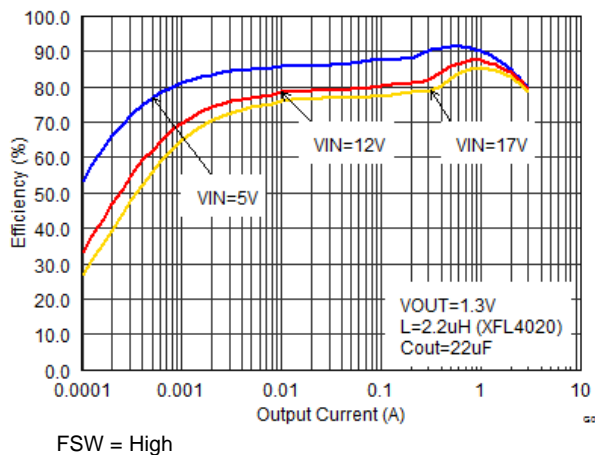

Figure 23. Efficiency vs. Output Current

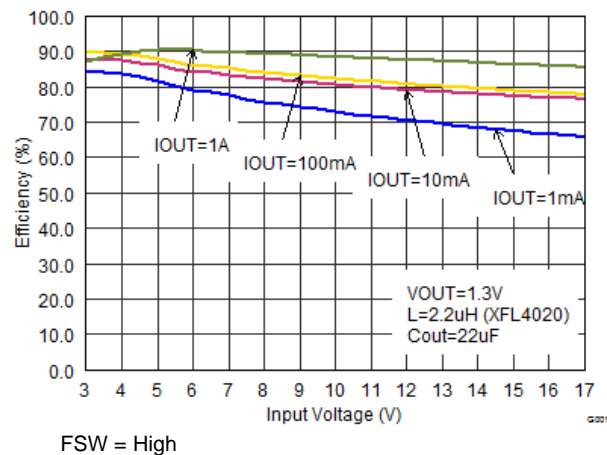

Figure 24. Efficiency vs. Input Voltage

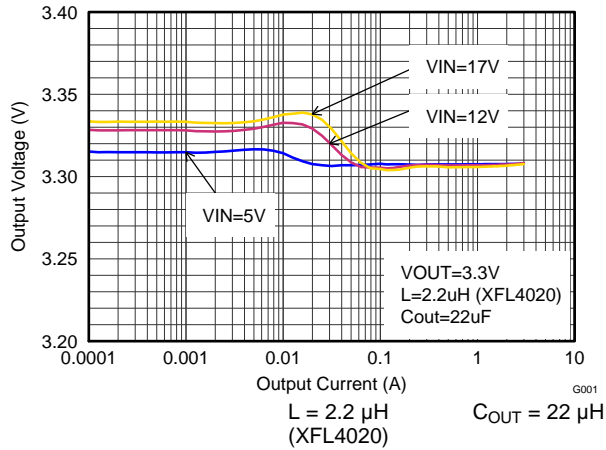

Figure 25. Output Voltage Accuracy (Load Regulation)

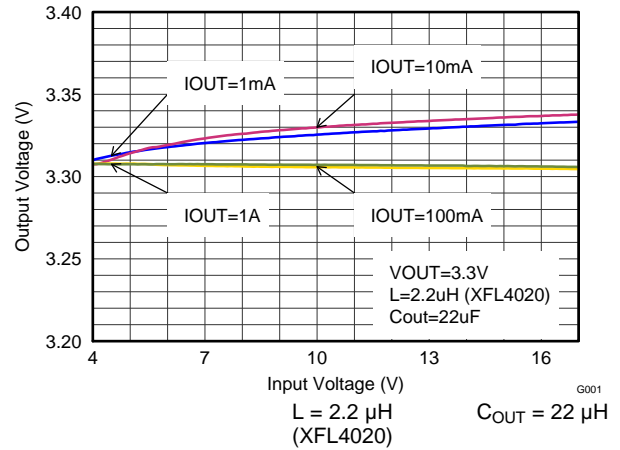

Figure 26. Output Voltage Accuracy (Line Regulation)

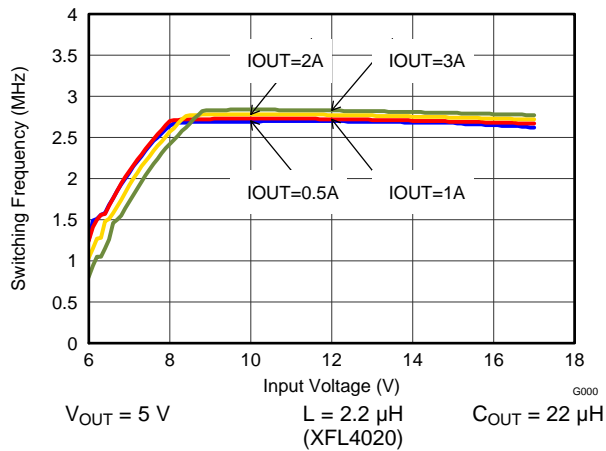

Figure 27. Switching Frequency vs. Input Voltage

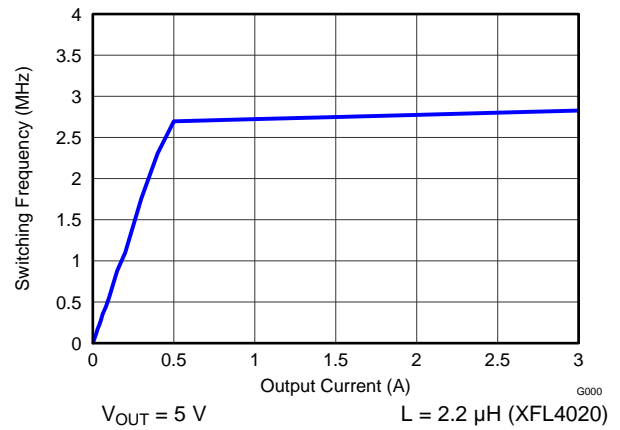

Figure 28. Switching Frequency vs. Output Current

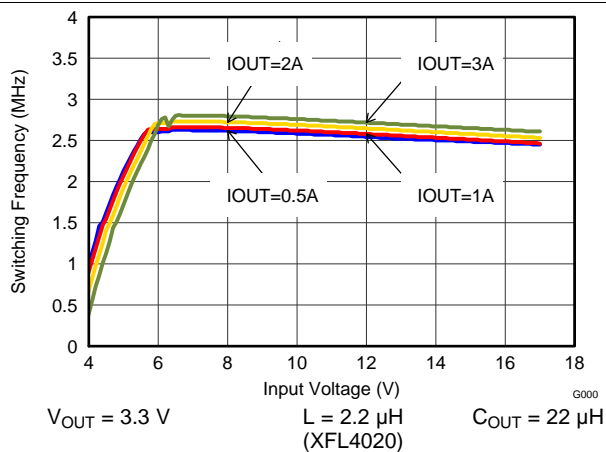

Figure 29. Switching Frequency vs. Input Voltage

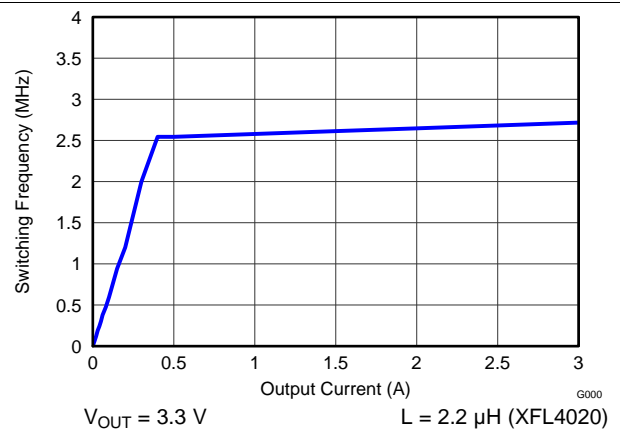

Figure 30. Switching Frequency vs. Output Current

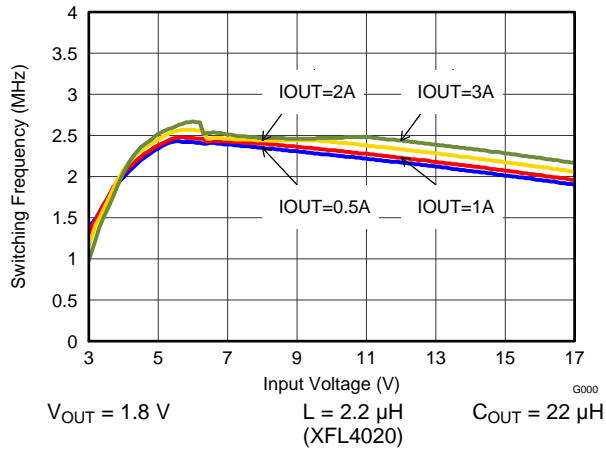

Figure 31. Switching Frequency vs. Input Voltage

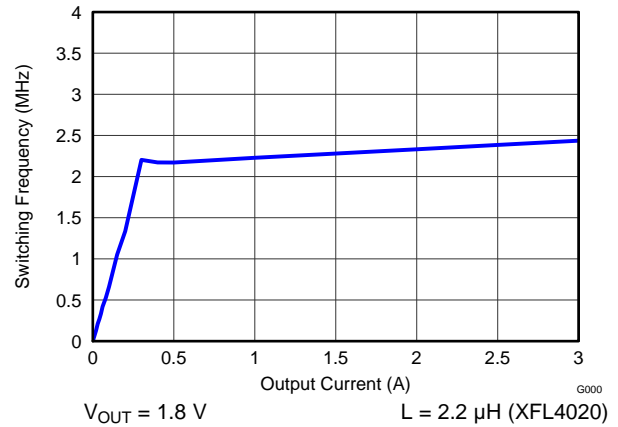

Figure 32. Switching Frequency vs. Output Current

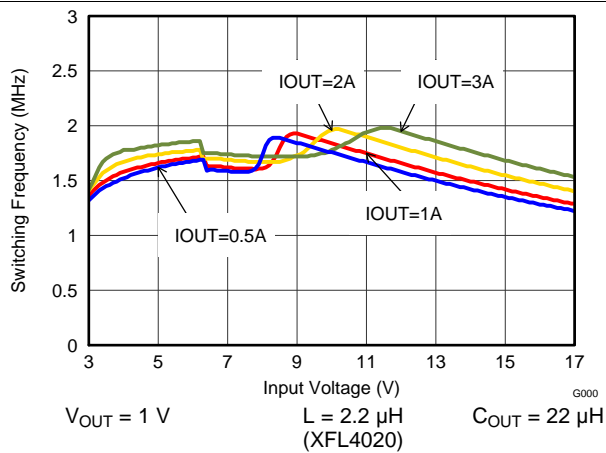

Figure 33. Switching Frequency vs. Input Voltage

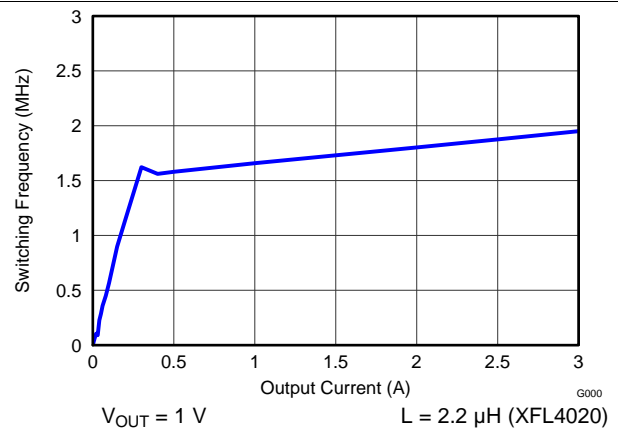

Figure 34. Switching Frequency vs. Output Current

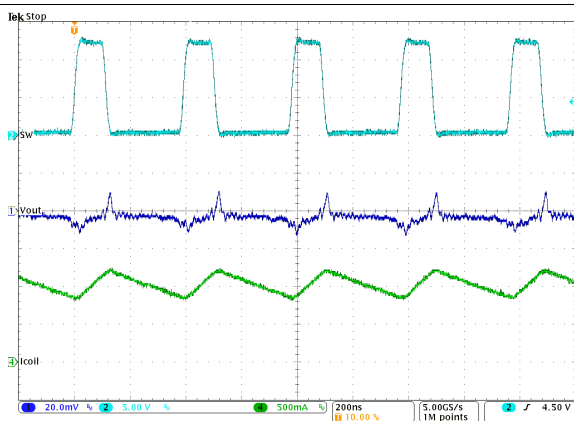

Figure 35. Typical Operation in PWM Mode ($I_{OUT} = 1\text{ A}$)

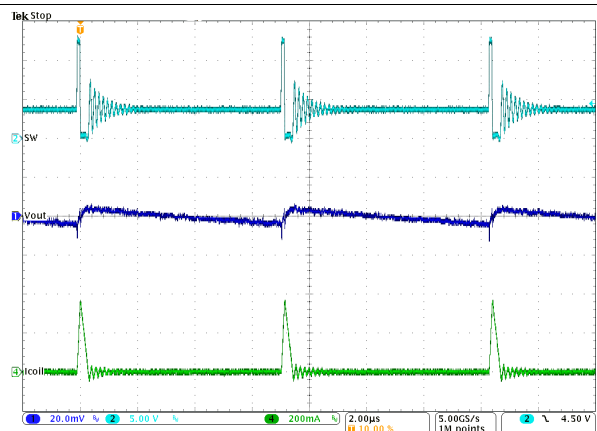

Figure 36. Typical Operation in Power Save Mode ($I_{OUT} = 10\text{ mA}$)

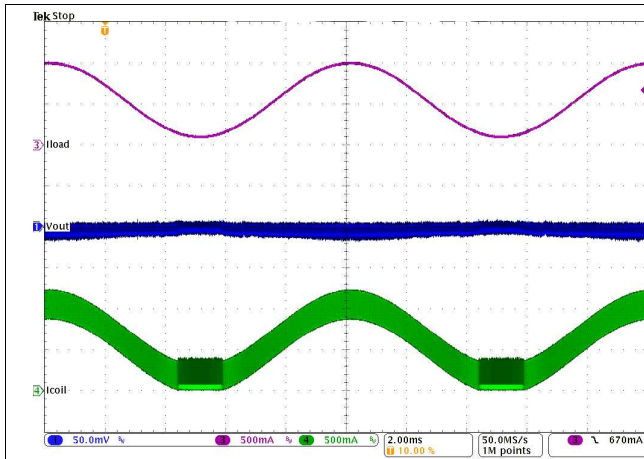

Figure 37. PWM-PSM-Transition

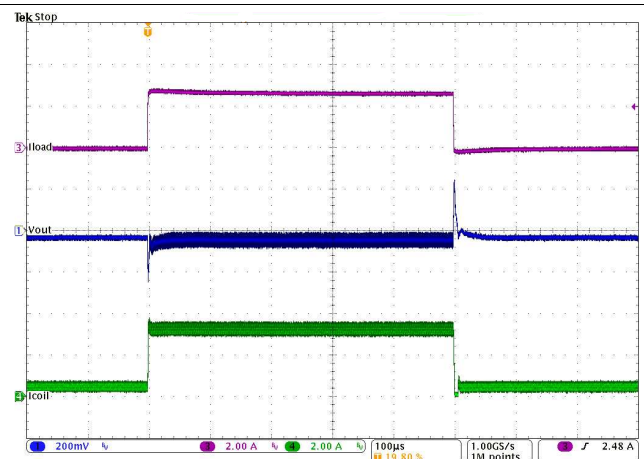

Figure 38. Load Transient Response (0.5 to 3 to 0.5 A)

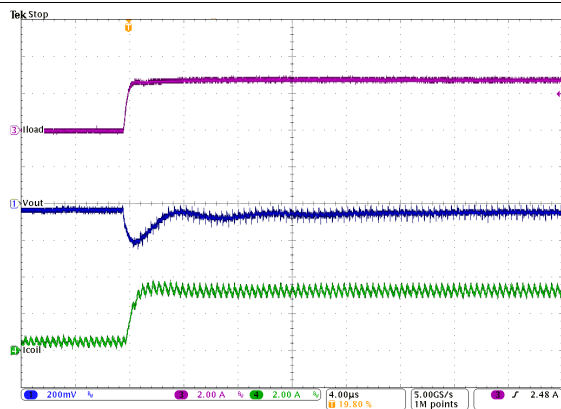

Figure 39. Load Transient Response of Figure 38, Rising Edge

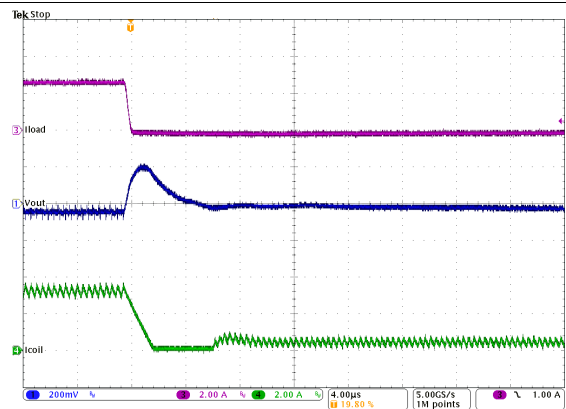

Figure 40. Load Transient Response of Figure 38, Falling Edge

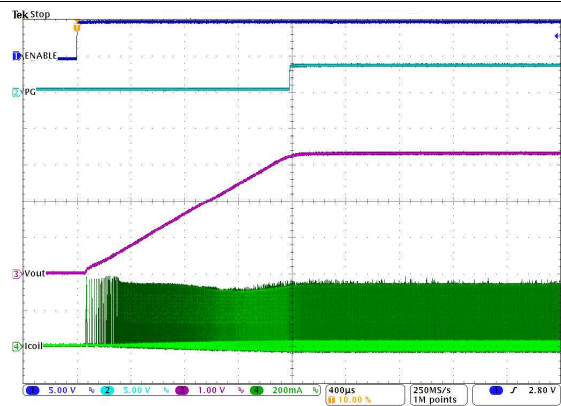

Figure 41. Start Up into 100 mA

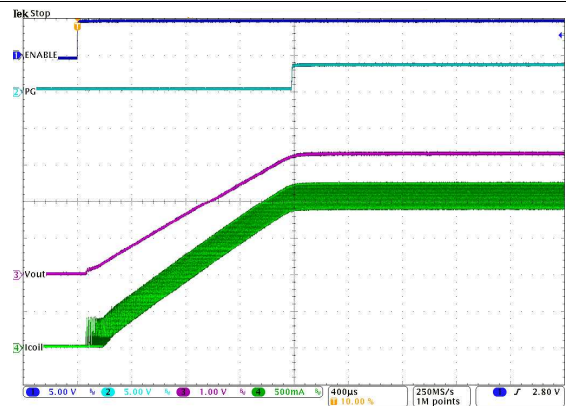

Figure 42. Start Up into 3 A

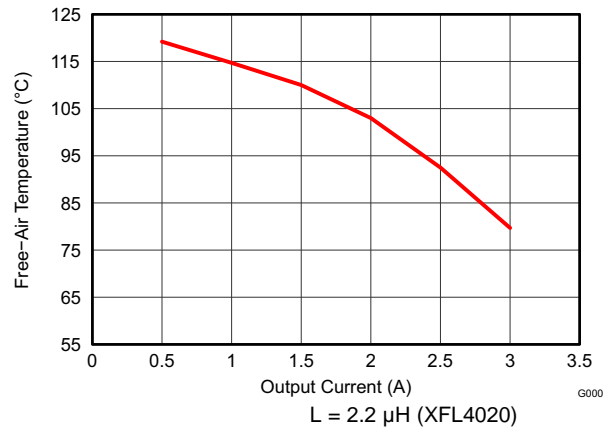
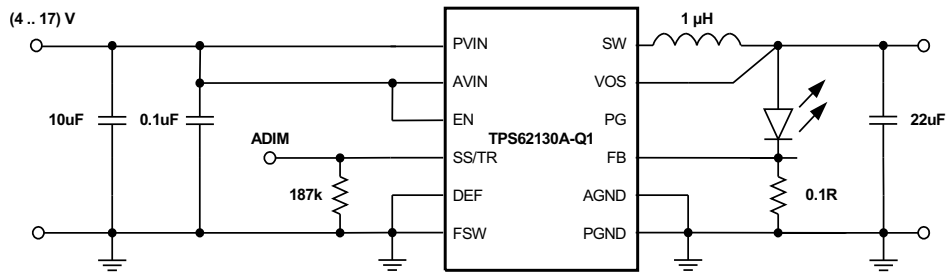

Figure 43. Maximum Ambient Temperature

10.3 System Examples

10.3.1 Regulated Power LED Supply

The TPS62130A-Q1 can be used as a power supply for power LEDs. The FB pin can be easily set down to lower values than nominal by using the SS/TR pin. With that, the voltage drop on the sense resistor is low, avoiding excessive power loss. Since this pin provides 2.5µA, the feedback pin voltage can be adjusted by an external resistor per Equation 15. This drop, proportional to the LED current, is used to regulate the output voltage (anode voltage) to a proper level to drive the LED. Both analog and PWM dimming are supported with the TPS62130A-Q1. Figure 44 shows an application circuit, tested with analog dimming:



Copyright © 2017, Texas Instruments Incorporated

Figure 44. Single Power LED Supply

The resistor at SS/TR sets the FB voltage to a level of about 300mV and is calculated from Equation 15.

$$V_{FB} = 0.64 \cdot 2.5\mu A \cdot R_{SS/TR} \quad (15)$$

The device now supplies a constant current, set by the resistor at the FB pin, by regulating the output voltage accordingly. The minimum input voltage has to be rated according to the forward voltage needed by the LED used. More information is available in the Application Note SLVA451.

10.3.2 Inverting Power Supply

The TPS62130A-Q1 can be used as inverting power supply by rearranging external circuitry as shown in Figure 45.

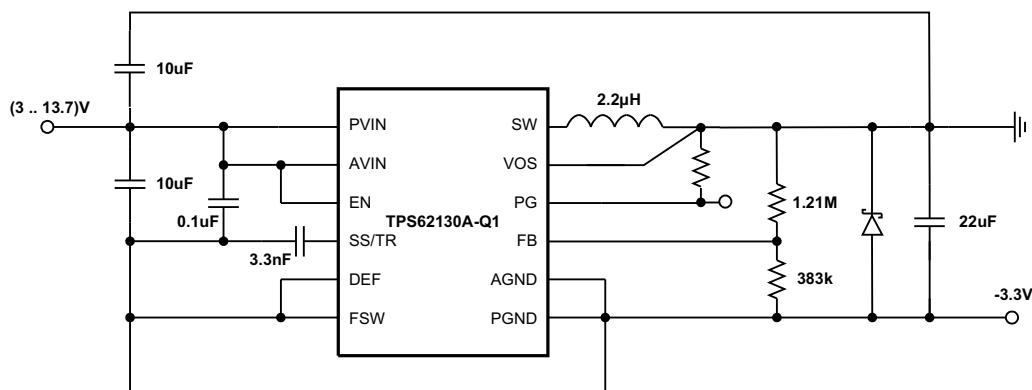

Copyright © 2017, Texas Instruments Incorporated

Figure 45. -3.3 V Inverting Power Supply

System Examples (continued)

As the former GND node now represents a voltage level below system ground, the voltage difference between V_{IN} and V_{OUT} has to be limited for operation to the maximum supply voltage of 17V (see Equation 16).

$$V_{IN} + |V_{OUT}| \leq V_{INmax} \quad (16)$$

The transfer function of the inverting power supply configuration differs from the buck mode transfer function, incorporating a Right Half Plane Zero additionally. The loop stability has to be adapted and an output capacitance of at least 22 μ F is recommended. A detailed design example is given in [SLVA469](#).

10.3.3 Active Output Discharge

The TPS6213xA-Q1 pulls the PG pin Low, when the device is shut down by EN, UVLO or thermal shutdown. Connecting PG to V_{OUT} through a resistor can be used to discharge V_{OUT} in those cases (see [Figure 46](#)).

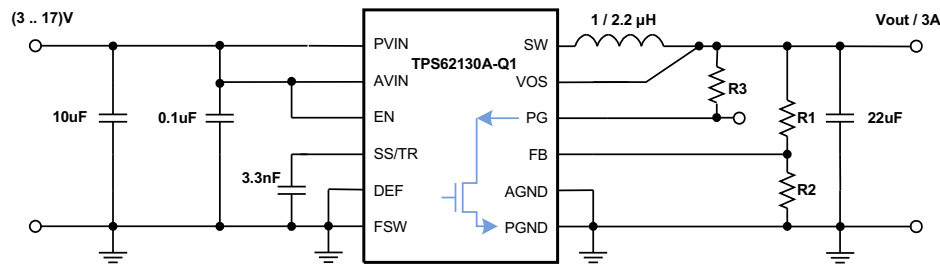

Copyright © 2017, Texas Instruments Incorporated

Figure 46. Output Discharge using PG Pin

The discharge rate can be adjusted by R3, which is also used to pull up the PG pin in normal operation. For reliability, keep the maximum current into the PG pin less than 10mA.

10.3.4 Various Output Voltages

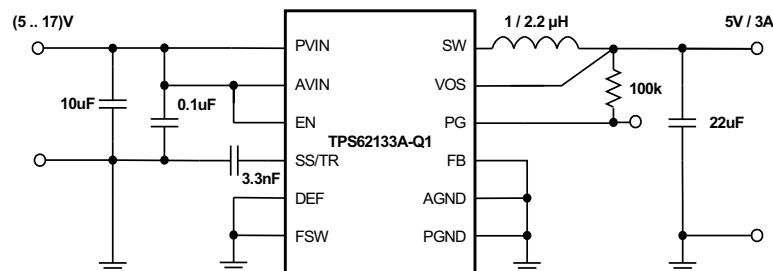

Copyright © 2017, Texas Instruments Incorporated

Figure 47. 5 V Power Supply using TPS62133A-Q1 fixed V_{OUT} version

System Examples (continued)

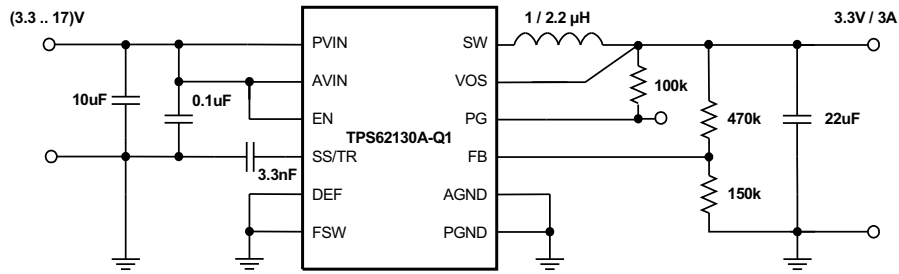

Copyright © 2017, Texas Instruments Incorporated

Figure 48. 3.3 V/3 A Power Supply

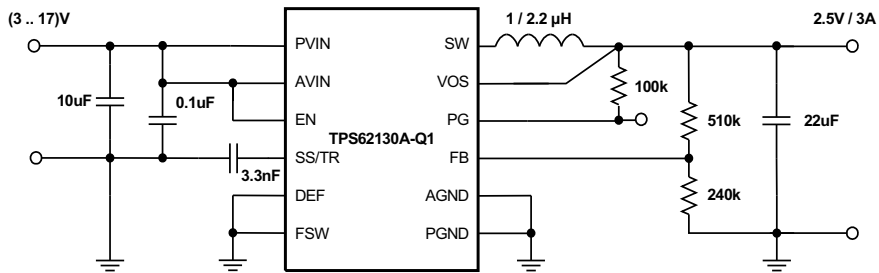

Copyright © 2017, Texas Instruments Incorporated

Figure 49. 2.5 V/3 A Power Supply

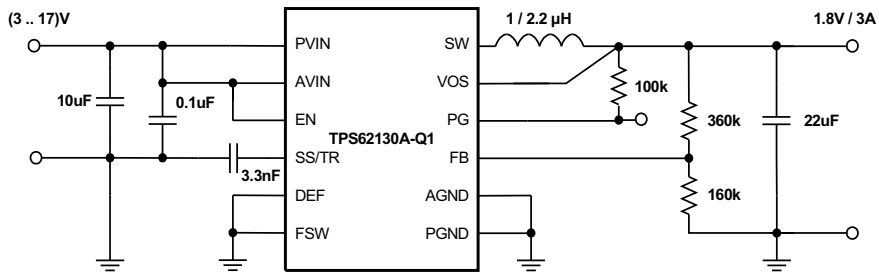

Copyright © 2017, Texas Instruments Incorporated

Figure 50. 1.8 V/3 A Power Supply

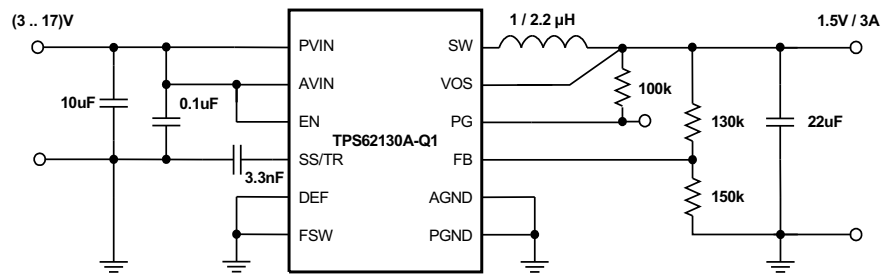
System Examples (continued)

Copyright © 2017, Texas Instruments Incorporated

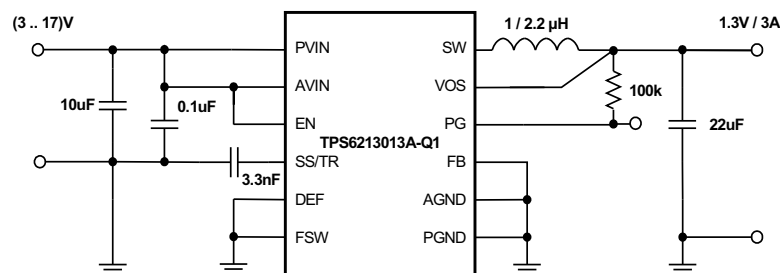
Figure 51. 1.5 V/3 A Power Supply

Copyright © 2017, Texas Instruments Incorporated

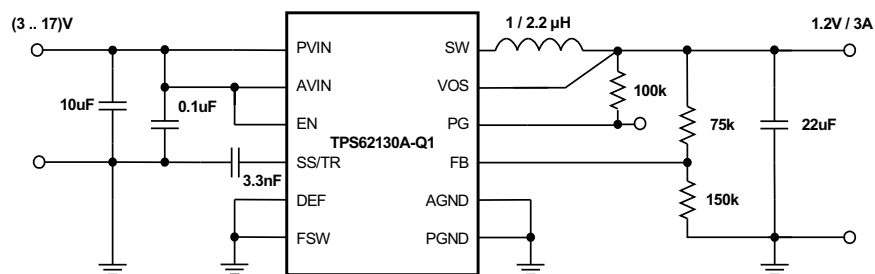
Figure 52. 1.3 V/3 A Power Supply using TPS6213013A-Q1 fixed V_{OUT} version

Copyright © 2017, Texas Instruments Incorporated

Figure 53. 1.2 V/3 A Power Supply

System Examples (continued)

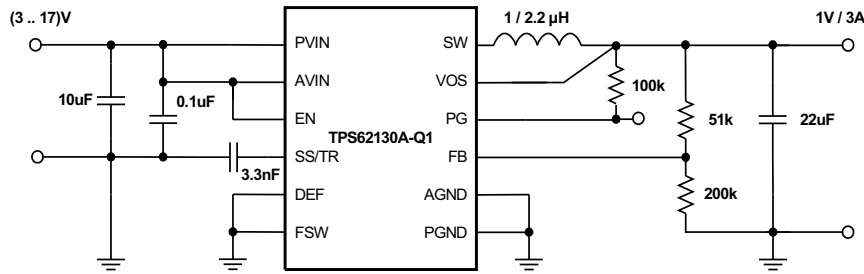

Copyright © 2017, Texas Instruments Incorporated

Figure 54. 1 V/3 A Power Supply

11 Power Supply Recommendations

The TPS6213xA-Q1 devices are designed to operate from a 3 to 17V input voltage supply. To avoid insufficient supply current due to line drop, ringing due to trace inductance at the VIN terminal or supply peak current limitations, additional bulk capacitance may be required. In the case ringing that is caused by the interaction with the ceramic input capacitors, an electrolytic or tantalum type capacitor may be needed for damping.

12 Layout

12.1 Layout Guidelines

A proper layout is critical for the operation of a switched mode power supply, even more at high switching frequencies. Therefore the PCB layout of the TPS6213xA-Q1 demands careful attention to ensure operation and to get the performance specified. A poor layout can lead to issues like poor regulation (both line and load), stability and accuracy weaknesses, increased EMI radiation and noise sensitivity. The layout also influences the thermal performance of the solution by its power dissipation capabilities.

See [Figure 55](#) for the recommended layout of the TPS62130A-Q1, which is designed for common external ground connections. Therefore both AGND and PGND pins are directly connected to the Exposed Thermal Pad. On the PCB, the direct common ground connection of AGND and PGND to the Exposed Thermal Pad and the system ground (ground plane) is mandatory. Also connect the VOS pin in the shortest way to the V_{OUT} potential at the output capacitor.

Provide low inductive and resistive paths for loops with high di/dt . Therefore paths conducting the switched load current should be as short and wide as possible. Provide low capacitive paths (with respect to all other nodes) for wires with high dv/dt . Therefore the input and output capacitance should be placed as close as possible to the IC pins and parallel wiring over long distances as well as narrow traces should be avoided. Loops which conduct an alternating current should outline an area as small as possible, as this area is proportional to the energy radiated.

Sensitive nodes like FB and VOS need to be connected with short wires and not nearby high dv/dt signals (e.g. SW). As they carry information about the output voltage, they should be connected as close as possible to the actual output voltage (at the output capacitor). The capacitor on the SS/TR pin and on AVIN as well as the FB resistors, R1 and R2, should be kept close to the IC and connect directly to those pins and the AGND pin.

The Exposed Thermal Pad must be soldered to the circuit board for mechanical reliability and to achieve appropriate power dissipation.

The recommended layout is implemented on the EVM and shown in its Users Guide, [SLVU437](#). Additionally, the EVM Gerber data are available for download here, [SLVC394](#).

12.2 Layout Example

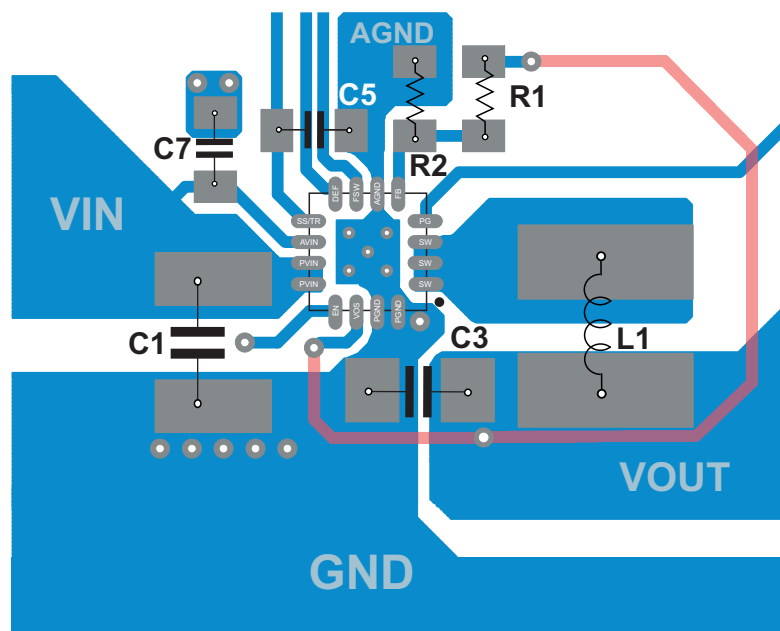

Figure 55. Layout Example with TPS62130A-Q1

13 器件和文档支持

13.1 器件支持

13.1.1 Third-Party Products Disclaimer

TI'S PUBLICATION OF INFORMATION REGARDING THIRD-PARTY PRODUCTS OR SERVICES DOES NOT CONSTITUTE AN ENDORSEMENT REGARDING THE SUITABILITY OF SUCH PRODUCTS OR SERVICES OR A WARRANTY, REPRESENTATION OR ENDORSEMENT OF SUCH PRODUCTS OR SERVICES, EITHER ALONE OR IN COMBINATION WITH ANY TI PRODUCT OR SERVICE.

13.2 相关链接

下面的表格列出了快速访问链接。类别包括技术文档、支持与社区资源、工具和软件，以及申请样片或购买产品的快速链接。

表 5. 相关链接

器件	产品文件夹	样片与购买	技术文档	工具和软件	支持和社区
TPS62130A-Q1	请单击此处	请单击此处	请单击此处	请单击此处	请单击此处
TPS62133A-Q1	请单击此处	请单击此处	请单击此处	请单击此处	请单击此处
TPS6213013A-Q1	请单击此处	请单击此处	请单击此处	请单击此处	请单击此处

13.3 Receiving Notification of Documentation Updates

To receive notification of documentation updates, navigate to the device product folder on ti.com. In the upper right corner, click on *Alert me* to register and receive a weekly digest of any product information that has changed. For change details, review the revision history included in any revised document.

13.4 Community Resources

下列链接提供到 TI 社区资源的连接。链接的内容由各个分销商“按照原样”提供。这些内容并不构成 TI 技术规范，并且不一定反映 TI 的观点；请参阅 TI 的《使用条款》。

TI E2E™ 在线社区 *TI 的工程师对工程师 (E2E) 社区*。此社区的创建目的在于促进工程师之间的协作。在 e2e.ti.com 中，您可以咨询问题、分享知识、拓展思路并与同行工程师一道帮助解决问题。

设计支持 *TI 参考设计支持* 可帮助您快速查找有帮助的 E2E 论坛、设计支持工具以及技术支持的联系信息。

13.5 商标

DCS-Control, E2E are trademarks of Texas Instruments.
WEBENCH is a registered trademark of Texas Instruments.
All other trademarks are the property of their respective owners.

13.6 静电放电警告



这些装置包含有限的内置 ESD 保护。存储或装卸时，应将导线一起截短或将装置放置于导电泡棉中，以防止 MOS 门极遭受静电损伤。

13.7 Glossary

SLYZ022 — *TI Glossary*.

This glossary lists and explains terms, acronyms, and definitions.

14 机械、封装和可订购信息

以下页面包含机械、封装和可订购信息。这些信息是指定器件的最新可用数据。数据如有变更，恕不另行通知和修订此文档。如欲获取此数据表的浏览器版本，请参阅左侧的导航。



PACKAGE OUTLINE

RGT0016C

VQFN - 1 mm max height

PLASTIC QUAD FLATPACK - NO LEAD

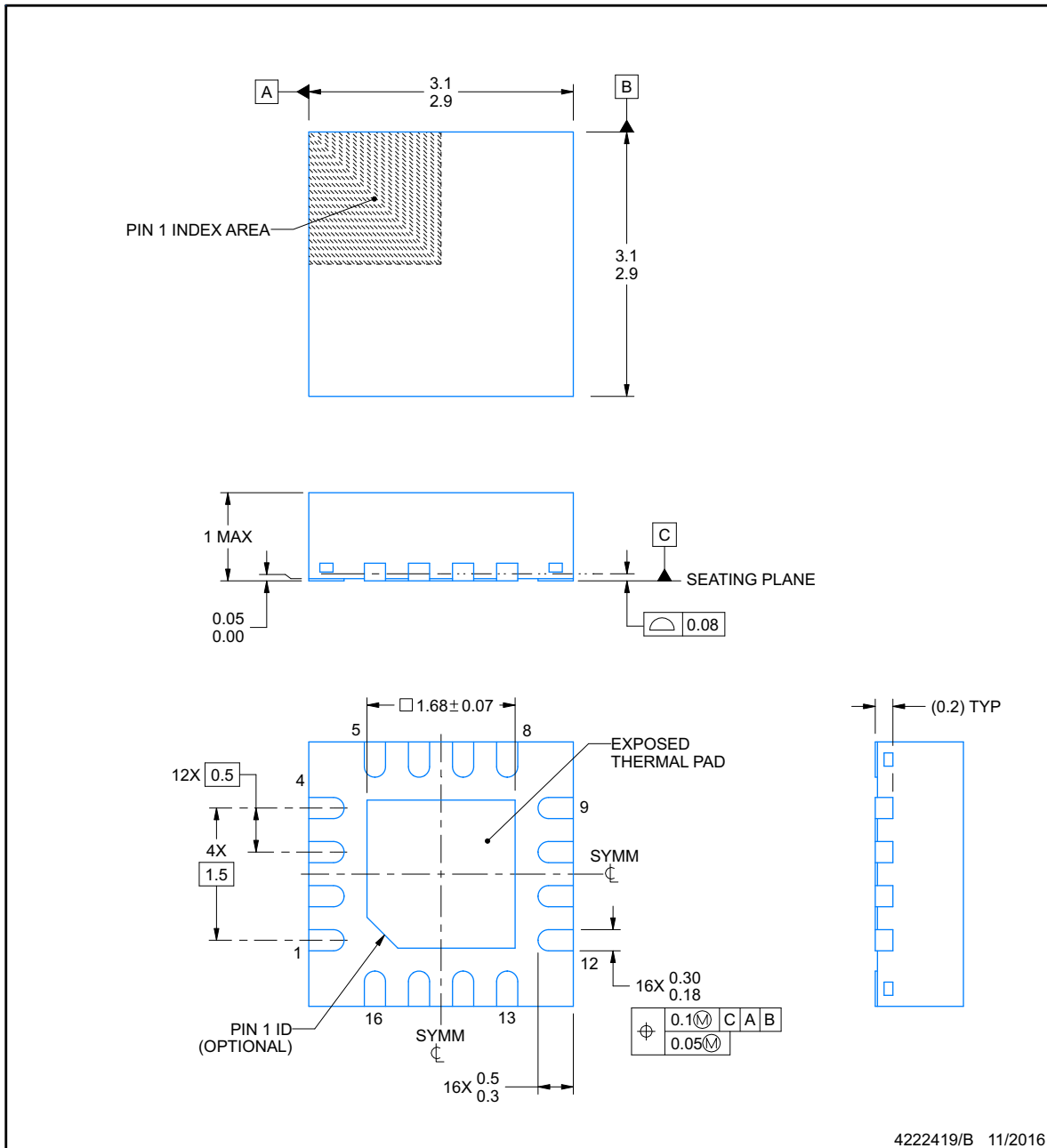

4222419/B 11/2016

NOTES:

1. All linear dimensions are in millimeters. Any dimensions in parenthesis are for reference only. Dimensioning and tolerancing per ASME Y14.5M.
2. This drawing is subject to change without notice.
3. The package thermal pad must be soldered to the printed circuit board for thermal and mechanical performance.

EXAMPLE BOARD LAYOUT

RGT0016C

VQFN - 1 mm max height

PLASTIC QUAD FLATPACK - NO LEAD

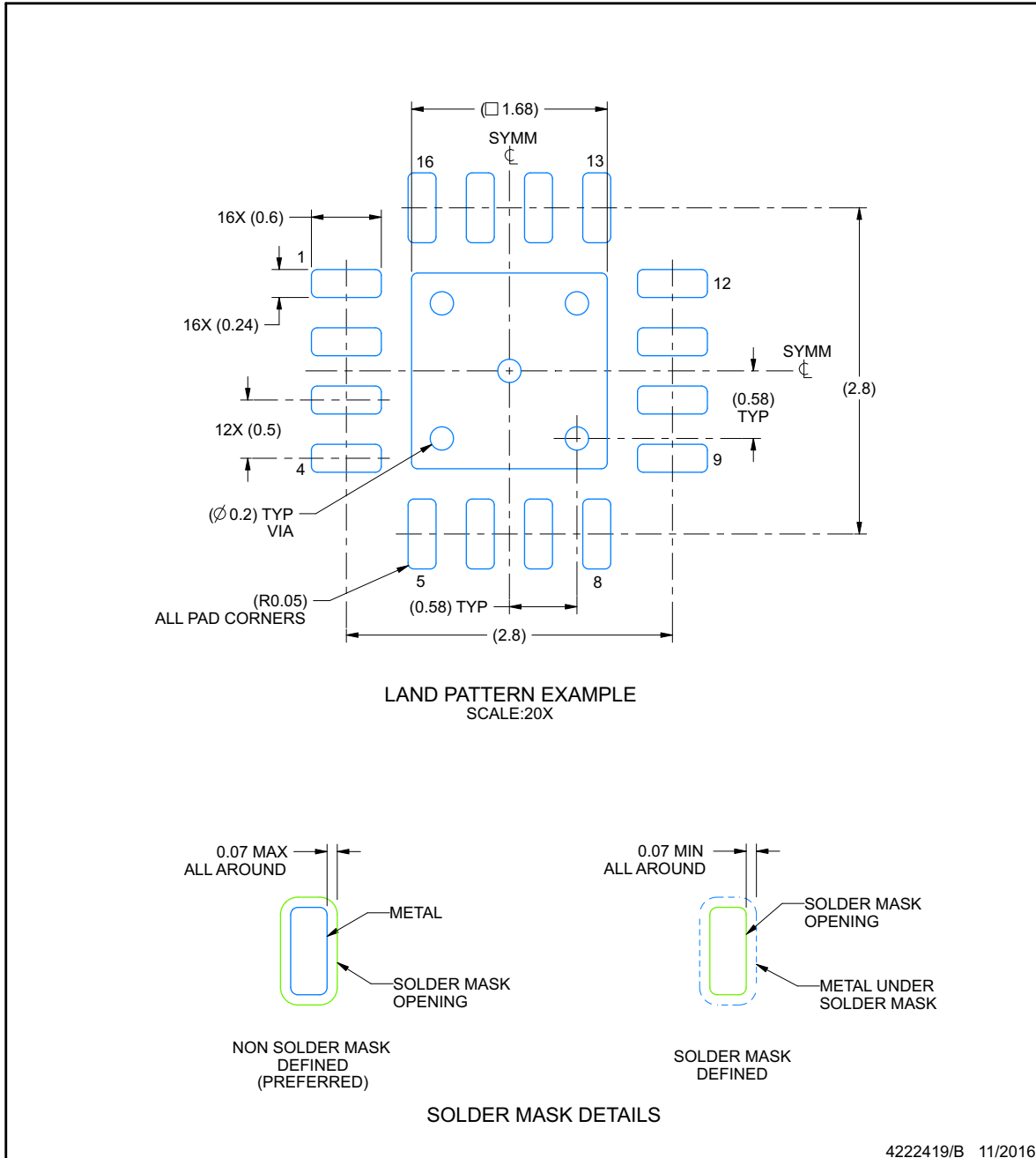

NOTES: (continued)

4. This package is designed to be soldered to a thermal pad on the board. For more information, see Texas Instruments literature number SLUA271 (www.ti.com/lit/slua271).
5. Vias are optional depending on application, refer to device data sheet. If any vias are implemented, refer to their locations shown on this view. It is recommended that vias under paste be filled, plugged or tented.

EXAMPLE STENCIL DESIGN

RGT0016C

VQFN - 1 mm max height

PLASTIC QUAD FLATPACK - NO LEAD

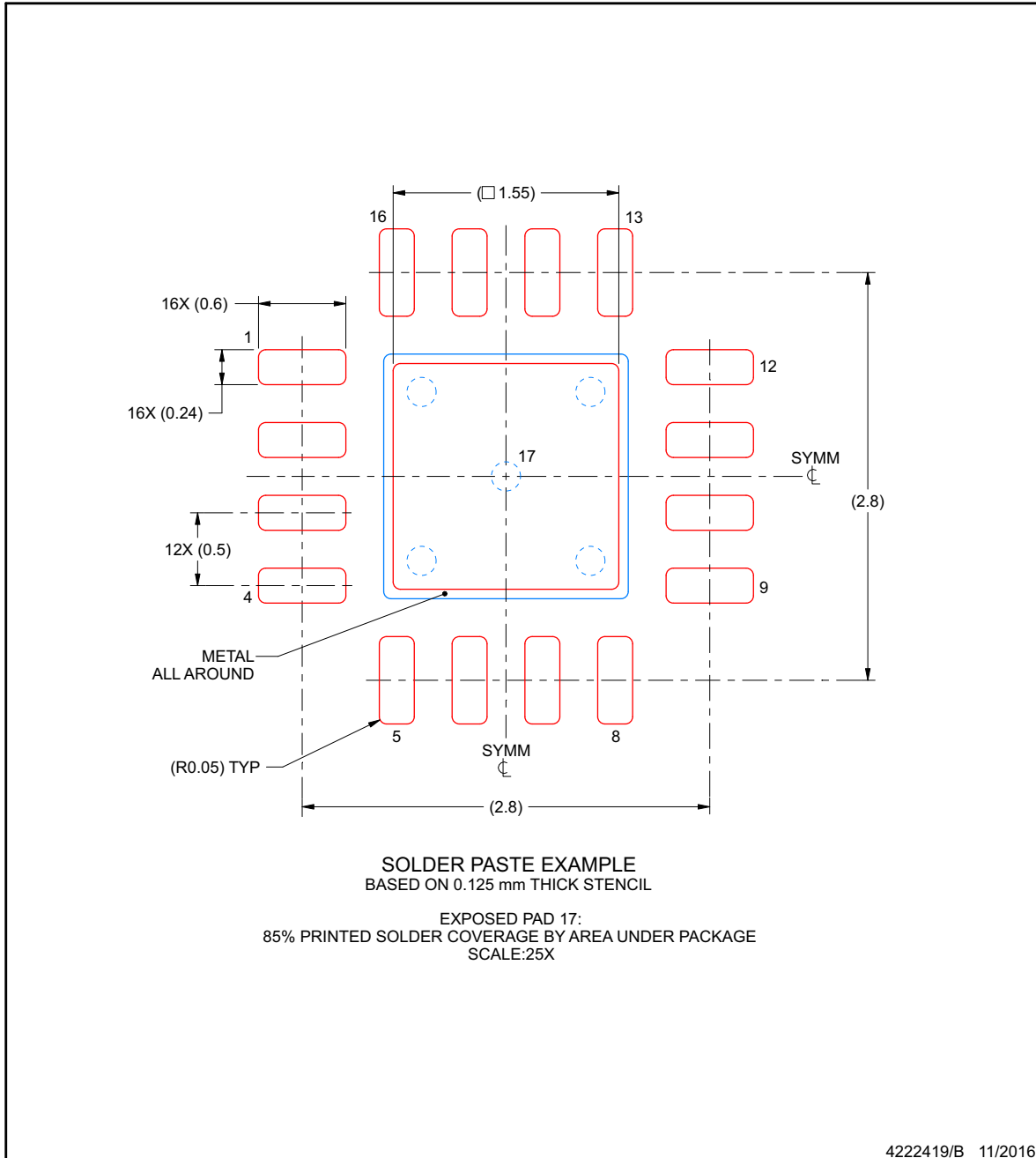

NOTES: (continued)

6. Laser cutting apertures with trapezoidal walls and rounded corners may offer better paste release. IPC-7525 may have alternate design recommendations.

PACKAGING INFORMATION

Orderable Device	Status (1)	Package Type	Package Drawing	Pins	Package Qty	Eco Plan (2)	Lead finish/ Ball material (6)	MSL Peak Temp (3)	Op Temp (°C)	Device Marking (4/5)	Samples
TPS6213013AQRGTRQ1	ACTIVE	VQFN	RGT	16	3000	RoHS & Green	NIPDAU	Level-2-260C-1 YEAR	-40 to 125	13013Q	Samples
TPS6213013AQRGTTQ1	ACTIVE	VQFN	RGT	16	250	RoHS & Green	NIPDAU	Level-2-260C-1 YEAR	-40 to 125	13013Q	Samples
TPS62130AQRGTRQ1	ACTIVE	VQFN	RGT	16	3000	RoHS & Green	NIPDAU	Level-2-260C-1 YEAR	-40 to 125	PA6IQ	Samples
TPS62130AQRGTTQ1	ACTIVE	VQFN	RGT	16	250	RoHS & Green	NIPDAU	Level-2-260C-1 YEAR	-40 to 125	PA6IQ	Samples
TPS62133AQRGTRQ1	ACTIVE	VQFN	RGT	16	3000	RoHS & Green	NIPDAU	Level-2-260C-1 YEAR	-40 to 125	PA6JQ	Samples
TPS62133AQRGTTQ1	ACTIVE	VQFN	RGT	16	250	RoHS & Green	NIPDAU	Level-2-260C-1 YEAR	-40 to 125	PA6JQ	Samples

(1) The marketing status values are defined as follows:

ACTIVE: Product device recommended for new designs.

LIFEBUY: TI has announced that the device will be discontinued, and a lifetime-buy period is in effect.

NRND: Not recommended for new designs. Device is in production to support existing customers, but TI does not recommend using this part in a new design.

PREVIEW: Device has been announced but is not in production. Samples may or may not be available.

OBSOLETE: TI has discontinued the production of the device.

(2) **RoHS:** TI defines "RoHS" to mean semiconductor products that are compliant with the current EU RoHS requirements for all 10 RoHS substances, including the requirement that RoHS substance do not exceed 0.1% by weight in homogeneous materials. Where designed to be soldered at high temperatures, "RoHS" products are suitable for use in specified lead-free processes. TI may reference these types of products as "Pb-Free".

RoHS Exempt: TI defines "RoHS Exempt" to mean products that contain lead but are compliant with EU RoHS pursuant to a specific EU RoHS exemption.

Green: TI defines "Green" to mean the content of Chlorine (Cl) and Bromine (Br) based flame retardants meet JS709B low halogen requirements of <=1000ppm threshold. Antimony trioxide based flame retardants must also meet the <=1000ppm threshold requirement.

(3) MSL, Peak Temp. - The Moisture Sensitivity Level rating according to the JEDEC industry standard classifications, and peak solder temperature.

(4) There may be additional marking, which relates to the logo, the lot trace code information, or the environmental category on the device.

(5) Multiple Device Markings will be inside parentheses. Only one Device Marking contained in parentheses and separated by a "~" will appear on a device. If a line is indented then it is a continuation of the previous line and the two combined represent the entire Device Marking for that device.

(6) Lead finish/Ball material - Orderable Devices may have multiple material finish options. Finish options are separated by a vertical ruled line. Lead finish/Ball material values may wrap to two lines if the finish value exceeds the maximum column width.

Important Information and Disclaimer: The information provided on this page represents TI's knowledge and belief as of the date that it is provided. TI bases its knowledge and belief on information provided by third parties, and makes no representation or warranty as to the accuracy of such information. Efforts are underway to better integrate information from third parties. TI has taken and continues to take reasonable steps to provide representative and accurate information but may not have conducted destructive testing or chemical analysis on incoming materials and chemicals. TI and TI suppliers consider certain information to be proprietary, and thus CAS numbers and other limited information may not be available for release.

In no event shall TI's liability arising out of such information exceed the total purchase price of the TI part(s) at issue in this document sold by TI to Customer on an annual basis.

TAPE AND REEL INFORMATION

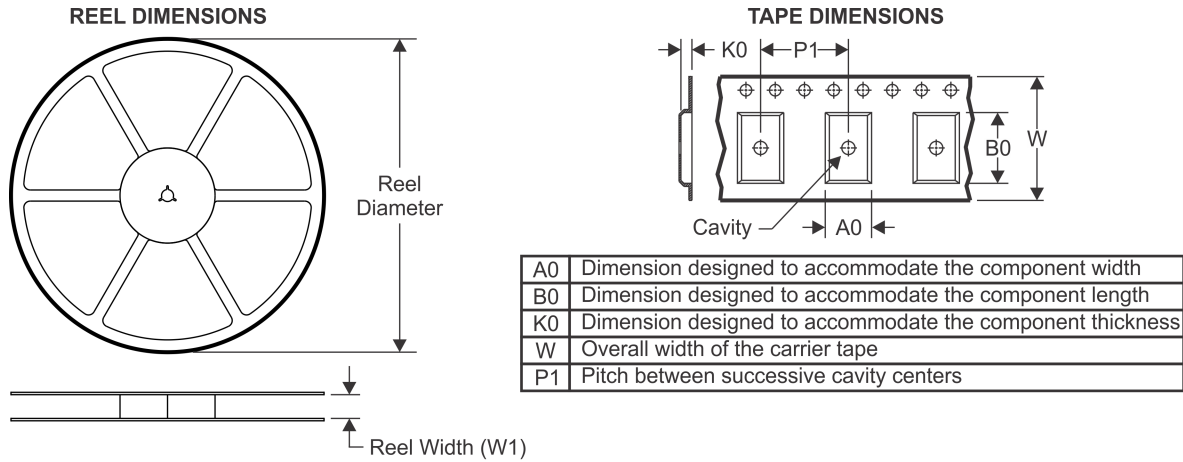

QUADRANT ASSIGNMENTS FOR PIN 1 ORIENTATION IN TAPE



*All dimensions are nominal

Device	Package Type	Package Drawing	Pins	SPQ	Reel Diameter (mm)	Reel Width W1 (mm)	A0 (mm)	B0 (mm)	K0 (mm)	P1 (mm)	W (mm)	Pin1 Quadrant
TPS6213013AQRGTRQ1	VQFN	RGT	16	3000	330.0	12.4	3.3	3.3	1.1	8.0	12.0	Q2
TPS6213013AQRGTTQ1	VQFN	RGT	16	250	180.0	12.4	3.3	3.3	1.1	8.0	12.0	Q2
TPS62130AQRGTRQ1	VQFN	RGT	16	3000	330.0	12.4	3.3	3.3	1.1	8.0	12.0	Q2
TPS62130AQRGTTQ1	VQFN	RGT	16	250	180.0	12.4	3.3	3.3	1.1	8.0	12.0	Q2
TPS62133AQRGTRQ1	VQFN	RGT	16	3000	330.0	12.4	3.3	3.3	1.1	8.0	12.0	Q2
TPS62133AQRGTTQ1	VQFN	RGT	16	250	180.0	12.4	3.3	3.3	1.1	8.0	12.0	Q2

TAPE AND REEL BOX DIMENSIONS

*All dimensions are nominal

Device	Package Type	Package Drawing	Pins	SPQ	Length (mm)	Width (mm)	Height (mm)
TPS6213013AQRGTRQ1	VQFN	RGT	16	3000	552.0	367.0	36.0
TPS6213013AQRGTTQ1	VQFN	RGT	16	250	552.0	185.0	36.0
TPS62130AQRGTRQ1	VQFN	RGT	16	3000	552.0	367.0	36.0
TPS62130AQRGTTQ1	VQFN	RGT	16	250	552.0	185.0	36.0
TPS62133AQRGTRQ1	VQFN	RGT	16	3000	552.0	367.0	36.0
TPS62133AQRGTTQ1	VQFN	RGT	16	250	552.0	185.0	36.0

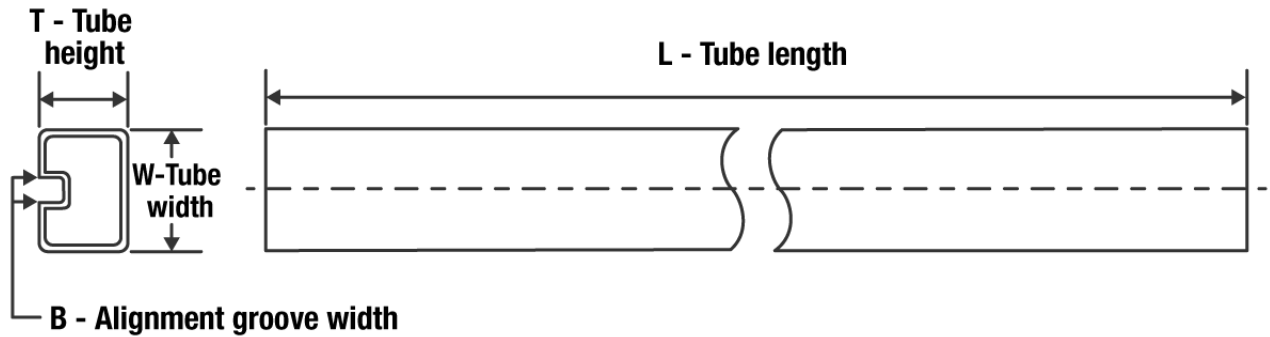
TUBE

*All dimensions are nominal

Device	Package Name	Package Type	Pins	SPQ	L (mm)	W (mm)	T (μm)	B (mm)
TPS6213013AQRGTRQ1	RGT	VQFN	16	3000	381	4.83	2286	0
TPS6213013AQRGTTQ1	RGT	VQFN	16	250	381	4.83	2286	0
TPS62130AQRGTRQ1	RGT	VQFN	16	3000	381	4.83	2286	0
TPS62130AQRGTTQ1	RGT	VQFN	16	250	381	4.83	2286	0
TPS62133AQRGTRQ1	RGT	VQFN	16	3000	381	4.83	2286	0
TPS62133AQRGTTQ1	RGT	VQFN	16	250	381	4.83	2286	0

重要声明和免责声明

TI“按原样”提供技术和可靠性数据（包括数据表）、设计资源（包括参考设计）、应用或其他设计建议、网络工具、安全信息和其他资源，不保证没有瑕疵且不做任何明示或暗示的担保，包括但不限于对适销性、某特定用途方面的适用性或不侵犯任何第三方知识产权的暗示担保。

这些资源可供使用 TI 产品进行设计的熟练开发人员使用。您将自行承担以下全部责任：(1) 针对您的应用选择合适的 TI 产品，(2) 设计、验证并测试您的应用，(3) 确保您的应用满足相应标准以及任何其他功能安全、信息安全、监管或其他要求。

这些资源如有变更，恕不另行通知。TI 授权您仅可将这些资源用于研发本资源所述的 TI 产品的应用。严禁对这些资源进行其他复制或展示。您无权使用任何其他 TI 知识产权或任何第三方知识产权。您应全额赔偿因在这些资源的使用中对 TI 及其代表造成的任何索赔、损害、成本、损失和债务，TI 对此概不负责。

TI 提供的产品受 [TI 的销售条款](#) 或 [ti.com](#) 上其他适用条款/TI 产品随附的其他适用条款的约束。TI 提供这些资源并不会扩展或以其他方式更改 TI 针对 TI 产品发布的适用的担保或担保免责声明。

TI 反对并拒绝您可能提出的任何其他或不同的条款。

邮寄地址：Texas Instruments, Post Office Box 655303, Dallas, Texas 75265

Copyright © 2022，德州仪器 (TI) 公司