

TPS65251-x 具有集成 FET 的 4.5V 至 18V 输入、高电流、三路同步降压开关

1 特性

- 宽输入电源电压范围 (4.5V 至 18V)
- 输出范围 : 0.8V 至 $V_{IN} - 1V$
- 持续负载电流 : 3A (降压开关 1) , 2A (降压开关 2 和 3)
- 最大电流 : 3.5A (降压开关 1) , 2.5A (降压开关 2 和 3)
- 可调开关频率为 300kHz 至 2.2MHz (由外部电阻设置)
- 针对每个降压通道的专用使能引脚
- 用于振荡器的外部同步引脚
- 通过外部电阻器设置的可调电流限制
- 软启动引脚
- 具有简单补偿电路的电流模式控制
- 电源正常状态指示
- 自动 PFM/PWM 操作
- VQFN 封装, 40 引脚 6mm × 6mm RHA

2 应用

- 机顶盒
- 蓝光™ DVD
- DVR
- 数字电视 (DTV)
- 汽车音频/视频
- 安防摄像机

3 说明

TPS65251-x 特有 3 个宽输入范围的同步高效率降压转换器。这款转换器设计用于简化其应用, 同时使得设计人员能够根据目标应用来优化他们的用法。

这款转换器可在 5V、9V、12V 或 15V 系统下工作, 并且集成有功率晶体管。可使用外部电阻分压器将输出

电压设置为 0.8V 与输入电源电压值之间的任意值。每个转换器特有有以下引脚: 使能引脚, 可针对排序用途而延迟启动; 软启动引脚, 可通过选择软启动电容来调节软启动时间; 电流限制 (RLIMx) 引脚, 使设计人员能够通过选择外部电阻来调节电流限制并优化电感的选择。这款转换器具有电流模式控制, 可简化 RC 补偿。

转换器的开关频率可根据需要选择通过 ROSC 引脚所连接的外部电阻来设置, 或者与 SYNC 引脚所连接的外部时钟同步。开关稳压器被设计成在 300kHz 至 2.2MHz 的频率范围内运行。降压开关 1 与降压开关 2 和 3 之间 180° 异相运行 (降压开关 2 与 3 同相运行), 最大限度地降低了对输入滤波器的要求。

TPS65251-x 特有监控电路, 用于监视每个转换器输出。完成排序后会将 PGOOD 引脚置为有效, 并报告所有 PG 信号, 期间耗时为一段可选的复位结束时间。PGOOD 信号的极性为高电平有效。

所有转换器均特有一个自动低功耗脉冲 PFM 跳跃模式, 此模式提升了轻负载和待机运行期间的效率, 而与此同时又保证一个极低的输出纹波, 从而在低输出电压上实现一个低于 2% 的值。

器件信息

器件型号	封装 ⁽¹⁾	封装尺寸 (标称值)
TPS65251-1	VQFN (40)	6.00mm × 6.00mm
TPS65251-2		
TPS65251-3		

(1) 如需了解所有可用封装, 请参阅数据表末尾的可订购产品附录。

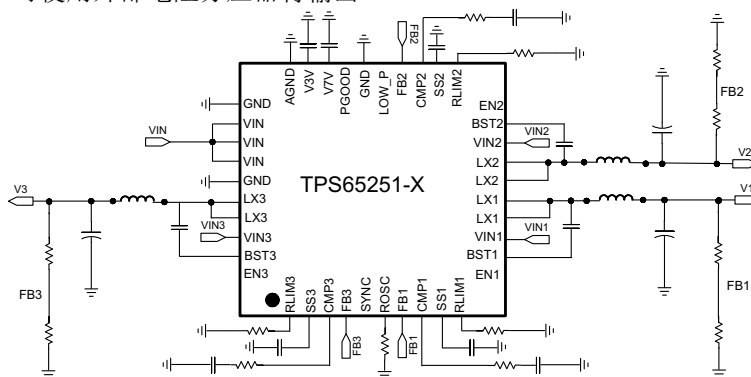

Table of Contents

1 特性	1	7.3 Feature Description.....	12
2 应用	1	7.4 Device Functional Modes.....	15
3 说明	1	8 Application and Implementation	16
4 Revision History	2	8.1 Application Information.....	16
5 Pin Configuration and Functions	3	8.2 Typical Application.....	16
6 Specifications	5	9 Power Supply Recommendations	29
6.1 Absolute Maximum Ratings.....	5	10 Layout	30
6.2 ESD Ratings.....	5	10.1 Layout Guidelines.....	30
6.3 Recommended Operating Conditions.....	5	10.2 Layout Example.....	31
6.4 Thermal Information.....	5	11 Device and Documentation Support	32
6.5 Electrical Characteristics.....	6	11.1 接收文档更新通知.....	32
6.6 Typical Characteristics for Buck 1.....	8	11.2 支持资源.....	32
6.7 Typical Characteristics for Buck 2.....	9	11.3 Trademarks.....	32
6.8 Typical Characteristics for Buck 3.....	10	11.4 Electrostatic Discharge Caution.....	32
7 Detailed Description	11	11.5 术语表.....	32
7.1 Overview.....	11	12 Mechanical, Packaging, and Orderable Information	32
7.2 Functional Block Diagram.....	11		

4 Revision History

Changes from Revision A (January 2015) to Revision B (January 2022)	Page
• 更新了整个文档中的表格、图和交叉参考的编号格式。.....	1
• Change VIN1, VIN2, VIN3, LX1, LX2, and LX3 maximum rating voltage from 18 V to 20 V.....	5
• Change LX1, LX2, and LX3 minimum rating voltage from - 1 V to - 3 V.....	5

Changes from Revision * (January 2015) to Revision A (January 2015)	Page
• 已将器件状态更新为量产数据.....	1

5 Pin Configuration and Functions



表 5-1. Pin Functions

PIN		I/O	DESCRIPTION
NAME	NO.		
RLIM3	1	I	Current limit setting for Buck 3. Fit a resistor from this pin to ground to set the peak current limit on the output inductor.
SS3	2	I	Soft-start pin for Buck 3. Fit a small ceramic capacitor to this pin to set the converter soft-start time.
COMP3	3	O	Compensation for Buck 3. Fit a series RC circuit to this pin to complete the compensation circuit of this converter.
FB3	4	I	Feedback input for Buck 3. Connect a divider set to 0.8 V from the output of the converter to ground.
SYNC	5	I	Synchronous clock input. If there is a sync clock in the system, connect to the pin. When not used, connect to GND.
ROSC	6	I	Oscillator set. This resistor sets the frequency of the internal autonomous clock. If external synchronization is used, the resistor should be fitted and set to about 70% of external clock frequency.
FB1	7	I	Feedback pin for Buck 1. Connect a divider set to 0.8 V from the output of the converter to ground.
COMP1	8	O	Compensation pin for Buck 1. Fit a series RC circuit to this pin to complete the compensation circuit of this converter.
SS1	9	I	Soft-start pin for Buck 1. Fit a small ceramic capacitor to this pin to set the converter soft-start time.
RLIM1	10	I	Current limit setting pin for Buck 1. Fit a resistor from this pin to ground to set the peak current limit on the output inductor.
EN1	11	I	Enable pin for Buck 1. A low-level signal on this pin disables it. If pin is left open, a weak internal pull-up to V3V allows for automatic enable. For a delayed start-up, add a small ceramic capacitor from this pin to ground.
BST1	12	I	Bootstrap capacitor for Buck 1. Fit a 47-nF ceramic capacitor from this pin to the switching node.
VIN1	13	I	Input supply for Buck 1. Fit a 10- μ F ceramic capacitor close to this pin.
LX1	14	O	Switching node for Buck 1
	15		
LX2	16	O	Switching node for Buck 2
	17		
VIN2	18	I	Input supply for Buck 2. Fit a 10- μ F ceramic capacitor close to this pin.
BST2	19	I	Bootstrap capacitor for Buck 2. Fit a 47-nF ceramic capacitor from this pin to the switching node.

表 5-1. Pin Functions (continued)

PIN		I/O	DESCRIPTION
NAME	NO.		
EN2	20	I	Enable pin for Buck 2. A low-level signal on this pin disables it. If pin is left open, a weak internal pull-up to V3V allows for automatic enable. For a delayed start-up, add a small ceramic capacitor from this pin to ground.
RLIM2	21	I	Current limit setting for Buck 2. Fit a resistor from this pin to ground to set the peak current limit on the output inductor.
SS2	22	I	Soft-start pin for Buck 2. Fit a small ceramic capacitor to this pin to set the converter soft-start time.
COMP2	23	O	Compensation pin for Buck 2. Fit a series RC circuit to this pin to complete the compensation circuit of this converter.
FB2	24	I	Feedback input for Buck 2. Connect a divider set to 0.8 V from the output of the converter to ground.
LOW_P	25	I	Low-power operation mode (active-high) input for TPS65251
GND	26		Ground pin
PGOOD	27	O	Power good. Open-drain output asserted after all converters are sequenced and within regulation. Polarity is factory selectable (active-high default).
V7V	28	O	Internal supply. Connect a 10- μ F ceramic capacitor from this pin to ground.
V3V	29	O	Internal supply. Connect a 3.3- to 10- μ F ceramic capacitor from this pin to ground.
AGND	30		Analog ground. Connect all GND pins and the power pad together.
GND	31		Ground pin
VIN	32	I	Input supply
	33		
	34		
GND	35		Ground pin
LX3	36	O	Switching node for Buck 3
	37		
VIN3	38		Input supply for Buck 3. Fit a 10- μ F ceramic capacitor close to this pin.
BST3	39	I	Bootstrap capacitor for Buck 3. Fit a 47-nF ceramic capacitor from this pin to the switching node.
EN3	40	I	Enable pin for Buck 3. A low-level signal on this pin disables it. If pin is left open, a weak internal pull-up to V3V allows for automatic enable. For a delayed start-up, add a small ceramic capacitor from this pin to ground.
PAD	—	—	Power pad. Connect to ground.

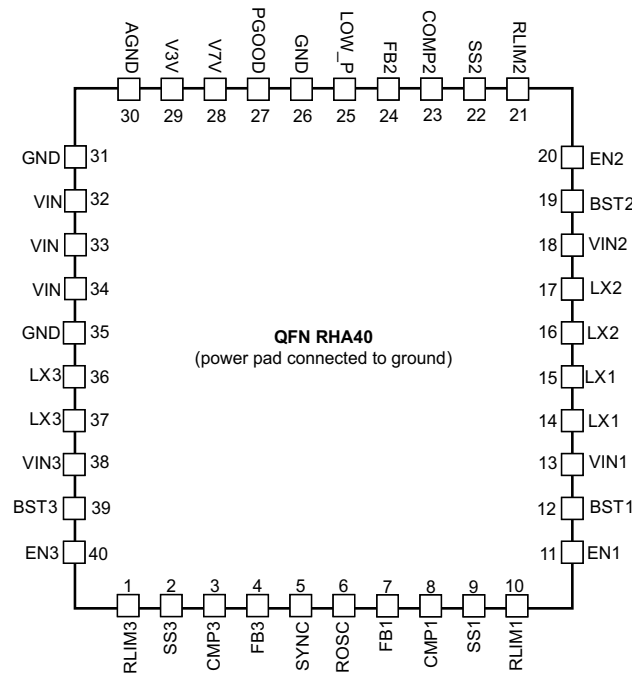
6 Specifications

6.1 Absolute Maximum Ratings

over operating free-air temperature range (unless otherwise noted)⁽¹⁾

		MIN	MAX	UNIT
Voltage	VIN1, VIN2, VIN3, LX1, LX2, LX3	- 0.3	20	V
	LX1, LX2, LX3 (maximum withstand voltage transient <10 ns)	- 3	23	V
	BST1, BST2, BST3, referenced to Lx pin	- 0.3	7	V
	V7V	- 0.3	7	V
	V3V, RLIM1, RLIM2, RLIM3, EN1, EN2, EN3, SS1, SS2, SS3, FB1, FB2, FB3, PGOOD, SYNC, ROSC, RST_IN, LOW_P, COMP1, COMP2, COMP3	- 0.3	3.6	V
	AGND, GND	- 0.3	0.3	V
T _J	Operating virtual junction temperature	- 40	125	°C
T _{stg}	Storage temperature	- 55	150	°C

(1) Stresses beyond those listed under "absolute maximum ratings" may cause permanent damage to the device. These are stress ratings only, and functional operation of the device at these or any other conditions beyond those indicated under "recommended operating conditions" is not implied. Exposure to absolute - maximum - rated conditions for extended periods may affect device reliability.

6.2 ESD Ratings

			VALUE	UNIT
V _(ESD)	Electrostatic discharge	Human body model (HBM), per ANSI/ESDA/JEDEC JS-001, all pins ⁽¹⁾	±2000	V
		Charged device model (CDM), per JEDEC specification JESD22-C101, all pins ⁽²⁾	±500	

(1) JEDEC document JEP155 states that 500-V HBM allows safe manufacturing with a standard ESD control process.

(2) JEDEC document JEP157 states that 250-V CDM allows safe manufacturing with a standard ESD control process.

6.3 Recommended Operating Conditions

over operating free-air temperature range (unless otherwise noted)

		MIN	NOM	MAX	UNIT
V _{IN}	Input operating voltage	4.5		18	V
T _J	Junction temperature	- 40		125	°C

6.4 Thermal Information

THERMAL METRIC ⁽¹⁾		TPS65251-x	UNIT
		RHA	
		40 PINS	
R _{θJA}	Junction-to-ambient thermal resistance	32.7	°C/W
R _{θJC(top)}	Junction-to-case (top) thermal resistance	21.4	
R _{θJB}	Junction-to-board thermal resistance	8.3	
ψ _{JT}	Junction-to-top characterization parameter	0.2	
ψ _{JB}	Junction-to-board characterization parameter	N/A	
R _{θJC(bot)}	Junction-to-case (bottom) thermal resistance	2	

(1) For more information about traditional and new thermal metrics, see the *IC Package Thermal Metrics* application report, [SPRA953](#).

6.5 Electrical Characteristics

 $T_J = -40^{\circ}\text{C to } 125^{\circ}\text{C}$, $V_{IN} = 12\text{ V}$, $f_{SW} = 500\text{ Hz}$ (unless otherwise noted)

PARAMETER		TEST CONDITIONS	MIN	TYP	MAX	UNIT
INPUT SUPPLY UVLO AND INTERNAL SUPPLY VOLTAGE						
V_{IN}	Input voltage range		4.5		18	V
I_{DDSDN}	Shutdown	EN pin = Low for all converters		175		μA
I_{DDQ}	Quiescent, low power disabled (Lo)	Converters enabled, no load Buck 1 = 3.3 V, Buck 2 = 2.5 V, Buck 3 = 7.5 V, $L = 4.7\ \mu\text{H}$, $f_{SW} = 800\text{ kHz}$		20		mA
$I_{DDQ_LOW_P}$	Quiescent, low power enabled (Hi)	Converters enabled, no load Buck 1 = 3.3 V, Buck 2 = 2.5 V, Buck 3 = 7.5 V, $L = 4.7\ \mu\text{H}$, $f_{SW} = 800\text{ kHz}$		1		mA
$UVLO_{VIN}$	V_{IN} undervoltage lockout	Rising V_{IN}		4.22		V
		Falling V_{IN}		4.1		
$UVLO_{DEGLITCH}$		Both edges		110		μs
V_{3p3}	Internal biasing supply			3.3		V
V_{7V}	Internal biasing supply			6.25		V
V_{7V_UVLO}	UVLO for internal V7V rail	Rising V7V		3.8		V
		Falling V7V		3.6		
$V_{7V_UVLO_DEGLITCH}$		Falling edge		110		μs
BUCK CONVERTERS (ENABLE CIRCUIT, CURRENT LIMIT, SOFT START, SWITCHING FREQUENCY AND SYNC CIRCUIT, LOW POWER MODE)						
V_{IH}	Enable threshold high	External GPIO mode, $V_{3p3} = 3.2\text{ to } 3.4\text{ V}$	$0.66 \times V_{3p3}$			V
	Enable high level	$V_{3p3} = 3.2\text{ to } 3.4\text{ V}$, V_{ENX} rising	1.55	1.67	1.82	
V_{IL}	Enable threshold low	External GPIO mode, $V_{3p3} = 3.2\text{ to } 3.4\text{ V}$	$0.33 \times V_{3p3}$			V
	Enable low level	$V_{3p3} = 3.2\text{ to } 3.4\text{ V}$, V_{ENX} falling	0.98	1.10	1.24	
R_{EN_DIS}	Enable discharge resistor		- 25%	2.1	25%	$\text{k}\Omega$
I_{CH_EN}	Pullup current enable pin			1.1		μA
t_D	Discharge time enable pins	Power-up		10		ms
I_{SS}	Soft-start pin current source			5		μA
F_{SW_BK}	Converter switching frequency range	Set externally with resistor	0.3		2.2	MHz
R_{FSW}	Frequency setting resistor	Depending on set frequency	50		600	$\text{k}\Omega$
f_{SW_TOL}	Internal oscillator accuracy	$f_{SW} = 800\text{ kHz}$	- 10%		10%	
V_{SYNCH}	External clock threshold high	$V_{3p3} = 3.3\text{ V}$			1.24	V
V_{SYNCL}	External clock threshold low	$V_{3p3} = 3.3\text{ V}$	1.55			V
$SYNC_{RANGE}$	Synchronization range		0.2		2.2	MHz
$SYNC_{CLK_MIN}$	Sync signal minimum duty cycle		40%			
$SYNC_{CLK_MAX}$	Sync signal maximum duty cycle				60%	
$V_{H_LOW_P}$	Low power mode threshold high	$V_{3p3} = 3.3\text{ V}$, V_{ENX} rising	1.55			V
$V_{L_LOW_P}$	Low power mode threshold Low	$V_{3p3} = 3.3\text{ V}$, V_{ENX} falling			1.24	V

$T_J = -40^{\circ}\text{C}$ to 125°C , $V_{IN} = 12\text{ V}$, $f_{SW} = 500\text{ Hz}$ (unless otherwise noted)

PARAMETER		TEST CONDITIONS	MIN	TYP	MAX	UNIT
FEEDBACK, REGULATION, OUTPUT STAGE						
V_{FB}	Feedback voltage	$V_{IN} = 12\text{ V}$, $T_J = 25^{\circ}\text{C}$	- 1%	0.8	1%	V
		$V_{IN} = 4.5$ to 18 V	- 2%	0.8	2%	
I_{FB}	Feedback leakage current				50	nA
t_{ON_MIN}	Minimum on-time (current sense blanking) to specify output regulation			70	100	ns
$RLIM_1$	Limit resistance range	$V_{IN} = 12\text{ V}$, $f_{SW} = 500\text{ kHz}$	75		300	k Ω
$RLIM_{2,3}$	Limit resistance range	$V_{IN} = 12\text{ V}$, $f_{SW} = 500\text{ kHz}$	1.1		5.1	A
$ILIM_1$	Buck1 current limit range	$V_{IN} = 12\text{ V}$, $f_{SW} = 500\text{ kHz}$	100		300	k Ω
$ILIM_2$	Buck2 current limit range	$V_{IN} = 12\text{ V}$, $f_{SW} = 500\text{ kHz}$	1.2		4.1	A
$ILIM_3$	Buck3 current limit range	$V_{IN} = 12\text{ V}$, $f_{SW} = 500\text{ kHz}$	1.2		4.1	A
MOSFET (BUCK 1)						
H.S. Switch	Turn-on resistance high-side FET on CH1	BOOT = 6.5 V, $T_J = 25^{\circ}\text{C}$		95		m Ω
L.S. Switch	Turn-on resistance low-side FET on CH1	$V_{IN} = 12\text{ V}$, $T_J = 25^{\circ}\text{C}$		50		m Ω
MOSFET (BUCK 2)						
H.S. Switch	Turn-on resistance high-side FET on CH2	BOOT = 6.5 V, $T_J = 25^{\circ}\text{C}$		120		m Ω
L.S. Switch	Turn-on resistance low-side FET on CH2	$V_{IN} = 12\text{ V}$, $T_J = 25^{\circ}\text{C}$		80		m Ω
MOSFET (BUCK 3)						
H.S. Switch	Turn-on resistance high-side FET on CH3	BOOT = 6.5 V, $T_J = 25^{\circ}\text{C}$		120		m Ω
L.S. Switch	Turn-on resistance low-side FET on CH3	$V_{IN} = 12\text{ V}$, $T_J = 25^{\circ}\text{C}$		80		m Ω
ERROR AMPLIFIER						
g_M	Error amplifier transconductance	- 2 $\mu\text{A} < I_{COMP} < 2\text{ }\mu\text{A}$		130		μmhos
g_{mPS}	COMP to ILX g_M	ILX = 0.5 A		10		A/V
POWER GOOD RESET GENERATOR						
V_{UV_BUCKX}	Threshold voltage for buck under voltage	Output falling		85%		
		Output rising (PG is asserted)		90%		
$t_{UV_deglitch}$	Deglintch time (both edges)	Each buck		11		ms
t_{ON_HICCUP}	Hiccup mode ON time	V_{UV_BUCKX} asserted		13		ms
t_{OFF_HICCUP}	Hiccup mode OFF time	All converters disabled. After t_{OFF_HICCUP} elapses, all converters go through sequencing again.		11		ms
VOV_BUCKX	Threshold voltage for buck over voltage	Output rising (high-side FET is forced off)		106%		
		Output falling (high-side FET is allowed to switch)		104%		
t_{RP}	Minimum reset period	TPS65251-1		1000		ms
		TPS65251-2		32		
		TPS65251-3		256		
THERMAL SHUTDOWN						
T_{TRIP}	Thermal shutdown trip point	Rising temperature		160		$^{\circ}\text{C}$
T_{HYST}	Thermal shutdown hysteresis	Device restarts		20		$^{\circ}\text{C}$
$t_{TRIP_DEGLITCH}$	Thermal shutdown deglitch		100		120	μs

6.6 Typical Characteristics for Buck 1

$T_A = 25^\circ\text{C}$, $V_{IN} = 12\text{ V}$, $V_O = 1.2\text{ V}$, $L = 4.7\ \mu\text{H}$, $C_O = 68\ \mu\text{F}$, $f_{SW} = 500\text{ Hz}$ (unless otherwise noted)

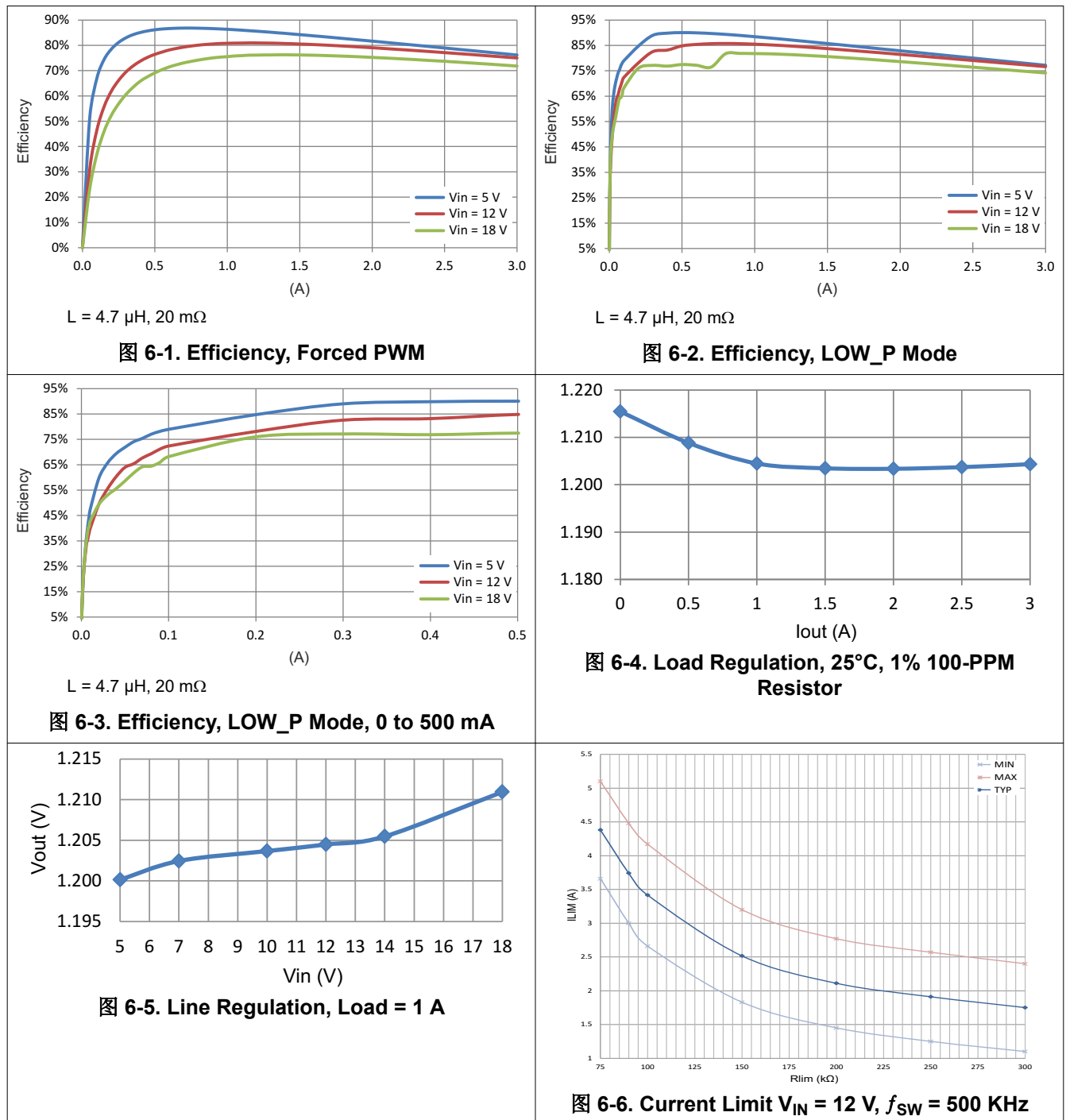

6.7 Typical Characteristics for Buck 2

$T_A = 25^\circ\text{C}$, $V_{IN} = 12\text{ V}$, $V_O = 1.8\text{ V}$, $L = 4.7\ \mu\text{H}$, $C_O = 68\ \mu\text{F}$, $f_{SW} = 500\text{ Hz}$ (unless otherwise noted)



图 6-7. Efficiency, Forced PWM



图 6-8. Efficiency, LOW_P Mode

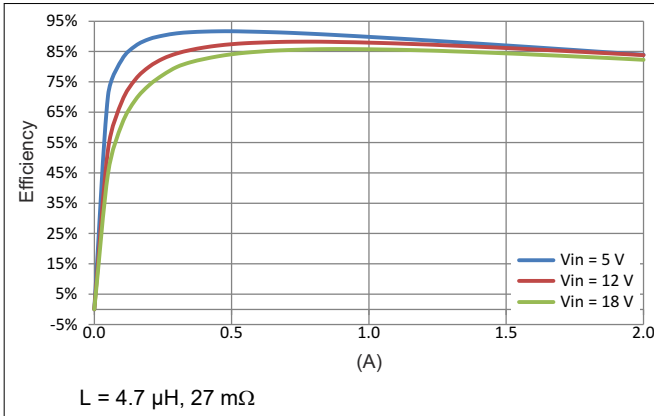

图 6-9. Efficiency, LOW_P Mode, 0 to 500 mA

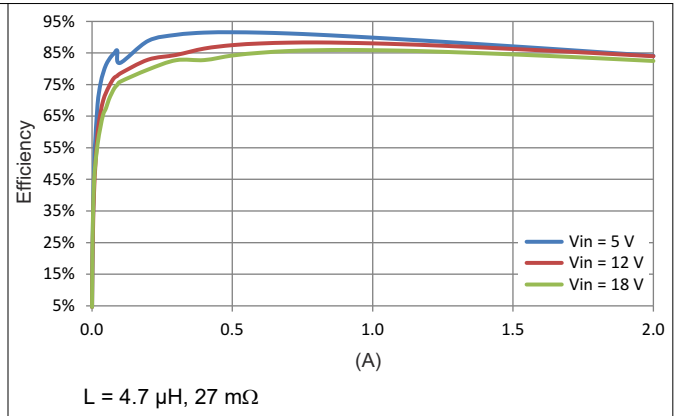

图 6-10. Load Regulation, 25°C , 1% 100-PPM Resistor

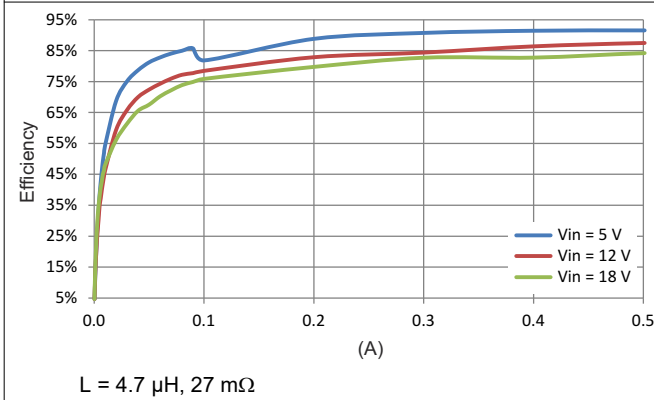

图 6-11. Line Regulation, Load = 1 A

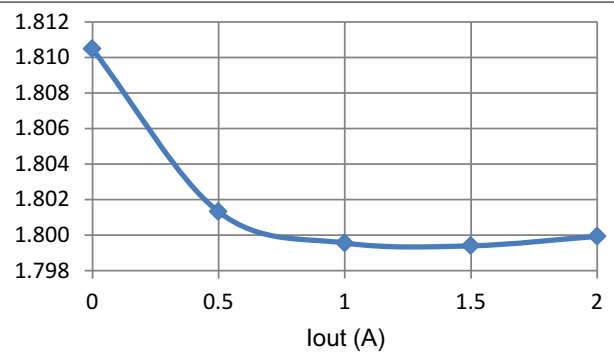

图 6-12. Current Limit $V_{IN} = 12\text{ V}$, $f_{SW} = 500\text{ kHz}$

6.8 Typical Characteristics for Buck 3

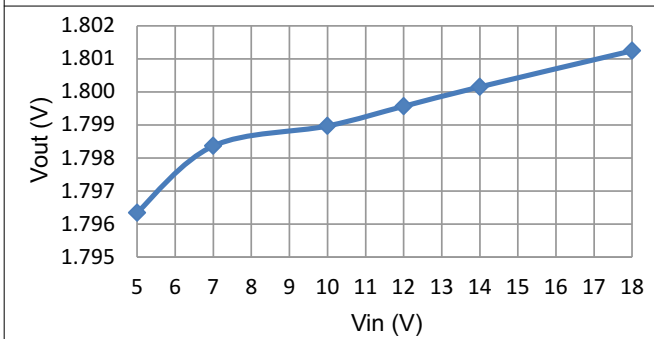
$T_A = 25^\circ\text{C}$, $V_{IN} = 12\text{ V}$, $V_O = 3.3\text{ V}$, $L = 4.7\ \mu\text{H}$, $C_O = 68\ \mu\text{F}$, $f_{SW} = 500\text{ Hz}$ (unless otherwise noted)

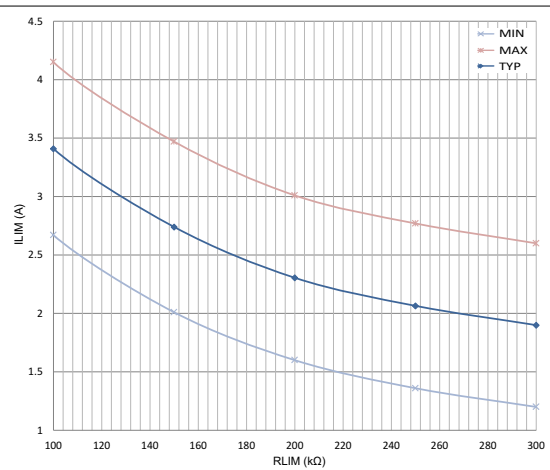
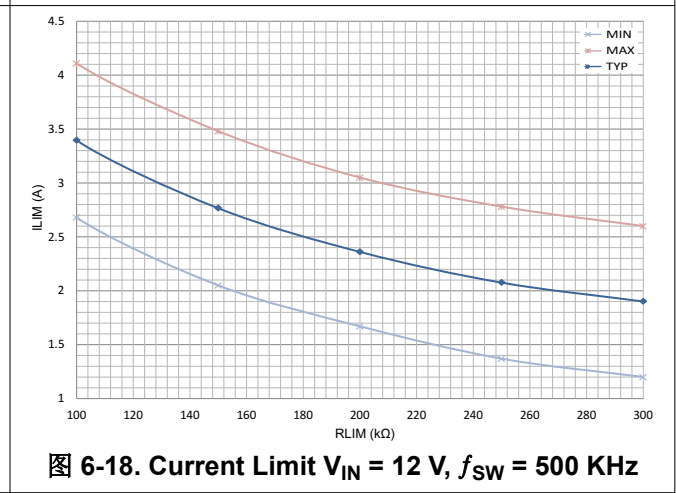
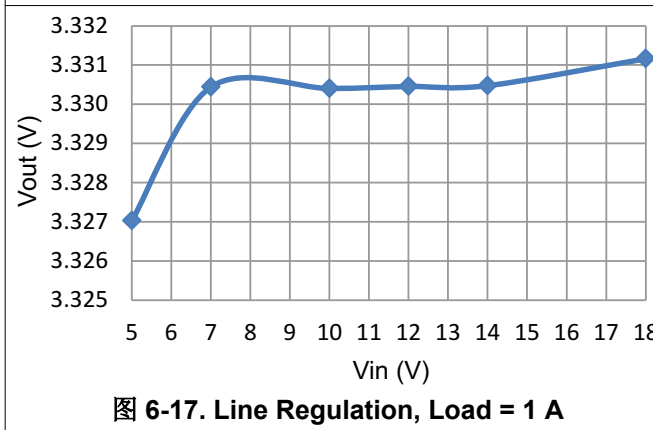
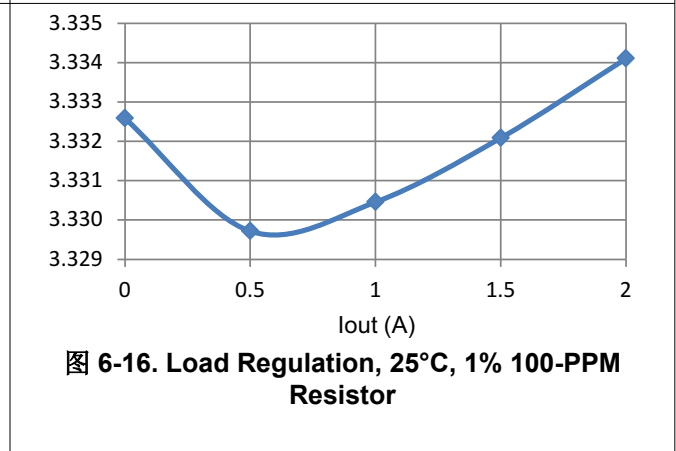
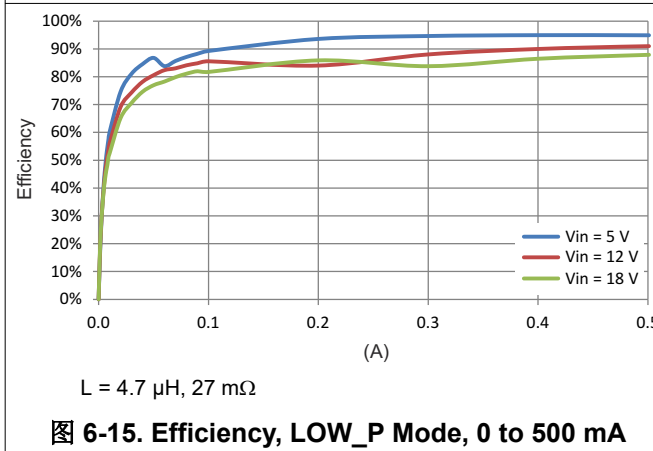
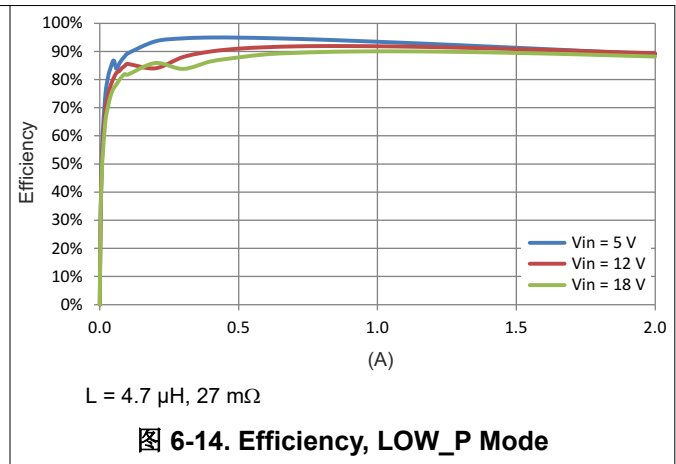
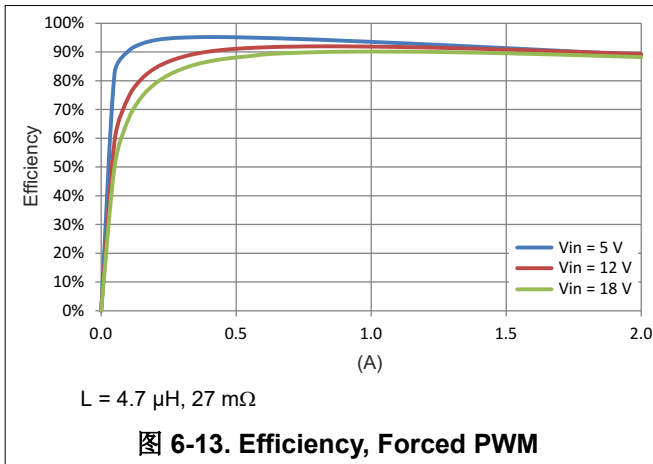

7 Detailed Description

7.1 Overview

TPS65251-x is a power management IC with three step-down buck converters. Both high-side and low-side MOSFETs are integrated to provide fully synchronous conversion with higher efficiency. TPS65251-x can support 4.5- to 18-V input supply, high load current, 300-kHz to 2.2-MHz clocking. The buck converters have an optional PSM mode, which can improve power dissipation during light loads. Alternatively, the device implements a constant frequency mode by connecting the LOW_P pin to ground. The wide switching frequency of 300 kHz to 2.2 MHz allows for efficiency and size optimization. The switching frequency is adjustable by selecting a resistor to ground on the ROSC pin. The SYNC pin also provides a means to synchronize the power converter to an external signal. Input ripple is reduced by 180° out-of-phase operation between Buck 1 and Buck 2. Buck 3 operates in phase with Buck 2.

All three buck converters have peak current mode control which simplifies external frequency compensation. A traditional type II compensation network can stabilize the system and achieve fast transient response. Moreover, an optional capacitor in parallel with the upper resistor of the feedback divider provides one more zero and makes the crossover frequency over 100 kHz.

Each buck converter has an individual current limit, which can be set up by a resistor to ground from the RLIM pin. The adjustable current limiting enables high-efficiency design with smaller and less expensive inductors.

The device has two built-in LDO regulators. During a standby mode, the 3.3-V LDO and the 6.5-V LDO can be used to drive MCU and other active loads. By this, the system is able to turn off the three buck converters and improve the standby efficiency.

The device has a power-good comparator monitoring the output voltage. Each converter has its own soft-start and enable pins, which provide independent control and programmable soft-start.

7.2 Functional Block Diagram

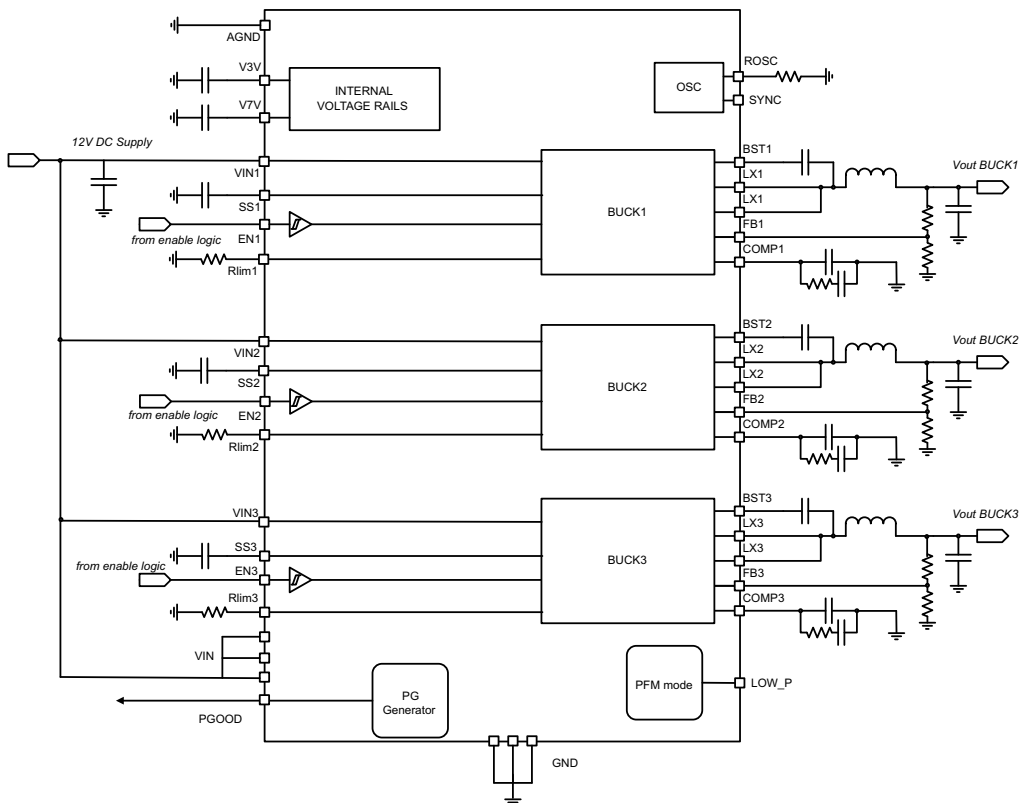

7.3 Feature Description

7.3.1 Adjustable Switching Frequency

To select the internal switching frequency, connect a resistor from RO_{SC} to ground. 图 7-1 shows the required resistance for a given switching frequency.



图 7-1. RO_{SC} vs Switching Frequency

$$R_{\text{OSC}} (\text{k}\Omega) = 174 \times f (\text{MHz})^{-1.122} \quad (1)$$

For operation at 800 kHz, a 230-kΩ resistor is required.

7.3.2 Synchronization

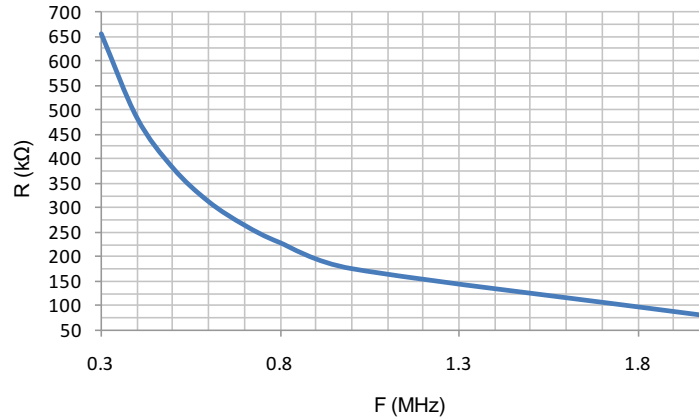
The status of the SYNC pin is ignored during start-up and the TPS65251's control only synchronizes to an external signal after the PGOOD signal is asserted. The status of the SYNC pin is ignored during start-up and the TPS65251 only synchronizes to an external clock if the PGOOD signal is asserted. When synchronization is applied, the PWM oscillator frequency must be lower than the sync pulse frequency to allow the external signal trumping the oscillator pulse reliably. When synchronization is not applied, the SYNC pin should be connected to ground.

7.3.3 Out-of-Phase Operation

Buck 1 has a low conduction resistance compared to Buck 2 and 3. Normally Buck 1 is used to drive higher system loads. Buck 2 and 3 are used to drive some peripheral loads like I/O and line drivers. The combination of Buck 2's and Buck 3's loads may be on par with Buck 1's load. To reduce input ripple current, Buck 2 operates in phase with Buck 3; Buck 1 and Buck 2 operate 180° out-of-phase. This enables the system, having less input ripple, to lower component cost, save board space, and reduce EMI.

7.3.4 Delayed Start-Up

If a delayed start-up is required on any of the buck converters, fit a ceramic capacitor to the EN_x pins. The delay added is approximately 1.67 ms per nF connected to the pin. Note that the EN pins have a weak 1-μA pull-up to the 3V3 rail.

7.3.5 Soft-Start Time

The device has an internal pullup current source of 5 μA that charges an external slow-start capacitor to implement a slow-start time. 方程式 2 shows how to select a slow-start capacitor based on an expected slow-start time. The voltage reference (V_{REF}) is 0.8 V and the slow-start charge current (I_{SS}) is 5 μA. The soft-start circuit requires 1 nF per 200 μs to be connected at the SS pin. A 1-ms soft-start time is implemented for all converters fitting 4.7 nF to the relevant pins.

$$t_{SS} \text{ (ms)} = V_{REF} \text{ (V)} \times \left(\frac{C_{SS} \text{ (nF)}}{I_{SS} \text{ (\mu A)}} \right) \quad (2)$$



图 7-2. TPS65251-x Timing Diagram

7.3.6 Adjusting the Output Voltage

The output voltage is set with a resistor divider from the output node to the FB pin. TI recommends to use 1% tolerance or better divider resistors. To improve efficiency at light load, start with 40.2 kΩ for the R1 resistor and use [方程式 3](#) to calculate R2.

$$R2 = R1 \times \left(\frac{0.8 \text{ V}}{V_O - 0.8 \text{ V}} \right) \quad (3)$$

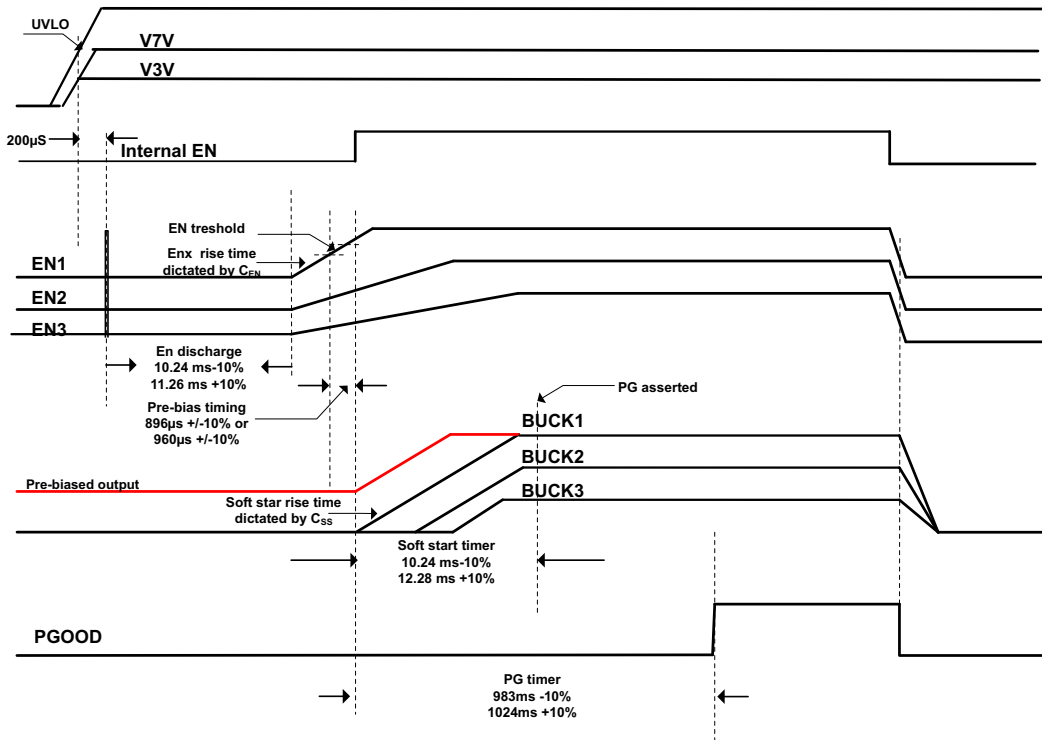

图 7-3. Voltage Divider Circuit

7.3.7 Input Capacitor

Use 10-μF X7R/X5R ceramic capacitors at the input of the converter inputs. Connect these capacitors as close as physically possible to the input pins of the converters.

7.3.8 Bootstrap Capacitor

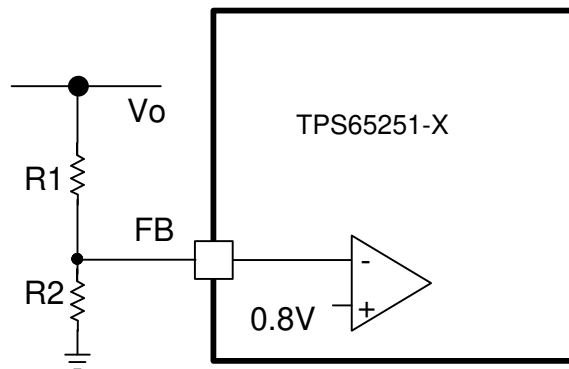
The device has three integrated boot regulators and requires a small ceramic capacitor between the BST and LX pin to provide the gate drive voltage for the high-side MOSFET. The value of the ceramic capacitor should be 0.047 μ F. TI recommends a ceramic capacitor with an X7R or X5R grade dielectric because of the stable characteristics over temperature and voltage.

7.3.9 Error Amplifier

The device has a transconductance error amplifier. The frequency compensation network is connected between the COMP pin and ground.

7.3.10 Slope Compensation

The device has a built-in slope compensation ramp. The slope compensation can prevent subharmonic oscillations in peak current mode control.

7.3.11 Power Good

The PGOOD pin is an open-drain output. The PGOOD pin is pulled low when any buck converter is pulled below 85% of the nominal output voltage. TI recommends to use a pullup resistor from the PGOOD to the output of Buck 1. The PGOOD is pulled up when all three buck converters' outputs are more than 90% of its nominal output voltage.

The reset time of the PGOOD pin varies according to the part:

- TPS65251-1 is 1 s.
- TPS65251-2 is 32 ms.
- TPS65251-3 is 256 ms.

The polarity of the PGOOD pin is active high.

7.3.12 3.3-V and 6.5-V LDO Regulators

The following ceramic capacitor (X7R/X5R) should be connected as close as possible to the described pins:

- 10 μ F for V7V pin 28
- 3.3 μ F for V3V pin 29

7.3.13 Current Limit Protection

All converters operate in hiccup mode: After an overcurrent event lasting more than 10 ms is sensed in any of the converters, all the converters shut down for 10 ms, then the start-up sequencing is retried. If the overload has been removed, the converter ramps up and operates normally. If this is not the case, the converter senses another overcurrent event and shuts down again, repeating the cycle (hiccup) until the failure is cleared.

If an overload condition lasts for <10 ms, only the relevant affected converter goes into and out of under voltage and no global hiccup mode occurs. The converter is protected by the cycle-by-cycle current limit during that time.

7.3.14 Overvoltage Transient Protection (OVP)

The device incorporates an OVP circuit to minimize voltage overshoot. The OVP feature minimizes the output overshoot by implementing a circuit to compare the FB pin voltage to OVP threshold, which is typical 106% of the internal voltage reference. If the FB pin voltage is greater than the OVP threshold, the high-side MOSFET is disabled preventing current from flowing to the output and minimizing output overshoot. When the FB voltage drops below the lower OVP threshold, which is typical 104%, the high-side MOSFET is allowed to turn on the next clock cycle.

7.3.15 Thermal Shutdown

The device implements an internal thermal shutdown to protect itself if the junction temperature exceeds 160°C. The thermal shutdown forces the device to stop switching when the junction temperature exceeds thermal trip threshold. After the die temperature decreases below 140°C, the device reinitiates the power-up sequence. The thermal shutdown hysteresis is 20°C.

7.4 Device Functional Modes

7.4.1 Low-Power/Pulse Skipping Operation

When a synchronous buck converter operates at light load or standby conditions, the switching losses are the dominant source of power losses. Under these load conditions, TPS65251-x uses a pulse skipping modulation technique to reduce the switching losses by keeping the power transistors in the off-state for several switching cycles, while maintaining a regulated output voltage. 图 7-4 shows the output voltage and load plus the inductor current.



图 7-4. Low Power/Pulse Skipping

During the burst mode, the converter continuously charges up the output capacitor until the output voltage reaches a certain limit threshold. The operation of the converter in this interval is equivalent to the peak inductor current mode control. In each switch period, the main switch is turned on until the inductor current reaches the peak current limit threshold. As the load increases, the number of pulses increases to make sure that the output voltage stays within regulation limits. When the load is very light, the low-power controller has a zero crossing detector to allow the low-side MOSFET to operate even in light load conditions. The transistor is not disabled at light loads. A zero crossing detection circuit disables it when inductor current reverses. During the whole process, the body diode does not conduct, but is used as blocking diode only.

During the skipping interval, the upper and lower transistors are turned off and the converter stays in idle mode. The output capacitors are discharged by the load current until the moment when the output voltage drops to a low threshold.

The choice of output filter influences the performance of the low-power circuit. The maximum ripple during low-power mode can be calculated as:

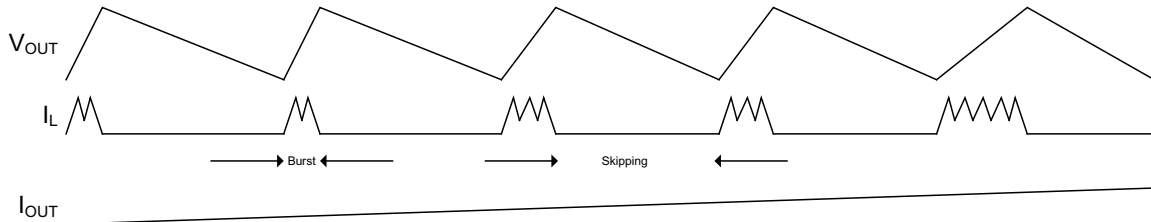
$$V_{\text{OUT_RIPPLE}} = \frac{K_{\text{RIP}} T_{\text{S}}}{C_{\text{OUT}}} \quad (4)$$

where

- K_{RIP} is 1.4 for Buck 1.
- K_{RIP} is 0.7 for Buck 2 and Buck 3.

T_{S} can be calculated as:

$$T_{\text{S}} = \frac{0.35}{\left[\left(\frac{V_{\text{IN}} - V_{\text{OUT}}}{L} \right) \frac{V_{\text{OUT}}}{V_{\text{IN}}} \right]} \quad (5)$$

8 Application and Implementation

备注

以下应用部分中的信息不属于 TI 器件规格的范围，TI 不担保其准确性和完整性。TI 的客户应负责确定器件是否适用于其应用。客户应验证并测试其设计，以确保系统功能。

8.1 Application Information

The device is triple synchronous step down dc/dc converter. It is typically used to convert a higher dc voltage to lower dc voltages with continuous available output current of 3 A/2 A/2 A. The following design procedure can be used to select component values for the TPS65251-x.

8.2 Typical Application

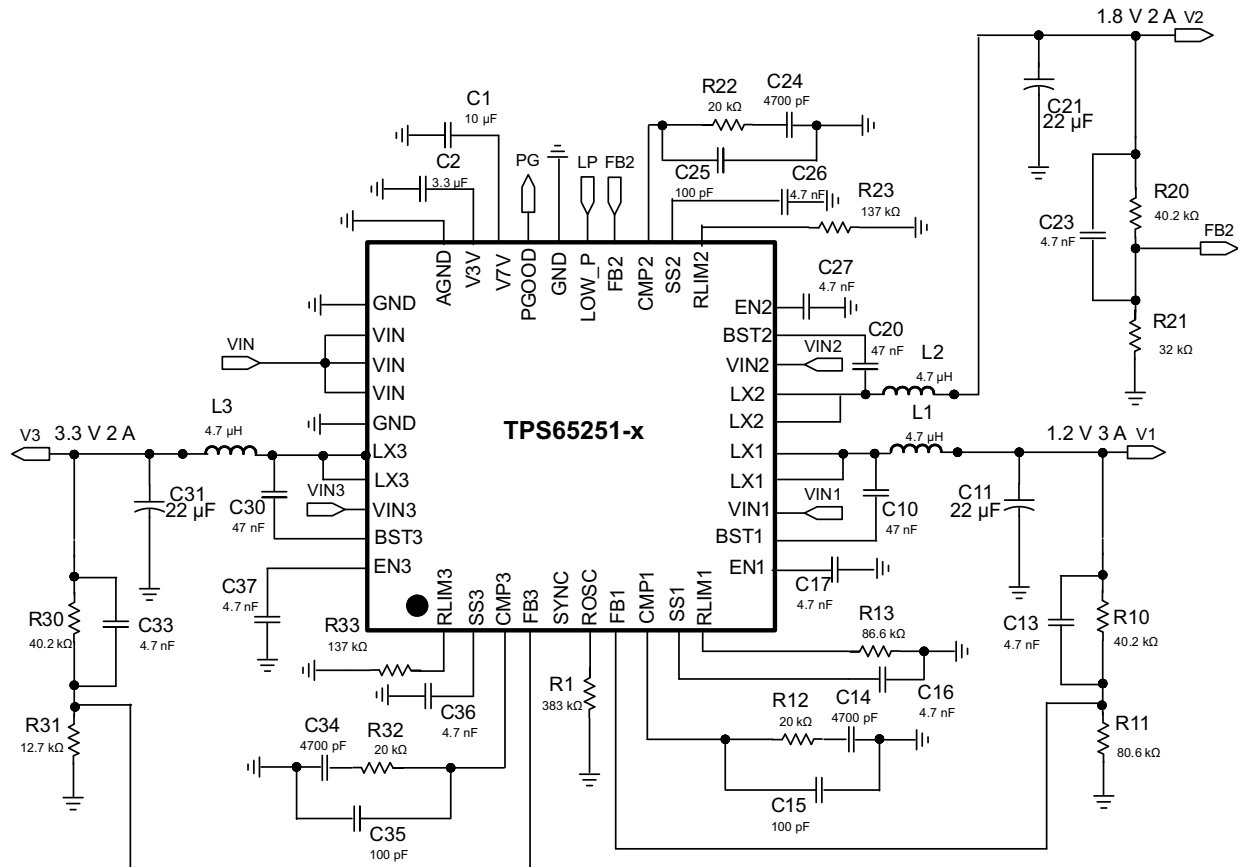

A. VIN pins require local decoupling capacitors.

图 8-1. Typical Application Circuit

8.2.1 Design Requirements

DESIGN PARAMETERS	VALUE
Output voltage	1.2 V
Transient response 0.5-A to 2-A load step	120 mV
Maximum output current	3 A
Input voltage	12 V nom, 9.6 to 14.4 V
Output voltage ripple	<30 mV p-p
Switching frequency	500 kHz

8.2.2 Detailed Design Procedure

8.2.2.1 Loop Compensation Circuit

A typical compensation circuit could be type II (R_c and C_c) to have a phase margin between 60° and 90° , or type III (R_c , C_c and C_{ff}) to improve the converter transient response. C_{Roll} adds a high frequency pole to attenuate high-frequency noise when needed. It may also prevent noise coupling from other rails if there is possibility of cross coupling in between rails when layout is very compact.



图 8-2. Loop Compensation

To calculate the external compensation components use 表 8-1:

表 8-1. Design Guideline for the Loop Compensation

	TYPE II CIRCUIT	TYPE III CIRCUIT
Select switching frequency that is appropriate for application depending on L, C sizes, output ripple, EMI concerns and etc. Switching frequencies between 500 kHz and 1 MHz give best trade off between performance and cost. When using smaller L and Cs, switching frequency can be increased. To optimize efficiency, switching frequency can be lowered.		Type III circuit recommended for switching frequencies higher than 500 kHz.
Select cross over frequency (f_c) to be less than 1/5 to 1/10 of switching frequency.	Suggested $f_c = f_s/10$	Suggested $f_c = f_s/10$
Set and calculate R_c .	$R_c = \frac{2\pi \times f_c \times V_o \times C_o}{g_M \times V_{ref} \times g_{m_{ps}}} \quad (6)$	$R_c = \frac{2\pi \times f_c \times C_o}{g_M \times g_{m_{ps}}} \quad (7)$
Calculate C_c by placing a compensation zero at or before the converter dominant pole $f_p = \frac{1}{C_o \times R_L \times 2\pi}$	$C_c = \frac{R_L \times C_o}{R_c} \quad (8)$	$C_c = \frac{R_L \times C_o}{R_c} \quad (10)$

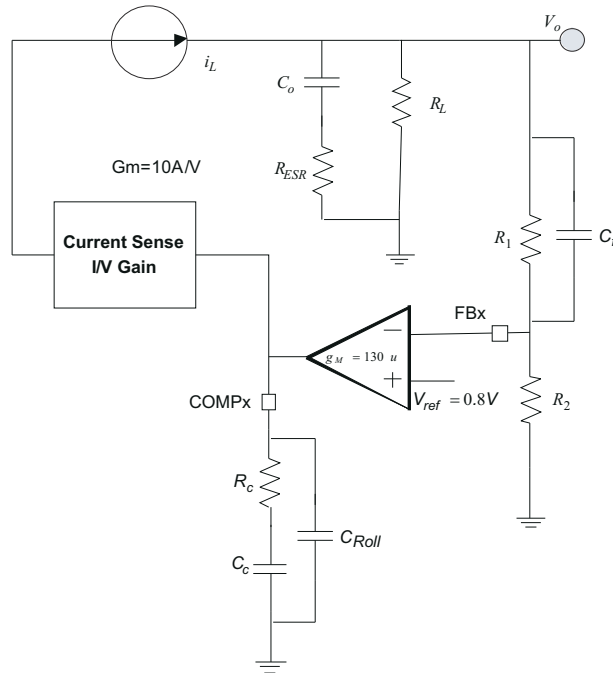
表 8-1. Design Guideline for the Loop Compensation (continued)

	TYPE II CIRCUIT	TYPE III CIRCUIT
Add C_{Roll} if needed to remove large signal coupling to high impedance COMP node. Make sure that $f_{p_{Roll}} = \frac{1}{2 \times \pi \times R_C \times C_{Roll}} \quad (11)$ is at least twice the cross over frequency.	$C_{Roll} = \frac{R_{e_{sr}} \times C_O}{R_C} \quad (12)$	$C_{Roll} = \frac{R_{e_{sr}} \times C_O}{R_C} \quad (13)$
Calculate C_{ff} compensation zero at low frequency to boost the phase margin at the crossover frequency. Make sure that the zero frequency ($f_{z_{ff}}$) is smaller than soft-start equivalent frequency ($1/T_{ss}$).	NA	$C_{ff} = \frac{1}{2 \times \pi \times f_{z_{ff}} \times R_1} \quad (14)$

8.2.2.2 Selecting the Switching Frequency

The first step is to decide on a switching frequency for the regulator. Typically, you will want to choose the highest switching frequency possible since this will produce the smallest solution size. The high switching frequency allows for lower valued inductors and smaller output capacitors compared to a power supply that switches at a lower frequency. However, the highest switching frequency causes extra switching losses, which hurt the converter's performance. The converter is capable of running from 300 kHz to 2.2 MHz. Unless a small solution size is an ultimate goal, a moderate switching frequency of 500 kHz is selected to achieve both a small solution size and a high efficiency operation. Using 图 7-1, R1 is determined to be 383 kΩ

8.2.2.3 Output Inductor Selection

To calculate the value of the output inductor, use 方程式 15. KIND is a coefficient that represents the amount of inductor ripple current relative to the maximum output current. In general, KIND is normally from 0.1 to 0.3 for the majority of applications.

For this design example, use KIND = 0.2 and the inductor value is calculated to be 3.6 μH. For this design, a nearest standard value was chosen: 4.7 μH. For the output filter inductor, it is important that the RMS current and saturation current ratings not be exceeded. The RMS and peak inductor current can be found from 方程式 16 and 方程式 17.

$$L_o = \frac{V_{in} - V_{out}}{I_o \times K_{ind}} \times \frac{V_{out}}{V_{in} \times f_{sw}} \quad (15)$$

$$I_{ripple} = \frac{V_{in} - V_{out}}{L_o} \times \frac{V_{out}}{V_{in} \times f_{sw}} \quad (16)$$

$$I_{L_{rms}} = \sqrt{I_o^2 + \frac{1}{12} \times \left(\frac{V_o \times (V_{in_{max}} - V_o)}{V_{in_{max}} \times L_o \times f_{sw}} \right)^2} \quad (17)$$

$$I_{L_{peak}} = I_{out} + \frac{I_{ripple}}{2} \quad (18)$$

8.2.2.4 Output Capacitor

There are two primary considerations for selecting the value of the output capacitor. The output capacitors are selected to meet load transient and output ripple's requirements.

方程式 19 gives the minimum output capacitance to meet the transient specification. For this example, $L_o = 4.7 \mu\text{H}$, $\Delta I_{OUT} = 1.5 \text{ A} - 0.75 \text{ A} = 0.75 \text{ A}$ and $\Delta V_{OUT} = 120 \text{ mV}$. Using these numbers gives a minimum capacitance of 18 μF. A standard 22-μF ceramic capacitor is chosen in the design.

$$C_o > \frac{\Delta I_{OUT}^2 \times L_o}{V_{out} \times \Delta V_{out}} \quad (19)$$

方程式 20 calculates the minimum output capacitance needed to meet the output voltage ripple specification. Where f_{sw} is the switching frequency, V_{RIPPLE} is the maximum allowable output voltage ripple, and I_{RIPPLE} is the inductor ripple current. In this case, the maximum output voltage ripple is 30 mV. From 方程式 16, the output current ripple is 0.46 A. From 方程式 20, the minimum output capacitance meeting the output voltage ripple requirement is 1.74 μ F.

$$C_o > \frac{1}{8 \times f_{sw}} \times \frac{1}{\frac{V_{ripple}}{I_{ripple}}} \quad (20)$$

Additional capacitance de-rating for aging, temperature and DC bias should influence this minimum value. For this example, one 22- μ F, 6.3-V X7R ceramic capacitor with 3 m Ω of ESR will be used.

8.2.2.5 Input Capacitor

A minimum 10- μ F X7R/X5R ceramic input capacitor is recommended to be added between VIN and GND. These capacitors should be connected as close as physically possible to the input pins of the converters as they handle the RMS ripple current shown in 方程式 21. For this example, $I_{OUT} = 3$ A, $V_{OUT} = 1.2$ V, $V_{INmin} = 9.6$ V, from 方程式 21, the input capacitors must support a ripple current of 0.99 A RMS.

$$I_{cirms} = I_{out} \times \sqrt{\frac{V_{out}}{V_{inmin}} \times \frac{(V_{inmin} - V_{out})}{V_{inmin}}} \quad (21)$$

The input capacitance value determines the input ripple voltage of the regulator. The input voltage ripple can be calculated using 方程式 22. Using the design example values, $I_{OUTmax} = 3$ A, $C_{IN} = 10$ μ F, $f_{SW} = 500$ kHz, yields an input voltage ripple of 150 mV.

$$\Delta V_{in} = \frac{I_{outmax} \times 0.25}{C_{in} \times f_{sw}} \quad (22)$$

8.2.2.6 Soft-Start Capacitor

The soft-start capacitor determines the minimum amount of time it will take for the output voltage to reach its nominal programmed value during power-up. This is useful if the output capacitance is very large and would require large amounts of current to quickly charge the capacitor to the output voltage level.

The soft-start capacitor value can be calculated using 方程式 23. In this example, the converter's soft-start time is 0.8 ms. In TPS65251-x, I_{ss} is 5 μ A and V_{ref} is 0.8 V. From 方程式 23, the soft-start capacitance is 5 nF. A standard 4.7-nF ceramic capacitor is chosen in this design. In this example, C16 is 4.7 nF

$$C_{ss}(nF) = \frac{T_{ss}(ms) \times I_{ss}(\mu A)}{V_{ref}(V)} \quad (23)$$

8.2.2.7 Bootstrap Capacitor Selection

A 0.047- μ F ceramic capacitor must be connected between the BST to LX pin for proper operation. It is recommended to use a ceramic capacitor with X5R or better grade dielectric. The capacitor should have 10-V or higher voltage rating.

8.2.2.8 Adjustable Current Limiting Resistor Selection

The converter uses the voltage drop on the high-side MOSFET to measure the inductor current. The overcurrent protection threshold can be optimized by changing the trip resistor. 图 6-6 governs the threshold of overcurrent

protection for Buck 1. When selecting a resistor, do not exceed the graph limits. In this example, the over current threshold is 3.2 A. In order to prevent a premature limit trip, the minimum line is used and the resistor is 86.6 kΩ.

When setting high-side current limit to large current values, ensure that the additional load immediately prior to an overcurrent condition will not cause the switching node voltage to exceed 20 V. Additionally, ensure during worst case operation, with all bucks loaded immediately prior to current limit, the maximum virtual junction temperature of the device does not exceed 125°C.

8.2.2.9 Output Voltage and Feedback Resistors Selection

For the example design, 40.2 kΩ was selected for R10. Vout is 1.2 V, Vref = 0.8 V. Using 方程式 24, R11 is calculated as 80.4 kΩ. A standard 80.6-kΩ resistor is chose in this design.

$$R11 = \frac{V_{out} - V_{ref}}{V_{ref}} \times R10 \quad (24)$$

8.2.2.10 Compensation

A type-II compensation circuit is adequate for the converter to have a phase margin between 60 and 90 degrees. The following equations show the procedure of designing a peak current mode control dc/dc converter.

The compensation design takes the following steps:

1. Set up the anticipated cross-over frequency. In this example, the anticipated cross-over frequency (fc) is 65 kHz. The power stage gain (gm_{PS}) is 10 A/V and the GM amplifier gain (g_M) is 130 μA/V.

$$R12 = \frac{2\pi \times f_c \times V_o \times C_o}{g_M \times V_{ref} \times g_{m_{PS}}} \quad (25)$$

2. Place compensation zero at low frequency to boost the phase margin at the crossover frequency. From the procedures above, the compensation network includes a 20-kΩ resistor (R12) and a 4700-pF capacitor (C1).
3. An additional pole can be added to attenuate high frequency noise.

From the procedures above, the compensation network includes a 20-kΩ resistor (R12) and a 4700-pF capacitor (C14).

8.2.2.11 3.3-V and 6.5-V LDO Regulators

The following ceramic capacitor (X7R/X5R) should be connected as close as possible to the described pins:

- 10 μF for V7V pin 28
- 3.3 μF to 10 μF for V3V pin 29

8.2.3 Application Curves



图 8-3. Buck 1 Start-Up (Ch3 = V_{IN})



图 8-4. Buck 1 Soft-Start

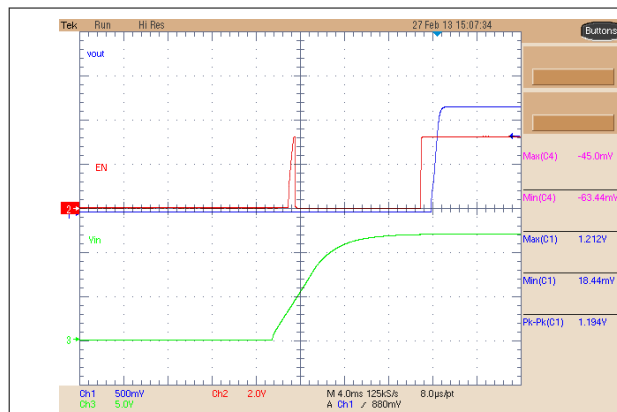

图 8-5. Buck 1 Start-Up 1.5-A Resistive

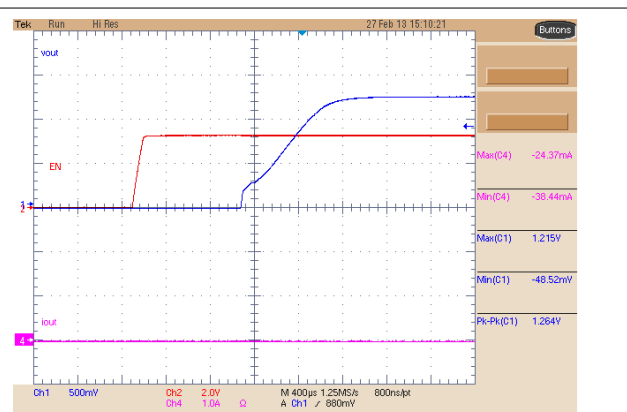

图 8-6. Buck 1 Soft-Start 2-A Load

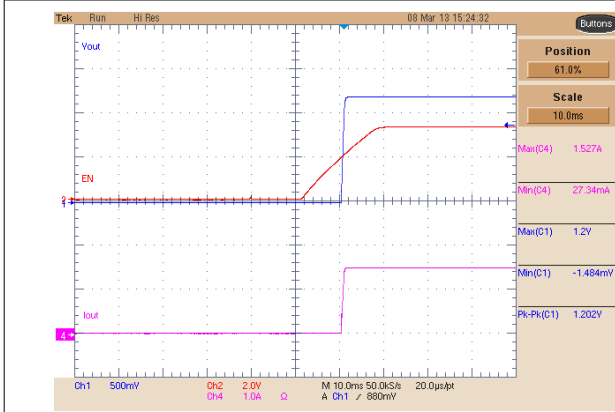

图 8-7. Buck 1 Switching Node, No Load

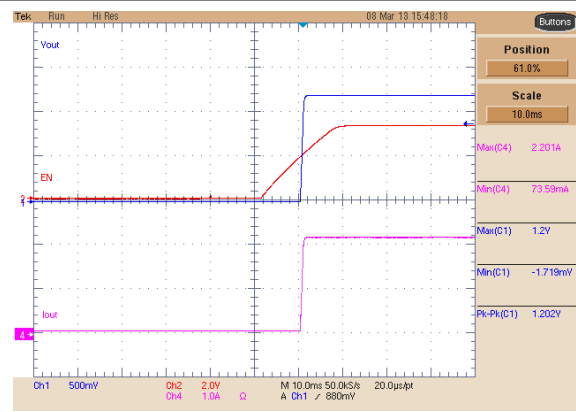

图 8-8. Buck 1 Switching Node, 1-A Load

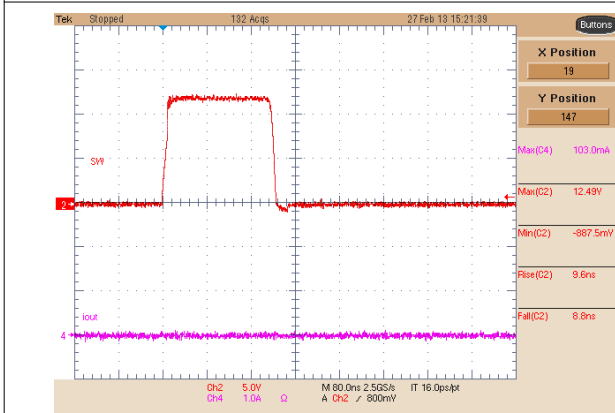

图 8-9. Buck 1 Switching Node, 2-A Load

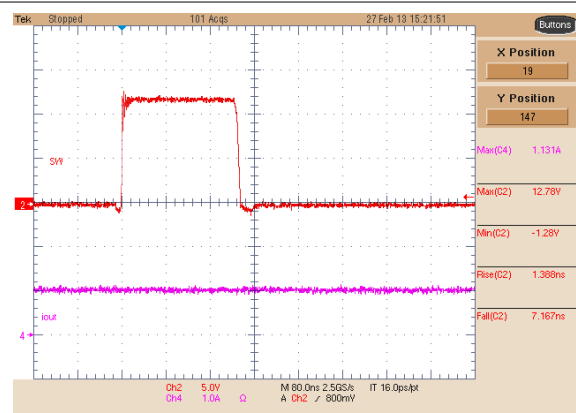

图 8-10. Buck 1 Switching Node, 3-A Load

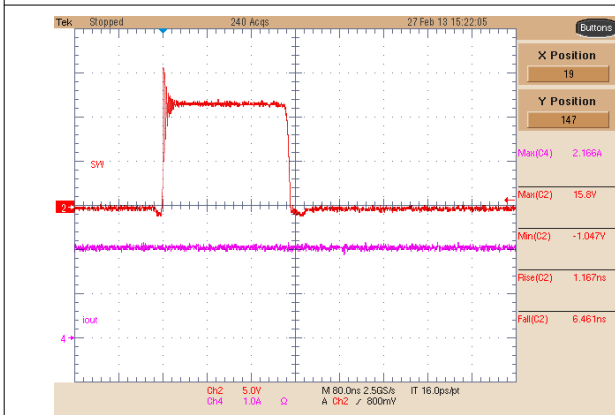

图 8-11. Buck 1 Dynamic Response, 0- to 1-A Step

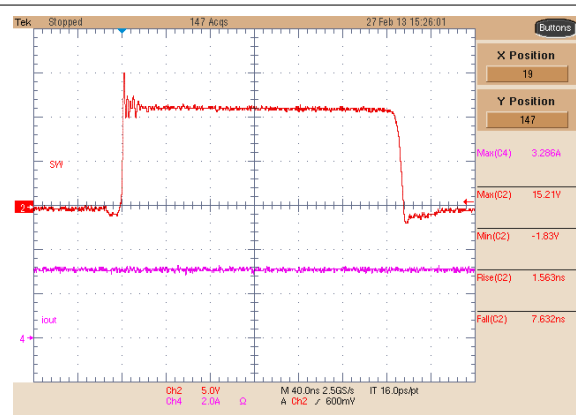

图 8-12. Buck 1 Dynamic Response, 2-A to 3-A Step

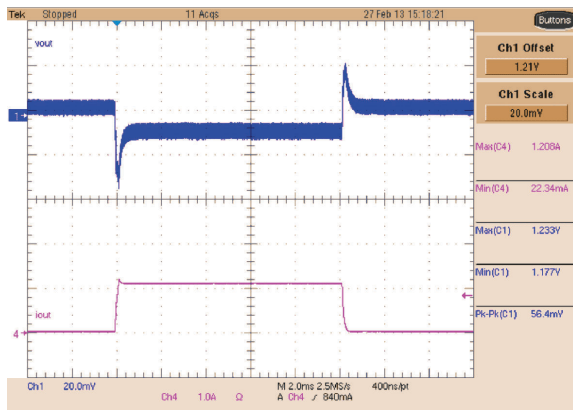

图 8-13. Buck 1 Dynamic Response, 1-A to 3-A Step

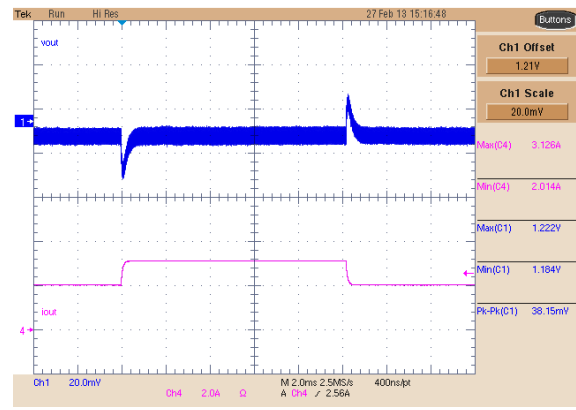

图 8-14. Buck 1 Ripple, 1-A Load

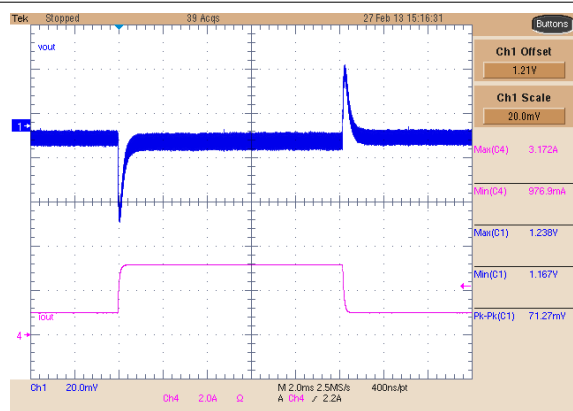

图 8-15. Buck 1 Ripple, 2-A Load

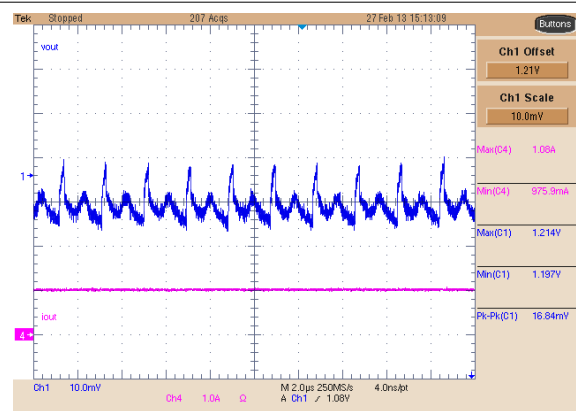

图 8-16. Buck 1 Ripple, 3-A Load

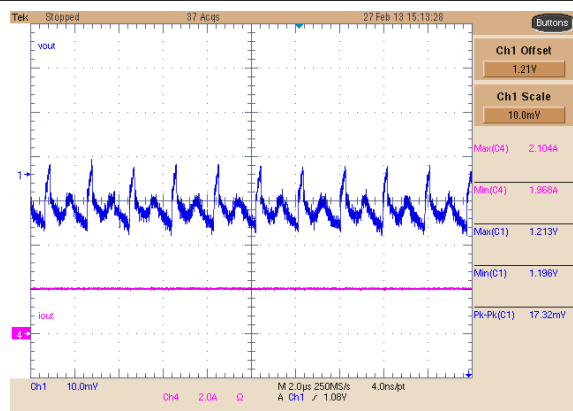

图 8-17. Buck 1 Current Limit Operation With Slow Rising Output Current, Trip at 4 A

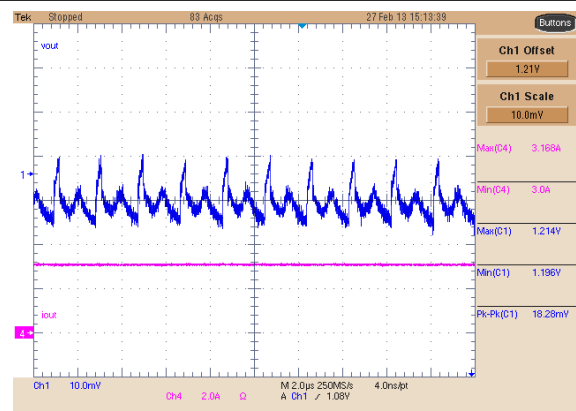

图 8-18. Buck 1 Current Limit Operation, Hiccup

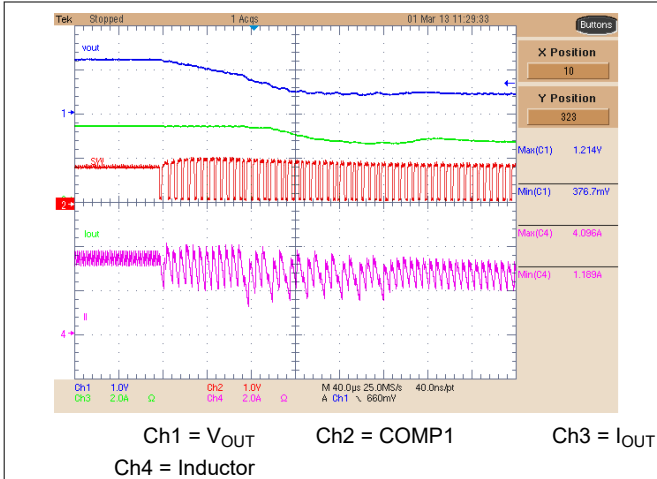

图 8-19. Buck 1 Low-Power Output, No Load

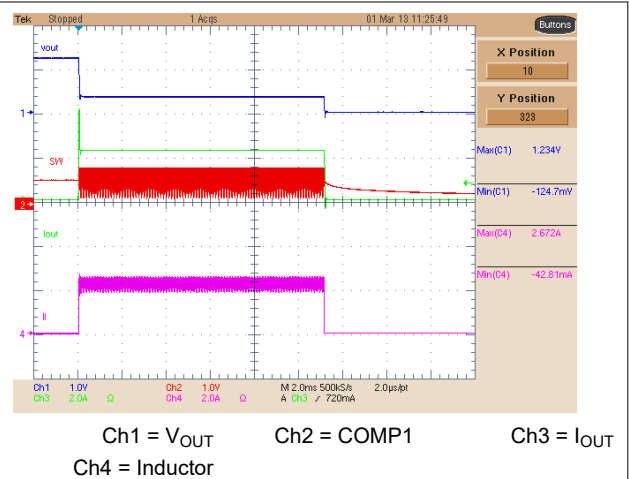

图 8-20. Buck 1 Low-Power Operation

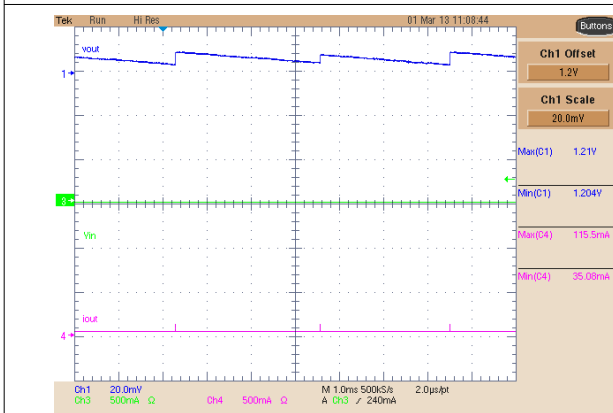

图 8-21. Buck 1 PFM to PWM Transition

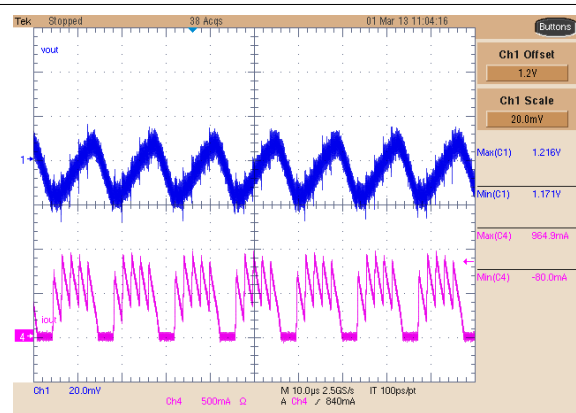

图 8-22. Buck 1 PWM to PFM Transition

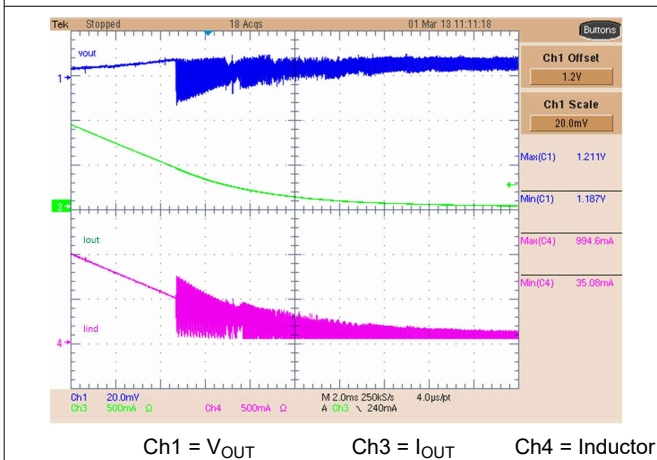

Ch3 = V_{IN}

图 8-23. Buck 2 Start-Up, No Load

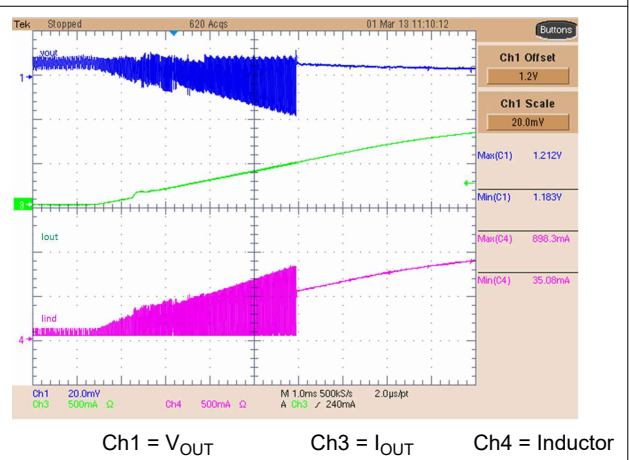
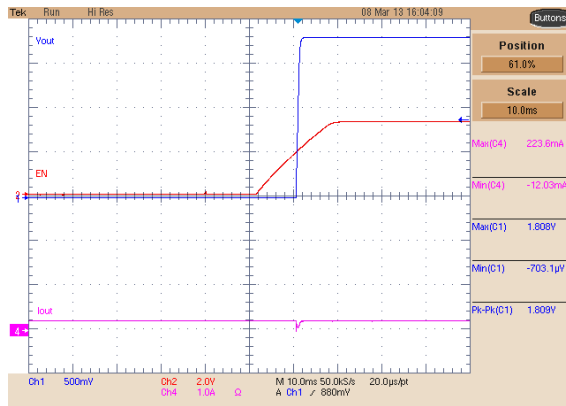

图 8-24. Buck 2 Start-Up, 2-A Load



图 8-25. Buck 2 Switching Node, No Load

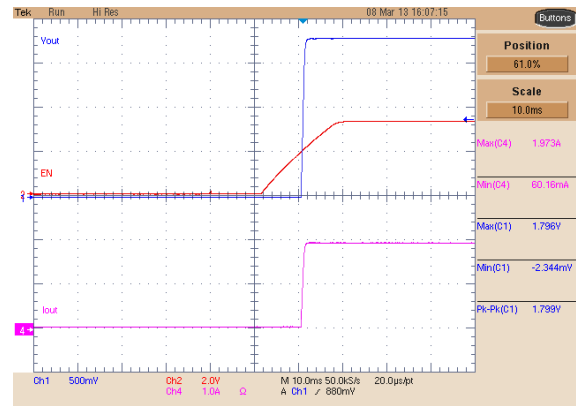

图 8-26. Buck 2 Switching Node, 1-A Load

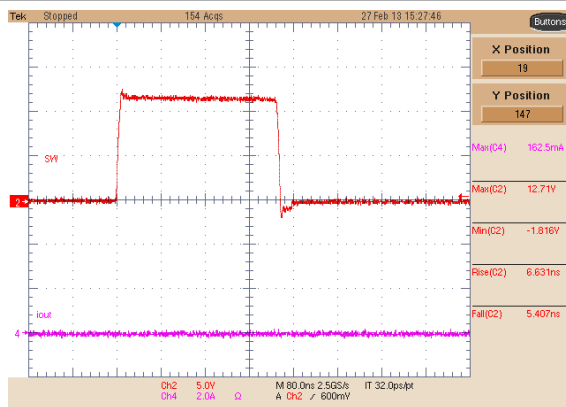

图 8-27. Buck 2 Switching Node, 2-A Load

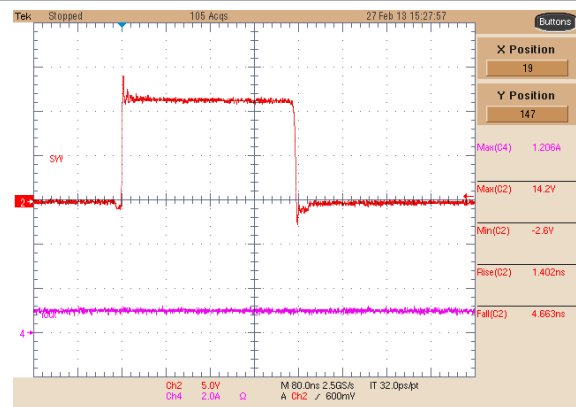

图 8-28. Buck 2 Dynamic Response, 0-A to 1-A Step

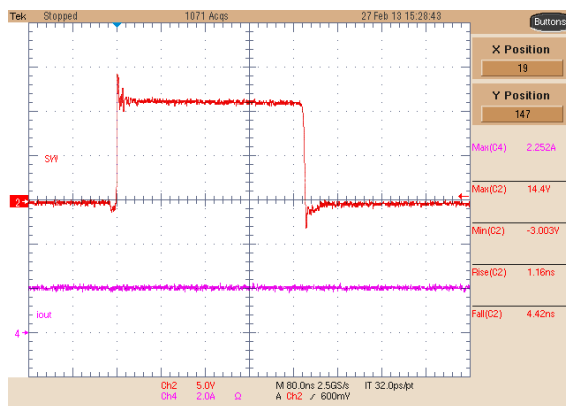

图 8-29. Buck 2 Dynamic Response, 1-A to 2-A Step

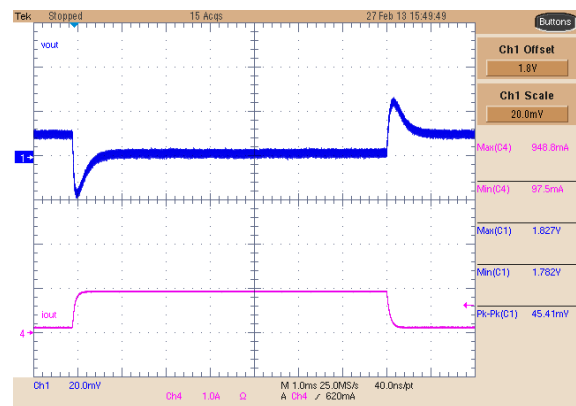

图 8-30. Buck 2 Ripple, No Load

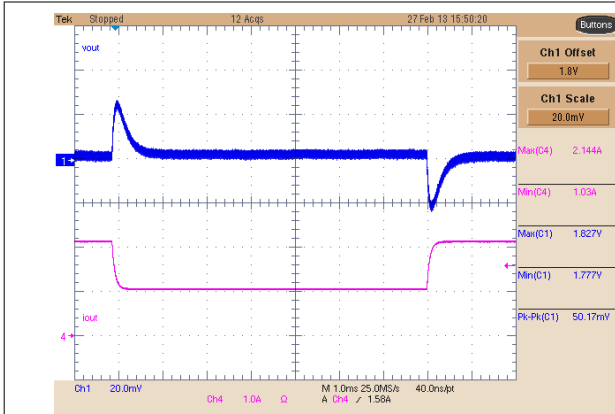

图 8-31. Buck 2 Ripple, 1-A Load

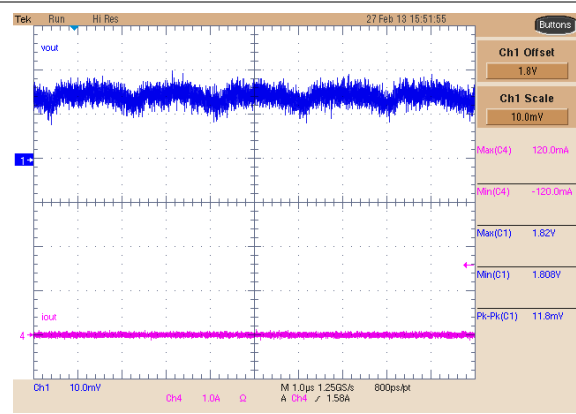

图 8-32. Buck 2 Ripple, 3-A Load

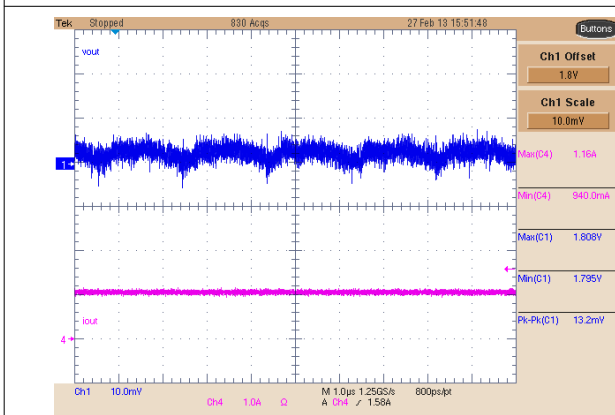

图 8-33. Buck 2 Low-Power Output, No Load

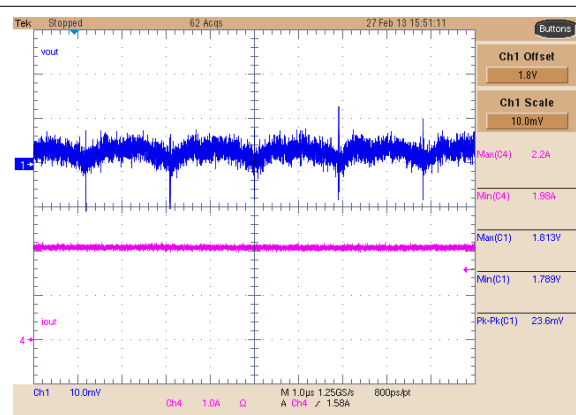

Ch1 = V_{OUT} Ch3 = I_{OUT} Ch4 = Inductor
 图 8-34. Buck 2 PFM to PWM Transition

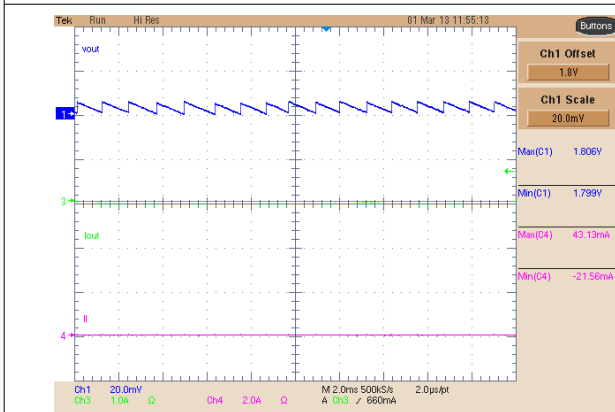
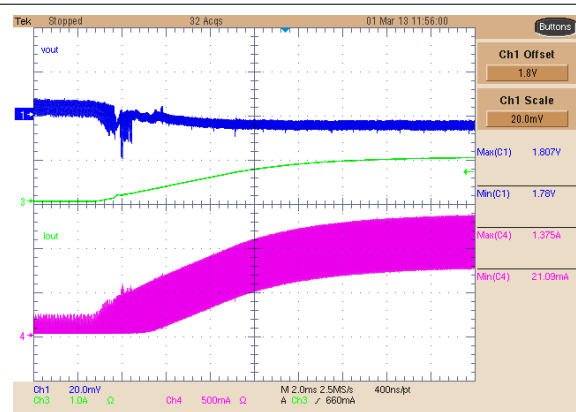
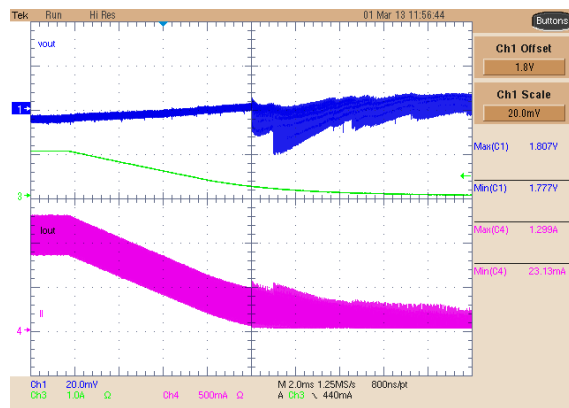

Ch1 = V_{OUT} Ch3 = I_{OUT} Ch4 = Inductor

图 8-35. Buck 2 PWM to PFM Transition

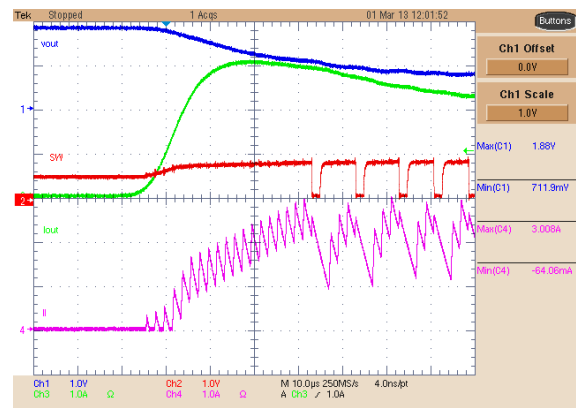

Ch1 = V_{OUT} Ch2 = COMP1 Ch3 = I_{OUT}
Ch4 = Inductor

图 8-36. Buck 2 Current Limit Operation

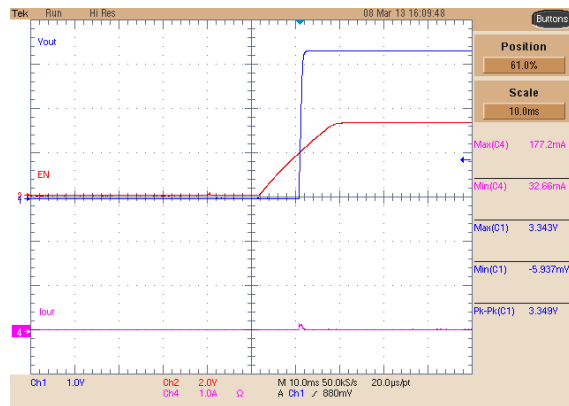

Ch3 = V_{IN}

图 8-37. Buck 3 Start-Up



图 8-38. Buck 3 Soft-Start



图 8-39. Buck 3 Switching Node, No Load

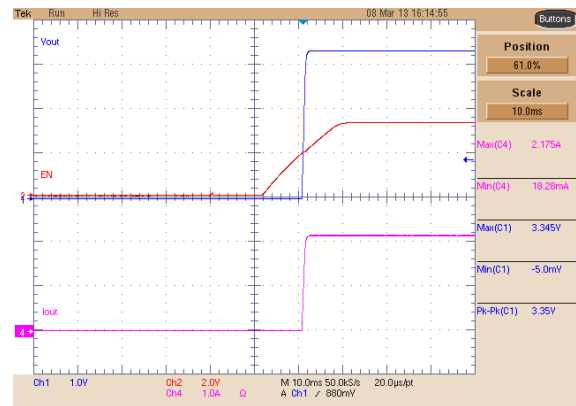

图 8-40. Buck 3 Switching Node, 1-A Load

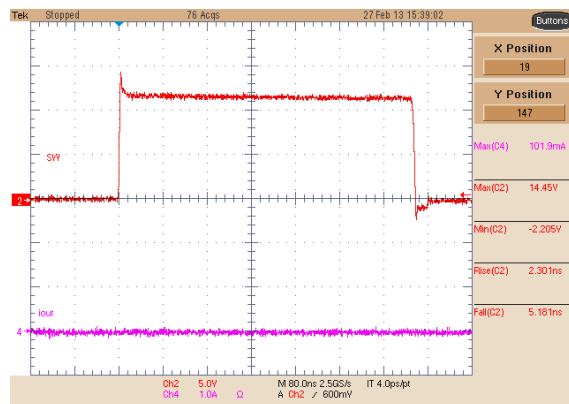

图 8-41. Buck 3 Switching Node, 1.5-A Load

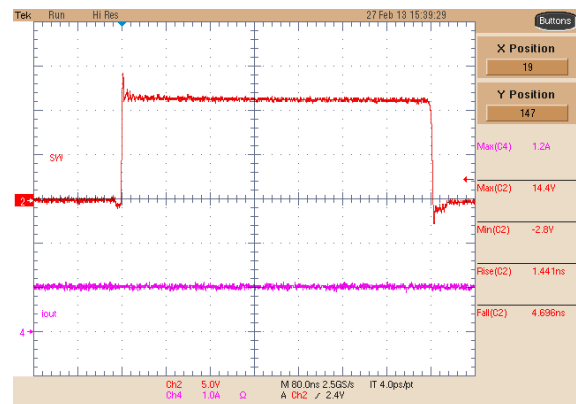

图 8-42. Buck 3 Dynamic Response, 0-A to 1-A Step

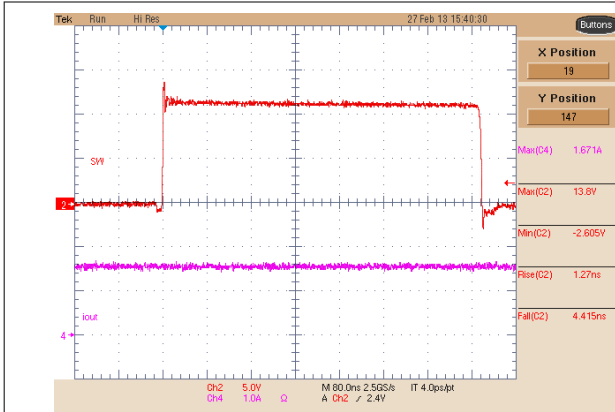

图 8-43. Buck 3 Dynamic Response, 1-A to 1.5-A Step

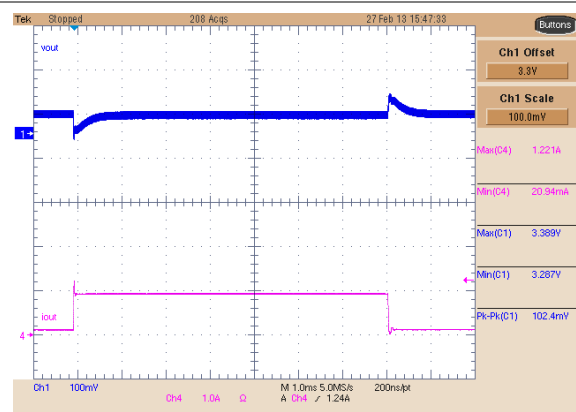

图 8-44. Buck 3 Ripple, No Load

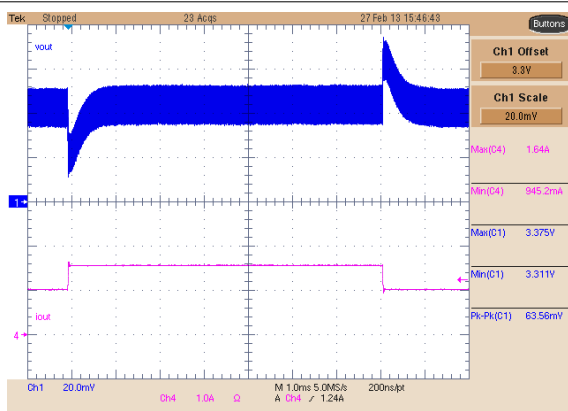

图 8-45. Buck 3 Ripple, 1-A Load

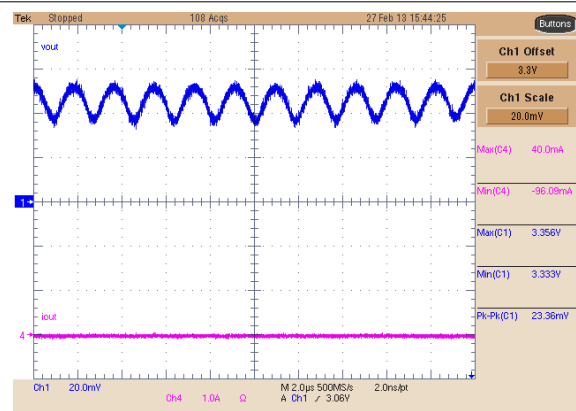

图 8-46. Buck 3 Ripple, 3-A Load

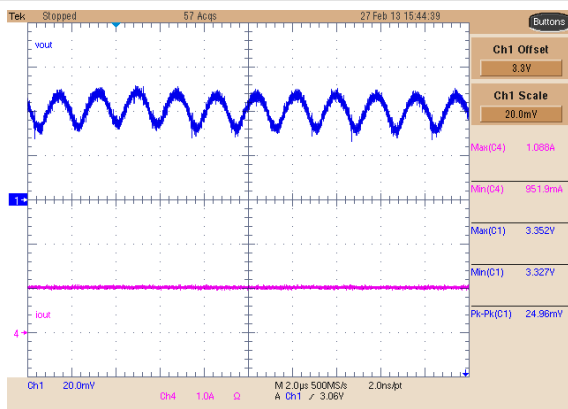

图 8-47. Buck 3 Low-Power Output, No Load

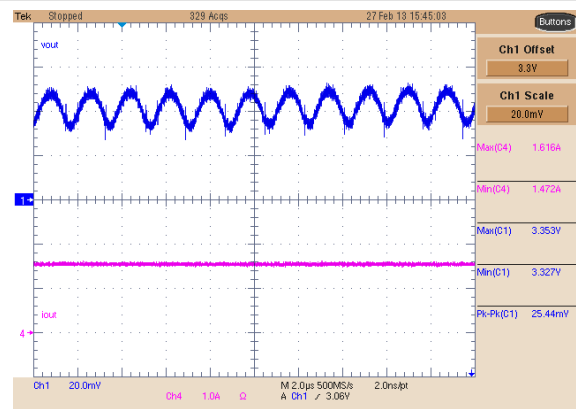

Ch1 = V_{OUT} Ch3 = I_{OUT} Ch4 = Inductor

图 8-48. Buck 3 PFM to PWM Transition

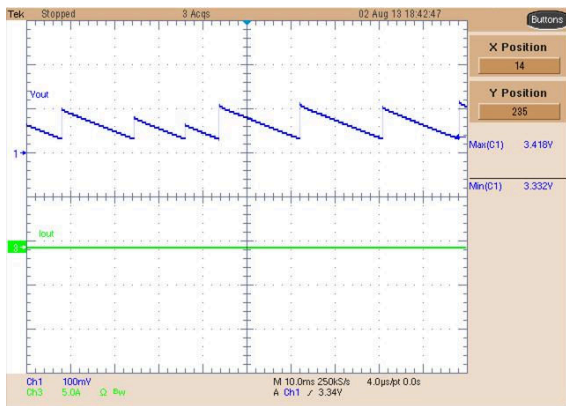
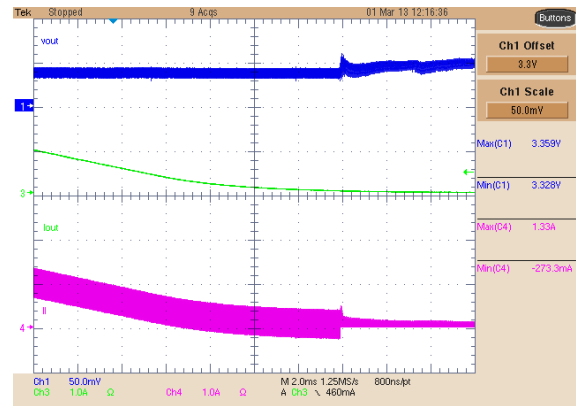
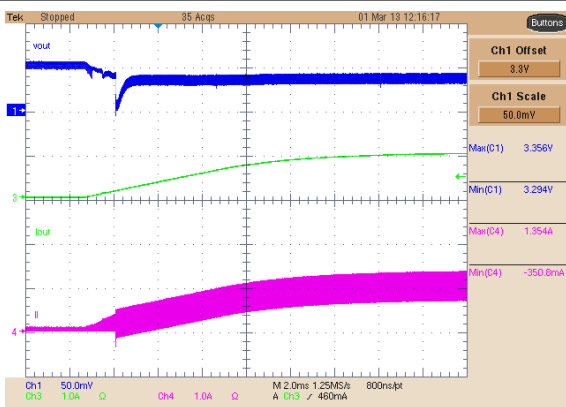

Ch1 = V_{OUT} Ch3 = I_{OUT} Ch4 = Inductor

图 8-49. Buck 3 PWM to PFM Transition

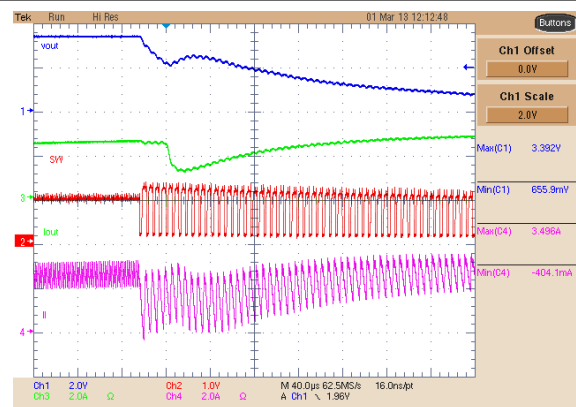

Ch1 = V_{OUT} Ch2 = COMP1 Ch3 = I_{OUT}
 Ch4 = Inductor

图 8-50. Buck 3 Current Limit Operation



图 8-51. Temperature Profile, $V_O = 1.2\text{ V}$, $I_O = 3\text{ A}$, $V_O = 1.8\text{ V}$, $I_O = 2\text{ A}$, $V_O = 3.3\text{ V}$, $I_O = 2\text{ A}$, $T_A = 28^\circ\text{C}$

9 Power Supply Recommendations

The device is designed to operate from an input voltage supply range between 4.5 V and 18 V. This input power supply should be well regulated. If the input supply is located more than a few inches from the TPS65251-x converter, additional bulk capacitance may be required in addition to the ceramic bypass capacitors. An electrolytic capacitor with a value of 47 μ F is a typical choice.

10 Layout

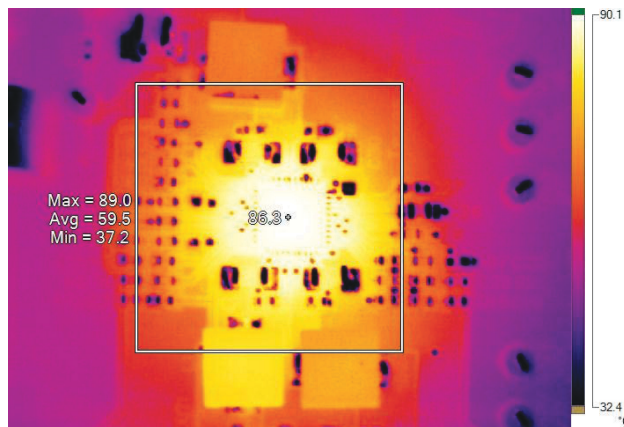
10.1 Layout Guidelines

Layout is a critical portion of PMIC designs.

- Place VOUT, and LX on the top layer and an inner power plane for VIN.
- Fit also on the top layer connections for the remaining pins of the PMIC and a large top side area filled with ground.
- The top layer ground area should be connected to the internal ground layer(s) using vias at the input bypass capacitor, the output filter capacitor and directly under the TPS65251-x device to provide a thermal path from the Powerpad land to ground.
- The AGND pin should be tied directly to the power pad under the IC and the power pad.
- For operation at full rated load, the top side ground area together with the internal ground plane, must provide adequate heat dissipating area.
- There are several signals paths that conduct fast changing currents or voltages that can interact with stray inductance or parasitic capacitance to generate noise or degrade the power supplies performance. To help eliminate these problems, the VIN pin should be bypassed to ground with a low ESR ceramic bypass capacitor with X5R or X7R dielectric. Care should be taken to minimize the loop area formed by the bypass capacitor connections, the VIN pins, and the ground connections. Since the LX connection is the switching node, the output inductor should be located close to the LX pins, and the area of the PCB conductor minimized to prevent excessive capacitive coupling.
- The output filter capacitor ground should use the same power ground trace as the VIN input bypass capacitor. Try to minimize this conductor length while maintaining adequate width.
- The compensation should be as close as possible to the COMP pins. The COMP and OSC pins are sensitive to noise so the components associated to these pins should be located as close as possible to the IC and routed with minimal lengths of trace.

10.2 Layout Example



图 10-1. Layout Schematic

11 Device and Documentation Support

11.1 接收文档更新通知

要接收文档更新通知，请导航至 ti.com 上的器件产品文件夹。点击 [订阅更新](#) 进行注册，即可每周接收产品信息更改摘要。有关更改的详细信息，请查看任何已修订文档中包含的修订历史记录。

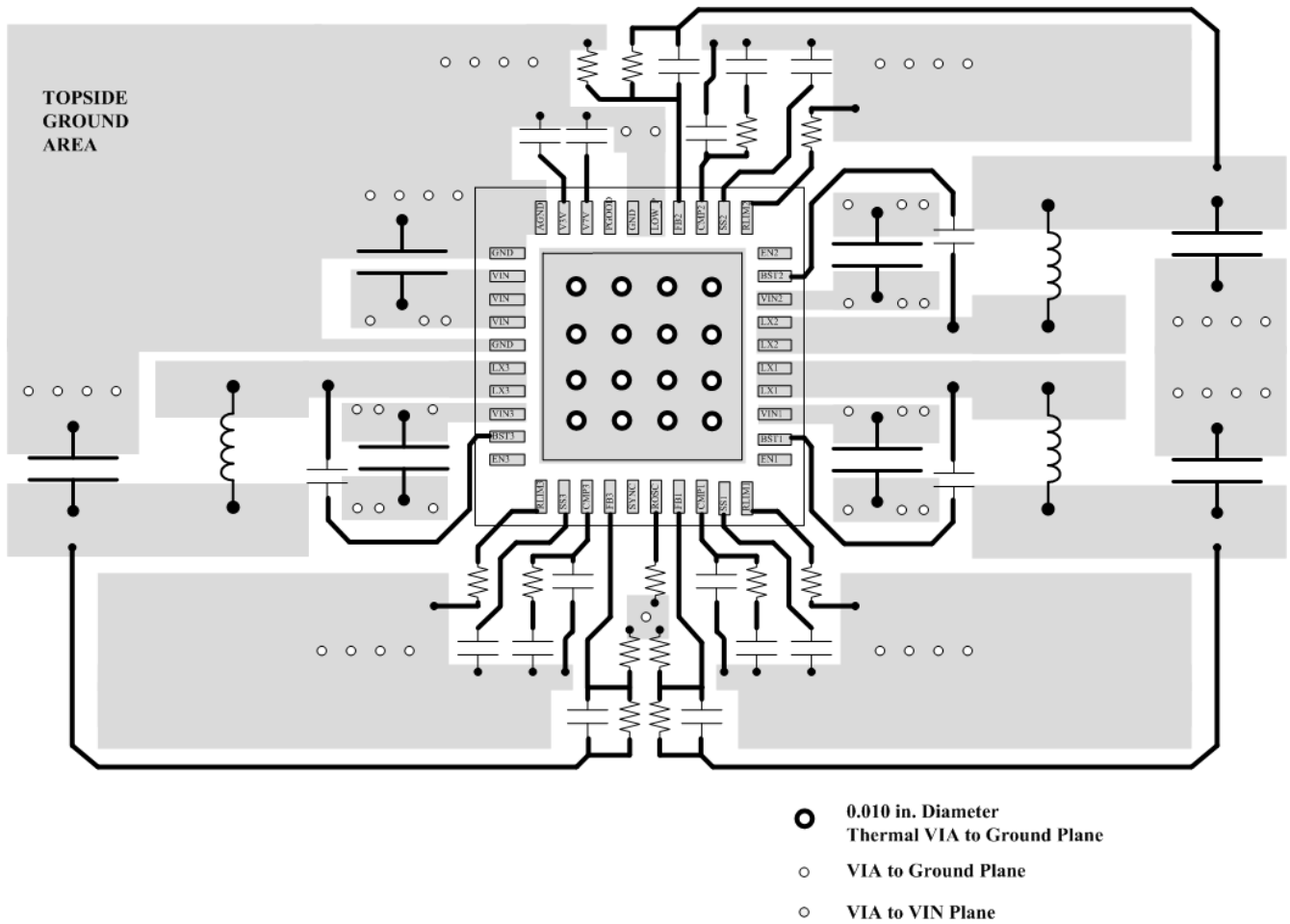
11.2 支持资源

[TI E2E™ 支持论坛](#) 是工程师的重要参考资料，可直接从专家获得快速、经过验证的解答和设计帮助。搜索现有解答或提出自己的问题可获得所需的快速设计帮助。

链接的内容由各个贡献者“按原样”提供。这些内容并不构成 TI 技术规范，并且不一定反映 TI 的观点；请参阅 TI 的《[使用条款](#)》。

11.3 Trademarks

蓝光™ is a trademark of Blu-ray Disc Association.

TI E2E™ is a trademark of Texas Instruments.

所有商标均为其各自所有者的财产。

11.4 Electrostatic Discharge Caution



This integrated circuit can be damaged by ESD. Texas Instruments recommends that all integrated circuits be handled with appropriate precautions. Failure to observe proper handling and installation procedures can cause damage.

ESD damage can range from subtle performance degradation to complete device failure. Precision integrated circuits may be more susceptible to damage because very small parametric changes could cause the device not to meet its published specifications.







11.5 术语表

[TI 术语表](#) 本术语表列出并解释了术语、首字母缩略词和定义。

12 Mechanical, Packaging, and Orderable Information

The following pages include mechanical, packaging, and orderable information. This information is the most current data available for the designated devices. This data is subject to change without notice and revision of this document. For browser-based versions of this data sheet, refer to the left-hand navigation.

PACKAGING INFORMATION

Orderable Device	Status (1)	Package Type	Package Drawing	Pins	Package Qty	Eco Plan (2)	Lead finish/ Ball material (6)	MSL Peak Temp (3)	Op Temp (°C)	Device Marking (4/5)	Samples
TPS65251-1RHAR	ACTIVE	VQFN	RHA	40	2500	RoHS & Green	NIPDAU	Level-3-260C-168 HR	-40 to 125	TPS 65251-1	
TPS65251-1RHAT	ACTIVE	VQFN	RHA	40	250	RoHS & Green	NIPDAU	Level-3-260C-168 HR	-40 to 125	TPS 65251-1	
TPS65251-2RHAR	ACTIVE	VQFN	RHA	40	2500	RoHS & Green	NIPDAU	Level-3-260C-168 HR	-40 to 125	TPS 65251-2	
TPS65251-2RHAT	ACTIVE	VQFN	RHA	40	250	RoHS & Green	NIPDAU	Level-3-260C-168 HR	-40 to 125	TPS 65251-2	
TPS65251-3RHAR	ACTIVE	VQFN	RHA	40	2500	RoHS & Green	NIPDAU	Level-3-260C-168 HR	-40 to 125	TPS 65251-3	
TPS65251-3RHAT	ACTIVE	VQFN	RHA	40	250	RoHS & Green	NIPDAU	Level-3-260C-168 HR	-40 to 125	TPS 65251-3	

(1) The marketing status values are defined as follows:

ACTIVE: Product device recommended for new designs.

LIFEBUY: TI has announced that the device will be discontinued, and a lifetime-buy period is in effect.

NRND: Not recommended for new designs. Device is in production to support existing customers, but TI does not recommend using this part in a new design.

PREVIEW: Device has been announced but is not in production. Samples may or may not be available.

OBSOLETE: TI has discontinued the production of the device.

(2) **RoHS:** TI defines "RoHS" to mean semiconductor products that are compliant with the current EU RoHS requirements for all 10 RoHS substances, including the requirement that RoHS substance do not exceed 0.1% by weight in homogeneous materials. Where designed to be soldered at high temperatures, "RoHS" products are suitable for use in specified lead-free processes. TI may reference these types of products as "Pb-Free".

RoHS Exempt: TI defines "RoHS Exempt" to mean products that contain lead but are compliant with EU RoHS pursuant to a specific EU RoHS exemption.

Green: TI defines "Green" to mean the content of Chlorine (Cl) and Bromine (Br) based flame retardants meet JS709B low halogen requirements of <=1000ppm threshold. Antimony trioxide based flame retardants must also meet the <=1000ppm threshold requirement.

(3) MSL, Peak Temp. - The Moisture Sensitivity Level rating according to the JEDEC industry standard classifications, and peak solder temperature.

(4) There may be additional marking, which relates to the logo, the lot trace code information, or the environmental category on the device.

(5) Multiple Device Markings will be inside parentheses. Only one Device Marking contained in parentheses and separated by a "~" will appear on a device. If a line is indented then it is a continuation of the previous line and the two combined represent the entire Device Marking for that device.

⁽⁶⁾ Lead finish/Ball material - Orderable Devices may have multiple material finish options. Finish options are separated by a vertical ruled line. Lead finish/Ball material values may wrap to two lines if the finish value exceeds the maximum column width.

Important Information and Disclaimer:The information provided on this page represents TI's knowledge and belief as of the date that it is provided. TI bases its knowledge and belief on information provided by third parties, and makes no representation or warranty as to the accuracy of such information. Efforts are underway to better integrate information from third parties. TI has taken and continues to take reasonable steps to provide representative and accurate information but may not have conducted destructive testing or chemical analysis on incoming materials and chemicals. TI and TI suppliers consider certain information to be proprietary, and thus CAS numbers and other limited information may not be available for release.

In no event shall TI's liability arising out of such information exceed the total purchase price of the TI part(s) at issue in this document sold by TI to Customer on an annual basis.

TAPE AND REEL INFORMATION

QUADRANT ASSIGNMENTS FOR PIN 1 ORIENTATION IN TAPE

*All dimensions are nominal

Device	Package Type	Package Drawing	Pins	SPQ	Reel Diameter (mm)	Reel Width W1 (mm)	A0 (mm)	B0 (mm)	K0 (mm)	P1 (mm)	W (mm)	Pin1 Quadrant
TPS65251-1RHAR	VQFN	RHA	40	2500	330.0	16.4	6.3	6.3	1.1	12.0	16.0	Q2
TPS65251-1RHAT	VQFN	RHA	40	250	180.0	16.4	6.3	6.3	1.1	12.0	16.0	Q2
TPS65251-2RHAR	VQFN	RHA	40	2500	330.0	16.4	6.3	6.3	1.1	12.0	16.0	Q2
TPS65251-2RHAT	VQFN	RHA	40	250	180.0	16.4	6.3	6.3	1.1	12.0	16.0	Q2
TPS65251-3RHAR	VQFN	RHA	40	2500	330.0	16.4	6.3	6.3	1.1	12.0	16.0	Q2
TPS65251-3RHAT	VQFN	RHA	40	250	180.0	16.4	6.3	6.3	1.1	12.0	16.0	Q2

TAPE AND REEL BOX DIMENSIONS

*All dimensions are nominal

Device	Package Type	Package Drawing	Pins	SPQ	Length (mm)	Width (mm)	Height (mm)
TPS65251-1RHAR	VQFN	RHA	40	2500	367.0	367.0	38.0
TPS65251-1RHAT	VQFN	RHA	40	250	210.0	185.0	35.0
TPS65251-2RHAR	VQFN	RHA	40	2500	367.0	367.0	38.0
TPS65251-2RHAT	VQFN	RHA	40	250	210.0	185.0	35.0
TPS65251-3RHAR	VQFN	RHA	40	2500	367.0	367.0	38.0
TPS65251-3RHAT	VQFN	RHA	40	250	210.0	185.0	35.0

GENERIC PACKAGE VIEW

RHA 40

VQFN - 1 mm max height

6 x 6, 0.5 mm pitch

PLASTIC QUAD FLATPACK - NO LEAD

This image is a representation of the package family, actual package may vary.
Refer to the product data sheet for package details.

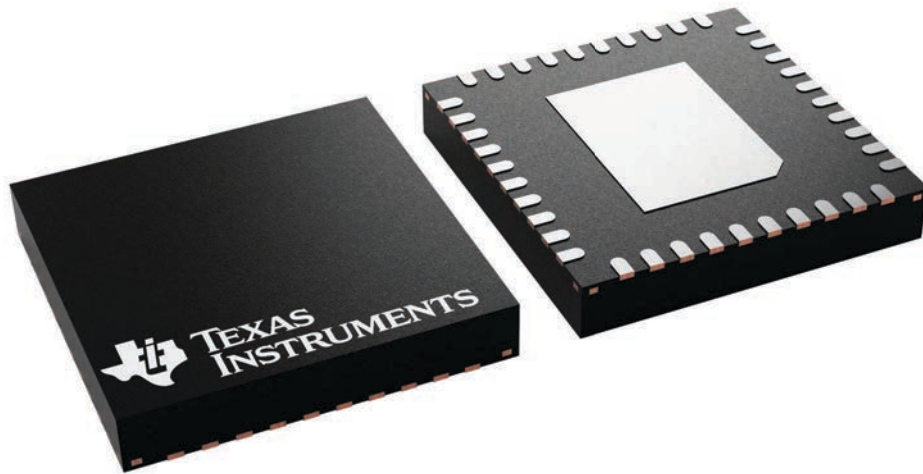

4225870/A

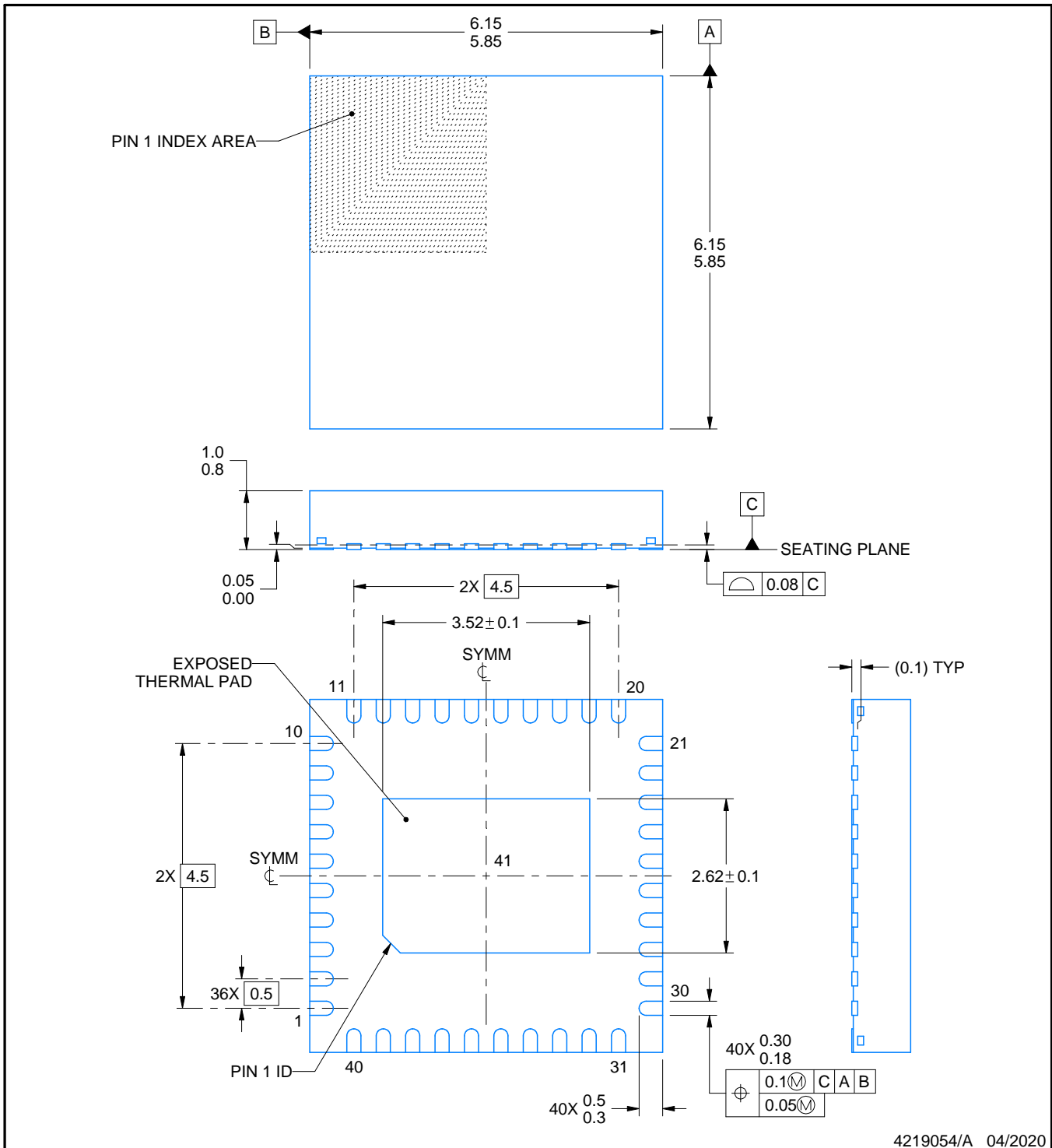
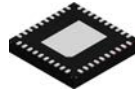

4219054/A 04/2020

NOTES:

1. All linear dimensions are in millimeters. Any dimensions in parenthesis are for reference only. Dimensioning and tolerancing per ASME Y14.5M.
2. This drawing is subject to change without notice.
3. The package thermal pad must be soldered to the printed circuit board for thermal and mechanical performance.

EXAMPLE BOARD LAYOUT

RHA0040E

VQFN - 1 mm max height

PLASTIC QUAD FLATPACK - NO LEAD

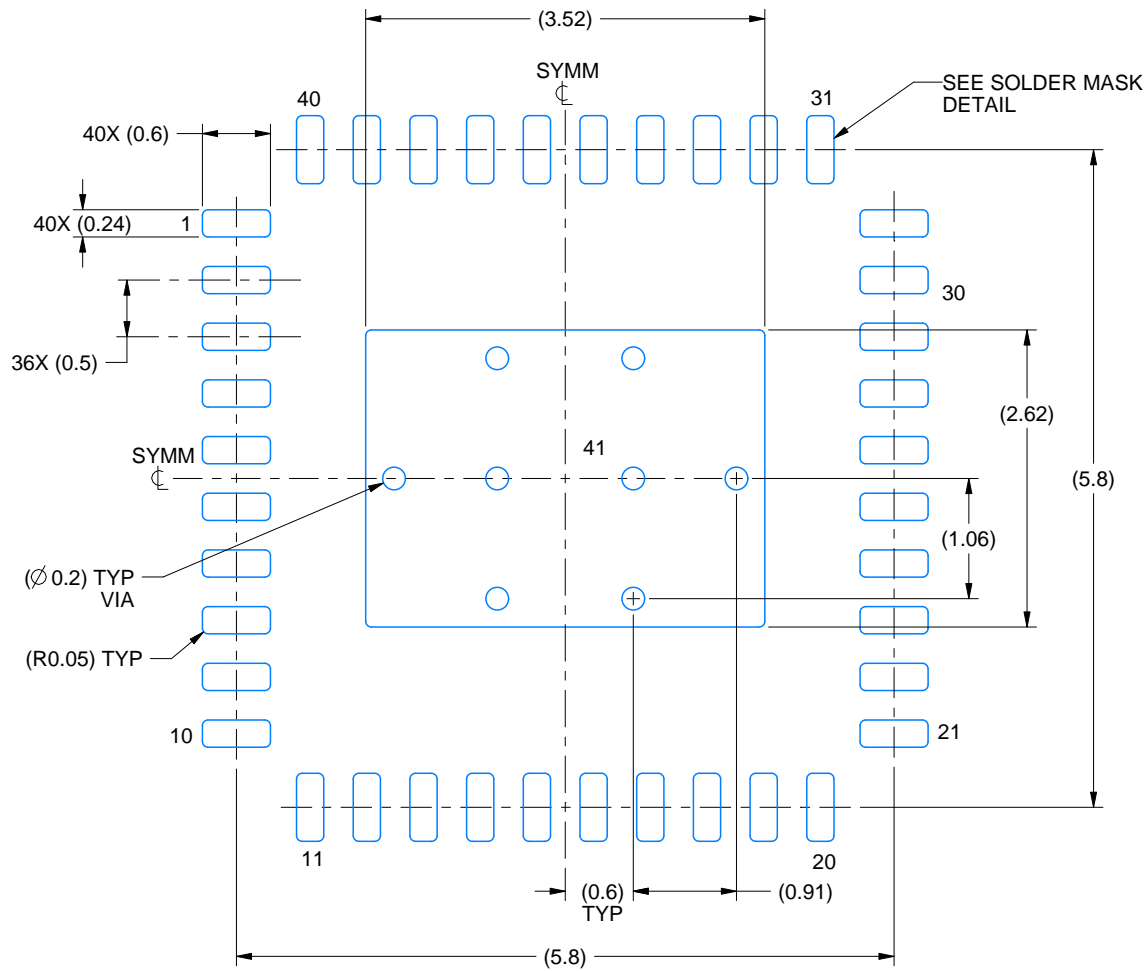

LAND PATTERN EXAMPLE
EXPOSED METAL SHOWN
SCALE: 15X

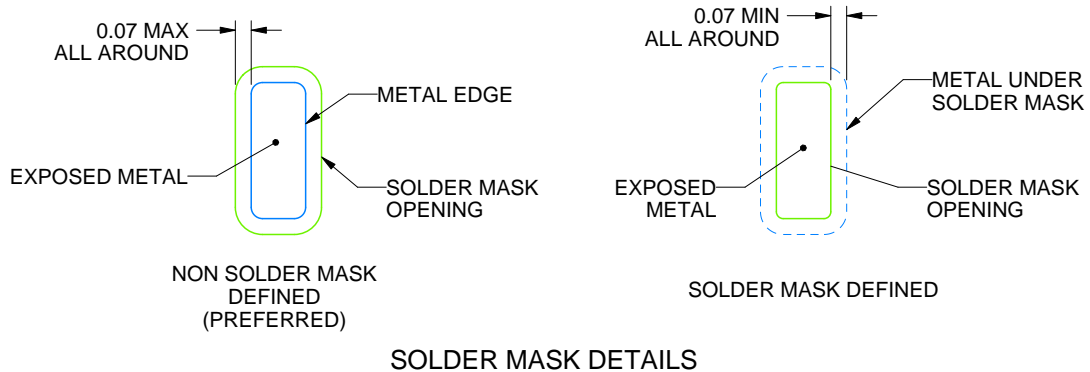

4219054/A 04/2020

NOTES: (continued)

- This package is designed to be soldered to a thermal pad on the board. For more information, see Texas Instruments literature number SLUA271 (www.ti.com/lit/slua271).
- Vias are optional depending on application, refer to device data sheet. If any vias are implemented, refer to their locations shown on this view. It is recommended that vias under paste be filled, plugged or tented.

EXAMPLE STENCIL DESIGN

RHA0040E

VQFN - 1 mm max height

PLASTIC QUAD FLATPACK - NO LEAD

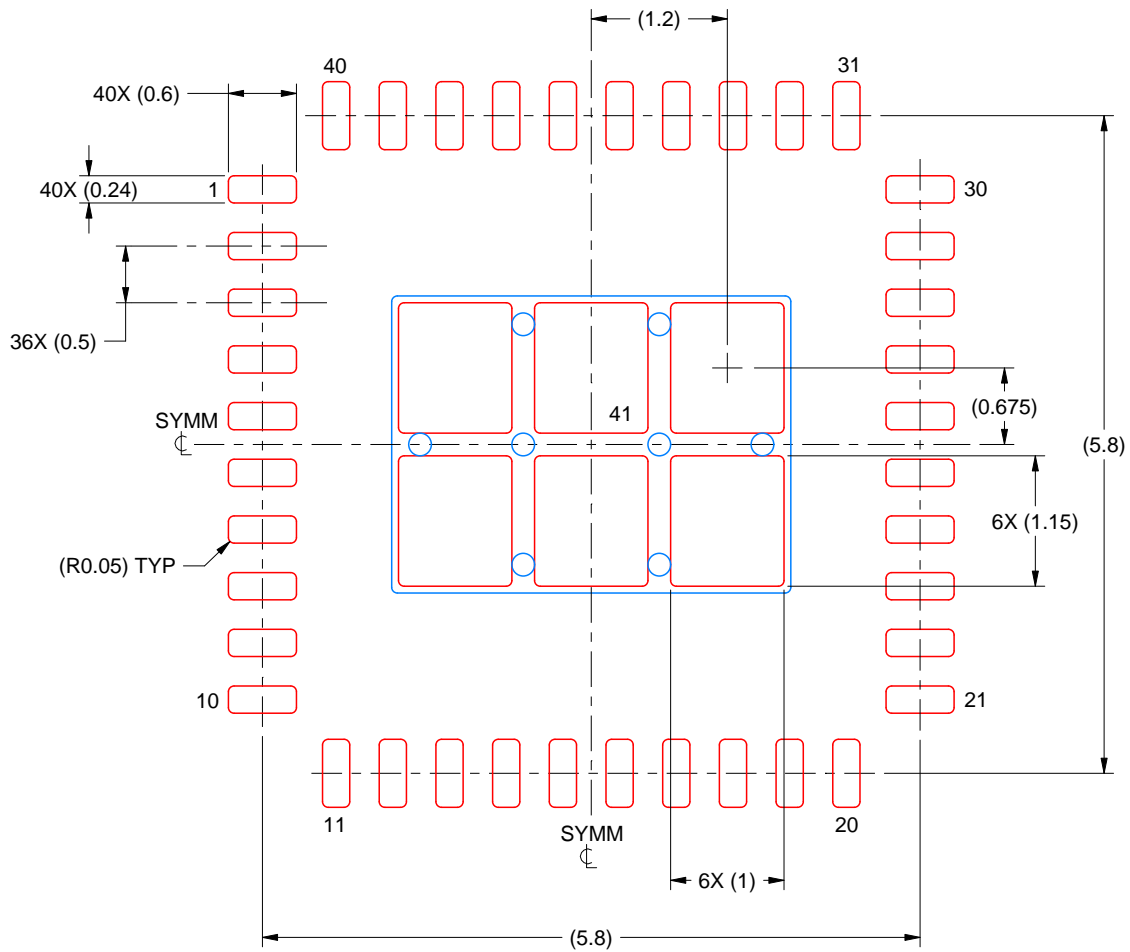

SOLDER PASTE EXAMPLE
 BASED ON 0.125 MM THICK STENCIL
 SCALE: 15X

EXPOSED PAD 41
 75% PRINTED SOLDER COVERAGE BY AREA UNDER PACKAGE

4219054/A 04/2020

NOTES: (continued)

6. Laser cutting apertures with trapezoidal walls and rounded corners may offer better paste release. IPC-7525 may have alternate design recommendations.

重要声明和免责声明

TI“按原样”提供技术和可靠性数据（包括数据表）、设计资源（包括参考设计）、应用或其他设计建议、网络工具、安全信息和其他资源，不保证没有瑕疵且不做任何明示或暗示的担保，包括但不限于对适销性、某特定用途方面的适用性或不侵犯任何第三方知识产权的暗示担保。

这些资源可供使用 TI 产品进行设计的熟练开发人员使用。您将自行承担以下全部责任：(1) 针对您的应用选择合适的 TI 产品，(2) 设计、验证并测试您的应用，(3) 确保您的应用满足相应标准以及任何其他功能安全、信息安全、监管或其他要求。

这些资源如有变更，恕不另行通知。TI 授权您仅可将这些资源用于研发本资源所述的 TI 产品的应用。严禁对这些资源进行其他复制或展示。您无权使用任何其他 TI 知识产权或任何第三方知识产权。您应全额赔偿因在这些资源的使用中对 TI 及其代表造成的任何索赔、损害、成本、损失和债务，TI 对此概不负责。

TI 提供的产品受 [TI 的销售条款](#) 或 [ti.com](#) 上其他适用条款/TI 产品随附的其他适用条款的约束。TI 提供这些资源并不会扩展或以其他方式更改 TI 针对 TI 产品发布的适用的担保或担保免责声明。

TI 反对并拒绝您可能提出的任何其他或不同的条款。

邮寄地址：Texas Instruments, Post Office Box 655303, Dallas, Texas 75265

Copyright © 2022，德州仪器 (TI) 公司