

具有精确电流监控器和快速过压保护功能的 TPS2596 2.7V 至 19V、0.125A 至 2A、89mΩ 电子保险丝

1 特性

- 宽输入电压范围：2.7V 至 19V
 - 绝对最大值为 21V
- 低导通电阻：Ron = 89mΩ（典型值）
- 带有可调节欠压锁定 (UVLO) 的高电平有效使能输入
- 可用过压保护选项：
 - 快速过压钳位（3.8V、5.7V 和 13.8V 引脚可选阈值），响应时间为 5μs（典型值）
 - 可调节过压锁定 (OVLO)，响应时间为 1.3μs（典型值）
- 配备负载电流监控器输出 (ILM) 的可调节电流限制
 - 电流范围：0.125A 至 2A
 - 电流限制准确度：
 - 整个电流范围内为 ±10.4%（最大值）
 - 在 1A 电流限制下为 ±5.5%（最大值）
- 不受电气快速瞬变干扰 (IEC 61000-4-4)
- 可调节的输出压摆率控制 (dVdt)
- 提供过热保护 (OTP)
- 故障指示引脚 (FLT)
- UL2367 认证正在处理中
- IEC 62368 CB 认证（正在申请中）
- 小尺寸：4.91mm x 3.9mm SOIC 封装

2 应用

- 能量计
- UL 60335-1 15W LPC 在电器中的应用
 - 冰箱
 - 洗碗机
 - 洗衣机和烘干机
- 机顶盒
- IP 网络摄像头

3 说明

TPS2596xx 系列 **电子保险丝**（集成式 FET 热插拔器件）是采用小型封装且高度集成的电路保护和电源管理解决方案。这些设备只需很少的外部组件即可提供多种保护模式，能够非常有效地抵御过载、短路、电压浪涌和过多浪涌电流。输出电流限制级别可通过单个外部电阻设定。还可能通过测量整个电流限制电阻的压降实现对输出负载电流的准确感应。对浪涌电流有特别要求的应用可以通过单个外部电容器设定输出转换率。对于 TPS25962x 型号，发生输入过压情况时，内部钳位电路会将输出限制在一个安全的固定最大电压（引脚可选），而无需外部组件。TPS25963x 型号使用户可以设置指定的过压截止阈值。

这些器件的额定工作结温范围为 -40°C 至 +125°C。

器件信息(1)

器件型号	封装	封装尺寸（标称值）
TPS259620DDA	SOIC (8)	4.91mm x 3.9mm
TPS259621DDA	SOIC (8)	4.91mm x 3.9mm
TPS259630DDA	SOIC (8)	4.91mm x 3.9mm
TPS259631DDA	SOIC (8)	4.91mm x 3.9mm

(1) 如需了解所有可用封装，请参阅数据表末尾的可订购产品附录。

简化原理图

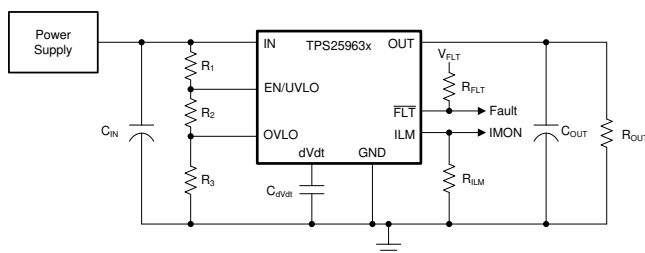

TPS25963x 1KV EFT 响应

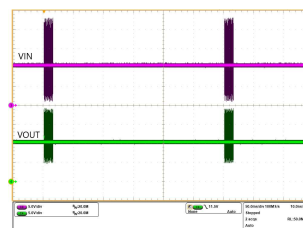

目录

1	特性	1	8.4	Device Functional Modes	25
2	应用	1	9	Application and Implementation	27
3	说明	1	9.1	Application Information	27
4	修订历史记录	2	9.2	Typical Application	27
5	器件比较表	3	9.3	System Examples	31
6	Pin Configuration and Functions	4	10	Power Supply Recommendations	34
7	Specifications	5	10.1	Transient Protection	34
7.1	Absolute Maximum Ratings	5	10.2	Output Short-Circuit Measurements	35
7.2	ESD Ratings	5	11	Layout	36
7.3	Recommended Operating Conditions	5	11.1	Layout Guidelines	36
7.4	Thermal Information	6	11.2	Layout Example	37
7.5	Electrical Characteristics	6	12	器件和文档支持	38
7.6	Timing Requirements	8	12.1	文档支持	38
7.7	Switching Characteristics	8	12.2	接收文档更新通知	38
7.8	Typical Characteristics	10	12.3	社区资源	38
8	Detailed Description	17	12.4	商标	38
8.1	Overview	17	12.5	静电放电警告	38
8.2	Functional Block Diagram	17	12.6	Glossary	38
8.3	Feature Description	18	13	机械、封装和可订购信息	38

4 修订历史记录

Changes from Original (May 2019) to Revision A

Page

•	将“预告信息”更改为“生产数据”	1
---	------------------------	----------

5 器件比较表

部件号	过压响应	热关断 (TSD) 响应
TPS259620	OVC - 3.8V、5.7V、13.8V (引脚可选)	闭锁
TPS259621	OVC - 3.8V、5.7V、13.8V (引脚可选)	自动重试
TPS259630	可调 OVLO	闭锁
TPS259631	可调 OVLO	自动重试

6 Pin Configuration and Functions

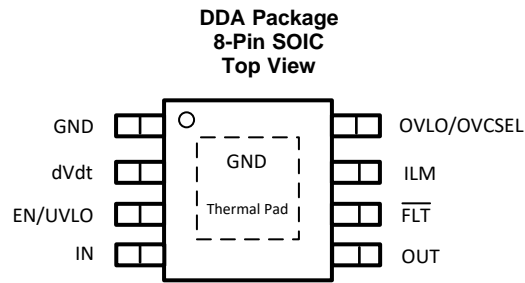

Pin Functions

PIN		I/O	DESCRIPTION
NAME	NO.		
GND	1	Ground	Ground
dVdt	2	Analog Output	A capacitor from this pin to GND sets the output turn on slew rate. Leave this pin floating for the fastest turn on slew rate.
EN/UVLO	3	Analog Input	Active High Enable for the Device. A resistor divider can be used to adjust the Undervoltage Lockout threshold. Do not leave floating.
IN	4	Power	Power Input
OUT	5	Power	Power Output
$\overline{\text{FLT}}$	6	Digital Output	Active Low indicator which will be pulled low when a fault is detected. It is an open-drain output that requires an external pull-up resistance.
ILM	7	Analog Output	This is a dual function pin used to limit and monitor the output current. An external resistor from this pin to GND sets the output current limit. The pin voltage can also be used to monitor the output load current.
OVLO	8	Analog Input	TPS25963x: A resistor divider can be used to adjust the Overvoltage Lockout threshold. Do not leave floating.
OVCSEL			TPS25962x: Overvoltage Clamp level select pin. Refer to Overvoltage Clamp for more details.
Thermal pad		Ground	The Exposed Pad is used primarily for heat dissipation and must be connected to system ground plane for best thermal performance.

7 Specifications

7.1 Absolute Maximum Ratings

over operating free-air temperature range (unless otherwise noted)⁽¹⁾

PARAMETER		PIN	MIN	MAX	UNITS
V _{IN}	Maximum Input Voltage Range	IN	-0.3	21	V
	Maximum Input Voltage Range (T _A = 25 °C)			22	V
V _{OUT}	Maximum Output Voltage Range	OUT	-0.3	min (21, V _{IN} + 0.3)	V
V _{EN/UVLO}	Maximum Enable Pin Voltage Range	EN/UVLO	-0.3	7	V
V _{OV}	Maximum OVCSEL/OVLO Pin Voltage Range	OVCSEL/OVLO	-0.3	7	V
V _{dVdT}	Maximum dVdT Pin Voltage Range	DVDT		2.5	V
V _{FLTB}	Maximum FLTB Pin Voltage Range	$\overline{\text{FLT}}$	-0.3	7	V
I _{FLTB}	Maximum FLTB Pin Sink Current	$\overline{\text{FLT}}$		10	mA
I _{MAX}	Maximum Continuous Switch Current	IN to OUT	Internally Limited		A
T _J	Junction temperature		Internally Limited		°C
T _{LEAD}	Maximum Lead Temperature			300	°C
T _{stg}	Storage temperature		-65	150	°C

- (1) Stresses beyond those listed under *Absolute Maximum Rating* may cause permanent damage to the device. These are stress ratings only, which do not imply functional operation of the device at these or any other conditions beyond those indicated under *Recommended Operating Condition*. Exposure to absolute-maximum-rated conditions for extended periods may affect device reliability.

7.2 ESD Ratings

			VALUE	UNIT
V _(ESD)	Electrostatic discharge	Human body model (HBM), per ANSI/ESDA/JEDEC JS-001, all pins ⁽¹⁾	±2000	V
		Charged device model (CDM), per JEDEC specification JESD22-C101, all pins ⁽²⁾	±500	

- (1) JEDEC document JEP155 states that 500-V HBM allows safe manufacturing with a standard ESD control process.
(2) JEDEC document JEP157 states that 250-V CDM allows safe manufacturing with a standard ESD control process.

7.3 Recommended Operating Conditions

over operating free-air temperature range (unless otherwise noted)

PARAMETER		PIN	MIN	MAX	UNITS
V _{IN}	Input Voltage Range	IN	2.7	19 ⁽¹⁾	V
V _{OUT}	Output Voltage Range	OUT		V _{IN} + 0.3	V
V _{EN/UVLO}	Enable Pin Voltage Range	EN/UVLO		6 ⁽²⁾	V
V _{OV}	OVLO Pin Voltage Range (TPS25963x Only)	OVLO	0.5	2	V
V _{dVdT}	dVdT Pin Capacitor Voltage Rating	DVDT	4		V
V _{FLTB}	FLTB Pin Voltage Range	$\overline{\text{FLT}}$		6	V
R _{ILM}	ILM Pin Resistance	ILM	453	7869	Ω
I _{MAX}	Continuous Switch Current	IN to OUT		2	A
T _J	Junction temperature		-40	125	°C

- (1) For TPS25962x, the input voltage should be limited to the selected Output Voltage Clamp Option as listed in the Electrical Characteristics section
(2) For supply voltages below 6V, it is okay to pull up the EN pin to IN through a resistor of 100 kΩ or higher. For supply voltages greater than 6V, it is recommended to use an appropriate resistor divider between IN, EN and GND to ensure the voltage at the EN pin is within the specified limits.

7.4 Thermal Information

THERMAL METRIC ⁽¹⁾		TPS2596X	
		DDA (SOIC-EP)	
		8 PINS	
			UNIT
R _{θJA}	Junction-to-ambient thermal resistance	52.7 ⁽²⁾	°C/W
R _{θJA}	Junction-to-ambient thermal resistance	119.8 ⁽³⁾	°C/W
Ψ _{JT}	Junction-to-top characterization parameter	8.9 ⁽²⁾	°C/W
Ψ _{JT}	Junction-to-top characterization parameter	17.5 ⁽³⁾	°C/W
Ψ _{JB}	Junction-to-board characterization parameter	27.1 ⁽²⁾	°C/W
Ψ _{JB}	Junction-to-board characterization parameter	68.1 ⁽³⁾	°C/W

(1) For more information about traditional and new thermal metrics, see the [Semiconductor and IC Package Thermal Metrics](#) application report.

(2) With exposed pad soldered to PCB

(3) Without exposed pad soldered to PCB

7.5 Electrical Characteristics

(Test conditions unless otherwise noted) $-40^{\circ}\text{C} \leq T_J \leq 125^{\circ}\text{C}$, $V_{IN} = 12\text{ V}$, $R_{ILM} = 453\ \Omega$, $C_{dvdT} = \text{Open}$, $\text{OUT} = \text{Open}$. All voltages referenced to GND.

PARAMETER		TEST CONDITIONS	MIN	TYP	MAX	UNITS
INPUT SUPPLY (IN)						
I _Q	IN quiescent current	TPS25963x		193	259	μA
		TPS25962x		206	266	μA
I _{SD}	IN Shutdown Current	V _{IN} < 4 V, V _{EN/UVLO} < V _{SD}			0.1	μA
		V _{IN} ≥ 4 V, V _{EN/UVLO} < V _{SD}		0.4	1.132	μA
V _{UVP(R)}	IN Undervoltage Protection threshold	V _{IN} Rising	2.46	2.53	2.58	V
V _{UVP(F)}		V _{IN} Falling	2.36	2.42	2.46	V
	IN Undervoltage Protection Hysteresis			110		mV
OUTPUT VOLTAGE CLAMP (OUT) - TPS25962X						
V _{OVc}	Overvoltage Clamp Threshold	R _{OVcSEL} = Short to GND, R _{OUT} = 10 KΩ	3.75	3.83	3.92	V
		R _{OVcSEL} = 400 KΩ to GND, R _{OUT} = 10 KΩ	5.54	5.69	5.83	V
		R _{OVcSEL} = OPEN, R _{OUT} = 10 KΩ	12.97	13.77	14.52	V
V _{CLAMP}	Output Voltage During Clamping	R _{OVcSEL} = Short to GND, I _{OUT} = 10 mA	3.47	3.59	3.7	V
		R _{OVcSEL} = 400 KΩ to GND, I _{OUT} = 10 mA	5.28	5.45	5.61	V
		R _{OVcSEL} = OPEN, I _{OUT} = 10 mA	13.13	13.58	13.97	V
OUTPUT CURRENT LIMIT AND MONITOR (ILM)						
G _{IMON}	Current monitor gain as measured on ILM pin (I _{ILM} / I _{OUT})	I _{OUT} = 0.13 A	531.22	653.21	800.00	μA/A
		I _{OUT} = 2 A	635.77	657.15	684.05	μA/A
I _{ILM}	I _{OUT} Current Limit	R _{ILM} = 7.87 KΩ, V _{DS} = 0.5 V, $-40^{\circ}\text{C} \leq T_A \leq 80^{\circ}\text{C}$	0.113	0.125	0.139	A
		R _{ILM} = 3.83 KΩ, V _{DS} = 0.5 V	0.224	0.247	0.269	A
		R _{ILM} = 909 Ω, V _{DS} = 0.5 V	0.949	1.005	1.051	A
		R _{ILM} = 453 Ω, V _{DS} = 0.5 V	1.83	2.004	2.147	A
		R _{ILM} = OPEN		0		A
I _{CB}	I _{OUT} Circuit Breaker Threshold during R _{ILM} Short condition	R _{ILM} = Short to GND (Single Point Failure Test IEC 62368-1)			1.5	A

Electrical Characteristics (continued)

(Test conditions unless otherwise noted) $-40^{\circ}\text{C} \leq T_J \leq 125^{\circ}\text{C}$, $V_{\text{IN}} = 12\text{ V}$, $R_{\text{ILM}} = 453\ \Omega$, $C_{\text{dVdT}} = \text{Open}$, $\text{OUT} = \text{Open}$. All voltages referenced to GND.

PARAMETER		TEST CONDITIONS	MIN	TYP	MAX	UNITS	
ON-RESISTANCE (IN TO OUT)							
R_{ON}	ON State Resistance	$V_{\text{IN}} < 4\text{ V}$, $I_{\text{OUT}} = 0.2\text{ A}$, $T_J = 25^{\circ}\text{C}$		97	99.8	m Ω	
		$V_{\text{IN}} < 4\text{ V}$, $I_{\text{OUT}} = 0.2\text{ A}$, $T_J = -40\text{ to }85^{\circ}\text{C}$			125.4	m Ω	
		$V_{\text{IN}} < 4\text{ V}$, $I_{\text{OUT}} = 0.2\text{ A}$, $T_J = -40\text{ to }125^{\circ}\text{C}$				143.4	m Ω
		$V_{\text{IN}} > 4\text{ V}$, $I_{\text{OUT}} = 0.2\text{ A}$, $T_J = 25^{\circ}\text{C}$		89	92.6	m Ω	
		$V_{\text{IN}} > 4\text{ V}$, $I_{\text{OUT}} = 0.2\text{ A}$, $T_J = -40\text{ to }85^{\circ}\text{C}$				115.3	m Ω
		$V_{\text{IN}} > 4\text{ V}$, $I_{\text{OUT}} = 0.2\text{ A}$, $T_J = -40\text{ to }125^{\circ}\text{C}$				131	m Ω
ENABLE/UNDERVOLTAGE LOCK OUT (EN/UVLO)							
$V_{\text{UVLO(R)}}$	UVLO Threshold	V_{EN} Rising	1.18	1.2	1.22	V	
$V_{\text{UVLO(F)}}$		V_{EN} Falling	1.08	1.1	1.13	V	
	UVLO Hysteresis			95		mV	
V_{SD}	V_{EN} threshold for lowest shutdown current	V_{EN} Falling	0.53		1.05	V	
I_{ENLKG}	EN leakage current		-0.1		0.1	μA	
OVERVOLTAGE LOCKOUT (OVLO) - TPS25963X							
$V_{\text{OVLO(R)}}$	OVLO Threshold	V_{OVLO} Rising	1.17	1.2	1.22	V	
$V_{\text{OVLO(F)}}$		V_{OVLO} Falling	1.08	1.1	1.13	V	
	OVLO Hysteresis			95		mV	
I_{OVLKG}	OVLO pin leakage current	$0.5 \leq V_{\text{OVLO}} \leq 1.5\text{V}$	-0.1		0.1	μA	
FAULT INDICATION (FLT)							
R_{FLTB}	$\overline{\text{FLT}}$ Internal Pull-down resistance	$\overline{\text{FLT}}$ asserted		11.52		Ω	
I_{FLTLKG}	$\overline{\text{FLT}}$ pin leakage current	$\overline{\text{FLT}}$ de-asserted, pull-up voltage 6 V	-1		1	μA	
OVERTEMPERATURE PROTECTION (OTP)							
TSD	Thermal Shutdown Rising Threshold	T_J Rising		157		$^{\circ}\text{C}$	
TSD _{HYS}	Thermal Shutdown Hysteresis	T_J Falling		11.5		$^{\circ}\text{C}$	
DVDT							
I_{DVDT}	dVdt Pin Charging Current		1.89	2.11	2.33	μA	
G_{DVDT}	DVDT gain		20.31	20.93	21.5	V	

7.6 Timing Requirements

Typical Values are taken at $T_J = 25^\circ\text{C}$ unless specifically noted otherwise.

PARAMETER	TEST CONDITIONS	MIN	TYP	MAX	UNITS
t_{LIM}	Current limit response time $I_{OUT} > 20\%$ over I_{LIM} to $I_{OUT} \leq I_{LIM}$		87		μs
t_{SC}	Short circuit response time $V_{OUT} \downarrow$ to $I_{OUT} \leq I_{LIM}$		5		μs
t_{OVLO}	Overvoltage lockout response time TPS25963x Only		1.3		μs
t_{OVC}	Output clamp response time TPS25962x Only, $I_{OUT} = 2\text{ A}$		5		μs
$t_{TSD,RST}$	Thermal Shutdown Auto-Retry Interval TPS2596x1 Only		95		ms

7.7 Switching Characteristics

The output rising slew rate is internally controlled and constant across the entire operating voltage range to ensure the turn-on timing is not affected by the load conditions. The rising slew rate can be adjusted by adding capacitance from the dVdt pin to ground. As C_{dVdt} is increased, it will slow the rising slew rate (SR). See Slew Rate and Inrush Current Control (dVdt) section for more details. The fall time, however, is dependent on the RC time constant of the load capacitance (C_{OUT}) and Load Resistance (R_L). The Switching Characteristics are only valid for the power-up sequence where the supply is available in steady state condition and the load voltage is completely discharged before the device is enabled. Typical Values are taken at $T_J = 25^\circ\text{C}$ unless specifically noted otherwise. $R_{OUT} = 100\ \Omega$, $C_{OUT} = 1\ \mu\text{F}$.

PARAMETER		V_{IN}	$C_{dVdt} = \text{Open}$	$C_{dVdt} = 3300\text{pF}$	UNIT
SR_{ON}	Output Rising slew rate	2.7 V	28.9	12.1	V/ms
		5 V	42.7	13.1	
		12 V	75.1	13.6	
$t_{D,ON}$	Turn on delay	2.7 V	77.5	216.5	μs
		5 V	78.9	247.3	
		12 V	82.9	314.9	
t_R	Rise time	2.7 V	74.7	182.4	μs
		5 V	94.1	311.0	
		12 V	128.4	707.8	
t_{ON}	Turn on time	2.7 V	152.2	398.9	μs
		5 V	173	558.4	
		12 V	211.3	1022.7	
$t_{D,OFF}$	Turn off delay	2.7 V	12.2	12.3	μs
		5 V	11.6	11.9	
		12 V	10.3	10.4	



图 1. TPS2596xx Switching Times

7.8 Typical Characteristics



图 2. TPS25963x Quiescent Current

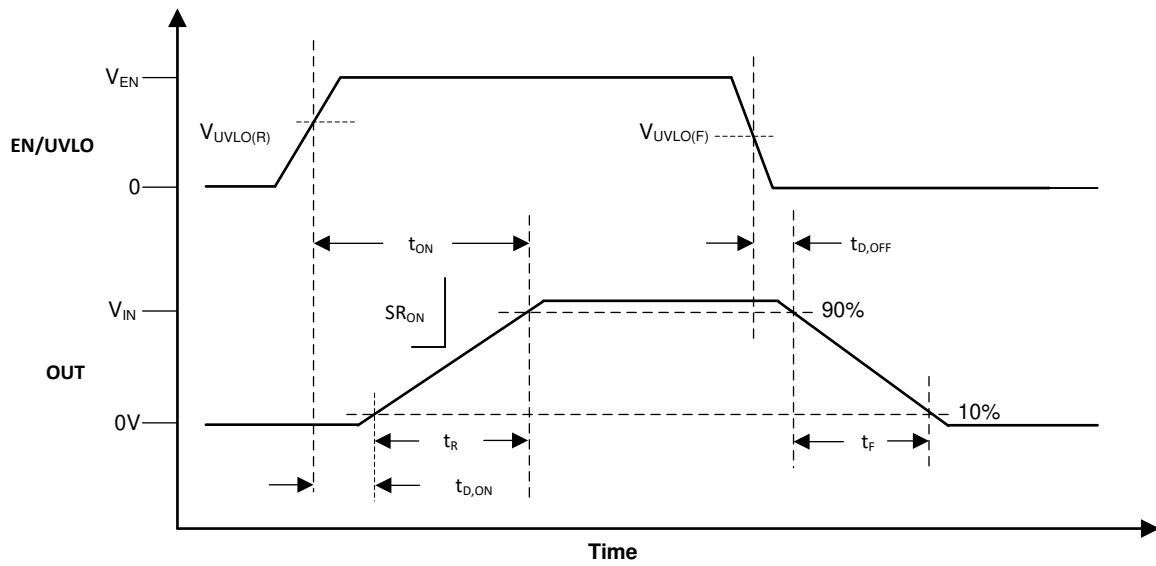

图 3. TPS25962x Quiescent Current

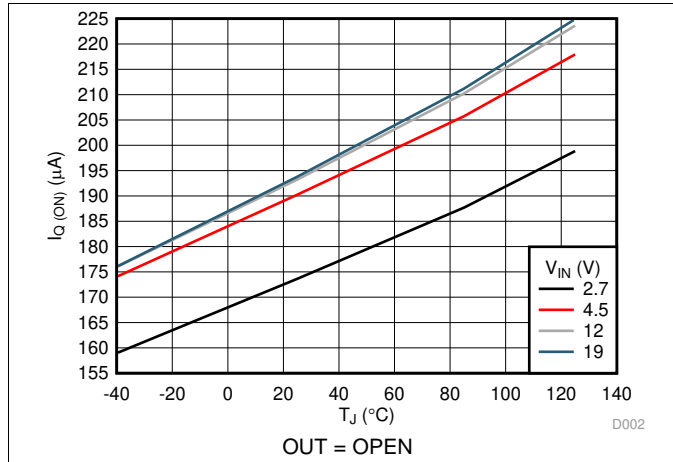

图 4. TPS25962x Quiescent Current During Overtoltage Clamping

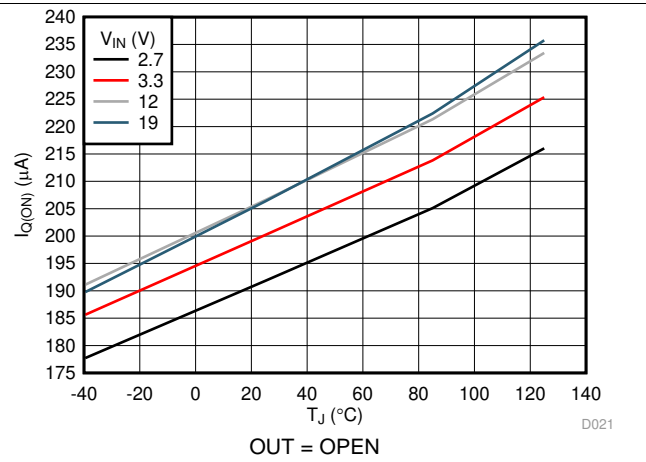

图 5. Disabled State Current

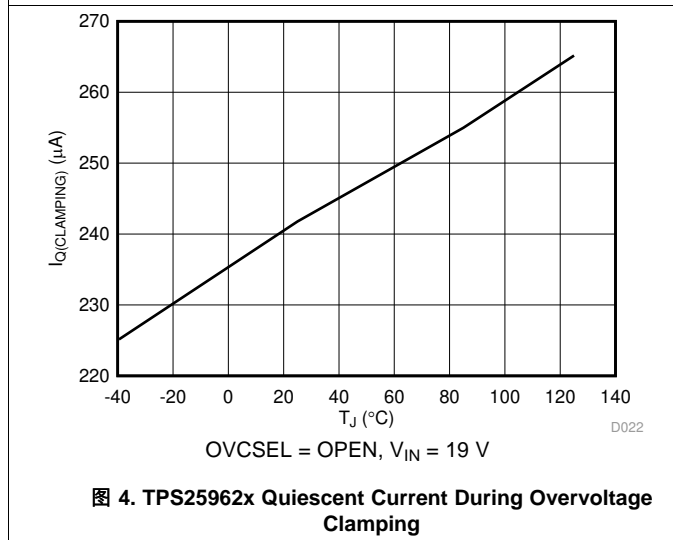

图 6. Shutdown Current

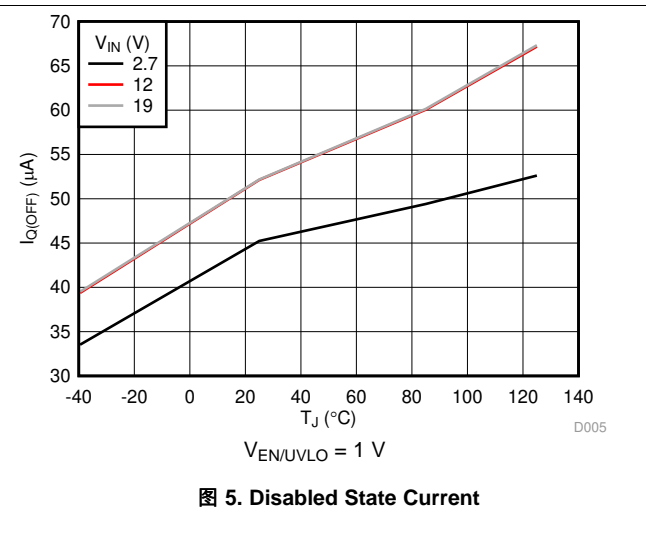

图 7. ON Resistance

Typical Characteristics (接下页)

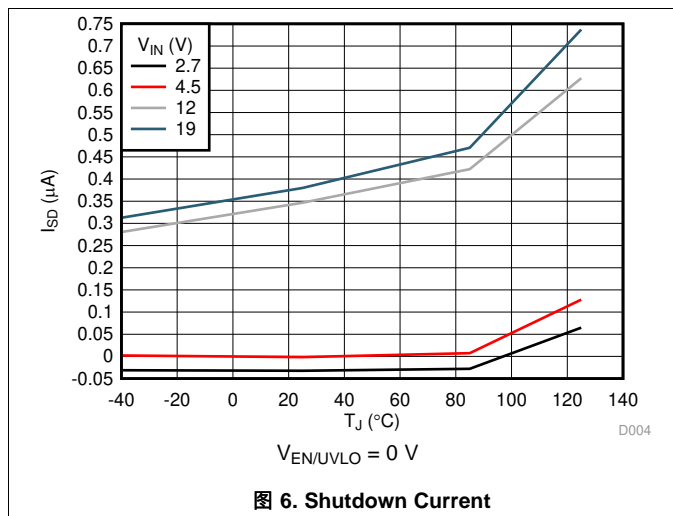

Typical Characteristics (接下页)

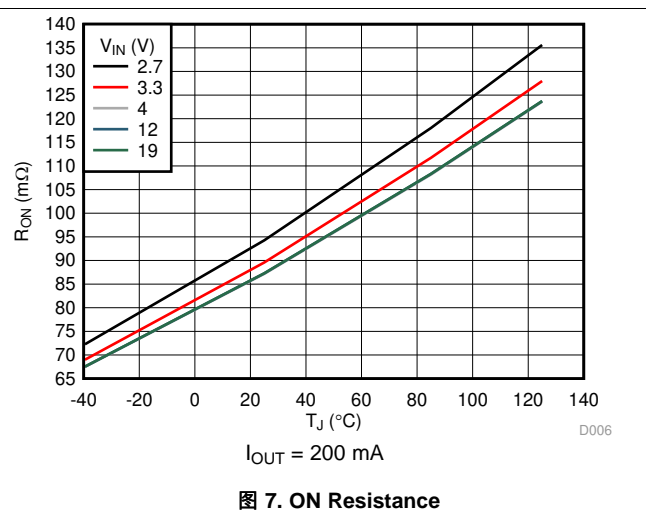
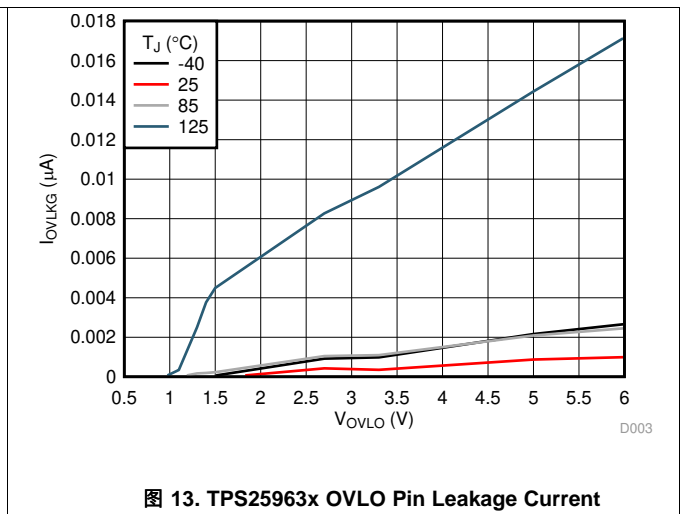
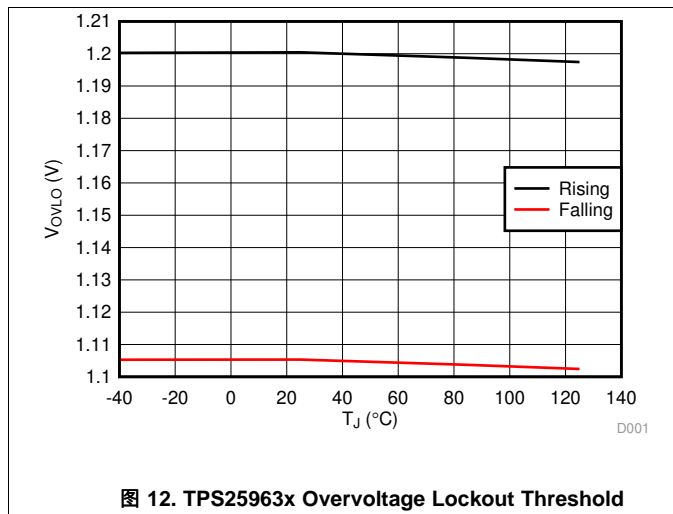
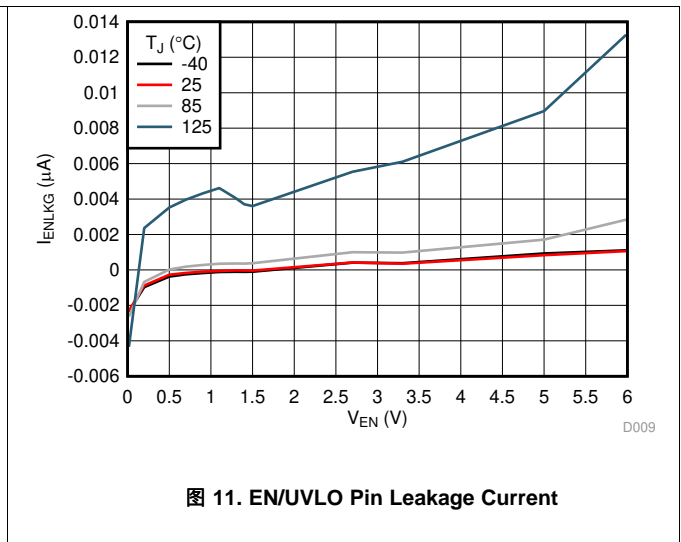
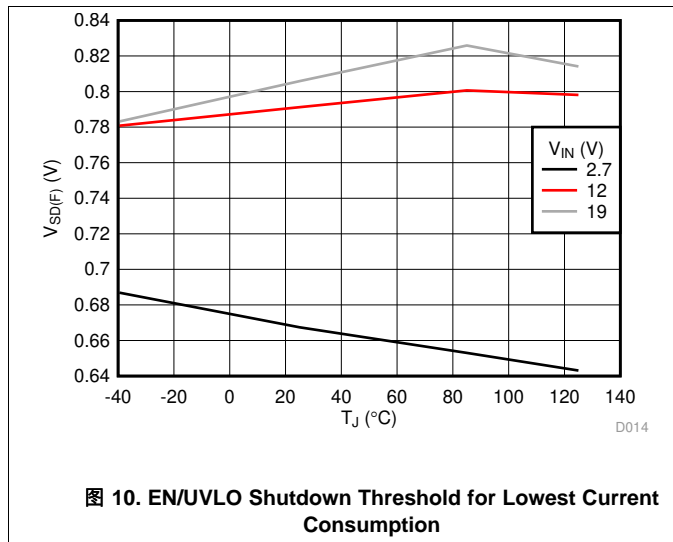
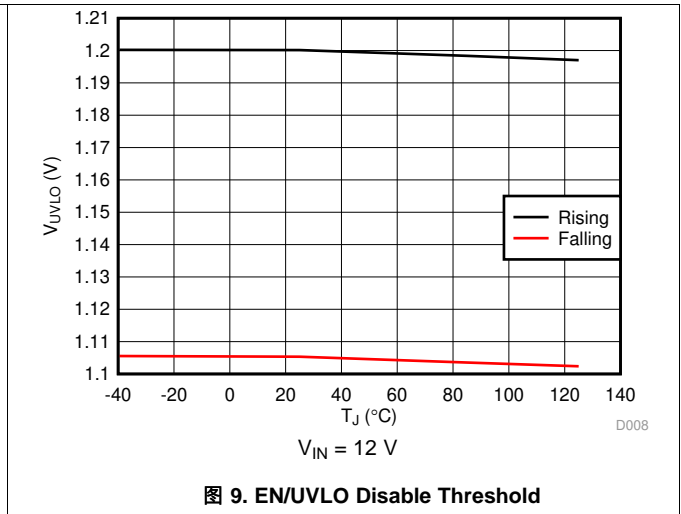
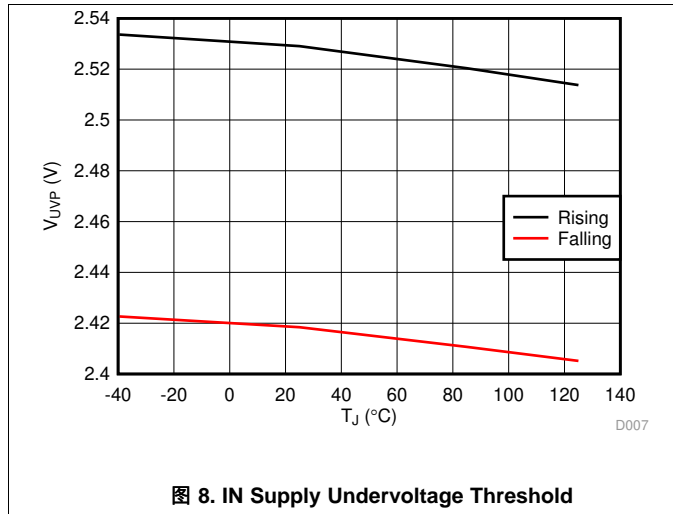

图 14. TPS25962x Overvoltage Clamp Threshold



图 15. TPS25962x Overvoltage Clamping Voltage

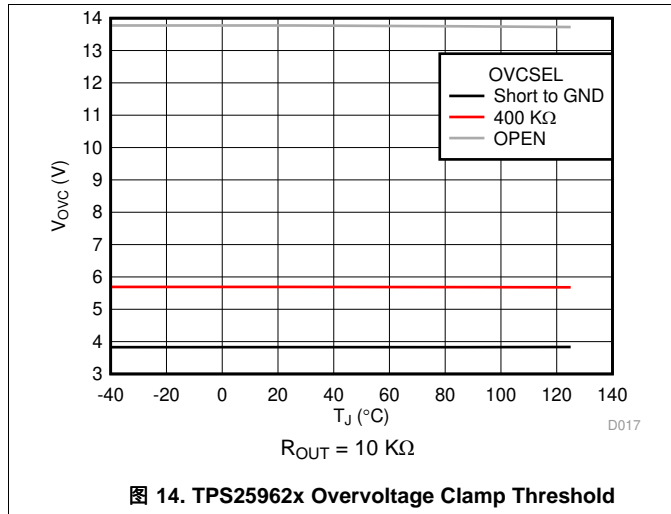

图 16. TPS25962x Overvoltage Clamping Voltage

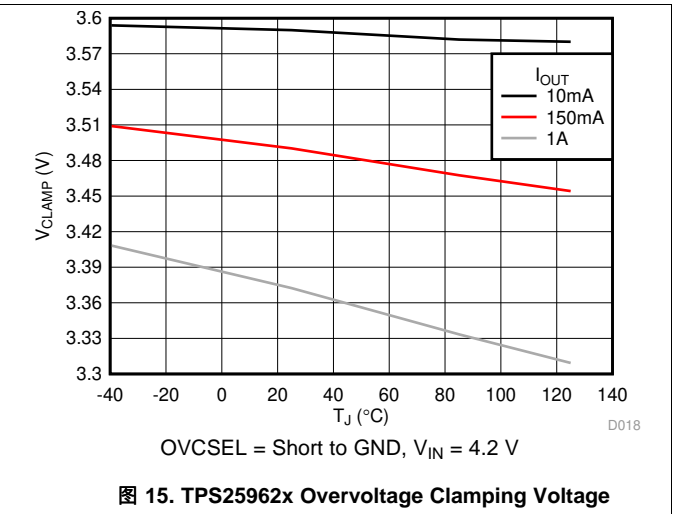

图 17. TPS25962x Overvoltage Clamping Voltage

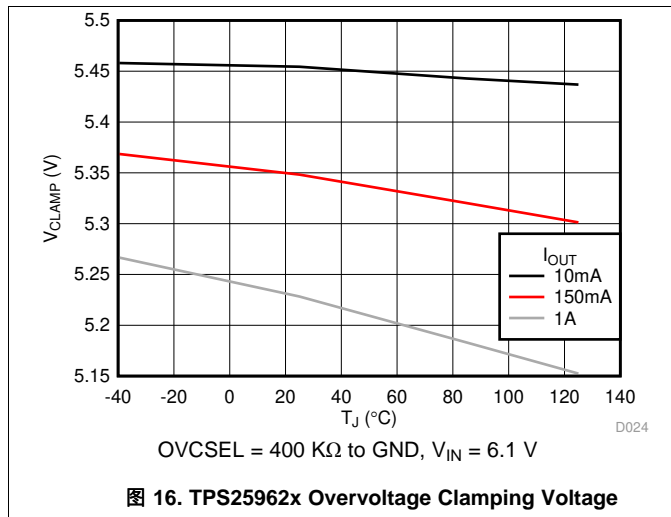

图 18. DVDT Charging Current

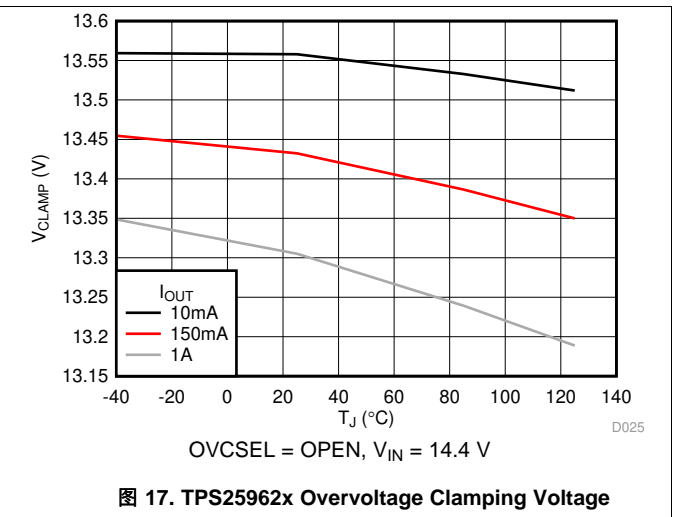

图 19. DVDT Gain

Typical Characteristics (接下页)

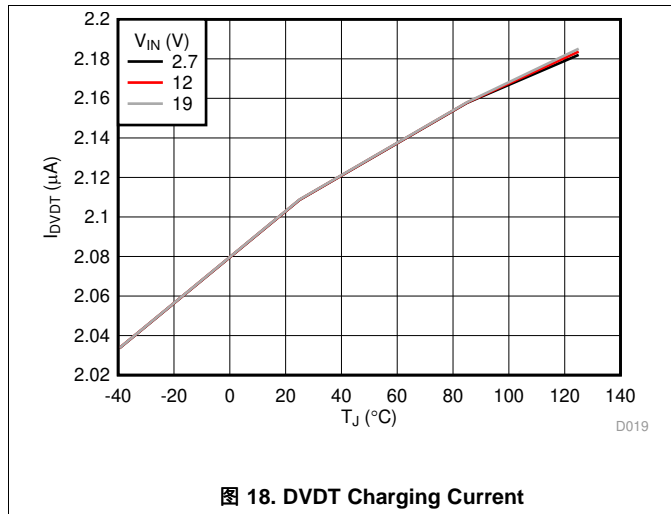

Typical Characteristics (接下页)

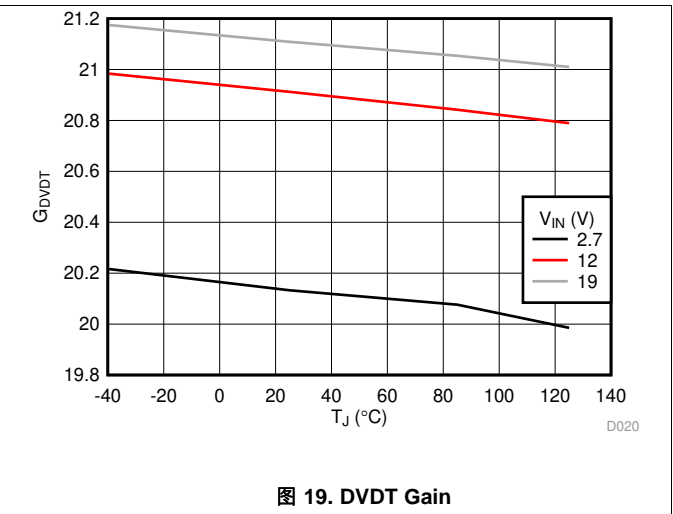
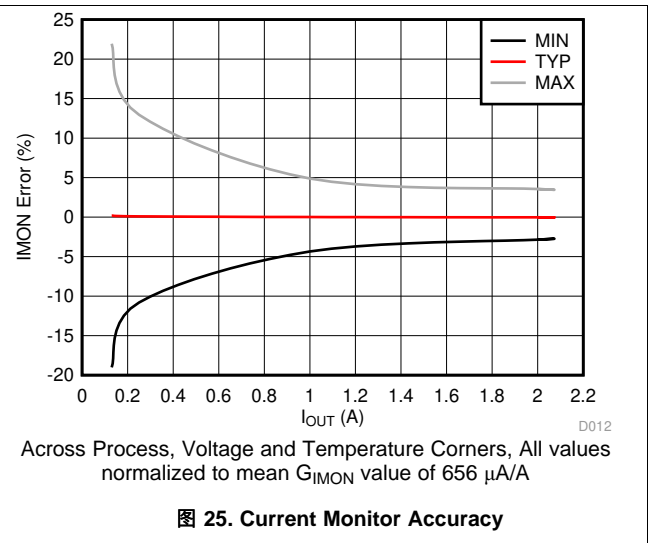
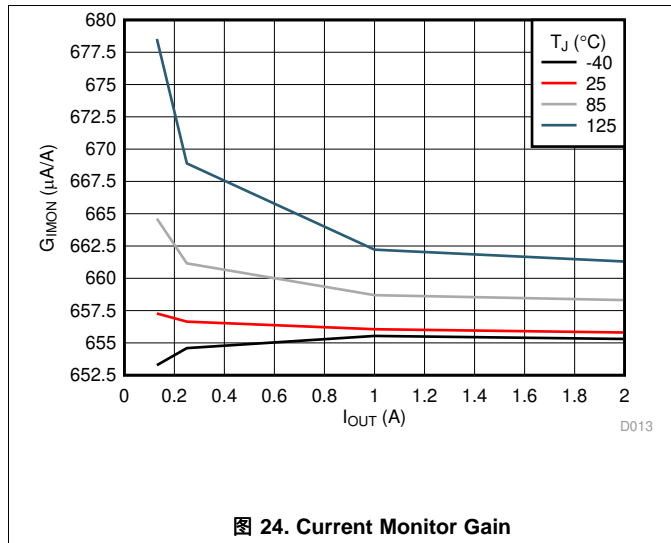
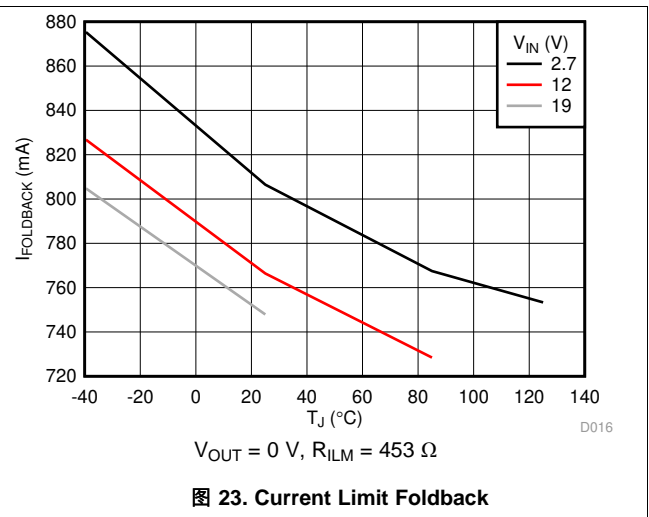
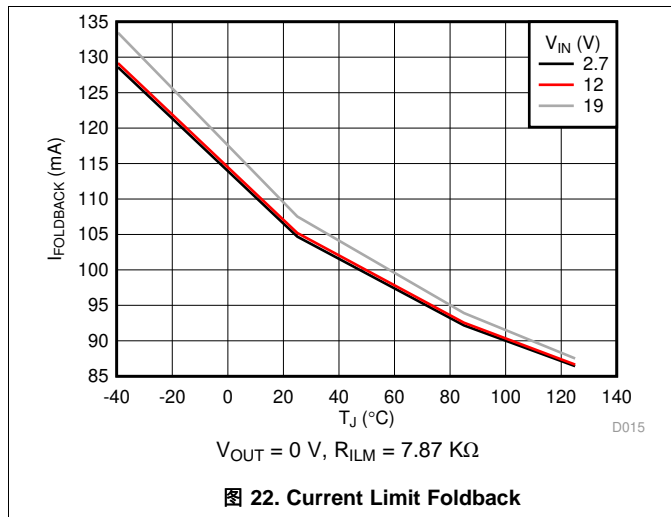
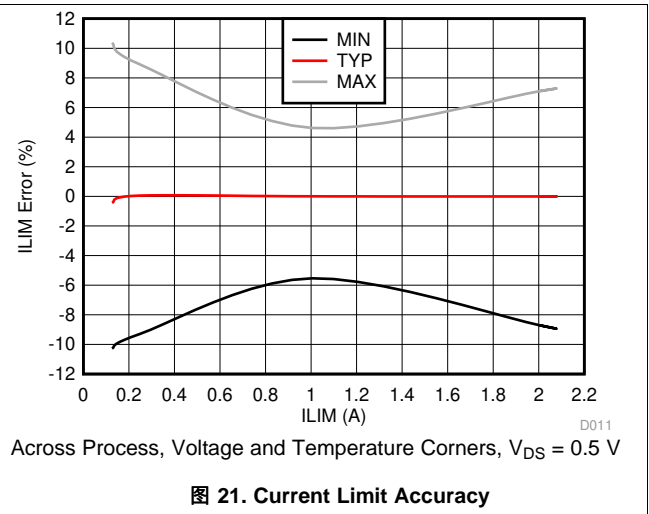
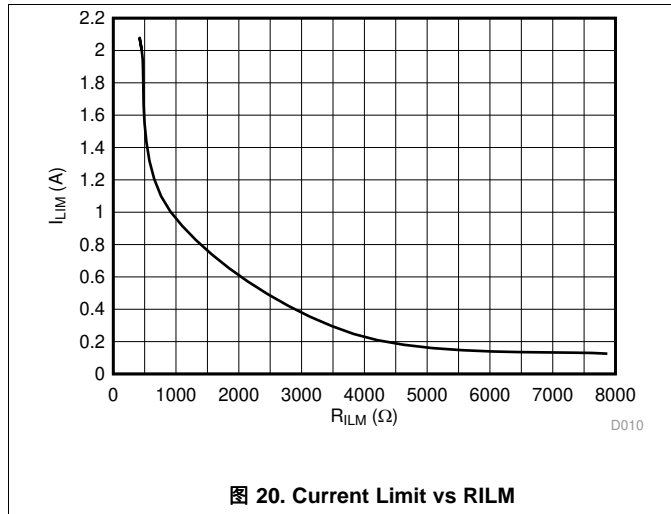
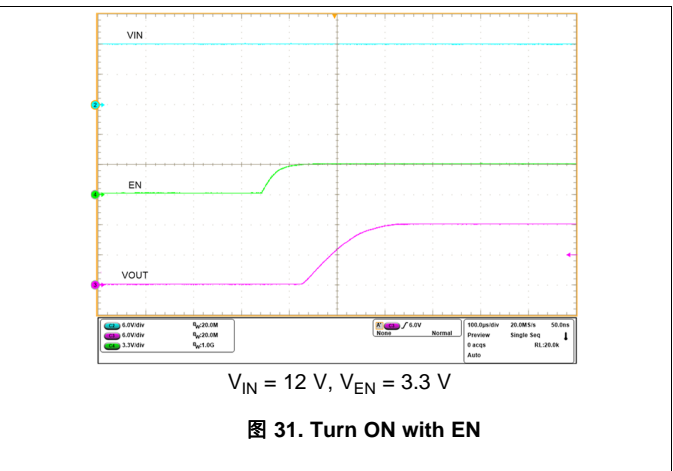
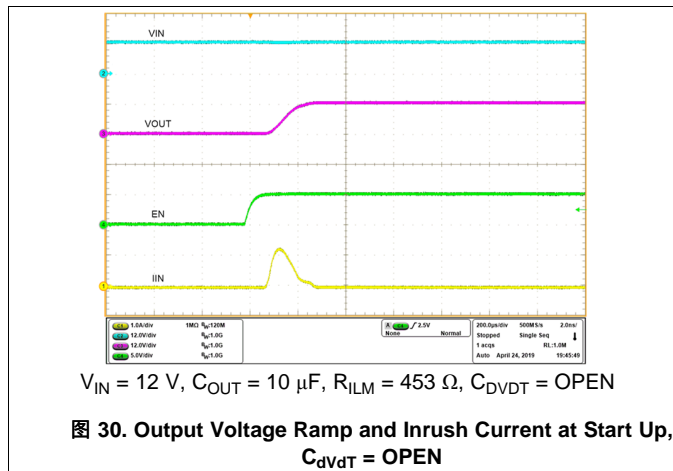
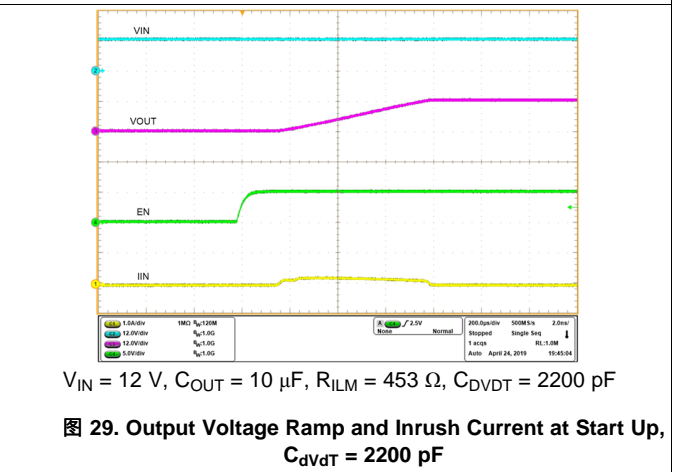
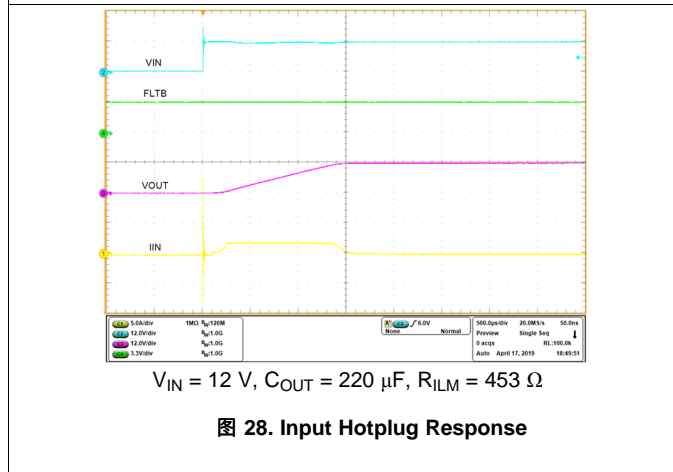
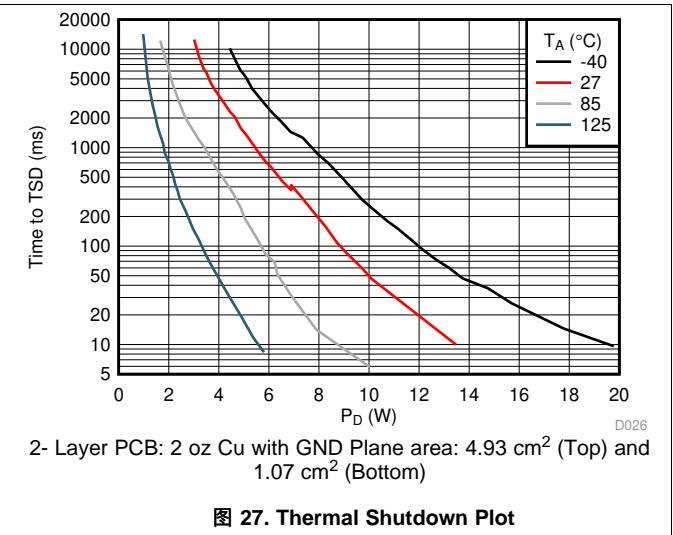
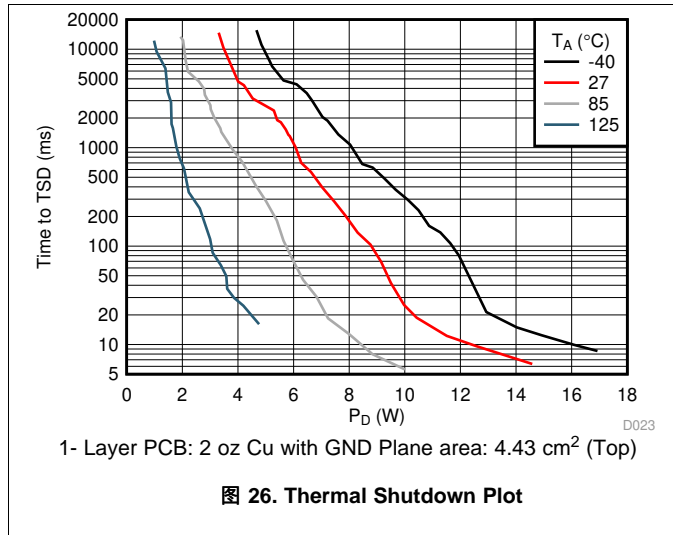

Typical Characteristics (接下页)

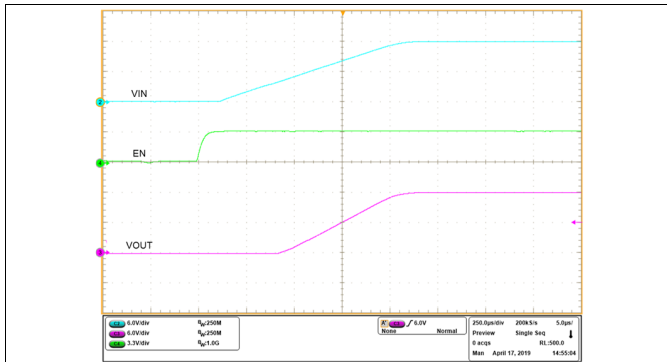

$V_{IN} = 12\text{ V}$, $V_{EN} = 3.3\text{ V}$

图 32. Turn ON with VIN

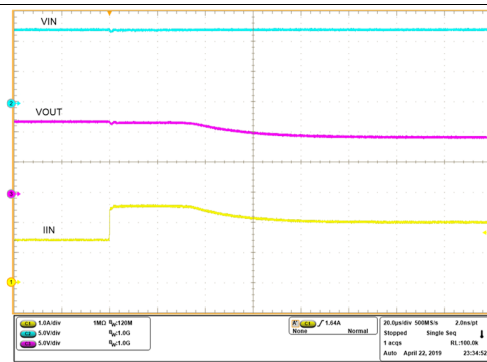

$V_{IN} = 12\text{ V}$, $R_{ILM} = 453\ \Omega$, R_{OUT} Varied From $8.33\ \Omega$ to $4.54\ \Omega$

图 33. Overcurrent Response

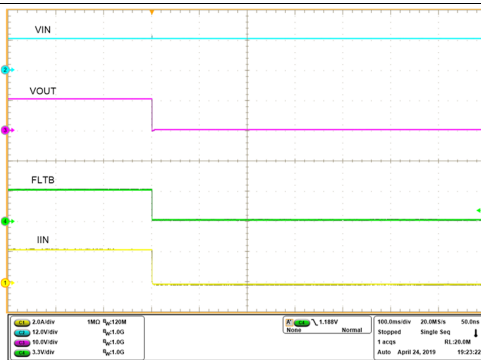

$V_{IN} = 12\text{ V}$, $R_{ILM} = 453\ \Omega$, $R_{OUT} = 5\ \Omega$

图 34. Thermal Shutdown Latch-off Response - TPS2596x0

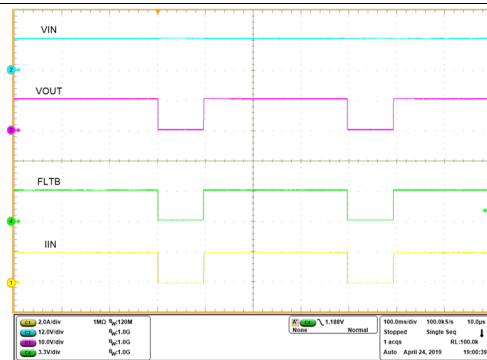

$V_{IN} = 12\text{ V}$, $R_{ILM} = 453\ \Omega$, $R_{OUT} = 5\ \Omega$

图 35. Thermal Shutdown Auto-Retry Response - TPS2596x1

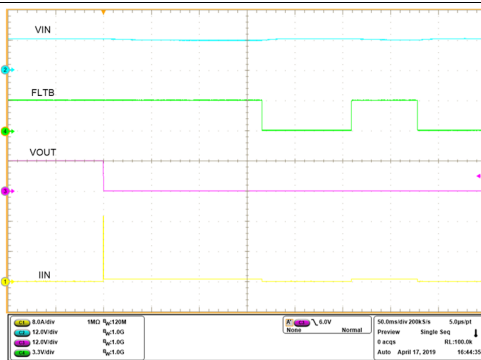

$V_{IN} = 12\text{ V}$, $R_{ILM} = 453\ \Omega$

图 36. Short-Circuit While ON Response

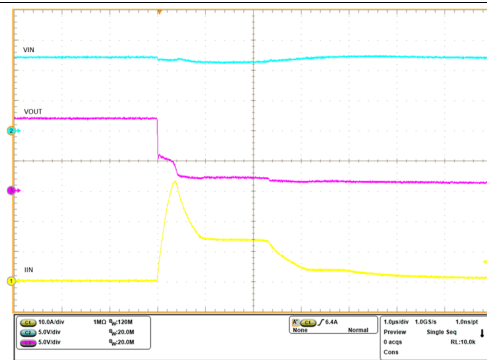

$V_{IN} = 12\text{ V}$, $R_{ILM} = 453\ \Omega$

图 37. Short-Circuit While ON Response (Zoomed In)

Typical Characteristics (接下页)



图 38. Power Up Into Short-Circuit



图 39. Power Up Into Short-Circuit (Zoomed In)

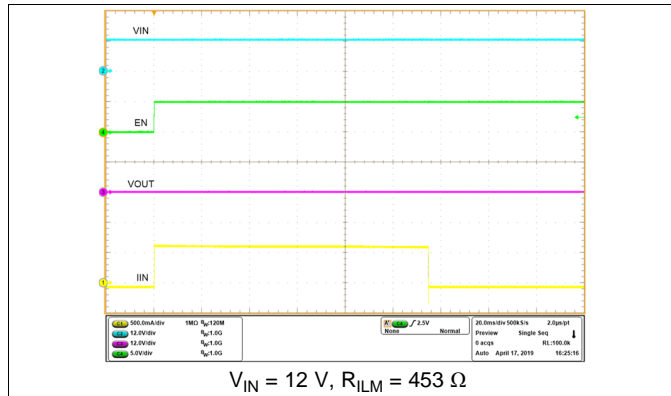

图 40. TPS25963x Overvoltage Lockout Response

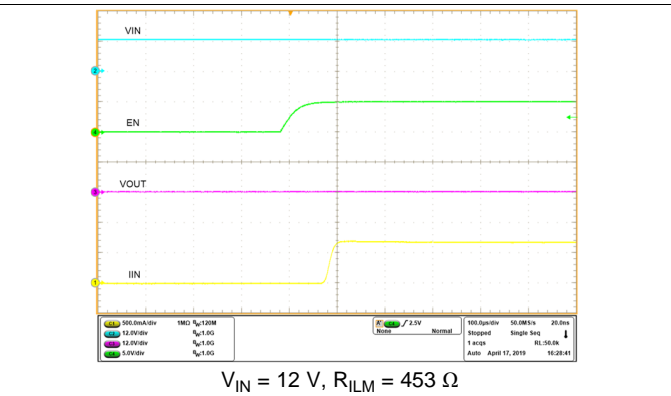

图 41. TPS25962x Overvoltage Clamp Response

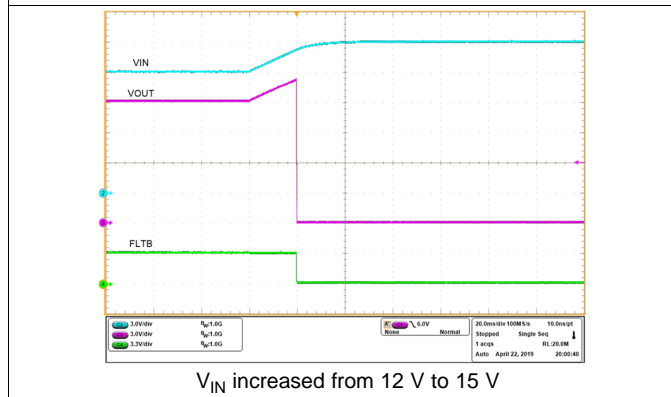

图 42. TPS25962x Overvoltage Clamp Response

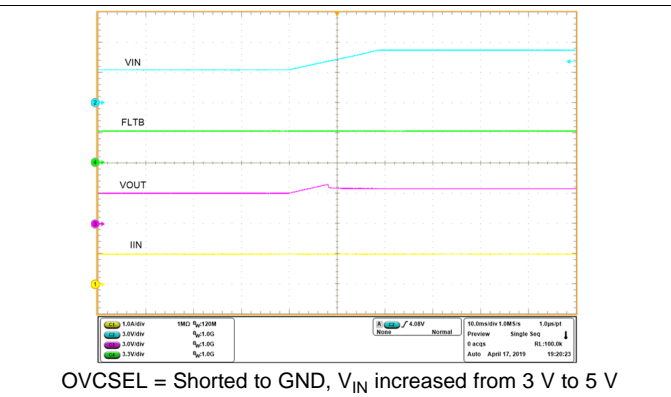

图 43. TPS25962x Overvoltage Clamp Response

8 Detailed Description

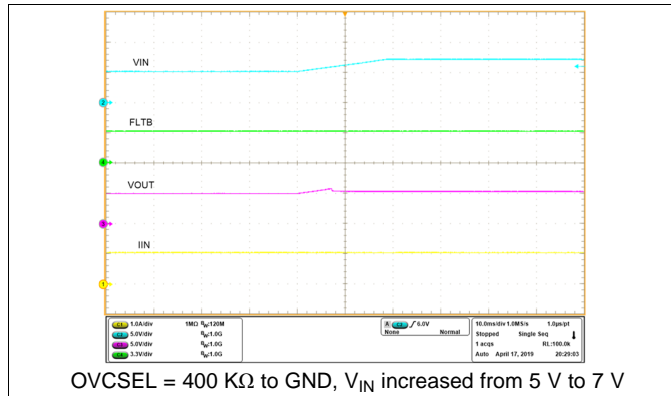
8.1 Overview

The TPS2596xx is an integrated eFuse device that is used to manage load voltage and load current. The device provides various factory programmed settings and user manageable settings, which allow device configuration for handling different transient and steady state supply and load fault conditions, thereby protecting the input supply and the downstream circuits connected to the device. The device also uses an in-built thermal shutdown mechanism to protect itself during these fault events.

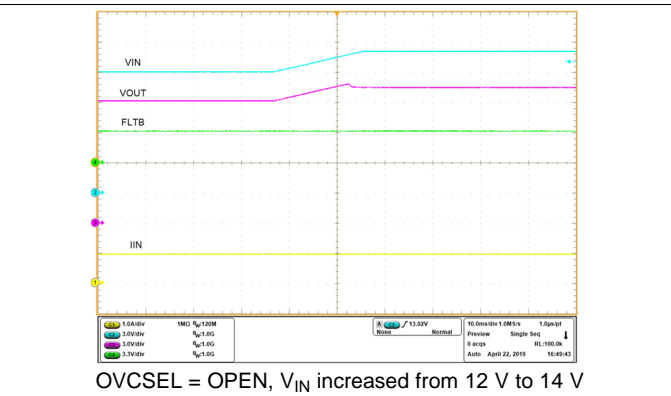
8.2 Functional Block Diagram

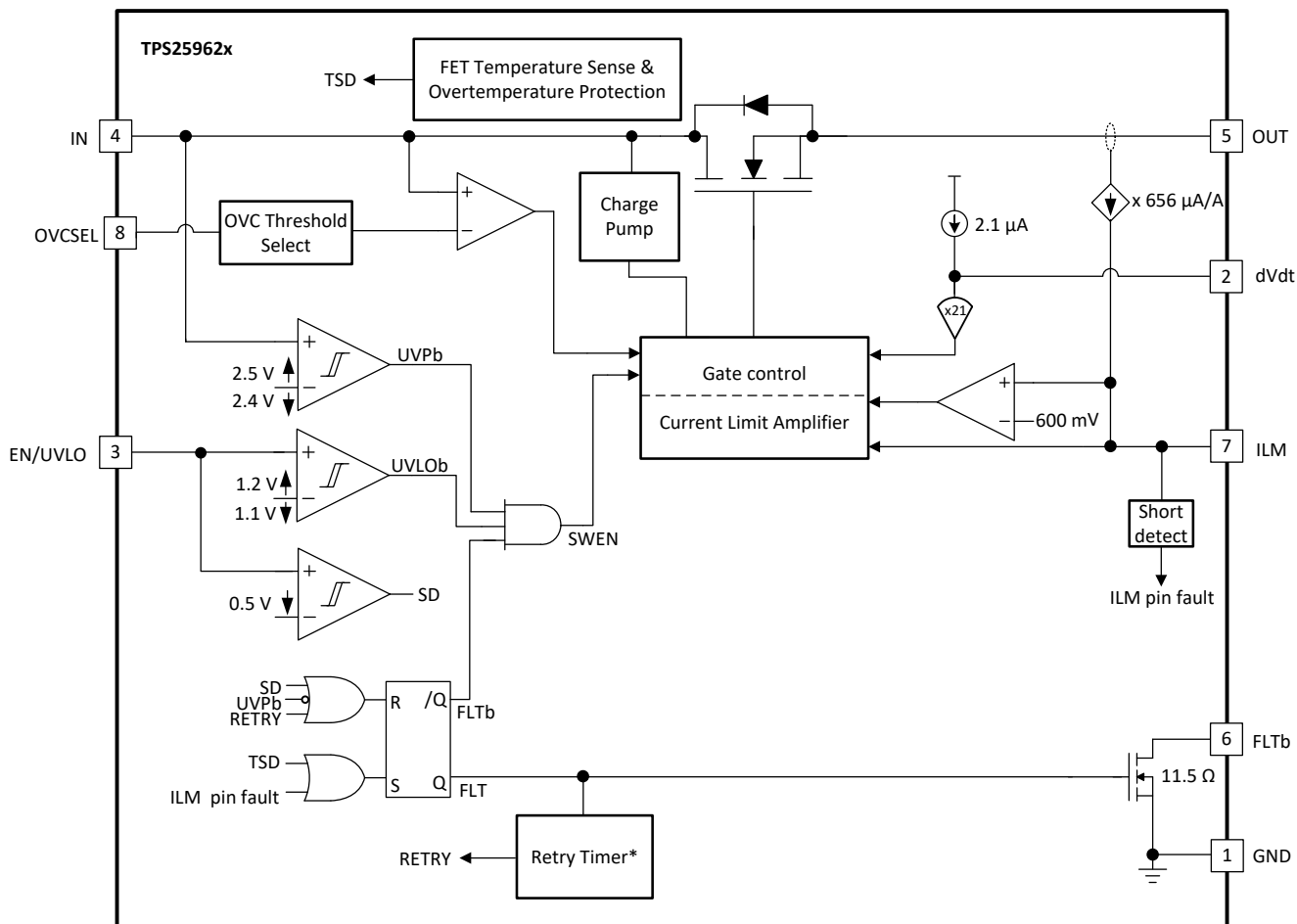

* Only for Auto-Retry Variant (TPS259621)

Functional Block Diagram (接下页)

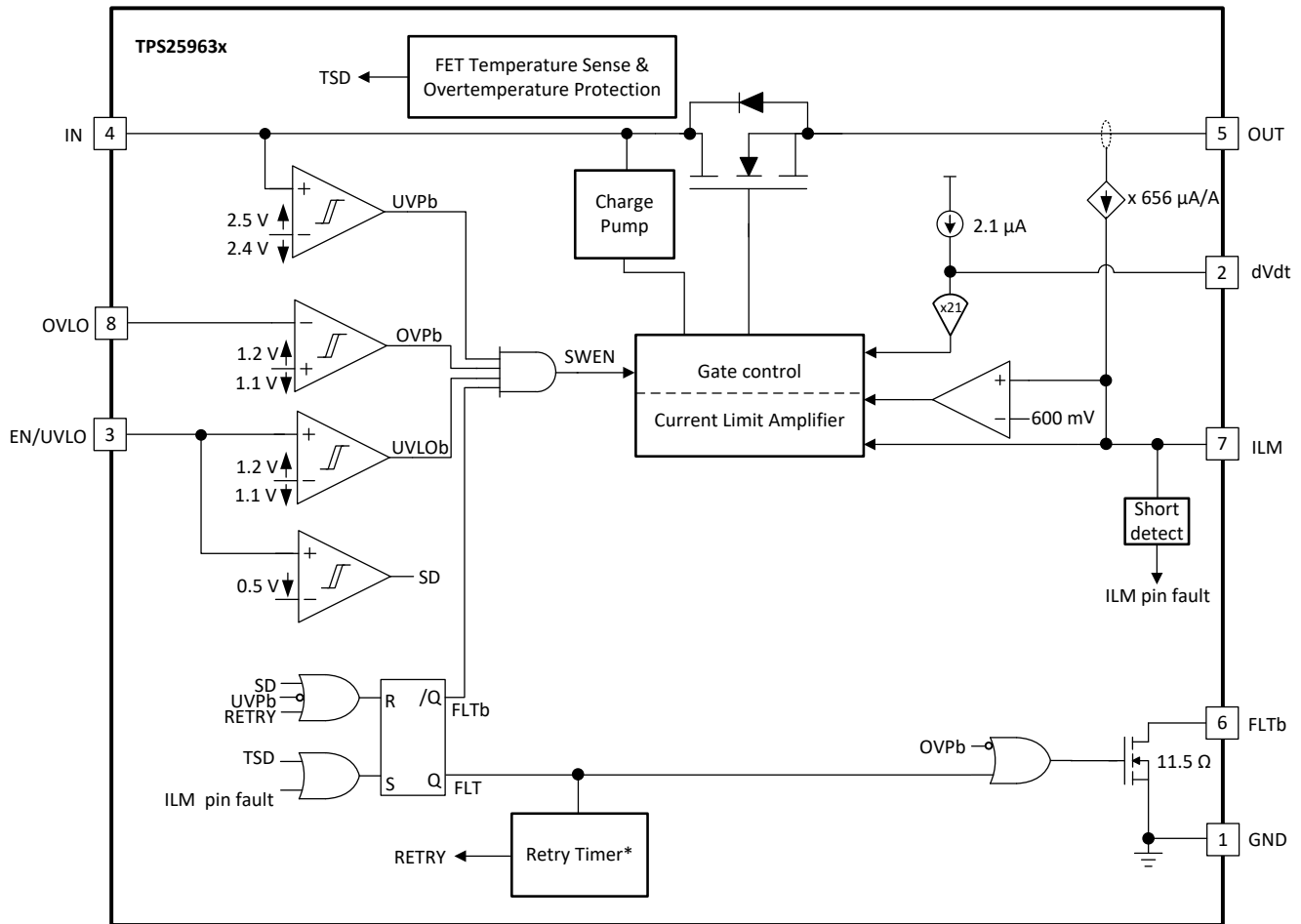

* Only for Auto-Retry Variant (TPS259631)

8.3 Feature Description

8.3.1 Undervoltage Protection (UVP) and Undervoltage Lockout (UVLO)

TPS2596xx constantly monitors the input supply to ensure that the load is powered up only when the voltage is at a sufficient level. During the start-up condition, the device waits for the input supply to rise above an internal fixed threshold $V_{UVP(R)}$ before it proceeds to turn ON the FET. Similarly, during the ON condition, if the input supply falls below the UVP threshold $V_{UVP(F)}$, the FET is turned OFF. The UVP rising and falling thresholds are slightly different, thereby providing some hysteresis and ensuring stable operation around the threshold voltage.

The TPS2596xx devices also provide an user adjustable UVLO mechanism to ensure that the load is powered up only when the voltage is at a sufficient level. This can be achieved by dividing the input supply and feeding it to the EN/UVLO pin. Whenever the voltage at the EN/UVLO pin falls below a threshold $V_{UVLO(F)}$, the device turns OFF the FET. The FET is turned ON again when the voltage rises above the threshold $V_{UVLO(R)}$. The rising and falling thresholds on this pin are slightly different, thereby providing some hysteresis and ensuring stable operation around the threshold voltage.

The user must choose the resistor divider values appropriately to map the desired input undervoltage level to the UVLO threshold of the part.

Feature Description (接下页)



图 44. Adjustable Undervoltage Lockout

$$V_{IN(UV)} = V_{UVLO(F)} \times \frac{(R1 + R2)}{R2} \tag{1}$$

8.3.2 Overvoltage Protection

The TPS2596xx devices provide 2 ways to handle an input overvoltage condition.

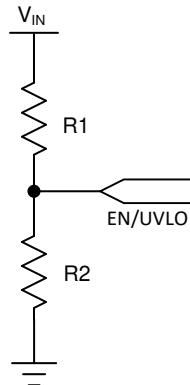
8.3.2.1 Overvoltage Lockout

The TPS25963x variants provide an user adjustable OVLO mechanism to ensure that the supply to the load is cut off if the input supply voltage exceeds a certain level. This can be achieved by dividing the input supply and feeding it to the OVLO pin. Whenever the voltage at the OVLO pin rises above a threshold $V_{OVLO(R)}$, the device turns OFF the FET. When the voltage at the OVLO pin falls below the threshold $V_{OVLO(F)}$, the FET is turned ON again. The rising and falling thresholds on this pin are slightly different, thereby providing some hysteresis and ensuring stable operation around the threshold voltage.



图 45. TPS25963x Overvoltage Lockout Response

Feature Description (接下页)

The user should choose the resistor divider values appropriately to map the desired input overvoltage level to the OVLO threshold of the part.

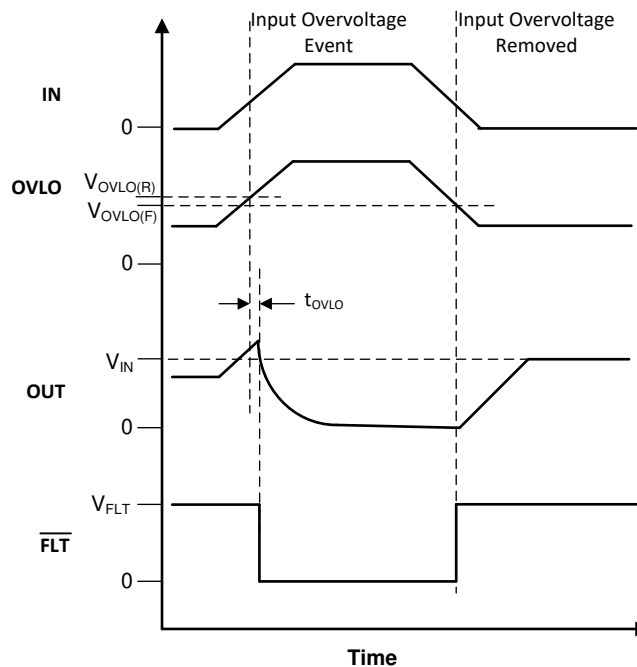

图 46. TPS25963x Adjustable Overvoltage Lockout

$$V_{IN(OV)} = V_{OVLO(R)} \times \frac{(R_1 + R_2)}{R_2} \quad (2)$$

8.3.2.2 Overvoltage Clamp

The TPS25962x variants provide a mechanism to clamp the output voltage to a user-selectable level quickly if the input voltage crosses a certain threshold. This ensures the load is not exposed to high voltages during any input overvoltage events and lowers the dependence on external protection devices (such as TVS/Zener diodes) in this condition. Once the input supply voltage rises above the OVC threshold voltage V_{OVC} , the device responds by clamping the voltage to V_{CLAMP} within a very short response time t_{OVC} . As long as an overvoltage condition is present on the input, the output voltage will be clamped to V_{CLAMP} . When the input drops below the output clamp threshold V_{OVC} , the clamp releases the output voltage as shown in 图 47.

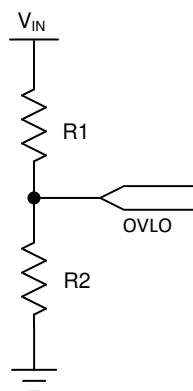
Feature Description (接下页)



图 47. TPS25962x Overvoltage Clamp Response

The OVC threshold can be configured to one of 3 pre-defined levels by connecting the OVCSEL pin as shown in 表 1.

表 1. TPS25962x Overvoltage Clamp Threshold Selection

OVCSEL Pin Connection	OVC Threshold (typ)
Shorted to GND	3.8 V
Connected to GND through 400 KΩ resistor	5.7 V
Open	13.7 V

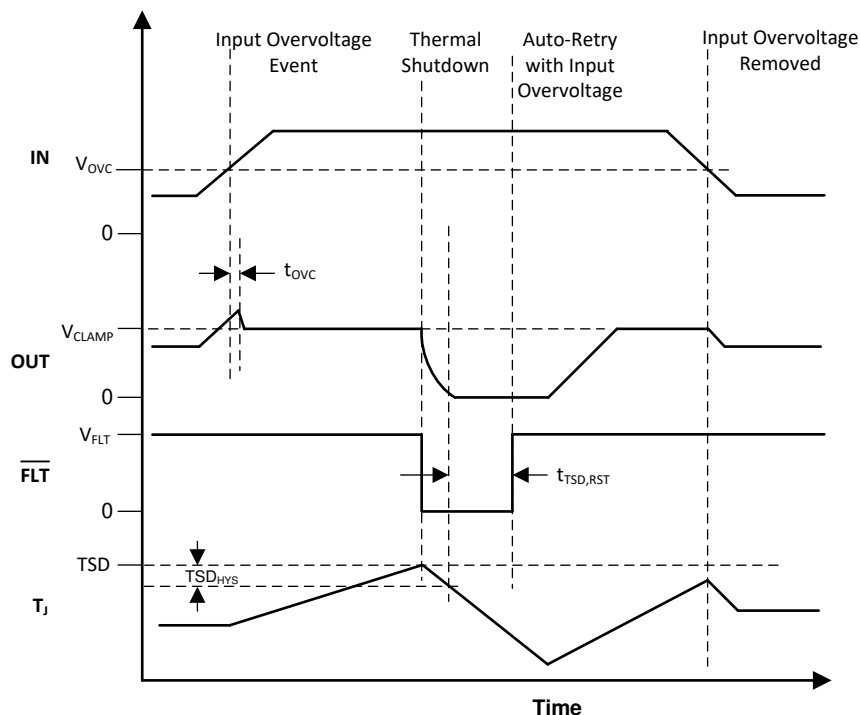
During the overvoltage clamp condition, there could be significant heat dissipation in the internal FET depending on the $V_{IN} - V_{OUT}$ voltage drop and the current (I_{OUT}) through the FET leading to thermal shutdown if the condition persists for an extended period of time. In this case, the device would either stay latched-off or start an auto-retry cycle as explained in the [Overtemperature Protection \(OTP\)](#) section.

8.3.3 Inrush Current, Overcurrent and Short Circuit Protection

The TPS2596xx devices incorporate three levels of protection against overcurrent:

- Adjustable slew rate for inrush current control (dVdt)
- Active current limiting with adjustable limit (I_{LIM}) for overcurrent protection
- Fast short-circuit response to protect against hard short-circuits

8.3.3.1 Slew Rate and Inrush Current Control (dVdt)

The inrush current during turn on is directly proportional to the load capacitance and rising slew rate. 公式 3 can be used to find the slew rate SR_{ON} required to limit the inrush current I_{INRUSH} for a given load capacitance C_{OUT} .

$$SR(mV / \mu s) = \frac{I_{INRUSH}(mA)}{C_L(\mu F)} \tag{3}$$

For loads requiring a slower rising slew rate, a capacitor can be connected to the dVdt pin to adjust the rising slew rate and lower the inrush current during turn on. The required C_{dVdt} capacitance value to produce a given slew rate can be calculated using 公式 4.

$$C_{dVdt}(\text{pF}) = \frac{42000}{\text{SR}(\text{mV} / \mu\text{s})} \quad (4)$$

8.3.3.2 Active Current Limiting

The load current is monitored during start-up and normal operation. When the load current exceeds the current limit I_{LIM} programmed by R_{ILM} resistor, the device regulates the current to the set limit I_{LIM} within t_{LIM} . The device exits current limiting when the load current falls below I_{LIM} . 公式 5 can be used to find the R_{ILM} value for a desired current limit.

$$R_{ILM}(\Omega) = \frac{903}{I_{LIM}(\text{A}) - 0.0112} \quad (5)$$

In the current limiting state, the output voltage drops resulting in increased power dissipation in the internal FET leading to thermal shutdown if the condition persists for an extended period of time. In this case, the device either stays latched-off or starts an auto-retry cycle as explained in the [Overtemperature Protection \(OTP\)](#) section.



图 48. TPS2596x1 Overcurrent Response (Auto-retry)



图 49. TPS2596x0 Overcurrent Response (Latch-off)

8.3.3.3 Short-Circuit Protection

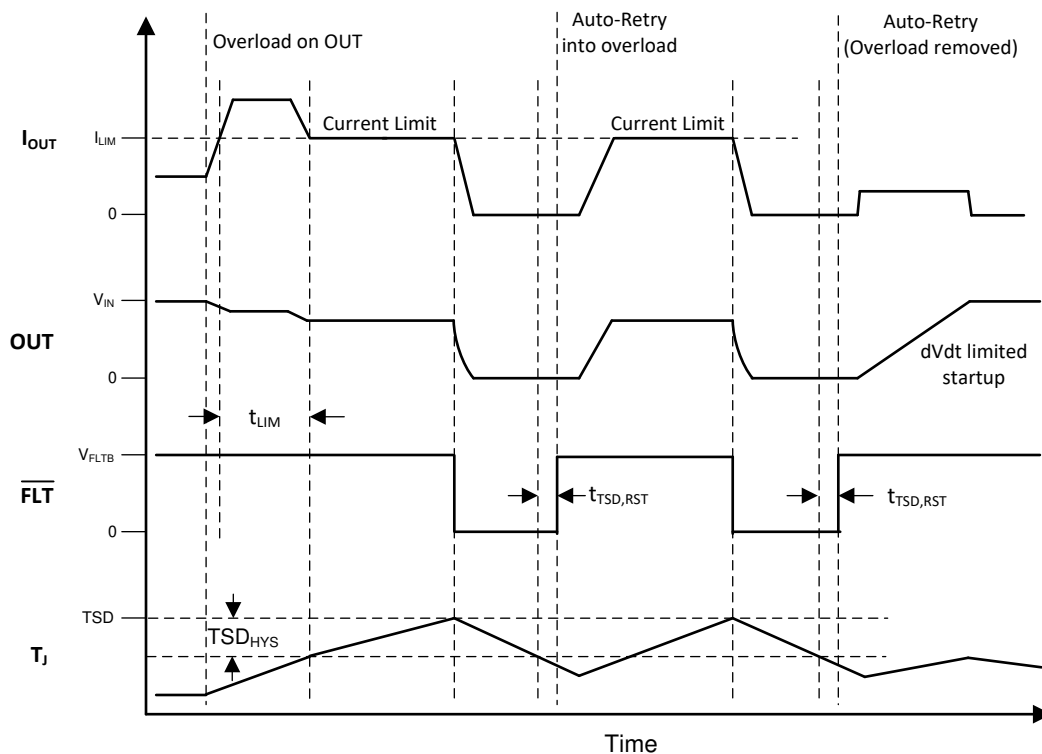
The current through the device increases very rapidly during a short-circuit event. If the current exceeds $1.5 \times I_{LIM}$, the device engages a fast current clamping circuit to regulate down the current faster than the nominal overcurrent response time (t_{LIM}). The device does not completely turn off the power FET to ensure uninterrupted power in the event of transient overcurrents or supply transients. The device stops limiting the current once the load current falls below the programmed I_{LIM} threshold.

The output voltage drops in the current limiting state, resulting in increased power dissipation in the internal FET and might lead to thermal shutdown if the condition persists for an extended period of time. In this case, the device either stays latched-off or starts an auto retry cycle as explained in the [Overtemperature Protection \(OTP\)](#) section.

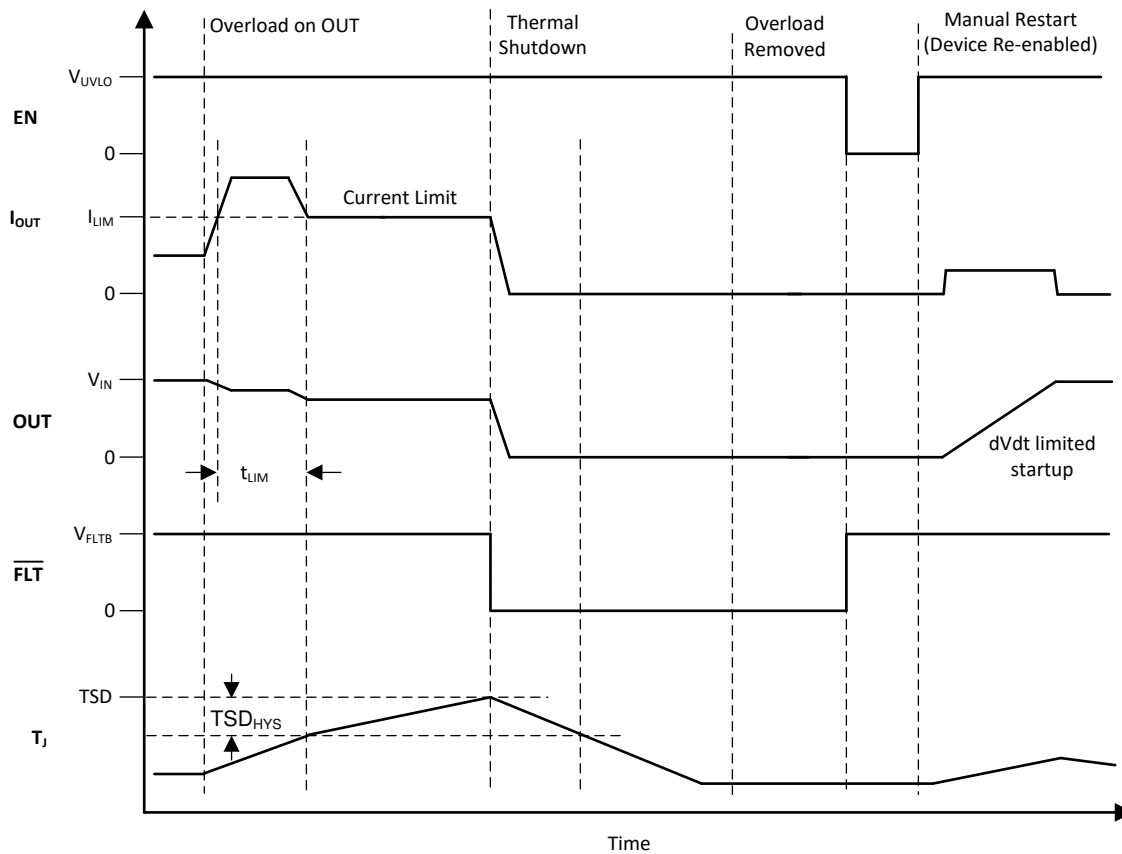

图 50. TPS2596xx Short Circuit Response

8.3.4 Analog Load Current Monitor (IMON)

The device allows the system to monitor the output load current accurately by providing an analog current on the ILM pin which is proportional to the current (I_{OUT}) through the FET. The user can sense the voltage (V_{ILM}) across the R_{ILM} to get a measure of the output load current.

$$I_{OUT}(A) = \frac{V_{ILM}(V)}{G_{IMON}(\mu A / A) \times R_{ILM}(\Omega)} \tag{6}$$

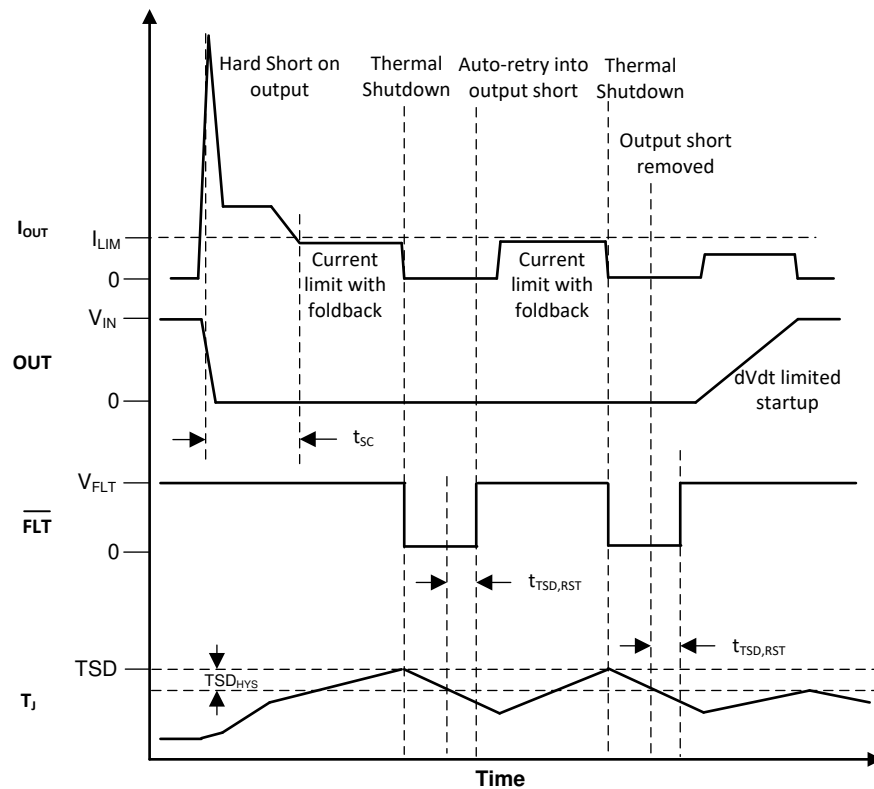
8.3.5 Overtemperature Protection (OTP)

Thermal Shutdown will occur when the junction temperature (T_J) exceeds the thermal shutdown threshold (TSD). When the TPS2596x0 variant detects thermal overload, it will be shut down and remain latched off until the device is power cycled or re-enabled by toggling the EN/UVLO pin. When the TPS2596x1 variant detects thermal overload, it will remain off until it has cooled down sufficiently. Once the TPS2596x1 junction has cooled down below TSD - TSD_{HYS}, it will remain off for an additional delay of t_{TSD,RST} after which it will automatically retry to turn on if it is still enabled.

表 2. TPS2596x Thermal Shutdown

Device	Enter TSD	Exit TSD
TPS2596x0 (Latch-Off)	T _J ≥ TSD	T _J < TSD - TSD _{HYS} and Power Cycle (V _{IN} < V _{UVP(F)}) / Enable Cycle (V _{EN} < V _{SD})
TPS2596x1 (Auto-Retry)	T _J ≥ TSD	T _J < TSD - TSD _{HYS} and t _{TSD,RST} timer expired

8.3.6 Fault Indication

表 3 summarizes the protection response to various fault conditions.

表 3. Fault Response

Event / Fault	Protection Response	$\overline{\text{FLT}}$ Asserted	$\overline{\text{FLT}}$ Delay
Overtemperature	Shutdown	Yes	
Undervoltage	Cut-off	No	
Overvoltage	Clamp (OVC - TPS25962x only)	No	
	Cut-off (OVLO - TPS25963x only)	Yes	t_{ovLo}
Overcurrent	Current Limit	No	
Short-Circuit	Current Limit	No	
ILM Pin Short to GND	Shut down	Yes	
ILM Pin Open	Shut down	No	

When the device turns off due to one of these fault conditions, the $\overline{\text{FLT}}$ pin is pulled low.

Power cycling the part or pulling the EN/UVLO pin voltage below V_{SD} clears the fault and the $\overline{\text{FLT}}$ pin is de-asserted. It also clears the $t_{\text{TSD,RST}}$ timer (Auto-retry variants only). Pulling the EN/UVLO just below the UVLO threshold ($V_{\text{UVLO(F)}}$) has no impact on the device in this condition. This is true for both Latch-off (TPS2596x0) and Auto-retry (TPS2596x1) variants.

For Auto-retry (TPS2596x1) variants, at the end of the $t_{\text{TSD,RST}}$ timer after a fault, the device restarts automatically and the $\overline{\text{FLT}}$ pin is de-asserted.

8.4 Device Functional Modes

The features of the device depend on the operating mode.

8.4.1 Enable and Fault Pin Functional Mode 1: Single Device, Self-Controlled

In this mode of operation, the device is enabled by the VIN voltage without the need of an external processor to drive the ENABLE pin. The $\overline{\text{FLT}}$ pin is optionally monitored by an external host as shown in 图 51.



图 51. Single Device, Self-Controlled

8.4.2 Enable and Fault Pin Functional Mode 2: Single Device, Host-Controlled

In this mode of operation, the device is enabled by the VIN voltage without the need of an external processor to drive the ENABLE pin. The $\overline{\text{FLT}}$ pin is optionally monitored by an external host as shown in 图 53.

Device Functional Modes (接下页)

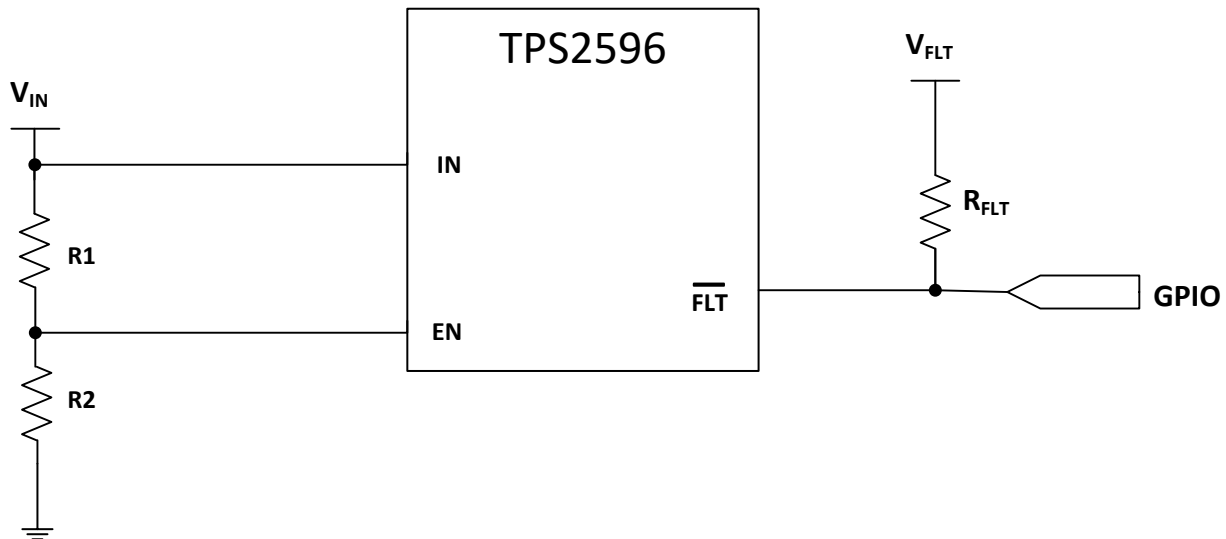
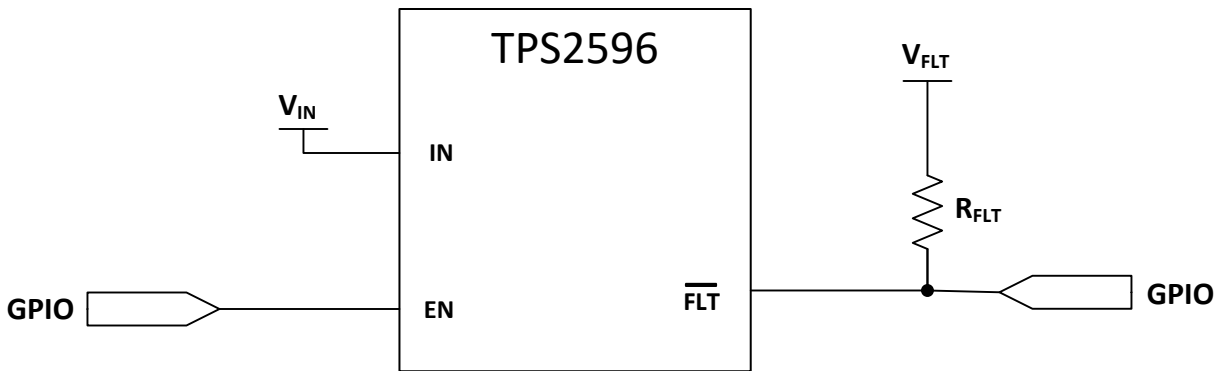
图 52. Single Device, Self-Controlled
8.4.3 Enable and Fault Pin Functional Mode 3: Multiple Devices, Self-Controlled

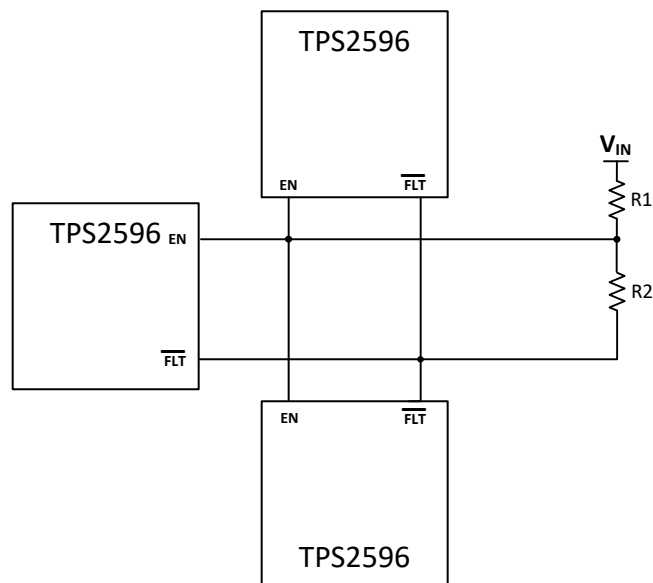
In this mode of operation, the devices are self-controlled (no host present). The EN and \overline{FLT} pins of multiple devices are shorted together as shown in 图 52. In this configuration, when any one of the TPS2596xx devices detects a fault, it automatically disables the other TPS2596xx devices in the system.

图 53. Multiple Devices, Self-Controlled

9 Application and Implementation

注

Information in the following applications sections is not part of the TI component specification, and TI does not warrant its accuracy or completeness. TI's customers are responsible for determining suitability of components for their purposes. Customers should validate and test their design implementation to confirm system functionality.

9.1 Application Information

The TPS2596xx device is an integrated eFuse that is typically used for hot-swap and power rail protection applications. The device operates from 2.7 V to 19 V with adjustable current limit and undervoltage protection. The device aids in controlling the in-rush current and provides precise current limiting during overload conditions for systems such as energy meters, white goods, building automation and adapter input protection. The device also provides robust protection for multiple faults on the sub-system rail.

The following design procedure can be used to select the supporting component values based on the application requirement.

9.2 Typical Application

9.2.1 Precision Current Limiting and Protection for White Goods

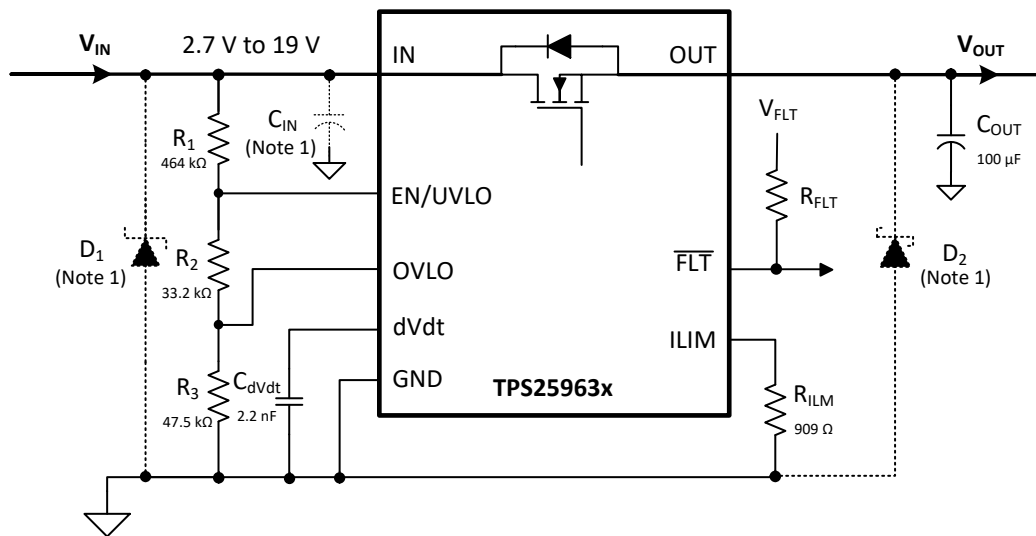

- (1) C_{IN} is optional and 0.1 μF is recommended to suppress transients due to the inductance of PCB routing or from input wiring. If system needs to pass IEC 61000-4-4 EFT test, minimum C_{IN} of 1 μF should be used to prevent eFuse from turning off during EFT bursts.

图 54. Typical Application Schematic: Simple eFuse for White Goods

9.2.2 Design Requirements

表 4. Design Parameters

DESIGN PARAMETER	EXAMPLE VALUE
Input voltage, V_{IN}	12 V
Undervoltage lockout set point, V_{UV}	8 V
Overvoltage protection set point, V_{OV}	13.7 V
Overvoltage protection type	Lock-out
Load at start-up, $R_{L(SU)}$	24 Ω

Typical Application (接下页)
表 4. Design Parameters (接下页)

DESIGN PARAMETER	EXAMPLE VALUE
Current limit, I_{LIM}	1 A
Load capacitance, C_{OUT}	100 μ F
Maximum ambient temperatures, T_A	85°C

9.2.3 Detailed Design Procedure

The designer must know the following:

- Normal input operation voltage
- Maximum output capacitance
- Maximum current limit
- Load during start-up
- Maximum ambient temperature of operation

This design procedure seeks to control the junction temperature of device under both static and transient conditions by proper selection of output ramp-up time and associated support components. The designer can adjust this procedure to fit the application and design criteria. A spreadsheet design tool [TPS2596 Design Calculator](#) is also available for simplified calculations.

9.2.3.1 Programming the Current-Limit Threshold: R_{ILM} Selection

The R_{ILM} resistor at the ILM pin sets the over load current limit, this can be set using [公式 7](#).

$$R_{ILM}(\Omega) = \frac{903}{I_{LIM}(A) - 0.0112} = \frac{903}{1 - 0.0112} = 913.2 \Omega \quad (7)$$

Choose closest standard value resistor: 909 Ω with 1% tolerance.

9.2.3.2 Undervoltage and Overvoltage Lockout Set Point

The undervoltage lockout (UVLO) and overvoltage lockout (OVLO) trip point is adjusted using the external voltage divider network of R_1 , R_2 and R_3 as connected between IN, EN/UVLO, OVLO and GND pins of the device. The values required for setting the undervoltage and overvoltage are calculated solving [公式 8](#) and [公式 9](#).

$$V_{UVLO} = \frac{R_2 + R_3}{(R_1 + R_2 + R_3)} \times V_{IN(UV)} \quad (8)$$

$$V_{OVLO} = \frac{R_3}{(R_1 + R_2 + R_3)} \times V_{IN(OV)} \quad (9)$$

Where $V_{UVLO(R)}$ is UVLO rising threshold (1.2 V). Because R_1 , R_2 and R_3 leak the current from input supply V_{IN} , these resistors must be selected based on the acceptable leakage current from input power supply V_{IN} .

The current drawn by R_1 , R_2 and R_3 from the power supply is $I_{R123} = V_{IN} / (R_1 + R_2 + R_3)$.

However, leakage currents due to external active components connected to the resistor string can add error to these calculations. So, the resistor string current, I_{R123} must be chosen to be 20 times greater than the leakage current expected.

From the device electrical specifications, $V_{OVLO} = 1.2$ V and $V_{UVLO} = 1.2$ V. For design requirements, $V_{OV} = 13.7$ V and $V_{UV} = 8$ V. To solve the equation, first choose the value of $R_3 = 47$ k Ω and use [公式 9](#) to solve for $(R_1 + R_2) = 489.58$ k Ω . Use Equation 8 and value of $(R_1 + R_2)$ to solve for $R_2 = 33.48$ k Ω and finally $R_1 = 456.1$ k Ω . Using the closest standard 1% resistor values gives $R_1 = 464$ k Ω , $R_2 = 33.2$ k Ω , and $R_3 = 47.5$ k Ω .

9.2.3.3 Setting Output Voltage Ramp Time (T_{dvdT})

For a successful design, the junction temperature of device must be kept below the absolute maximum rating during both dynamic (start-up) and steady state conditions. Dynamic power stresses often are an order of magnitude greater than the static stresses, so it is important to determine the right start-up time and in-rush current limit required with system capacitance to avoid thermal shutdown during start-up with and without load.

The required ramp-up capacitor C_{dvdT} is calculated considering the two possible cases (see [Case 1: Start-Up Without Load. Only Output Capacitance \$C_{OUT}\$ Draws Current](#) and [Case 2: Start-Up With Load. Output Capacitance \$C_{OUT}\$ and Load Draw Current](#)).

9.2.3.3.1 Case 1: Start-Up Without Load. Only Output Capacitance C_{OUT} Draws Current

During start-up, as the output capacitor charges, the voltage drop as well as the power dissipated across the internal FET decreases. The average power dissipated in the device during start-up is calculated using [公式 11](#).

For TPS2596xx device, the inrush current is determined as shown in [公式 10](#).

$$I_{INRUSH} = C_{OUT} \times \frac{V_{IN}}{T_{dvdT}} \quad (10)$$

Power dissipation during start-up is shown in [公式 11](#).

$$P_{D(INRUSH)} = 0.5 \times V_{IN} \times I_{INRUSH} \quad (11)$$

[公式 11](#) assumes that load does not draw any current until the output voltage has reached its final value.

9.2.3.3.2 Case 2: Start-Up With Load. Output Capacitance C_{OUT} and Load Draw Current

When the load draws current during the turnon sequence, there is additional power dissipated. Considering a resistive load during start-up $R_{L(SU)}$, load current ramps up proportionally with increase in output voltage during T_{dvdT} time. Equations 12 to 15 show the average power dissipation in the internal FET during charging time due to resistive load.

$$P_{D(LOAD)} = \left(\frac{1}{6}\right) \times \frac{V_{IN}^2}{R_{L(SU)}} \quad (12)$$

Total power dissipated in the device during start-up is [公式 13](#).

$$P_{D(STARTUP)} = P_{D(INRUSH)} + P_{D(LOAD)} \quad (13)$$

Total current during start-up is given by [公式 14](#).

$$I_{STARTUP} = I_{INRUSH} + I_L(t) \quad (14)$$

If $I_{STARTUP} > I_{LIMIT}$, the device limits the current to I_{LIMIT} and the current-limited charging time is determined by [公式 15](#).

$$T_{dvdT(Current-Limited)} = C_{OUT} \times R_{L(SU)} \times \left[\frac{I_{LIMIT}}{I_{INRUSH}} - 1 + \text{LN} \left(\frac{I_{INRUSH}}{I_{LIMIT} - \frac{V_{IN}}{R_{L(SU)}}} \right) \right] \quad (15)$$

The power dissipation, with and without load, for selected start-up time must not exceed the shutdown limits as shown in [图 55](#).



图 55. Thermal Shutdown Limit Plot

For the design example under discussion, select ramp-up capacitor $C_{dVdt} = 22000 \text{ pF}$. The default slew rate for $C_{dVdt} = 22000 \text{ pF}$ is $1.9 \text{ mV}/\mu\text{s}$. With slew rate of $1.9 \text{ mV}/\mu\text{s}$, the ramp-up time T_{dVdt} for 12 V input is 6.3 ms .

The inrush current drawn by the load capacitance C_{OUT} during ramp-up using 公式 16.

$$I_{INRUSH} = \frac{100 \mu\text{F} \times 1.9 \text{ mV}}{\mu\text{s}} = 190 \text{ mA} \tag{16}$$

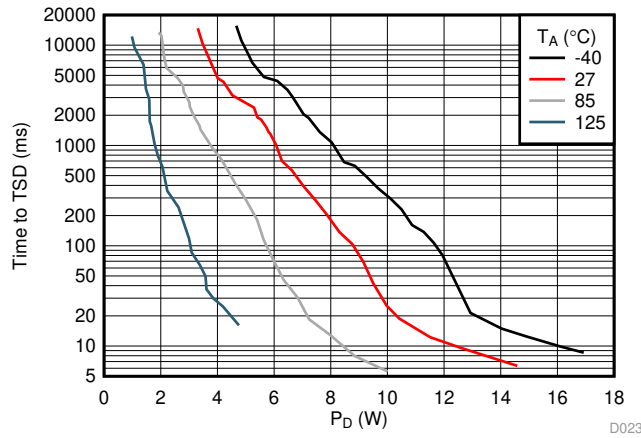
The inrush power dissipation is calculated using 公式 17.

$$P_{D(INRUSH)} = 0.5 \times 12 \times 190 \text{ m} = 1.14 \text{ W} \tag{17}$$

For 1.14 W of power loss, the thermal shutdown time of the device must not be less than the ramp-up time T_{dVdt} to avoid the false trip at the maximum operating temperature. 图 55 shows the thermal shutdown limit at $T_A = 85 \text{ }^\circ\text{C}$, for 1.14 W of power, the shutdown time is infinite. Therefore, it is safe to use 6.3 ms as the start-up time without any load on the output.

The additional power dissipation when a $10\text{-}\Omega$ load is present during start-up is calculated using 公式 18.

$$P_{D(LOAD)} = \left(\frac{1}{6}\right) \times \frac{12 \times 12}{24} = 1\text{W} \tag{18}$$

The total device power dissipation during start-up is given in 公式 19.

$$P_{D(STARTUP)} = 1 + 1.14 = 2.24 \text{ W} \tag{19}$$

图 55 shows $T_A = 85 \text{ }^\circ\text{C}$ and the thermal shutdown time for 2.24 W is approximately 2000 ms , which increases the margins further for shutdown time and ensures successful operation during start up and steady state conditions.

When C_{OUT} is large, there is a need to decrease the power dissipation during start-up. This can be done by increasing the value of the C_{dVdt} capacitor.

9.2.4 Support Component Selection: R_{FLT} and C_{IN}

Referring to application schematics, R_{FLT} is required only if \overline{FLT} is used; The resistor serves as pull-up for the open-drain output driver. The current sunk by this pin should not exceed 10 mA . C_{IN} is a bypass capacitor to help control transient voltages, unit emissions, and local supply noise. Where acceptable, a value in the range from $0.001 \text{ }\mu\text{F}$ to $0.1 \text{ }\mu\text{F}$ is recommended for C_{IN} .

9.2.5 Application Curves

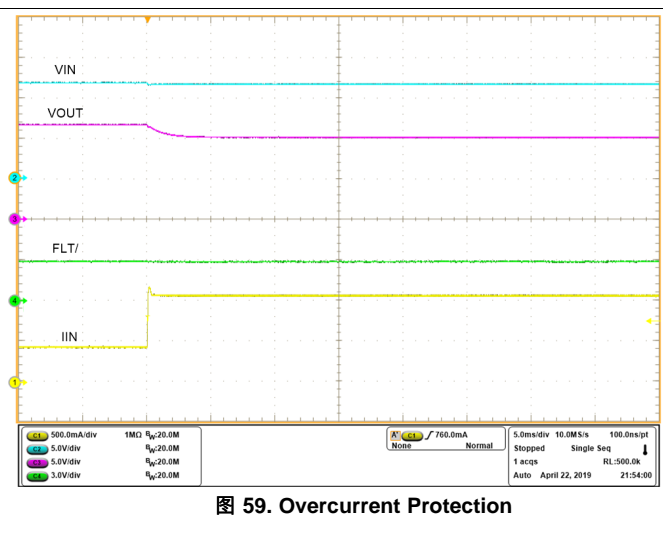
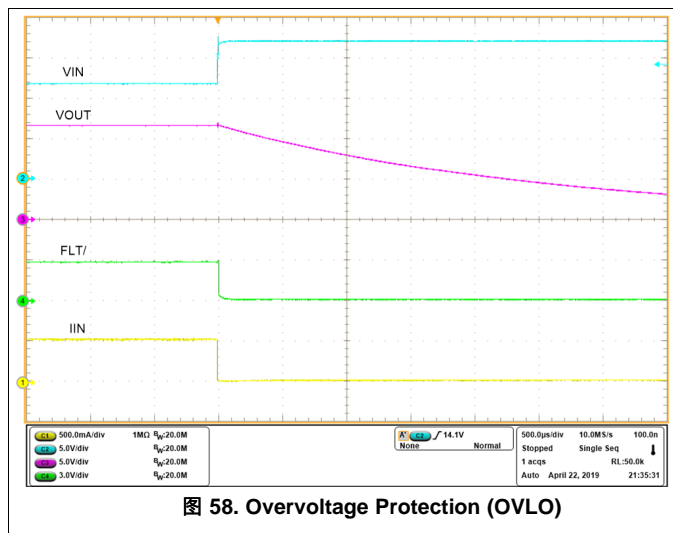
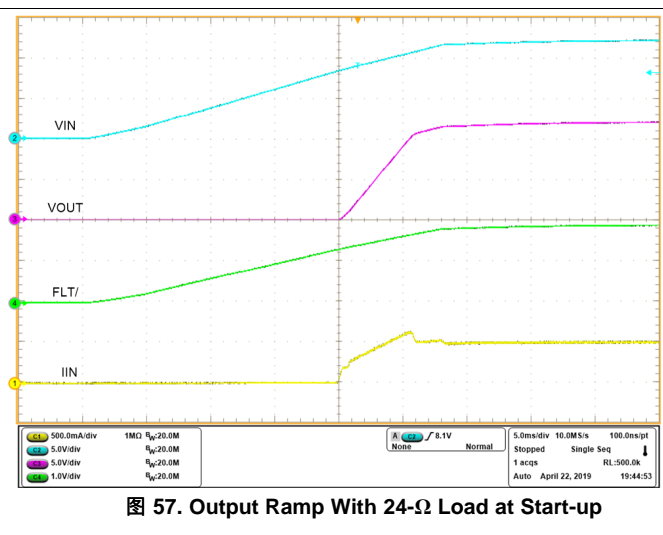
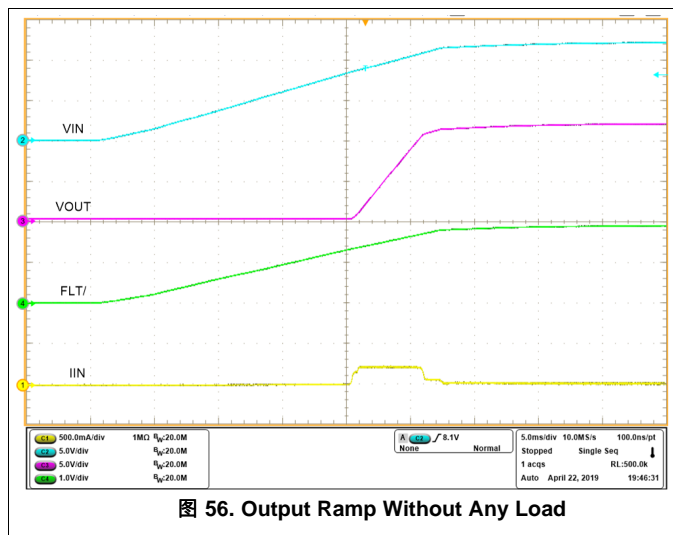

9.3 System Examples

The TPS2596xx provides a simple solution for current limiting, inrush current control and supervision of power rails for wide range of applications operating at 2.7 V to 19 V and delivering up to 2 A.

9.3.1 Current Limiting and Overvoltage Protection and for Energy Meter Power Rails

Energy meters generally use a single AC/DC power supply (for example: flyback converter) with multiple DC outputs for powering blocks like Metrology (analog front-end, microcontroller, memory), Real Time Clock (RTC), Relay (for remote load connect/disconnect) and Communications module. Metrology is the most critical sub-system and is required to operate uninterrupted under all conditions, even if a fault occurs in any of the supplementary blocks. One solution would be to oversize the power supply design so that it can handle the excess current demands during a fault condition, which increases the cost of the meter. A more elegant and cost-optimized solution would be to add an eFuse like TPS2596xx on the supplementary power rails, which provides accurate current limiting and fast short-circuit protection, thereby ensuring reliable operation of the metrology block without increasing the size or cost of the power supply. Apart from that, the TPS2596xx provides additional benefits such as:

- Overvoltage Protection (Lock-out and Clamp) to shield down-stream low voltage circuits from harmful overvoltages arising from poor cross-regulation between windings or AC input voltage surges.

System Examples (接下页)

- Disconnect supply to rarely used loads to minimize power consumption

图 60 shows a typical energy meter power supply implementation using TPS2596xx.



图 60. Energy Meter Power Rail Protection Example

TIDA-010037 demonstrates energy meter design using eFuse for protecting auxiliary rails.

9.3.2 Precision Current Limiting and Protection in Appliances

Household and similar electrical appliances are subjected to various tests (for example: needle flame, glow wire) as part of the certification for electrical and fire safety compliance as per the regulations. Special precautions need to be taken in the design to pass these tests, which include the use of higher grade flame retardant plastic material for the housing enclosures. There are certain provisions in the standard which can be leveraged to make the certification easier, faster and also reduce the cost of plastic materials. For example, any node which has less than 15 W of power available to it is classified as a LPC (Low Power Circuit as per the definition in IEC 60335-1) and deemed to be safe. All circuits or sub-systems further downstream from a LPC node are exempt from the aforementioned tests.

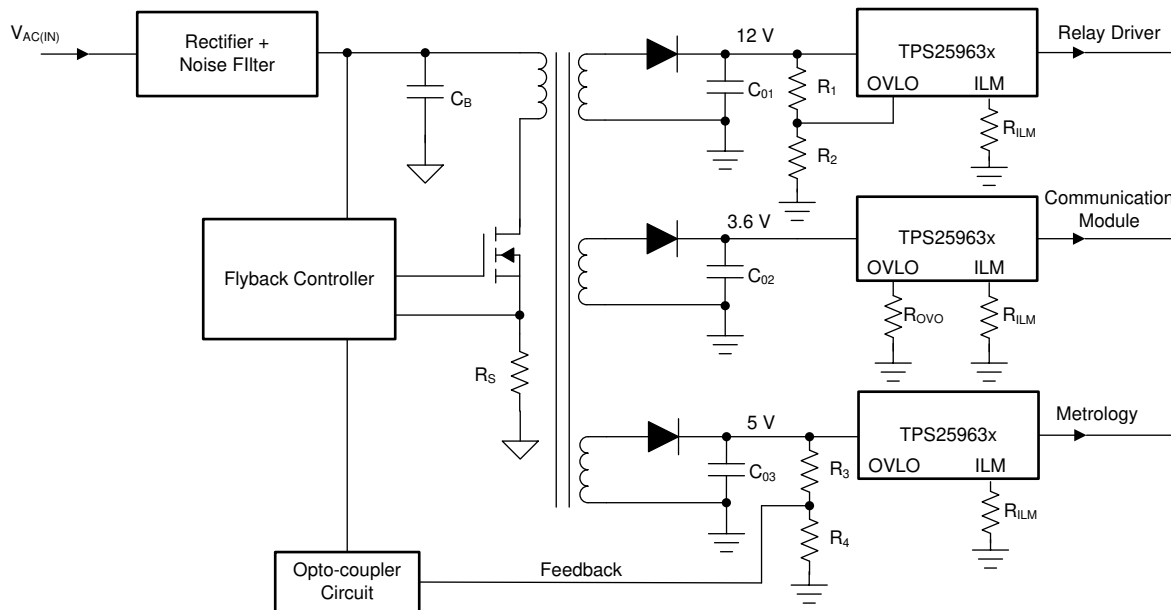
eFuses like TPS2596xx are a simple and cost effective way to limit the power delivered to the downstream load. The key parameter to be considered is the current limit tolerance and accuracy, which determines how high one can set the nominal current limit without exceeding the 15-W power limit on the upper end. On the lower end, it determines the maximum power the load can draw in normal conditions without hitting the current limit. TPS2596xx provides a current limit accuracy of $\pm 5\%$ (at room temperature), which allows the load to use nearly 90% out of the 15-W limit under normal operating conditions.

In contrast, an alternative current limiting solution with wider current limit tolerance, say $\pm 25\%$ would leave only 50% out of 15 W for the load circuit to operate under normal conditions. This places severe constraints on the load circuit design and/or capabilities.

图 61 shows a sub-system example of a refrigerator and freezer system where TPS2596xx is used for precision current limiting and protection of 15-W rails to ease the qualification as low-power circuit as per IEC 60335-1.

System Examples (接下页)



图 61. Appliances 15-W LPC Implementation Example

TIDA-010004 demonstrates a multi-load drive using single driver chip with eFuse for protection and 15-W LPC implementation.

Refer to this [Designing Low-Power Circuits \(LPCs\) using TPS2596 for Household and similar Appliances](#) application note for a detailed insight into implementing power limited circuits using eFuses.

10 Power Supply Recommendations

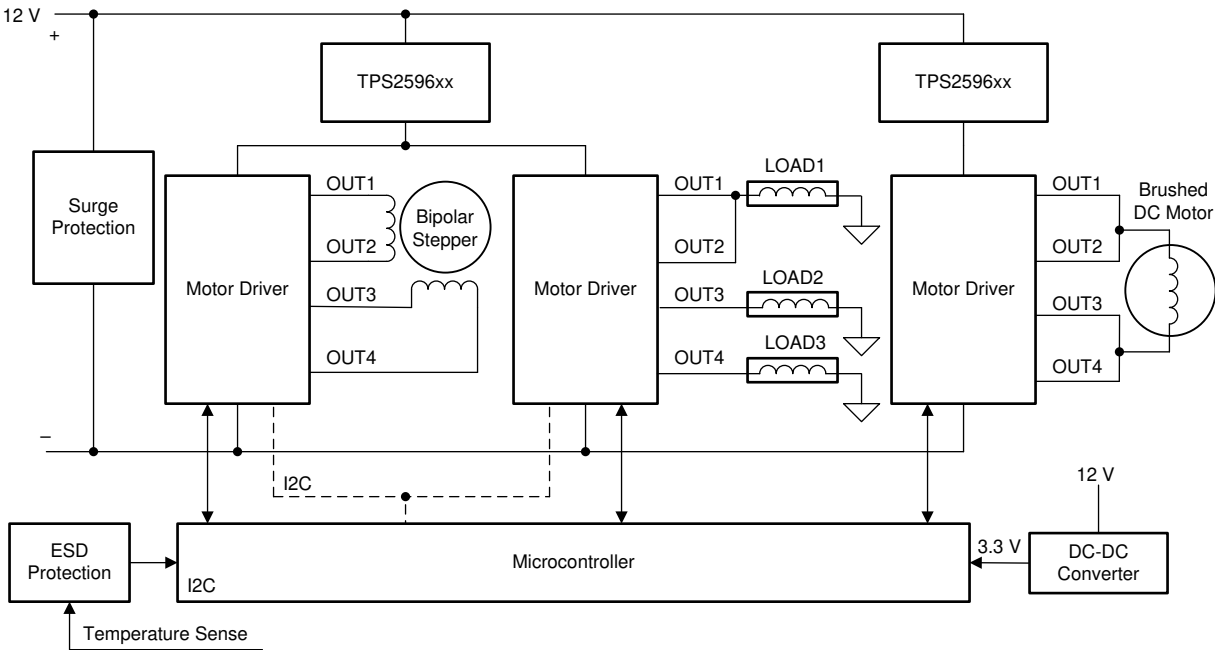
The TPS2596xx devices are designed for a supply voltage range of $2.7\text{ V} \leq V_{IN} \leq 19\text{ V}$. An input ceramic bypass capacitor higher than $0.1\text{ }\mu\text{F}$ is recommended if the input supply is located more than a few inches from the device. The power supply must be rated higher than the set current limit to avoid voltage droops during overcurrent and short-circuit conditions.

10.1 Transient Protection

In the case of a short circuit and overload current limit when the device interrupts current flow, the input inductance generates a positive voltage spike on the input, and the output inductance generates a negative voltage spike on the output. The peak amplitude of voltage spikes (transients) is dependent on the value of inductance in series to the input or output of the device. Such transients can exceed the absolute maximum ratings of the device if steps are not taken to address the issue. Typical methods for addressing transients include:

- Minimize lead length and inductance into and out of the device.
- Use a large PCB GND plane.
- Use a Schottky diode across the output to absorb negative spikes.
- Use a low-value ceramic capacitor $C_{IN} = 0.001\text{ }\mu\text{F}$ to $0.1\text{ }\mu\text{F}$ to absorb the energy and dampen the transients. The approximate value of input capacitance can be estimated with [公式 20](#):

$$V_{SPIKE(Absolute)} = V_{IN} + I_{LOAD} \times \sqrt{\frac{L_{IN}}{C_{IN}}} \tag{20}$$

where

- V_{IN} is the nominal supply voltage
- I_{LOAD} is the load current
- L_{IN} equals the effective inductance seen looking into the source
- C_{IN} is the capacitance present at the input

NOTE: Systems which need to pass IEC 61000-4-4 tests for immunity to Electrical Fast Transients (EFT) should use a minimum C_{IN} of $1\text{ }\mu\text{F}$ to ensure the TPS2596xx does not turn OFF during the EFT burst.

Some applications may require the addition of a Transient Voltage Suppressor (TVS) to prevent transients from exceeding the absolute maximum ratings of the device. The circuit implementation with optional protection components (a ceramic capacitor, TVS and Schottky diode) is shown in [图 62](#).



图 62. Circuit Implementation with Optional Protection Components

10.2 Output Short-Circuit Measurements

It is difficult to obtain repeatable and similar short-circuit testing results. The following contribute to variation in results:

- Source bypassing
- Input leads
- Circuit layout
- Component selection
- Output shorting method
- Relative location of the short
- Instrumentation

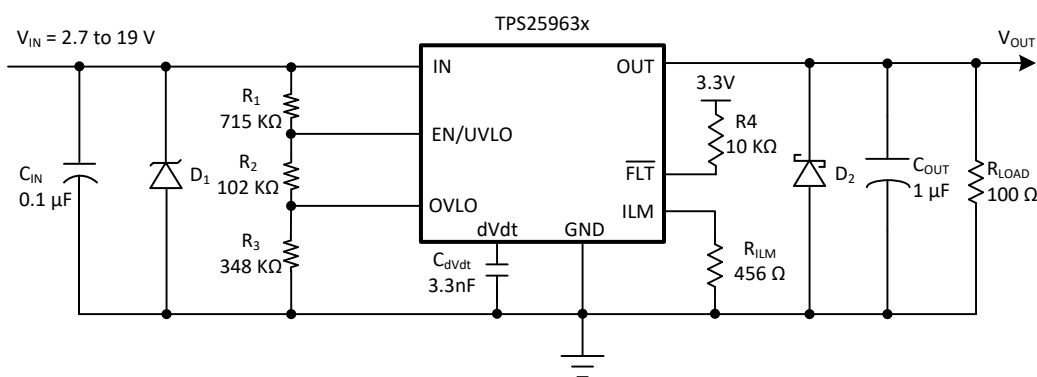
The actual short exhibits a certain degree of randomness because it microscopically bounces and arcs. Ensure that configuration and methods are used to obtain realistic results. Do not expect to see waveforms exactly like those in this data sheet because every setup is different.

11 Layout

11.1 Layout Guidelines

- For all applications, a ceramic decoupling capacitor of 0.01 μF or greater is recommended between the IN terminal and GND terminal. For hot-plug applications, where input power-path inductance is negligible, this capacitor can be eliminated or minimized.
- The optimal placement of the decoupling capacitor is closest to the IN and GND terminals of the device. Care must be taken to minimize the loop area formed by the bypass-capacitor connection, the IN terminal, and the GND terminal of the IC. See [图 63](#) for a PCB layout example.
- High current-carrying power-path connections must be as short as possible and must be sized to carry at least twice the full-load current.
- The GND terminal must be tied to the PCB ground plane at the terminal of the IC. The PCB ground must be a copper plane or island on the board.
- Locate the following support components close to their connection pins:

- R_{ILM}
- C_{dVdT}
- Resistor network for the EN/UVLO pin
- Resistor network for the OVLO pin for TPS25693x variants
- Pull-down resistor on the OVCSEL pin for TPS25692x variants

Connect the other end of the component to the GND pin of the device with shortest trace length. The trace routing from the R_{ILM} , C_{dVdT} and R_{OVCSEL} (for TPS25962x variants) components to the device pins must be as short as possible to reduce parasitic effects on the current limit, soft-start timing and overvoltage clamp response. These traces must not have any coupling to switching signals on the board.

- Protection devices such as TVS, snubbers, capacitors, or diodes must be placed physically close to the device they are intended to protect. These protection devices must be routed with short traces to reduce inductance. For example, a protection Schottky diode is recommended to address negative transients due to switching of inductive loads, and it must be physically close to the OUT pins.
- Obtaining acceptable performance with alternate layout schemes is possible. The Layout Example shown in [图 63](#) has been shown to produce good results and is intended as a guideline.

11.2 Layout Example

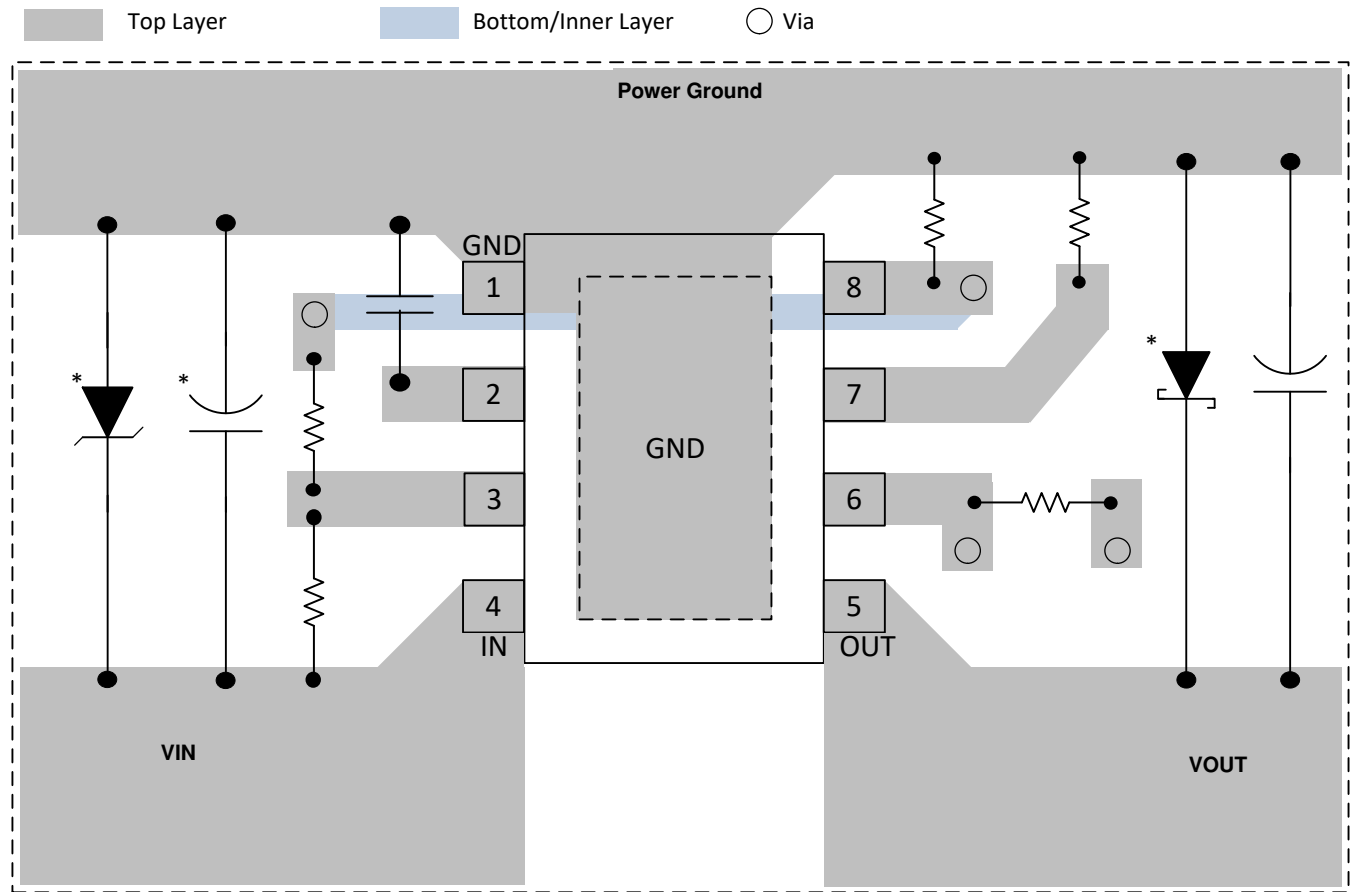

* Optional: Needed only to suppress the transients caused by inductive load switching

图 63. TPS2596xx Layout Example

12 器件和文档支持

12.1 文档支持

12.1.1 相关文档

请参阅如下相关文档：

- 《[电子保险丝的基本知识](#)》
- 《[TPS2596EVM: TPS2596xx 评估模块](#)》
- 《[TPS2596 设计计算器](#)》
- 《[使用 TPS2596 为家用或类似用途电器设计低功耗电路 \(LPC\)](#)》
- 《[TIDA-010037 高精度分相 CT 电量计](#)》
- 《[TIDA-010004 基于单个驱动器且受全面保护的 12V 步进、刷式直流和执行器驱动器](#)》

12.2 接收文档更新通知

要接收文档更新通知，请导航至 ti.com 上的器件产品文件夹。单击右上角的通知我进行注册，即可每周接收产品信息更改摘要。有关更改的详细信息，请查看任何已修订文档中包含的修订历史记录。

12.3 社区资源

The following links connect to TI community resources. Linked contents are provided "AS IS" by the respective contributors. They do not constitute TI specifications and do not necessarily reflect TI's views; see TI's [Terms of Use](#).

TI E2E™ Online Community *TI's Engineer-to-Engineer (E2E) Community*. Created to foster collaboration among engineers. At e2e.ti.com, you can ask questions, share knowledge, explore ideas and help solve problems with fellow engineers.

Design Support *TI's Design Support* Quickly find helpful E2E forums along with design support tools and contact information for technical support.

12.4 商标

E2E is a trademark of Texas Instruments.

All other trademarks are the property of their respective owners.

12.5 静电放电警告



ESD 可能会损坏该集成电路。德州仪器 (TI) 建议通过适当的预防措施处理所有集成电路。如果不遵守正确的处理措施和安装程序，可能会损坏集成电路。

ESD 的损坏小至导致微小的性能降级，大至整个器件故障。精密的集成电路可能更容易受到损坏，这是因为非常细微的参数更改都可能会导致器件与其发布的规格不相符。

12.6 Glossary

[SLYZ022](#) — *TI Glossary*.

This glossary lists and explains terms, acronyms, and definitions.

13 机械、封装和可订购信息

以下页面包含机械、封装和可订购信息。这些信息是指定器件的最新可用数据。数据如有变更，恕不另行通知，且不会对此文档进行修订。如需获取此数据表的浏览器版本，请查阅左侧的导航栏。

重要声明和免责声明

TI 均以“原样”提供技术性数据（包括数据表）、设计资源（包括参考设计）、应用或其他设计建议、网络工具、安全信息和其他资源，不保证其中不含任何瑕疵，且不做任何明示或暗示的担保，包括但不限于对适销性、适合某特定用途或不侵犯任何第三方知识产权的暗示担保。

所述资源可供专业开发人员应用TI 产品进行设计使用。您将对以下行为独自承担全部责任：(1) 针对您的应用选择合适的TI 产品；(2) 设计、验证并测试您的应用；(3) 确保您的应用满足相应标准以及任何其他安全、安保或其他要求。所述资源如有变更，恕不另行通知。TI 对您使用所述资源的授权仅限于开发资源所涉及TI 产品的相关应用。除此之外不得复制或展示所述资源，也不提供其它TI 或任何第三方的知识产权授权许可。如因使用所述资源而产生任何索赔、赔偿、成本、损失及债务等，TI 对此概不负责，并且您须赔偿由此对TI 及其代表造成的损害。

TI 所提供产品均受TI 的销售条款 (<http://www.ti.com.cn/zh-cn/legal/termsofsale.html>) 以及ti.com.cn上或随附TI产品提供的其他可适用条款的约束。TI提供所述资源并不扩展或以其他方式更改TI 针对TI 产品所发布的可适用的担保范围或担保免责声明。

邮寄地址：上海市浦东新区世纪大道 1568 号中建大厦 32 楼，邮政编码：200122
Copyright © 2019 德州仪器半导体技术（上海）有限公司

PACKAGING INFORMATION

Orderable Device	Status (1)	Package Type	Package Drawing	Pins	Package Qty	Eco Plan (2)	Lead finish/ Ball material (6)	MSL Peak Temp (3)	Op Temp (°C)	Device Marking (4/5)	Samples
TPS259620DDAR	ACTIVE	SO PowerPAD	DDA	8	2500	RoHS & Green	SN	Level-2-260C-1 YEAR	-40 to 125	259620	Samples
TPS259620DDAT	ACTIVE	SO PowerPAD	DDA	8	250	RoHS & Green	SN	Level-2-260C-1 YEAR	-40 to 125	259620	Samples
TPS259621DDAR	ACTIVE	SO PowerPAD	DDA	8	2500	RoHS & Green	SN	Level-2-260C-1 YEAR	-40 to 125	259621	Samples
TPS259621DDAT	ACTIVE	SO PowerPAD	DDA	8	250	RoHS & Green	SN	Level-2-260C-1 YEAR	-40 to 125	259621	Samples
TPS259630DDAR	ACTIVE	SO PowerPAD	DDA	8	2500	RoHS & Green	SN	Level-2-260C-1 YEAR	-40 to 125	259630	Samples
TPS259630DDAT	ACTIVE	SO PowerPAD	DDA	8	250	RoHS & Green	SN	Level-2-260C-1 YEAR	-40 to 125	259630	Samples
TPS259631DDAR	ACTIVE	SO PowerPAD	DDA	8	2500	RoHS & Green	SN	Level-2-260C-1 YEAR	-40 to 125	259631	Samples
TPS259631DDAT	ACTIVE	SO PowerPAD	DDA	8	250	RoHS & Green	SN	Level-2-260C-1 YEAR	-40 to 125	259631	Samples

(1) The marketing status values are defined as follows:

ACTIVE: Product device recommended for new designs.

LIFEBUY: TI has announced that the device will be discontinued, and a lifetime-buy period is in effect.

NRND: Not recommended for new designs. Device is in production to support existing customers, but TI does not recommend using this part in a new design.

PREVIEW: Device has been announced but is not in production. Samples may or may not be available.

OBSELETE: TI has discontinued the production of the device.

(2) **RoHS:** TI defines "RoHS" to mean semiconductor products that are compliant with the current EU RoHS requirements for all 10 RoHS substances, including the requirement that RoHS substance do not exceed 0.1% by weight in homogeneous materials. Where designed to be soldered at high temperatures, "RoHS" products are suitable for use in specified lead-free processes. TI may reference these types of products as "Pb-Free".

RoHS Exempt: TI defines "RoHS Exempt" to mean products that contain lead but are compliant with EU RoHS pursuant to a specific EU RoHS exemption.

Green: TI defines "Green" to mean the content of Chlorine (Cl) and Bromine (Br) based flame retardants meet JS709B low halogen requirements of <=1000ppm threshold. Antimony trioxide based flame retardants must also meet the <=1000ppm threshold requirement.

(3) MSL, Peak Temp. - The Moisture Sensitivity Level rating according to the JEDEC industry standard classifications, and peak solder temperature.

(4) There may be additional marking, which relates to the logo, the lot trace code information, or the environmental category on the device.

(5) Multiple Device Markings will be inside parentheses. Only one Device Marking contained in parentheses and separated by a "~" will appear on a device. If a line is indented then it is a continuation of the previous line and the two combined represent the entire Device Marking for that device.

⁽⁶⁾ Lead finish/Ball material - Orderable Devices may have multiple material finish options. Finish options are separated by a vertical ruled line. Lead finish/Ball material values may wrap to two lines if the finish value exceeds the maximum column width.

Important Information and Disclaimer:The information provided on this page represents TI's knowledge and belief as of the date that it is provided. TI bases its knowledge and belief on information provided by third parties, and makes no representation or warranty as to the accuracy of such information. Efforts are underway to better integrate information from third parties. TI has taken and continues to take reasonable steps to provide representative and accurate information but may not have conducted destructive testing or chemical analysis on incoming materials and chemicals. TI and TI suppliers consider certain information to be proprietary, and thus CAS numbers and other limited information may not be available for release.

In no event shall TI's liability arising out of such information exceed the total purchase price of the TI part(s) at issue in this document sold by TI to Customer on an annual basis.

TAPE AND REEL INFORMATION



QUADRANT ASSIGNMENTS FOR PIN 1 ORIENTATION IN TAPE



*All dimensions are nominal

Device	Package Type	Package Drawing	Pins	SPQ	Reel Diameter (mm)	Reel Width W1 (mm)	A0 (mm)	B0 (mm)	K0 (mm)	P1 (mm)	W (mm)	Pin1 Quadrant
TPS259620DDAR	SO Power PAD	DDA	8	2500	330.0	12.8	6.4	5.2	2.1	8.0	12.0	Q1
TPS259620DDAT	SO Power PAD	DDA	8	250	330.0	12.8	6.4	5.2	2.1	8.0	12.0	Q1
TPS259621DDAR	SO Power PAD	DDA	8	2500	330.0	12.8	6.4	5.2	2.1	8.0	12.0	Q1
TPS259621DDAT	SO Power PAD	DDA	8	250	330.0	12.8	6.4	5.2	2.1	8.0	12.0	Q1
TPS259630DDAR	SO Power PAD	DDA	8	2500	330.0	12.8	6.4	5.2	2.1	8.0	12.0	Q1
TPS259630DDAT	SO Power PAD	DDA	8	250	330.0	12.8	6.4	5.2	2.1	8.0	12.0	Q1
TPS259631DDAR	SO Power PAD	DDA	8	2500	330.0	12.8	6.4	5.2	2.1	8.0	12.0	Q1
TPS259631DDAT	SO	DDA	8	250	330.0	12.8	6.4	5.2	2.1	8.0	12.0	Q1

Device	Package Type	Package Drawing	Pins	SPQ	Reel Diameter (mm)	Reel Width W1 (mm)	A0 (mm)	B0 (mm)	K0 (mm)	P1 (mm)	W (mm)	Pin1 Quadrant
	Power PAD											

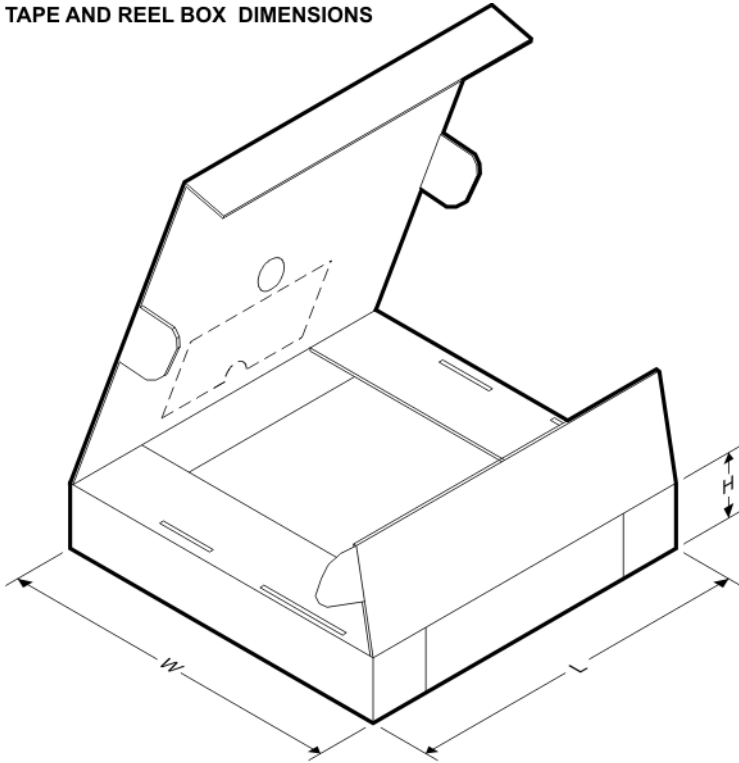
TAPE AND REEL BOX DIMENSIONS

*All dimensions are nominal

Device	Package Type	Package Drawing	Pins	SPQ	Length (mm)	Width (mm)	Height (mm)
TPS259620DDAR	SO PowerPAD	DDA	8	2500	366.0	364.0	50.0
TPS259620DDAT	SO PowerPAD	DDA	8	250	366.0	364.0	50.0
TPS259621DDAR	SO PowerPAD	DDA	8	2500	366.0	364.0	50.0
TPS259621DDAT	SO PowerPAD	DDA	8	250	366.0	364.0	50.0
TPS259630DDAR	SO PowerPAD	DDA	8	2500	366.0	364.0	50.0
TPS259630DDAT	SO PowerPAD	DDA	8	250	366.0	364.0	50.0
TPS259631DDAR	SO PowerPAD	DDA	8	2500	366.0	364.0	50.0
TPS259631DDAT	SO PowerPAD	DDA	8	250	366.0	364.0	50.0



Images above are just a representation of the package family, actual package may vary.
Refer to the product data sheet for package details.

DDA (R-PDSO-G8)

PowerPAD™ PLASTIC SMALL-OUTLINE



4202561/F 12/11

- NOTES:
- All linear dimensions are in millimeters. Dimensioning and tolerancing per ASME Y14.5-1994.
 - This drawing is subject to change without notice.
 - Body dimensions do not include mold flash or protrusion not to exceed 0,15.
 - This package is designed to be soldered to a thermal pad on the board. Refer to Technical Brief, PowerPad Thermally Enhanced Package, Texas Instruments Literature No. SLMA002 for information regarding recommended board layout. This document is available at www.ti.com <<http://www.ti.com>>.
 - See the additional figure in the Product Data Sheet for details regarding the exposed thermal pad features and dimensions.
 - This package complies to JEDEC MS-012 variation BA

PowerPAD is a trademark of Texas Instruments.

DDA (R-PDSO-G8)

PowerPAD™ PLASTIC SMALL OUTLINE

THERMAL INFORMATION

This PowerPAD™ package incorporates an exposed thermal pad that is designed to be attached to a printed circuit board (PCB). The thermal pad must be soldered directly to the PCB. After soldering, the PCB can be used as a heatsink. In addition, through the use of thermal vias, the thermal pad can be attached directly to the appropriate copper plane shown in the electrical schematic for the device, or alternatively, can be attached to a special heatsink structure designed into the PCB. This design optimizes the heat transfer from the integrated circuit (IC).

For additional information on the PowerPAD package and how to take advantage of its heat dissipating abilities, refer to Technical Brief, PowerPAD Thermally Enhanced Package, Texas Instruments Literature No. SLMA002 and Application Brief, PowerPAD Made Easy, Texas Instruments Literature No. SLMA004. Both documents are available at www.ti.com.

The exposed thermal pad dimensions for this package are shown in the following illustration.

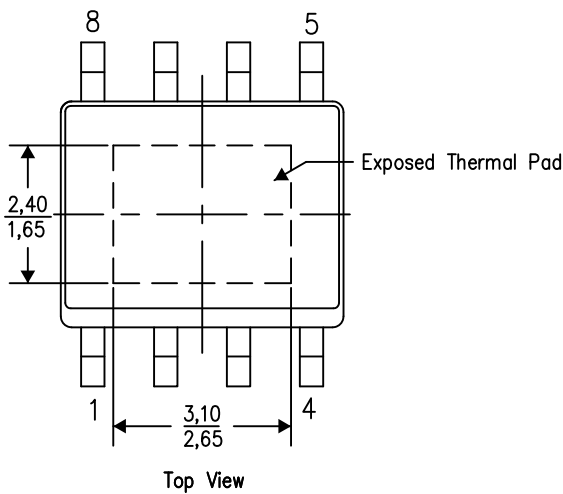

Exposed Thermal Pad Dimensions

4206322-6/L 05/12

NOTE: A. All linear dimensions are in millimeters

PowerPAD is a trademark of Texas Instruments

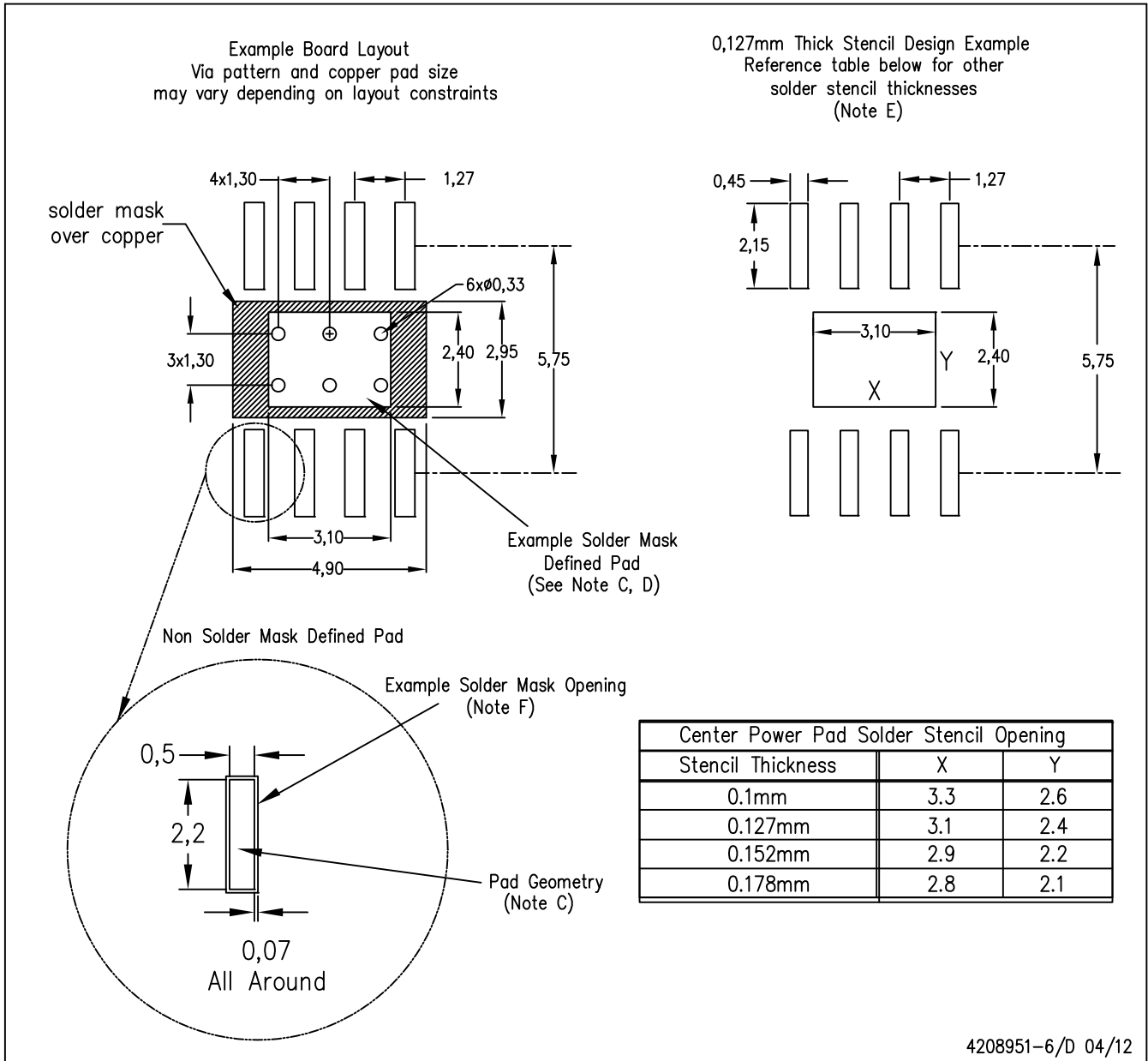

- NOTES:
- A. All linear dimensions are in millimeters.
 - B. This drawing is subject to change without notice.
 - C. Publication IPC-7351 is recommended for alternate designs.
 - D. This package is designed to be soldered to a thermal pad on the board. Refer to Technical Brief, PowerPad Thermally Enhanced Package, Texas Instruments Literature No. SLMA002, SLMA004, and also the Product Data Sheets for specific thermal information, via requirements, and recommended board layout. These documents are available at www.ti.com <<http://www.ti.com>>. Publication IPC-7351 is recommended for alternate designs.
 - E. Laser cutting apertures with trapezoidal walls and also rounding corners will offer better paste release. Customers should contact their board assembly site for stencil design recommendations. Example stencil design based on a 50% volumetric metal load solder paste. Refer to IPC-7525 for other stencil recommendations.
 - F. Customers should contact their board fabrication site for solder mask tolerances between and around signal pads.

PowerPAD is a trademark of Texas Instruments.

重要声明和免责声明

TI 均以“原样”提供技术性及其可靠性数据（包括数据表）、设计资源（包括参考设计）、应用或其他设计建议、网络工具、安全信息和其他资源，不保证其中不含任何瑕疵，且不做任何明示或暗示的担保，包括但不限于对适销性、适合某特定用途或不侵犯任何第三方知识产权的暗示担保。

所述资源可供专业开发人员应用TI 产品进行设计使用。您将对以下行为独自承担全部责任：(1) 针对您的应用选择合适的TI 产品；(2) 设计、验证并测试您的应用；(3) 确保您的应用满足相应标准以及任何其他安全、安保或其他要求。所述资源如有变更，恕不另行通知。TI 对您使用所述资源的授权仅限于开发资源所涉及TI 产品的相关应用。除此之外不得复制或展示所述资源，也不提供其它TI 或任何第三方的知识产权授权许可。如因使用所述资源而产生任何索赔、赔偿、成本、损失及债务等，TI 对此概不负责，并且您须赔偿由此对TI 及其代表造成的损害。

TI 所提供产品均受TI 的销售条款 (<http://www.ti.com.cn/zh-cn/legal/termsofsale.html>) 以及ti.com.cn上或随附TI产品提供的其他可适用条款的约束。TI提供所述资源并不扩展或以其他方式更改TI 针对TI 产品所发布的可适用的担保范围或担保免责声明。

邮寄地址：上海市浦东新区世纪大道 1568 号中建大厦 32 楼，邮政编码：200122

Copyright © 2020 德州仪器半导体技术（上海）有限公司