

February 1998 - Revised October 2003

High-Speed CMOS Logic Quad Analog Switch with Level Translation

Features

- **Wide Analog-Input-Voltage Range**
 $V_{CC} - V_{EE}$ 0V to 10V
- **Low "ON" Resistance**
 - 45Ω (Typ) $V_{CC} = 4.5V$
 - 35Ω (Typ) $V_{CC} = 6V$
 - 30Ω (Typ) $V_{CC} - V_{EE} = 9V$
- **Fast Switching and Propagation Delay Times**
- **Low "OFF" Leakage Current**
- **Built-In "Break-Before-Make" Switching**
- **Logic-Level Translation to Enable 5V Logic to Accommodate ±5V Analog Signals**
- **Wide Operating Temperature Range . . . -55°C to 125°C**
- **HC Types**
 - 2V to 10V Operation
 - **High Noise Immunity: $N_{IL} = 30\%$, $N_{IH} = 30\%$ of V_{CC} at $V_{CC} = 5V$**
- **HCT Types**
 - **Direct LSTTL Input Logic Compatibility, $V_{IL} = 0.8V$ (Max), $V_{IH} = 2V$ (Min)**
 - **CMOS Input Compatibility, $I_I \leq 1\mu A$ at V_{OL} , V_{OH}**

Description

The 'HC4316 and CD74HCT4316 contain four independent digitally controlled analog switches that use silicon-gate CMOS technology to achieve operating speeds similar to LSTTL with the low power consumption of standard CMOS integrated circuits.

In addition these devices contain logic-level translation circuits that provide for analog signal switching of voltages between $\pm 5V$ via 5V logic. Each switch is turned on by a high-level voltage on its select input (S) when the common Enable (E) is Low. A High E disables all switches. The digital inputs can swing between V_{CC} and GND; the analog inputs/outputs can swing between V_{CC} as a positive limit and V_{EE} as a negative limit. Voltage ranges are shown in Figures 2 and 3.

Ordering Information

PART NUMBER	TEMP. RANGE (°C)	PACKAGE
CD54HC4316F3A	-55 to 125	16 Ld CERDIP
CD74HC4316E	-55 to 125	16 Ld PDIP
CD74HC4316M	-55 to 125	16 Ld SOIC
CD74HC4316MT	-55 to 125	16 Ld SOIC
CD74HC4316M96	-55 to 125	16 Ld SOIC
CD74HC4316NSR	-55 to 125	16 Ld SOP
CD74HC4316PW	-55 to 125	16 Ld TSSOP
CD74HC4316PWR	-55 to 125	16 Ld TSSOP
CD74HC4316PWT	-55 to 125	16 Ld TSSOP
CD74HCT4316E	-55 to 125	16 Ld PDIP
CD74HCT4316M	-55 to 125	16 Ld SOIC
CD74HCT4316MT	-55 to 125	16 Ld SOIC
CD74HCT4316M96	-55 to 125	16 Ld SOIC

NOTE: When ordering, use the entire part number. The suffixes 96 and R denote tape and reel. The suffix T denotes a small-quantity reel of 250.

Pinout

CD54HC4316 (CERDIP)
 CD74HC4316 (PDIP, SOIC, SOP, TSSOP)
 CD74HCT4316 (PDIP, SOIC)

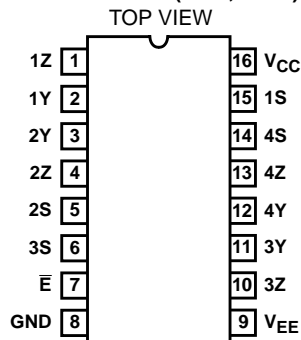

Functional Diagram

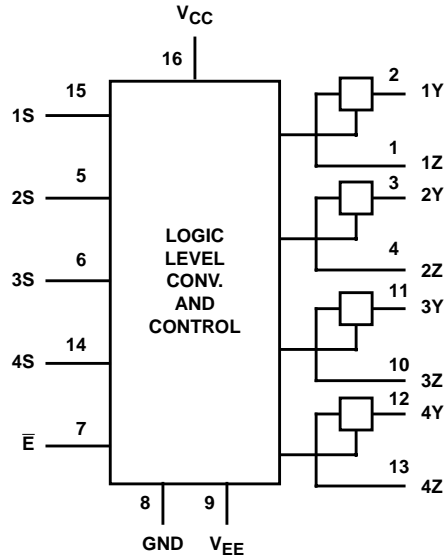

TRUTH TABLE

INPUTS		SWITCH
\bar{E}	S	
L	L	OFF
L	H	ON
H	X	OFF

H= High Level Voltage
 L= Low Level Voltage
 X= Don't Care

Logic Diagram

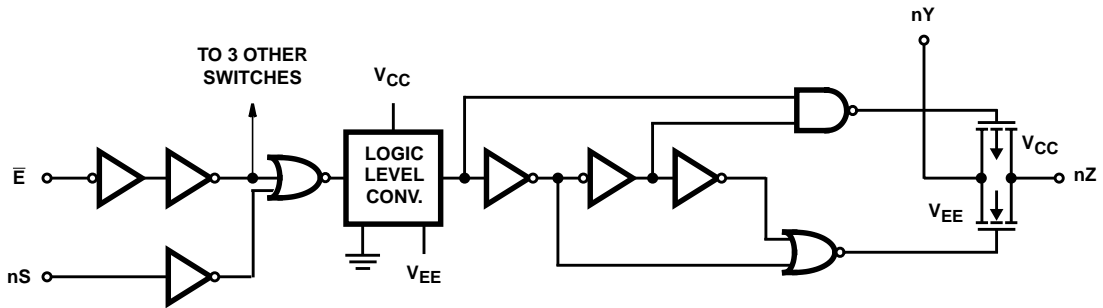

FIGURE 1. ONE SWITCH

CD54HC4316, CD74HC4316, CD74HCT4316

Absolute Maximum Ratings

DC Supply Voltage, V_{CC}	-0.5V to 7V
DC Supply Voltage, $V_{CC} - V_{EE}$	-0.5V to 10.5V
DC Supply Voltage, V_{EE}	0.5V to -7V
DC Input Diode Current, I_{IK}	
For $V_I < -0.5V$ or $V_I > V_{CC} + 0.5V$	$\pm 20mA$
DC Switch Diode Current, I_{OK}	
For $V_I < V_{EE} - 0.5V$ or $V_I < V_{CC} + 0.5V$	$\pm 25mA$
DC Switch Diode Current	
For $V_I > V_{EE} - 0.5V$ or $V_I < V_{CC} + 0.5V$	$\pm 25mA$
DC Output Diode Current, I_{OK}	
For $V_O < -0.5V$ or $V_O > V_{CC} + 0.5V$	$\pm 20mA$
DC Output Source or Sink Current per Output Pin, I_O	
For $V_O > -0.5V$ or $V_O < V_{CC} + 0.5V$	$\pm 25mA$
DC V_{CC} or Ground Current, I_{CC}	$\pm 50mA$

Operating Conditions

Temperature Range, T_A	-55°C to 125°C
Supply Voltage Range, V_{CC}	
HC Types2V to 6V
HCT Types	4.5V to 5.5V
Supply Voltage Range, $V_{CC} - V_{EE}$	
HC, HCT Types (Figure 2)2V to 10V
Supply Voltage Range, V_{EE}	
HC, HCT Types (Figure 3)	0V to -6V
DC Input or Output Voltage, V_I	GND to V_{CC}
Analog Switch I/O Voltage, V_{IS}	V_{EE} (Min)
.....	V_{CC} (Max)
Input Rise and Fall Time, t_r, t_f	
2V	1000ns (Max)
4.5V	500ns (Max)
6V	400ns (Max)

CAUTION: Stresses above those listed in "Absolute Maximum Ratings" may cause permanent damage to the device. This is a stress only rating and operation of the device at these or any other conditions above those indicated in the operational sections of this specification is not implied.

NOTE:

1. The package thermal impedance is calculated in accordance with JESD 51-7.

Thermal Information

Package Thermal Impedance, θ_{JA} (see Note 1):	
E (PDIP) Package	67°C/W
M (SOIC) Package	73°C/W
NS (SOP) Package	64°C/W
PW (TSSOP) Package	108°C/W
Maximum Junction Temperature (Plastic Package)	150°
Maximum Storage Temperature Range	-65°C to 150°
Maximum Lead Temperature (Soldering 10s)	300°
SOIC - Lead Tips Only	

Recommended Operating Area as a Function of Supply Voltage

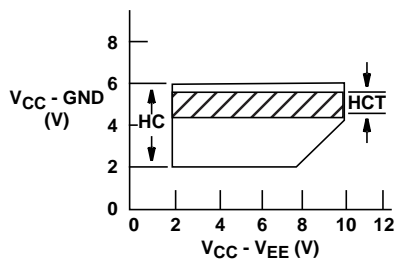

FIGURE 2.

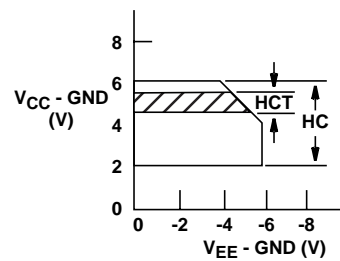

FIGURE 3.

CD54HC4316, CD74HC4316, CD74HCT4316

DC Electrical Specifications

PARAMETER	SYMBOL	TEST CONDITIONS				25°C			-40°C TO 85°C		-55°C TO 125°C		UNITS
		V _I (V)	V _{IS} (V)	V _{EE} (V)	V _{CC} (V)	MIN	TYP	MAX	MIN	MAX	MIN	MAX	
HC TYPES													
High Level Input Voltage	V _{IH}	-	-	-	2	1.5	-	-	1.5	-	1.5	-	V
					4.5	3.15	-	-	3.15	-	3.15	-	V
					6	4.2	-	-	4.2	-	4.2	-	V
Low Level Input Voltage	V _{IL}	-	-	-	2	-	-	0.5	-	0.5	-	0.5	V
					4.5	-	-	1.35	-	1.35	-	1.35	V
					6	-	-	1.8	-	1.8	-	1.8	V
“ON” Resistance I _O = 1mA (Figures 4, 5)	R _{ON}	V _{IH} or V _{IL}	V _{CC} or V _{EE}	0	4.5	-	45	180	-	225	-	270	Ω
				0	6	-	35	160	-	200	-	240	Ω
				-4.5	4.5	-	30	135	-	170	-	205	Ω
			V _{CC} to V _{EE}	0	4.5	-	85	320	-	400	-	480	Ω
				0	6	-	55	240	-	300	-	360	Ω
				-4.5	4.5	-	35	170	-	215	-	255	Ω
Maximum “ON” Resistance Between Any Two Channels	ΔR _{ON}	-	-	0	4.5	-	10	-	-	-	-	-	Ω
				0	6	-	8.5	-	-	-	-	-	Ω
				-4.5	4.5	-	5	-	-	-	-	-	Ω
Switch Off Leakage Current	I _{IZ}	V _{IH} or V _{IL}	V _{CC} - V _{EE}	0	6	-	-	±0.1	-	±1	-	±1	μA
				-5	5	-	-	±0.1	-	±1	-	±1	μA
Control Input Leakage Current	I _{IL}	V _{CC} or GND	-	0	6	-	-	±0.1	-	±1	-	±1	μA
Quiescent Device Current I _O = 0	I _{CC}	V _{CC} or GND	When V _{IS} = V _{EE} , V _{OS} = V _{CC}	0	6	-	-	8	-	80	-	160	μA
				-5	5	-	-	16	-	160	-	320	μA
When V _{IS} = V _{CC} , V _{OS} = V _{EE}				0	6	-	-	8	-	80	-	160	μA
				-5	5	-	-	16	-	160	-	320	μA
HCT TYPES													
High Level Input Voltage	V _{IH}	-	-	-	4.5 to 5.5	2	-	-	2	-	2	-	V
Low Level Input Voltage	V _{IL}	-	-	-	4.5 to 5.5	-	-	0.8	-	0.8	-	0.8	V
“ON” Resistance I _O = 1mA (Figures 4, 5)	R _{ON}	V _{IH} or V _{IL}	V _{CC} or V _{EE}	0	4.5	-	45	180	-	225	-	270	Ω
				-4.5	4.5	-	30	135	-	170	-	205	Ω
			V _{CC} to V _{EE}	0	4.5	-	85	320	-	400	-	480	Ω
				-4.5	4.5	-	35	170	-	215	-	255	Ω
Maximum “ON” Resistance Between Any Two Channels	ΔR _{ON}	-	-	0	4.5	-	10	-	-	-	-	-	Ω
				-4.5	4.5	-	5	-	-	-	-	-	Ω
Switch Off Leakage Current	I _{IZ}	V _{IH} or V _{IL}	V _{CC} - V _{EE}	0	6	-	-	±0.1	-	±1	-	±1	μA
				-5	5	-	-	±0.1	-	±1	-	±1	μA

CD54HC4316, CD74HC4316, CD74HCT4316

DC Electrical Specifications (Continued)

PARAMETER	SYMBOL	TEST CONDITIONS				25°C			-40°C TO 85°C		-55°C TO 125°C		UNITS
		V _I (V)	V _{IS} (V)	V _{EE} (V)	V _{CC} (V)	MIN	TYP	MAX	MIN	MAX	MIN	MAX	
Control Input Leakage Current	I _I	V _{CC} or GND	-	0	5.5	-	-	±0.1	-	±1	-	±1	μA
Quiescent Device Current I _O = 0	I _{CC}	Any Voltage Between V _{CC} and GND	When V _{IS} = V _{EE} , V _{OS} = V _{CC}	0	5.5	-	-	8	-	80	-	160	μA
			When V _{IS} = V _{CC} , V _{OS} = V _{EE}	-4.5	5.5	-	-	16	-	160	-	320	μA
Additional Quiescent Device Current Per Input Pin: 1 Unit Load	ΔI _{CC} (Note 2)	V _{CC} -2.1	-	-	4.5 to 5.5	-	100	360	-	450	-	490	μA

NOTE:

- For dual-supply systems theoretical worst case (V_I = 2.4V, V_{CC} = 5.5V) specification is 1.8mA.

HCT Input Loading Table

INPUT	UNIT LOADS
All	0.5

NOTE: Unit Load is ΔI_{CC} limit specified in DC Electrical Table, e.g., 360μA max at 25°C.

Switching Specifications Input t_r, t_f = 6ns

PARAMETER	SYMBOL	TEST CONDITIONS	V _{EE} (V)	V _{CC} (V)	25°C			-40°C TO 85°C		-55°C TO 125°C		UNITS
					MIN	TYP	MAX	MIN	MAX	MIN	MAX	
HC TYPES												
Propagation Delay, Switch In to Out	t _{PLH} , t _{PHL}	C _L = 50pF	0	2	-	-	60	-	75	-	90	ns
			0	4.5	-	-	12	-	15	-	18	ns
			0	6	-	-	10	-	13	-	15	ns
			-4.5	4.5	-	-	8	-	10	-	12	ns
Turn "ON" Time \bar{E} to Out	t _{PZH} , t _{PZL}	C _L = 50pF	0	2	-	-	205	-	255	-	310	ns
			0	4.5	-	-	41	-	51	-	62	ns
			0	6	-	-	35	-	43	-	53	ns
			-4.5	4.5	-	-	37	-	47	-	56	ns
		C _L = 15pF	-	5	-	17	-	-	-	-	-	ns
Turn "ON" Time nS to Out	t _{PZH} , t _{PZL}	C _L = 50pF	0	2	-	-	175	-	220	-	265	ns
			0	4.5	-	-	35	-	44	-	53	ns
			0	6	-	-	30	-	37	-	45	ns
			-4.5	4.5	-	-	34	-	43	-	51	ns
		C _L = 15pF	-	5	-	14	-	-	-	-	-	ns
Turn "OFF" Time \bar{E} to Out	t _{PLZ} , t _{PHZ}	C _L = 50pF	0	2	-	-	205	-	255	-	310	ns
			0	4.5	-	-	41	-	51	-	62	ns
			0	6	-	-	35	-	43	-	53	ns
			-4.5	4.5	-	-	37	-	47	-	56	ns
		C _L = 15pF	-	5	-	17	-	-	-	-	-	ns

CD54HC4316, CD74HC4316, CD74HCT4316

Switching Specifications Input $t_r, t_f = 6\text{ns}$ (Continued)

PARAMETER	SYMBOL	TEST CONDITIONS	V _{EE} (V)	V _{CC} (V)	25°C			-40°C TO 85°C		-55°C TO 125°C		UNITS
					MIN	TYP	MAX	MIN	MAX	MIN	MAX	
Turn "OFF" Time nS to Out	t _{PLZ} , t _{PHZ}	C _L = 50pF	0	2	-	-	175	-	220	-	265	ns
			0	4.5	-	-	35	-	44	-	53	ns
			0	6	-	-	30	-	37	-	45	ns
			-4.5	4.5	-	-	34	-	43	-	51	ns
		C _L = 15pF	-	5	-	14	-	-	-	-	-	ns
Input (Control) Capacitance	C _I	-	-	-	-	10	-	10	-	10	pF	
Power Dissipation Capacitance (Notes 3, 4)	C _{PD}	-	-	5	-	42	-	-	-	-	pF	
HCT TYPES												
Propagation Delay, Switch In to Switch Out	t _{PLH} , t _{PHL}	C _L = 50pF	0	4.5	-	-	12	-	15	-	18	ns
			-4.5	4.5	-	-	8	-	10	-	12	ns
Turn "ON" Time \bar{E} to Out	t _{PZH}	C _L = 50pF	0	4.5	-	-	44	-	55	-	66	ns
			-4.5	4.5	-	-	42	-	53	-	63	ns
		C _L = 15pF	-	5	-	18	-	-	-	-	-	ns
	t _{PZL}	C _L = 50pF	0	4.5	-	-	56	-	70	-	85	ns
			-4.5	4.5	-	-	42	-	53	-	63	ns
		C _L = 15pF	-	5	-	24	-	-	-	-	-	ns
Turn "ON" Time nS to Out	t _{PZH}	C _L = 50pF	0	4.5	-	-	40	-	53	-	60	ns
			-4.5	4.5	-	-	34	-	43	-	51	ns
		C _L = 15pF	-	5	-	17	-	-	-	-	-	ns
	t _{PZL}	C _L = 50pF	0	4.5	-	-	50	-	63	-	75	ns
			-4.5	4.5	-	-	34	-	43	-	51	ns
		C _L = 15pF	-	5	-	18	-	-	-	-	-	ns
Turn "OFF" Time \bar{E} to Out	t _{PLZ}	C _L = 50pF	0	4.5	-	-	50	-	63	-	75	ns
			-4.5	4.5	-	-	46	-	58	-	69	ns
	t _{PLZ} , t _{PHZ}	C _L = 15pF	-	5	-	21	-	-	-	-	-	ns
			-	5	-	21	-	-	-	-	-	ns
Turn "OFF" Time nS to Out	t _{PHZ}	C _L = 50pF	0	4.5	-	-	44	-	55	-	66	ns
			-4.5	4.5	-	-	40	-	50	-	60	ns
	t _{PLZ} , t _{PHZ}	C _L = 15pF	-	5	-	18	-	-	-	-	-	ns
			-	5	-	18	-	-	-	-	-	ns
Input (Control) Capacitance	C _I	-	-	-	-	10	-	10	-	10	pF	
Power Dissipation Capacitance (Notes 3, 4)	C _{PD}	-	-	5	-	47	-	-	-	-	pF	

NOTES:

- C_{PD} is used to determine the dynamic power consumption, per package.
- $P_D = C_{PD} V_{CC}^2 f_i + \sum (C_L + C_S) V_{CC}^2 f_o$ where f_i = input frequency, f_o = output frequency, C_L = output load capacitance, C_S = switch capacitance, V_{CC} = supply voltage.

Analog Channel Specifications T_A = 25°C

PARAMETER	TEST CONDITIONS	V _{CC} (V)	HC4316	CD74HCT4316	UNITS
Switch Frequency Response Bandwidth at -3dB (Figure 6)	Figure 9 (Notes 5, 6)	4.5	>200	>200	MHz
Crosstalk Between Any Two Switches (Figure 7)	Figure 8 (Notes 6, 7)	4.5	TBE	TBE	dB

CD54HC4316, CD74HC4316, CD74HCT4316

Analog Channel Specifications $T_A = 25^\circ\text{C}$ (Continued)

PARAMETER	TEST CONDITIONS	V_{CC} (V)	HC4316	CD74HCT4316	UNITS
Total Harmonic Distortion	1kHz, $V_{IS} = 4V_{P-P}$ (Figure 10)	4.5	0.078	0.078	%
	1kHz, $V_{IS} = 8V_{P-P}$ (Figure 10)	9	0.018	0.018	%
Control to Switch Feedthrough Noise	Figure 11	4.5	TBE	TBE	mV
		9	TBE	TBE	mV
Switch "OFF" Signal Feedthrough (Figure 7)	Figure 12 (Notes 6, 7)	4.5	-62	-62	dB
Switch Input Capacitance, C_S	-	-	5	5	pF

NOTES:

5. Adjust input level for 0dBm at output, $f = 1\text{MHz}$.
6. V_{IS} is centered at $V_{CC}/2$.
7. Adjust input for 0dBm at V_{IS} .

Typical Performance Curves

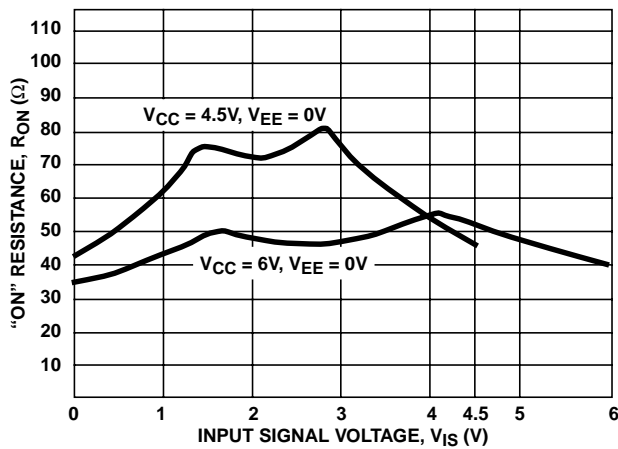

FIGURE 4. TYPICAL "ON" RESISTANCE vs INPUT SIGNAL VOLTAGE

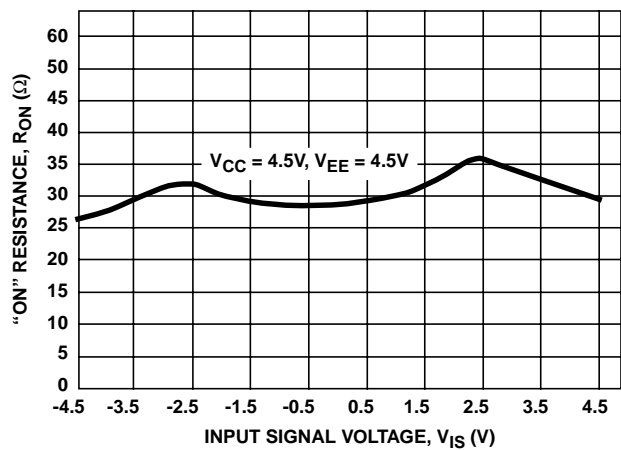

FIGURE 5. TYPICAL "ON" RESISTANCE vs INPUT SIGNAL VOLTAGE

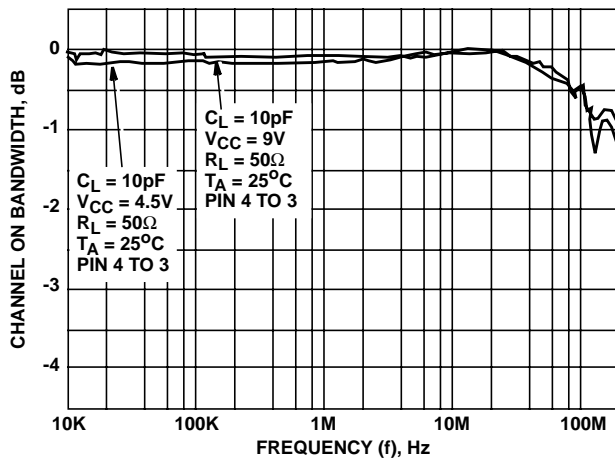

FIGURE 6. SWITCH FREQUENCY RESPONSE

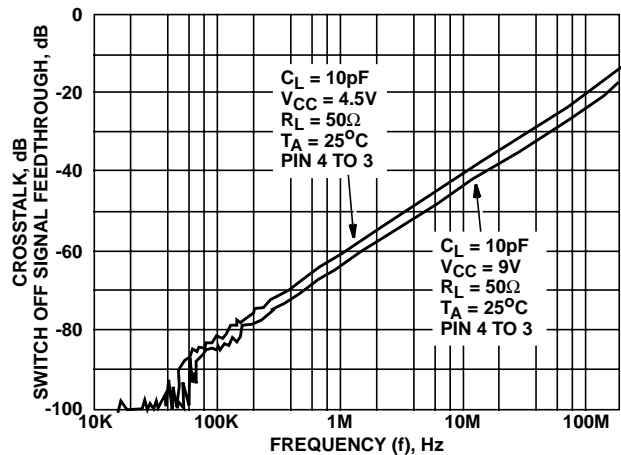

FIGURE 7. SWITCH-OFF SIGNAL FEEDTHROUGH AND CROSSTALK vs FREQUENCY

Analog Test Circuits

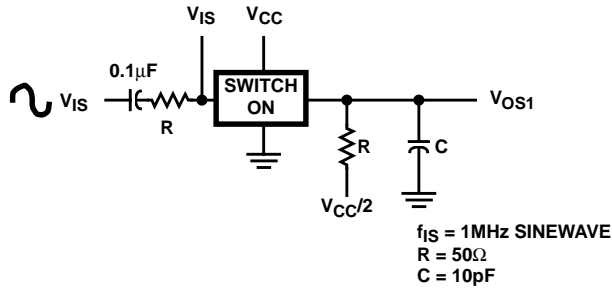

FIGURE 8. CROSTALK BETWEEN TWO SWITCHES TEST CIRCUIT

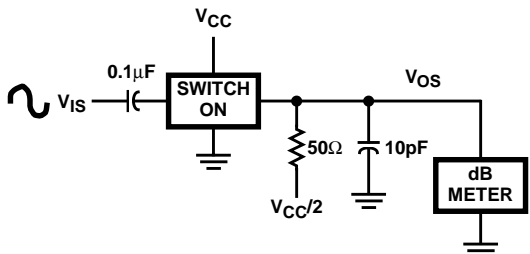
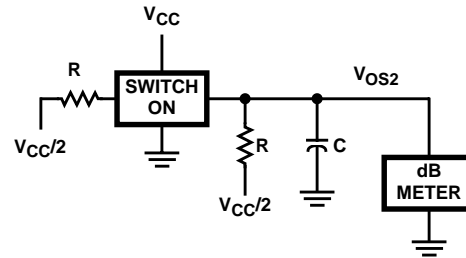

FIGURE 9. FREQUENCY RESPONSE TEST CIRCUIT

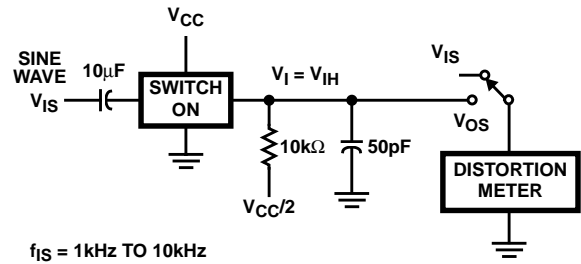

FIGURE 10. TOTAL HARMONIC DISTORTION TEST CIRCUIT

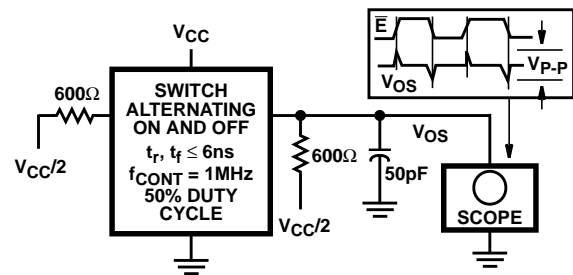

FIGURE 11. CONTROL-TO-SWITCH FEEDTHROUGH NOISE TEST CIRCUIT

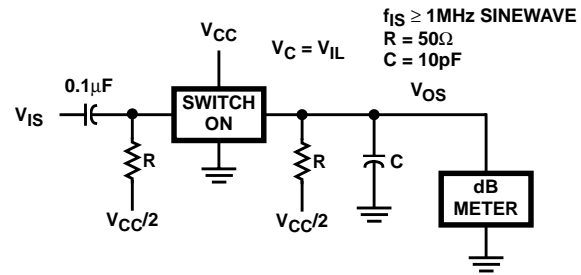

FIGURE 12. SWITCH OFF SIGNAL FEEDTHROUGH

Test Circuits and Waveforms

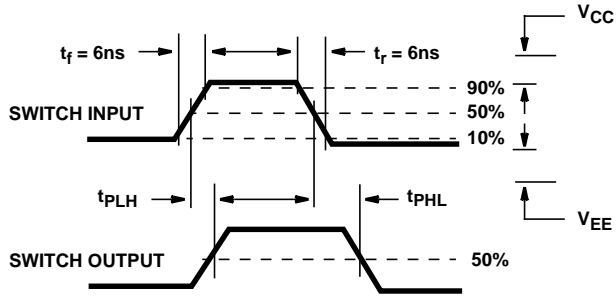

FIGURE 13. SWITCH PROPAGATION DELAY TIMES

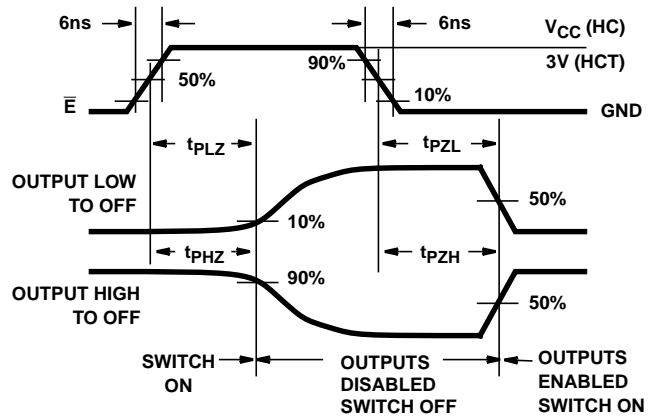
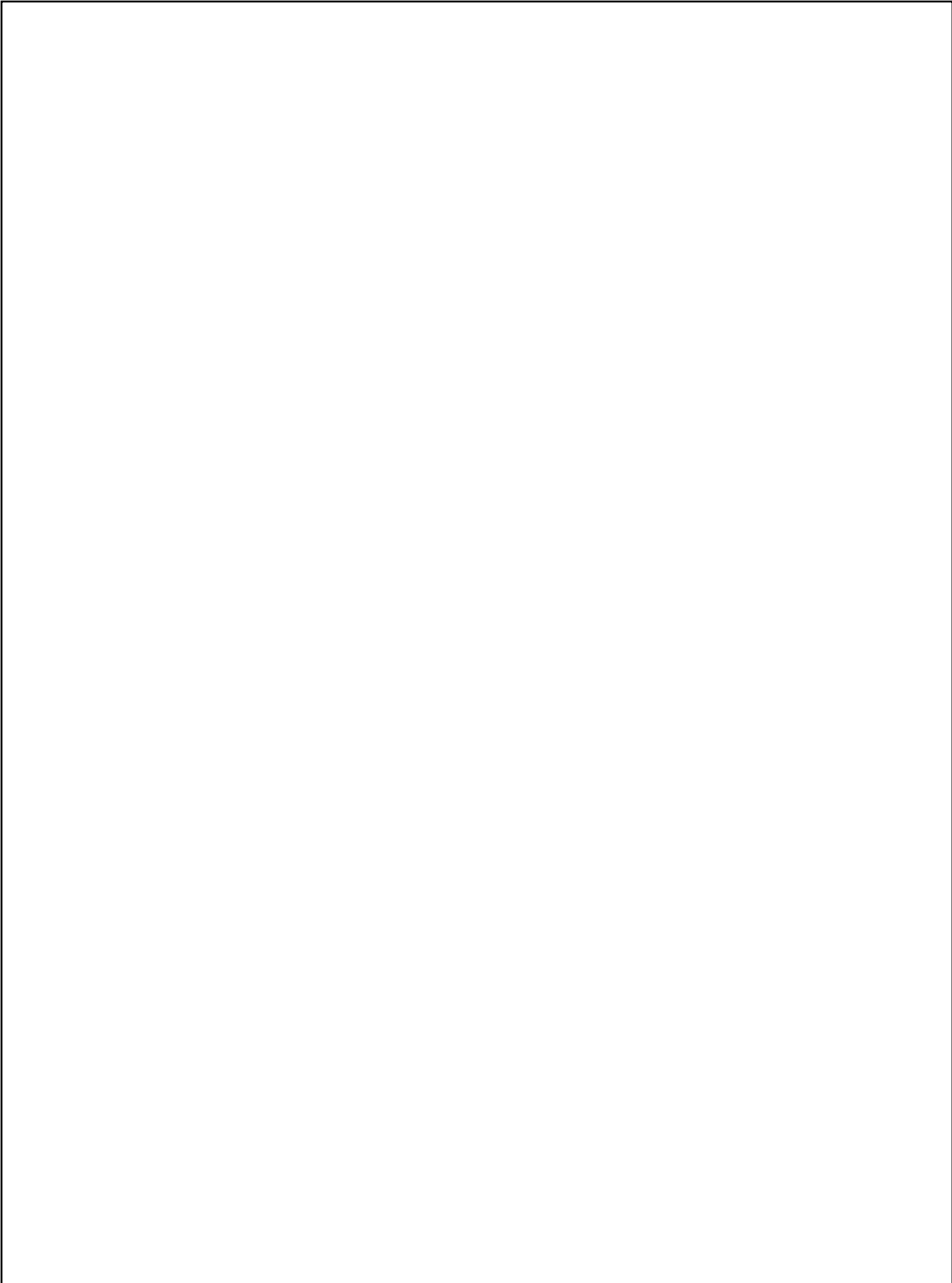

FIGURE 14. SWITCH TURN-ON AND TURN-OFF PROPAGATION DELAY TIMES WAVEFORMS



PACKAGING INFORMATION

Orderable Device	Status (1)	Package Type	Package Drawing	Pins	Package Qty	Eco Plan (2)	Lead finish/ Ball material (6)	MSL Peak Temp (3)	Op Temp (°C)	Device Marking (4/5)	Samples
CD54HC4316F3A	ACTIVE	CDIP	J	16	1	Non-RoHS & Green	SNPB	N / A for Pkg Type	-55 to 125	CD54HC4316F3A	Samples
CD74HC4316E	ACTIVE	PDIP	N	16	25	RoHS & Green	NIPDAU	N / A for Pkg Type	-55 to 125	CD74HC4316E	Samples
CD74HC4316M	ACTIVE	SOIC	D	16	40	RoHS & Green	NIPDAU	Level-1-260C-UNLIM	-55 to 125	HC4316M	Samples
CD74HC4316M96	ACTIVE	SOIC	D	16	2500	RoHS & Green	NIPDAU	Level-1-260C-UNLIM	-55 to 125	HC4316M	Samples
CD74HC4316ME4	ACTIVE	SOIC	D	16	40	RoHS & Green	NIPDAU	Level-1-260C-UNLIM	-55 to 125	HC4316M	Samples
CD74HC4316MG4	ACTIVE	SOIC	D	16	40	RoHS & Green	NIPDAU	Level-1-260C-UNLIM	-55 to 125	HC4316M	Samples
CD74HC4316NSR	ACTIVE	SO	NS	16	2000	RoHS & Green	NIPDAU	Level-1-260C-UNLIM	-55 to 125	HC4316M	Samples
CD74HC4316PW	ACTIVE	TSSOP	PW	16	90	RoHS & Green	NIPDAU	Level-1-260C-UNLIM	-55 to 125	HJ4316	Samples
CD74HC4316PWR	ACTIVE	TSSOP	PW	16	2000	RoHS & Green	NIPDAU	Level-1-260C-UNLIM	-55 to 125	HJ4316	Samples
CD74HCT4316E	ACTIVE	PDIP	N	16	25	RoHS & Green	NIPDAU	N / A for Pkg Type	-55 to 125	CD74HCT4316E	Samples
CD74HCT4316M	ACTIVE	SOIC	D	16	40	RoHS & Green	NIPDAU	Level-1-260C-UNLIM	-55 to 125	HCT4316M	Samples
CD74HCT4316M96	ACTIVE	SOIC	D	16	2500	RoHS & Green	NIPDAU	Level-1-260C-UNLIM	-55 to 125	HCT4316M	Samples

(1) The marketing status values are defined as follows:

ACTIVE: Product device recommended for new designs.

LIFEBUY: TI has announced that the device will be discontinued, and a lifetime-buy period is in effect.

NRND: Not recommended for new designs. Device is in production to support existing customers, but TI does not recommend using this part in a new design.

PREVIEW: Device has been announced but is not in production. Samples may or may not be available.

OBsolete: TI has discontinued the production of the device.

(2) **RoHS:** TI defines "RoHS" to mean semiconductor products that are compliant with the current EU RoHS requirements for all 10 RoHS substances, including the requirement that RoHS substance do not exceed 0.1% by weight in homogeneous materials. Where designed to be soldered at high temperatures, "RoHS" products are suitable for use in specified lead-free processes. TI may reference these types of products as "Pb-Free".

RoHS Exempt: TI defines "RoHS Exempt" to mean products that contain lead but are compliant with EU RoHS pursuant to a specific EU RoHS exemption.

Green: TI defines "Green" to mean the content of Chlorine (Cl) and Bromine (Br) based flame retardants meet JS709B low halogen requirements of <=1000ppm threshold. Antimony trioxide based flame retardants must also meet the <=1000ppm threshold requirement.

- (3) MSL, Peak Temp. - The Moisture Sensitivity Level rating according to the JEDEC industry standard classifications, and peak solder temperature.
- (4) There may be additional marking, which relates to the logo, the lot trace code information, or the environmental category on the device.
- (5) Multiple Device Markings will be inside parentheses. Only one Device Marking contained in parentheses and separated by a "~" will appear on a device. If a line is indented then it is a continuation of the previous line and the two combined represent the entire Device Marking for that device.
- (6) Lead finish/Ball material - Orderable Devices may have multiple material finish options. Finish options are separated by a vertical ruled line. Lead finish/Ball material values may wrap to two lines if the finish value exceeds the maximum column width.

Important Information and Disclaimer:The information provided on this page represents TI's knowledge and belief as of the date that it is provided. TI bases its knowledge and belief on information provided by third parties, and makes no representation or warranty as to the accuracy of such information. Efforts are underway to better integrate information from third parties. TI has taken and continues to take reasonable steps to provide representative and accurate information but may not have conducted destructive testing or chemical analysis on incoming materials and chemicals. TI and TI suppliers consider certain information to be proprietary, and thus CAS numbers and other limited information may not be available for release.

In no event shall TI's liability arising out of such information exceed the total purchase price of the TI part(s) at issue in this document sold by TI to Customer on an annual basis.

OTHER QUALIFIED VERSIONS OF CD54HC4316, CD74HC4316 :

- Catalog : [CD74HC4316](#)
- Military : [CD54HC4316](#)

NOTE: Qualified Version Definitions:

- Catalog - TI's standard catalog product
- Military - QML certified for Military and Defense Applications

TAPE AND REEL INFORMATION

QUADRANT ASSIGNMENTS FOR PIN 1 ORIENTATION IN TAPE

*All dimensions are nominal

Device	Package Type	Package Drawing	Pins	SPQ	Reel Diameter (mm)	Reel Width W1 (mm)	A0 (mm)	B0 (mm)	K0 (mm)	P1 (mm)	W (mm)	Pin1 Quadrant
CD74HC4316M96	SOIC	D	16	2500	330.0	16.4	6.5	10.3	2.1	8.0	16.0	Q1
CD74HC4316NSR	SO	NS	16	2000	330.0	16.4	8.2	10.5	2.5	12.0	16.0	Q1
CD74HC4316PWR	TSSOP	PW	16	2000	330.0	12.4	6.9	5.6	1.6	8.0	12.0	Q1
CD74HCT4316M96	SOIC	D	16	2500	330.0	16.4	6.5	10.3	2.1	8.0	16.0	Q1

TAPE AND REEL BOX DIMENSIONS

*All dimensions are nominal

Device	Package Type	Package Drawing	Pins	SPQ	Length (mm)	Width (mm)	Height (mm)
CD74HC4316M96	SOIC	D	16	2500	340.5	336.1	32.0
CD74HC4316NSR	SO	NS	16	2000	356.0	356.0	35.0
CD74HC4316PWR	TSSOP	PW	16	2000	356.0	356.0	35.0
CD74HCT4316M96	SOIC	D	16	2500	340.5	336.1	32.0

TUBE

*All dimensions are nominal

Device	Package Name	Package Type	Pins	SPQ	L (mm)	W (mm)	T (μm)	B (mm)
CD74HC4316E	N	PDIP	16	25	506	13.97	11230	4.32
CD74HC4316E	N	PDIP	16	25	506	13.97	11230	4.32
CD74HC4316M	D	SOIC	16	40	507	8	3940	4.32
CD74HC4316ME4	D	SOIC	16	40	507	8	3940	4.32
CD74HC4316MG4	D	SOIC	16	40	507	8	3940	4.32
CD74HC4316PW	PW	TSSOP	16	90	530	10.2	3600	3.5
CD74HCT4316E	N	PDIP	16	25	506	13.97	11230	4.32
CD74HCT4316E	N	PDIP	16	25	506	13.97	11230	4.32
CD74HCT4316M	D	SOIC	16	40	507	8	3940	4.32

D (R-PDSO-G16)

PLASTIC SMALL OUTLINE



- NOTES:
- A. All linear dimensions are in inches (millimeters).
 - B. This drawing is subject to change without notice.
 - C. Body length does not include mold flash, protrusions, or gate burrs. Mold flash, protrusions, or gate burrs shall not exceed 0.006 (0,15) each side.
 - D. Body width does not include interlead flash. Interlead flash shall not exceed 0.017 (0,43) each side.
 - E. Reference JEDEC MS-012 variation AC.

D (R-PDSO-G16)

PLASTIC SMALL OUTLINE



- NOTES:
- A. All linear dimensions are in millimeters.
 - B. This drawing is subject to change without notice.
 - C. Publication IPC-7351 is recommended for alternate designs.
 - D. Laser cutting apertures with trapezoidal walls and also rounding corners will offer better paste release. Customers should contact their board assembly site for stencil design recommendations. Refer to IPC-7525 for other stencil recommendations.
 - E. Customers should contact their board fabrication site for solder mask tolerances between and around signal pads.

PW0016A

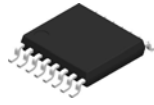

PACKAGE OUTLINE

TSSOP - 1.2 mm max height

SMALL OUTLINE PACKAGE

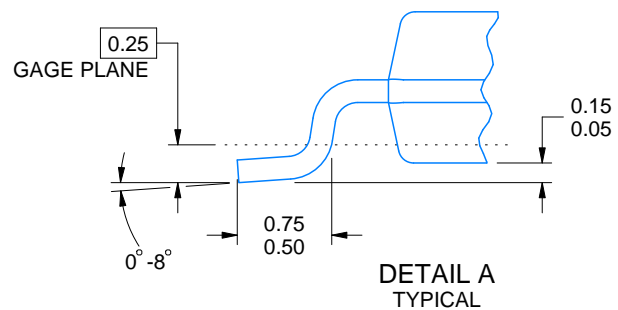
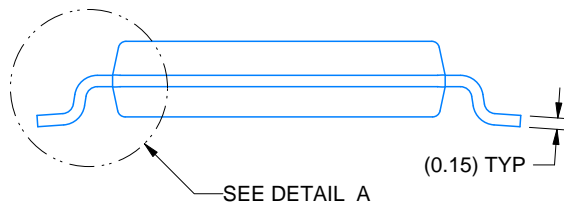
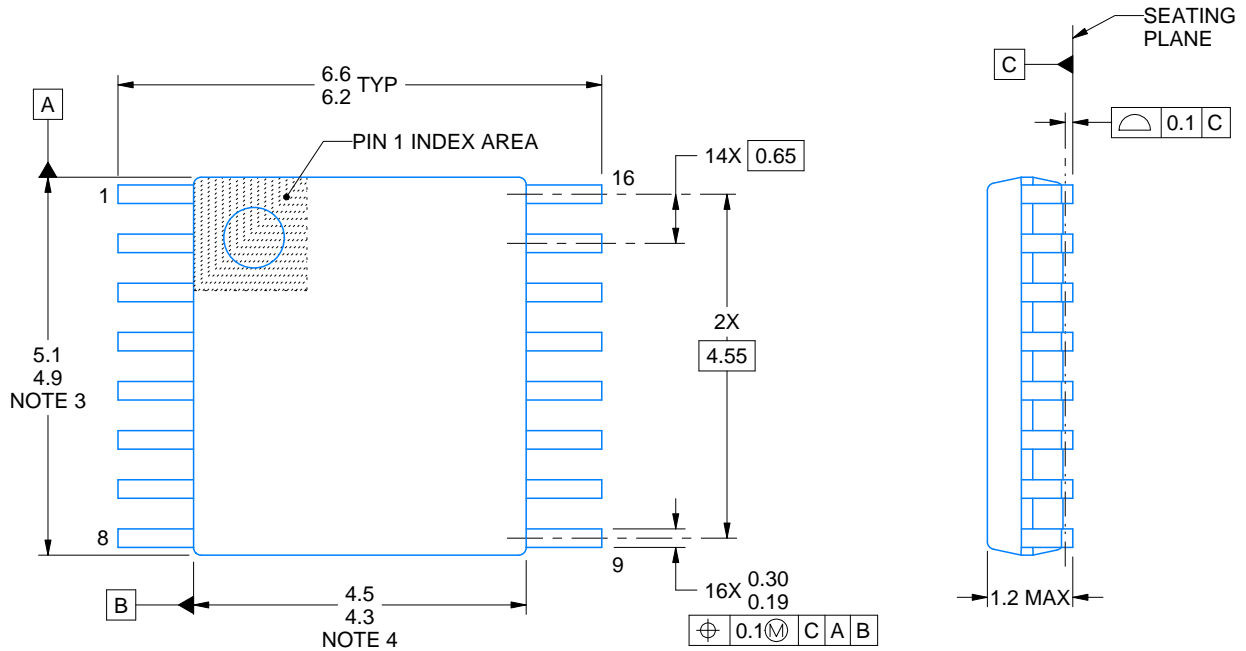

4220204/A 02/2017

NOTES:

1. All linear dimensions are in millimeters. Any dimensions in parenthesis are for reference only. Dimensioning and tolerancing per ASME Y14.5M.
2. This drawing is subject to change without notice.
3. This dimension does not include mold flash, protrusions, or gate burrs. Mold flash, protrusions, or gate burrs shall not exceed 0.15 mm per side.
4. This dimension does not include interlead flash. Interlead flash shall not exceed 0.25 mm per side.
5. Reference JEDEC registration MO-153.

EXAMPLE BOARD LAYOUT

PW0016A

TSSOP - 1.2 mm max height

SMALL OUTLINE PACKAGE



LAND PATTERN EXAMPLE
EXPOSED METAL SHOWN
SCALE: 10X



SOLDER MASK DETAILS

4220204/A 02/2017

NOTES: (continued)

- 6. Publication IPC-7351 may have alternate designs.
- 7. Solder mask tolerances between and around signal pads can vary based on board fabrication site.

EXAMPLE STENCIL DESIGN

PW0016A

TSSOP - 1.2 mm max height

SMALL OUTLINE PACKAGE



SOLDER PASTE EXAMPLE
BASED ON 0.125 mm THICK STENCIL
SCALE: 10X

4220204/A 02/2017

NOTES: (continued)

8. Laser cutting apertures with trapezoidal walls and rounded corners may offer better paste release. IPC-7525 may have alternate design recommendations.
9. Board assembly site may have different recommendations for stencil design.

MECHANICAL DATA

NS (R-PDSO-G**)

PLASTIC SMALL-OUTLINE PACKAGE

14-PINS SHOWN



- NOTES:
- A. All linear dimensions are in millimeters.
 - B. This drawing is subject to change without notice.
 - C. Body dimensions do not include mold flash or protrusion, not to exceed 0,15.

N (R-PDIP-T**)

PLASTIC DUAL-IN-LINE PACKAGE

16 PINS SHOWN



- NOTES:
- A. All linear dimensions are in inches (millimeters).
 - B. This drawing is subject to change without notice.
 - Falls within JEDEC MS-001, except 18 and 20 pin minimum body length (Dim A).
 - The 20 pin end lead shoulder width is a vendor option, either half or full width.



PACKAGE OUTLINE

NS0016A

SOP - 2.00 mm max height

SOP



4220735/A 12/2021

NOTES:

1. All linear dimensions are in millimeters. Dimensions in parenthesis are for reference only. Dimensioning and tolerancing per ASME Y14.5M.
2. This drawing is subject to change without notice.
3. This dimension does not include mold flash, protrusions, or gate burrs. Mold flash, protrusions, or gate burrs shall not exceed 0.15 mm, per side.
4. This dimension does not include interlead flash. Interlead flash shall not exceed 0.25 mm, per side.

EXAMPLE BOARD LAYOUT

NS0016A

SOP - 2.00 mm max height

SOP



4220735/A 12/2021

NOTES: (continued)

5. Publication IPC-7351 may have alternate designs.

6. Solder mask tolerances between and around signal pads can vary based on board fabrication site.

EXAMPLE STENCIL DESIGN

NS0016A

SOP - 2.00 mm max height

SOP



SOLDER PASTE EXAMPLE
BASED ON 0.125 mm THICK STENCIL
SCALE:7X

4220735/A 12/2021

NOTES: (continued)

7. Laser cutting apertures with trapezoidal walls and rounded corners may offer better paste release. IPC-7525 may have alternate design recommendations.
8. Board assembly site may have different recommendations for stencil design.

IMPORTANT NOTICE AND DISCLAIMER

TI PROVIDES TECHNICAL AND RELIABILITY DATA (INCLUDING DATA SHEETS), DESIGN RESOURCES (INCLUDING REFERENCE DESIGNS), APPLICATION OR OTHER DESIGN ADVICE, WEB TOOLS, SAFETY INFORMATION, AND OTHER RESOURCES "AS IS" AND WITH ALL FAULTS, AND DISCLAIMS ALL WARRANTIES, EXPRESS AND IMPLIED, INCLUDING WITHOUT LIMITATION ANY IMPLIED WARRANTIES OF MERCHANTABILITY, FITNESS FOR A PARTICULAR PURPOSE OR NON-INFRINGEMENT OF THIRD PARTY INTELLECTUAL PROPERTY RIGHTS.

These resources are intended for skilled developers designing with TI products. You are solely responsible for (1) selecting the appropriate TI products for your application, (2) designing, validating and testing your application, and (3) ensuring your application meets applicable standards, and any other safety, security, regulatory or other requirements.

These resources are subject to change without notice. TI grants you permission to use these resources only for development of an application that uses the TI products described in the resource. Other reproduction and display of these resources is prohibited. No license is granted to any other TI intellectual property right or to any third party intellectual property right. TI disclaims responsibility for, and you will fully indemnify TI and its representatives against, any claims, damages, costs, losses, and liabilities arising out of your use of these resources.

TI's products are provided subject to [TI's Terms of Sale](#) or other applicable terms available either on ti.com or provided in conjunction with such TI products. TI's provision of these resources does not expand or otherwise alter TI's applicable warranties or warranty disclaimers for TI products.

TI objects to and rejects any additional or different terms you may have proposed.

Mailing Address: Texas Instruments, Post Office Box 655303, Dallas, Texas 75265
Copyright © 2022, Texas Instruments Incorporated