

UCD7138 具有体二极管导通感测和报告功能的 4A/6A 单通道同步整流器驱动器

1 特性

- 具有体二极管导通感测功能的低侧栅极驱动器
- 栅极关断边沿体二极管导通报告功能
- 栅极导通边沿延迟优化
- 与 UCD3138A 系列数字电源控制器中的死区补偿 (DTC) 模块搭配使用：
 - 支持自动或手动调节栅极导通边沿和关断边沿的死区
 - 负电流保护
- -150mV 体二极管导通感测阈值
- 能够感测短至 10ns 的体二极管导通时间
- 4A 峰值拉电流和 6A 峰值灌电流非对称驱动能力
- 短暂传播延迟（典型值为 14ns）
- 短暂上升和下降时间（典型值为 5ns）
- 高达 2MHz 的工作频率
- 4.5V 至 18V 电源范围
- 轨到轨驱动能力
- V_{CC} 欠压闭锁 (UVLO)
- 6 引脚 3mm x 3mm 引脚超薄型四方扁平无引线 (WQFN)-6 封装

2 应用

- LLC 转换器
- 硬开关全桥转换器
- 数字电源控制应用

3 说明

UCD7138 器件是一款具有体二极管导通感测和报告功能的 4A/6A 单通道金属氧化物半导体场效应晶体管 (MOSFET) 驱动器，这款高性能驱动器可使德州仪器的 UCD3138A 数字脉宽调制 (PWM) 控制器实现高级同步整流 (SR) 控制。这款器件包含高速栅极驱动器、体二极管导通感测电路和导通延迟优化电路。该器件非常适合需要优化 SR 死区的高功率、高效率隔离式转换器应用。

UCD7138 器件具备 4A 峰值拉电流和 6A 峰值灌电流非对称轨到轨驱动能力。短暂的传播延迟以及上升和下降时间使得该器件在高频条件下能够高效运行。该器件内置一个阈值为 -150mV 的高速比较器，可检测体二极管的导通情况并将该信息报告给 UCD3138A 数字电源控制器。UCD7138 器件能够感测短至 10ns 的体二极管导通时间。UCD7138 器件将对 SR 导通边沿进行优化。UCD3138A 数字电源控制器将分析由 UCD7138 DTC 引脚报告的体二极管导通信息，从而对 SR 关断边沿进行优化。

这一芯片组可最大限度缩短体二极管的导通时间以实现系统效率最大化，同时兼具稳定而快速的负电流保护和简单接口优势。

器件信息⁽¹⁾

器件型号	封装	封装尺寸 (标称值)
UCD7138	WSON (6)	3.00mm x 3.00mm

(1) 如需了解所有可用封装，请见数据表末尾的可订购产品附录。

4 简化电路原理图

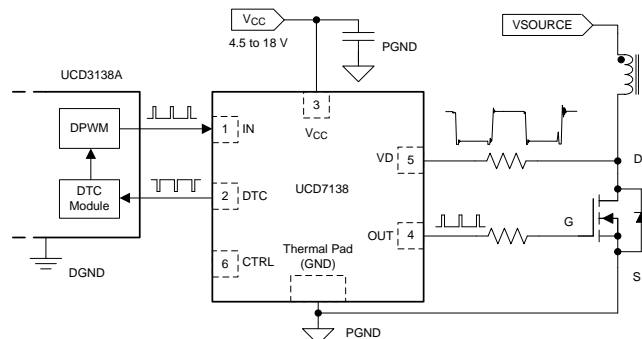

340W LLC 应用的节能曲线

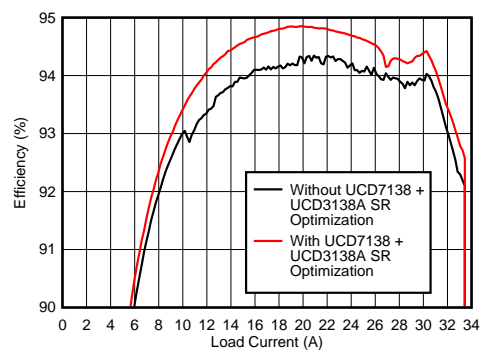

D001



目录

1	特性	1	8.3	Feature Description	12
2	应用	1	8.4	Device Functional Modes	14
3	说明	1	9	Application and Implementation	15
4	简化电路原理图	1	9.1	Application Information	15
5	修订历史记录	2	9.2	Typical Application	15
6	Pin Configuration and Functions	3	10	Power Supply Recommendations	26
7	Specifications	4	11	Layout	26
7.1	Absolute Maximum Ratings	4	11.1	Layout Guidelines	26
7.2	ESD Ratings	4	11.2	Layout Example	27
7.3	Recommended Operating Conditions	4	12	器件和文档支持	28
7.4	Thermal Information	4	12.1	文档支持	28
7.5	Electrical Characteristics	5	12.2	社区资源	28
7.6	Switching Characteristics	6	12.3	商标	28
7.7	Typical Characteristics	7	12.4	静电放电警告	28
8	Detailed Description	11	12.5	术语表	28
8.1	Overview	11	13	机械、封装和可订购信息	28
8.2	Functional Block Diagram	11			

5 修订历史记录

Changes from Revision A (April 2015) to Revision B

Page

- | | |
|-------------------------------|----------|
| • 已更改 器件状态：从产品预览更改为量产数据 | 1 |
|-------------------------------|----------|

6 Pin Configuration and Functions

DRS Package
6-Pin WSON With Exposed Thermal Pad
Top View

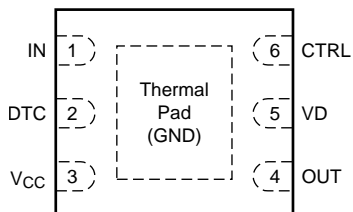

Pin Functions

PIN		TYPE	DESCRIPTION
NO.	NAME		
1	IN	I	Input: Gate driver input. This pin should be connected directly to the DPWM output of the digital controller.
2	DTC	O	Body-diode conduction-time report: Standard digital IO. Pulled high internally. Output low when the body diode is conducting. This pin should be connected to the DTC0 or DTC1 pin on UCD3138A.
3	V _{CC}	P	IC supply: External bias supply input. The supply range is 4.5-V to 18-V. A ceramic bypass capacitor of at least 1 μF should be placed as close as possible to the V _{CC} pin and the thermal pad. Where possible, use thick & wide Cu connections.
4	OUT	O	Gate driver output: Integrated push-pull gate driver for one or more external power MOSFETs. Typical 4-A source and 6-A sink capability. This is a rail-to-rail output, with the rails defined by the voltages on V _{CC} and GND. This pin should be connected to the gate terminal of the synchronous rectification MOSFET.
5	VD	I	Drain voltage: Connect this pin as close as possible to the controlled-MOSFET drain pad. This pin is internally connected to the diode conduction detection comparator. The comparator has a –0.15-V threshold to detect body-diode conduction. A 20-Ω resistor should be connected between the VD pin and MOSFET drain terminal to limit the current. The maximum voltage of the VD pin should not exceed 45 V. A simple external circuit can enable the usage of much higher voltages, see Figure 34 .
6	CTRL	I	Rising edge optimization control: Connect this pin to ground to disable rising edge optimization. Leave this pin floating or connect it to logic high to enable rising edge optimization.
—	Thermal Pad (GND)	—	Exposed thermal pad: The exposed pad on the bottom of the package enhances the thermal performance of the device. This pad is the device ground reference.

7 Specifications

7.1 Absolute Maximum Ratings

 over operating free-air temperature range (unless otherwise noted) ⁽¹⁾

		MIN	MAX	UNIT
Input voltage	V _{CC}	-0.3	20	V
	IN, CRTL	-0.3	3.8	
	VD	-1	45	
Maximum V _{CC} continuous input current	DC current		50	mA
Output current, peak (pulse)			6	A
Switching frequency, f _S			2000	kHz
Operating junction temperature, T _J		-40	125	°C
Lead temperature, soldering, 10 s, T _(SOL)			300	°C
Storage temperature, T _{stg}		-65	150	°C

- (1) Stresses beyond those listed under *Absolute Maximum Ratings* may cause permanent damage to the device. These are stress ratings only, which do not imply functional operation of the device at these or any other conditions beyond those indicated under *Recommended Operating Conditions*. Exposure to absolute-maximum-rated conditions for extended periods may affect device reliability.

7.2 ESD Ratings

		VALUE	UNIT
V _(ESD) Electrostatic discharge	Human body model (HBM), per ANSI/ESDA/JEDEC JS-001, all pins ⁽¹⁾	±2000	V
	Charged device model (CDM), per JEDEC specification JESD22-C101, all pins ⁽²⁾	±500	

- (1) JEDEC document JEP155 states that 500-V HBM allows safe manufacturing with a standard ESD control process.
 (2) JEDEC document JEP157 states that 250-V CDM allows safe manufacturing with a standard ESD control process.

7.3 Recommended Operating Conditions

over operating free-air temperature range (unless otherwise noted)

		MIN	NOM	MAX	UNIT
V _{CC}	V _{CC} input voltage from a low impedance source	4.5		18	V
V _{IN}	Input voltage	0		3.6	V
C _(BP)	V _{CC} bypass capacitor	1			μF
T _J	Operating junction temperature	-40		125	°C

7.4 Thermal Information

THERMAL METRIC ⁽¹⁾		UCD7138	UNIT
		DRS (WSON)	
		6 PINS	
R _{θJA}	Junction-to-ambient thermal resistance	73.4	°C/W
R _{θJC(top)}	Junction-to-case (top) thermal resistance	84.2	
R _{θJB}	Junction-to-board thermal resistance	46.3	
ψ _{JT}	Junction-to-top characterization parameter	2.6	
ψ _{JB}	Junction-to-board characterization parameter	46.4	
R _{θJC(bot)}	Junction-to-case (bottom) thermal resistance	12.4	

- (1) For more information about traditional and new thermal metrics, see the *Semiconductor and IC Package Thermal Metrics* application report, [SPRA953](#).

7.5 Electrical Characteristics

At $V_{CC} = 12 V_{DC}$, $-40^{\circ}C < T_J = T_A < 125^{\circ}C$, $1\mu F$ capacitor from V_{CC} to GND, all voltages are with respect to ground and currents are positive into and negative out of the specified terminal, unless otherwise noted. Typical values are at $T_J = 25^{\circ}C$.

PARAMETER		TEST CONDITIONS	MIN	TYP	MAX	UNIT
VCC BIAS SUPPLY						
$I_{CC(UV)}$	V_{CC} current, undervoltage	$V_{CC} = 3.4 V$		122	186	μA
$I_{CC(ON)}$	V_{CC} current, no switching	$V_{CC} = 12 V$		0.85	1.1	mA
$I_{CC(OPERATE)}$	V_{CC} current, normal operation ⁽¹⁾	$V_{CC} = 12 V$, $C_{(LOAD)} = 10 nF$, $f = 100 kHz$		13	17	mA
GATE INPUT (IN)						
V_{IH}	Input signal high threshold		1.93	2.03	2.10	V
V_{IL}	Input signal low threshold		0.98	1.03	1.08	V
$V_{I(hys)}$	Input hysteresis		0.90	1.00		V
DTC OUTPUT						
$V_{OL(DTC)}$	Low level output voltage				0.25	V
$V_{OH(DTC)}$	High level output voltage		2.5			V
$I_{OH(DTC)}$	Output sinking current				4	mA
$I_{OL(DTC)}$	Output sourcing current		-4			mA
V_{DTC}	Maximum DTC pin output voltage			3.5	3.6	V
UNDervOLTAGE LOCKOUT SECTION (UVLO)						
$V_{CC(ON)}$	V_{CC} turnon threshold		3.30	3.80	4.30	V
$V_{CC(OFF)}$	V_{CC} turnoff threshold		3.10	3.56	4.02	V
$V_{CC(hys)}$	UVLO hysteresis	$V_{CC(hys)} = V_{CC(ON)} - V_{CC(OFF)}$		0.24		V
COMPARATOR						
V_{TH}	Body diode conduction sensing threshold		-179	-147	-113	mV
$C_{I(VD-ground)}$	Differential input capacitance between VD and ground ⁽¹⁾	$V_D = -150 mV$		20		pF
GATE DRIVER						
$V_{CC-V_{OH}}$	Output high voltage	$I_{OUT} = -10 mA$		0.038	0.064	V
V_{OL}	Output low voltage	$I_{OUT} = 10 mA$		0.0025	0.009	V
$R_{(UP)}$	Pullup resistance	$T_A = 25^{\circ}C$, $I_{OUT} = -25 mA$ to $-50 mA$		5	6.1	Ω
		$T_A = -40^{\circ}C$ to $125^{\circ}C$, $I_{OUT} = -50 mA$		5	6.3	Ω
$R_{(DOWN)}$	Pulldown resistance	$T_A = 25^{\circ}C$, $I_{OUT} = 25 mA$ to $50 mA$		0.31	0.44	Ω
		$T_A = -40^{\circ}C$ to $125^{\circ}C$, $I_{OUT} = 50 mA$		0.33	0.45	Ω
$I_{O(source)}$	Output peak current (source) ⁽¹⁾	$C_{(LOAD)} = 0.22 \mu F$, $f_S = 1 kHz$, 5-V output		-4		A
$I_{O(sink)}$	Output peak current (sink) ⁽¹⁾	$C_{(LOAD)} = 0.22 \mu F$, $f_S = 1 kHz$, 5-V output		6		A

(1) Ensured by Design, not tested in Production.

7.6 Switching Characteristics

At $V_{CC} = 12 V_{DC}$, $-40^{\circ}C < T_J = T_A < 125^{\circ}C$, $1\mu F$ capacitor from V_{CC} to GND, all voltages are with respect to ground and currents are positive into and negative out of the specified terminal, unless otherwise noted. Typical values are at $T_J = 25^{\circ}C$.

PARAMETER		TEST CONDITIONS	MIN	TYP	MAX	UNIT
t_r	Rise time	$C_{(LOAD)} = 1\text{ nF}$, $V_{CC} = 5\text{ V}$, See 图 1 and 图 24		5	8	ns
		$C_{(LOAD)} = 1\text{ nF}$, $V_{CC} = 12\text{ V}$, See 图 1 and 图 24		4	8	ns
t_f	Fall time	$C_{(LOAD)} = 1\text{ nF}$, $V_{CC} = 5\text{ V}$, See 图 1 and 图 24		3.36	5	ns
		$C_{(LOAD)} = 1\text{ nF}$, $V_{CC} = 12\text{ V}$, See 图 1 and 图 24		3.5	5	ns
$t_{w(VD)}$	Minimum VD pulse duration (width) that changes the DTC output state	$V_{CC} = 5\text{ V}$		10	23	ns
		$V_{CC} = 12\text{ V}$		10	23	ns
$t_{w(IN)}$	Minimum IN duration (width) that changes OUT state	$V_{CC} = 5\text{ V}$		11	13	ns
		$V_{CC} = 12\text{ V}$		11	13	ns
$t_{d(1)}$	Gate driver turn on propagation delay	$C_{(LOAD)} = 1\text{ nF}$, $V_{IN} = 0\text{ V to } 3.3\text{ V}$, $V_{CC} = 5\text{ V}$, $V_{VD} = -0.5\text{ V}$, See 图 1 and 图 24		14	26.6	ns
		$C_{(LOAD)} = 1\text{ nF}$, $V_{IN} = 0\text{ V to } 3.3\text{ V}$, $V_{CC} = 12\text{ V}$, $V_{VD} = -0.5\text{ V}$, See 图 1 and 图 24		14	25	ns
$t_{d(2)}$	Gate driver turn off propagation delay	$C_{(LOAD)} = 1\text{ nF}$, $V_{IN} = 3.3\text{ V to } 0\text{ V}$, $V_{CC} = 5\text{ V}$, See 图 1 and 图 24		14	22.9	ns
		$C_{(LOAD)} = 1\text{ nF}$, $V_{IN} = 3.3\text{ V to } 0\text{ V}$, $V_{CC} = 12\text{ V}$, See 图 1 and 图 24		14	22	ns
$t_{d(COMP)}$	Body-diode conduction detection-comparator controlled-turnon propagation delay ⁽¹⁾	$C_{(LOAD)} = 1\text{ nF}$, $V_{IN} = 3.3\text{ V}$, $V_{CC} = 5\text{ V}$, $V_{VD} = 2\text{ V to } -0.5\text{ V}$, See 图 24		28	36	ns
		$C_{(LOAD)} = 1\text{ nF}$, $V_{IN} = 3.3\text{ V}$, $V_{CC} = 12\text{ V}$, $V_{VD} = 2\text{ V to } -0.5\text{ V}$, See 图 24		26	33	ns
$t_{d(DTC)}$	DTC output propagation delay	$V_{CC} = 5\text{ V}$		21	27	ns
		$V_{CC} = 12\text{ V}$		18	25	ns

(1) For details about the operation, see the [Gate Turnon and Turnoff](#) section.



图 1. Input Driver Operation

7.7 Typical Characteristics



图 2. Start-Up Current ($I_{\text{CC(UV)}}$) vs Temperature

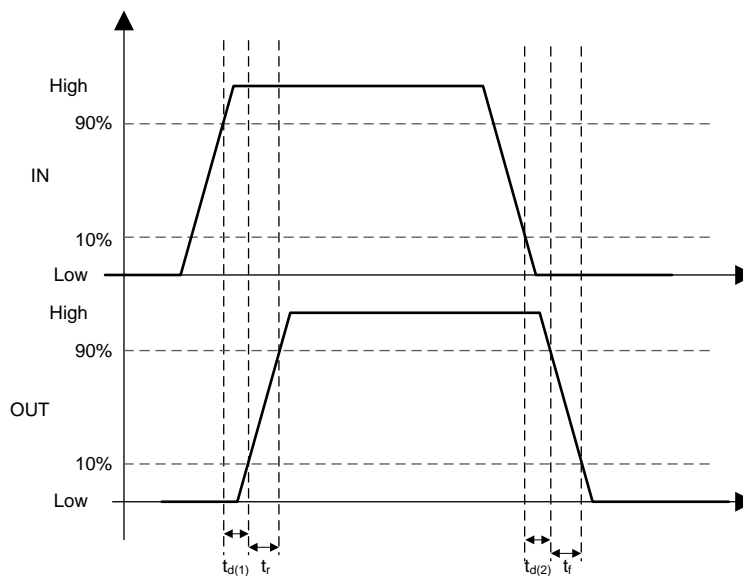

图 3. Standby Current ($I_{\text{CC(ON)}}$) vs Temperature

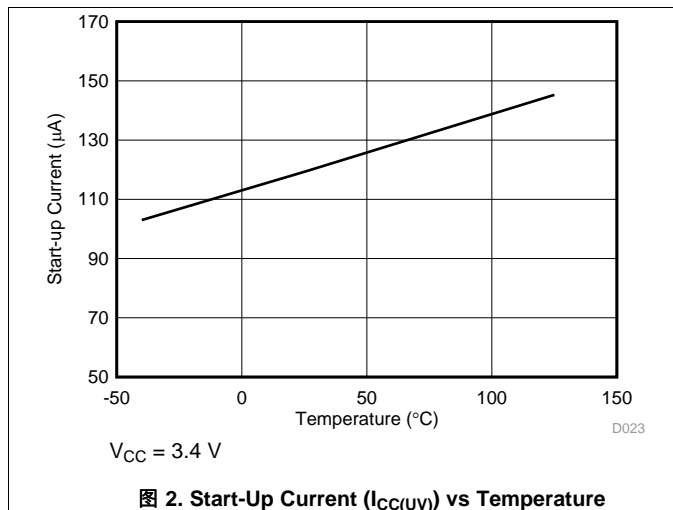

图 4. Operating Supply current ($I_{\text{CC(OPERATE)}}$) vs Temperature

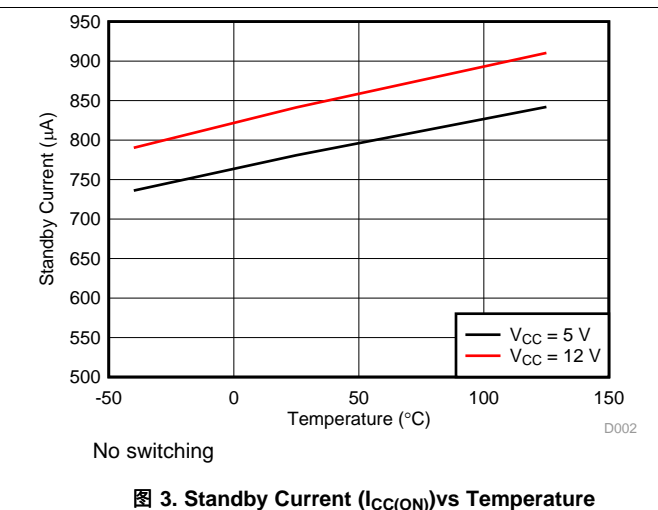

图 5. Body-Diode Conduction Sensing Threshold (V_{TH}) vs Temperature

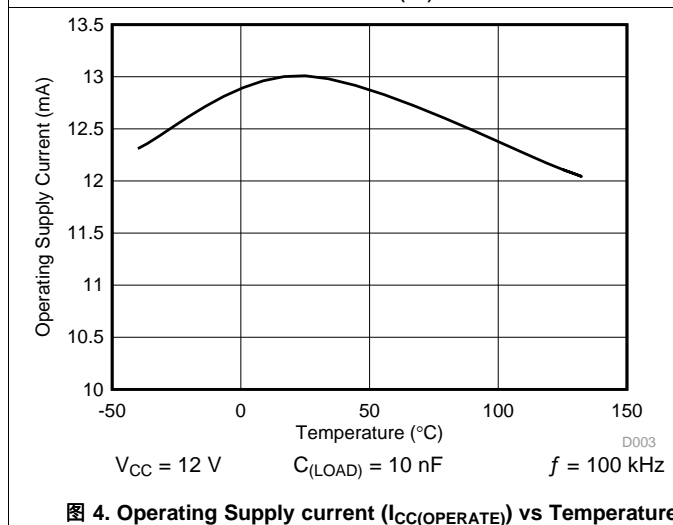

图 6. UVLO On-Voltage ($V_{\text{CC(ON)}}$) vs Temperature

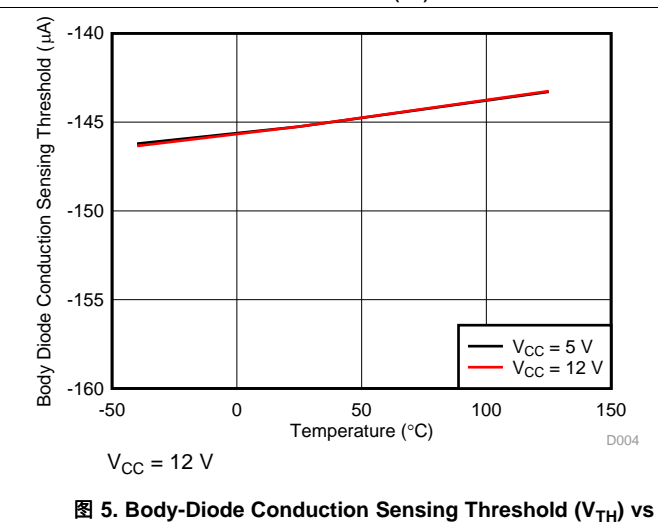

图 7. UVLO OFF-Voltage ($V_{\text{CC(OFF)}}$) vs Temperature

Typical Characteristics (接下页)

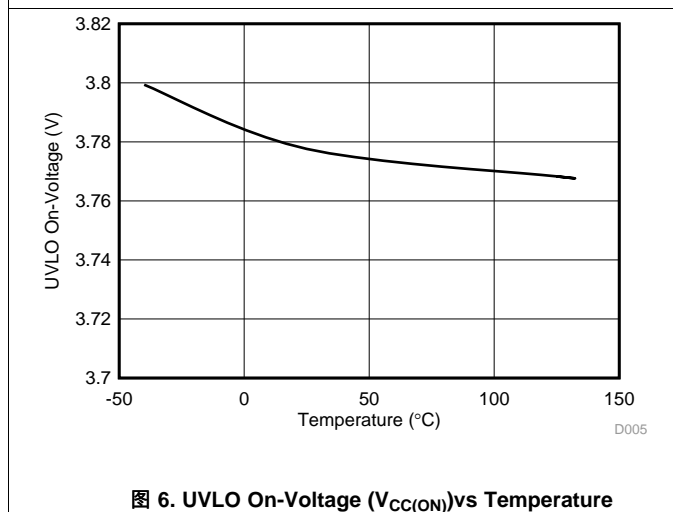

Typical Characteristics (接下页)

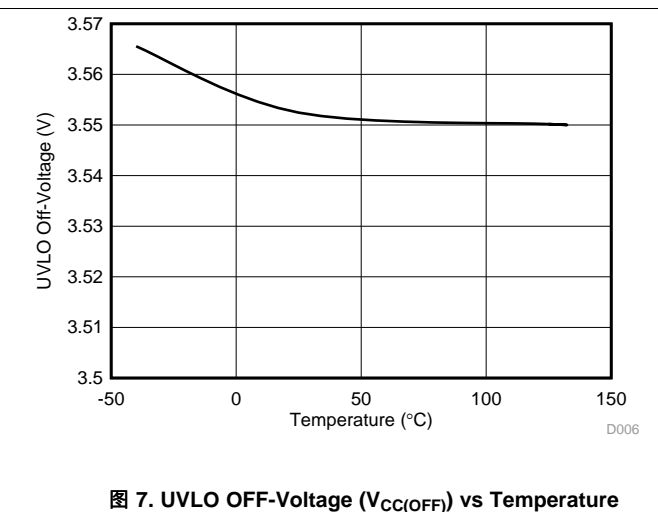
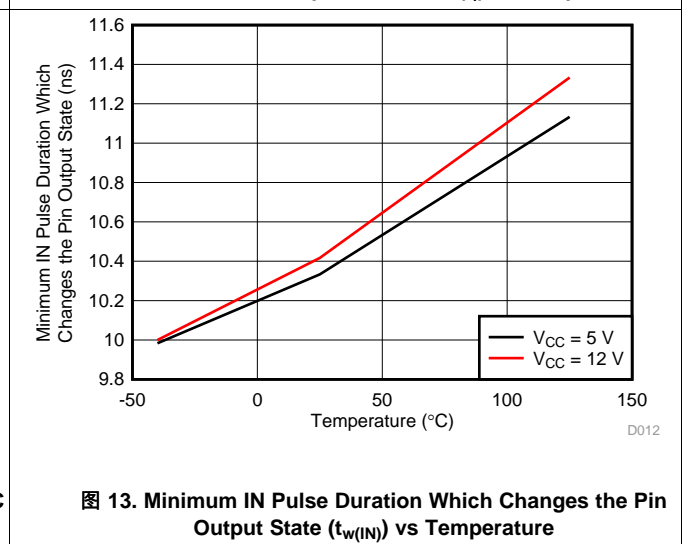
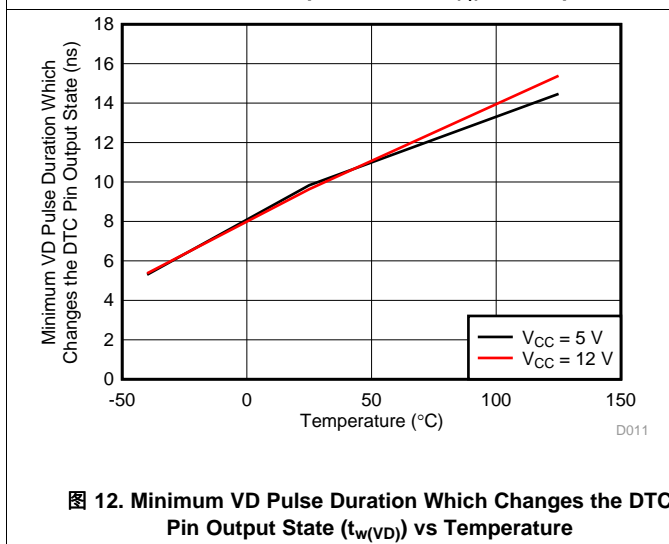
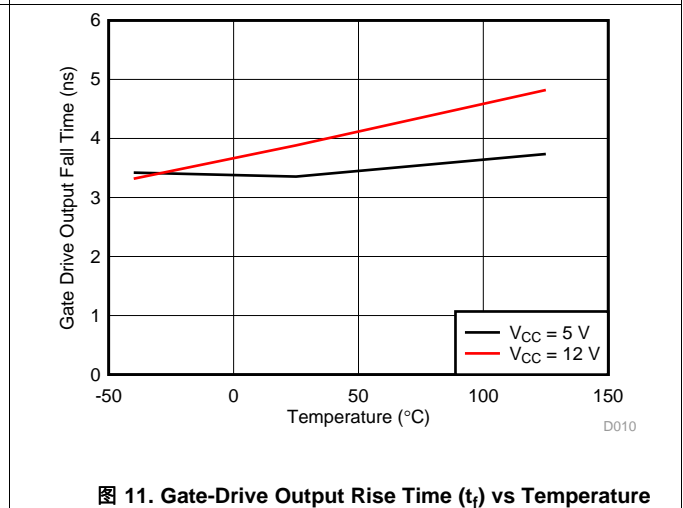
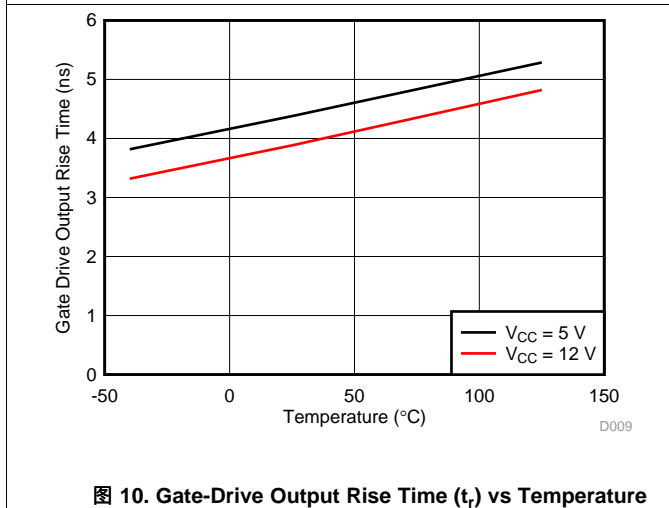
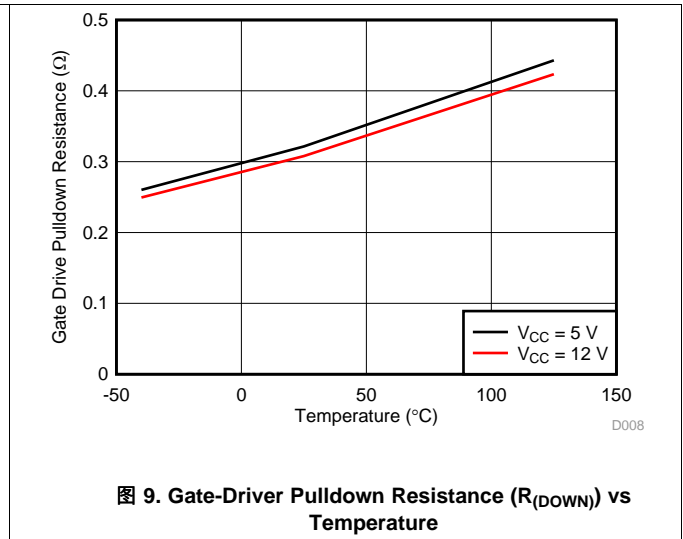
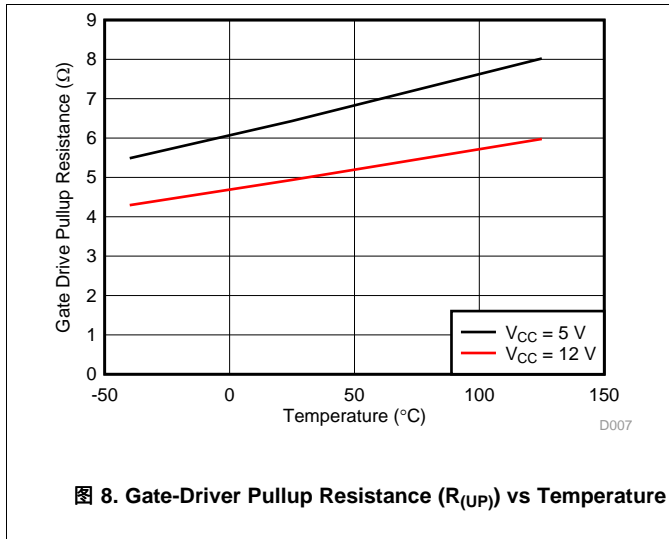

图 14. Gate Turnon Propagation Delay ($t_{d(1)}$) vs Temperature



图 15. Gate Turnoff Propagation Delay ($t_{d(2)}$) vs Temperature

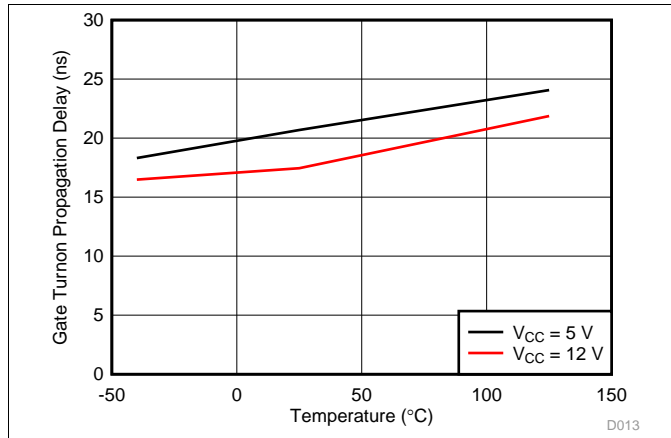

图 16. Comparator-Controlled Turnon Delay for Body-Diode Conduction Detection ($t_{d(COMP)}$) vs Temperature

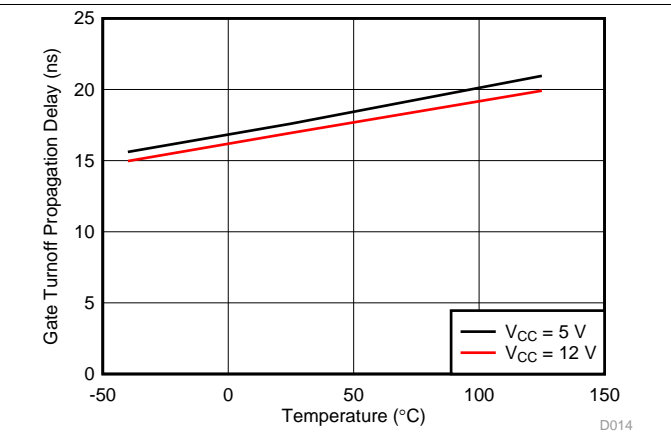

图 17. DTC Output Propagation Delay ($t_{d(DTC)}$) vs Temperature

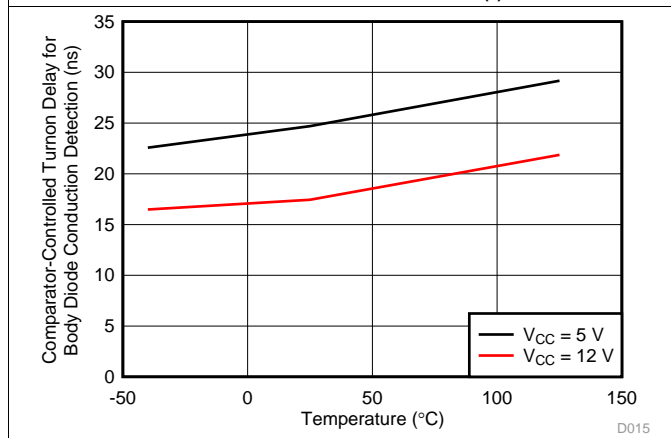

图 18. Gate Turnon Propagation Delay ($t_{d(1)}$) vs Supply Voltage (V_{CC})

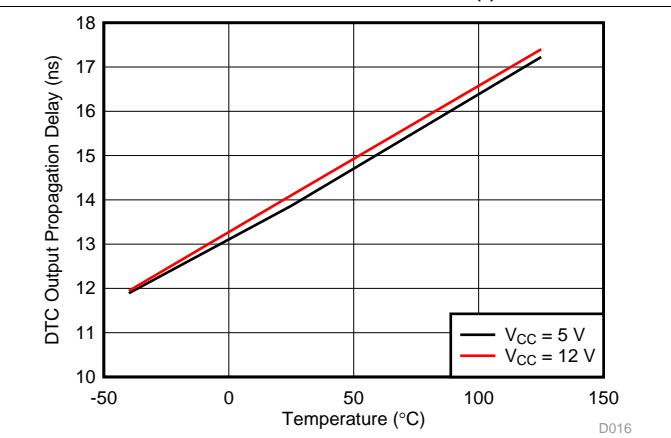

图 19. Gate Turnoff Propagation Delay ($t_{d(2)}$) vs Supply Voltage (V_{CC})

Typical Characteristics (接下页)

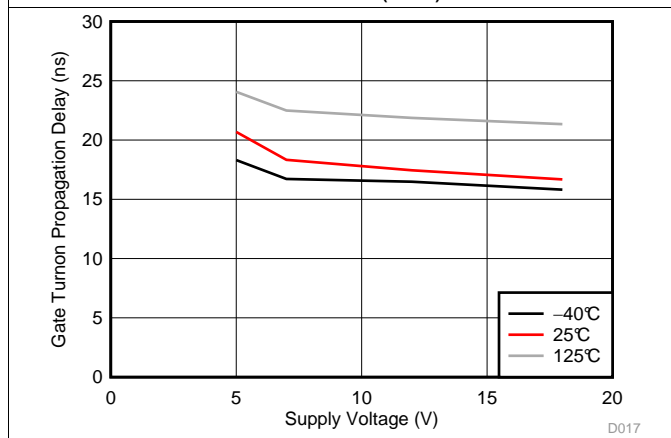

图 20. Comparator-Controlled Turnon Delay for Body-Diode Conduction Detection ($t_{d(Comp)}$) vs Supply Voltage (V_{CC})

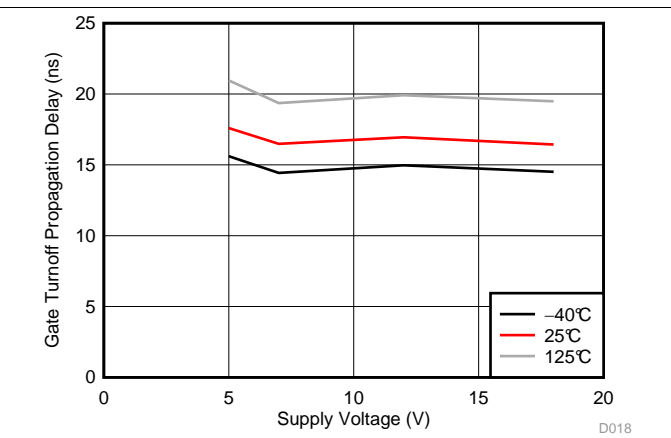

图 21. DTC Output Propagation Delay ($t_{d(DTC)}$) vs Supply Voltage (V_{CC})

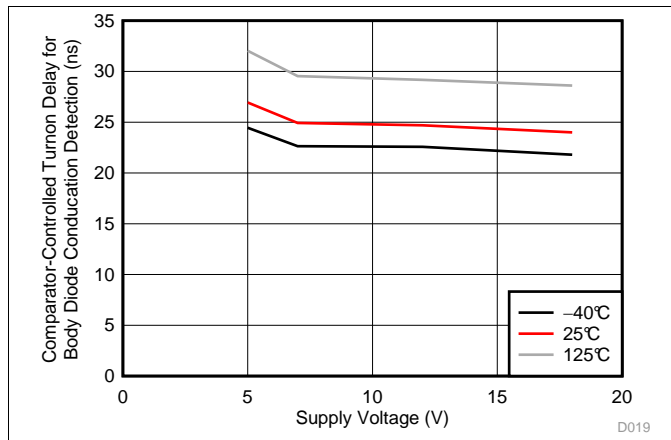

图 22. Gate-Drive Output Rise Time (t_r) vs Supply Voltage (V_{CC})

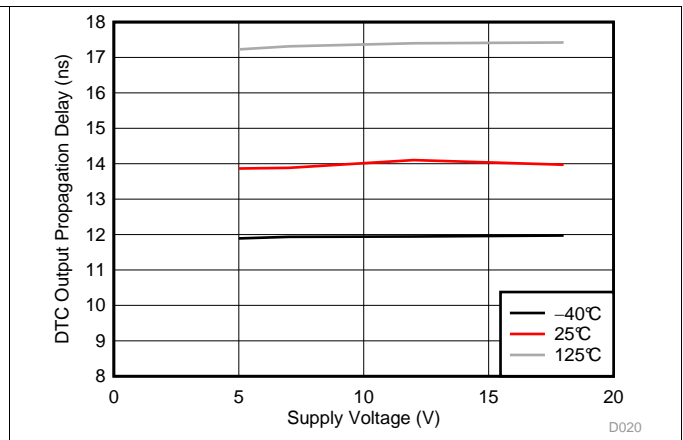

图 23. Gate-Drive Output Fall time (t_f) vs Supply Voltage (V_{CC})

8 Detailed Description

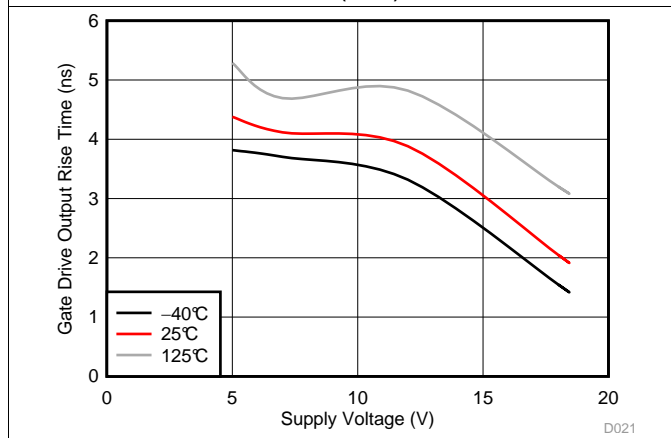
8.1 Overview

The UCD7138 low-side gate driver is a high-performance driver for secondary-side synchronous rectification with body-diode conduction sensing. The device is suitable for high-power high-efficiency isolated converter applications where dead-time optimization is desired. The body-diode conduction is sensed at the falling edge of the gate-drive signal and sent to the UCD3138A digital-power controller through one digital IO pin. The digital controller can adjust the dead-time setting based on this information. The body-diode conduction time is detected in a certain time window in the UCD3138A digital controller. This detection prevents reporting erroneous signals because of noise or reverse current. At the gate turn-on edge, the UCD7138 gate driver optimizes the dead time by turning the gate on as soon as diode conduction is detected. The benefits of this driver to the system include, but are not limited to, improved efficiency, improved reliability, and ease of design.

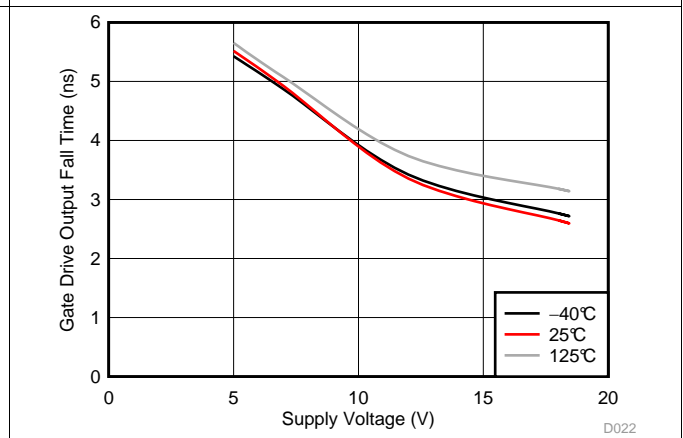
The internal gate driver is a single-channel, high-speed gate driver suitable for both 12-V and 5-V drive. The gate driver offers 4-A source and 6-A sink (asymmetrical drive) peak drive current capability. The package and pin configuration provide minimum parasitic inductances to reduce rise and fall times and to limit ringing. Additionally, the short propagation delay with minimized tolerances and variations allows efficient operation at high frequencies. The 5- Ω and 0.35- Ω pull-up and pull-down resistances boost immunity to hard switching with high slew-rate dV and dt.

The internal body-diode conduction detector is a high-speed comparator with 20-ns propagation delay. The DTC output is internally pulled high by default. When body-diode conduction is sensed, DTC pin drives low.

8.2 Functional Block Diagram

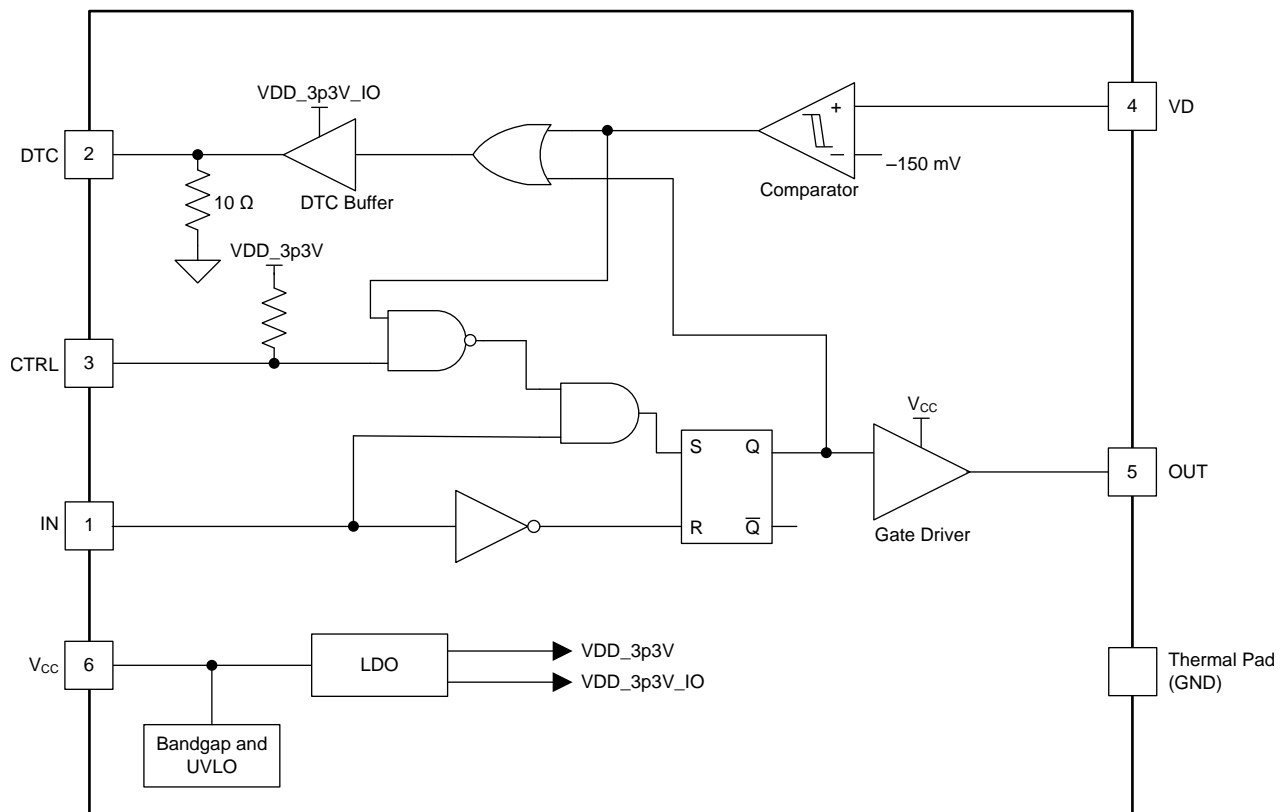

8.3 Feature Description

8.3.1 Body-Diode Conduction Detection

In [图 24](#), V_{DS} is the drain-to-source voltage which is connected to the VD pin. The IN pin is the gate-driver input-command signal from the UCD3138A digital controller. The DTC pin is the sensed body-diode conduction. The OUT pin is the gate-driver output. The body-diode conduction detection comparator has a -150-mV threshold. When the body diode conducts, the DTC pin is low. If the body diode does not conduct, the DTC pin is high.



图 24. Input-Output Timing Diagram (Turn-On Optimization is Enabled)

To improve noise immunity, the comparator output DTC is blanked when the gate driver output, OUT, is high. The DTC signal always outputs high when OUT is high.

Feature Description (接下页)

8.3.2 Gate Turnon and Turnoff

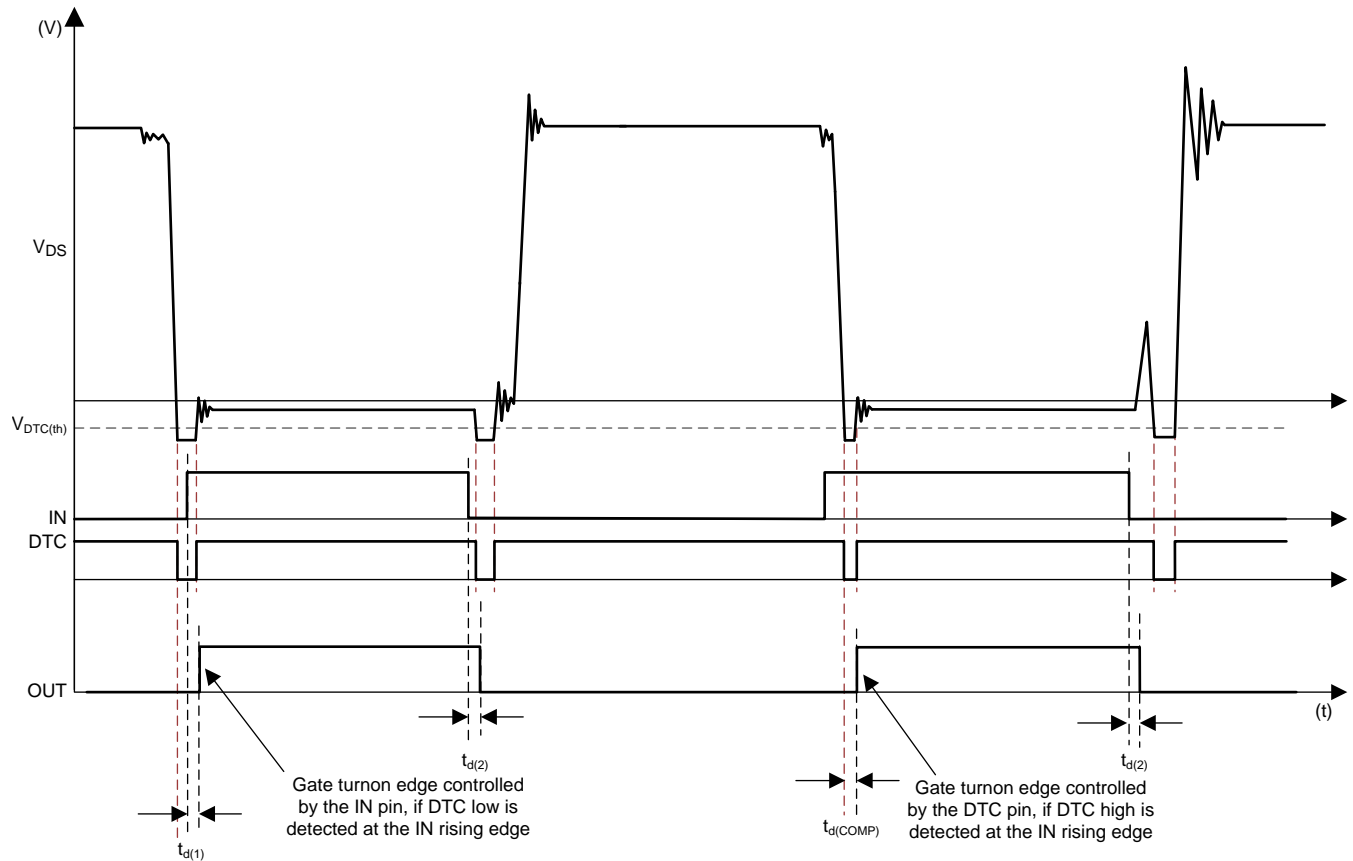
Gate turnon is controlled by both the gate driver input, IN, and body-diode conduction. System robustness is enhanced through internal logic that guarantees that OUT is only allowed high if IN is also high. At the IN rising edge, the UCD7138 gate-driver analyzes the DTC signal and determines the required course of action. The OUT pin is sent high immediately if the DTC comparator output is low at the rising edge of the IN signal. If the DTC pin is high at the rising edge of the IN signal, OUT is held low until DTC goes low. To allow the gate turnon edge to optimize freely, setting the dead time between the primary side falling edge and the IN rising edge smaller than expected in the UCD3138A digital controller is recommended.

The gate turnoff edge is determined by the IN signal only. The gate is turned off immediately at the IN falling edge.

表 1. Truth Table for CTRL Pin Function

CTRL PIN CONFIGURATION	FUNCTION
0 V or ground	Turn-on optimization disabled
3.3 V or floating	Turn-on optimization enabled

8.3.3 V_{CC} and Undervoltage Lockout

The UCD7138 device has an internal undervoltage-lockout (UVLO) protection feature based on the V_{CC} -pin voltage. Whenever the driver is in the UVLO condition (such as when the V_{CC} voltage is less than $V_{CC(ON)}$ during power up or when the V_{CC} voltage is less than $V_{CC(OFF)}$ during power down), the device holds all outputs low, regardless of the status of the inputs. The UVLO voltage is typically 3.8 V with a 240-mV hysteresis. This hysteresis helps prevent chatter when low V_{CC} supply voltages have noise from the power supply and also when droops occur in the V_{CC} bias voltage.

For example, at power up, the UCD7138 driver output remains low until the V_{CC} voltage reaches the UVLO threshold. The magnitude of the OUT signal rises with V_{CC} until steady-state V_{CC} is reached. The output remains low until the UVLO threshold is reached. The DTC signal begins to rise when V_{CC} begins to rise. The internal diode conduction detection comparator remains inactive until V_{CC} passes $V_{CC(ON)}$ threshold.



图 25. Device Power Up and Power Down

8.3.4 Operating Supply Current

The UCD7138 device features very-low quiescent supply current. The total supply current is the sum of the quiescent supply current, the average I_{OUT} current from switching, and any current related to pull-up resistors on the unused input pin. Knowing the operating frequency (f_S) and the MOSFET gate (Q_G) charge, the average I_{OUT} current can be calculated as product of Q_G and f_S .

8.3.5 Driver Stage

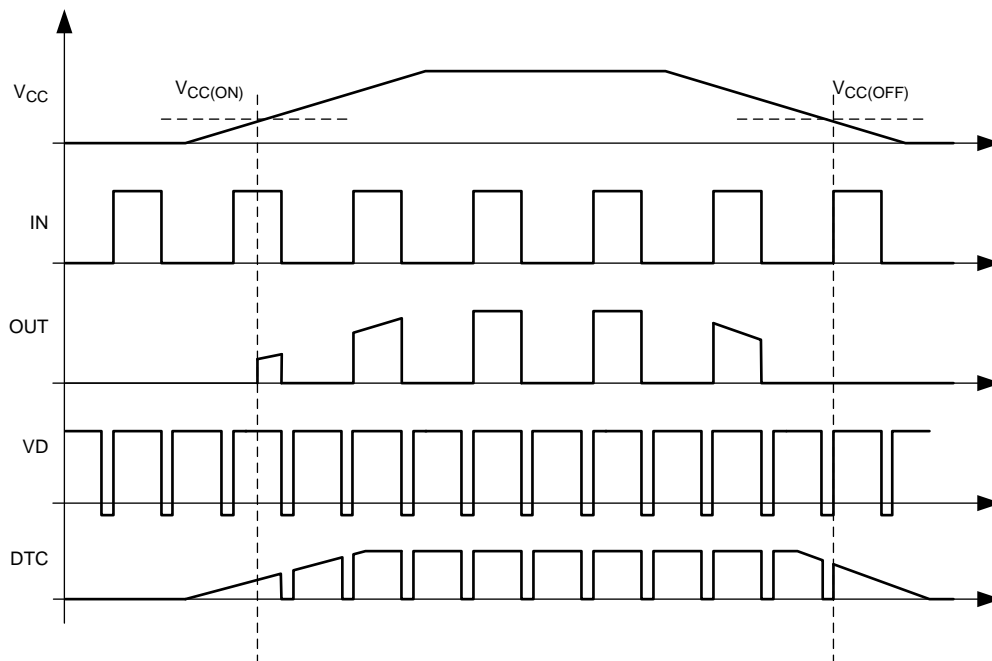
The input pins of the UCD7138 device are based on a CMOS-compatible input-threshold logic that is independent of the V_{CC} supply voltage. The logic-level thresholds can be conveniently driven with PWM control signals derived from 3.3-V.

The output stage of the UCD7138 device features a unique architecture on the pull-up structure. This architecture delivers the highest peak-source current when needed during the Miller-plateau region of the power switch turnon transition (when the power switch drain or collector voltage experiences dV/dt). The output stage pull-up structure features a P-Channel MOSFET and an additional N-Channel MOSFET in parallel. The function of the N-Channel MOSFET is to provide a brief boost in the peak sourcing current to enable fast turnon. This boost occurs by briefly turning on the N-Channel MOSFET when the output is changing state from LOW to HIGH.



图 26. Gate-Driver Output Structure

8.4 Device Functional Modes

8.4.1 UVLO Mode

When the V_{CC} voltage to the device has not reached the $V_{CC(ON)}$ threshold or has fallen below the UVLO threshold, $V_{CC(OFF)}$, the device operates in the low-power UVLO mode. In this mode, most internal functions are disabled and the I_{CC} current is very low. In UVLO mode, the OUT pin is held low. The device passes out of UVLO mode when the V_{CC} voltage increases above the $V_{CC(ON)}$ threshold.

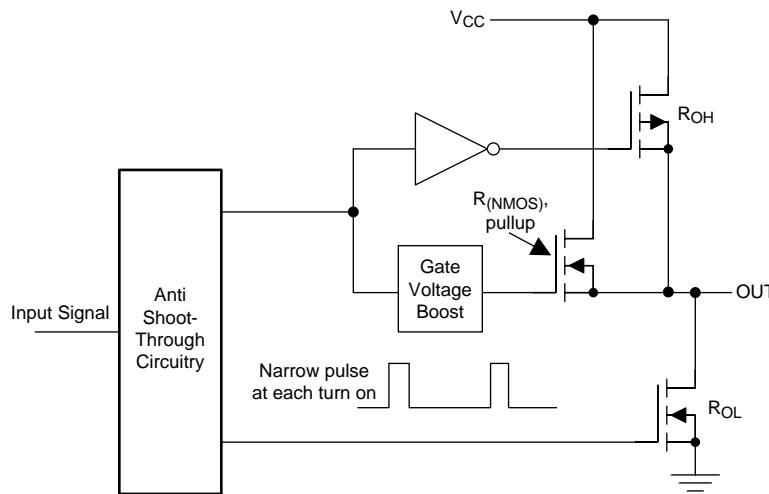
8.4.2 Normal Operation Mode

In this mode, the I_{CC} current is higher because all internal control and timing functions are operating and the gate-driver output, OUT, is driving the controlled MOSFET for synchronous rectification. In this mode, the V_{CC} current is the sum of $I_{CC(ON)}$ plus the average current required to drive the load on the OUT pin.

9 Application and Implementation

注

Information in the following applications sections is not part of the TI component specification, and TI does not warrant its accuracy or completeness. TI's customers are responsible for determining suitability of components for their purposes. Customers should validate and test their design implementation to confirm system functionality.

9.1 Application Information

The UCD7138 device can be used in a wide range of applications. The device can be used on many center-tapped secondary-side rectification topologies. Specifically, the device can be used in half-bridge LLC converters. In these applications, the UCD3138A and UCD7138 chipset enables the synchronous rectifiers to closely approximate the behavior of an ideal diode which is difficult to do in an LLC converter because of the variations in the SR current-conduction time.

The UCD7138 and UCD3138A chipset together can provide an easy-to-use, high-performance and advanced SR-control solution. Without this solution, fine tuning is required for each operation region (including below resonant frequency, at resonant frequency, and above resonant frequency). For LLC converters in production, each power stage may have a different resonant frequency because of tolerances of circuit capacitors and inductors. Calibration is required for each converter to achieve high efficiency. With UCD7138 and UCD3138A advanced SR control, optimal SR operation is easily achieved for every converter without fine tuning and calibration of the resonant tank can be eliminated in production. For more information see *Using UCD7138 and UCD3138A for Advanced Synchronous Rectification Control*, [SLUA737](#).

9.2 Typical Application

9.2.1 Half-Bridge LLC

 [27](#) shows a typical half-bridge LLC application using the UCD7138 device as a secondary-side SR driver and the UCD3138A device as a controller.

Typical Application (接下页)



图 28. Drain to Source Voltage Waveforms in a Typical Half Bridge LLC Application and Desired Waveforms

As shown in 图 29, when the SR pulse is on for too long, the drain-to-source voltage shoots up. The upper waveform in 图 29 shows the SR current. The lower waveform shows the SR drain-to-source voltage. The black segment of the curves show when the SR MOSFET is on. The red and green segments of the curves show when the SR MOSFET is off. The SR current is positive at first, but continues to drop until it is negative. The drain-to-source voltage is close to 0 V when the SR MOSFET is on. As soon as the SR MOSFET is turned off, the negative current must reset. The capacitance across the drain and source terminal is charged, and the drain-to-source voltage increases. The green segments of the curves show when the negative current reset process is complete at which point the body diode of the MOSFET conducts briefly again.

Typical Application (接下页)

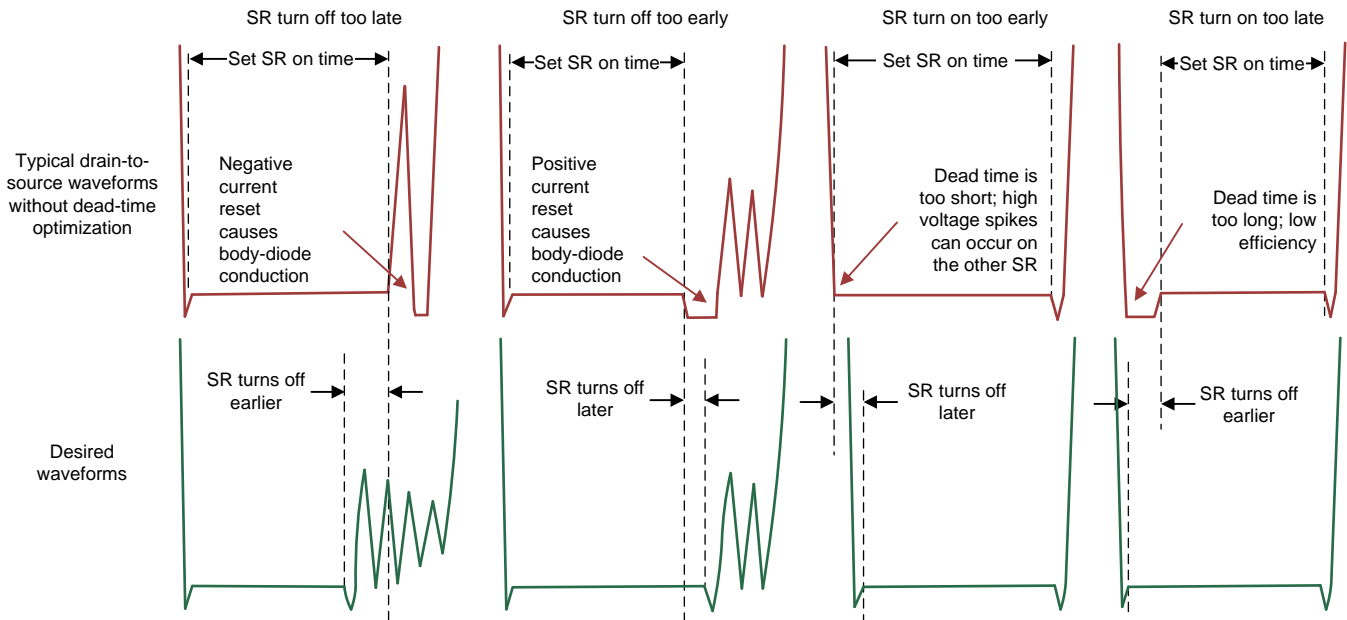

图 29. SR Drain-to-Source Voltage Shoot Up When No Negative Current Flow Occurs

For the UCD3138A device, a DTC detection window is generated at the falling edge of the gate drive command IN signal. Only during this detection window is the DTC low time counted by a 4-ns resolution timer capture inside the UCD3138A device. 图 30 shows the simplified system block diagram. In the two body-diode conduction cases shown in 图 31, the SR on time should be adjusted in different directions. The detection window identify that these two cases are different. If, during the detection window, a large amount of DTC low time is detected, and the SR turns off too early. If, during the detection window, no or very-short DTC low time is detected and the SR turns off too late.

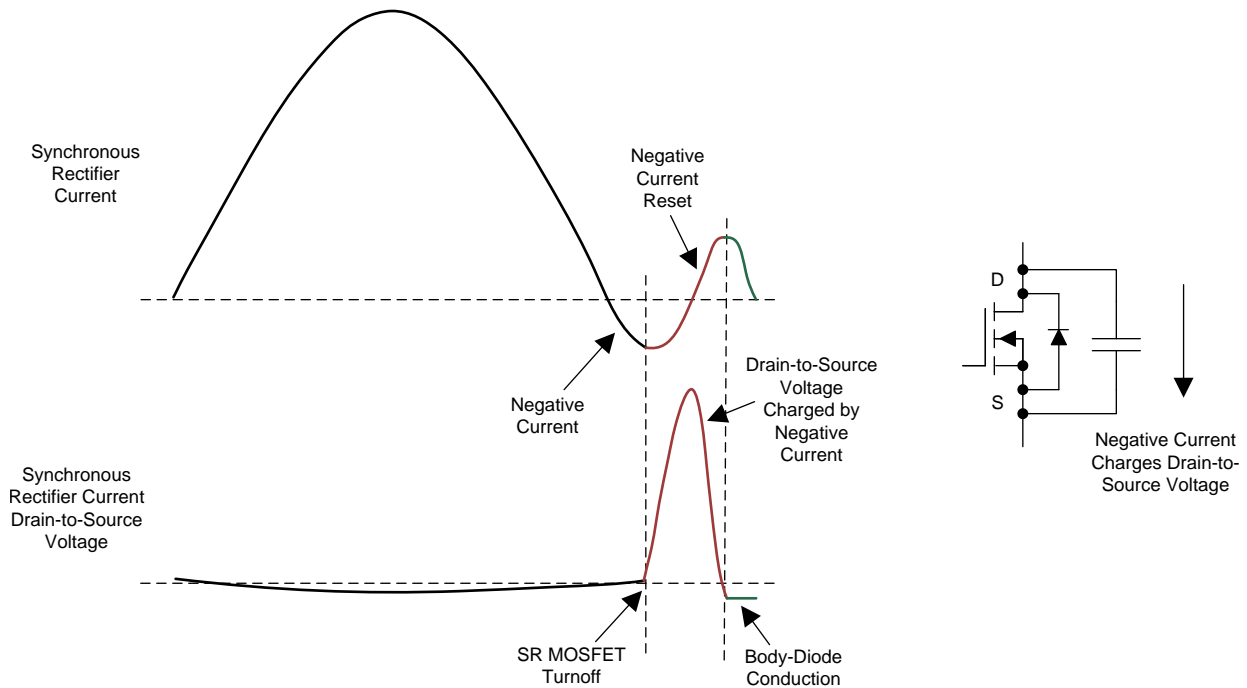

图 30. Simplified System Block Diagram

Typical Application (接下页)

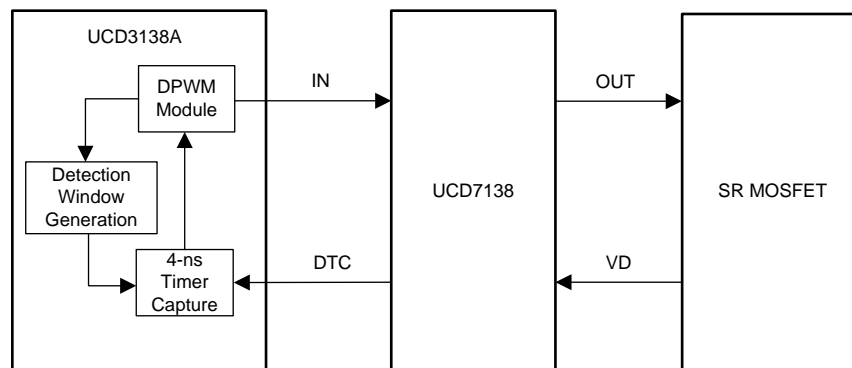

图 31. Body-Diode Connection Detection

The UCD3138A digital controller counts the body-diode conduction time of the current cycle and adjusts the SR on time of the next cycle. In 图 32, the DTC0 and DTC1 signals are the body-diode conduction inputs received from the UCD7138 device. SR0_DPWM and SR1_DPWM are the DPWM waveforms for the SRs. The red and green dashed lines are moving edges controlled by both the UCD3138A digital-compensator output and the DTC interface. In each cycle, directly after the falling edge of the SR DPWM waveform, a detection window is generated for the body-diode conduction time. The detection window is defined by both DETECT_BLANK and DETECT_LEN registers. During this detection window, a 4-ns timer capture counts the conduction time of the body diode. The SR DPWM turnoff edge of the next cycle is then adjusted accordingly.

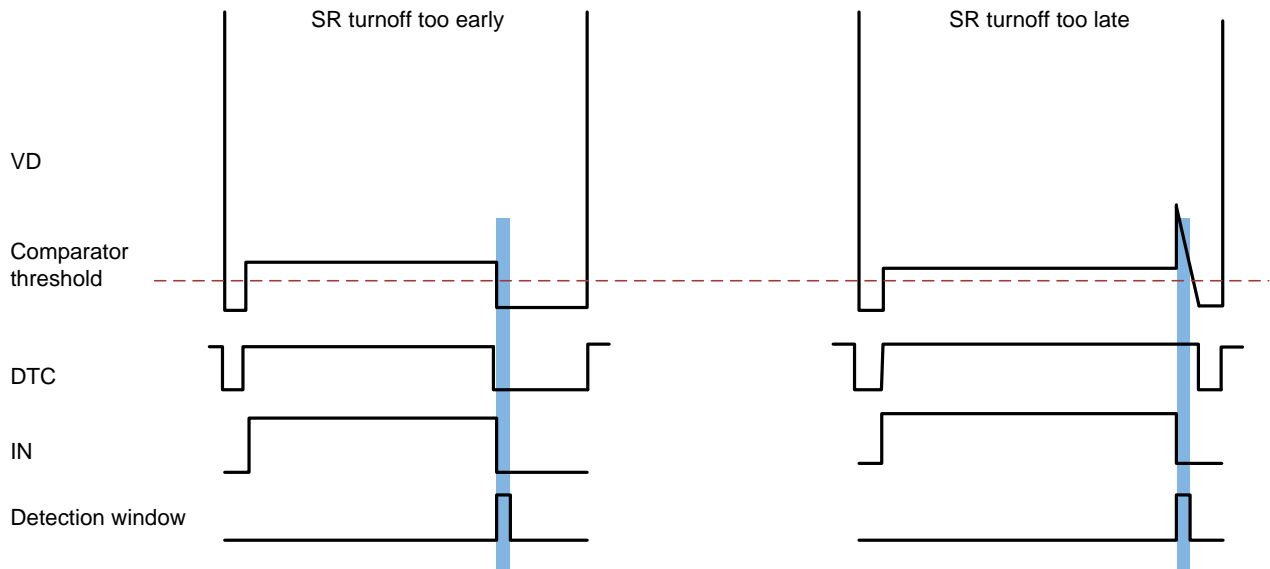

图 32. Timing Diagram of the DTC Interface in UCD3138A

Typical Application (接下页)

图 33. DTC Interface Principle

图 33 shows how the SR turnoff edge is adjusted based on the DTC measurement of the previous cycle. The A_CNT or B_CNT is the counted values of diode conduction time of two SRs which ranges from 0 to 127. The two types of SR control modes are automatic-control mode and manual-control mode. If manual-control mode is used, the SR on-time adjustment value is determined by the manual write register. If automatic-control mode is used, the UCD3138A digital controller automatically calculates the SR on-time adjustment amount for the next cycle. The body-diode conduction time at the falling edge of the SR gate is regulated to a target value by step-by-step edge adjustment in the UCD3138A device. The SR on time is reduced by a preprogrammed large amount, when the sensed body-diode conduction time is less than a programmable threshold. This reduction prevents the power supply from damaged caused by negative current in the SRs.

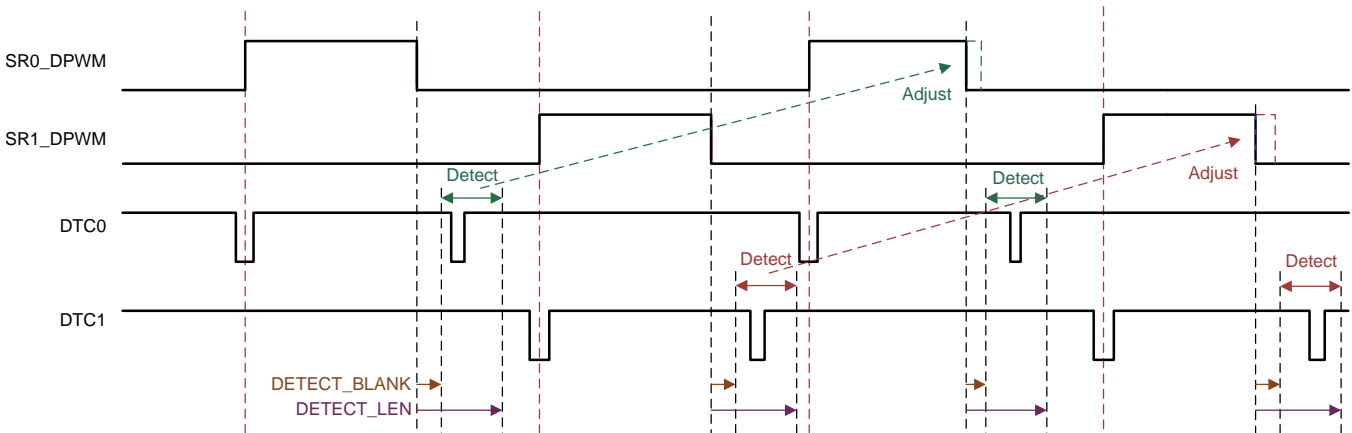
For more information on the DTC interface on UCD3138A see *UCD7138 and UCD3138A for Advanced Synchronous Rectification Control*, [SLAU737](#) and *UCD3138A Highly Integrated Digital Controller for Isolated Power*, [SLUSC66](#).

9.2.1.1 Design Requirements
9.2.1.1.1 Gate Input

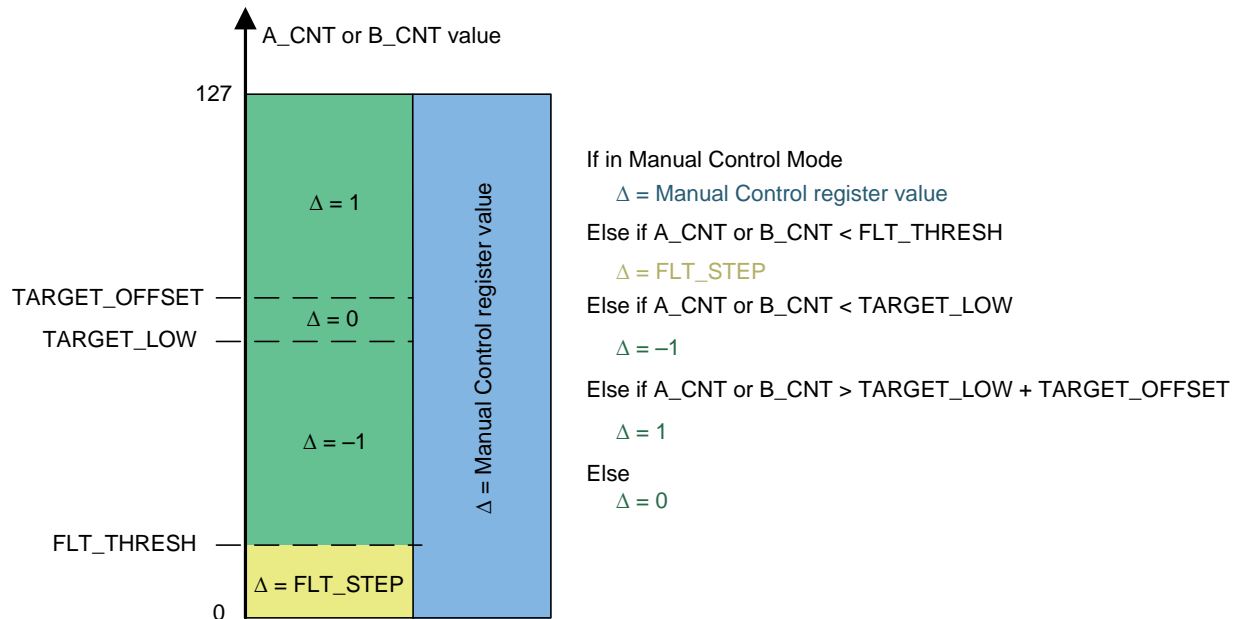
The input stage of the driver should be driven by a signal with fast rise and fall times. Caution must be exercised whenever the driver is used with slowly varying input signals, in situations where the device is located in a mechanical socket or PCB layout is not optimal (bad grounding, for example). Ground bounce is often caused by high di/dt current from the driver output, coupled with board-layout parasitic. The differential voltage between the input pin IN and ground pad GND may be modified by ground bounce and trigger an unintended change of output state. Because of short propagation delay, the unintended change of state can ultimately result in high-frequency oscillations, which increases power dissipation and can potentially damage the device. In the worst case, when a slow input signal is used and PCB layout is not optimal, adding a small capacitor (1 nF) between the input pin and ground very close to the driver device may be necessary.

9.2.1.1.2 Gate Output

The output of the gate driver (OUT) must be connected as close to the MOSFET gate as possible. A small resistor may be connected in between to reduce the high-frequency oscillations on the gate. Doing so can also slow down the gate transitions. The DTC detection windows inside UCD3138A may need some adjustment to compensate for the delay caused by the added resistor.

Typical Application (接下页)

9.2.1.1.3 Drain-to-Source Voltage Sensing

When the drain-to-source voltage is below 0 V, current flows out of the VD pin to the drain terminal of the MOSFET. This current flow must be limited to ensure proper operation of the device. The recommended current-limiting resistance value is 20Ω.

The highest voltage that can be applied to VD pin is 45 V which is good for applications where 40-V MOSFETs are used for the secondary-side SRs. If a higher voltage is required for VD pin, an external high-voltage blocking circuit can be used together with the UCD7138 device as shown in 图 34. Depending on the required voltage rating, a different external high-voltage blocking MOSFET can be selected. Usually a small SOT-23 MOSFET can be used. In this circuit, the gate terminal of the external high-voltage blocking MOSFET is connected to V_{CC} of the UCD7138 gate driver. The source terminal is connected with a current-limiting resistor to the VD pin of the UCD7138 device. The drain terminal is connected to the SR MOSFET drain terminal. When a low voltage is presented at the drain terminal, the blocking MOSFET is turned on because of the positive gate-to-source voltage. When the drain voltage becomes higher and higher, the source terminal voltage rises along with the drain terminal until the gate-to-source voltage falls below the threshold. When the source voltage is high enough so that the blocking MOSFET is turned off, the high voltage on the SR drain is blocked.



图 34. External High-Voltage Blocking Circuit

9.2.1.1.4 DTC Output

The DTC pin is the internal comparator output. This pin should be connected to the DTC0 or DTC1 pin on the UCD3138A device. To keep edges sharp, no filtering is recommended. If noise spikes are observed on the DTC signal, the blanking times in the UCD3138A device can be used to prevent the digital controller from sensing noise. This pin is not designed to drive large current. If filtering must be used, ensure that the sink and source current on this pin is within ±4 mA as specified in the

[Electrical Characteristics](#) table.

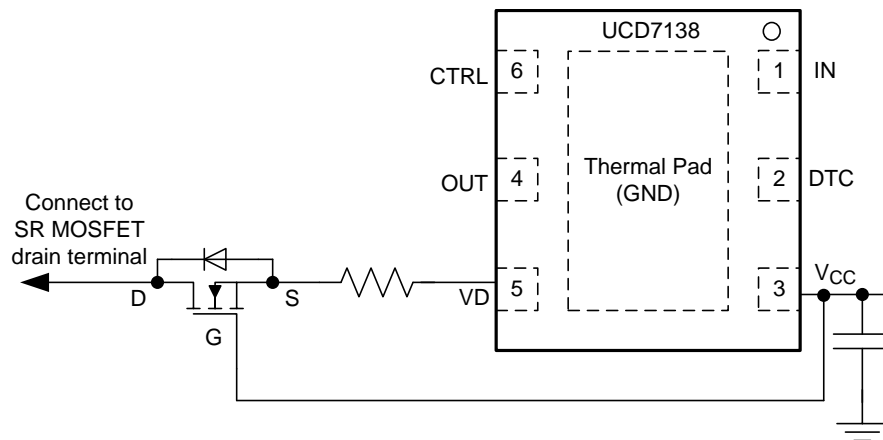
9.2.1.1.5 Turn-on Edge Optimization

The turnon edge optimization is useful when a positive current flow is at the rising edge of SRs. To maximize the efficiency gain, the dead time between the falling edge of the primary and the rising edge of the secondary should be programmed to a smaller value than expected, so that the rising edge of the SRs can move freely by UCD7138.

9.2.1.2 Detailed Design Procedure

9.2.1.2.1 Design Without SR-Control Optimization

The design procedure of an LLC converter with synchronous rectification can be greatly simplified by using the UCD7138 and UCD3138A chipset. The converter hardware and firmware can initially be designed without advanced SR optimization and then add SR optimization function in.

Typical Application (接下页)

For more information on the UCD3138A-based digital LLC converter, *UCD3138A Highly Integrated Digital Controller for Isolated Power*, [SLUSC66](#).

9.2.1.2.2 Setting the DTC Detection Window

The body-diode conduction should be detected in a specific region for the system to operate correctly. The detection window is defined by a blanking time register `DETECT_BLANK` and a detection length register `DETECT_LEN` in the UCD3138A device. To set the detection window, let the LLC converter operate below resonant frequency. Measure the VD, IN, and DTC waveforms on an oscilloscope. Use cursors to measure the time, t , difference between the IN falling edge and the starting point of body-diode conduction (first falling edge of DTC excluding noise spike). The blanking time should be set to be less than t . Usually the required blanking time is very short or non-existent, so the blanking time can be set to around 10% of t . The detection window length can be set to a few times of the desired body-diode conduction time. For example, if the desired body-diode conduction time is 40 ns, the detection window length can be set to 120 ns. Make sure that the body-diode conduction is well covered inside the detection window when it is at an optimal value. The end point of the detection window should never exceed the first valley on the VD waveform to avoid errors in measurement (see [图 35](#)).



图 35. Setting the DTC Detection Window in UCD3138A

After the detection window is set, enable the DTC module in manual control mode. Set the offset in the manual control registers to 0. Change the input voltage and load current to different operation points to verify that the UCD3138A DTC module measures the correct values in the `A_CNT` and `B_CNT` registers. See the *UCD3138A64 Programmer's Manual*, [SLUUB54](#) for detailed register information.

9.2.1.2.3 Setting the Clamps

The SR adjustment accumulator clamps defines the maximum SR turnoff edge offset from the calculated value from the UCD3138A compensator. The maximum clamp can be set to prevent the SR on time from going too long and causing shoot through. The minimum clamp can be set based on the light load condition where the desired SR turnoff edge offset is the maximum.

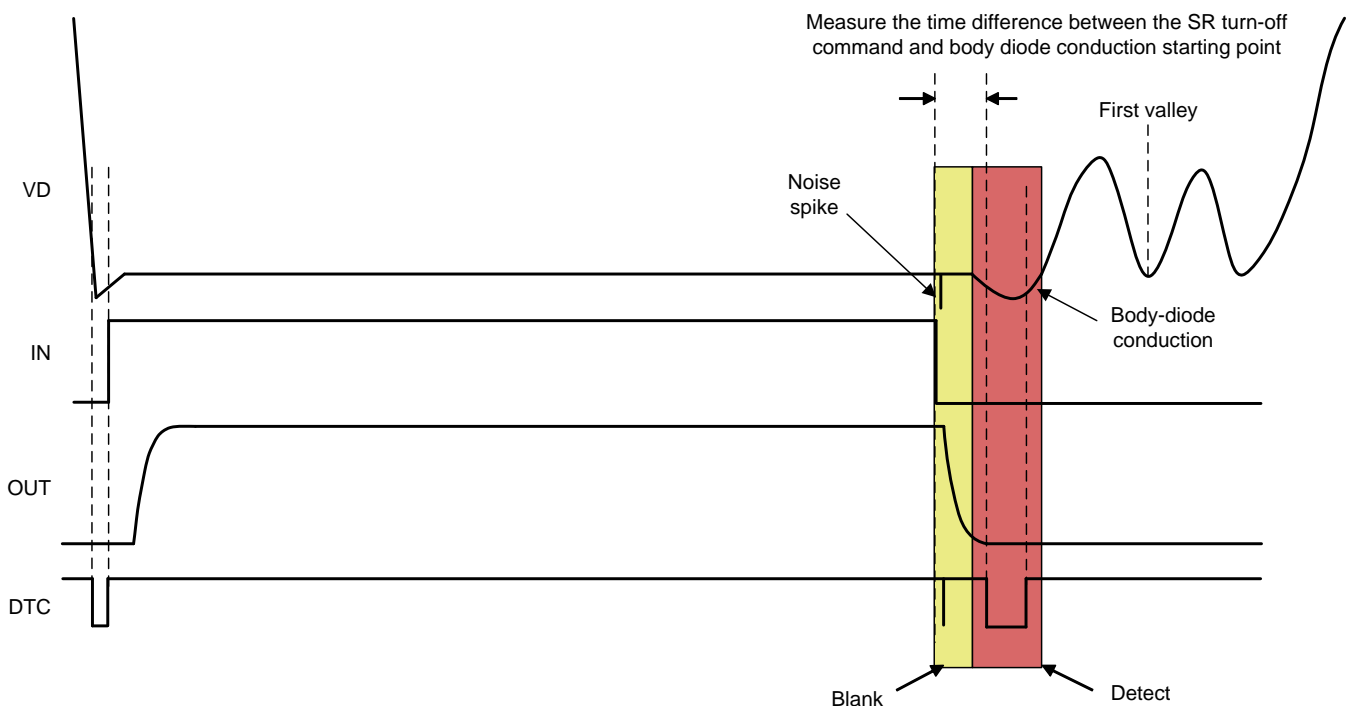
In addition to the SR adjustment accumulator clamps, the SR pulse falling edge is naturally clamped at 50% or 100% or the switching period in UCD3138A. This natural clamp is a default feature of UCD3138A and does not require any special setting.

Typical Application (接下页)

9.2.1.2.4 Setting the DTC Optimization Target and Hysteresis

The body diode must maintain a minimum conduction time for the UCD3138A DTC interface to function properly. The minimum body-diode conduction time is set by the DTC target and target register. A target hysteresis register can also be set to reduce the steady-state output-voltage ripple.

9.2.1.2.5 Setting the DTC Negative Current Fault Protection

If the detected body-diode conduction time is less than the programmed threshold, negative current can occur. This threshold can be set by the fault threshold register in the UCD3138A DTC module. If a DTC fault is detected, the SR on time is reduced by a programmed step size in the next switching cycle. This step size is defined by FLT_STEP register in the DTC module. To avoid noise and jitter in the negative current fault detection, a consecutive DTC fault counter can be used. A fault step is executed only after a consecutive number of faults are detected.

After all these registers are set, enable the UCD3138A DTC module in automatic control mode, enable the turnon-edge optimization on the UCD7138 device, and review the different operation conditions to see the overall system performance. The DTC module can be turned on or off by toggling DTC_EN bit in Loop Mux register in UCD3138A. The performance before and after SR optimization control can be compared very easily as shown in the [Application Curves](#) section.

Typical Application (接下页)

9.2.1.3 Application Curves

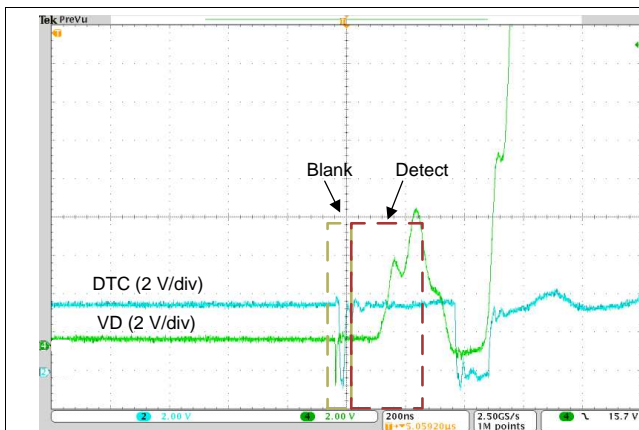

No optimization, SR on time too long.
High V_{DS} stress on the other SR.
Horizontal: 200 ns/div

图 36. SR Turnoff Edge Before Optimization

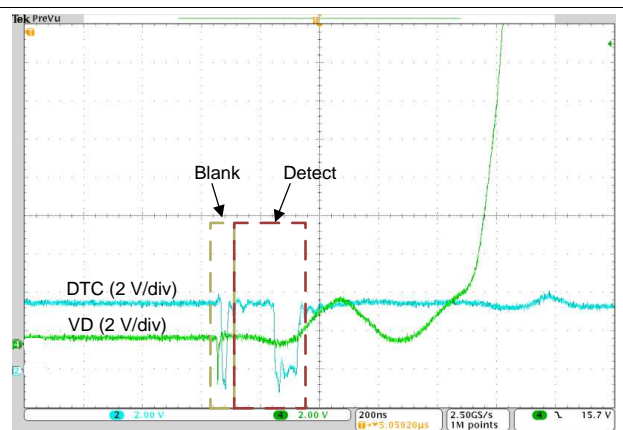

With optimization
Horizontal: 200 ns/div

图 37. SR Turnoff Edge After Optimization

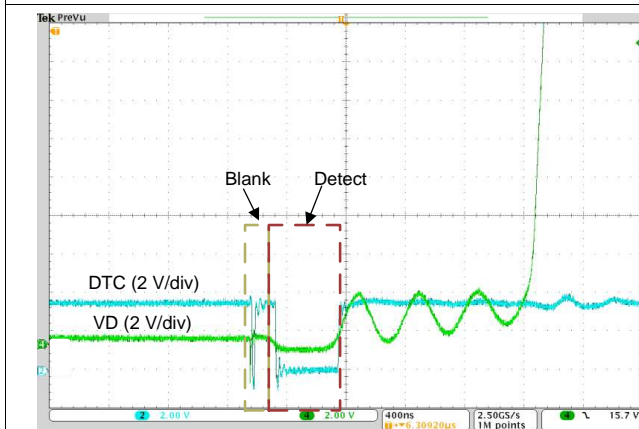

No optimization, SR on time too short. Low efficiency.
Horizontal: 200 ns/div

图 38. SR Turnoff Edge Before Optimization

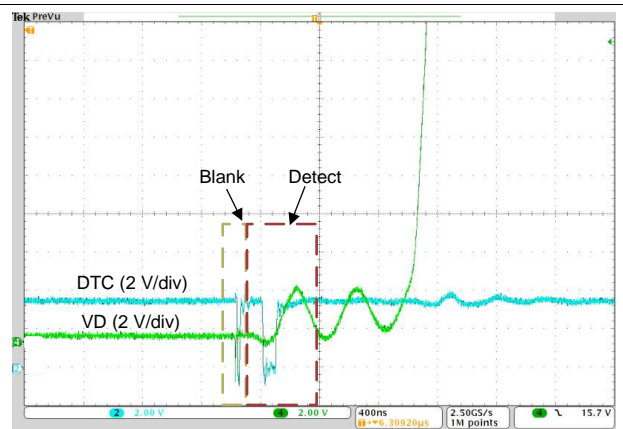

With optimization
Horizontal: 200 ns/div

图 39. SR Turnoff Edge After Optimization

Typical Application (接下页)

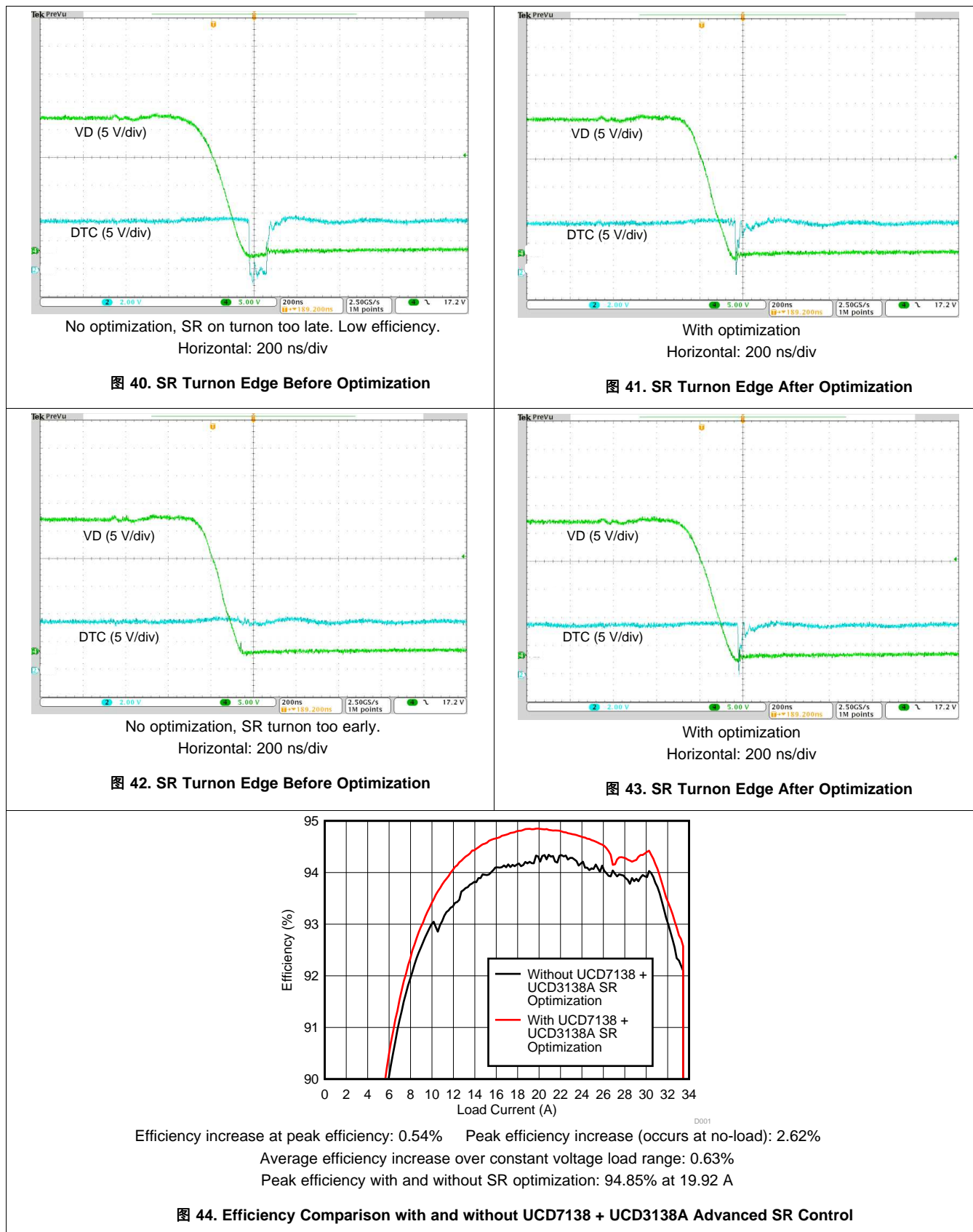

10 Power Supply Recommendations

Because the driver draws current from the V_{CC} pin to bias all internal circuits, for the best high-speed circuit performance, two V_{CC} bypass capacitors are recommended to prevent noise problems. The use of surface-mount (SM) components is highly recommended. A 1 μ F ceramic capacitor should be placed as close as possible to the V_{CC} to ground pad of the gate driver.

11 Layout

11.1 Layout Guidelines

Proper PCB layout is extremely important in a high-current, fast-switching circuit to provide appropriate device operation and design robustness. The following circuit layout guidelines are strongly recommended.

- Place the driver device as close as possible to power and ground to minimize the length of high-current traces between the output pins and the gate of the power device.
- Place the V_{CC} bypass capacitors between the V_{CC} pin and ground as close as possible to the driver with minimal trace length to improve the noise filtering. These capacitors support the high-peak current that is drawn from the V_{CC} supply during turnon of the power MOSFET. The use of low inductance SM components such as chip resistors and chip capacitors is highly recommended.
- The turnon and turnoff current-loop paths (driver device, power MOSFET, and V_{CC} bypass capacitors) should be minimized as much as possible to keep the stray inductance to a minimum.
- Separate power traces and signal traces, such as output and input signals.
- Star-point grounding is a good way to minimize noise coupling from one current loop to another. The ground of the driver should be connected to the other circuit nodes such as the source of power switch, ground of PWM controller, and others at one single point. The connected paths should be as short as possible and as wide as possible to reduce resistance and inductance.
- Use a ground plane to provide noise shielding. Fast rise and fall times at the OUT pin can corrupt the input signals during transition. The ground plane must not be a conduction path for any current loop. Instead, the ground plane must be connected to the star-point with one single trace to establish the ground potential.
- A 1- Ω resistor may be connected between OUT pin and the gate terminal of the MOSFET to reduce gate to source voltage ringing.
- A 20- Ω resistor should be connected between VD pin and the drain terminal of the MOSFET to limit the current flowing out of VD pin when the drain terminal voltage is negative.

11.2 Layout Example



图 45. Layout Example With Surface-Mount MOSFET



图 46. Layout Example With Through-Hole MOSFET

12 器件和文档支持

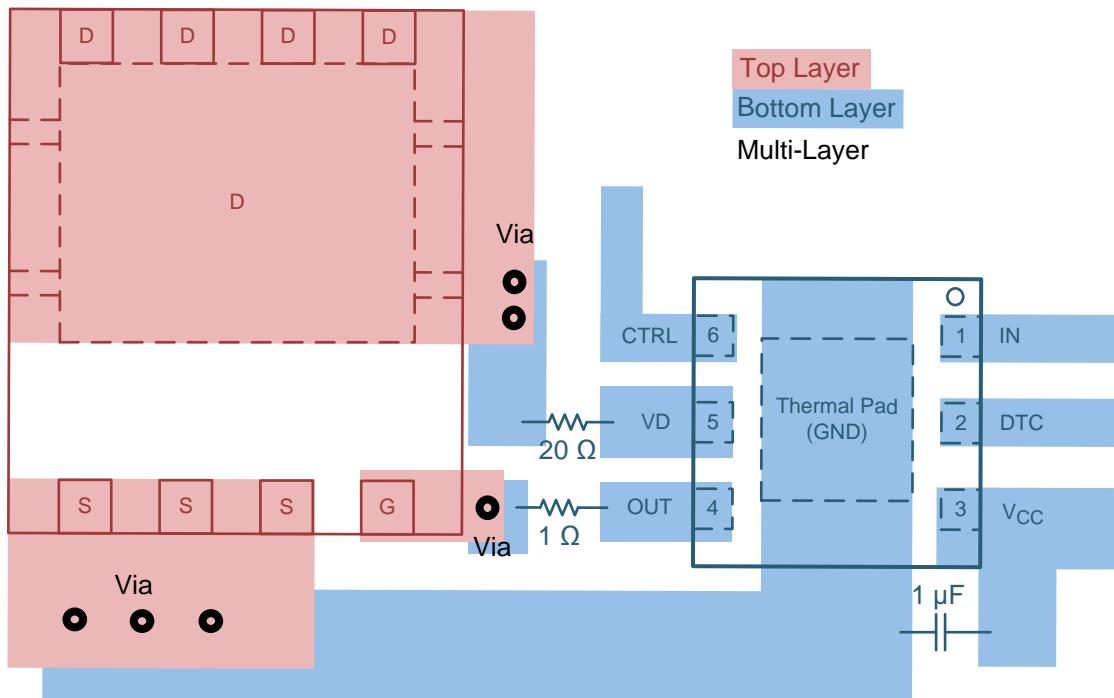
12.1 文档支持

12.1.1 相关文档

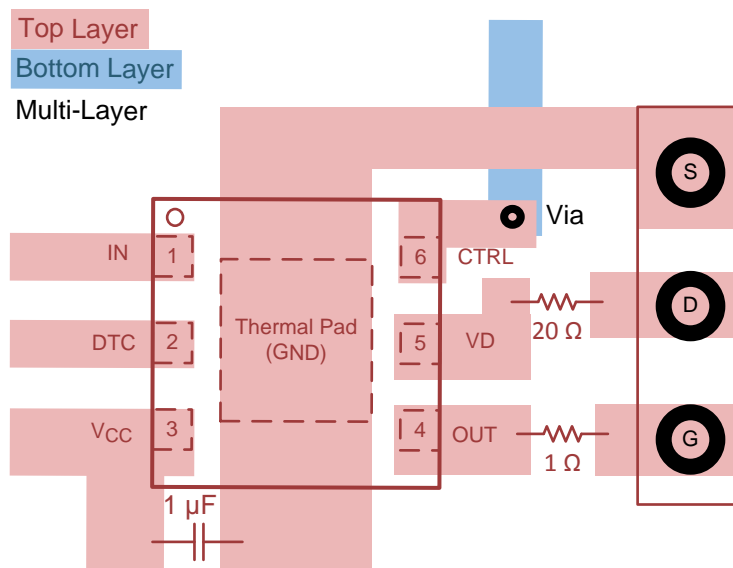
相关文档如下：

- 《UCD3138A 用于隔离电源的高度集成数字控制器》，[SLUSC66](#)
- 《使用 UCD7138 和 UCD3138A 实现高级同步整流控制》，[SLUA737](#)
- 《UCD3138 数字电源外设编程手册》，[SLUU995](#)
- 《UCD3138A 迁移指南》，[SLUA741](#)

12.2 社区资源

The following links connect to TI community resources. Linked contents are provided "AS IS" by the respective contributors. They do not constitute TI specifications and do not necessarily reflect TI's views; see TI's [Terms of Use](#).

TI E2E™ Online Community *TI's Engineer-to-Engineer (E2E) Community*. Created to foster collaboration among engineers. At e2e.ti.com, you can ask questions, share knowledge, explore ideas and help solve problems with fellow engineers.

Design Support *TI's Design Support* Quickly find helpful E2E forums along with design support tools and contact information for technical support.

12.3 商标

E2E is a trademark of Texas Instruments.

All other trademarks are the property of their respective owners.

12.4 静电放电警告



这些装置包含有限的内置 ESD 保护。存储或装卸时，应将导线一起截短或将装置放置于导电泡棉中，以防止 MOS 门极遭受静电损伤。

12.5 术语表

[SLYZ022](#) — *TI 术语表*。

这份术语表列出并解释术语、首字母缩略词和定义。

13 机械、封装和可订购信息

以下页中包括机械、封装和可订购信息。 这些信息是针对指定器件可提供的最新数据。 这些数据会在无通知且不对本文档进行修订的情况下发生改变。 欲获得该数据表的浏览器版本，请查阅左侧的导航栏。

重要声明

德州仪器(TI)及其下属子公司有权根据 JESD46 最新标准,对所提供的产品和服务进行更正、修改、增强、改进或其它更改,并有权根据 JESD48 最新标准中止提供任何产品和服务。客户在下订单前应获取最新的相关信息,并验证这些信息是否完整且是最新的。所有产品的销售都遵循在订单确认时所提供的TI 销售条款与条件。

TI 保证其所销售的组件的性能符合产品销售时 TI 半导体产品销售条件与条款的适用规范。仅在 TI 保证的范围内,且 TI 认为有必要时才会使用测试或其它质量控制技术。除非适用法律做出了硬性规定,否则没有必要对每种组件的所有参数进行测试。

TI 对应用帮助或客户产品设计不承担任何义务。客户应对其使用 TI 组件的产品和应用自行负责。为尽量减小与客户产品和应用相关的风险,客户应提供充分的设计与操作安全措施。

TI 不对任何 TI 专利权、版权、屏蔽作品权或其它与使用了 TI 组件或服务的组合设备、机器或流程相关的 TI 知识产权中授予的直接或隐含权限作出任何保证或解释。TI 所发布的与第三方产品或服务有关的信息,不能构成从 TI 获得使用这些产品或服务的许可、授权、或认可。使用此类信息可能需要获得第三方的专利权或其它知识产权方面的许可,或是 TI 的专利权或其它知识产权方面的许可。

对于 TI 的产品手册或数据表中 TI 信息的重要部分,仅在没有对内容进行任何篡改且带有相关授权、条件、限制和声明的情况下才允许进行复制。TI 对此类篡改过的文件不承担任何责任或义务。复制第三方的信息可能需要服从额外的限制条件。

在转售 TI 组件或服务时,如果对该组件或服务参数的陈述与 TI 标明的参数相比存在差异或虚假成分,则会失去相关 TI 组件或服务的所有明示或暗示授权,且这是不正当的、欺诈性商业行为。TI 对任何此类虚假陈述均不承担任何责任或义务。

客户认可并同意,尽管任何应用相关信息或支持仍可能由 TI 提供,但他们将独力负责满足与其产品及其在应用中使用的 TI 产品相关的所有法律、法规和安全相关要求。客户声明并同意,他们具备制定与实施安全措施所需的全部专业技术和知识,可预见故障的危险后果、监测故障及其后果、降低有可能造成人身伤害的故障的发生机率并采取适当的补救措施。客户将全额赔偿因在此类安全关键应用中使用任何 TI 组件而对 TI 及其代理造成的任何损失。

在某些场合中,为了推进安全相关应用有可能对 TI 组件进行特别的促销。TI 的目标是利用此类组件帮助客户设计和创立其特有的可满足适用的功能安全性标准和要求的终端产品解决方案。尽管如此,此类组件仍然服从这些条款。

TI 组件未获得用于 FDA Class III (或类似的生命攸关医疗设备)的授权许可,除非各方授权官员已经达成了专门管控此类使用的特别协议。

只有那些 TI 特别注明属于军用等级或“增强型塑料”的 TI 组件才是设计或专门用于军事/航空应用或环境的。购买者认可并同意,对并非指定面向军事或航空航天用途的 TI 组件进行军事或航空航天方面的应用,其风险由客户单独承担,并且由客户独力负责满足与此类使用相关的所有法律和法规要求。

TI 已明确指定符合 ISO/TS16949 要求的产品,这些产品主要用于汽车。在任何情况下,因使用非指定产品而无法达到 ISO/TS16949 要求, TI 不承担任何责任。

	产品		应用
数字音频	www.ti.com.cn/audio	通信与电信	www.ti.com.cn/telecom
放大器和线性器件	www.ti.com.cn/amplifiers	计算机及周边	www.ti.com.cn/computer
数据转换器	www.ti.com.cn/dataconverters	消费电子	www.ti.com.cn/consumer-apps
DLP® 产品	www.dlp.com	能源	www.ti.com.cn/energy
DSP - 数字信号处理器	www.ti.com.cn/dsp	工业应用	www.ti.com.cn/industrial
时钟和计时器	www.ti.com.cn/clockandtimers	医疗电子	www.ti.com.cn/medical
接口	www.ti.com.cn/interface	安防应用	www.ti.com.cn/security
逻辑	www.ti.com.cn/logic	汽车电子	www.ti.com.cn/automotive
电源管理	www.ti.com.cn/power	视频和影像	www.ti.com.cn/video
微控制器 (MCU)	www.ti.com.cn/microcontrollers		
RFID 系统	www.ti.com.cn/rfidsys		
OMAP应用处理器	www.ti.com/omap		
无线连通性	www.ti.com.cn/wirelessconnectivity	德州仪器在线技术支持社区	www.deyisupport.com

邮寄地址: 上海市浦东新区世纪大道1568号, 中建大厦32楼邮政编码: 200122
Copyright © 2015, 德州仪器半导体技术(上海)有限公司

PACKAGING INFORMATION

Orderable Device	Status (1)	Package Type	Package Drawing	Pins	Package Qty	Eco Plan (2)	Lead finish/ Ball material (6)	MSL Peak Temp (3)	Op Temp (°C)	Device Marking (4/5)	Samples
UCD7138DRSR	ACTIVE	SON	DRS	6	3000	RoHS & Green	NIPDAU	Level-2-260C-1 YEAR	-40 to 125	UD7138	Samples
UCD7138DRST	ACTIVE	SON	DRS	6	250	RoHS & Green	NIPDAU	Level-2-260C-1 YEAR	-40 to 125	UD7138	Samples

(1) The marketing status values are defined as follows:

ACTIVE: Product device recommended for new designs.

LIFEBUY: TI has announced that the device will be discontinued, and a lifetime-buy period is in effect.

NRND: Not recommended for new designs. Device is in production to support existing customers, but TI does not recommend using this part in a new design.

PREVIEW: Device has been announced but is not in production. Samples may or may not be available.

OBSOLETE: TI has discontinued the production of the device.

(2) **RoHS:** TI defines "RoHS" to mean semiconductor products that are compliant with the current EU RoHS requirements for all 10 RoHS substances, including the requirement that RoHS substance do not exceed 0.1% by weight in homogeneous materials. Where designed to be soldered at high temperatures, "RoHS" products are suitable for use in specified lead-free processes. TI may reference these types of products as "Pb-Free".

RoHS Exempt: TI defines "RoHS Exempt" to mean products that contain lead but are compliant with EU RoHS pursuant to a specific EU RoHS exemption.

Green: TI defines "Green" to mean the content of Chlorine (Cl) and Bromine (Br) based flame retardants meet JS709B low halogen requirements of <=1000ppm threshold. Antimony trioxide based flame retardants must also meet the <=1000ppm threshold requirement.

(3) MSL, Peak Temp. - The Moisture Sensitivity Level rating according to the JEDEC industry standard classifications, and peak solder temperature.

(4) There may be additional marking, which relates to the logo, the lot trace code information, or the environmental category on the device.

(5) Multiple Device Markings will be inside parentheses. Only one Device Marking contained in parentheses and separated by a "~" will appear on a device. If a line is indented then it is a continuation of the previous line and the two combined represent the entire Device Marking for that device.

(6) Lead finish/Ball material - Orderable Devices may have multiple material finish options. Finish options are separated by a vertical ruled line. Lead finish/Ball material values may wrap to two lines if the finish value exceeds the maximum column width.

Important Information and Disclaimer:The information provided on this page represents TI's knowledge and belief as of the date that it is provided. TI bases its knowledge and belief on information provided by third parties, and makes no representation or warranty as to the accuracy of such information. Efforts are underway to better integrate information from third parties. TI has taken and continues to take reasonable steps to provide representative and accurate information but may not have conducted destructive testing or chemical analysis on incoming materials and chemicals. TI and TI suppliers consider certain information to be proprietary, and thus CAS numbers and other limited information may not be available for release.

In no event shall TI's liability arising out of such information exceed the total purchase price of the TI part(s) at issue in this document sold by TI to Customer on an annual basis.

TAPE AND REEL INFORMATION



QUADRANT ASSIGNMENTS FOR PIN 1 ORIENTATION IN TAPE



*All dimensions are nominal

Device	Package Type	Package Drawing	Pins	SPQ	Reel Diameter (mm)	Reel Width W1 (mm)	A0 (mm)	B0 (mm)	K0 (mm)	P1 (mm)	W (mm)	Pin1 Quadrant
UCD7138DRSR	SON	DRS	6	3000	330.0	12.4	3.3	3.3	1.1	8.0	12.0	Q2
UCD7138DRST	SON	DRS	6	250	180.0	12.4	3.3	3.3	1.1	8.0	12.0	Q2

TAPE AND REEL BOX DIMENSIONS

*All dimensions are nominal

Device	Package Type	Package Drawing	Pins	SPQ	Length (mm)	Width (mm)	Height (mm)
UCD7138DRSR	SON	DRS	6	3000	367.0	367.0	35.0
UCD7138DRST	SON	DRS	6	250	210.0	185.0	35.0

DRS (S-PWSON-N6)

PLASTIC SMALL OUTLINE NO-LEAD

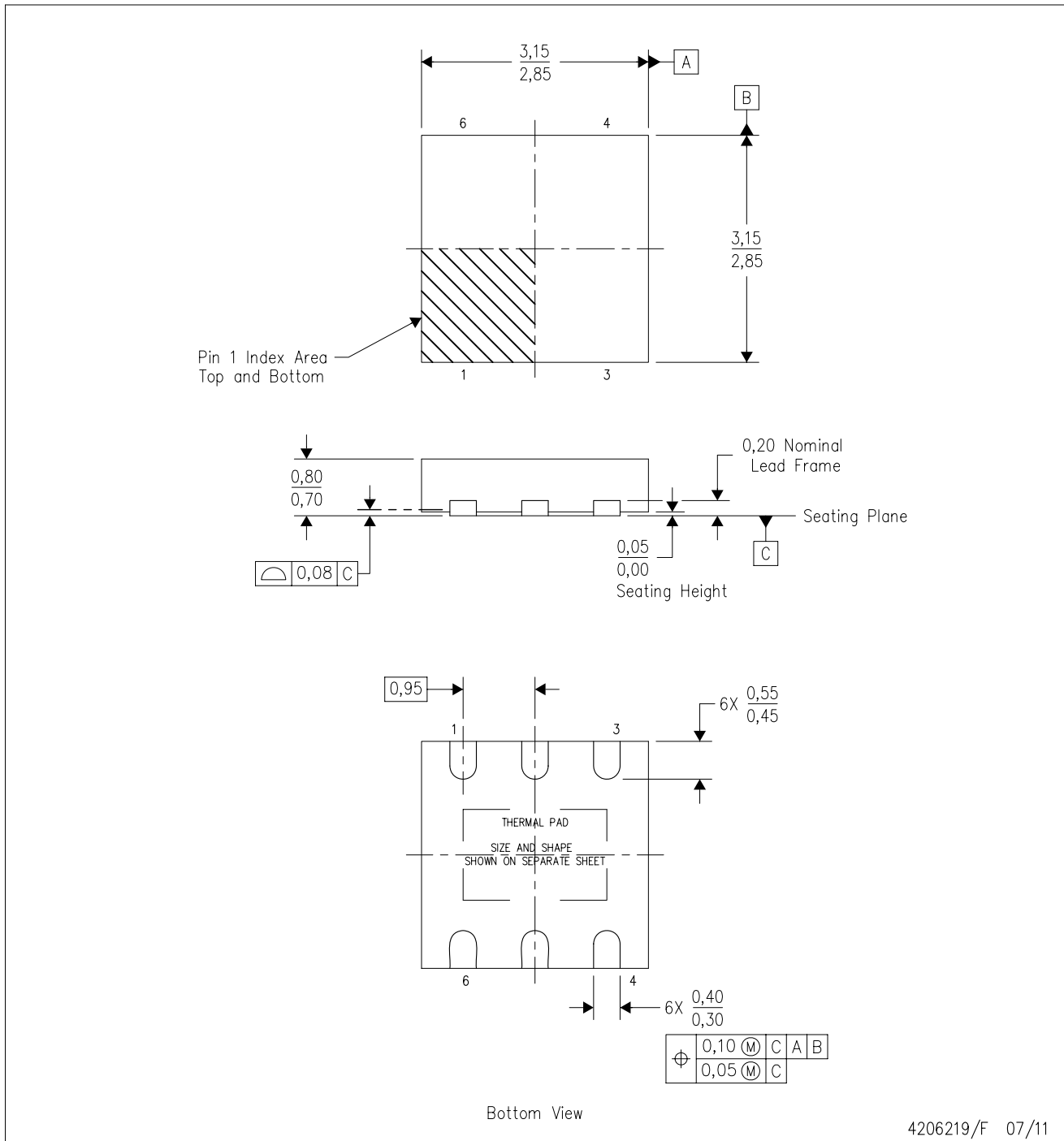

- NOTES:
- All linear dimensions are in millimeters. Dimensioning and tolerancing per ASME Y14.5M-1994.
 - This drawing is subject to change without notice.
 - SON (Small Outline No-Lead) package configuration.
 - The package thermal pad must be soldered to the board for thermal and mechanical performance.
 - See the additional figure in the Product Data Sheet for details regarding the exposed thermal pad features and dimensions.

THERMAL PAD MECHANICAL DATA

DRS (S-PWSON-N6)

PLASTIC SMALL OUTLINE NO-LEAD

THERMAL INFORMATION

This package incorporates an exposed thermal pad that is designed to be attached directly to an external heatsink. The thermal pad must be soldered directly to the printed circuit board (PCB). After soldering, the PCB can be used as a heatsink. In addition, through the use of thermal vias, the thermal pad can be attached directly to the appropriate copper plane shown in the electrical schematic for the device, or alternatively, can be attached to a special heatsink structure designed into the PCB. This design optimizes the heat transfer from the integrated circuit (IC).

For information on the Quad Flatpack No-Lead (QFN) package and its advantages, refer to Application Report, QFN/SON PCB Attachment, Texas Instruments Literature No. SLUA271. This document is available at www.ti.com.

The exposed thermal pad dimensions for this package are shown in the following illustration.

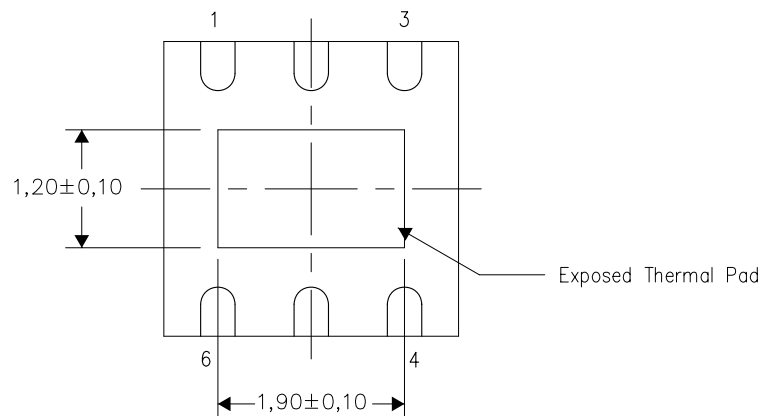

Bottom View

Exposed Thermal Pad Dimensions

4207663/E 07/11

NOTE: All linear dimensions are in millimeters

DRS (S-PWSON-N6)

PLASTIC SMALL OUTLINE NO-LEAD

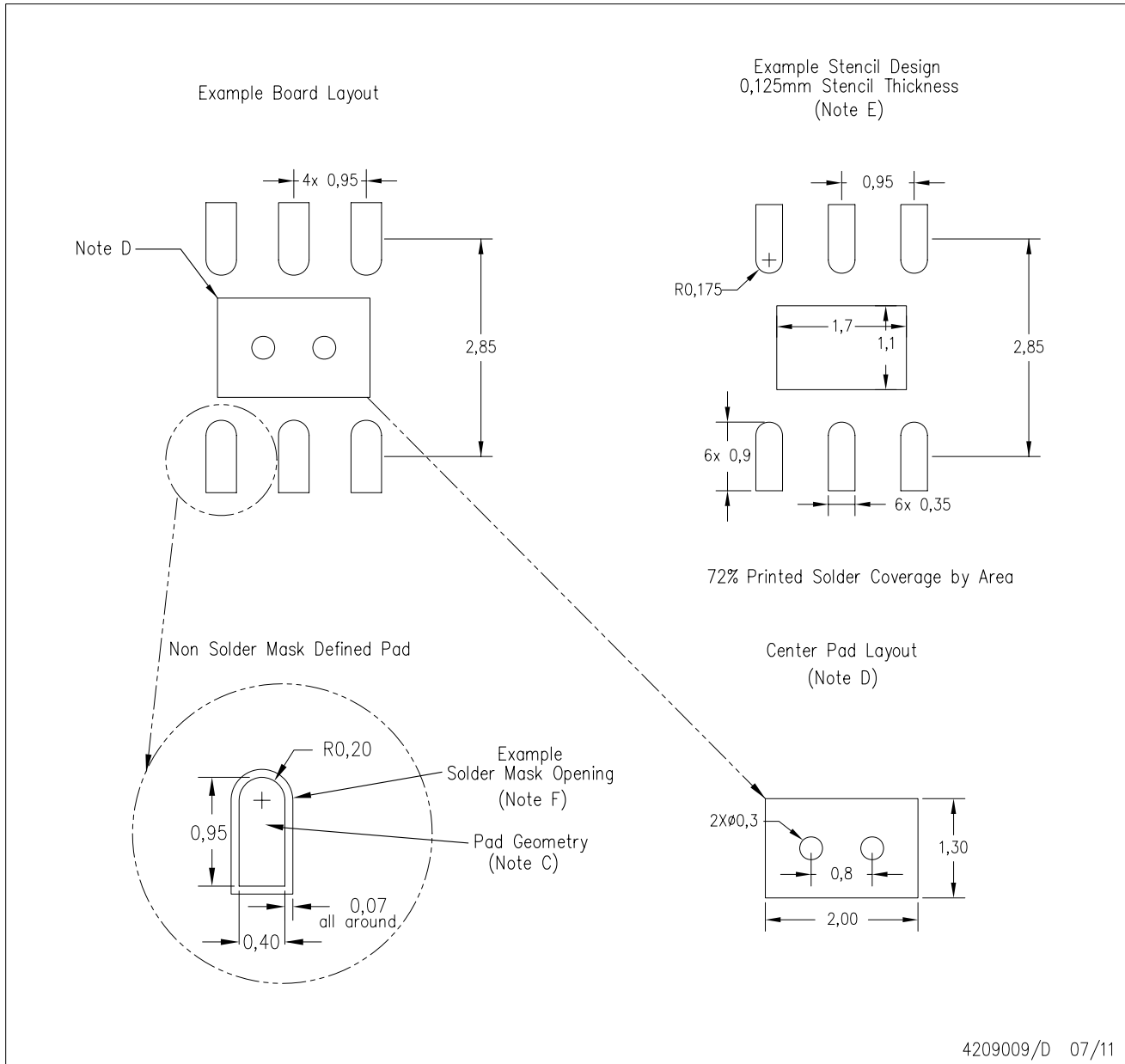

- NOTES:
- All linear dimensions are in millimeters.
 - This drawing is subject to change without notice.
 - Publication IPC-7351 is recommended for alternate designs.
 - This package is designed to be soldered to a thermal pad on the board. Refer to Application Note, QFN/SON PCB Attachment, Texas Instruments Literature No. SLUA271, and also the Product Data Sheets for specific thermal information, via requirements, and recommended board layout. These documents are available at www.ti.com <<http://www.ti.com>>.
 - Laser cutting apertures with trapezoidal walls and also rounding corners will offer better paste release. Customers should contact their board assembly site for stencil design recommendations. Refer to IPC 7525 for stencil design considerations.
 - Customers should contact their board fabrication site for solder mask tolerances.

重要声明和免责声明

TI 均以“原样”提供技术性及其可靠性数据（包括数据表）、设计资源（包括参考设计）、应用或其他设计建议、网络工具、安全信息和其他资源，不保证其中不含任何瑕疵，且不做任何明示或暗示的担保，包括但不限于对适销性、适合某特定用途或不侵犯任何第三方知识产权的暗示担保。

所述资源可供专业开发人员应用TI 产品进行设计使用。您将对以下行为独自承担全部责任：(1) 针对您的应用选择合适的TI 产品；(2) 设计、验证并测试您的应用；(3) 确保您的应用满足相应标准以及任何其他安全、安保或其他要求。所述资源如有变更，恕不另行通知。TI 对您使用所述资源的授权仅限于开发资源所涉及TI 产品的相关应用。除此之外不得复制或展示所述资源，也不提供其它TI 或任何第三方的知识产权授权许可。如因使用所述资源而产生任何索赔、赔偿、成本、损失及债务等，TI 对此概不负责，并且您须赔偿由此对TI 及其代表造成的损害。

TI 所提供产品均受TI 的销售条款 (<http://www.ti.com.cn/zh-cn/legal/termsofsale.html>) 以及ti.com.cn上或随附TI产品提供的其他可适用条款的约束。TI提供所述资源并不扩展或以其他方式更改TI 针对TI 产品所发布的可适用的担保范围或担保免责声明。

邮寄地址：上海市浦东新区世纪大道 1568 号中建大厦 32 楼，邮政编码：200122

Copyright © 2020 德州仪器半导体技术（上海）有限公司