

TPS7A25 具有电源正常状态指示功能的 300mA、18V、超低 I_Q 、低压降线性稳压器

1 特性

- 超低 I_Q : 2 μ A
- 输入电压 : 2.4V 至 18V
- 可用输出电压选项 :
 - 固定 : 1.25V 至 5.0V
 - 可调节 : 1.24 V 至 17.66 V
- 在温度范围内的精度为 1%
- 低压降 : 300 mA 时为 340 mV (最大值)
- 开漏电源正常状态输出
- 热关断保护和过流保护
- 有源过冲下拉
- 工作结温 : -40°C 至 +125°C
- 与 1 μ F 输出电容器一起工作时保持稳定
- 封装 : 6 引脚 WSON

2 应用

- 家庭和楼宇自动化
- 多节电池移动电源
- 智能电网和计量
- 便携式电动工具
- 电机驱动器
- 白色家电
- 便携式电器

3 说明

TPS7A25 低压降 (LDO) 线性稳压器集 2.4V 至 18V 输入电压范围和极低静态电流 (I_Q) 特性于一体。这些特性帮助现代电器满足日益严苛的能源要求, 并有助于延长便携式电源解决方案的电池寿命。

TPS7A25 有固定电压和可调节电压两种版本可供选用。为获得更大的灵活性或更高的输出电压, 可调节电压版本使用反馈电阻器将输出电压设置为 1.24 V 到 17.64V 之间。两种版本都具有 1% 的输出调节精度, 可对微控制器 (MCU) 基准电压进行精密调节。

在电流为 300mA 时, TPS7A25 LDO 的最大压降小于 340mV, 因此它比标准线性稳压器的工作效率更高。此最大压降使得在 5.4V 输入电压 (V_{IN}) 至 5.0V 输出电压 (V_{OUT}) 范围内的效率达到了 92.5%。

电源正常状态 (PG) 指示灯可以用来将 MCU 保持在复位状态, 直到电源正常, 或用于电源定序。PG 引脚为开漏输出; 因此, 该引脚很容易进行电平位移, 以便通过 V_{OUT} 以外的导轨进行监控。内置电流限制和热关断有助于在发生负载短路或故障时保护稳压器。

如需更高的输出电流选项, 请考虑 [TPS7A26](#)。

封装信息⁽¹⁾

器件型号	封装	封装尺寸 (NOM)
TPS7A25	DRV (WSON, 6)	2.00mm x 2.00mm

(1) 如需了解所有可用封装, 请参阅数据表末尾的封装选项附录。

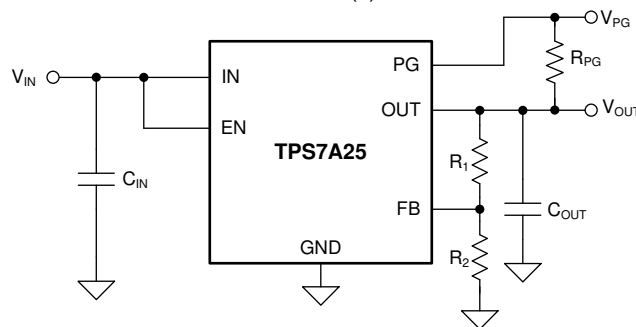

典型应用电路



Table of Contents

1 特性	1	8.2 Functional Block Diagrams	13
2 应用	1	8.3 Feature Description	14
3 说明	1	8.4 Device Functional Modes	17
4 Revision History	2	9 Device and Documentation Support	25
5 Pin Configuration and Functions	3	9.1 Device Support	25
6 Specifications	4	9.2 Documentation Support	25
6.1 Absolute Maximum Ratings.....	4	9.3 接收文档更新通知	25
6.2 ESD Ratings.....	4	9.4 支持资源	25
6.3 Recommended Operating Conditions.....	5	9.5 Trademarks	25
6.4 Thermal Information.....	5	9.6 Electrostatic Discharge Caution	25
6.5 Electrical Characteristics.....	6	9.7 术语表	25
7 Typical Characteristics	7	10 Mechanical, Packaging, and Orderable Information	25
8 Detailed Description	13	10.1 Mechanical Data	26
8.1 Overview.....	13		

4 Revision History

注：以前版本的页码可能与当前版本的页码不同

Changes from Revision B (August 2019) to Revision C (December 2022)	Page
• 更改了 <i>输出电压选项</i> 要点中的最大值：将固定电压从 5.5V 更改为 5V.....	1
• Added Vout abs max ratings for fixed version.....	4

Changes from Revision A (March 2019) to Revision B (August 2019)	Page
• 更改了 <i>输出电压选项</i> 要点中的最大值：将固定电压从 5V 更改为 5.5V，并将可调节电压从 17.64V 更改为 17.66V.....	1
• 更改了“说明”部分：删除了第二段中有关固定电压的描述，将 360mV 更改为 340mV，并添加了最后一段..	1
• Added fixed version to <i>Pin Configuration and Functions</i> section.....	3
• Added accuracy for fixed output options.....	6
• Added <i>Fixed Version</i> image to <i>Functional Block Diagrams</i> section.....	13
• Added <i>Active</i> to <i>Active Overshoot Pulldown Circuitry</i> section title.....	16
• Added <i>Fixed Version Layout Example</i> figure.....	24

5 Pin Configuration and Functions



图 5-1. TPS7A25: DRV Package (Adjustable), 6-Pin WSON (Top View)



图 5-2. TPS7A25: DRV Package (Fixed), 6-Pin WSON (Top View)

表 5-1. Pin Functions

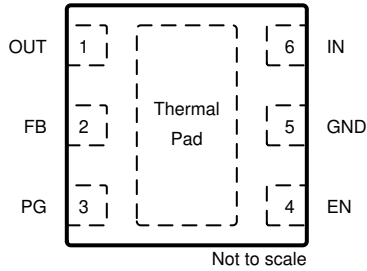
NAME	PIN		I/O	DESCRIPTION
	DRV (Adjustable)	DRV (Fixed)		
EN	4	4	Input	Enable pin. Drive EN greater than $V_{EN(HI)}$ to enable the regulator. Drive EN less than $V_{EN(LOW)}$ to put the regulator into low-current shutdown. Do not float this pin. If not used, connect EN to IN.
FB	2	—	Input	Feedback pin. Input to the control-loop error amplifier. This pin is used to set the output voltage of the device with the use of external resistors. For adjustable-voltage version devices only.
GND	5	5	—	Ground pin.
IN	6	6	Input	Input pin. For best transient response and to minimize input impedance, use the recommended value or larger capacitor from IN to ground as listed in the <i>Recommended Operating Conditions</i> table. Place the input capacitor as close to the IN and GND pins of the device as possible.
NC	—	2	—	No internal connection. For fixed-voltage version devices only. This pin can be floated but the device will have better thermal performance with this pin tied to GND.
OUT	1	1	Output	Output pin. A capacitor is required from OUT to ground for stability. For best transient response, use the nominal recommended value or larger capacitor from OUT to ground. Follow the recommended capacitor value as listed in the <i>Recommended Operating Conditions</i> table. Place the output capacitor as close to the OUT and GND pins of the device as possible.
PG	3	3	Output	Power-good pin; open-collector output. Pullup externally to the OUT pin or another voltage rail. The PG pin goes high when $V_{OUT} > V_{IT(PG,RISING)}$ in the <i>Electrical Characteristics</i> table. The PG pin is driven low when $V_{OUT} < V_{IT(PG,FALLING)}$ in the <i>Electrical Characteristics</i> table. If not used this pin can be floated but the device will have better thermal performance with this pin tied to GND.
Thermal pad	Pad	Pad	—	Exposed pad of the package. Connect this pad to ground or leave floating. Connect the thermal pad to a large-area ground plane for best thermal performance.

6 Specifications

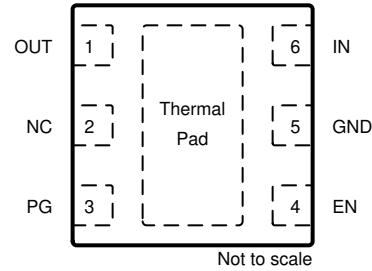
6.1 Absolute Maximum Ratings

over operating free-air temperature range (unless otherwise noted)⁽¹⁾

		MIN	MAX	UNIT
Voltage ⁽²⁾	V _{IN}	- 0.3	20	V
	V _{OUT} (adjustable version)	- 0.3	V _{IN} + 0.3 ⁽³⁾	
	V _{OUT} (fixed version)	- 0.3	5.5	
	V _{FB}	- 0.3	5.5	
	V _{EN}	- 0.3	20	
	V _{PG}	- 0.3	20	
Current	Maximum output	Internally limited		A
Temperature	Operating junction, T _J	- 50	150	°C
	Storage, T _{stg}	- 65	150	

- (1) Stresses beyond those listed under *Absolute Maximum Ratings* may cause permanent damage to the device. These are stress ratings only, which do not imply functional operation of the device at these or any other conditions beyond those indicated under *Recommended Operating Conditions*. Exposure to absolute-maximum-rated conditions for extended periods may affect device reliability.
- (2) All voltages with respect to GND.
- (3) V_{IN} + 0.3 V or 20 V (whichever is smaller).

6.2 ESD Ratings

			VALUE	UNIT
V _(ESD)	Electrostatic discharge	Human body model (HBM), per ANSI/ESDA/JEDEC JS-001 ⁽¹⁾	±2000	V
		Charged device model (CDM), per JEDEC specification JESD22-C101 ⁽²⁾	±1000	

- (1) JEDEC document JEP155 states that 2-kV HBM allows safe manufacturing with a standard ESD control process.
- (2) JEDEC document JEP157 states that 500-V CDM allows safe manufacturing with a standard ESD control process.

6.3 Recommended Operating Conditions

		MIN	NOM	MAX	UNIT
V _{IN}	Input voltage	2.4		18	V
V _{OUT}	Output voltage (adjustable version)	1.24		18 - V _{DO}	V
V _{OUT}	Output voltage (fixed version)	1.25		5.0	V
I _{OUT}	Output current	0		300	mA
V _{EN}	Enable voltage	0		18	V
V _{PG} ⁽¹⁾	Power-good voltage	0		18	V
C _{IN} ⁽²⁾	Input capacitor		1		μF
C _{OUT} ⁽²⁾	Output capacitor	1	2.2	100	μF
T _J	Operating junction temperature	- 40		125	°C

- (1) Select pullup resistor to limit PG pin sink current when PG output is driven low. See the *Power Good* section for details.
(2) All capacitor values are assumed to derate to 50% of the nominal capacitor value.

6.4 Thermal Information

THERMAL METRIC ⁽¹⁾		TPS7A25	
		DRV (WSON)	
		6 PINS	
			UNIT
R _{θJA}	Junction-to-ambient thermal resistance	73.3	°C/W
R _{θJC(top)}	Junction-to-case (top) thermal resistance	90.6	°C/W
R _{θJB}	Junction-to-board thermal resistance	38.3	°C/W
ψ _{JT}	Junction-to-top characterization parameter	3.7	°C/W
ψ _{JB}	Junction-to-board characterization parameter	38.4	°C/W
R _{θJC(bot)}	Junction-to-case (bottom) thermal resistance	14.3	°C/W

- (1) For more information about traditional and new thermal metrics, see the [Semiconductor and IC Package Thermal Metrics](#) application report.

6.5 Electrical Characteristics

specified at $T_J = -40^\circ\text{C}$ to $+125^\circ\text{C}$, $V_{IN} = V_{OUT(nom)} + 0.5\text{ V}$ or $V_{IN} = 2.4\text{ V}$ (whichever is greater), FB tied to OUT, $I_{OUT} = 1\text{ mA}$, $V_{EN} = 2\text{ V}$, and $C_{IN} = 1\ \mu\text{F}$, $C_{OUT} = 2.2\ \mu\text{F}$ ceramic (unless otherwise noted); typical values are at $T_J = 25^\circ\text{C}$

PARAMETER		TEST CONDITIONS	MIN	TYP	MAX	UNIT
$V_{UVLO(RISING)}$	UVLO threshold rising	V_{IN} rising	1.95	2.15	2.35	V
$V_{UVLO(HYS)}$	UVLO hysteresis			70		mV
$V_{UVLO(FALLING)}$	UVLO threshold falling	V_{IN} falling	1.85	2.09	2.25	V
V_{FB}	Feedback voltage	Adjustable version only		1.24		V
V_{OUT}	Output voltage accuracy	Adjustable version, $V_{OUT} = V_{FB}$	1.228	1.24	1.252	V
V_{OUT}	Output voltage accuracy	Fixed output versions	-1		1	%
$\Delta V_{OUT(\Delta V_{IN})}$	Line regulation ⁽¹⁾	$(V_{OUT(nom)} + 0.5\text{ V or } 2.4\text{ V}) \leq V_{IN} \leq 18\text{ V}$	-0.1		0.1	%
$\Delta V_{OUT(\Delta I_{OUT})}$	Load regulation	$1\text{ mA} \leq I_{OUT} \leq 300\text{ mA}$	-0.5		0.5	%
V_{DO}	Dropout voltage ⁽²⁾	$I_{OUT} = 50\text{ mA}$		64	105	mV
		$I_{OUT} = 150\text{ mA}$		120	180	
		$I_{OUT} = 300\text{ mA}$		210	340	
I_{CL}	Output current limit	$V_{OUT} = 0.9 \times V_{OUT(nom)}$	325	510	720	mA
I_{GND}	Ground pin current	$I_{OUT} = 0\text{ mA}$		2	4.5	μA
		$I_{OUT} = 1\text{ mA}$		15		
$I_{SHUTDOWN}$	Shutdown current	$V_{EN} \leq 0.4\text{ V}$, $V_{IN} = 2.4\text{ V}$, $I_{out} = 0\text{ mA}$		325	600	nA
I_{FB}	FB pin current			10		nA
I_{EN}	EN pin current	$V_{EN} = 18\text{ V}$		10		nA
$V_{EN(HI)}$	Enable pin high-level input voltage	Device enabled	0.9			V
$V_{EN(LOW)}$	Enable pin low-level input voltage	Device disabled			0.4	V
$V_{IT(PG,RISING)}$	PG pin threshold rising	$R_{PULLUP} = 10\text{ k}\Omega$, V_{OUT} rising, $V_{IN} \geq V_{UVLO(RISING)}$		93	96.5	$\%V_{OUT}$
$V_{HYS(PG)}$	PG pin hysteresis	$R_{PULLUP} = 10\text{ k}\Omega$, V_{OUT} falling, $V_{IN} \geq V_{UVLO(RISING)}$		3		$\%V_{OUT}$
$V_{IT(PG,FALLING)}$	PG pin threshold falling	$R_{PULLUP} = 10\text{ k}\Omega$, V_{OUT} falling, $V_{IN} \geq V_{UVLO(RISING)}$	84	90		$\%V_{OUT}$
$V_{OL(PG)}$	PG pin low level output voltage	$V_{OUT} < V_{IT(PG,FALLING)}$, $I_{PG-SINK} = 500\ \mu\text{A}$			0.4	V
$I_{LKG(PG)}$	PG pin leakage current	$V_{OUT} > V_{IT(PG,RISING)}$, $V_{PG} = 18\text{ V}$		5	300	nA
PSRR	Power-supply rejection ratio	$f = 10\text{ Hz}$		75		dB
		$f = 100\text{ Hz}$		62		
		$f = 1\text{ kHz}$		52		
V_n	Output noise voltage	$BW = 10\text{ Hz to } 100\text{ kHz}$, $V_{OUT} = 1.2\text{ V}$		300		μV_{RMS}
$T_{SD(shutdown)}$	Thermal shutdown temperature	Shutdown, temperature increasing		165		$^\circ\text{C}$
$T_{SD(reset)}$	Thermal shutdown reset temperature	Reset, temperature decreasing		145		$^\circ\text{C}$

(1) $V_{out(nom)} + 0.5\text{ V}$ or 2.4 V (whichever is greater).

(2) V_{DO} is measured with $V_{IN} = 0.97 \times V_{OUT(nom)}$ for fixed output voltage versions. V_{DO} is not measured for fixed output voltage versions when $V_{OUT} \leq 2.5\text{ V}$. For the adjustable output device, V_{DO} is measured with $V_{FB} = 0.97 \times V_{FB(nom)}$.

7 Typical Characteristics

at operating temperature $T_J = 25^\circ\text{C}$, $I_{OUT} = 1\text{ mA}$, $V_{EN} = 0.9\text{ V}$, $C_{IN} = 2.2\ \mu\text{F}$, $C_{OUT} = 2.2\ \mu\text{F}$, and $V_{IN} = V_{OUT(\text{typ})} + 0.5\text{ V}$ or 2.4 V (whichever is greater), unless otherwise noted; typical values are at $T_J = 25^\circ\text{C}$



图 7-1. Line Regulation vs V_{IN}



图 7-2. Load Regulation vs I_{OUT}

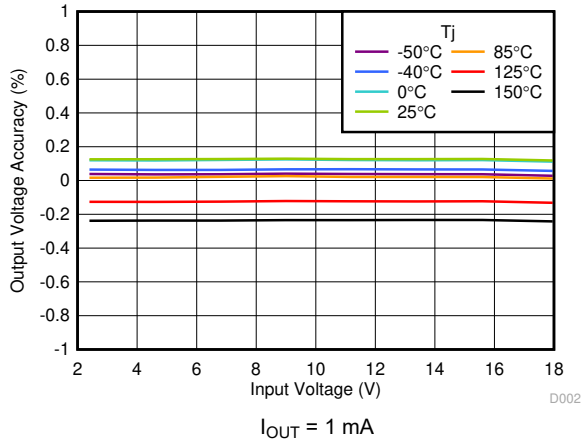

图 7-3. Dropout Voltage vs V_{IN}

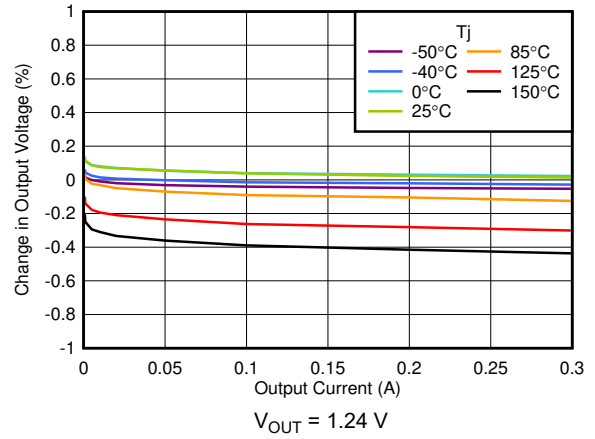

图 7-4. Dropout Voltage vs V_{IN}

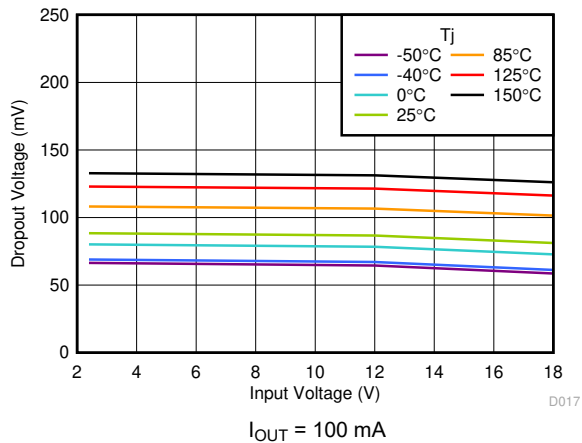

图 7-5. Dropout Voltage vs V_{IN}

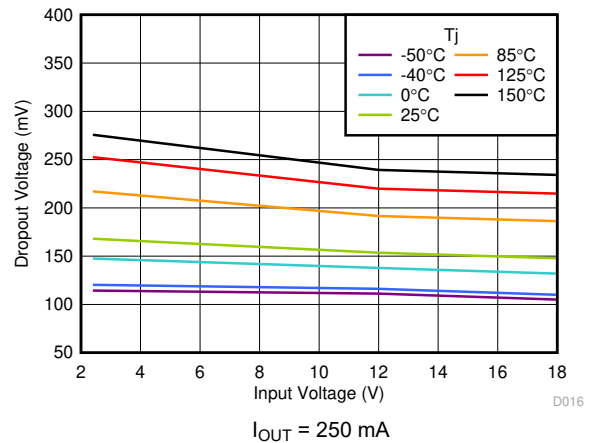

图 7-6. Dropout Voltage vs I_{IN}

7 Typical Characteristics (continued)

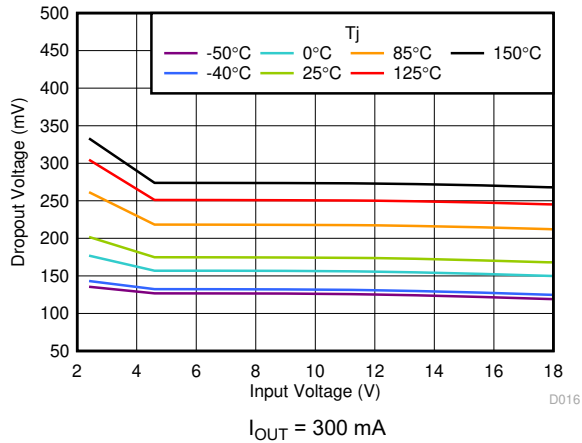
at operating temperature $T_J = 25^\circ\text{C}$, $I_{OUT} = 1\text{ mA}$, $V_{EN} = 0.9\text{ V}$, $C_{IN} = 2.2\ \mu\text{F}$, $C_{OUT} = 2.2\ \mu\text{F}$, and $V_{IN} = V_{OUT(\text{typ})} + 0.5\text{ V}$ or 2.4 V (whichever is greater), unless otherwise noted; typical values are at $T_J = 25^\circ\text{C}$

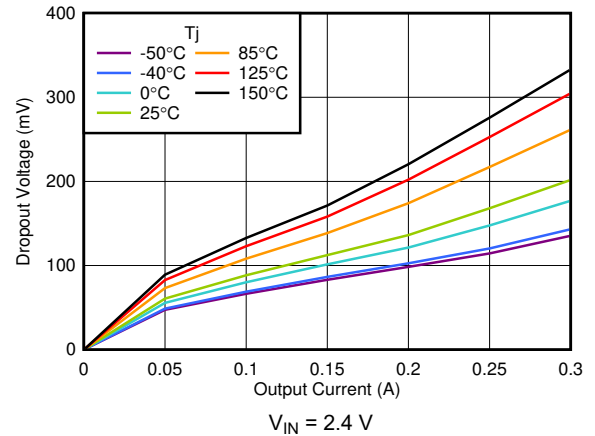

图 7-7. Dropout Voltage vs I_{OUT}



图 7-8. Current Limit vs V_{IN}

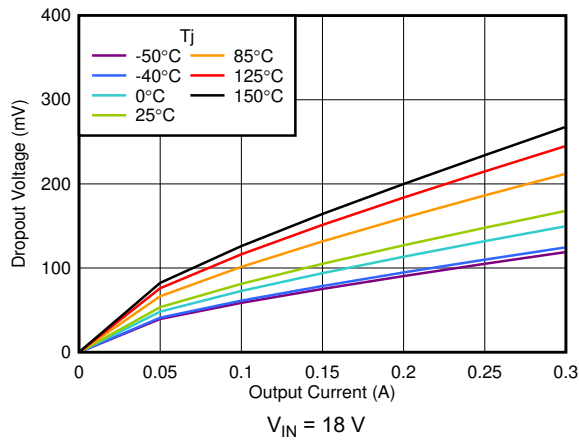

图 7-9. I_{GND} vs V_{IN}

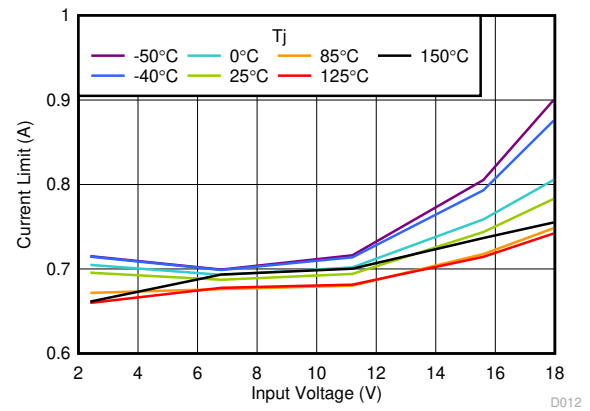

图 7-10. I_Q vs V_{IN}

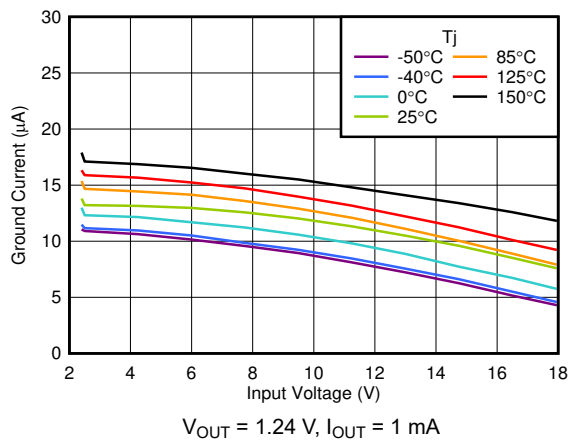

图 7-11. I_Q vs V_{IN}

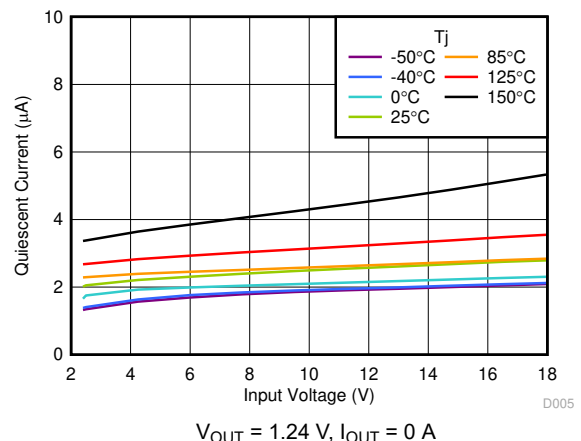

图 7-12. I_{GND} vs I_{OUT}

7 Typical Characteristics (continued)

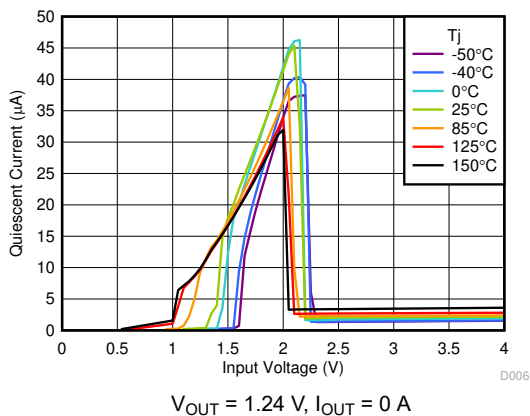
at operating temperature $T_J = 25^\circ\text{C}$, $I_{OUT} = 1\text{ mA}$, $V_{EN} = 0.9\text{ V}$, $C_{IN} = 2.2\ \mu\text{F}$, $C_{OUT} = 2.2\ \mu\text{F}$, and $V_{IN} = V_{OUT(\text{typ})} + 0.5\text{ V}$ or 2.4 V (whichever is greater), unless otherwise noted; typical values are at $T_J = 25^\circ\text{C}$

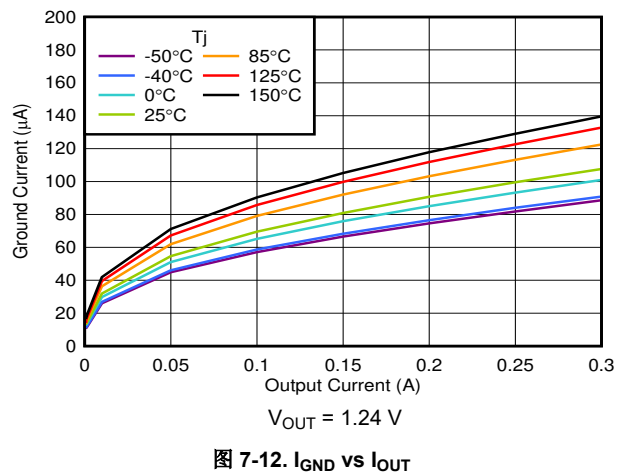

图 7-13. Shutdown Current vs V_{IN}



图 7-14. V_{EN} Thresholds vs Temperature

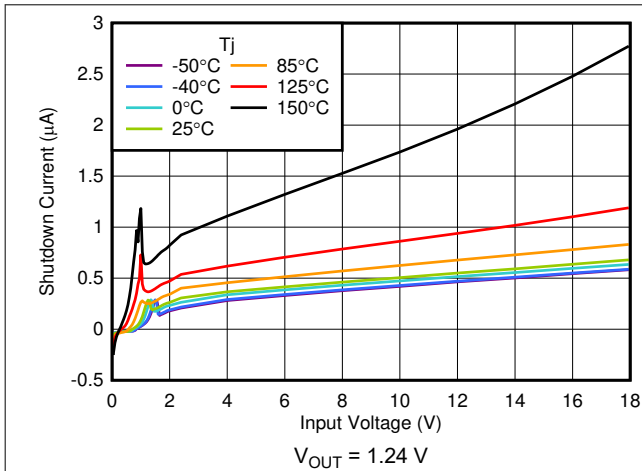

图 7-15. UVLO Thresholds vs Temperature

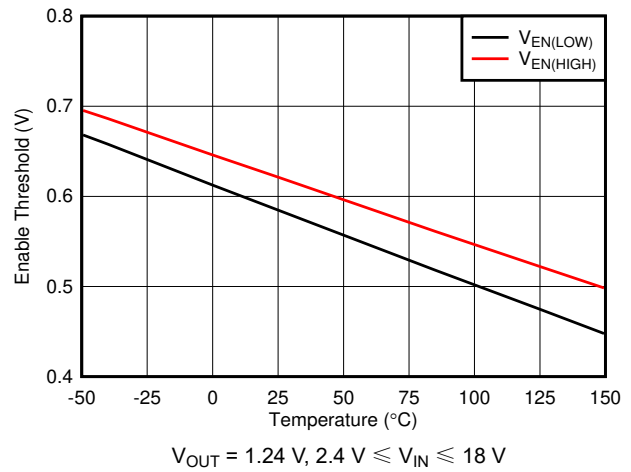

图 7-16. PG Thresholds vs Temperature

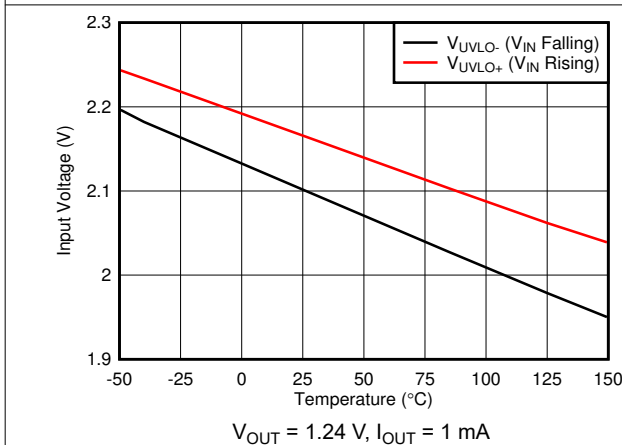

图 7-17. PG Leakage Current vs Temperature

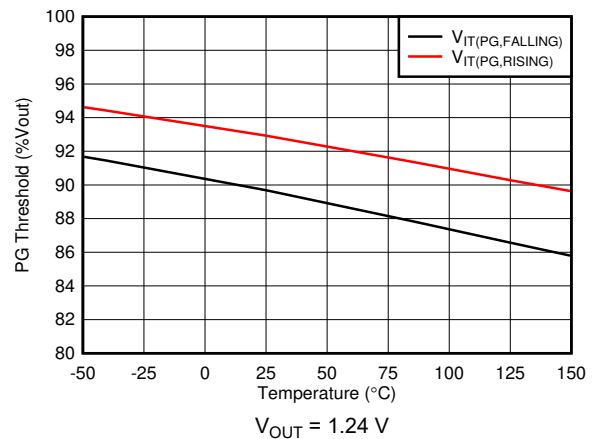

图 7-18. PSRR vs Frequency and I_{OUT}

7 Typical Characteristics (continued)

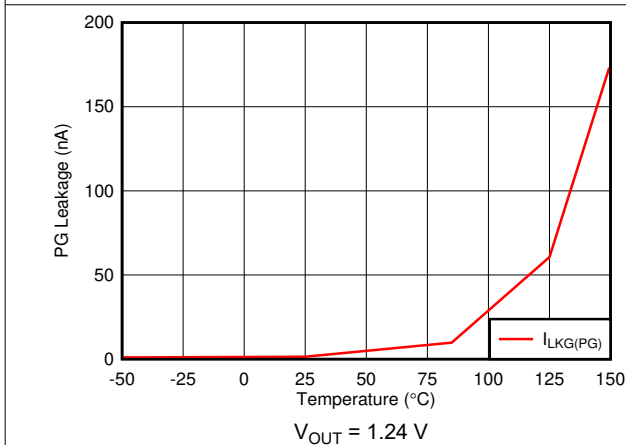
at operating temperature $T_J = 25^\circ\text{C}$, $I_{OUT} = 1\text{ mA}$, $V_{EN} = 0.9\text{ V}$, $C_{IN} = 2.2\ \mu\text{F}$, $C_{OUT} = 2.2\ \mu\text{F}$, and $V_{IN} = V_{OUT(\text{typ})} + 0.5\text{ V}$ or 2.4 V (whichever is greater), unless otherwise noted; typical values are at $T_J = 25^\circ\text{C}$

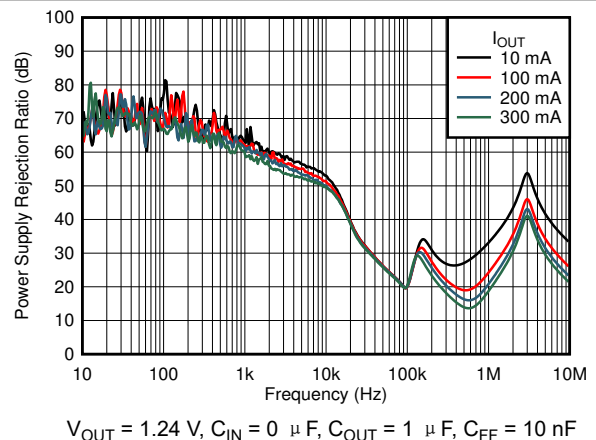

图 7-19. PSRR vs Frequency and I_{OUT}



图 7-20. PSRR vs Frequency and V_{IN}

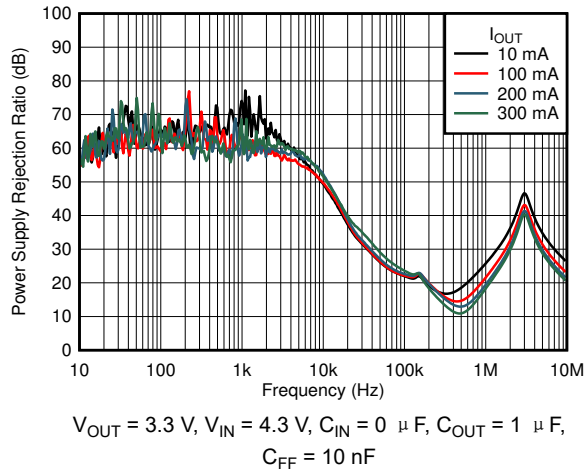

图 7-21. PSRR vs Frequency and C_{OUT}

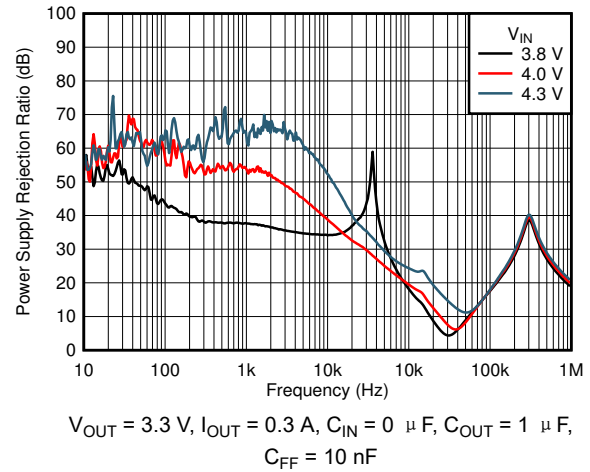

图 7-22. PSRR vs Frequency and C_{FF}

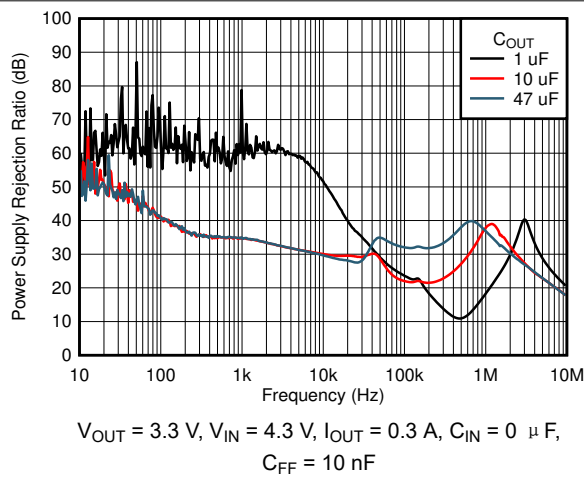

图 7-23. PSRR vs Frequency and V_{OUT}

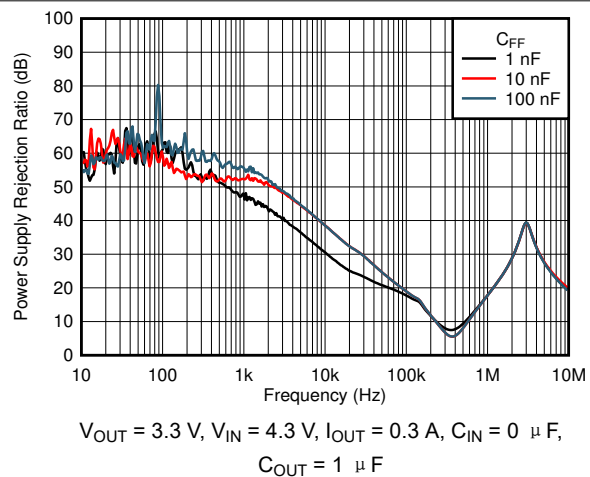

图 7-24. Output Noise (V_n) vs Frequency and V_{OUT}

7 Typical Characteristics (continued)

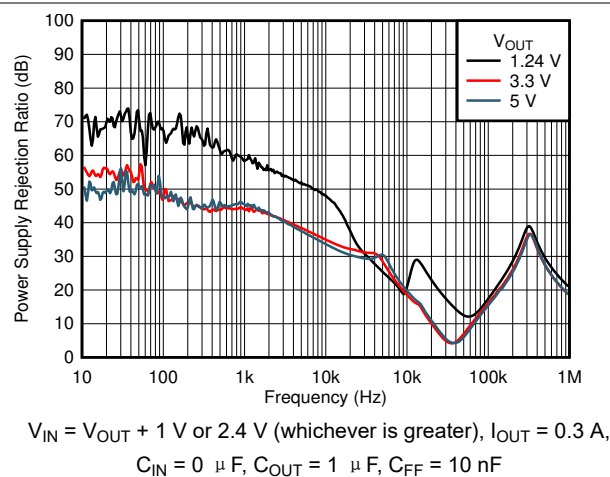
at operating temperature $T_J = 25^\circ\text{C}$, $I_{OUT} = 1\text{ mA}$, $V_{EN} = 0.9\text{ V}$, $C_{IN} = 2.2\ \mu\text{F}$, $C_{OUT} = 2.2\ \mu\text{F}$, and $V_{IN} = V_{OUT(\text{typ})} + 0.5\text{ V}$ or 2.4 V (whichever is greater), unless otherwise noted; typical values are at $T_J = 25^\circ\text{C}$

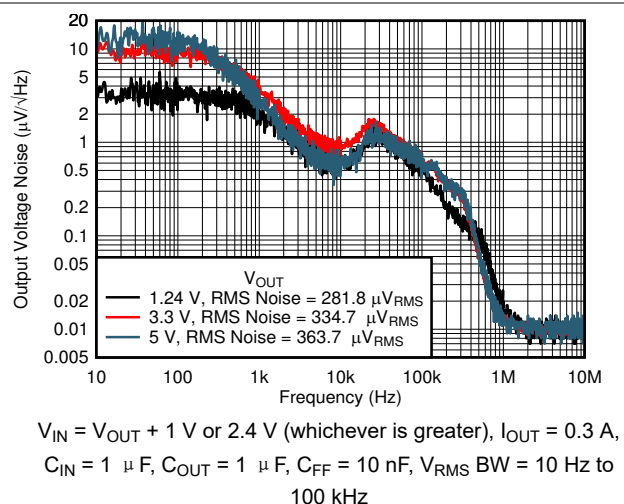

图 7-25. Output Noise (V_n) vs Frequency and I_{OUT}



图 7-26. Output Noise (V_n) vs Frequency and C_{OUT}

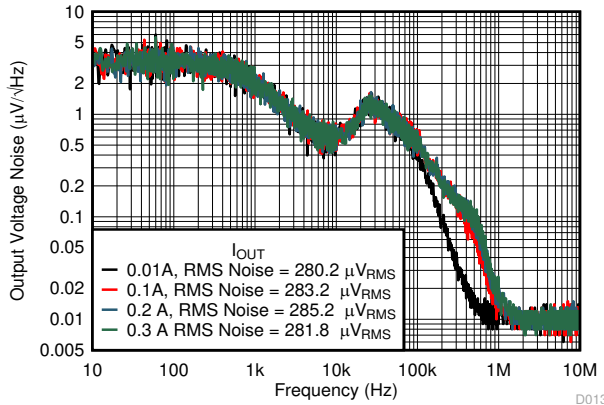

图 7-27. Output Noise (V_n) vs Frequency and C_{FF}

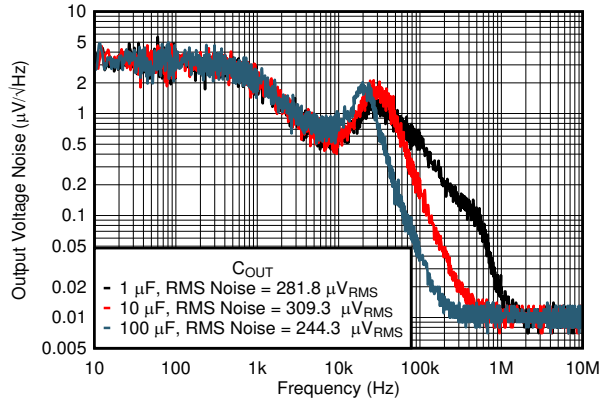

图 7-28. Load Transient

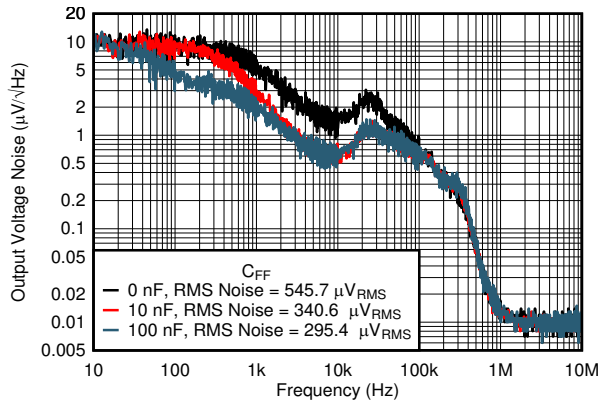

图 7-29. Load Transient

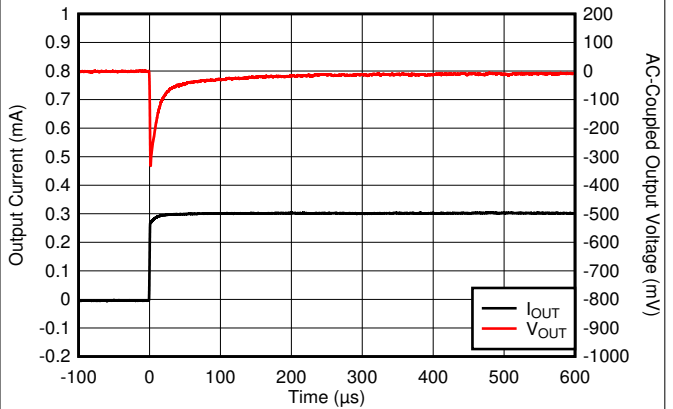

图 7-30. Line Transient

7 Typical Characteristics (continued)

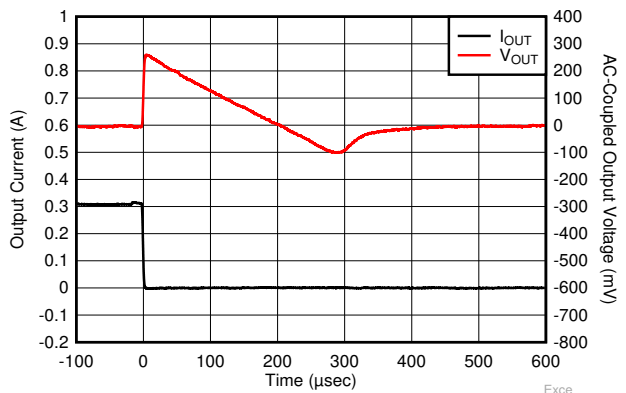
at operating temperature $T_J = 25^\circ\text{C}$, $I_{OUT} = 1\text{ mA}$, $V_{EN} = 0.9\text{ V}$, $C_{IN} = 2.2\ \mu\text{F}$, $C_{OUT} = 2.2\ \mu\text{F}$, and $V_{IN} = V_{OUT(\text{typ})} + 0.5\text{ V}$ or 2.4 V (whichever is greater), unless otherwise noted; typical values are at $T_J = 25^\circ\text{C}$

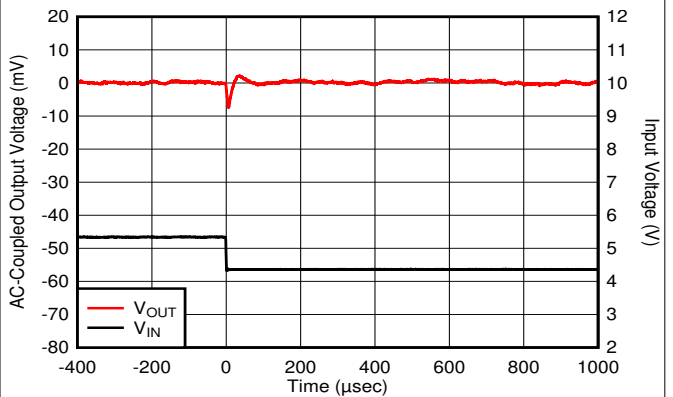

图 7-31. Line Transient



图 7-32. Start-Up With Enable

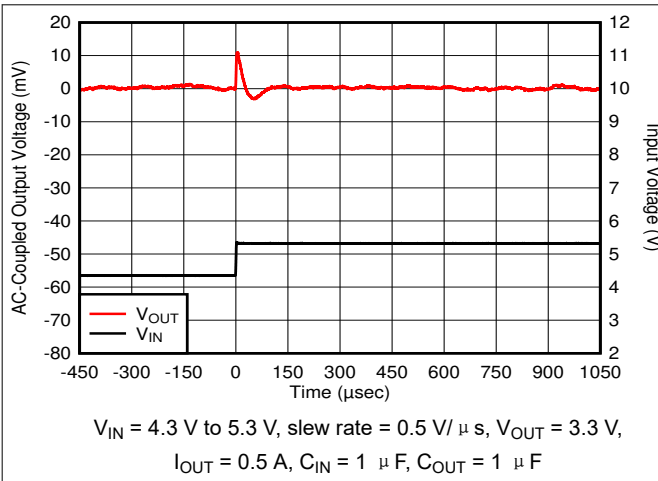

图 7-33. Start-Up With Enable Pin Tied to Input

8 Detailed Description

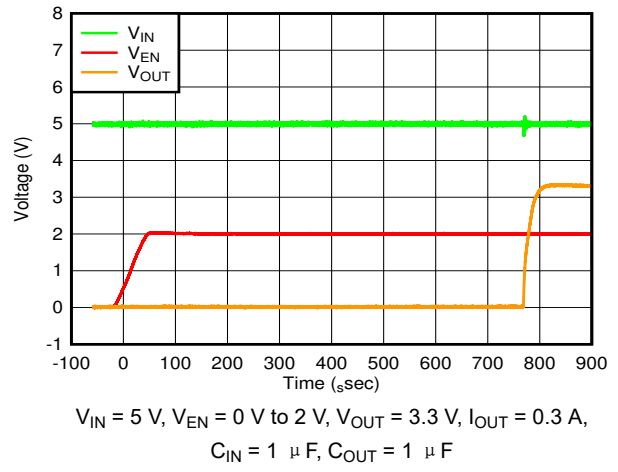
8.1 Overview

The TPS7A25 is an 18-V, low quiescent current, low-dropout (LDO) linear regulator. The low I_Q performance makes the TPS7A25 an excellent choice for battery-powered or line-power applications that are expected to meet increasingly stringent standby-power standards.

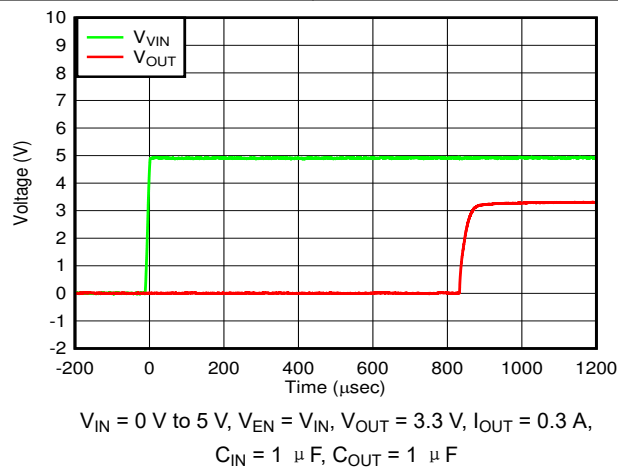
The 1% accuracy over temperature and power-good indication make this device an excellent choice for meeting a wide range of microcontroller power requirements. Additionally, the TPS7A25 has an internal soft-start to minimize inrush current into the output capacitance.

For increased reliability, the TPS7A25 also incorporates overcurrent, overshoot pulldown, and thermal shutdown protection. The operating junction temperature is -40°C to $+125^{\circ}\text{C}$, and adds margin for applications concerned with higher working ambient temperatures.

The TPS7A25 is available in a thermally enhanced WSON package.

8.2 Functional Block Diagrams



图 8-1. Adjustable Version



图 8-2. Fixed Version

8.3 Feature Description

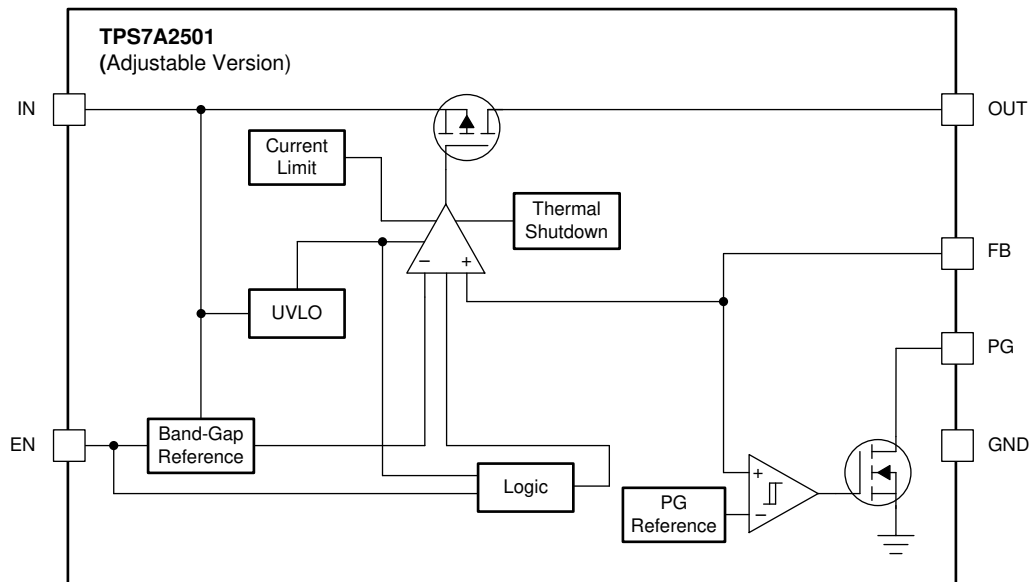
8.3.1 Output Enable

The enable pin for the device is an active-high pin. The output voltage is enabled when the voltage of the enable pin is greater than the high-level input voltage of the EN pin and disabled when the enable pin voltage is less than the low-level input voltage of the EN pin. If independent control of the output voltage is not needed, connect the enable pin to the input of the device.

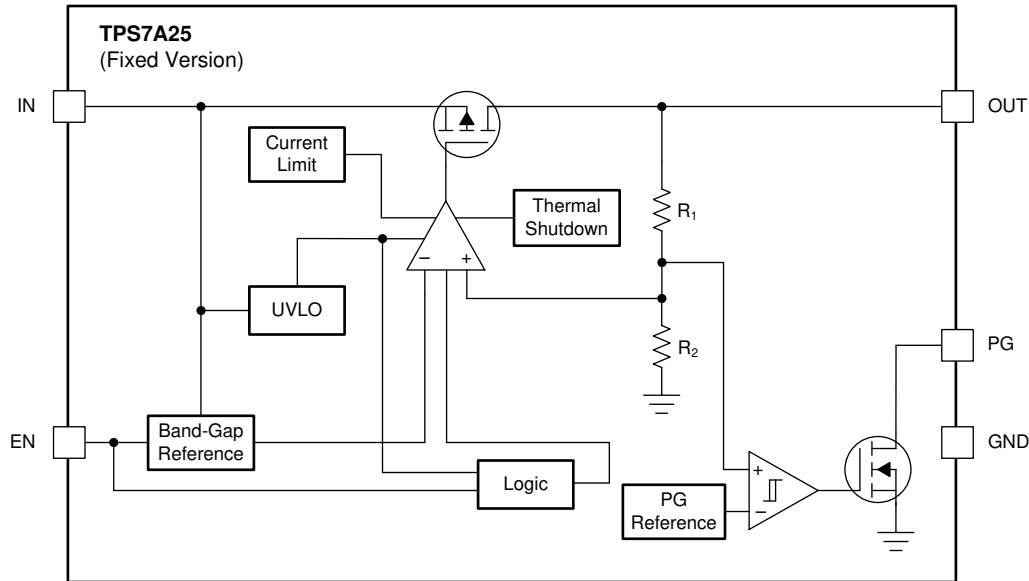
8.3.2 Dropout Voltage

Dropout voltage (V_{DO}) is defined as the input voltage minus the output voltage ($V_{IN} - V_{OUT}$) at the rated output current (I_{RATED}), where the pass transistor is fully on. I_{RATED} is the maximum I_{OUT} listed in the *Recommended Operating Conditions* table. The pass transistor is in the ohmic or triode region of operation, and acts as a switch. The dropout voltage indirectly specifies a minimum input voltage greater than the nominal programmed output voltage at which the output voltage is expected to stay in regulation. If the input voltage falls to less than the nominal output regulation, then the output voltage falls as well.

For a CMOS regulator, the dropout voltage is determined by the drain-source on-state resistance ($R_{DS(ON)}$) of the pass transistor. Therefore, if the linear regulator operates at less than the rated current, the dropout voltage for that current scales accordingly. Use [方程式 1](#) to calculate the $R_{DS(ON)}$ of the device.

$$R_{DS(ON)} = \frac{V_{DO}}{I_{RATED}} \quad (1)$$

8.3.3 Current Limit

The device has an internal current limit circuit that protects the regulator during transient high-load current faults or shorting events. The current limit is a brick-wall scheme. In a high-load current fault, the brick-wall scheme limits the output current to the current limit (I_{CL}). I_{CL} is listed in the *Electrical Characteristics* table.

The output voltage is not regulated when the device is in current limit. When a current limit event occurs, the device begins to heat up because of the increase in power dissipation. When the device is in brick-wall current limit, the pass transistor dissipates power $[(V_{IN} - V_{OUT}) \times I_{CL}]$. If thermal shutdown is triggered, the device turns off. After the device cools down, the internal thermal shutdown circuit turns the device back on. If the output current fault condition continues, the device cycles between current limit and thermal shutdown. For more information on current limits, see the [Know Your Limits application note](#).

图 8-3 depicts a diagram of the current limit.



图 8-3. Current Limit

8.3.4 Undervoltage Lockout (UVLO)

The device has an independent undervoltage lockout (UVLO) circuit that monitors the input voltage, allowing a controlled and consistent turn on and off of the output voltage. To prevent the device from turning off if the input drops during turn on, the UVLO has hysteresis as specified in the *Electrical Characteristics* table.

8.3.5 Thermal Shutdown

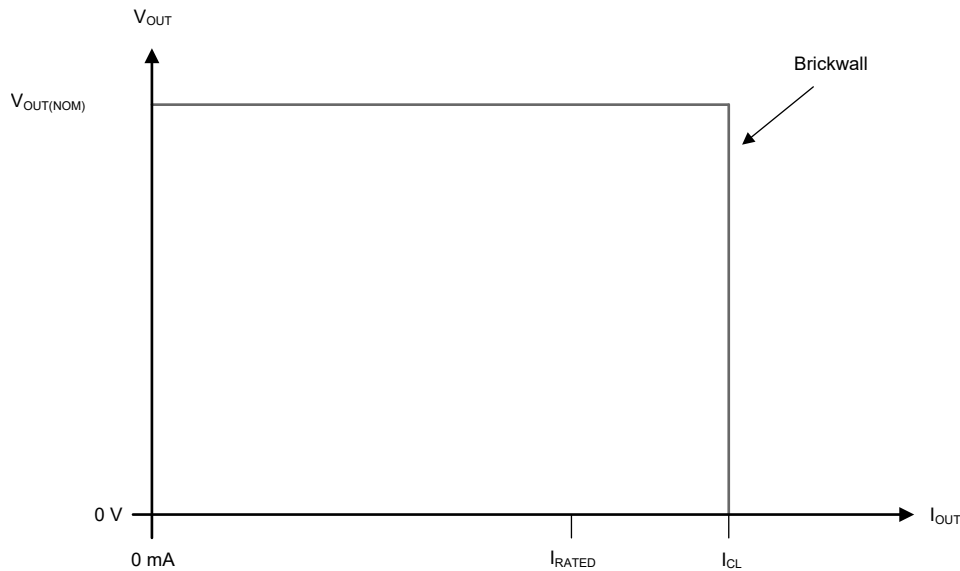
The device contains a thermal shutdown protection circuit to disable the device when the junction temperature (T_J) of the pass transistor rises to $T_{SD(shutdown)}$ (typical). Thermal shutdown hysteresis assures that the device resets (turns on) when the temperature falls to $T_{SD(reset)}$ (typical).

The thermal time-constant of the semiconductor die is fairly short, thus the device may cycle on and off when thermal shutdown is reached until power dissipation is reduced. Power dissipation during start-up can be high from large $V_{IN} - V_{OUT}$ voltage drops across the device or from high inrush currents charging large output capacitors. Under some conditions, the thermal shutdown protection disables the device before start-up completes.

When the thermal limit is triggered with the load current near the value of the current limit, the output may oscillate prior to the output switching off.

For reliable operation, limit the junction temperature to the maximum listed in the *Recommended Operating Conditions* table. Operation above this maximum temperature causes the device to exceed its operational specifications. Although the internal protection circuitry of the device is designed to protect against thermal overall conditions, this circuitry is not intended to replace proper heat sinking. Continuously running the device into thermal shutdown or above the maximum recommended junction temperature reduces long-term reliability.

8.3.6 Power Good

The power-good (PG) pin is an open-drain output and can be connected to a regulated supply through an external pullup resistor. The maximum pullup voltage is listed as V_{PG} in the *Recommended Operating Conditions* table. For the PG pin to have a valid output, the voltage on the IN pin must be greater than $V_{UVLO(RISING)}$, as listed in the *Electrical Characteristics* table. When the V_{OUT} exceeds $V_{IT(PG,RISING)}$, the PG output is high impedance and the PG pin voltage pulls up to the connected regulated supply. When the regulated output falls below $V_{IT(PG,FALLING)}$, the open-drain output turns on and pulls the PG output low after a short deglitch time. If output voltage monitoring is not needed, the PG pin can be left floating or connected to ground.

The recommended maximum PG pin sink current ($I_{PG-SINK}$) and the leakage current into the PG pin ($I_{LK(PG)}$) are listed in the *Electrical Characteristics* table.

The PG pullup voltage (V_{PG_PULLUP}), the desired minimum power-good output voltage ($V_{PG(MIN)}$), and $I_{LK(PG)}$ limit the maximum PG pin pullup resistor value (R_{PG_PULLUP}). V_{PG_PULLUP} , the PG pin low-level output voltage ($V_{OL(PG)}$), and $I_{PG-SINK}$ limit the minimum R_{PG_PULLUP} . Maximum and minimum values for R_{PG_PULLUP} can be calculated from the following equations:

$$R_{PG_PULLUP(MAX)} = (V_{PG_PULLUP} - V_{PG(MIN)}) / I_{LK(PG_MAX)} \quad (2)$$

$$R_{PG_PULLUP(MIN)} = (V_{PG_PULLUP} - V_{OL(PG)}) / I_{PG-SINK} \quad (3)$$

For example, if the PG pin is connected to a pullup resistor with a 3.3-V external supply, from [方程式 2](#), $R_{PG_PULLUP(MAX)}$ is 11 M Ω . From [方程式 3](#), $R_{PG_PULLUP(MIN)}$ is 5.8 k Ω .

8.3.7 Active Overshoot Pulldown Circuitry

This device has pulldown circuitry connected to V_{OUT} . This circuitry is a 100- μ A current sink, in series with a 5.5-k Ω resistor, controlled by V_{EN} . When V_{EN} is below $V_{EN(LOW)}$, the pulldown circuitry is disabled and the LDO output is in high-impedance mode.

If the output voltage is more than 60 mV above nominal voltage when $V_{EN} \geq V_{EN(LOW)}$, the pulldown circuitry turns on and the output is pulled down until the output voltage is within 60 mV from the nominal voltage. This feature helps reduce overshoot during the transient response.

8.4 Device Functional Modes

8.4.1 Device Functional Mode Comparison

表 8-1 shows the conditions that lead to the different modes of operation. See the *Electrical Characteristics* table for parameter values.

表 8-1. Device Functional Mode Comparison

OPERATING MODE	PARAMETER			
	V_{IN}	V_{EN}	I_{OUT}	T_J
Normal operation	$V_{IN} > V_{OUT(nom)} + V_{DO}$ and $V_{IN} > V_{IN(min)}$	$V_{EN} > V_{EN(HI)}$	$I_{OUT} < I_{OUT(max)}$	$T_J < T_{SD(shutdown)}$
Dropout operation	$V_{IN(min)} < V_{IN} < V_{OUT(nom)} + V_{DO}$	$V_{EN} > V_{EN(HI)}$	$I_{OUT} < I_{OUT(max)}$	$T_J < T_{SD(shutdown)}$
Disabled (any true condition disables the device)	$V_{IN} < V_{UVLO}$	$V_{EN} < V_{EN(LOW)}$	Not applicable	$T_J > T_{SD(shutdown)}$

8.4.2 Normal Operation

The device regulates to the nominal output voltage when the following conditions are met:

- The input voltage is greater than the nominal output voltage plus the dropout voltage ($V_{OUT(nom)} + V_{DO}$)
- The output current is less than the current limit ($I_{OUT} < I_{CL}$)
- The device junction temperature is less than the thermal shutdown temperature ($T_J < T_{SD}$)
- The enable voltage has previously exceeded the enable rising threshold voltage and has not yet decreased to less than the enable falling threshold

8.4.3 Dropout Operation

If the input voltage is lower than the nominal output voltage plus the specified dropout voltage, but all other conditions are met for normal operation, the device operates in dropout mode. In this mode, the output voltage tracks the input voltage. During this mode, the transient performance of the device becomes significantly degraded because the pass transistor is in the ohmic or triode region, and acts as a switch. Line or load transients in dropout can result in large output-voltage deviations.

When the device is in a steady dropout state (defined as when the device is in dropout, $V_{IN} < V_{OUT(NOM)} + V_{DO}$, directly after being in a normal regulation state, but *not* during start-up), the pass transistor is driven into the ohmic or triode region. When the input voltage returns to a value greater than or equal to the nominal output voltage plus the dropout voltage ($V_{OUT(NOM)} + V_{DO}$), the output voltage can overshoot for a short period of time while the device pulls the pass transistor back into the linear region.

8.4.4 Disabled

The output of the device can be shutdown by forcing the voltage of the enable pin to less than the maximum EN pin low-level input voltage (see the *Electrical Characteristics* table). When disabled, the pass transistor is turned off and internal circuits are shutdown.

Application and Implementation

备注

Information in the following applications sections is not part of the TI component specification, and TI does not warrant its accuracy or completeness. TI's customers are responsible for determining suitability of components for their purposes. Customers should validate and test their design implementation to confirm system functionality.

9.1 Application Information

9.1.1 Adjustable Device Feedback Resistors

The adjustable-version device requires external feedback divider resistors to set the output voltage. V_{OUT} is set using the feedback divider resistors, R_1 and R_2 , according to the following equation:

$$V_{OUT} = V_{FB} \times (1 + R_1 / R_2) \quad (4)$$

To ignore the FB pin current error term in the V_{OUT} equation, set the feedback divider current to 100 times the FB pin current listed in the *Electrical Characteristics* table. This setting provides the maximum feedback divider series resistance, as shown in the following equation:

$$R_1 + R_2 \leq V_{OUT} / (I_{FB} \times 100) \quad (5)$$

9.1.2 Recommended Capacitor Types

The device is designed to be stable using low equivalent series resistance (ESR) capacitors at the input and output. Multilayer ceramic capacitors have become the industry standard for these types of applications and are recommended, but must be used with good judgment. Ceramic capacitors that employ X7R-, X5R-, and C0G-rated dielectric materials provide relatively good capacitive stability across temperature, whereas the use of Y5V-rated capacitors is discouraged because of large variations in capacitance.

Regardless of the ceramic capacitor type selected, the effective capacitance varies with operating voltage and temperature. As a rule of thumb, expect the effective capacitance to decrease by as much as 50%. The input and output capacitors recommended in the *Recommended Operating Conditions* table account for an effective capacitance of approximately 50% of the nominal value.

9.1.3 Input and Output Capacitor Requirements

Although an input capacitor is not required for stability, good analog design practice is to connect a capacitor from IN to GND. This capacitor counteracts reactive input sources and improves transient response, input ripple, and PSRR. An input capacitor is recommended if the source impedance is more than 0.5Ω . A higher value capacitor may be necessary if large, fast transient load or line transients are anticipated or if the device is located several inches from the input power source.

Dynamic performance of the device is improved with the use of an output capacitor. Use an output capacitor within the range specified in the *Recommended Operating Conditions* table for stability.

The effective output capacitance is recommended to not exceed $50 \mu\text{F}$.

9.1.4 Reverse Current

Excessive reverse current can damage this device. Reverse current flows through the intrinsic body diode of the pass transistor instead of the normal conducting channel. At high magnitudes, this current flow degrades the long-term reliability of the device.

Conditions where reverse current can occur are outlined in this section, all of which can exceed the absolute maximum rating of $V_{OUT} \leq V_{IN} + 0.3 \text{ V}$.

- If the device has a large C_{OUT} and the input supply collapses with little or no load current
- The output is biased when the input supply is not established

- The output is biased above the input supply

If reverse current flow is expected in the application, external protection is recommended to protect the device. Reverse current is not limited in the device, so external limiting is required if extended reverse voltage operation is anticipated.

图 9-1 shows one approach for protecting the device.



图 9-1. Example Circuit for Reverse Current Protection Using a Schottky Diode

图 9-2 shows another, more commonly used, approach in high input voltage applications.

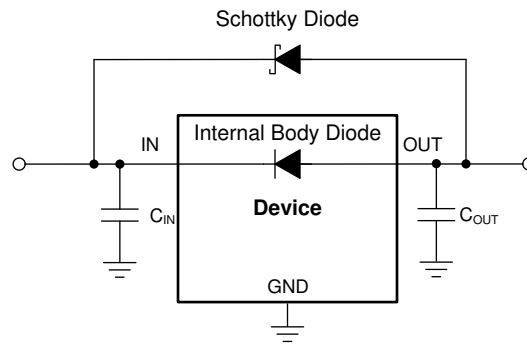

图 9-2. Reverse Current Prevention Using A Diode Before the LDO

9.1.5 Feed-Forward Capacitor (C_{FF})

For the adjustable-voltage version device, a feed-forward capacitor (C_{FF}) can be connected from the OUT pin to the FB pin. C_{FF} improves transient, noise, and PSRR performance, but is not required for regulator stability. Common C_{FF} value choices range between 10 nF and 100 nF. A higher capacitance C_{FF} can be used; however, the start-up time increases. For a detailed description of C_{FF} tradeoffs, see the [Pros and Cons of Using a Feedforward Capacitor with a Low-Dropout Regulator application note](#).

9.1.6 Power Dissipation (P_D)

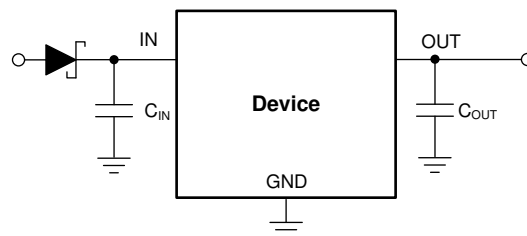
Circuit reliability requires consideration of the device power dissipation, location of the circuit on the printed circuit board (PCB), and correct sizing of the thermal plane. The PCB area around the regulator must have few or no other heat-generating devices that cause added thermal stress.

To first-order approximation, power dissipation in the regulator depends on the input-to-output voltage difference and load conditions. The following equation calculates power dissipation (P_D).

$$P_D = (V_{IN} - V_{OUT}) \times I_{OUT} \quad (6)$$

备注

Power dissipation can be minimized, and therefore greater efficiency can be achieved, by correct selection of the system voltage rails. For the lowest power dissipation use the minimum input voltage required for correct output regulation.

For devices with a thermal pad, the primary heat conduction path for the device package is through the thermal pad to the PCB. Solder the thermal pad to a copper pad area under the device. This pad area must contain an array of plated vias that conduct heat to additional copper planes for increased heat dissipation.

The maximum power dissipation determines the maximum allowable ambient temperature (T_A) for the device. According to the following equation, power dissipation and junction temperature are most often related by the junction-to-ambient thermal resistance ($R_{\theta JA}$) of the combined PCB and device package and the temperature of the ambient air (T_A).

$$T_J = T_A + (R_{\theta JA} \times P_D) \quad (7)$$

Thermal resistance ($R_{\theta JA}$) is highly dependent on the heat-spreading capability built into the particular PCB design, and therefore varies according to the total copper area, copper weight, and location of the planes. The junction-to-ambient thermal resistance listed in the *Thermal Information* table is determined by the JEDEC standard PCB and copper-spreading area, and is used as a relative measure of package thermal performance.

9.1.7 Estimating Junction Temperature

The JEDEC standard now recommends the use of psi (Ψ) thermal metrics to estimate the junction temperatures of the linear regulator when in-circuit on a typical PCB board application. These metrics are not thermal resistance parameters and instead offer a practical and relative way to estimate junction temperature. These psi metrics are determined to be significantly independent of the copper area available for heat-spreading. The *Thermal Information* table lists the primary thermal metrics, which are the junction-to-top characterization parameter (ψ_{JT}) and junction-to-board characterization parameter (ψ_{JB}). These parameters provide two methods for calculating the junction temperature (T_J), as described in the following equations. Use the junction-to-top characterization parameter (ψ_{JT}) with the temperature at the center-top of device package (T_T) to calculate the junction temperature. Use the junction-to-board characterization parameter (ψ_{JB}) with the PCB surface temperature 1 mm from the device package (T_B) to calculate the junction temperature.

$$T_J = T_T + \psi_{JT} \times P_D \quad (8)$$

where:

- P_D is the dissipated power
- T_T is the temperature at the center-top of the device package

$$T_J = T_B + \psi_{JB} \times P_D \quad (9)$$

where:

- T_B is the PCB surface temperature measured 1 mm from the device package and centered on the package edge

For detailed information on the thermal metrics and how to use them, see the [Semiconductor and IC Package Thermal Metrics application note](#).

9.1.8 Special Consideration for Line Transients

During a line transient, the response of this LDO to a very large or fast input voltage change can cause a brief shutdown lasting up to a few hundred microseconds from the voltage transition. This shutdown can be avoided by reducing the voltage step size, increasing the transition time, or a combination of both. 图 9-3 provides a boundary to follow to avoid this behavior. If necessary, reduce slew rate and the voltage step size to stay below the curve.



图 9-3. Recommended Input Voltage Step and Slew Rate in a Line transient

9.2 Typical Application

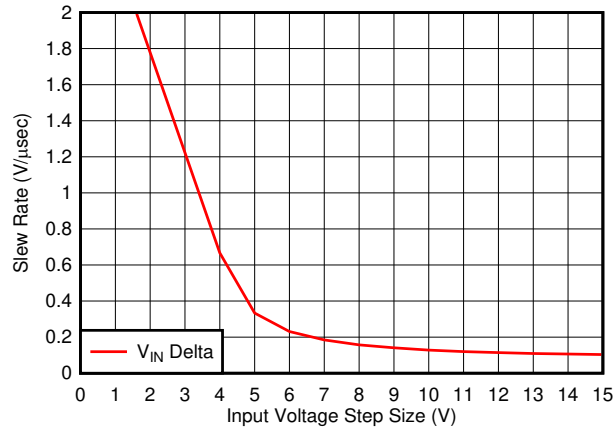

图 9-4. Generating a 5-V Rail From a Multicell Power Bank

9.2.1 Design Requirements

表 9-1 summarizes the design requirements for 图 9-4.

表 9-1. Design Parameters

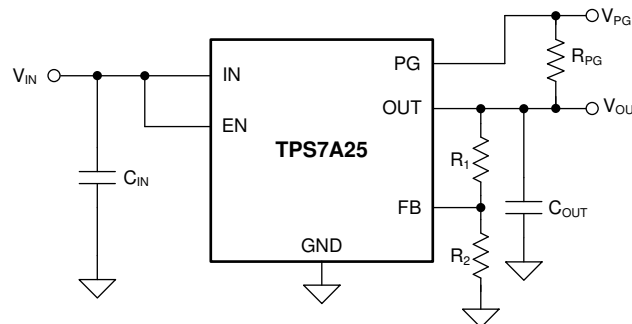
PARAMETER	DESIGN VALUES
V_{IN}	8.4 V
V_{OUT}	5 V \pm 1%
$I_{(IN)}$ (no load)	< 5 μ A
I_{OUT} (max)	220 mA
T_A	70°C (max)

9.2.2 Detailed Design Procedure

Select a 5-V output, fixed or adjustable device to generate the 5-V rail. The fixed-version LDO has internal feedback divider resistors and thus has lower effective quiescent current. The adjustable-version LDO requires external feedback divider resistors, and resistor selection is described in the [Selecting Feedback Divider Resistors](#) section.

9.2.2.1 Transient Response

As with any regulator, increasing the output capacitor value reduces over- and undershoot magnitude, but increases transient response duration.

9.2.2.2 Selecting Feedback Divider Resistors

For this design example, V_{OUT} is set to 5 V. The following equations set the feedback divider resistors for the desired output voltage:

$$V_{OUT} = V_{FB} \times (1 + R_1 / R_2) \quad (10)$$

$$R_1 + R_2 \leq V_{OUT} / (I_{FB} \times 100) \quad (11)$$

For improved output accuracy, use [方程式 11](#) and $I_{FB(TYP)} = 10$ nA as listed in the *Electrical Characteristics* table to calculate the upper limit for series feedback resistance, $R_1 + R_2 \leq 5$ M Ω .

The control-loop error amplifier drives the FB pin to the same voltage as the internal reference ($V_{FB} = 1.24$ V as listed in the *Electrical Characteristics* table). Use [方程式 10](#) to determine the ratio of $R_1 / R_2 = 3.03$. Use this ratio and solve [方程式 11](#) for R_2 . Now calculate the upper limit for $R_2 \leq 1.24$ M Ω . Select a standard resistor value for $R_2 = 1.18$ M Ω .

Reference [方程式 10](#) and solve for R_1 :

$$R_1 = (V_{OUT} / V_{FB} - 1) \times R_2 \quad (12)$$

From [方程式 12](#), $R_1 = 3.64$ M Ω can be determined. Select a standard resistor value for $R_1 = 3.6$ M Ω . From [方程式 10](#), $V_{OUT} = 5.023$ V.

9.2.2.3 Thermal Dissipation

Junction temperature can be determined using the junction-to-ambient thermal resistance ($R_{\theta JA}$) and the total power dissipation (P_D). Use [方程式 13](#) to calculate the power dissipation. Multiply P_D by $R_{\theta JA}$ and add the ambient temperature (T_A), as [方程式 14](#) shows, to calculate the junction temperature (T_J).

$$P_D = (I_{GND} + I_{OUT}) \times (V_{IN} - V_{OUT}) \quad (13)$$

$$T_J = R_{\theta JA} \times P_D + T_A \quad (14)$$

[方程式 15](#) calculates the maximum ambient temperature. [方程式 16](#) calculates the maximum ambient temperature for this application.

$$T_{A(MAX)} = T_{J(MAX)} - (R_{\theta JA} \times P_D) \quad (15)$$

$$T_{A(MAX)} = 125^\circ\text{C} - [73.3^\circ\text{C/W} \times (8.4\text{ V} - 5\text{ V}) \times 0.22\text{ A}] = 70.2^\circ\text{C} \quad (16)$$

9.2.3 Application Curve

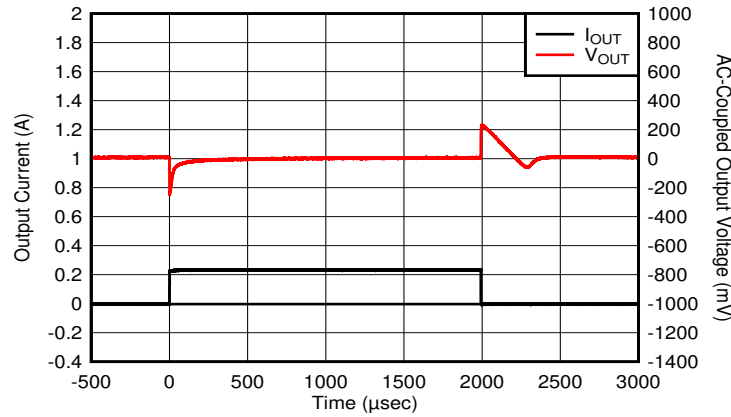

$I_{OUT} = 1 \text{ mA to } 0.22 \text{ A}$, slew rate = $0.5 \text{ A}/\mu\text{s}$, $V_{OUT} = 5 \text{ V}$, $V_{IN} = 8.4 \text{ V}$, $C_{IN} = 1 \mu\text{F}$, $C_{OUT} = 1 \mu\text{F}$, $C_{FF} = 0 \mu\text{F}$

图 9-5. TPS7A25 Load Transient (1 mA to 220 mA)

9.3 Power Supply Recommendations

The device is designed to operate from an input supply voltage range of 2.4 V to 18 V. To ensure that the output voltage is well regulated and dynamic performance is optimum, the input supply must be at least $V_{OUT(nom)} + 0.5 \text{ V}$. Connect a low output impedance power supply directly to the input pin of the TPS7A25.

9.4 Layout

9.4.1 Layout Guidelines

- Place input and output capacitors as close to the device pins as possible
- Use copper planes for device connections to optimize thermal performance
- Place thermal vias around the device and under the DRV thermal pad to distribute heat

9.4.2 Layout Examples



图 9-6. Adjustable Version Layout Example



图 9-7. Fixed Version Layout Example

9 Device and Documentation Support

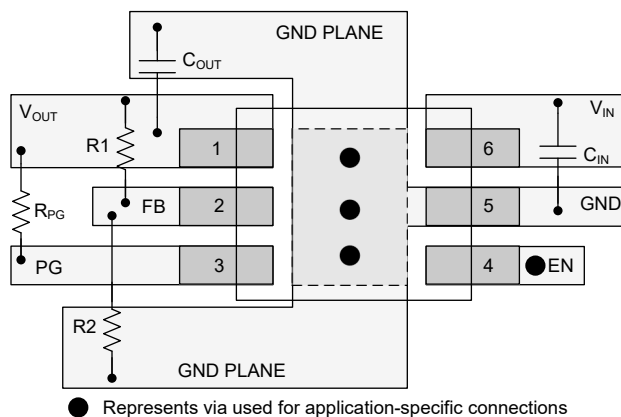
9.1 Device Support

9.1.1 Device Nomenclature

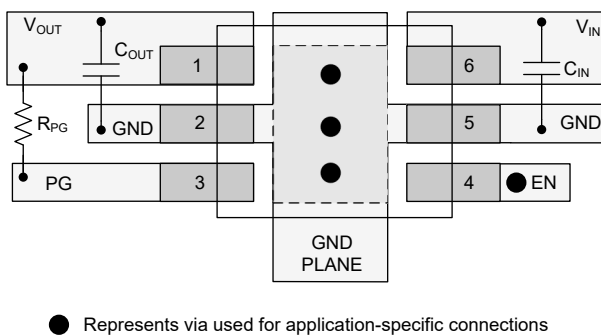
表 9-1. Device Nomenclature⁽¹⁾

PRODUCT	V_{OUT}
TPS7A25xx(x)yyyz	<p>xx(x) is the nominal output voltage. For output voltages with a resolution of 100 mV, two digits are used in the ordering number; for output voltages with a resolution of 50 mV, three digits are used (for example, 28 = 2.8 V; 125 = 1.25 V). 01 indicates adjustable output version.</p> <p>yyy is the package designator.</p> <p>z is the package quantity. R is for large quantity reel, T is for small quantity reel.</p>

(1) For the most current package and ordering information see the Package Option Addendum at the end of this document, or visit the device product folder at www.ti.com.

9.2 Documentation Support

9.2.1 Related Documentation

For related documentation see the following:

Texas Instruments, [TPS7A26 500-mA, 18-V, Ultra-Low \$I_Q\$, Low Dropout Linear Voltage Regulator With Power-Good data sheet](#)

9.3 接收文档更新通知

要接收文档更新通知，请导航至 ti.com 上的器件产品文件夹。点击 [订阅更新](#) 进行注册，即可每周接收产品信息更改摘要。有关更改的详细信息，请查看任何已修订文档中包含的修订历史记录。

9.4 支持资源

[TI E2E™ 支持论坛](#) 是工程师的重要参考资料，可直接从专家获得快速、经过验证的解答和设计帮助。搜索现有解答或提出自己的问题可获得所需的快速设计帮助。

链接的内容由各个贡献者“按原样”提供。这些内容并不构成 TI 技术规范，并且不一定反映 TI 的观点；请参阅 TI 的《[使用条款](#)》。

9.5 Trademarks

TI E2E™ is a trademark of Texas Instruments.

所有商标均为其各自所有者的财产。

9.6 Electrostatic Discharge Caution



This integrated circuit can be damaged by ESD. Texas Instruments recommends that all integrated circuits be handled with appropriate precautions. Failure to observe proper handling and installation procedures can cause damage.

ESD damage can range from subtle performance degradation to complete device failure. Precision integrated circuits may be more susceptible to damage because very small parametric changes could cause the device not to meet its published specifications.

9.7 术语表

[TI 术语表](#) 本术语表列出并解释了术语、首字母缩略词和定义。

10 Mechanical, Packaging, and Orderable Information

The following pages include mechanical, packaging, and orderable information. This information is the most current data available for the designated devices. This data is subject to change without notice and revision of this document. For browser-based versions of this data sheet, refer to the left-hand navigation.

10.1 Mechanical Data

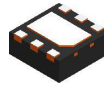

DRV0006A

PACKAGE OUTLINE

WSON - 0.8 mm max height

PLASTIC SMALL OUTLINE - NO LEAD

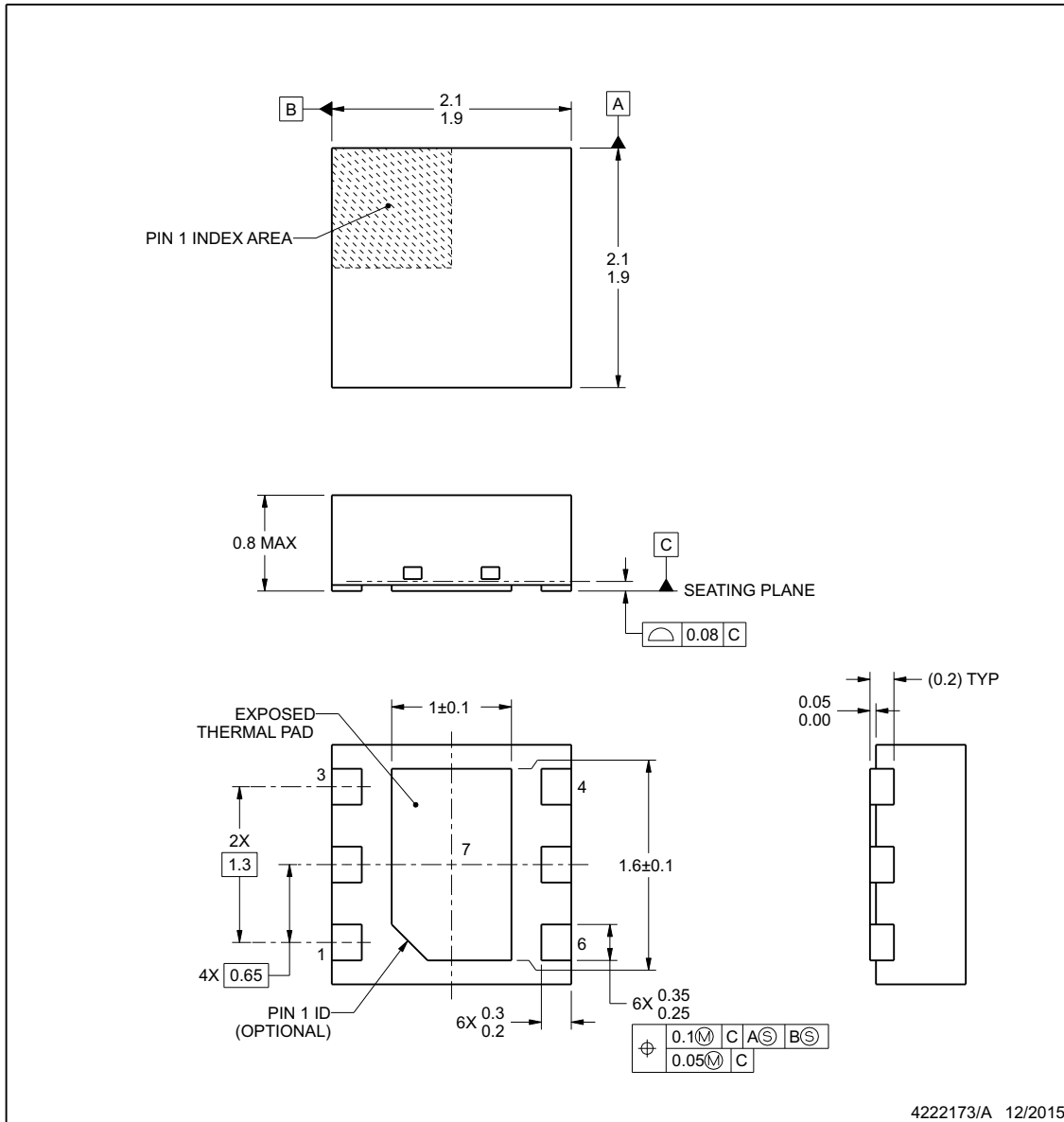

NOTES:

1. All linear dimensions are in millimeters. Any dimensions in parenthesis are for reference only. Dimensioning and tolerancing per ASME Y14.5M.
2. This drawing is subject to change without notice.
3. The package thermal pad must be soldered to the printed circuit board for thermal and mechanical performance.

EXAMPLE BOARD LAYOUT

DRV0006A

WSN - 0.8 mm max height

PLASTIC SMALL OUTLINE - NO LEAD

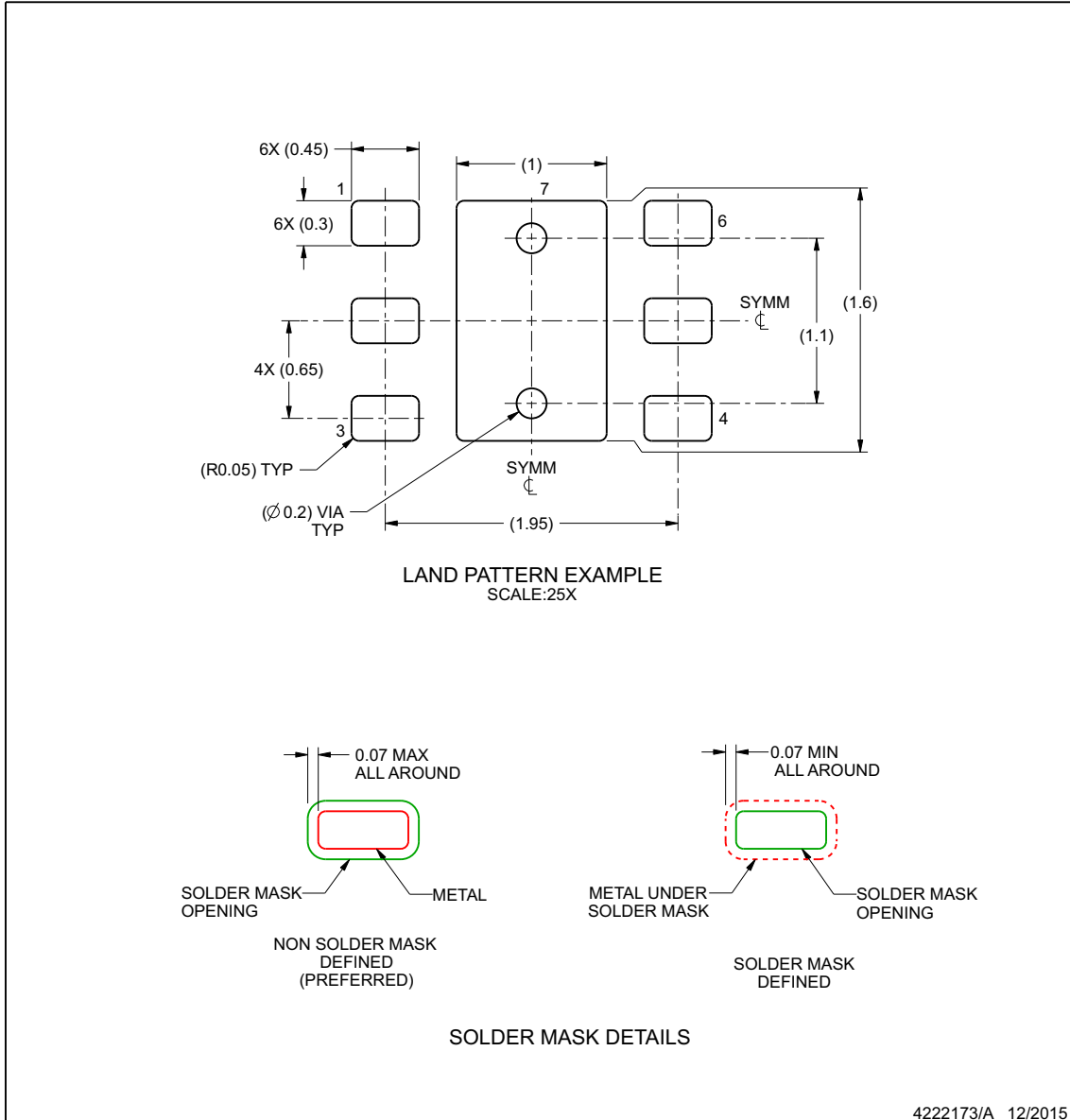

NOTES: (continued)

- This package is designed to be soldered to a thermal pad on the board. For more information, see Texas Instruments literature number SLUA271 (www.ti.com/lit/slua271).
- Vias are optional depending on application, refer to device data sheet. If some or all are implemented, recommended via locations are shown.

EXAMPLE STENCIL DESIGN

DRV0006A

WSON - 0.8 mm max height

PLASTIC SMALL OUTLINE - NO LEAD

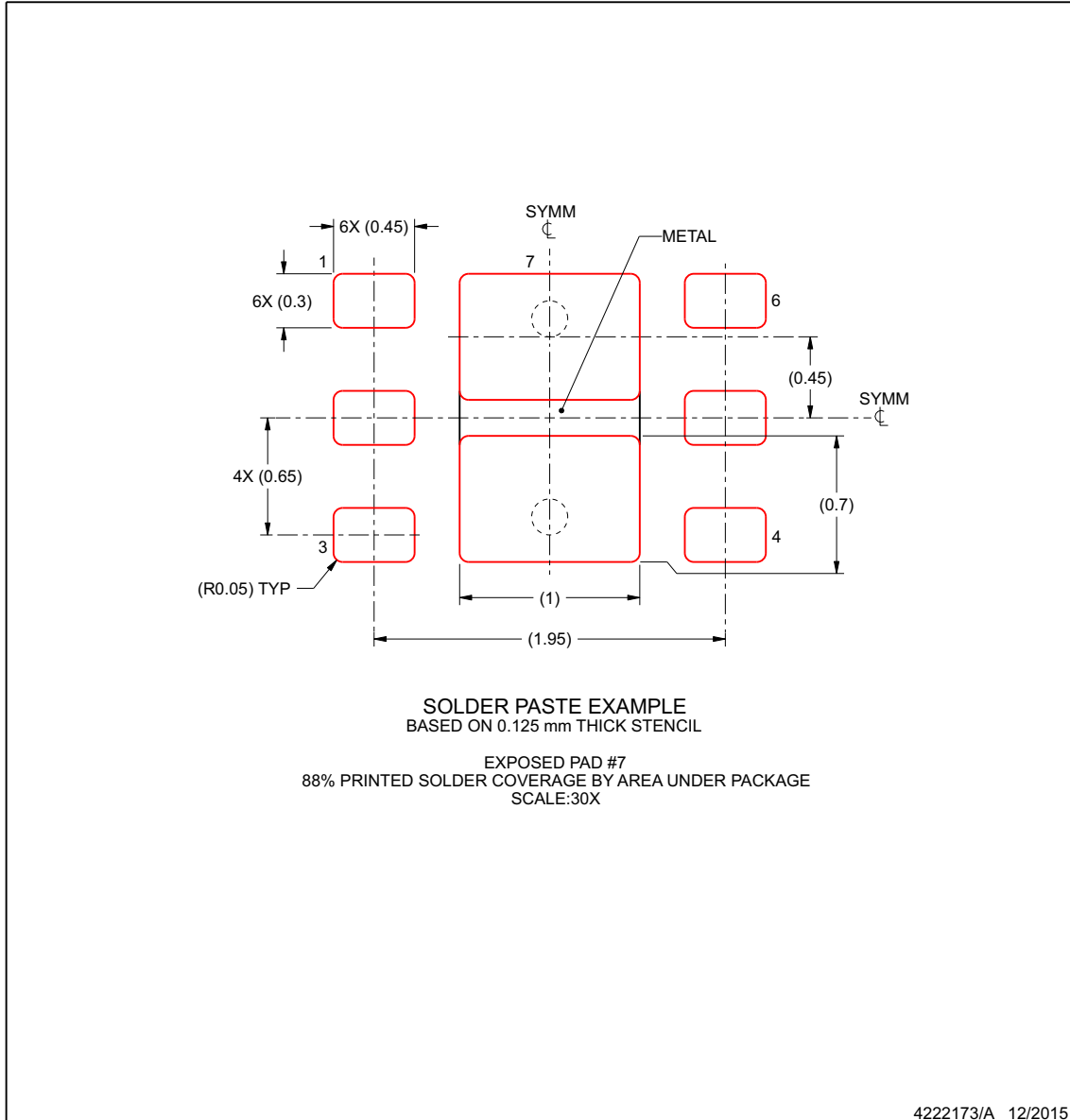

NOTES: (continued)

6. Laser cutting apertures with trapezoidal walls and rounded corners may offer better paste release. IPC-7525 may have alternate design recommendations.

PACKAGING INFORMATION

Orderable Device	Status (1)	Package Type	Package Drawing	Pins	Package Qty	Eco Plan (2)	Lead finish/ Ball material (6)	MSL Peak Temp (3)	Op Temp (°C)	Device Marking (4/5)	Samples
TPS7A2501DRVR	ACTIVE	WSON	DRV	6	3000	RoHS & Green	NIPDAU	Level-1-260C-UNLIM	-40 to 125	7A25	Samples
TPS7A2501DRVT	ACTIVE	WSON	DRV	6	250	RoHS & Green	NIPDAU	Level-1-260C-UNLIM	-40 to 125	7A25	Samples
TPS7A25125DRVR	ACTIVE	WSON	DRV	6	3000	RoHS & Green	NIPDAU	Level-1-260C-UNLIM	-40 to 125	1XCP	Samples
TPS7A2518DRVR	ACTIVE	WSON	DRV	6	3000	RoHS & Green	NIPDAU	Level-1-260C-UNLIM	-40 to 125	1XBP	Samples
TPS7A2525DRVR	ACTIVE	WSON	DRV	6	3000	RoHS & Green	NIPDAU	Level-1-260C-UNLIM	-40 to 125	1XAP	Samples
TPS7A2533DRVR	ACTIVE	WSON	DRV	6	3000	RoHS & Green	NIPDAU	Level-1-260C-UNLIM	-40 to 125	1WSP	Samples
TPS7A2550DRVR	ACTIVE	WSON	DRV	6	3000	RoHS & Green	NIPDAU	Level-1-260C-UNLIM	-40 to 125	1WQP	Samples

(1) The marketing status values are defined as follows:

ACTIVE: Product device recommended for new designs.

LIFEBUY: TI has announced that the device will be discontinued, and a lifetime-buy period is in effect.

NRND: Not recommended for new designs. Device is in production to support existing customers, but TI does not recommend using this part in a new design.

PREVIEW: Device has been announced but is not in production. Samples may or may not be available.

OBSOLETE: TI has discontinued the production of the device.

(2) **RoHS:** TI defines "RoHS" to mean semiconductor products that are compliant with the current EU RoHS requirements for all 10 RoHS substances, including the requirement that RoHS substance do not exceed 0.1% by weight in homogeneous materials. Where designed to be soldered at high temperatures, "RoHS" products are suitable for use in specified lead-free processes. TI may reference these types of products as "Pb-Free".

RoHS Exempt: TI defines "RoHS Exempt" to mean products that contain lead but are compliant with EU RoHS pursuant to a specific EU RoHS exemption.

Green: TI defines "Green" to mean the content of Chlorine (Cl) and Bromine (Br) based flame retardants meet JS709B low halogen requirements of <=1000ppm threshold. Antimony trioxide based flame retardants must also meet the <=1000ppm threshold requirement.

(3) MSL, Peak Temp. - The Moisture Sensitivity Level rating according to the JEDEC industry standard classifications, and peak solder temperature.

(4) There may be additional marking, which relates to the logo, the lot trace code information, or the environmental category on the device.

(5) Multiple Device Markings will be inside parentheses. Only one Device Marking contained in parentheses and separated by a "~" will appear on a device. If a line is indented then it is a continuation of the previous line and the two combined represent the entire Device Marking for that device.

⁽⁶⁾ Lead finish/Ball material - Orderable Devices may have multiple material finish options. Finish options are separated by a vertical ruled line. Lead finish/Ball material values may wrap to two lines if the finish value exceeds the maximum column width.

Important Information and Disclaimer:The information provided on this page represents TI's knowledge and belief as of the date that it is provided. TI bases its knowledge and belief on information provided by third parties, and makes no representation or warranty as to the accuracy of such information. Efforts are underway to better integrate information from third parties. TI has taken and continues to take reasonable steps to provide representative and accurate information but may not have conducted destructive testing or chemical analysis on incoming materials and chemicals. TI and TI suppliers consider certain information to be proprietary, and thus CAS numbers and other limited information may not be available for release.

In no event shall TI's liability arising out of such information exceed the total purchase price of the TI part(s) at issue in this document sold by TI to Customer on an annual basis.

TAPE AND REEL INFORMATION

QUADRANT ASSIGNMENTS FOR PIN 1 ORIENTATION IN TAPE

*All dimensions are nominal

Device	Package Type	Package Drawing	Pins	SPQ	Reel Diameter (mm)	Reel Width W1 (mm)	A0 (mm)	B0 (mm)	K0 (mm)	P1 (mm)	W (mm)	Pin1 Quadrant
TPS7A2501DRVR	WSO	DRV	6	3000	178.0	8.4	2.25	2.25	1.0	4.0	8.0	Q2
TPS7A2501DRVT	WSO	DRV	6	250	178.0	8.4	2.25	2.25	1.0	4.0	8.0	Q2
TPS7A25125DRVR	WSO	DRV	6	3000	178.0	8.4	2.25	2.25	1.0	4.0	8.0	Q2
TPS7A2518DRVR	WSO	DRV	6	3000	178.0	8.4	2.25	2.25	1.0	4.0	8.0	Q2
TPS7A2525DRVR	WSO	DRV	6	3000	178.0	8.4	2.25	2.25	1.0	4.0	8.0	Q2
TPS7A2533DRVR	WSO	DRV	6	3000	178.0	8.4	2.25	2.25	1.0	4.0	8.0	Q2
TPS7A2550DRVR	WSO	DRV	6	3000	178.0	8.4	2.25	2.25	1.0	4.0	8.0	Q2

TAPE AND REEL BOX DIMENSIONS

*All dimensions are nominal

Device	Package Type	Package Drawing	Pins	SPQ	Length (mm)	Width (mm)	Height (mm)
TPS7A2501DRVR	WSON	DRV	6	3000	205.0	200.0	33.0
TPS7A2501DRVT	WSON	DRV	6	250	205.0	200.0	33.0
TPS7A25125DRVR	WSON	DRV	6	3000	205.0	200.0	33.0
TPS7A2518DRVR	WSON	DRV	6	3000	205.0	200.0	33.0
TPS7A2525DRVR	WSON	DRV	6	3000	205.0	200.0	33.0
TPS7A2533DRVR	WSON	DRV	6	3000	205.0	200.0	33.0
TPS7A2550DRVR	WSON	DRV	6	3000	205.0	200.0	33.0

GENERIC PACKAGE VIEW

DRV 6

WSO - 0.8 mm max height

PLASTIC SMALL OUTLINE - NO LEAD



Images above are just a representation of the package family, actual package may vary.
Refer to the product data sheet for package details.

4206925/F



4222173/B 04/2018

NOTES:

1. All linear dimensions are in millimeters. Any dimensions in parenthesis are for reference only. Dimensioning and tolerancing per ASME Y14.5M.
2. This drawing is subject to change without notice.
3. The package thermal pad must be soldered to the printed circuit board for thermal and mechanical performance.

EXAMPLE STENCIL DESIGN

DRV0006A

WSON - 0.8 mm max height

PLASTIC SMALL OUTLINE - NO LEAD



SOLDER PASTE EXAMPLE
BASED ON 0.125 mm THICK STENCIL

EXPOSED PAD #7
88% PRINTED SOLDER COVERAGE BY AREA UNDER PACKAGE
SCALE:30X

4222173/B 04/2018

NOTES: (continued)

6. Laser cutting apertures with trapezoidal walls and rounded corners may offer better paste release. IPC-7525 may have alternate design recommendations.

重要声明和免责声明

TI“按原样”提供技术和可靠性数据（包括数据表）、设计资源（包括参考设计）、应用或其他设计建议、网络工具、安全信息和其他资源，不保证没有瑕疵且不做任何明示或暗示的担保，包括但不限于对适销性、某特定用途方面的适用性或不侵犯任何第三方知识产权的暗示担保。

这些资源可供使用 TI 产品进行设计的熟练开发人员使用。您将自行承担以下全部责任：(1) 针对您的应用选择合适的 TI 产品，(2) 设计、验证并测试您的应用，(3) 确保您的应用满足相应标准以及任何其他功能安全、信息安全、监管或其他要求。

这些资源如有变更，恕不另行通知。TI 授权您仅可将这些资源用于研发本资源所述的 TI 产品的应用。严禁对这些资源进行其他复制或展示。您无权使用任何其他 TI 知识产权或任何第三方知识产权。您应全额赔偿因在这些资源的使用中对 TI 及其代表造成的任何索赔、损害、成本、损失和债务，TI 对此概不负责。

TI 提供的产品受 [TI 的销售条款](#) 或 [ti.com](#) 上其他适用条款/TI 产品随附的其他适用条款的约束。TI 提供这些资源并不会扩展或以其他方式更改 TI 针对 TI 产品发布的适用的担保或担保免责声明。

TI 反对并拒绝您可能提出的任何其他或不同的条款。

邮寄地址：Texas Instruments, Post Office Box 655303, Dallas, Texas 75265

Copyright © 2022，德州仪器 (TI) 公司