



## SN74LVC2G08 Dual 2-Input Positive-AND Gate

### 1 Features

- Available in the Texas Instruments NanoStar™ and NanoFree™ Package
- Supports 5-V  $V_{CC}$  Operation
- Inputs Accept Voltages to 5.5 V
- Max  $t_{pd}$  of 4.7 ns at 3.3 V
- Low Power Consumption, 10- $\mu$ A Maximum  $I_{CC}$
- $\pm$ 24-mA Output Drive at 3.3 V
- Typical  $V_{OLP}$  (Output Ground Bounce)  $<0.8$  V at  $V_{CC} = 3.3$  V,  $T_A = 25^\circ\text{C}$
- Typical  $V_{OHV}$  (Output  $V_{OH}$  Undershoot)  $>2$  V at  $V_{CC} = 3.3$  V,  $T_A = 25^\circ\text{C}$
- $I_{off}$  Supports Live Insertion, Partial-Power-Down Mode, and Back-Drive Protection
- Can Be Used as a Down Translator to Translate Inputs From a Maximum of 5.5 V Down to the  $V_{CC}$  Level
- Latch-Up Performance Exceeds 100 mA Per JESD 78, Class II
- ESD Protection Exceeds JESD 22
  - 2000-V Human Body Model (A114-A)
  - 1000-V Charged-Device Model (C101)

### 2 Applications

- IP Phones: Wired and Wireless
- Optical Networking: EPON and Video Over Fiber
- Point-to-Point Microwave Backhaul
- Power: Telecom DC/DC Module: Analog
- Power: Telecom DC/DC Module: Digital
- Private Branch Exchange (PBX)
- Telecom Shelter: Power Distribution Unit (PDU)
- Vector Signal Analyzers and Generators
- Wireless Communications Testers
- Wireless Repeaters
- xDSL Modem/DSLAM

### 3 Description

This dual 2-input positive-AND gate is designed for 1.65-V to 5.5-V  $V_{CC}$  operation.

The SN74LVC2G08 device performs the Boolean function  $Y = A \times B$  or  $Y = \overline{A + B}$  in positive logic.

NanoFree package technology is a major breakthrough in IC packaging concepts, using the die as the package.

This device is fully specified for partial-power-down applications using  $I_{off}$ . The  $I_{off}$  circuitry disables the outputs, preventing damaging current backflow through the device when it is powered down.

#### Device Information<sup>(1)</sup>

PART NUMBER	PACKAGE	BODY SIZE (NOM)
SN74LVC2G08DCT	SM8 (8)	2.95 mm x 2.80 mm
SN74LVC2G08DCU	VSSOP (8)	2.30 mm x 2.00 mm
SN74LVC2G08YZP	DSBGA (8)	1.91 mm x 0.91 mm

(1) For all available packages, see the orderable addendum at the end of the data sheet.

#### Logic Diagram (Positive Logic)

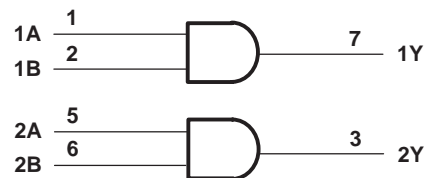

## Table of Contents

<b>1 Features</b> ..... 1 <b>2 Applications</b> ..... 1 <b>3 Description</b> ..... 1 <b>4 Revision History</b> ..... 2 <b>5 Pin Configuration and Functions</b> ..... 3 <b>6 Specifications</b> ..... 4 6.1 Absolute Maximum Ratings ..... 4 6.2 ESD Ratings ..... 4 6.3 Recommended Operating Conditions ..... 5 6.4 Thermal Information ..... 5 6.5 Electrical Characteristics ..... 6 6.6 Switching Characteristics ..... 6 6.7 Typical Characteristics ..... 7 <b>7 Parameter Measurement Information</b> ..... 8 <b>8 Detailed Description</b> ..... 9 8.1 Overview ..... 9	8.2 Functional Block Diagram ..... 9 8.3 Feature Description ..... 9 8.4 Device Functional Modes ..... 9 <b>9 Application and Implementation</b> ..... 10 9.1 Application Information ..... 10 9.2 Typical Application ..... 10 <b>10 Power Supply Recommendations</b> ..... 11 <b>11 Layout</b> ..... 11 11.1 Layout Guidelines ..... 11 11.2 Layout Example ..... 11 <b>12 Device and Documentation Support</b> ..... 12 12.1 Community Resources ..... 12 12.2 Trademarks ..... 12 12.3 Electrostatic Discharge Caution ..... 12 12.4 Glossary ..... 12 <b>13 Mechanical, Packaging, and Orderable Information</b> ..... 12
---	---

## 4 Revision History

NOTE: Page numbers for previous revisions may differ from page numbers in the current version.

<b>Changes from Revision M (April 2014) to Revision N</b>	<b>Page</b>
<ul style="list-style-type: none"> <li>• Added <i>Pin Configuration and Functions</i> section, <i>ESD Ratings</i> and <i>Thermal Information</i> tables, <i>Feature Description</i> section, <i>Device Functional Modes</i> section, <i>Application and Implementation</i> section, <i>Power Supply Recommendations</i> section, <i>Layout</i> section, <i>Device and Documentation Support</i> section, and <i>Mechanical, Packaging, and Orderable Information</i> section</li> </ul>	1

## 5 Pin Configuration and Functions

**DCT Package  
8-Pin SM8  
Top View**

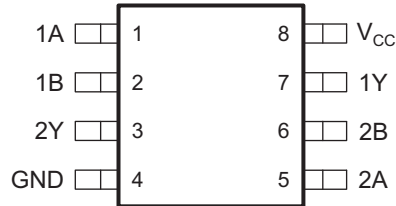

**DCU Package  
8-Pin VSSOP  
Top View**

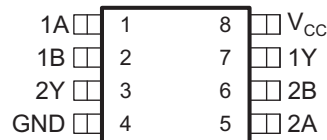

**YZP Package  
8-Pin DSBGA  
Bottom View**



### Pin Functions<sup>(1)</sup>

PIN		I/O	DESCRIPTION
NAME	NO.		
1A	1	I	Channel 1 logic input
1B	2	I	Channel 1 logic input
1Y	7	O	Logic level output
2A	5	I	Channel 2 logic input
2B	6	I	Channel 2 logic input
2Y	3	O	Logic level output
GND	4	—	Ground
V <sub>CC</sub>	8	—	Power Supply

(1) See [Mechanical, Packaging, and Orderable Information](#) for dimensions.

## 6 Specifications

### 6.1 Absolute Maximum Ratings

over operating free-air temperature range (unless otherwise noted)<sup>(1)</sup>

		MIN	MAX	UNIT
V <sub>CC</sub>	Supply voltage	-0.5	6.5	V
V <sub>I</sub>	Input voltage <sup>(2)</sup>	-0.5	6.5	V
V <sub>O</sub>	Voltage applied to any output in the high-impedance or power-off state <sup>(2)</sup>	-0.5	6.5	V
V <sub>O</sub>	Voltage applied to any output in the high or low state <sup>(2)(3)</sup>	-0.5	V <sub>CC</sub> + 0.5	V
I <sub>IK</sub>	Input clamp current	V <sub>I</sub> < 0		mA
I <sub>OK</sub>	Output clamp current	V <sub>O</sub> < 0		mA
I <sub>O</sub>	Continuous output current			±50 mA
	Continuous current through V <sub>CC</sub> or GND			±100 mA
T <sub>J</sub>	Junction temperature			150 °C
T <sub>stg</sub>	Storage temperature	-65	150	°C

- (1) Stresses beyond those listed under *Absolute Maximum Ratings* may cause permanent damage to the device. These are stress ratings only, and functional operation of the device at these or any other conditions beyond those indicated under *Recommended Operating Conditions* is not implied. Exposure to absolute-maximum-rated conditions for extended periods may affect device reliability.
- (2) The input negative-voltage and output voltage ratings may be exceeded if the input and output current ratings are observed.
- (3) The value of V<sub>CC</sub> is provided in the *Recommended Operating Conditions* table.

### 6.2 ESD Ratings

		VALUE	UNIT
V <sub>(ESD)</sub>	Electrostatic discharge	Human body model (HBM), per ANSI/ESDA/JEDEC JS-001 <sup>(1)</sup>	±2000
		Charged-device model (CDM), per JEDEC specification JESD22-C101 <sup>(2)</sup>	±1000

- (1) JEDEC document JEP155 states that 500-V HBM allows safe manufacturing with a standard ESD control process.
- (2) JEDEC document JEP157 states that 250-V CDM allows safe manufacturing with a standard ESD control process.

### 6.3 Recommended Operating Conditions<sup>(1)</sup>

			MIN	MAX	UNIT
V <sub>CC</sub>	Supply voltage	Operating	1.65	5.5	V
		Data retention only	1.5		
V <sub>IH</sub>	High-level input voltage	V <sub>CC</sub> = 1.65 V to 1.95 V	0.65 × V <sub>CC</sub>		V
		V <sub>CC</sub> = 2.3 V to 2.7 V	1.7		
		V <sub>CC</sub> = 3 V to 3.6 V	2		
		V <sub>CC</sub> = 4.5 V to 5.5 V	0.7 × V <sub>CC</sub>		
V <sub>IL</sub>	Low-level input voltage	V <sub>CC</sub> = 1.65 V to 1.95 V	0.35 × V <sub>CC</sub>		V
		V <sub>CC</sub> = 2.3 V to 2.7 V	0.7		
		V <sub>CC</sub> = 3 V to 3.6 V	0.8		
		V <sub>CC</sub> = 4.5 V to 5.5 V	0.3 × V <sub>CC</sub>		
V <sub>I</sub>	Input voltage		0	5.5	V
V <sub>O</sub>	Output voltage		0	V <sub>CC</sub>	V
I <sub>OH</sub>	High-level output current	V <sub>CC</sub> = 1.65 V	–4		mA
		V <sub>CC</sub> = 2.3 V	–8		
		V <sub>CC</sub> = 3 V	–16		
			–24		
		V <sub>CC</sub> = 4.5 V	–32		
I <sub>OL</sub>	Low-level output current	V <sub>CC</sub> = 1.65 V	4		mA
		V <sub>CC</sub> = 2.3 V	8		
		V <sub>CC</sub> = 3 V	16		
			24		
		V <sub>CC</sub> = 4.5 V	32		
Δt/Δv	Input transition rise or fall rate	V <sub>CC</sub> = 1.8 V ± 0.15 V, 2.5 V ± 0.2 V	20		ns/V
		V <sub>CC</sub> = 3.3 V ± 0.3 V	10		
		V <sub>CC</sub> = 5 V ± 0.5 V	5		
T <sub>A</sub>	Operating free-air temperature	SN74LVC2G08DCU	–40	125	°C
		SN74LVC2G08DCT	–40	125	
		SN74LVC2G08YZP	–40	85	

(1) All unused inputs of the device must be held at V<sub>CC</sub> or GND to ensure proper device operation. Refer to the TI application report, *Implications of Slow or Floating CMOS Inputs*, literature number [SCBA004](#).

### 6.4 Thermal Information

THERMAL METRIC <sup>(1)</sup>	SN74LVC2G08			UNIT	
	DCT (SM8)	DCU (VSSOP)	YZP (DSBGA)		
	8 PINS	8 PINS	8 PINS		
R <sub>θJA</sub>	Junction-to-ambient thermal resistance	220	227	128	°C/W
R <sub>θJC(top)</sub>	Junction-to-case (top) thermal resistance	108	84	14	°C/W

(1) For more information about traditional and new thermal metrics, see the *Semiconductor and IC Package Thermal Metrics* application report, [SPRA953](#).

## 6.5 Electrical Characteristics

over recommended operating free-air temperature range (unless otherwise noted)

PARAMETER		TEST CONDITIONS	V <sub>CC</sub>	MIN	TYP <sup>(1)</sup>	MAX	UNIT
V <sub>OH</sub>		I <sub>OH</sub> = -100 μA	1.65 V to 5.5 V	V <sub>CC</sub> - 0.1			V
		I <sub>OH</sub> = -4 mA	1.65 V	1.2			
		I <sub>OH</sub> = -8 mA	2.3 V	1.9			
		I <sub>OH</sub> = -16 mA	3 V	2.4			
		I <sub>OH</sub> = -24 mA		2.3			
		I <sub>OH</sub> = -32 mA	4.5 V	3.8			
V <sub>OL</sub>		I <sub>OL</sub> = 100 μA	1.65 V to 5.5 V			0.1	V
		I <sub>OL</sub> = 4 mA	1.65 V			0.45	
		I <sub>OL</sub> = 8 mA	2.3 V			0.3	
		I <sub>OL</sub> = 16 mA	3 V			0.4	
		I <sub>OL</sub> = 24 mA				0.55	
		I <sub>OL</sub> = 32 mA	4.5 V			0.55	
I <sub>I</sub>	A or B inputs	V <sub>I</sub> = 5.5 V or GND	0 to 5.5 V			±5	μA
I <sub>off</sub>		V <sub>I</sub> or V <sub>O</sub> = 5.5 V	0			±10	μA
I <sub>CC</sub>		V <sub>I</sub> = 5.5 V or GND, I <sub>O</sub> = 0	1.65 V to 5.5 V			10	μA
ΔI <sub>CC</sub>		One input at V <sub>CC</sub> - 0.6 V, Other inputs at V <sub>CC</sub> or GND, T <sub>A</sub> = -40°C to 85°C	3 V to 5.5 V			500	μA
C <sub>i</sub>		V <sub>I</sub> = V <sub>CC</sub> or GND, T <sub>A</sub> = -40°C to 85°C	3.3 V		5		pF
C <sub>pd</sub>		f = 10 MHz, T <sub>A</sub> = -40°C to 85°C	1.8 V to 3.3V		17		
			5 V		20		

 (1) All typical values are at V<sub>CC</sub> = 3.3 V, T<sub>A</sub> = 25°C.

## 6.6 Switching Characteristics

PARAMETER	FROM (INPUT)	TO (OUTPUT)	T <sub>A</sub>	V <sub>CC</sub>	MIN	MAX	UNIT
t <sub>pd</sub>	A or B	Y	-40°C to 85°C	V <sub>CC</sub> = 1.8 V ± 0.15 V	2.6	9	ns
				V <sub>CC</sub> = 2.5 V ± 0.2 V	1	5.1	
				V <sub>CC</sub> = 3.3 V ± 0.3 V	1	4.7	
				V <sub>CC</sub> = 5 V ± 0.5 V	1	3.8	
			-40°C to 125°C	V <sub>CC</sub> = 1.8 V ± 0.15 V	2.6	9.8	
				V <sub>CC</sub> = 2.5 V ± 0.2 V	1	5.8	
				V <sub>CC</sub> = 3.3 V ± 0.3 V	1	5.3	
				V <sub>CC</sub> = 5 V ± 0.5 V	1	4.8	

## 6.7 Typical Characteristics

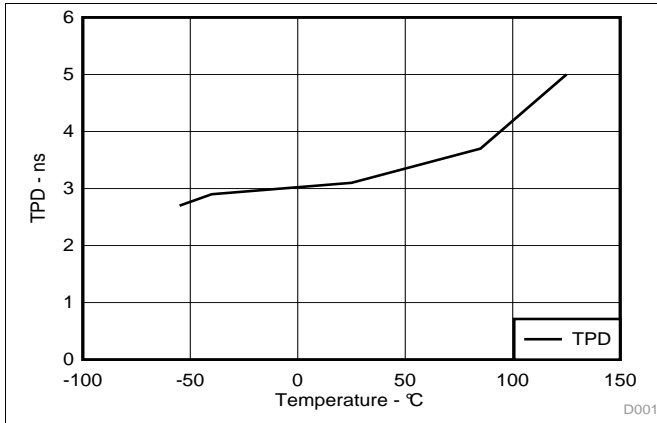

Figure 1. t<sub>PD</sub> Across Temperature at 3.3-V V<sub>CC</sub>

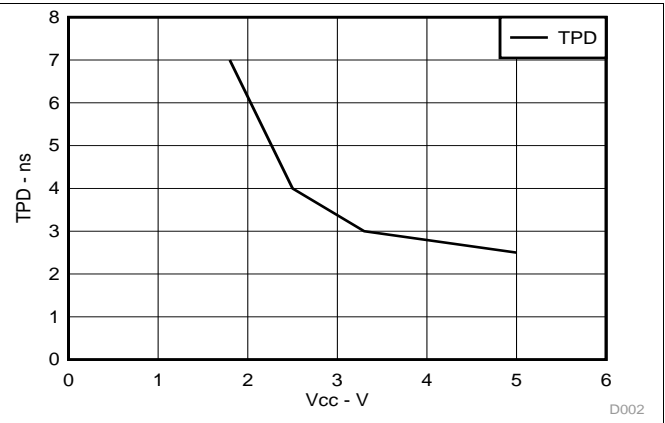
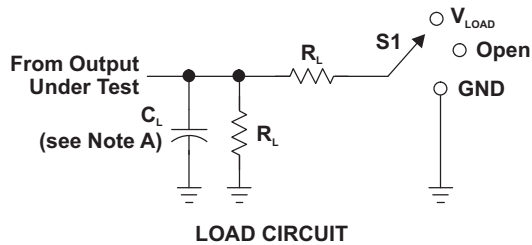

Figure 2. t<sub>PD</sub> Across V<sub>CC</sub> at 25°C

## 7 Parameter Measurement Information



TEST	S1
$t_{PLH}/t_{PHL}$	Open
$t_{PLZ}/t_{PZL}$	$V_{LOAD}$
$t_{PHZ}/t_{PZH}$	GND

$V_{CC}$	INPUTS		$V_M$	$V_{LOAD}$	$C_L$	$R_L$	$V_{\Delta}$
	$V_i$	$t_i/t_r$					
$1.8\text{ V} \pm 0.15\text{ V}$	$V_{CC}$	$\leq 2\text{ ns}$	$V_{CC}/2$	$2 \times V_{CC}$	30 pF	1 k $\Omega$	0.15 V
$2.5\text{ V} \pm 0.2\text{ V}$	$V_{CC}$	$\leq 2\text{ ns}$	$V_{CC}/2$	$2 \times V_{CC}$	30 pF	500 $\Omega$	0.15 V
$3.3\text{ V} \pm 0.3\text{ V}$	3 V	$\leq 2.5\text{ ns}$	1.5 V	6 V	50 pF	500 $\Omega$	0.3 V
$5\text{ V} \pm 0.5\text{ V}$	$V_{CC}$	$\leq 2.5\text{ ns}$	$V_{CC}/2$	$2 \times V_{CC}$	50 pF	500 $\Omega$	0.3 V

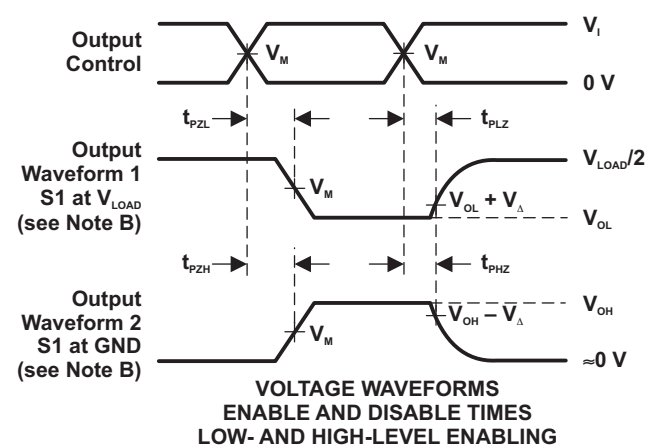
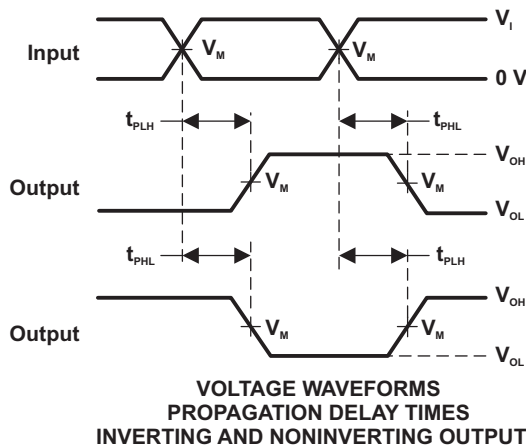
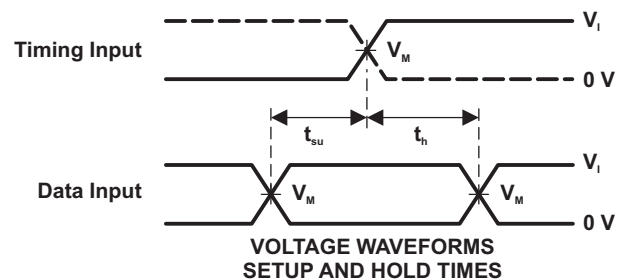
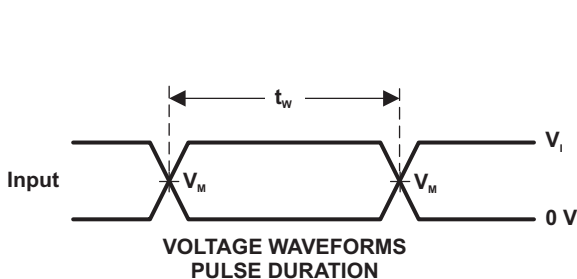

- NOTES:
- A.  $C_L$  includes probe and jig capacitance.
  - B. Waveform 1 is for an output with internal conditions such that the output is low, except when disabled by the output control. Waveform 2 is for an output with internal conditions such that the output is high, except when disabled by the output control.
  - C. All input pulses are supplied by generators having the following characteristics: PRR  $\leq 10\text{ MHz}$ ,  $Z_o = 50\ \Omega$ .
  - D. The outputs are measured one at a time, with one transition per measurement.
  - E.  $t_{PLZ}$  and  $t_{PHZ}$  are the same as  $t_{dis}$ .
  - F.  $t_{PZL}$  and  $t_{PZH}$  are the same as  $t_{en}$ .
  - G.  $t_{PLH}$  and  $t_{PHL}$  are the same as  $t_{pd}$ .
  - H. All parameters and waveforms are not applicable to all devices.

**Figure 3. Load Circuit and Voltage Waveforms**



## 8 Detailed Description

### 8.1 Overview

The SN74LVC1G06 device contains two positive-AND gates with a maximum sink current of 24 mA. A very low tpd of 4.7ns at 3.3V makes the device ideal for high speed applications. Additionally, 5.5V tolerant inputs allow the device to be used as a down translator if needed.

### 8.2 Functional Block Diagram

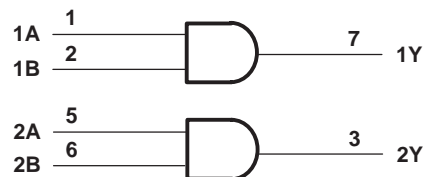

### 8.3 Feature Description

#### 8.3.1 Down Voltage Translation

SN74LVC2G08 allows for logic input and output signals up to 5.5 V. While operating at  $V_{CC}$  of 3.3 V, the device will still recognize 5.5 V as a valid high input, however, the resulting output will be 3.3 V. This is the same for other voltage levels in the device effectively down translating any input logic level higher than  $V_{CC}$  but lower or equal to 5.5 V.

### 8.4 Device Functional Modes

[Table 1](#) lists the functional modes of the SN74LVC2G08.

**Table 1. Function Table**

INPUTS		OUTPUT
A	B	Y
H	H	H
L	X	L
X	L	L

## 9 Application and Implementation

### NOTE

Information in the following applications sections is not part of the TI component specification, and TI does not warrant its accuracy or completeness. TI's customers are responsible for determining suitability of components for their purposes. Customers should validate and test their design implementation to confirm system functionality.

### 9.1 Application Information

The SN74LVC2G08 is a high-drive CMOS device that can be used for implementing AND logic with a high output drive, such as an LED application. It can produce 24 mA of drive current at 3.3 V, making it ideal for driving multiple outputs and good for high-speed applications up to 100 MHz. The inputs are 5.5-V tolerant allowing it to translate down to  $V_{CC}$ .

### 9.2 Typical Application

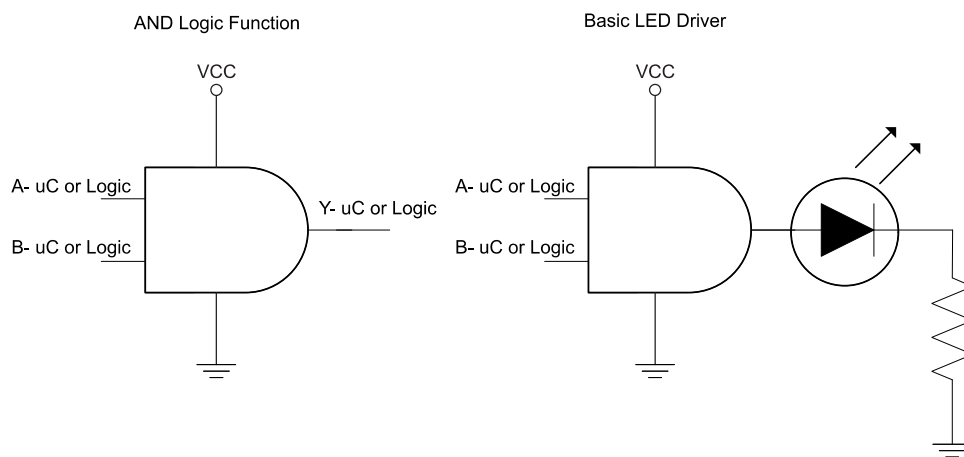

**Figure 4. Typical Application**

#### 9.2.1 Design Requirements

This device uses CMOS technology and has balanced output drive. Take care to avoid bus contention because it can drive currents that would exceed maximum limits. The high drive will also create fast edges into light loads so routing and load conditions must be considered to prevent ringing.

#### 9.2.2 Detailed Design Procedure

1. Recommended Input Conditions
  - Rise time and fall time specs. See  $(\Delta t/\Delta V)$  in the [Recommended Operating Conditions](#) table.
  - Specified high and low levels. See  $(V_{IH}$  and  $V_{IL})$  in the [Recommended Operating Conditions](#) table.
  - Inputs are overvoltage tolerant allowing them to go as high as  $(V_I$  maximum) in the [Recommended Operating Conditions](#) table at any valid  $V_{CC}$ .
2. Recommended Output Conditions
  - Load currents must not exceed  $(I_O$  maximum) per output and must not exceed total current (continuous current through  $V_{CC}$  or GND) for the part. These limits are located in the [Recommended Operating Conditions](#) table.
  - Outputs must not be pulled above  $V_{CC}$  in normal operating conditions.

## Typical Application (continued)

### 9.2.3 Application Curves

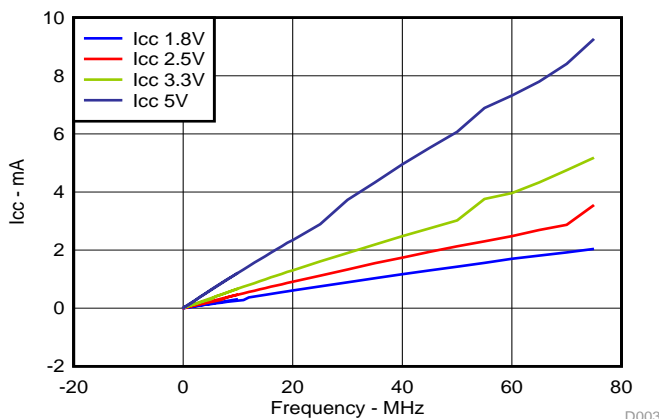

Figure 5. I<sub>CC</sub> vs Frequency

## 10 Power Supply Recommendations

The power supply can be any voltage between the minimum and maximum supply voltage rating located in the [Recommended Operating Conditions](#) table. Each V<sub>CC</sub> pin must have a good bypass capacitor to prevent power disturbance. For devices with a single supply, a 0.1-μF capacitor is recommended and if there are multiple V<sub>CC</sub> pins then 0.01-μF or 0.022-μF capacitor is recommended for each power pin. It is ok to parallel multiple bypass capacitors to reject different frequencies of noise. 0.1-μF and 1-μF capacitors are commonly used in parallel. The bypass capacitor must be installed as close to the power pin as possible for best results

## 11 Layout

### 11.1 Layout Guidelines

When using multiple bit logic devices inputs must not ever float. In many cases, functions or parts of functions of digital logic devices are unused; for example, when only two inputs of a triple-input AND gate are used or only 3 of the 4 buffer gates are used. Such input pins must not be left unconnected because the undefined voltages at the outside connections result in undefined operational states. Specified below are the rules that must be observed under all circumstances. All unused inputs of digital logic devices must be connected to a high or low bias to prevent them from floating. The logic level that must be applied to any particular unused input depends on the function of the device. Generally they will be tied to GND or V<sub>CC</sub> whichever make more sense or is more convenient.

### 11.2 Layout Example

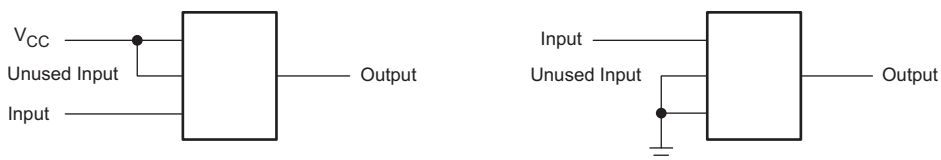

Figure 6. Layout Example

## 12 Device and Documentation Support

### 12.1 Community Resources

The following links connect to TI community resources. Linked contents are provided "AS IS" by the respective contributors. They do not constitute TI specifications and do not necessarily reflect TI's views; see TI's [Terms of Use](#).

**TI E2E™ Online Community** *TI's Engineer-to-Engineer (E2E) Community*. Created to foster collaboration among engineers. At [e2e.ti.com](http://e2e.ti.com), you can ask questions, share knowledge, explore ideas and help solve problems with fellow engineers.

**Design Support** *TI's Design Support* Quickly find helpful E2E forums along with design support tools and contact information for technical support.

### 12.2 Trademarks

NanoStar, NanoFree, E2E are trademarks of Texas Instruments.  
All other trademarks are the property of their respective owners.

### 12.3 Electrostatic Discharge Caution



These devices have limited built-in ESD protection. The leads should be shorted together or the device placed in conductive foam during storage or handling to prevent electrostatic damage to the MOS gates.

### 12.4 Glossary

[SLYZ022](#) — *TI Glossary*.

This glossary lists and explains terms, acronyms, and definitions.

## 13 Mechanical, Packaging, and Orderable Information

The following pages include mechanical, packaging, and orderable information. This information is the most current data available for the designated devices. This data is subject to change without notice and revision of this document. For browser-based versions of this data sheet, refer to the left-hand navigation.

**PACKAGING INFORMATION**

Orderable Device	Status (1)	Package Type	Package Drawing	Pins	Package Qty	Eco Plan (2)	Lead finish/ Ball material (6)	MSL Peak Temp (3)	Op Temp (°C)	Device Marking (4/5)	Samples
SN74LVC2G08DCTR	ACTIVE	SM8	DCT	8	3000	RoHS & Green	NIPDAU	Level-1-260C-UNLIM	-40 to 125	C08 (R, Z)	<a href="#">Samples</a>
SN74LVC2G08DCTRE4	ACTIVE	SM8	DCT	8	3000	RoHS & Green	NIPDAU	Level-1-260C-UNLIM	-40 to 125	C08 (R, Z)	<a href="#">Samples</a>
SN74LVC2G08DCTRG4	ACTIVE	SM8	DCT	8	3000	RoHS & Green	NIPDAU	Level-1-260C-UNLIM	-40 to 125	C08 (R, Z)	<a href="#">Samples</a>
SN74LVC2G08DCUR	ACTIVE	VSSOP	DCU	8	3000	RoHS & Green	NIPDAU   SN	Level-1-260C-UNLIM	-40 to 125	(08, C08J, C08Q, C08R) (CR, CZ)	<a href="#">Samples</a>
SN74LVC2G08DCURE4	ACTIVE	VSSOP	DCU	8	3000	RoHS & Green	NIPDAU	Level-1-260C-UNLIM	-40 to 125	C08R	<a href="#">Samples</a>
SN74LVC2G08DCURG4	ACTIVE	VSSOP	DCU	8	3000	RoHS & Green	NIPDAU	Level-1-260C-UNLIM	-40 to 125	C08R	<a href="#">Samples</a>
SN74LVC2G08DCUT	ACTIVE	VSSOP	DCU	8	250	RoHS & Green	NIPDAU   SN	Level-1-260C-UNLIM	-40 to 125	(C08J, C08Q, C08R) CR	<a href="#">Samples</a>
SN74LVC2G08DCUTG4	ACTIVE	VSSOP	DCU	8	250	RoHS & Green	NIPDAU	Level-1-260C-UNLIM	-40 to 125	C08R	<a href="#">Samples</a>
SN74LVC2G08YZPR	ACTIVE	DSBGA	YZP	8	3000	RoHS & Green	SNAGCU	Level-1-260C-UNLIM	-40 to 85	(CE7, CEN)	<a href="#">Samples</a>

(1) The marketing status values are defined as follows:

**ACTIVE:** Product device recommended for new designs.

**LIFEBUY:** TI has announced that the device will be discontinued, and a lifetime-buy period is in effect.

**NRND:** Not recommended for new designs. Device is in production to support existing customers, but TI does not recommend using this part in a new design.

**PREVIEW:** Device has been announced but is not in production. Samples may or may not be available.

**OBSOLETE:** TI has discontinued the production of the device.

(2) **RoHS:** TI defines "RoHS" to mean semiconductor products that are compliant with the current EU RoHS requirements for all 10 RoHS substances, including the requirement that RoHS substance do not exceed 0.1% by weight in homogeneous materials. Where designed to be soldered at high temperatures, "RoHS" products are suitable for use in specified lead-free processes. TI may reference these types of products as "Pb-Free".

**RoHS Exempt:** TI defines "RoHS Exempt" to mean products that contain lead but are compliant with EU RoHS pursuant to a specific EU RoHS exemption.

**Green:** TI defines "Green" to mean the content of Chlorine (Cl) and Bromine (Br) based flame retardants meet JS709B low halogen requirements of <=1000ppm threshold. Antimony trioxide based flame retardants must also meet the <=1000ppm threshold requirement.

(3) MSL, Peak Temp. - The Moisture Sensitivity Level rating according to the JEDEC industry standard classifications, and peak solder temperature.

(4) There may be additional marking, which relates to the logo, the lot trace code information, or the environmental category on the device.

(5) Multiple Device Markings will be inside parentheses. Only one Device Marking contained in parentheses and separated by a "~" will appear on a device. If a line is indented then it is a continuation of the previous line and the two combined represent the entire Device Marking for that device.

(6) Lead finish/Ball material - Orderable Devices may have multiple material finish options. Finish options are separated by a vertical ruled line. Lead finish/Ball material values may wrap to two lines if the finish value exceeds the maximum column width.

**Important Information and Disclaimer:**The information provided on this page represents TI's knowledge and belief as of the date that it is provided. TI bases its knowledge and belief on information provided by third parties, and makes no representation or warranty as to the accuracy of such information. Efforts are underway to better integrate information from third parties. TI has taken and continues to take reasonable steps to provide representative and accurate information but may not have conducted destructive testing or chemical analysis on incoming materials and chemicals. TI and TI suppliers consider certain information to be proprietary, and thus CAS numbers and other limited information may not be available for release.

In no event shall TI's liability arising out of such information exceed the total purchase price of the TI part(s) at issue in this document sold by TI to Customer on an annual basis.

**OTHER QUALIFIED VERSIONS OF SN74LVC2G08 :**

- Automotive: [SN74LVC2G08-Q1](#)
- Enhanced Product: [SN74LVC2G08-EP](#)

NOTE: Qualified Version Definitions:

- Automotive - Q100 devices qualified for high-reliability automotive applications targeting zero defects
- Enhanced Product - Supports Defense, Aerospace and Medical Applications

**TAPE AND REEL INFORMATION**

**QUADRANT ASSIGNMENTS FOR PIN 1 ORIENTATION IN TAPE**

\*All dimensions are nominal

Device	Package Type	Package Drawing	Pins	SPQ	Reel Diameter (mm)	Reel Width W1 (mm)	A0 (mm)	B0 (mm)	K0 (mm)	P1 (mm)	W (mm)	Pin1 Quadrant
SN74LVC2G08DCTR	SM8	DCT	8	3000	180.0	13.0	3.35	4.5	1.55	4.0	12.0	Q3
SN74LVC2G08DCTR	SM8	DCT	8	3000	177.8	12.4	3.45	4.4	1.45	4.0	12.0	Q3
SN74LVC2G08DCUR	VSSOP	DCU	8	3000	178.0	9.0	2.25	3.35	1.05	4.0	8.0	Q3
SN74LVC2G08DCUR	VSSOP	DCU	8	3000	180.0	9.0	2.25	3.4	1.0	4.0	8.0	Q3
SN74LVC2G08DCUR	VSSOP	DCU	8	3000	180.0	8.4	2.25	3.35	1.05	4.0	8.0	Q3
SN74LVC2G08DCUR	VSSOP	DCU	8	3000	178.0	9.5	2.25	3.35	1.05	4.0	8.0	Q3
SN74LVC2G08DCURG4	VSSOP	DCU	8	3000	180.0	8.4	2.25	3.35	1.05	4.0	8.0	Q3
SN74LVC2G08DCUT	VSSOP	DCU	8	250	180.0	8.4	2.25	3.35	1.05	4.0	8.0	Q3
SN74LVC2G08DCUT	VSSOP	DCU	8	250	178.0	9.5	2.25	3.35	1.05	4.0	8.0	Q3
SN74LVC2G08DCUT	VSSOP	DCU	8	250	178.0	9.0	2.25	3.35	1.05	4.0	8.0	Q3
SN74LVC2G08DCUTG4	VSSOP	DCU	8	250	180.0	8.4	2.25	3.35	1.05	4.0	8.0	Q3
SN74LVC2G08YZPR	DSBGA	YZP	8	3000	178.0	9.2	1.02	2.02	0.63	4.0	8.0	Q1

**TAPE AND REEL BOX DIMENSIONS**

\*All dimensions are nominal

Device	Package Type	Package Drawing	Pins	SPQ	Length (mm)	Width (mm)	Height (mm)
SN74LVC2G08DCTR	SM8	DCT	8	3000	182.0	182.0	20.0
SN74LVC2G08DCTR	SM8	DCT	8	3000	183.0	183.0	20.0
SN74LVC2G08DCUR	VSSOP	DCU	8	3000	180.0	180.0	18.0
SN74LVC2G08DCUR	VSSOP	DCU	8	3000	182.0	182.0	20.0
SN74LVC2G08DCUR	VSSOP	DCU	8	3000	202.0	201.0	28.0
SN74LVC2G08DCUR	VSSOP	DCU	8	3000	202.0	201.0	28.0
SN74LVC2G08DCURG4	VSSOP	DCU	8	3000	202.0	201.0	28.0
SN74LVC2G08DCUT	VSSOP	DCU	8	250	202.0	201.0	28.0
SN74LVC2G08DCUT	VSSOP	DCU	8	250	202.0	201.0	28.0
SN74LVC2G08DCUT	VSSOP	DCU	8	250	180.0	180.0	18.0
SN74LVC2G08DCUTG4	VSSOP	DCU	8	250	202.0	201.0	28.0
SN74LVC2G08YZPR	DSBGA	YZP	8	3000	220.0	220.0	35.0







# EXAMPLE STENCIL DESIGN

DCU0008A

VSSOP - 0.9 mm max height

SMALL OUTLINE PACKAGE

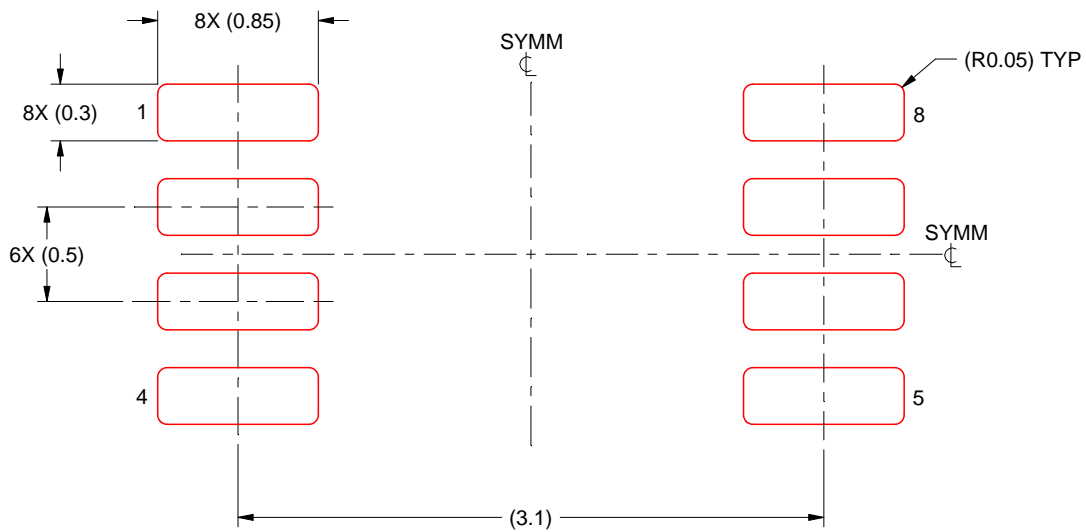

SOLDER PASTE EXAMPLE  
BASED ON 0.125 mm THICK STENCIL  
SCALE: 25X

4225266/A 09/2014

NOTES: (continued)

7. Laser cutting apertures with trapezoidal walls and rounded corners may offer better paste release. IPC-7525 may have alternate design recommendations.
8. Board assembly site may have different recommendations for stencil design.

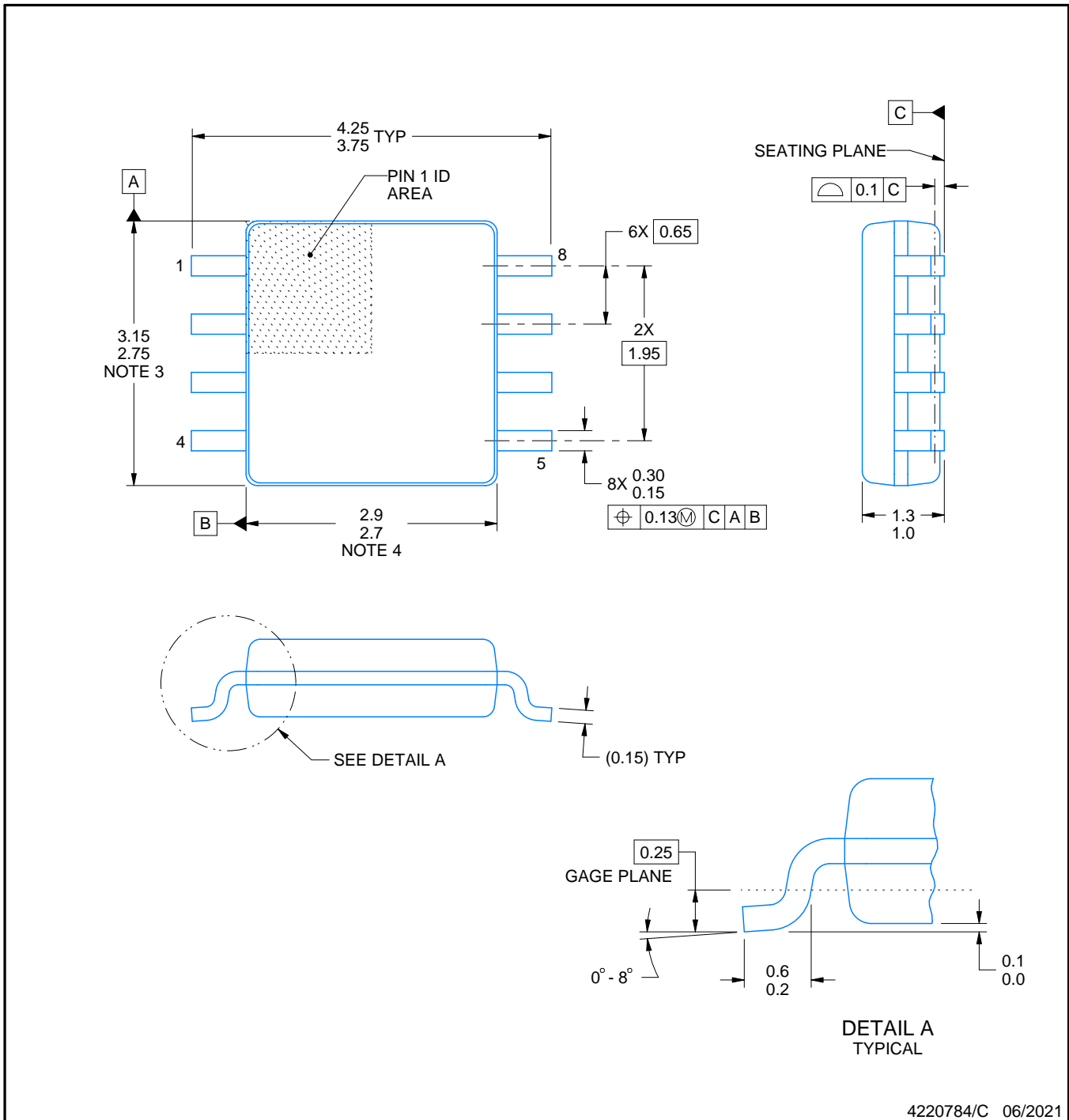
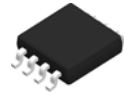

NOTES:

1. All linear dimensions are in millimeters. Dimensions in parenthesis are for reference only. Dimensioning and tolerancing per ASME Y14.5M.
2. This drawing is subject to change without notice.
3. This dimension does not include mold flash, protrusions, or gate burrs. Mold flash, protrusions, or gate burrs shall not exceed 0.15 mm per side.
4. This dimension does not include interlead flash. Interlead flash shall not exceed 0.25 mm per side.

# EXAMPLE BOARD LAYOUT

DCT0008A

SSOP - 1.3 mm max height

SMALL OUTLINE PACKAGE

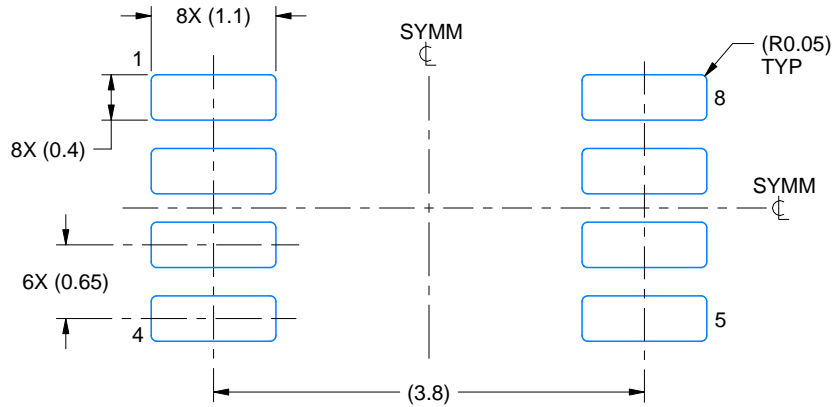

LAND PATTERN EXAMPLE  
EXPOSED METAL SHOWN  
SCALE:15X

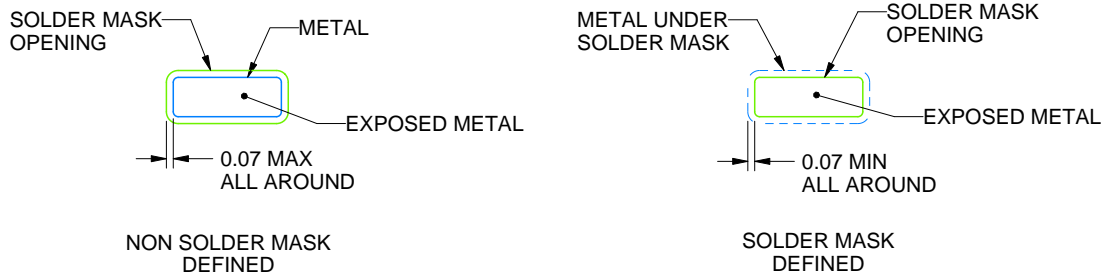

SOLDER MASK DETAILS

4220784/C 06/2021

NOTES: (continued)

- 5. Publication IPC-7351 may have alternate designs.
- 6. Solder mask tolerances between and around signal pads can vary based on board fabrication site.

# EXAMPLE STENCIL DESIGN

DCT0008A

SSOP - 1.3 mm max height

SMALL OUTLINE PACKAGE

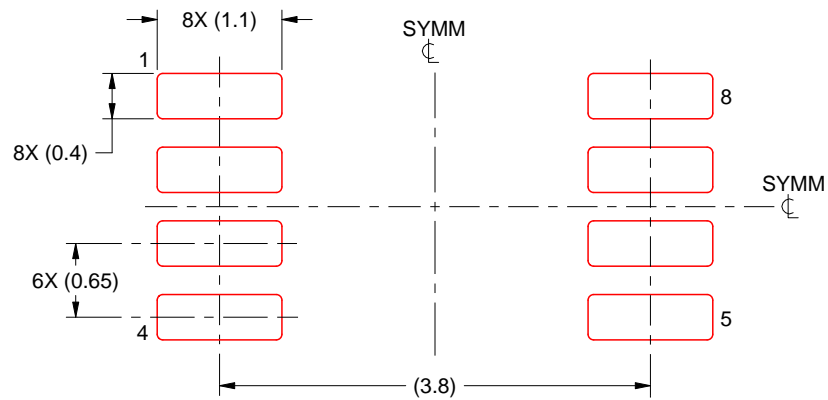

SOLDER PASTE EXAMPLE  
BASED ON 0.125 mm THICK STENCIL  
SCALE:15X

4220784/C 06/2021

NOTES: (continued)

7. Laser cutting apertures with trapezoidal walls and rounded corners may offer better paste release. IPC-7525 may have alternate design recommendations.
8. Board assembly site may have different recommendations for stencil design.

YZP0008

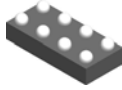

# PACKAGE OUTLINE

DSBGA - 0.5 mm max height

DIE SIZE BALL GRID ARRAY

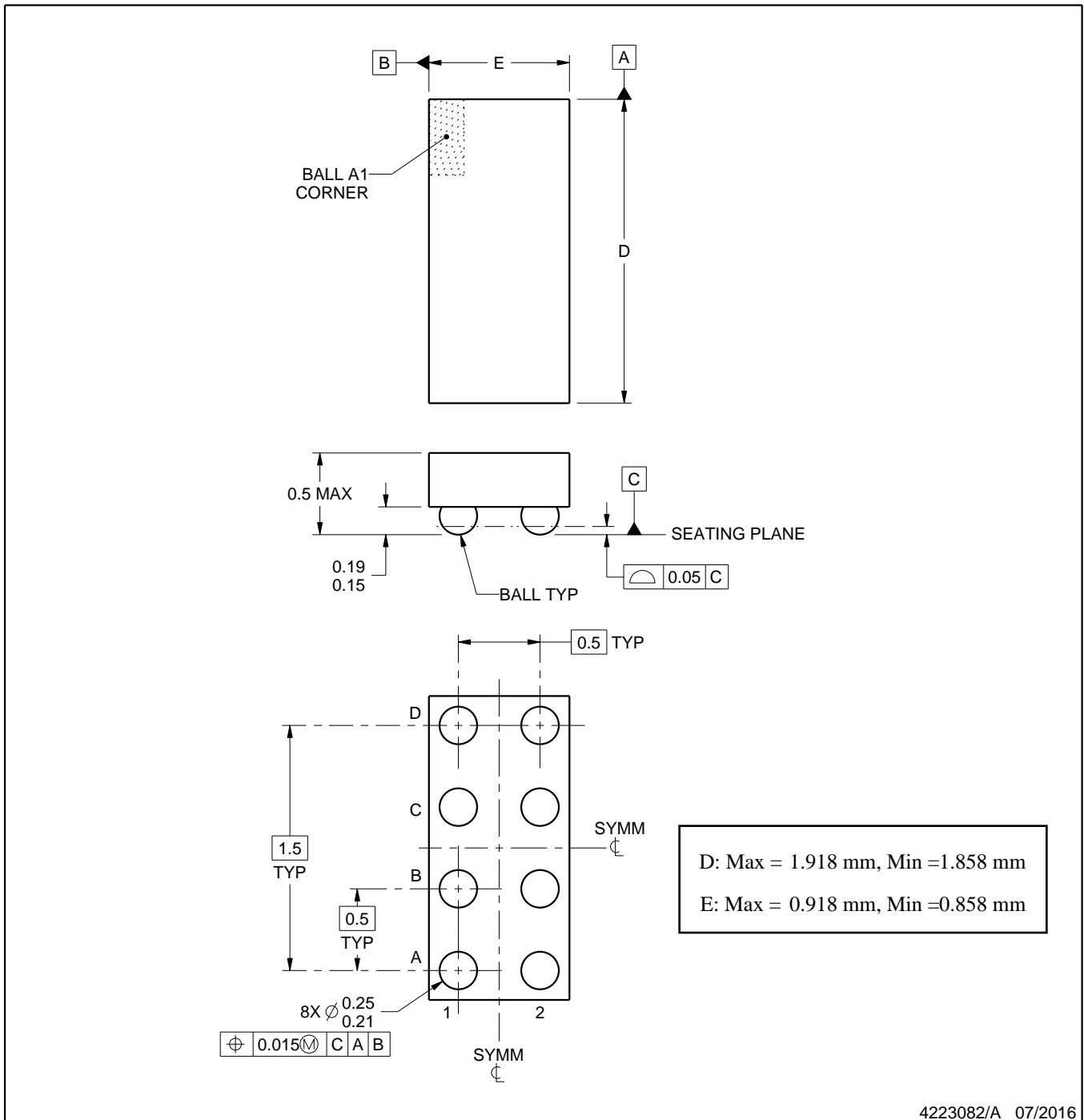

NOTES:

1. All linear dimensions are in millimeters. Any dimensions in parenthesis are for reference only. Dimensioning and tolerancing per ASME Y14.5M.
2. This drawing is subject to change without notice.

# EXAMPLE BOARD LAYOUT

YZP0008

DSBGA - 0.5 mm max height

DIE SIZE BALL GRID ARRAY

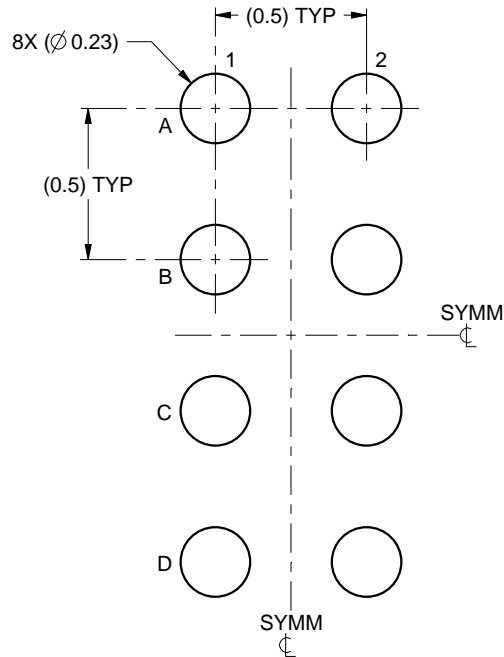

LAND PATTERN EXAMPLE  
SCALE:40X

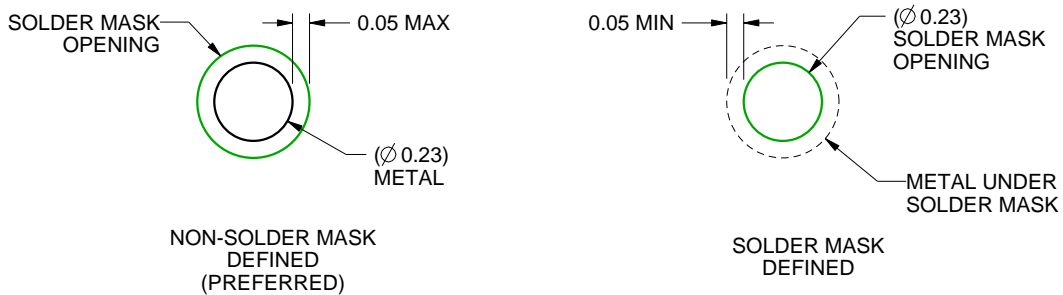

SOLDER MASK DETAILS  
NOT TO SCALE

4223082/A 07/2016

NOTES: (continued)

3. Final dimensions may vary due to manufacturing tolerance considerations and also routing constraints. For more information, see Texas Instruments literature number SNVA009 ([www.ti.com/lit/snva009](http://www.ti.com/lit/snva009)).



# EXAMPLE STENCIL DESIGN

YZP0008

DSBGA - 0.5 mm max height

DIE SIZE BALL GRID ARRAY

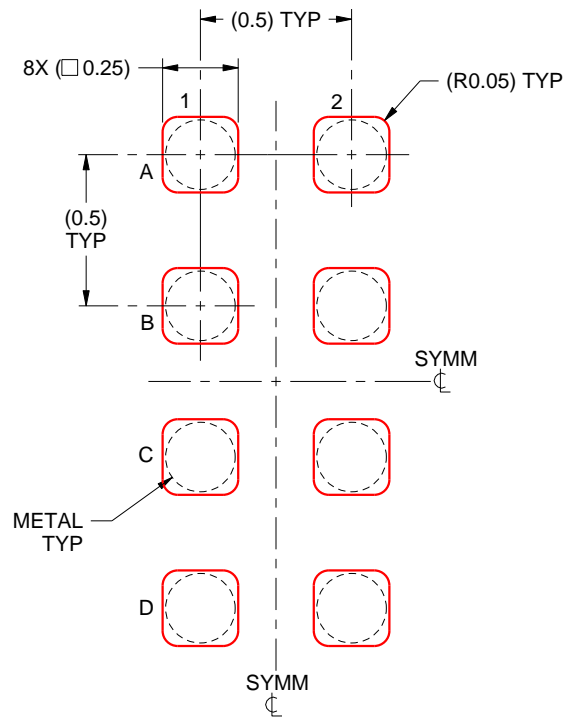

SOLDER PASTE EXAMPLE  
BASED ON 0.1 mm THICK STENCIL  
SCALE:40X

4223082/A 07/2016

NOTES: (continued)

4. Laser cutting apertures with trapezoidal walls and rounded corners may offer better paste release.

## IMPORTANT NOTICE AND DISCLAIMER

TI PROVIDES TECHNICAL AND RELIABILITY DATA (INCLUDING DATA SHEETS), DESIGN RESOURCES (INCLUDING REFERENCE DESIGNS), APPLICATION OR OTHER DESIGN ADVICE, WEB TOOLS, SAFETY INFORMATION, AND OTHER RESOURCES "AS IS" AND WITH ALL FAULTS, AND DISCLAIMS ALL WARRANTIES, EXPRESS AND IMPLIED, INCLUDING WITHOUT LIMITATION ANY IMPLIED WARRANTIES OF MERCHANTABILITY, FITNESS FOR A PARTICULAR PURPOSE OR NON-INFRINGEMENT OF THIRD PARTY INTELLECTUAL PROPERTY RIGHTS.

These resources are intended for skilled developers designing with TI products. You are solely responsible for (1) selecting the appropriate TI products for your application, (2) designing, validating and testing your application, and (3) ensuring your application meets applicable standards, and any other safety, security, regulatory or other requirements.

These resources are subject to change without notice. TI grants you permission to use these resources only for development of an application that uses the TI products described in the resource. Other reproduction and display of these resources is prohibited. No license is granted to any other TI intellectual property right or to any third party intellectual property right. TI disclaims responsibility for, and you will fully indemnify TI and its representatives against, any claims, damages, costs, losses, and liabilities arising out of your use of these resources.

TI's products are provided subject to [TI's Terms of Sale](#) or other applicable terms available either on [ti.com](https://www.ti.com) or provided in conjunction with such TI products. TI's provision of these resources does not expand or otherwise alter TI's applicable warranties or warranty disclaimers for TI products.

TI objects to and rejects any additional or different terms you may have proposed.

Mailing Address: Texas Instruments, Post Office Box 655303, Dallas, Texas 75265  
Copyright © 2023, Texas Instruments Incorporated