

LM74700-Q1 低 I_Q 电池反向保护理想二极管控制器

1 特性

- 具有符合 AEC-Q100 标准的下列特性
 - 器件温度等级 1：
 - 40°C 至 +125°C 环境工作温度范围
 - 器件 HBM ESD 分类等级 2
 - 器件 CDM ESD 分类等级 C4B
- 提供功能安全
 - 可帮助进行功能安全系统设计的文档
- 3.2V 至 65V 输入范围 (3.9V 启动)
- 65V 反向电压额定值
- 适用于外部 N 沟道 MOSFET 的电荷泵
- 20mV 阳极至阴极正向压降调节
- 使能引脚特性
- 1 μ A 关断电流 (EN = 低电平)
- 80 μ A 工作静态电流 (EN = 高电平)
- 2.3A 峰值栅极关断电流
- 快速响应反向电流阻断：
 - 小于 0.75 μ s
- 采用合适的 TVS 二极管，符合汽车 ISO7637 瞬态要求
- 采用 6 引脚和 8 引脚 SOT-23 封装 2.90mm \times 1.60mm

2 应用

- 汽车 ADAS 系统 - 摄像头
- 汽车信息娱乐系统 - 数字仪表盘、主机
- 工业工厂自动化 - PLC
- 企业电源
- 用于冗余电源的有源 ORing

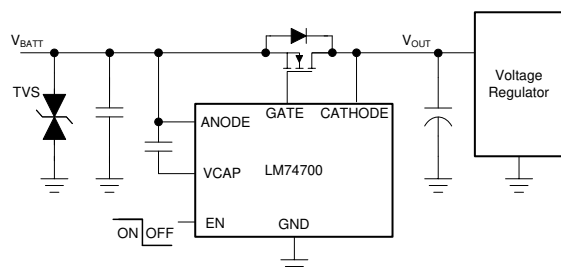

典型应用原理图

3 说明

LM74700-Q1 是一款符合汽车 AEC Q100 标准的理想二极管控制器，与外部 N 沟道 MOSFET 配合工作，可作为理想二极管整流器利用 20mV 正向压降实现低损耗反向保护。3.2V 至 65V 的宽电源输入范围可实现对众多常用直流总线电压 (例如：12V、24V 和 48V 汽车电池系统) 的控制。3.2V 输入电压支持适用于汽车系统中严苛的冷启动要求。该器件可耐受低至 -65V 的负电源电压，并提供负载保护。

该器件通过控制 MOSFET 的栅极将正向压降调节至 20mV。该电流调节方案可在反向电流事件中支持平稳关机，并确保零直流反向电流。该器件能够快速 (< 0.75 μ s) 响应反向电流阻断，因此适用于在 ISO7637 脉冲测试以及电源故障和输入微短路条件下要求保持输出电压的系统。

LM74700-Q1 控制器可提供适用于外部 N 沟道 MOSFET 的电荷泵栅极驱动器。LM74700-Q1 的高电压额定值有助于简化用于汽车 ISO7637 保护的系统设计。当使能引脚处于低电平时，控制器关闭，消耗大约 1 μ A 的电流。

器件信息(1)

器件型号	封装	封装尺寸 (标称值)
LM74700-Q1	SOT-23 (6)	2.90mm \times 1.60mm
LM74700-Q1	SOT-23 (8)	2.90mm \times 1.60mm

(1) 如需了解所有可用封装，请参阅数据表末尾的可订购产品附录。

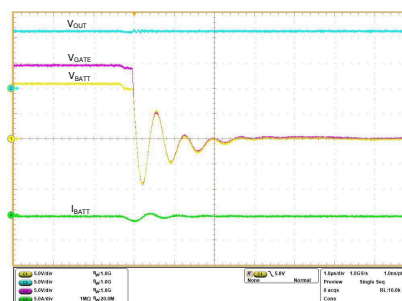

输入短路期间的反向电流阻断



Table of Contents

1 特性	1	9.3 Feature Description.....	13
2 应用	1	9.4 Device Functional Modes.....	15
3 说明	1	10 Application and Implementation	16
4 Revision History	2	10.1 Application Information.....	16
5 Pin Configuration and Functions	3	10.2 OR-ing Application Configuration.....	21
6 Specifications	5	11 Power Supply Recommendations	22
6.1 Absolute Maximum Ratings.....	5	12 Layout	23
6.2 ESD Ratings.....	5	12.1 Layout Guidelines.....	23
6.3 Recommended Operating Conditions.....	5	12.2 Layout Example.....	24
6.4 Thermal Information.....	6	13 Device and Documentation Support	25
6.5 Electrical Characteristics.....	6	13.1 接收文档更新通知.....	25
6.6 Switching Characteristics.....	7	13.2 支持资源.....	25
7 Typical Characteristics	8	13.3 Trademarks.....	25
8 Parameter Measurement Information	11	13.4 静电放电警告.....	25
9 Detailed Description	12	13.5 术语表.....	25
9.1 Overview.....	12	14 Mechanical, Packaging, and Orderable Information	25
9.2 Functional Block Diagram.....	12		

4 Revision History

注：以前版本的页码可能与当前版本的页码不同

Changes from Revision F (December 2019) to Revision G (December 2020)	Page
• 更新了整个文档的表、图和交叉参考的编号格式.....	1
• 向数据表添加了 DDF (SOT-23) 封装.....	1
• Relaxed VCAP specs in <i>Electrical Characteristics</i> table.....	5
Changes from Revision E (February 2019) to Revision F (December 2019)	Page
• 向 节 1 部分添加了“提供功能安全”链接.....	1
Changes from Revision D (January 2019) to Revision E (February 2019)	Page
• 将“预告信息”更改为“量产数据”.....	1
Changes from Revision C (November 2018) to Revision D (January 2019)	Page
• Added <i>Typical Characteristics</i> section.....	8
• Added <i>Parameter Measurement Information</i> section.....	11
• Deleted <i>Application Limitations</i> section.....	21
• Added <i>Or-ing Application Configuration</i> section.....	21
Changes from Revision B (October 2018) to Revision C (November 2018)	Page
• Added footnotes to the <i>Absolute Maximum Ratings</i> and <i>Recommended Operating Conditions</i> tables in the <i>Specifications</i> section.....	5
Changes from Revision A (March 2018) to Revision B (October 2018)	Page
• 在 <i>规格</i> 和 <i>应用限制</i> 部分进行了更改.....	1
Changes from Revision * (October 2017) to Revision A (March 2018)	Page
• 在整个数据表中进行了多处更改.....	1

5 Pin Configuration and Functions



图 5-1. DBV Package 6-Pin SOT-23 Top View

表 5-1. Pin Functions

PIN		I/O ⁽¹⁾	DESCRIPTION
NO.	NAME		
1	VCAP	O	Charge pump output. Connect to external charge pump capacitor
2	GND	G	Ground pin
3	EN	I	Enable pin. Can be connected to ANODE for always ON operation
4	CATHODE	I	Cathode of the diode. Connect to the drain of the external N-channel MOSFET
5	GATE	O	Gate drive output. Connect to gate of the external N-channel MOSFET
6	ANODE	I	Anode of the diode and input power. Connect to the source of the external N-channel MOSFET

(1) I = Input, O = Output, G = GND

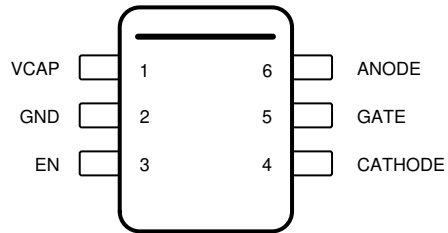

图 5-2. DDF Package 8-Pin SOT-23 Top View

表 5-2. Pin Functions

PIN		I/O ⁽¹⁾	DESCRIPTION
NO.	NAME		
1	EN	I	Enable pin. Can be connected to ANODE for always ON operation
2	GND	G	Ground pin
3	N.C		No connection
4	VCAP	O	Charge pump output. Connect to external charge pump capacitor
5	ANODE	I	Anode of the diode and input power. Connect to the source of the external N-channel MOSFET
6	GATE	O	Gate drive output. Connect to gate of the external N-channel MOSFET
7	N.C		No connection
8	CATHODE	I	Cathode of the diode. Connect to the drain of the external N-channel MOSFET

(1) I = Input, O = Output, G = GND

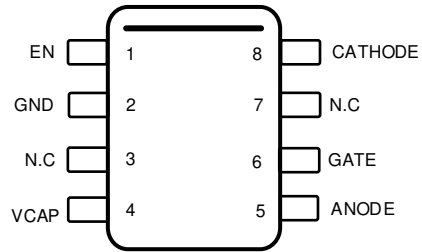
6 Specifications

6.1 Absolute Maximum Ratings

over operating free-air temperature range (unless otherwise noted)⁽¹⁾

		MIN	MAX	UNIT
Input Pins	ANODE to GND	- 65	65	V
	EN to GND, $V_{(ANODE)} > 0$ V	- 0.3	65	V
	EN to GND, $V_{(ANODE)} \leq 0$ V	$V_{(ANODE)}$	$(65 + V_{(ANODE)})$	V
Output Pins	GATE to ANODE	- 0.3	15	V
	VCAP to ANODE	- 0.3	15	V
Output to Input Pins	CATHODE to ANODE	- 5	75	V
Operating junction temperature ⁽²⁾		- 40	150	°C
Storage temperature, T_{stg}		- 40	150	°C

- (1) Stresses beyond those listed under Absolute Maximum Ratings may cause permanent damage to the device. These are stress ratings only, which do not imply functional operation of the device at these or any other conditions beyond those indicated under Recommended Operating Conditions. Exposure to absolute-maximum-rated conditions for extended periods may affect device reliability.
- (2) High junction temperatures degrade operating lifetimes. Operating lifetime is de-rated for junction temperatures greater than 125°C.

6.2 ESD Ratings

			VALUE	UNIT	
$V_{(ESD)}$	Electrostatic discharge	Human body model (HBM), per AEC Q100-002 ⁽¹⁾	±2000	V	
		Charged device model (CDM), per AEC Q100-011	Corner pins (VCAP, EN, ANODE, CATHODE)		±750
			Other pins		±500

- (1) JEDEC document JEP155 states that 500-V HBM allows safe manufacturing with a standard ESD control process.

6.3 Recommended Operating Conditions

over operating free-air temperature range (unless otherwise noted)⁽¹⁾

		MIN	NOM	MAX	UNIT
Input Pins	ANODE to GND	- 60		60	V
	CATHODE to GND			60	
	EN to GND	- 60		60	
Input to Output pins	ANODE to CATHODE	- 70			V
External capacitance	ANODE	22			nF
	CATHODE, VCAP to ANODE	0.1			µF
External MOSFET max V_{GS} rating	GATE to ANODE	15			V
T_J	Operating junction temperature range ⁽²⁾	- 40		150	°C

- (1) Recommended Operating Conditions are conditions under which the device is intended to be functional. For specifications and test conditions, see [Electrical Characteristics](#).
- (2) High junction temperatures degrade operating lifetimes. Operating lifetime is de-rated for junction temperatures greater than 125°C.

6.4 Thermal Information

THERMAL METRIC ⁽¹⁾		LM74700-Q1	LM74700-Q1	UNIT
		DBV (SOT)	DDF (SOT)	
		6 PINS	8 PINS	
$R_{\theta JA}$	Junction-to-ambient thermal resistance	189.8	133.8	°C/W
$R_{\theta JC(top)}$	Junction-to-case (top) thermal resistance	103.8	72.6	°C/W
$R_{\theta JB}$	Junction-to-board thermal resistance	45.8	54.5	°C/W
Ψ_{JT}	Junction-to-top characterization parameter	19.4	4.6	°C/W
Ψ_{JB}	Junction-to-board characterization parameter	45.5	54.2	°C/W

(1) For more information about traditional and new thermal metrics, see the Semiconductor and IC Package Thermal Metrics application report, SPRA953.

6.5 Electrical Characteristics

$T_J = -40^{\circ}\text{C}$ to $+125^{\circ}\text{C}$; typical values at $T_J = 25^{\circ}\text{C}$, $V_{(ANODE)} = 12\text{ V}$, $C_{(VCAP)} = 0.1\ \mu\text{F}$, $V_{(EN)} = 3.3\text{ V}$, over operating free-air temperature range (unless otherwise noted)

PARAMETER		TEST CONDITIONS	MIN	TYP	MAX	UNIT
V_{ANODE} SUPPLY VOLTAGE						
$V_{(ANODE)}$	Operating input voltage		4		60	V
$V_{(ANODE\ POR)}$	VANODE POR Rising threshold				3.9	V
	VANODE POR Falling threshold		2.2	2.8	3.1	V
$V_{(ANODE\ POR(Hys))}$	VANODE POR Hysteresis		0.44		0.67	V
$I_{(SHDN)}$	Shutdown Supply Current	$V_{(EN)} = 0\text{ V}$		0.9	1.5	μA
$I_{(Q)}$	Operating Quiescent Current			80	130	μA
ENABLE INPUT						
$V_{(EN_IL)}$	Enable input low threshold		0.5	0.9	1.22	V
$V_{(EN_IH)}$	Enable input high threshold		1.06	2	2.6	
$V_{(EN_Hys)}$	Enable Hysteresis		0.52		1.35	V
$I_{(EN)}$	Enable sink current	$V_{(EN)} = 12\text{ V}$		3	5	μA
V_{ANODE} to V_{CATHODE}						
$V_{(AK\ REG)}$	Regulated Forward $V_{(AK)}$ Threshold		13	20	29	mV
$V_{(AK)}$	$V_{(AK)}$ threshold for full conduction mode		34	50	57	mV
$V_{(AK\ REV)}$	$V_{(AK)}$ threshold for reverse current blocking		-17	-11	-2	mV
Gm	Regulation Error AMP Transconductance ⁽¹⁾		1200	1800	3100	$\mu\text{A/V}$
GATE DRIVE						
$I_{(GATE)}$	Peak source current	$V_{(ANODE)} - V_{(CATHODE)} = 100\text{ mV}$, $V_{(GATE)} - V_{(ANODE)} = 5\text{ V}$	3	11		mA
	Peak sink current	$V_{(ANODE)} - V_{(CATHODE)} = -20\text{ mV}$, $V_{(GATE)} - V_{(ANODE)} = 5\text{ V}$		2370		mA
	Regulation max sink current	$V_{(ANODE)} - V_{(CATHODE)} = 0\text{ V}$, $V_{(GATE)} - V_{(ANODE)} = 5\text{ V}$	6	26		μA
RDS_{ON}	discharge switch RDS_{ON}	$V_{(ANODE)} - V_{(CATHODE)} = -20\text{ mV}$, $V_{(GATE)} - V_{(ANODE)} = 100\text{ mV}$	0.4		2	Ω
CHARGE PUMP						

6.5 Electrical Characteristics (continued)

$T_J = -40^\circ\text{C}$ to $+125^\circ\text{C}$; typical values at $T_J = 25^\circ\text{C}$, $V_{(ANODE)} = 12\text{ V}$, $C_{(VCAP)} = 0.1\ \mu\text{F}$, $V_{(EN)} = 3.3\text{ V}$, over operating free-air temperature range (unless otherwise noted)

PARAMETER		TEST CONDITIONS	MIN	TYP	MAX	UNIT
$I_{(VCAP)}$	Charge Pump source current (Charge pump on)	$V_{(VCAP)} - V_{(ANODE)} = 7\text{ V}$	162	300	600	μA
	Charge Pump sink current (Charge pump off)	$V_{(VCAP)} - V_{(ANODE)} = 14\text{ V}$		5	10	μA
$V_{(VCAP)} - V_{(ANODE)}$	Charge pump voltage at $V_{(ANODE)} = 3.2\text{ V}$	$I_{(VCAP)} \leq 30\ \mu\text{A}$	8			V
	Charge pump turn on voltage		10.8	12.1	12.9	V
	Charge pump turn off voltage		11.6	13	13.9	V
	Charge Pump Enable comparator Hysteresis		0.54	0.9	1.36	V
$V_{(VCAP\ UVLO)}$	$V_{(VCAP)} - V_{(ANODE)}$ UV release at rising edge	$V_{(ANODE)} - V_{(CATHODE)} = 100\text{ mV}$	5.8	6.6	7.7	V
	$V_{(VCAP)} - V_{(ANODE)}$ UV threshold at falling edge	$V_{(ANODE)} - V_{(CATHODE)} = 100\text{ mV}$	5.11	5.68	6	V
CATHODE						
$I_{(CATHODE)}$	CATHODE sink current	$V_{(ANODE)} = 12\text{ V}$, $V_{(ANODE)} - V_{(CATHODE)} = -100\text{ mV}$		1.7	2	μA
		$V_{(ANODE)} - V_{(CATHODE)} = -100\text{ mV}$		1.2	2.2	μA
		$V_{(ANODE)} = -12\text{ V}$, $V_{(CATHODE)} = 12\text{ V}$		1.25	2.06	μA

(1) Parameter guaranteed by design and characterization

6.6 Switching Characteristics

$T_J = -40^\circ\text{C}$ to $+125^\circ\text{C}$; typical values at $T_J = 25^\circ\text{C}$, $V_{(ANODE)} = 12\text{ V}$, $C_{(VCAP)} = 0.1\ \mu\text{F}$, $V_{(EN)} = 3.3\text{ V}$, over operating free-air temperature range (unless otherwise noted)

PARAMETER		TEST CONDITIONS	MIN	TYP	MAX	UNIT
EN_{TDLY}	Enable (low to high) to Gate Turn On delay	$V_{(VCAP)} > V_{(VCAP\ UVLOR)}$		75	110	μs
$t_{Reverse\ delay}$	Reverse voltage detection to Gate Turn Off delay	$V_{(ANODE)} - V_{(CATHODE)} = 100\text{ mV}$ to -100 mV		0.45	0.75	μs
$t_{Forward\ recovery}$	Forward voltage detection to Gate Turn On delay	$V_{(ANODE)} - V_{(CATHODE)} = -100\text{ mV}$ to 700 mV		1.4	2.6	μs

7 Typical Characteristics



图 7-1. Shutdown Supply Current vs Supply Voltage



图 7-2. Operating Quiescent Current vs Supply Voltage

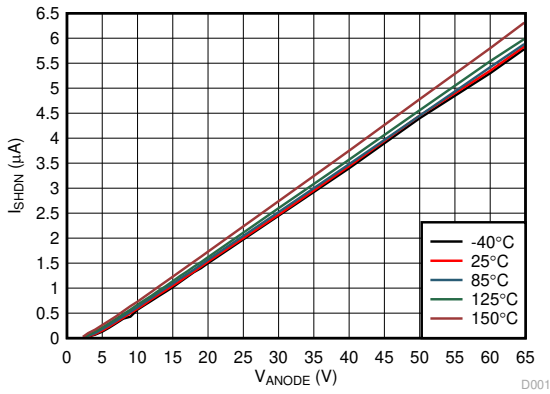

图 7-3. Enable Sink Current vs Supply Voltage

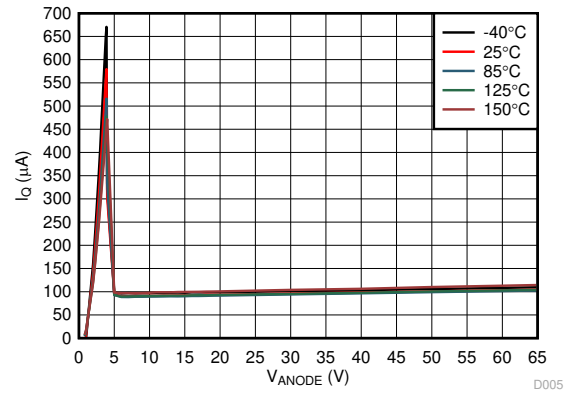

图 7-4. CATHODE Sink Current vs Supply Voltage

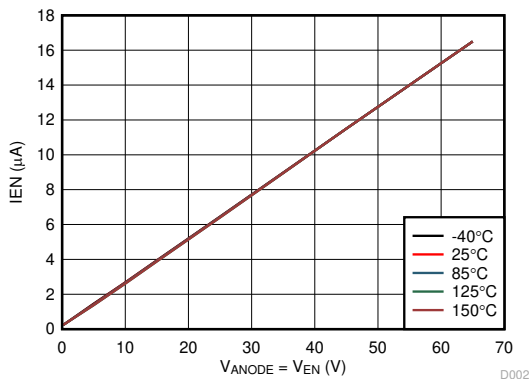

图 7-5. Charge Pump Current vs Supply Voltage at VCAP = 6 V

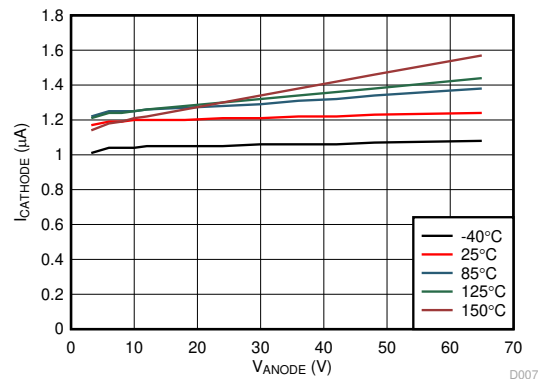

图 7-6. Charge Pump V-I Characteristics at VANODE >= 12 V

7 Typical Characteristics (continued)

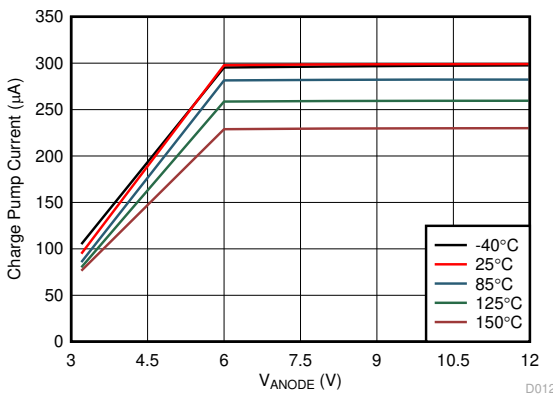

图 7-7. Charge Pump V-I Characteristics at VANODE = 3.2 V

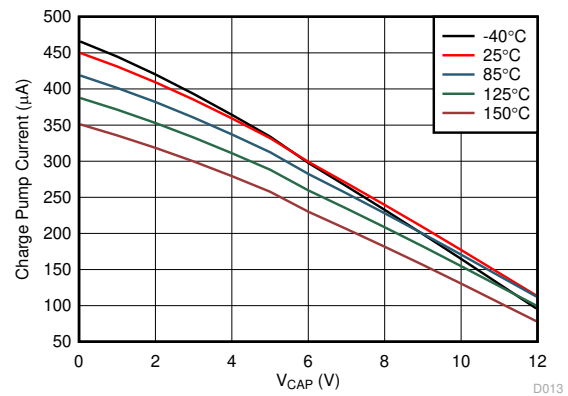

图 7-8. Enable Falling Threshold vs Temperature

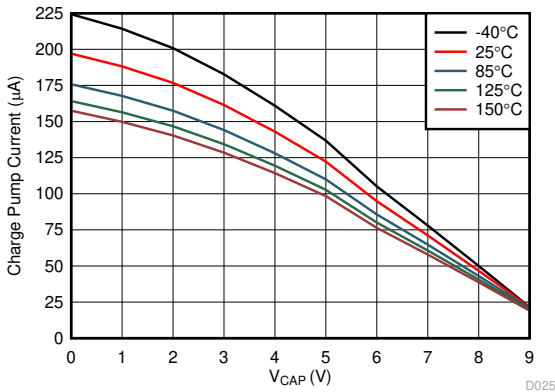

图 7-9. Reverse Current Blocking Delay vs Temperature

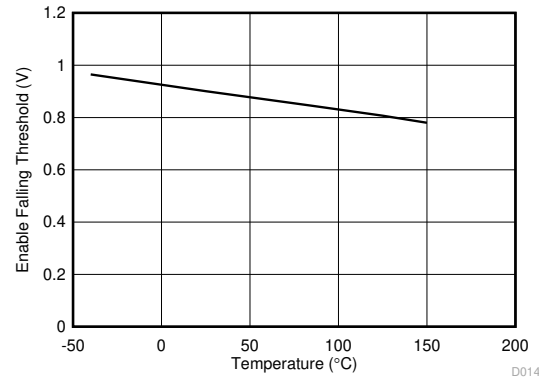

图 7-10. Forward Recovery Delay vs Temperature

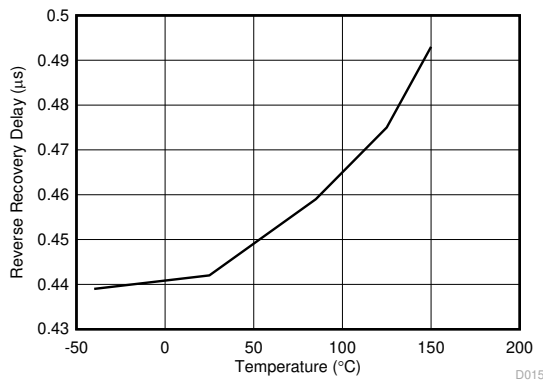

图 7-11. Enable to Gate Delay vs Temperature

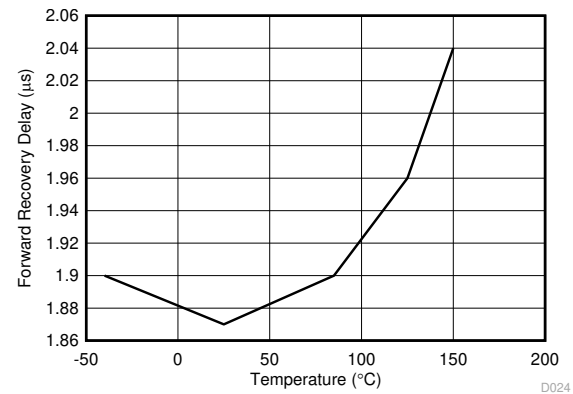

图 7-12. Charge Pump ON/OFF Threshold vs Temperature

7 Typical Characteristics (continued)

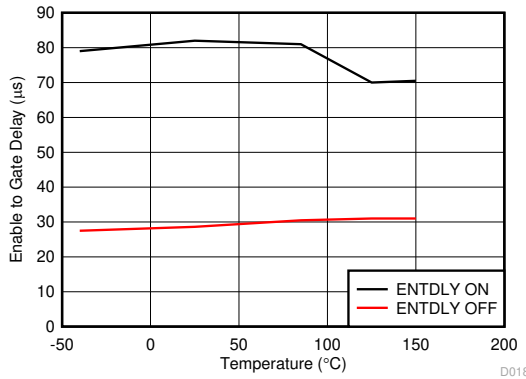

图 7-13. Charge Pump UVLO Threshold vs Temperature

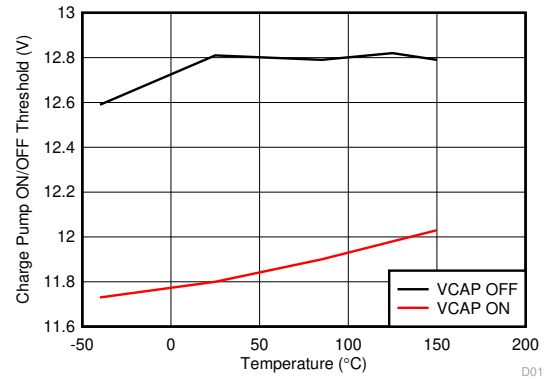

图 7-14. VANODE POR Threshold vs Temperature

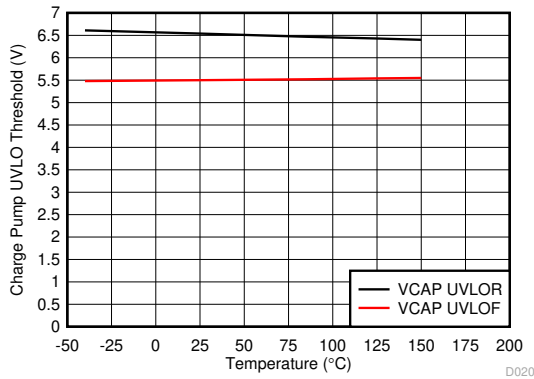

图 7-15. Gate Current vs Forward Voltage Drop

8 Parameter Measurement Information

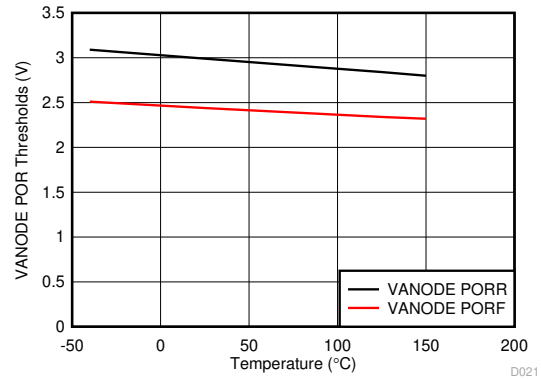

图 8-1. Timing Waveforms

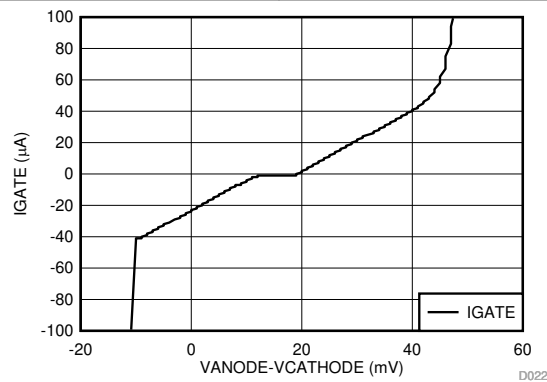
9 Detailed Description

9.1 Overview

The LM74700-Q1 [ideal diode controller](#) has all the features necessary to implement an efficient and fast reverse polarity protection circuit or be used in an ORing configuration while minimizing the number of external components. This easy to use ideal diode controller is paired with an external N-channel MOSFET to replace other reverse polarity schemes such as a P-channel MOSFET or a Schottky diode. An internal charge pump is used to drive the external N-Channel MOSFET to a maximum gate drive voltage of approximately 15 V. The voltage drop across the MOSFET is continuously monitored between the ANODE and CATHODE pins, and the GATE to ANODE voltage is adjusted as needed to regulate the forward voltage drop at 20 mV. This closed loop regulation scheme enables graceful turn off of the MOSFET during a reverse current event and ensures zero DC reverse current flow. A fast reverse current condition is detected when the voltage across ANODE and CATHODE pins reduces below -11 mV, resulting in the GATE pin being internally connected to the ANODE pin turning off the external N-channel MOSFET, and using the body diode to block any of the reverse current. An enable pin, EN is available to place the LM74700-Q1 in shutdown mode disabling the N-Channel MOSFET and minimizing the quiescent current.

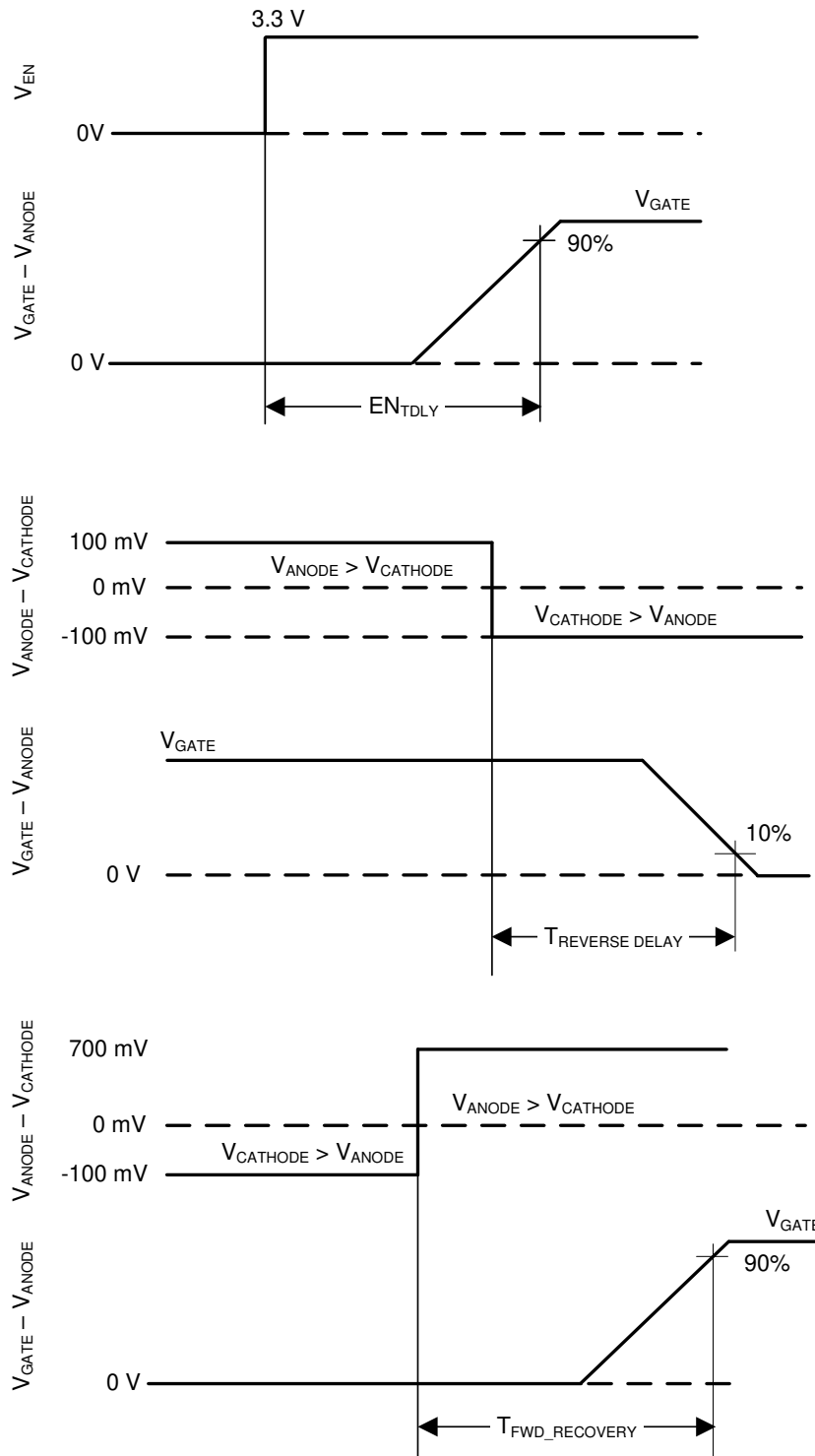
9.2 Functional Block Diagram

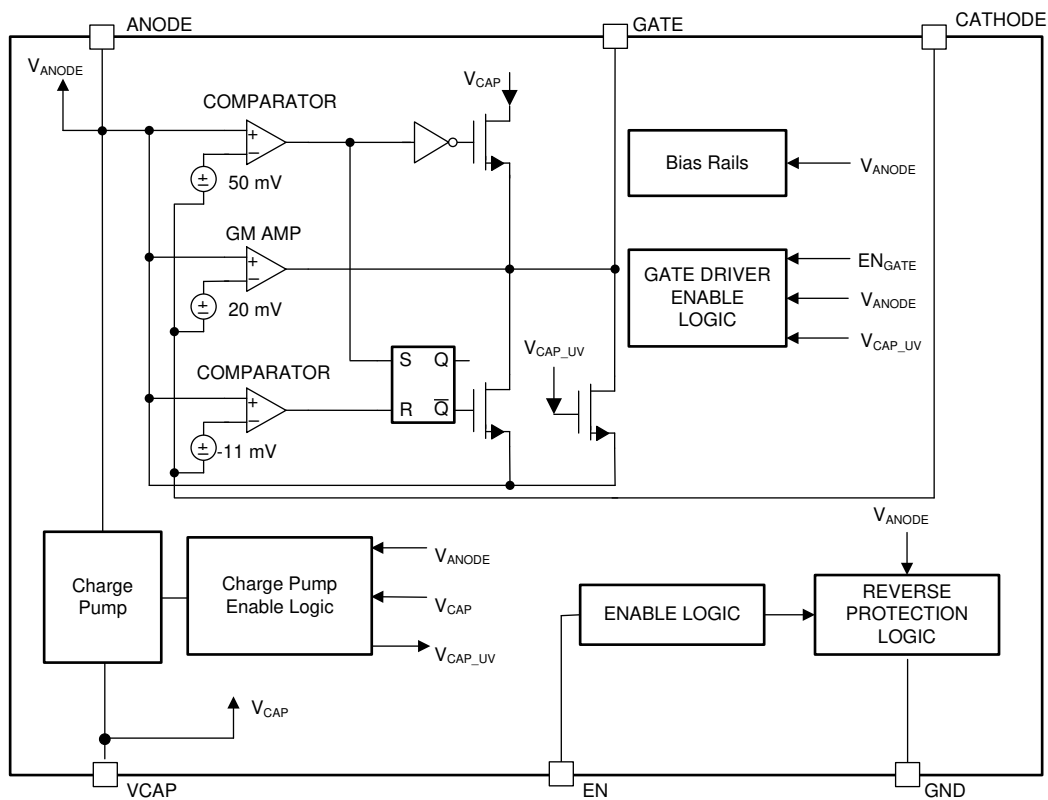

Copyright © 2017, Texas Instruments Incorporated

9.3 Feature Description

9.3.1 Input Voltage

The ANODE pin is used to power the LM74700-Q1's internal circuitry, typically drawing 80 μA when enabled and 1 μA when disabled. If the ANODE pin voltage is greater than the POR Rising threshold, then LM74700-Q1 operates in either shutdown mode or conduction mode in accordance with the EN pin voltage. The voltage from ANODE to GND is designed to vary from 65 V to -65 V, allowing the LM74700-Q1 to withstand negative voltage transients.

9.3.2 Charge Pump

The charge pump supplies the voltage necessary to drive the external N-channel MOSFET. An external charge pump capacitor is placed between VCAP and ANODE pins to provide energy to turn on the external MOSFET. In order for the charge pump to supply current to the external capacitor the EN pin voltage must be above the specified input high threshold, $V_{(EN_IH)}$. When enabled the charge pump sources a charging current of 300- μA typical. If EN pins is pulled low, then the charge pump remains disabled. To ensure that the external MOSFET can be driven above its specified threshold voltage, the VCAP to ANODE voltage must be above the undervoltage lockout threshold, typically 6.6 V, before the internal gate driver is enabled. Use [方程式 1](#) to calculate the initial gate driver enable delay.

$$T_{(DRV_EN)} = 75\mu\text{s} + C_{(VCAP)} \times \frac{V_{(VCAP_UVLOR)}}{300\mu\text{A}} \quad (1)$$

where

- $C_{(VCAP)}$ is the charge pump capacitance connected across ANODE and VCAP pins
- $V_{(VCAP_UVLOR)} = 6.6 \text{ V}$ (typical)

. To remove any chatter on the gate drive approximately 900 mV of hysteresis is added to the VCAP undervoltage lockout. The charge pump remains enabled until the VCAP to ANODE voltage reaches 13 V, typically, at which point the charge pump is disabled decreasing the current draw on the ANODE pin. The charge pump remains disabled until the VCAP to ANODE voltage is below to 12.1 V typically at which point the charge pump is enabled. The voltage between VCAP and ANODE continue to charge and discharge between 12.1 V and 13 V as shown in [图 9-1](#). By enabling and disabling the charge pump, the operating quiescent current of the LM74700-Q1 is reduced. When the charge pump is disabled it sinks 5- μA typical.

If the above conditions are not achieved, then the GATE pin is internally connected to the ANODE pin, assuring that the external MOSFET is disabled. Once these conditions are achieved the gate driver operates in the correct mode depending on the ANODE to CATHODE voltage.

9.3.4 Enable

The LM74700-Q1 has an enable pin, EN. The enable pin allows for the gate driver to be either enabled or disabled by an external signal. If the EN pin voltage is greater than the rising threshold, the gate driver and charge pump operates as described in [Gate Driver](#) and [Charge Pump](#) sections. If the enable pin voltage is less than the input low threshold, the charge pump and gate driver are disabled placing the LM74700-Q1 in shutdown mode. The EN pin can withstand a voltage as large as 65 V and as low as -65 V. This allows for the EN pin to be connected directly to the ANODE pin if enable functionality is not needed. In conditions where EN is left floating, the internal sink current of 3 uA pulls EN pin low and disables the device.

9.4 Device Functional Modes

9.4.1 Shutdown Mode

The LM74700-Q1 enters shutdown mode when the EN pin voltage is below the specified input low threshold $V_{(EN_IL)}$. Both the gate driver and the charge pump are disabled in shutdown mode. During shutdown mode the LM74700-Q1 enters low I_Q operation with the ANODE pin only sinking 1 μ A. When the LM74700-Q1 is in shutdown mode, forward current flow through the external MOSFET is not interrupted but is conducted through the MOSFET's body diode.

9.4.2 Conduction Mode

Conduction mode occurs when the gate driver is enabled. There are three regions of operating during conduction mode based on the ANODE to CATHODE voltage of the LM74700-Q1. Each of the three modes is described in the [Regulated Conduction Mode](#), [Full Conduction Mode](#) and [Reverse Current Protection Mode](#) sections.

9.4.2.1 Regulated Conduction Mode

For the LM74700-Q1 to operate in regulated conduction mode, the gate driver must be enabled as described in the [Gate Driver](#) section and the current from source to drain of the external MOSFET must be within the range to result in an ANODE to CATHODE voltage drop of -11 mV to 50 mV. During forward regulation mode the ANODE to CATHODE voltage is regulated to 20 mV by adjusting the GATE to ANODE voltage. This closed loop regulation scheme enables graceful turn off of the MOSFET at very light loads and ensures zero DC reverse current flow.

9.4.2.2 Full Conduction Mode

For the LM74700-Q1 to operate in full conduction mode the gate driver must be enabled as described in the [Gate Driver](#) section and the current from source to drain of the external MOSFET must be large enough to result in an ANODE to CATHODE voltage drop of greater than 50-mV typical. If these conditions are achieved the GATE pin is internally connected to the VCAP pin resulting in the GATE to ANODE voltage being approximately the same as the VCAP to ANODE voltage. By connecting VCAP to GATE the external MOSFET's $R_{DS(ON)}$ is minimized reducing the power loss of the external MOSFET when forward currents are large.

9.4.2.3 Reverse Current Protection Mode

For the LM74700-Q1 to operate in reverse current protection mode, the gate driver must be enabled as described in the [Gate Driver](#) section and the current of the external MOSFET must be flowing from the drain to the source. When the ANODE to CATHODE voltage is typically less than -11 mV, reverse current protection mode is entered and the GATE pin is internally connected to the ANODE pin. The connection of the GATE to ANODE pin disables the external MOSFET. The body diode of the MOSFET blocks any reverse current from flowing from the drain to source.

10 Application and Implementation

Note

Information in the following applications sections is not part of the TI component specification, and TI does not warrant its accuracy or completeness. TI's customers are responsible for determining suitability of components for their purposes, as well as validating and testing their design implementation to confirm system functionality.

10.1 Application Information

The LM74700-Q1 is used with N-Channel MOSFET controller in a typical reverse polarity protection application. The schematic for the 12-V battery protection application is shown in 图 10-1 where the LM74700-Q1 is used in series with a battery to drive the MOSFET Q1. The TVS is not required for the LM74700-Q1 to operate, but they are used to clamp the positive and negative voltage surges. The output capacitor C_{OUT} is recommended to protect the immediate output voltage collapse as a result of line disturbance.

10.1.1 Typical Application



图 10-1. Typical Application Circuit

10.1.1.1 Design Requirements

A design example, with system design parameters listed in 表 10-1 is presented.

表 10-1. Design Parameters

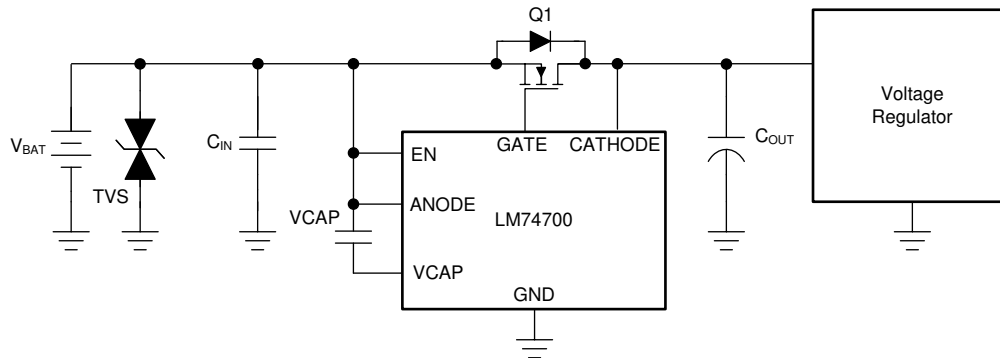
DESIGN PARAMETER	EXAMPLE VALUE
Input voltage range	12-V Battery, 12-V Nominal with 3.2-V Cold Crank and 35-V Load Dump
Output voltage	3.2 V during Cold Crank to 35-V Load Dump
Output current range	3-A Nominal, 5-A Maximum
Output capacitance	1- μ F Minimum, 47- μ F Typical Hold Up Capacitance
Automotive EMC Compliance	ISO 7637-2 and ISO 16750-2

10.1.1.2 Detailed Design Procedure

10.1.1.2.1 Design Considerations

- Input operating voltage range, including cold crank and load dump conditions
- Nominal load current and maximum load current

10.1.1.2.2 MOSFET Selection

The important MOSFET electrical parameters are the maximum continuous drain current I_D , the maximum drain-to-source voltage $V_{DS(MAX)}$, the maximum source current through body diode and the drain-to-source On resistance $R_{DS(ON)}$.

The maximum continuous drain current, I_D , rating must exceed the maximum continuous load current. The maximum drain-to-source voltage, $V_{DS(MAX)}$, must be high enough to withstand the highest differential voltage seen in the application. This would include any anticipated fault conditions. It is recommended to use MOSFETs with voltage rating up to 60-V maximum with the LM74700-Q1 because anode-cathode maximum voltage is 65 V. The maximum V_{GS} LM74700-Q1 can drive is 13 V, so a MOSFET with 15-V minimum V_{GS} should be selected. If a MOSFET with $< 15\text{-V } V_{GS}$ rating is selected, a zener diode can be used to clamp V_{GS} to safe level. During startup, inrush current flows through the body diode to charge the bulk hold-up capacitors at the output. The maximum source current through the body diode must be higher than the inrush current that can be seen in the application.

To reduce the MOSFET conduction losses, lowest possible $R_{DS(ON)}$ is preferred, but selecting a MOSFET based on low $R_{DS(ON)}$ may not be beneficial always. Higher $R_{DS(ON)}$ will provide increased voltage information to LM74700-Q1's reverse comparator at a lower reverse current. Reverse current detection is better with increased $R_{DS(ON)}$. It is recommended to operate the MOSFET in regulated conduction mode during nominal load conditions and select $R_{DS(ON)}$ such that at nominal operating current, forward voltage drop V_{DS} is close to 20-mV regulation point and not more than 50 mV.

As a guideline, it is suggested to choose $(20 \text{ mV} / I_{Load(Nominal)}) \leq R_{DS(ON)} \leq (50 \text{ mV} / I_{Load(Nominal)})$.

MOSFET manufacturers usually specify $R_{DS(ON)}$ at 4.5-V V_{GS} and 10-V V_{GS} . $R_{DS(ON)}$ increases drastically below 4.5-V V_{GS} and $R_{DS(ON)}$ is highest when V_{GS} is close to MOSFET V_{th} . For stable regulation at light load conditions, it is recommended to operate the MOSFET close to 4.5-V V_{GS} , that is, much higher than MOSFET gate threshold voltage. It is recommended to choose MOSFET gate threshold voltage V_{th} of 2-V to 2.5-V maximum. Choosing a lower V_{th} MOSFET also reduces the turn ON time.

Based on the design requirements, preferred MOSFET ratings are:

- 60-V $V_{DS(MAX)}$ and $\pm 20\text{-V } V_{GS(MAX)}$
- $R_{DS(ON)}$ at 3-A nominal current: $(20 \text{ mV} / 3\text{A}) \leq R_{DS(ON)} \leq (50 \text{ mV} / 3\text{A}) = 6.67 \text{ m}\Omega \leq R_{DS(ON)} \leq 16.67 \text{ m}\Omega$
- MOSFET gate threshold voltage V_{th} : 2V maximum

DMT6007LFG MOSFET from Diodes Inc. is selected to meet this 12-V reverse battery protection design requirements and it is rated at:

- 60-V $V_{DS(MAX)}$ and $\pm 20\text{-V } V_{GS(MAX)}$
- $R_{DS(ON)}$ 6.5-m Ω typical and 8.5-m Ω maximum rated at 4.5-V V_{GS}
- MOSFET V_{th} : 2-V maximum

Thermal resistance of the MOSFET should be considered against the expected maximum power dissipation in the MOSFET to ensure that the junction temperature (T_J) is well controlled.

10.1.1.2.3 Charge Pump VCAP, input and output capacitance

Minimum required capacitance for charge pump VCAP and input/output capacitance are:

- VCAP: Minimum 0.1 μF is required; recommended value of VCAP (μF) $\geq 10 \times C_{ISS(MOSFET)}(\mu\text{F})$
- C_{IN} : minimum 22 nF of input capacitance
- C_{OUT} : minimum 100 nF of output capacitance

10.1.1.3 Selection of TVS Diodes for 12-V Battery Protection Applications

TVS diodes are used in automotive systems for protection against transients. In the 12-V battery protection application circuit shown in [Figure 10-2](#), a bi-directional TVS diode is used to protect from positive and negative

transient voltages that occur during normal operation of the car and these transient voltage levels and pulses are specified in ISO 7637-2 and ISO 16750-2 standards.

There are two important specifications are breakdown voltage and clamping voltage of the TVS. Breakdown voltage is the voltage at which the TVS diode goes into avalanche similar to a zener diode and is specified at a low current value typical 1 mA and the breakdown voltage should be higher than worst case steady state voltages seen in the system. The breakdown voltage of the TVS+ should be higher than 24-V jump start voltage and 35-V suppressed load dump voltage and less than the maximum ratings of LM74700-Q1 (65 V). The breakdown voltage of TVS- should be beyond than maximum reverse battery voltage - 16 V, so that the TVS- is not damaged due to long time exposure to reverse connected battery.

Clamping voltage is the voltage the TVS diode clamps in high current pulse situations and this voltage is much higher than the breakdown voltage. TVS diodes are meant to clamp transient pulses and should not interfere with steady state operation. In the case of an ISO 7637-2 pulse 1, the input voltage goes up to - 150 V with a generator impedance of 10 Ω . This translates to 15 A flowing through the TVS - and the voltage across the TVS would be close to its clamping voltage.



图 10-2. Typical 12-V Battery Protection with Single Bi-Directional TVS

The next criterion is that the absolute maximum rating of Anode to Cathode reverse voltage of the LM74700-Q1 (- 75 V) and the maximum V_{DS} rating MOSFET are not exceeded. In the design example, 60-V rated MOSFET is chosen and maximum limit on the cathode to anode voltage is 60 V.

In case of ISO 7637-2 pulse 1, the anode of LM74700-Q1 is pulled down by the ISO pulse and clamped by TVS-. The MOSFET is turned off quickly to prevent reverse current from discharging the bulk output capacitors. When the MOSFET turns off, the cathode to anode voltage seen is equal to (TVS Clamping voltage + Output capacitor voltage). If the maximum voltage on output capacitor is 16 V (maximum battery voltage), then the clamping voltage of the TVS- should not exceed, $(60 \text{ V} - 16) \text{ V} = - 44 \text{ V}$.

The SMBJ33CA TVS diode can be used for 12-V battery protection application. The breakdown voltage of 36.7 V meets the jump start, load dump requirements on the positive side and 16-V reverse battery connection on the negative side. During ISO 7637-2 pulse 1 test, the SMBJ33CA clamps at - 44 V with 15 A of peak surge current as shown in [Response to ISO 7637-2 Pulse 1](#) and it meets the clamping voltage $\leq 44 \text{ V}$.

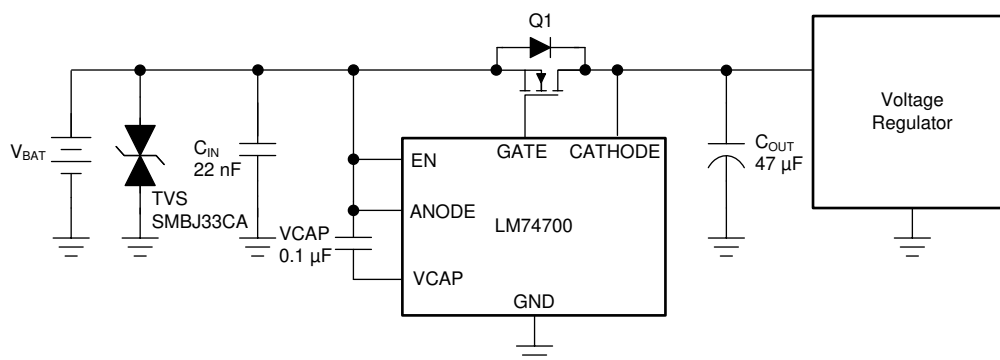
SMBJ series of TVS' are rated up to 600-W peak pulse power levels. This is sufficient for ISO 7637-2 pulses and suppressed load dump (ISO-16750-2 pulse B).

10.1.1.4 Selection of TVS Diodes and MOSFET for 24-V Battery Protection Applications

Typical 24-V battery protection application circuit shown in [图 10-3](#) uses two uni-directional TVS diodes to protect from positive and negative transient voltages.



图 10-3. Typical 24-V Battery Protection with Two Uni-Directional TVS

The breakdown voltage of the TVS+ should be higher than 48-V jump start voltage, less than the absolute maximum ratings of anode and enable pin of LM74700-Q1 (65 V) and should withstand 65-V suppressed load dump. The breakdown voltage of TVS- should be lower than maximum reverse battery voltage - 32 V, so that the TVS- is not damaged due to long time exposure to reverse connected battery.

During ISO 7637-2 pulse 1, the input voltage goes up to - 600 V with a generator impedance of 50 Ω. This translates to 12 A flowing through the TVS-. The clamping voltage of the TVS- cannot be same as that of 12-V battery protection circuit. Because during the ISO 7637-2 pulse, the Anode to Cathode voltage seen is equal to (-TVS Clamping voltage + Output capacitor voltage). For a 24-V battery application, the maximum battery voltage is 32 V, then the clamping voltage of the TVS- should not exceed, 75 V - 32 V = 43 V.

Single bi-directional TVS cannot be used for 24-V battery protection because breakdown voltage for TVS+ \geq 65 V, maximum clamping voltage is \leq 43 V and the clamping voltage cannot be less than the breakdown voltage. Two un-directional TVS connected back-back needs to be used at the input. For positive side TVS+, SMBJ58A with the breakdown voltage of 64.4 V (minimum), 67.8 (typical) is recommended. For the negative side TVS-, SMBJ26A with breakdown voltage close to 32 V (to withstand maximum reverse battery voltage - 32 V) and maximum clamping voltage of 42.1 V is recommended.

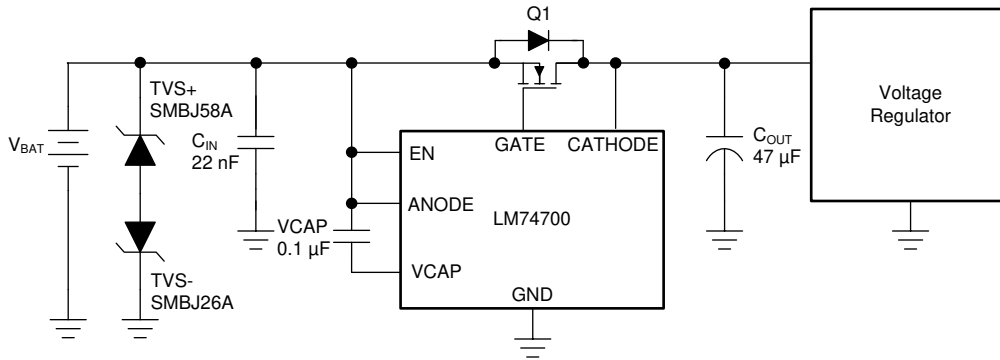
For 24-V battery protection, a 75-V rated MOSFET is recommended to be used along with SMBJ26A and SMBJ58A connected back-back at the input.

10.1.1.5 Application Curves



图 10-4. ISO 7637-2 Pulse 1



图 10-5. Response to ISO 7637-2 Pulse 1

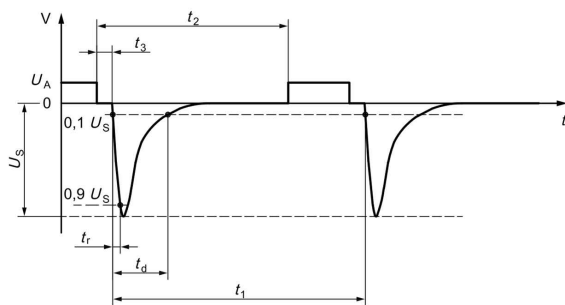

Time (2 ms/DIV)

图 10-6. Startup with 3-A Load

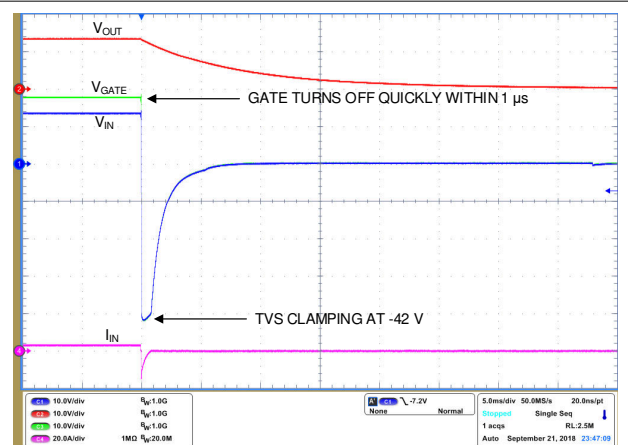
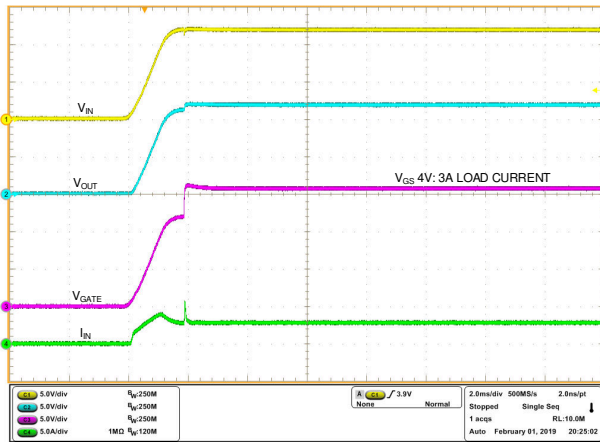
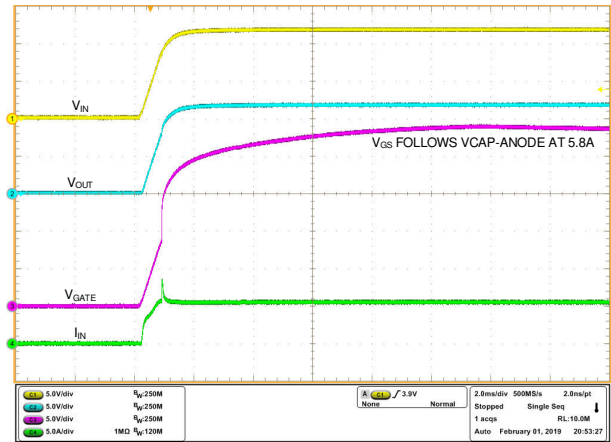

Time (2 ms/DIV)

图 10-7. Startup with 5.8-A Load

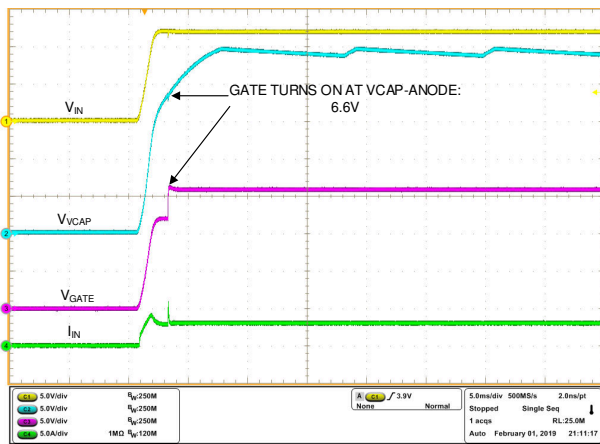

Time (5 ms/DIV)

图 10-8. VCAP During Startup at 3-A Load

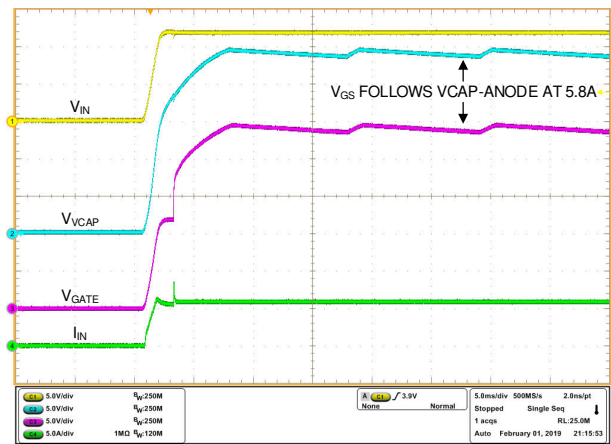

Time (5 ms/DIV)

图 10-9. VCAP During Startup at 5.8-A Load

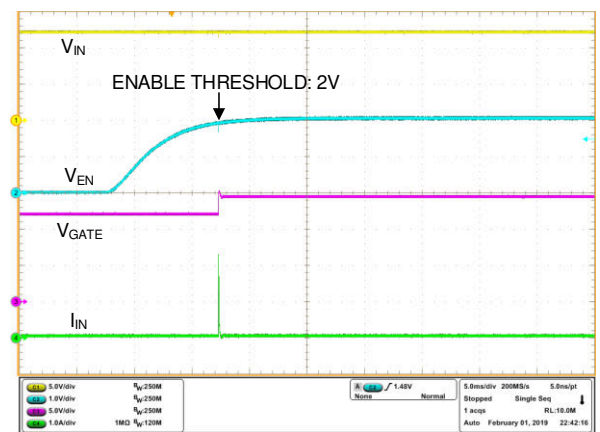

Time (5 ms/DIV)

图 10-10. Enable Threshold

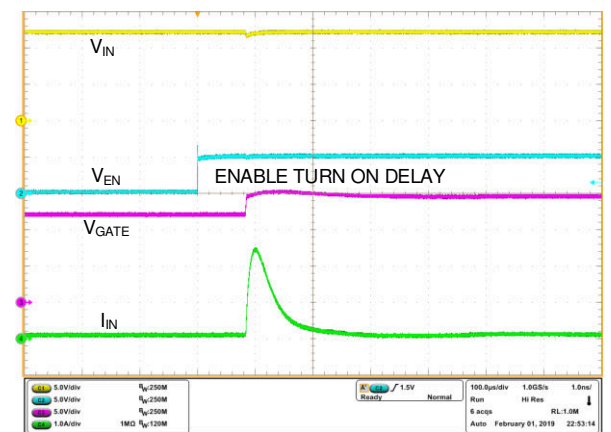

Time (100 μ s/DIV)

图 10-11. Enable Turn ON Delay

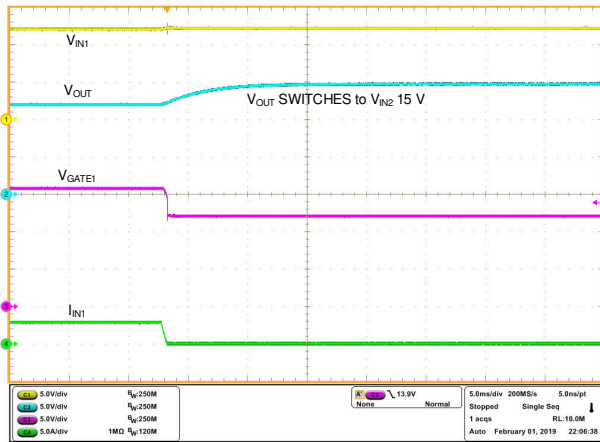

Time (5 ms/DIV)

图 10-12. ORing V_{IN1} to V_{IN2} Switch Over

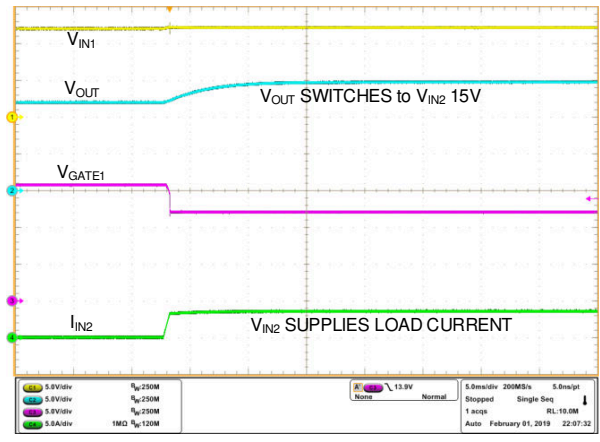

Time (5 ms/DIV)

图 10-13. ORing V_{IN1} to V_{IN2} Switch Over

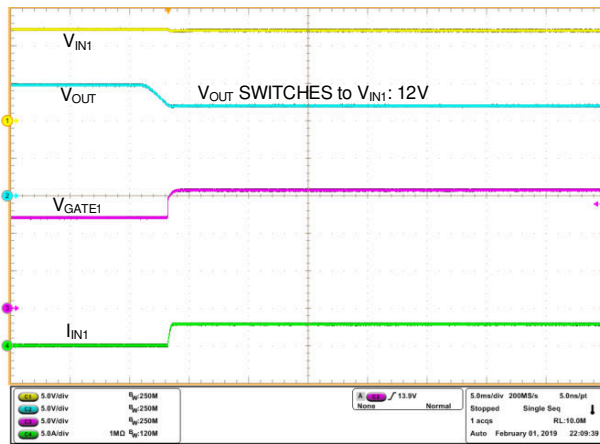

Time (5 ms/DIV)

图 10-14. ORing V_{IN2} to V_{IN1} Switch Over

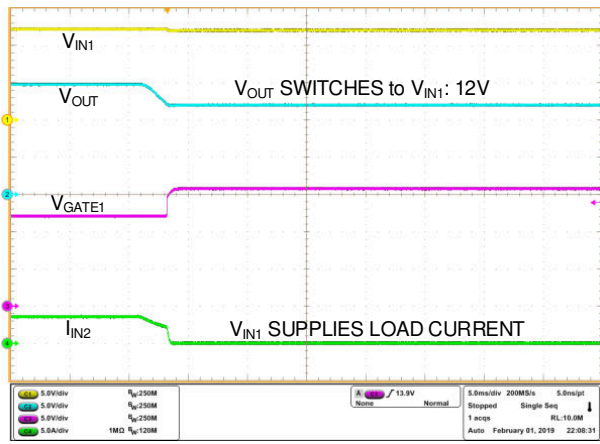

Time (5 ms/DIV)

图 10-15. ORing V_{IN2} to V_{IN1} Switch Over

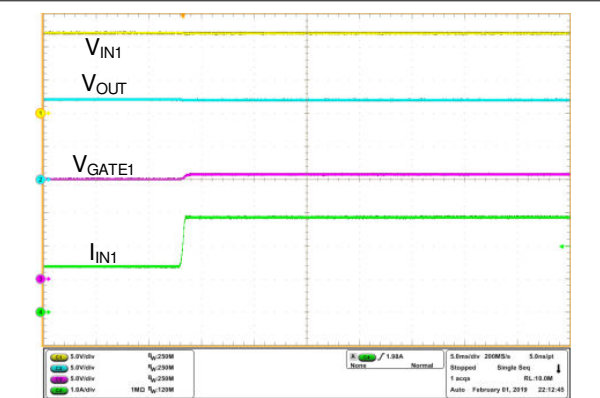

Time (5 ms/DIV)

图 10-16. ORing - V_{IN2} Failure and Switch Over to V_{IN1}

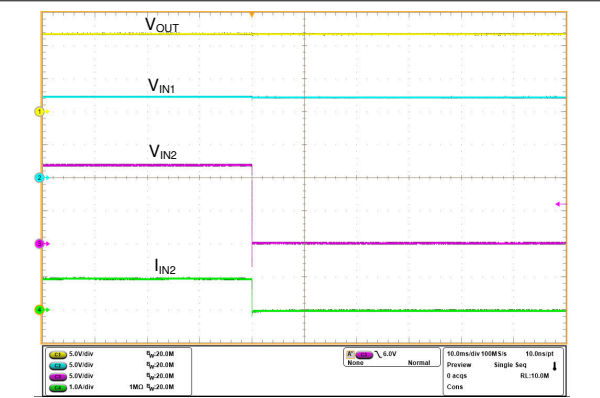

Time (10 ms/DIV)

图 10-17. ORing - V_{IN2} Failure and Switch Over to V_{IN1}

10.2 OR-ing Application Configuration

Basic redundant power architecture comprises of two or more voltage or power supply sources driving a single load. In its simplest form, the OR-ing solution for redundant power supplies consists of Schottky OR-ing diodes

that protect the system against an input power supply fault condition. A diode OR-ing device provides effective and low cost solution with few components. However, the diodes forward voltage drops affects the efficiency of the system permanently, since each diode in an OR-ing application spends most of its time in forward conduction mode. These power losses increase the requirements for thermal management and allocated board space.

The LM74700-Q1 ICs combined with external N-Channel MOSFETs can be used in OR-ing Solution as shown in [Figure 10-18](#). The forward diode drop is reduced as the external N-Channel MOSFET is turned ON during normal operation. LM74700-Q1 quickly detects the reverse current, pulls down the MOSFET gate fast, leaving the body diode of the MOSFET to block the reverse current flow. An effective OR-ing solution needs to be extremely fast to limit the reverse current amount and duration. The LM74700-Q1 devices in OR-ing configuration constantly sense the voltage difference between Anode and Cathode pins, which are the voltage levels at the power sources (V_{IN1} , V_{IN2}) and the common load point respectively. The source to drain voltage V_{DS} for each MOSFET is monitored by the Anode and Cathode pins of the LM74700-Q1. A fast comparator shuts down the Gate Drive through a fast Pull-Down within $0.45 \mu\text{s}$ (typical) as soon as $V_{(IN)} - V_{(OUT)}$ falls below -11 mV . It turns on the Gate with 11-mA gate charge current once the differential forward voltage $V_{(IN)} - V_{(OUT)}$ exceeds 50 mV .



图 10-18. Typical OR-ing Application

ORing V_{IN1} to V_{IN2} Switch Over to ORing V_{IN2} to V_{IN1} Switch Over show the smooth switch over between two power supply rails V_{IN1} at 12 V and V_{IN2} at 15 V. ORing - V_{IN2} Failure and Switch Over to V_{IN1} and ORing - V_{IN2} Failure and Switch Over to V_{IN1} illustrate the performance when V_{IN2} fails. LM74700-Q1 controlling V_{IN2} power rail turns off quickly, so that the output remains uninterrupted and V_{IN1} is protected from V_{IN2} failure.

11 Power Supply Recommendations

The LM74700-Q1 Ideal Diode Controller designed for the supply voltage range of $3.2 \text{ V} \leq V_{ANODE} \leq 65 \text{ V}$. If the input supply is located more than a few inches from the device, an input ceramic bypass capacitor higher than 22 nF is recommended. To prevent LM74700-Q1 and surrounding components from damage under the conditions of a direct output short circuit, it is necessary to use a power supply having over load and short circuit protection.

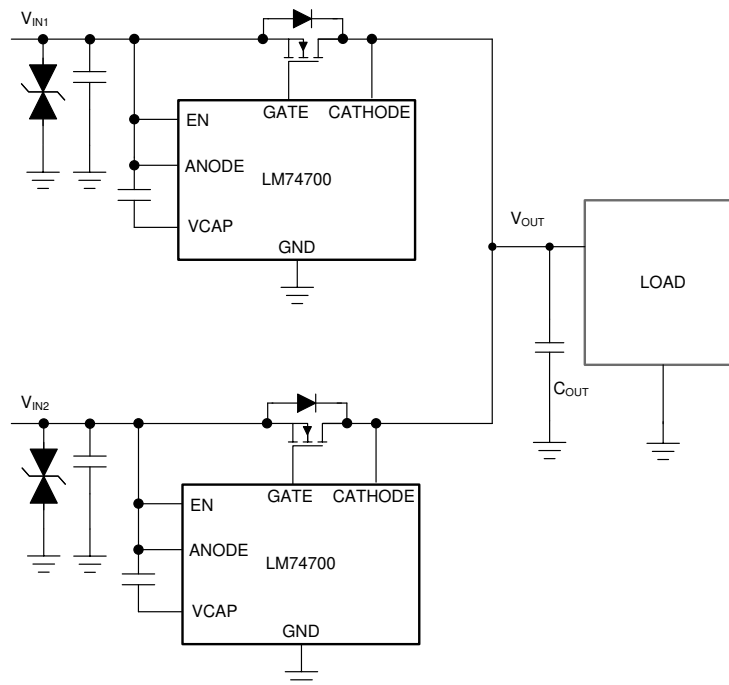
12 Layout

12.1 Layout Guidelines

- Connect ANODE, GATE and CATHODE pins of LM74700-Q1 close to the MOSFET's SOURCE, GATE and DRAIN pins.
- The high current path of for this solution is through the MOSFET, therefore it is important to use thick traces for source and drain of the MOSFET to minimize resistive losses.
- The charge pump capacitor across VCAP and ANODE pins must be kept away from the MOSFET to lower the thermal effects on the capacitance value.
- The Gate pin of the LM74700-Q1 must be connected to the MOSFET gate with short trace. Avoid excessively thin and long trace to the Gate Drive.
- Keep the GATE pin close to the MOSFET to avoid increase in MOSFET turn-off delay due to trace resistance.
- Obtaining acceptable performance with alternate layout schemes is possible, however the layout shown in the [Layout Example](#) is intended as a guideline and to produce good results.

12.2 Layout Example



图 12-1. LM74700-Q1 DBV Package Example Layout



图 12-2. LM74700-Q1 DDF Package Example Layout

13 Device and Documentation Support

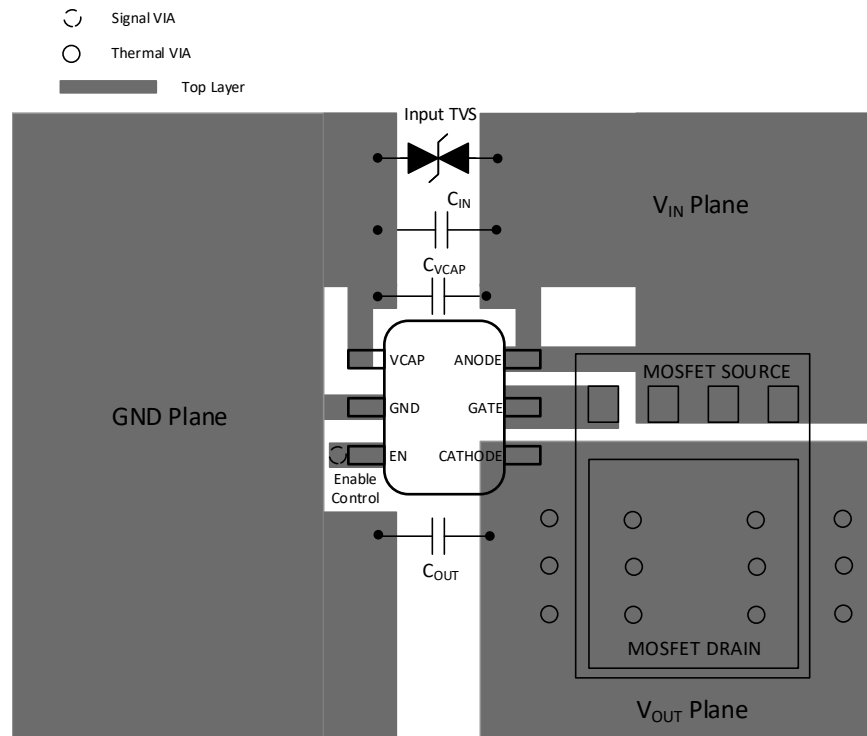
13.1 接收文档更新通知

要接收文档更新通知，请导航至 ti.com 上的器件产品文件夹。点击 [订阅更新](#) 进行注册，即可每周接收产品信息更改摘要。有关更改的详细信息，请查看任何已修订文档中包含的修订历史记录。

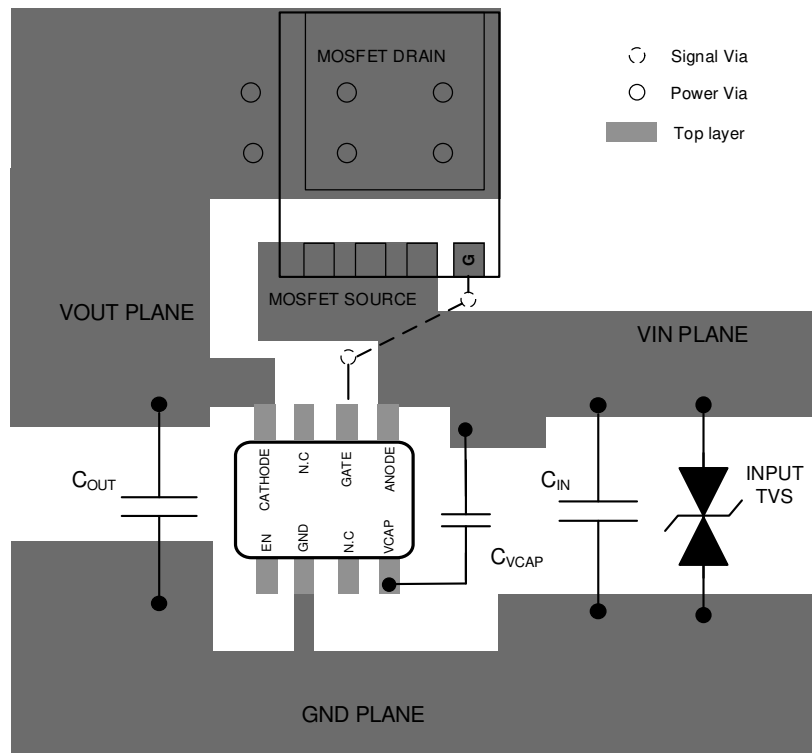
13.2 支持资源

TI E2E™ 支持论坛 是工程师的重要参考资料，可直接从专家获得快速、经过验证的解答和设计帮助。搜索现有解答或提出自己的问题可获得所需的快速设计帮助。

链接的内容由各个贡献者“按原样”提供。这些内容并不构成 TI 技术规范，并且不一定反映 TI 的观点；请参阅 TI 的 [《使用条款》](#)。

13.3 Trademarks

TI E2E™ is a trademark of Texas Instruments.
所有商标均为其各自所有者的财产。

13.4 静电放电警告



静电放电 (ESD) 会损坏这个集成电路。德州仪器 (TI) 建议通过适当的预防措施处理所有集成电路。如果不遵守正确的处理和安装程序，可能会损坏集成电路。

ESD 的损坏小至导致微小的性能降级，大至整个器件故障。精密的集成电路可能更容易受到损坏，这是因为非常细微的参数更改都可能会导致器件与其发布的规格不相符。

13.5 术语表

TI 术语表 本术语表列出并解释了术语、首字母缩略词和定义。

14 Mechanical, Packaging, and Orderable Information

The following pages include mechanical, packaging, and orderable information. This information is the most current data available for the designated devices. This data is subject to change without notice and revision of this document. For browser-based versions of this data sheet, refer to the left-hand navigation.

PACKAGING INFORMATION

Orderable Device	Status (1)	Package Type	Package Drawing	Pins	Package Qty	Eco Plan (2)	Lead finish/ Ball material (6)	MSL Peak Temp (3)	Op Temp (°C)	Device Marking (4/5)	Samples
LM74700QDBVRQ1	ACTIVE	SOT-23	DBV	6	3000	RoHS & Green	NIPDAU	Level-2-260C-1 YEAR	-40 to 125	M747	Samples
LM74700QDBVTQ1	ACTIVE	SOT-23	DBV	6	250	RoHS & Green	NIPDAU	Level-2-260C-1 YEAR	-40 to 125	M747	Samples
LM74700QDDFRQ1	ACTIVE	SOT-23-THIN	DDF	8	3000	RoHS & Green	NIPDAU	Level-1-260C-UNLIM	-40 to 125	747F	Samples

(1) The marketing status values are defined as follows:

ACTIVE: Product device recommended for new designs.

LIFEBUY: TI has announced that the device will be discontinued, and a lifetime-buy period is in effect.

NRND: Not recommended for new designs. Device is in production to support existing customers, but TI does not recommend using this part in a new design.

PREVIEW: Device has been announced but is not in production. Samples may or may not be available.

OBSOLETE: TI has discontinued the production of the device.

(2) **RoHS:** TI defines "RoHS" to mean semiconductor products that are compliant with the current EU RoHS requirements for all 10 RoHS substances, including the requirement that RoHS substance do not exceed 0.1% by weight in homogeneous materials. Where designed to be soldered at high temperatures, "RoHS" products are suitable for use in specified lead-free processes. TI may reference these types of products as "Pb-Free".

RoHS Exempt: TI defines "RoHS Exempt" to mean products that contain lead but are compliant with EU RoHS pursuant to a specific EU RoHS exemption.

Green: TI defines "Green" to mean the content of Chlorine (Cl) and Bromine (Br) based flame retardants meet JS709B low halogen requirements of <=1000ppm threshold. Antimony trioxide based flame retardants must also meet the <=1000ppm threshold requirement.

(3) MSL, Peak Temp. - The Moisture Sensitivity Level rating according to the JEDEC industry standard classifications, and peak solder temperature.

(4) There may be additional marking, which relates to the logo, the lot trace code information, or the environmental category on the device.

(5) Multiple Device Markings will be inside parentheses. Only one Device Marking contained in parentheses and separated by a "~" will appear on a device. If a line is indented then it is a continuation of the previous line and the two combined represent the entire Device Marking for that device.

(6) Lead finish/Ball material - Orderable Devices may have multiple material finish options. Finish options are separated by a vertical ruled line. Lead finish/Ball material values may wrap to two lines if the finish value exceeds the maximum column width.

Important Information and Disclaimer:The information provided on this page represents TI's knowledge and belief as of the date that it is provided. TI bases its knowledge and belief on information provided by third parties, and makes no representation or warranty as to the accuracy of such information. Efforts are underway to better integrate information from third parties. TI has taken and continues to take reasonable steps to provide representative and accurate information but may not have conducted destructive testing or chemical analysis on incoming materials and chemicals. TI and TI suppliers consider certain information to be proprietary, and thus CAS numbers and other limited information may not be available for release.

In no event shall TI's liability arising out of such information exceed the total purchase price of the TI part(s) at issue in this document sold by TI to Customer on an annual basis.

TAPE AND REEL INFORMATION



QUADRANT ASSIGNMENTS FOR PIN 1 ORIENTATION IN TAPE



*All dimensions are nominal

Device	Package Type	Package Drawing	Pins	SPQ	Reel Diameter (mm)	Reel Width W1 (mm)	A0 (mm)	B0 (mm)	K0 (mm)	P1 (mm)	W (mm)	Pin1 Quadrant
LM74700QDBVRQ1	SOT-23	DBV	6	3000	180.0	8.4	3.2	3.2	1.4	4.0	8.0	Q3
LM74700QDBVTQ1	SOT-23	DBV	6	250	180.0	8.4	3.2	3.2	1.4	4.0	8.0	Q3
LM74700QDDFRQ1	SOT-23-THIN	DDF	8	3000	180.0	8.4	3.2	3.2	1.4	4.0	8.0	Q3

TAPE AND REEL BOX DIMENSIONS

*All dimensions are nominal

Device	Package Type	Package Drawing	Pins	SPQ	Length (mm)	Width (mm)	Height (mm)
LM74700QDBVRQ1	SOT-23	DBV	6	3000	213.0	191.0	35.0
LM74700QDBVTQ1	SOT-23	DBV	6	250	213.0	191.0	35.0
LM74700QDDFRQ1	SOT-23-THIN	DDF	8	3000	210.0	185.0	35.0

DBV0006A



PACKAGE OUTLINE

SOT-23 - 1.45 mm max height

SMALL OUTLINE TRANSISTOR



NOTES:

1. All linear dimensions are in millimeters. Any dimensions in parenthesis are for reference only. Dimensioning and tolerancing per ASME Y14.5M.
2. This drawing is subject to change without notice.
3. Body dimensions do not include mold flash or protrusion. Mold flash and protrusion shall not exceed 0.25 per side.
4. Leads 1,2,3 may be wider than leads 4,5,6 for package orientation.
5. Reference JEDEC MO-178.

EXAMPLE BOARD LAYOUT

DBV0006A

SOT-23 - 1.45 mm max height

SMALL OUTLINE TRANSISTOR



LAND PATTERN EXAMPLE
EXPOSED METAL SHOWN
SCALE:15X



SOLDER MASK DETAILS

4214840/C 06/2021

NOTES: (continued)

- 6. Publication IPC-7351 may have alternate designs.
- 7. Solder mask tolerances between and around signal pads can vary based on board fabrication site.

EXAMPLE STENCIL DESIGN

DBV0006A

SOT-23 - 1.45 mm max height

SMALL OUTLINE TRANSISTOR



SOLDER PASTE EXAMPLE
BASED ON 0.125 mm THICK STENCIL
SCALE:15X

4214840/C 06/2021

NOTES: (continued)

8. Laser cutting apertures with trapezoidal walls and rounded corners may offer better paste release. IPC-7525 may have alternate design recommendations.
9. Board assembly site may have different recommendations for stencil design.

EXAMPLE BOARD LAYOUT

DDF0008A

SOT-23 - 1.1 mm max height

PLASTIC SMALL OUTLINE

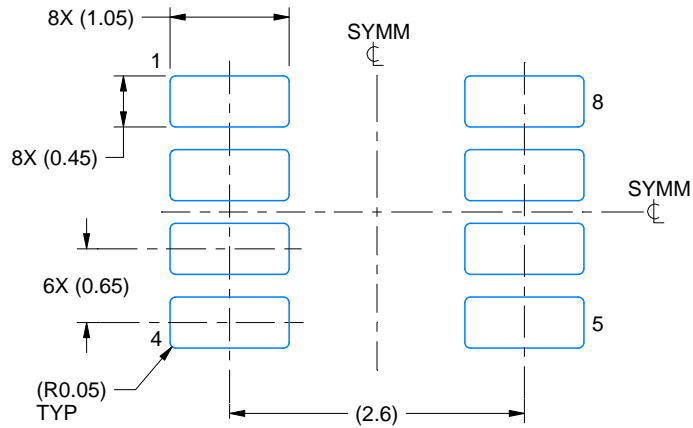

LAND PATTERN EXAMPLE
SCALE:15X

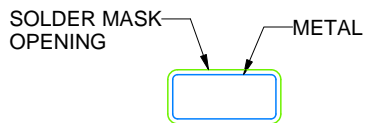

NON SOLDER MASK
DEFINED

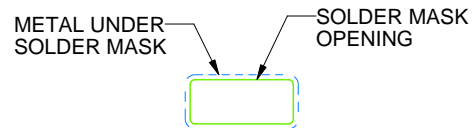

SOLDER MASK
DEFINED

SOLDER MASK DETAILS

4222047/C 10/2022

NOTES: (continued)

- 4. Publication IPC-7351 may have alternate designs.
- 5. Solder mask tolerances between and around signal pads can vary based on board fabrication site.

EXAMPLE STENCIL DESIGN

DDF0008A

SOT-23 - 1.1 mm max height

PLASTIC SMALL OUTLINE



SOLDER PASTE EXAMPLE
BASED ON 0.125 mm THICK STENCIL
SCALE:15X

4222047/C 10/2022

NOTES: (continued)

6. Laser cutting apertures with trapezoidal walls and rounded corners may offer better paste release. IPC-7525 may have alternate design recommendations.
7. Board assembly site may have different recommendations for stencil design.

重要声明和免责声明

TI“按原样”提供技术和可靠性数据（包括数据表）、设计资源（包括参考设计）、应用或其他设计建议、网络工具、安全信息和其他资源，不保证没有瑕疵且不做任何明示或暗示的担保，包括但不限于对适销性、某特定用途方面的适用性或不侵犯任何第三方知识产权的暗示担保。

这些资源可供使用 TI 产品进行设计的熟练开发人员使用。您将自行承担以下全部责任：(1) 针对您的应用选择合适的 TI 产品，(2) 设计、验证并测试您的应用，(3) 确保您的应用满足相应标准以及任何其他功能安全、信息安全、监管或其他要求。

这些资源如有变更，恕不另行通知。TI 授权您仅可将这些资源用于研发本资源所述的 TI 产品的应用。严禁对这些资源进行其他复制或展示。您无权使用任何其他 TI 知识产权或任何第三方知识产权。您应全额赔偿因在这些资源的使用中对 TI 及其代表造成的任何索赔、损害、成本、损失和债务，TI 对此概不负责。

TI 提供的产品受 [TI 的销售条款](#) 或 [ti.com](#) 上其他适用条款/TI 产品随附的其他适用条款的约束。TI 提供这些资源并不会扩展或以其他方式更改 TI 针对 TI 产品发布的适用的担保或担保免责声明。

TI 反对并拒绝您可能提出的任何其他或不同的条款。

邮寄地址：Texas Instruments, Post Office Box 655303, Dallas, Texas 75265

Copyright © 2022，德州仪器 (TI) 公司