

# 具有负载突降保护和 I<sup>2</sup>C 诊断功能的 TAS6421-Q1 75W、2MHz 数字输入单通道汽车用 D 类 Burr-Brown™ 音频放大器



Texas Instruments  
Burr-Brown Audio

## 1 特性

- 高级负载诊断功能
  - 直流诊断功能，无需输入时钟即可执行
  - 交流诊断功能，可通过阻抗和相位响应实现高频扬声器检测
- 可轻松满足 CISPR25-L5 EMC 规范
- 符合面向汽车应用的 AEC-Q100 标准
  - 温度等级：-40°C 至 +125°C
- 音频输入
  - I<sup>2</sup>S 或 4/8 通道 TDM 输入
  - 输入采样率：44.1kHz、48kHz、96kHz
  - 输入格式：16 位至 32 位 I<sup>2</sup>S 和 TDM
- 音频输出
  - 单通道桥接式负载 (BTL)
  - 最高可达 2.1MHz 的输出开关频率
  - 在 4Ω 负载、14.4V BTL 条件下，输出功率为 27W，THD 为 10%
  - 在 2Ω 负载、14.4V BTL 条件下，输出功率为 45W，THD 为 10%
- 在 4Ω 负载、14.4V BTL 条件下的音频性能
  - 输出功率为 1W 时，THD+N < 0.02%
  - 42μV<sub>RMS</sub> 输出噪声
  - -90dB 串扰
- 负载诊断，独立于主机运行
  - 开路和短路输出负载
  - 输出至电池短路或接地短路
  - 线路输出检测高达 6kΩ
- 保护
  - 输出电流限制和短路保护
  - 40V 负载突降
  - 可承受接地开路和电源开路
  - 过热警告和关断
  - 欠压和过压，直流偏移
- 常规运行
  - 4.5V 至 26.4V 电源电压
  - I<sup>2</sup>C 控制，具有 4 个地址选项
  - 削波检测（自锁或非自锁）

## 2 应用

- 汽车音响主机和外部放大器
- 紧急呼叫 (eCall)
- 虚拟引擎声浪系统 (VESS)

## 3 说明

TAS6421-Q1 器件是一款单通道数字输入 D 类 Burr-Brown™ 音频放大器，采用了 2.1MHz PWM 开关频率，能以非常小的 PCB 尺寸实现成本优化的解决方案，可针对启停事件在低至 4.5V 的电压下全面运行，并可在高达 40kHz 的音频带宽下提供出色的音质。TAS6421-Q1 的尺寸和引脚与 TAS642x-Q1 系列器件兼容，实现了灵活性，只需进行极少的重新设计即可轻松支持多种系统配置。

输出开关频率既可以设置为高于调幅 (AM) 频带，以消除 AM 频带干扰并降低输出滤波需求及成本；也可以设置为低于 AM 频带，以优化器件效率。该器件具有内置负载诊断功能，用于检测和诊断误接的输出，以及检测交流耦合的高频扬声器。

器件信息<sup>(1)</sup>

器件型号	封装	封装尺寸 (标称值)
TAS6421-Q1	HSSOP (56)	18.41mm x 7.49mm

(1) 如需了解所有可用封装，请参阅数据表末尾的可订购产品附录。

功能方框图

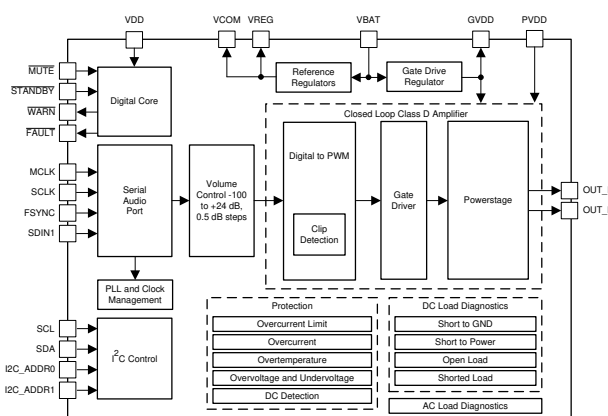

## 目录

<b>1 特性</b> ..... 1 <b>2 应用</b> ..... 1 <b>3 说明</b> ..... 1 <b>4 修订历史记录</b> ..... 2 <b>5 说明 (续)</b> ..... 3 <b>6 Device Options</b> ..... 4 <b>7 Pin Configuration and Functions</b> ..... 5 <b>8 Specifications</b> ..... 7 8.1 Absolute Maximum Ratings ..... 7 8.2 ESD Ratings ..... 7 8.3 Recommended Operating Conditions ..... 8 8.4 Thermal Information ..... 8 8.5 Electrical Characteristics ..... 9 8.6 Typical Characteristics ..... 13 <b>9 Parameter Measurement Information</b> ..... 17 <b>10 Detailed description</b> ..... 18 10.1 Overview ..... 18 10.2 Functional Block Diagram ..... 18	10.3 Feature Description ..... 19 10.4 Device Functional Modes ..... 29 10.5 Programming ..... 30 10.6 Register Maps ..... 33 <b>11 Application and Implementation</b> ..... 47 11.1 Application Information ..... 47 11.2 Typical Applications ..... 48 <b>12 Power Supply Recommendations</b> ..... 51 <b>13 Layout</b> ..... 51 13.1 Layout Guidelines ..... 51 13.2 Layout Example ..... 52 13.3 Thermal Considerations ..... 52 <b>14 器件和文档支持</b> ..... 54 14.1 文档支持 ..... 54 14.2 接收文档更新通知 ..... 54 14.3 社区资源 ..... 54 14.4 商标 ..... 54 14.5 静电放电警告 ..... 54 14.6 Glossary ..... 54
---	---

## 4 修订历史记录

注：之前版本的页码可能与当前版本有所不同。

### Changes from Original (April 2019) to Revision A

Page

<ul style="list-style-type: none"> <li>• 将器件状态从预告信息 更改为生产 数据..... 1</li> </ul>	1
--	---

## 5 说明 (续)

在 14.4V 电源电压条件下，当负载为  $4\Omega$ 、THD+N 为 10% 时，TAS6421-Q1 可提供单通道的 27W 输出功率；当负载为  $2\Omega$ 、THD+N 为 10% 时，可提供 45W 的输出功率。在 25V 电源电压条件下，当负载为  $4\Omega$ 、THD+N 为 10% 时，此器件可提供 75W 的输出功率。

有关兼容引脚的双通道和四通道器件，请参阅 [TAS6422-Q1](#)、[TAS6424L-Q1](#)、[TAS6424M-Q1](#) 和 [TAS6424-Q1](#)。

## 6 Device Options

Part Number	Channel Count	Power-Supply Voltage Range	Channel Current Limit (Typ)	Output Power per channel / 10% THD			
				4 $\Omega$ / BTL 14.4 V	4 $\Omega$ / BTL Max Voltage	2 $\Omega$ / BTL 14.4 V	2 $\Omega$ / PBTL Max Voltage
TAS6424-Q1	4	4.5 V to 26.4 V	6.5 A	27 W	75 W at 25 V	45 W	150 W at 25 V
TAS6424M-Q1	4	4.5 V to 18 V	6.5 A	27 W	45 W at 18 V	45 W	80 W at 18 V
TAS6424L-Q1	4	4.5 V to 18 V	4.8 A	27 W	45 W at 18 V	27 W	80 W at 18 V
TAS6422-Q1	2	4.5 V to 26.4 V	6.5 A	27 W	75 W at 25 V	45 W	150 W at 25 V
TAS6421-Q1	1	4.5 V to 26.4 V	6.5 A	27 W	75 W at 25 V	45 W	N/A

## 7 Pin Configuration and Functions

**DKQ Package  
56-Pin HSSOP With Exposed Thermal Pad  
Top View**

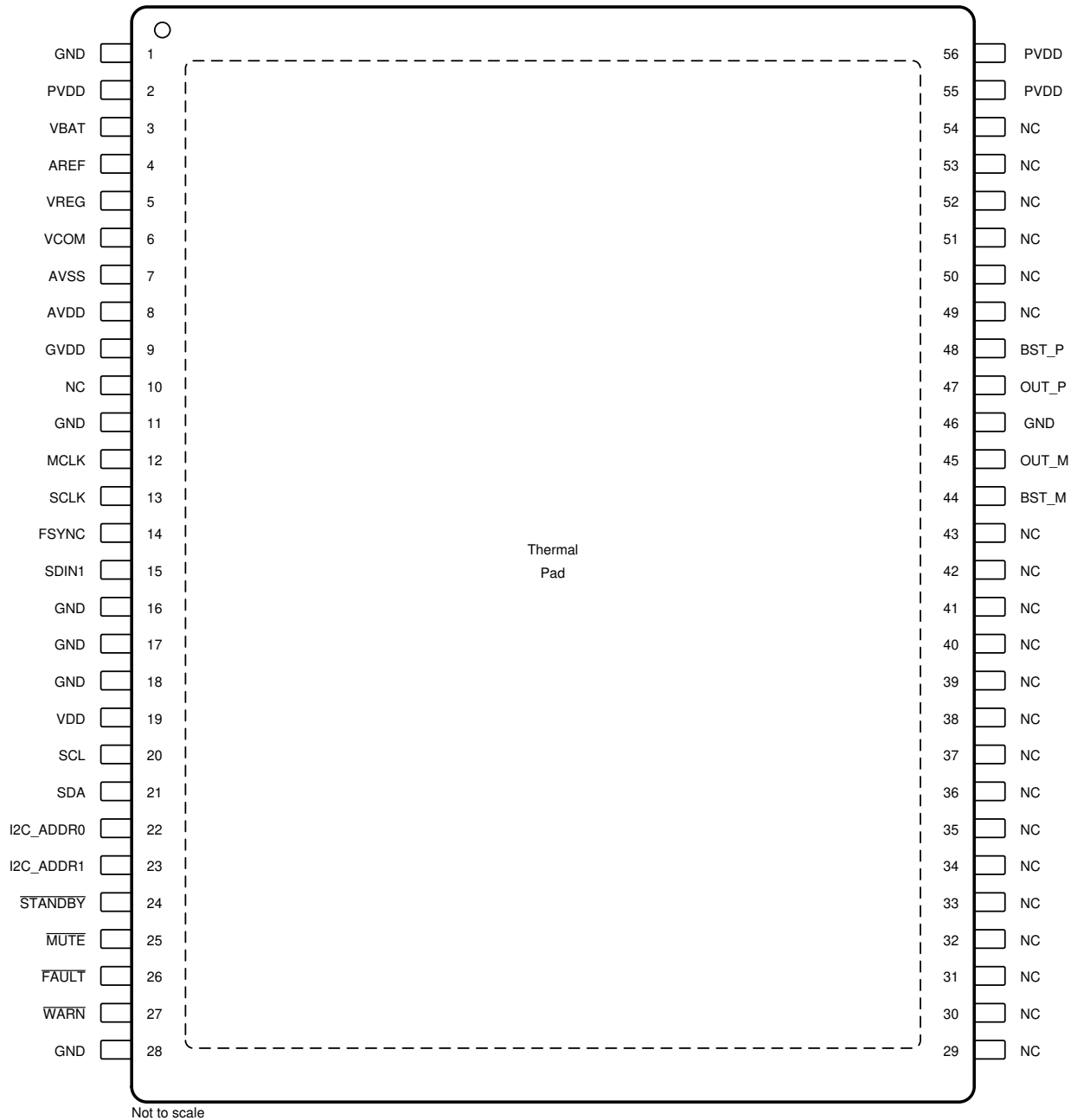

### Pin Functions

PIN		TYPE <sup>(1)</sup>	DESCRIPTION
NAME	NO.		
AREF	4	PWR	VREG and VCOM bypass capacitor return
AVDD	8	PWR	Voltage regulator bypass. Connect 1 $\mu$ F capacitor from AVDD to AVSS
AVSS	7	PWR	AVDD bypass capacitor return
BST_M	44	PWR	Bootstrap capacitor connection pin for high-side gate driver
BST_P	48	PWR	Bootstrap capacitor connection pin for high-side gate driver
$\overline{\text{FAULT}}$	26	DO	Reports a fault (active low, open drain), 100 k $\Omega$ internal pull-up resistor
FSYNC	14	DI	Audio frame clock input
GND	1, 11, 16, 17, 18, 28, 46	GND	Ground
GVDD	9	PWR	Gate drive voltage regulator derived from VBAT input pin. Connect 2.2 $\mu$ F capacitor to GND
I2C_ADDR0	22	DI	I <sup>2</sup> C address pins. Refer to 表 7
I2C_ADDR1	23		
MCLK	12	DI	Audio master clock input
$\overline{\text{MUTE}}$	25	DI	Mutes the device outputs (active low) while keeping output FETs switching at 50%, 100 k $\Omega$ internal pull-down resistor
NC	10, 29-43, 49-54	NC	Not connected or pulled to ground
OUT_M	45	NO	Negative output for the channel
OUT_P	47	PO	Positive output for the channel
PVDD	2, 55, 56	PWR	PVDD voltage input (can be connected to battery). Bulk capacitor and bypass capacitor required
SCL	20	DI	I <sup>2</sup> C clock input
SCLK	13	DI	Audio bit and serial clock input
SDA	21	DI/DO	I <sup>2</sup> C data input and output
SDIN1	15	DI	TDM data input and audio I <sup>2</sup> S data input
$\overline{\text{STANDBY}}$	24	DI	Enables low power standby state (active Low), 100 k $\Omega$ internal pull-down resistor
VBAT	3	PWR	Battery voltage input
VCOM	6	PWR	Bias voltage
VDD	19	PWR	3.3 V external supply voltage
VREG	5	PWR	Voltage regulator bypass
$\overline{\text{WARN}}$	27	DO	Clip and overtemperature warning (active low, open drain), 100 k $\Omega$ internal pull-up resistor
Thermal Pad	—	GND	Provides both electrical and thermal connection for the device. Heatsink must be connected to GND.

(1) GND = ground, PWR = power, PO = positive output, NO = negative output, DI = digital input, DO = digital output, DI/DO = digital input and output, NC = no connection

## 8 Specifications

### 8.1 Absolute Maximum Ratings

over operating free-air temperature range (unless otherwise noted)<sup>(1)</sup>

		MIN	MAX	UNIT
PVDD, VBAT	DC supply voltage relative to GND	-0.3	30	V
V <sub>MAX</sub>	Transient supply voltage: PVDD, VBAT	-1	40	V
V <sub>RAMP</sub>	Supply-voltage ramp rate: PVDD, VBAT		75	V/ms
VDD	DC supply voltage relative to GND	-0.3	3.5	V
I <sub>MAX</sub>	Maximum current per pin (PVDD, VBAT, OUT_P, OUT_M, GND)		8	A
I <sub>MAX_PULSED</sub>	Pulsed supply current per PVDD pin (one shot)		12	A
V <sub>LOGIC</sub>	Input voltage for logic pins (SCL, SDA, SDIN1, FSYNC, MCLK, BCLK, SCLK, MUTE, STANDBY, I2C_ADDRx)	-0.3	VDD + 0.5	V
V <sub>GND</sub>	Maximum voltage between GND pins	-0.3	0.3	V
T <sub>J</sub>	Maximum operating junction temperature	-55	150	°C
T <sub>stg</sub>	Storage temperature	-55	150	°C

(1) Stresses beyond those listed under Absolute Maximum Ratings may cause permanent damage to the device. These are stress ratings only, which do not imply functional operation of the device at these or any other conditions beyond those indicated under Recommended Operating Conditions. Exposure to absolute-maximum-rated conditions for extended periods may affect device reliability.

### 8.2 ESD Ratings

		VALUE	UNIT
V <sub>(ESD)</sub>	Electrostatic discharge	Human-body model (HBM), per AEC Q100-002 <sup>(1)</sup> HBM ESD Classification Level 2	±3000
		Charged-device model (CDM), per AEC Q100-011 CDM ESD Classification Level C4B	±500
		Corner pins (1, 28, 29 and 56)	±750

(1) (1) AEC Q100-002 indicates that HBM stressing shall be in accordance with the ANSI/ESDA/JEDEC JS-001 specification.

### 8.3 Recommended Operating Conditions

			MIN	TYP	MAX	UNIT
PVDD	Output FET Supply Voltage Range	Relative to GND	4.5		26.4	V
VBAT	Battery Supply Voltage Input	Relative to GND	4.5	14.4	18	
VDD	DC Logic supply	Relative to GND	3.0	3.3	3.5	
T <sub>A</sub>	Ambient temperature		–40		125	°C
T <sub>J</sub>	Junction temperature	An adequate thermal design is required	–40		150	
R <sub>L</sub>	Minimum speaker load impedance	BTL Mode	2	4		Ω
R <sub>PU_I2C</sub>	I <sup>2</sup> C pullup resistance on SDA and SCL pins		1	4.7	10	kΩ
C <sub>Bypass</sub>	External capacitance on bypass pins	Pin 2, 3, 5, 6, 8, 19		1		μF
C <sub>GVDD</sub>	External capacitance on GVDD pin	Pin 9		2.2		μF
C <sub>OUT</sub>	External capacitance to GND on OUT pins	Limit set by DC-diagnostic timing		1	3.3	μF
L <sub>O</sub>	Output filter inductance at 2.1MHz	Minimum inductance at I <sub>SD</sub> current levels	1			μH

### 8.4 Thermal Information

THERMAL METRIC <sup>(1)</sup>		TAS6421-Q1 <sup>(2)</sup>	
		DKQ (HSSOP)	
		56 PINS	UNIT
R <sub>θJA</sub>	Junction-to-ambient thermal resistance	42.8	°C/W
R <sub>θJC(top)</sub>	Junction-to-case (top) thermal resistance	0.9	°C/W
R <sub>θJB</sub>	Junction-to-board thermal resistance	21.2	°C/W
Ψ <sub>JT</sub>	Junction-to-top characterization parameter	0.5	°C/W
Ψ <sub>JB</sub>	Junction-to-board characterization parameter	20.2	°C/W
R <sub>θJC(bot)</sub>	Junction-to-case (bottom) thermal resistance	-	°C/W

(1) For more information about traditional and new thermal metrics, see the [Semiconductor and IC Package Thermal Metrics](#) application report, SPRA953.

(2) JEDEC Standard 4 Layer PCB.



## 8.5 Electrical Characteristics

Test conditions (unless otherwise noted):  $T_C = 25^\circ\text{C}$ ,  $PVDD = VBAT = 14.4\text{ V}$ ,  $VDD = 3.3\text{ V}$ ,  $R_L = 4\ \Omega$ ,  $P_{out} = 1\text{ W/ch}$ ,  $f_{IN} = 1\text{ kHz}$ ,  $f_{SW} = 2.11\text{ MHz}$ , AES17 Filter, default I2C settings

PARAMETER		TEST CONDITIONS	MIN	TYP	MAX	UNIT
<b>OPERATING CURRENT</b>						
$I_{PVDD\_IDLE}$	PVDD idle current	Channel playing, no audio input		17	23	mA
$I_{VBAT\_IDLE}$	VBAT idle current	Channel playing, no audio input		28	32	mA
$I_{PVDD\_STBY}$	PVDD standby current	STANDBY Active, $VDD = 0\text{ V}$		0.5	1	$\mu\text{A}$
$I_{VBAT\_STBY}$	VBAT standby current	STANDBY Active, $VDD = 0\text{ V}$		4	6	$\mu\text{A}$
$I_{VDD}$	VDD supply current	Channel playing, $-60\text{-dB}$ signal		15	18	mA
<b>OUTPUT POWER</b>						
$P_{O\_BTL}$	Output power per channel, BTL	4 $\Omega$ , $PVDD = 14.4\text{ V}$ , THD+N = 1%, $TC = 75^\circ\text{C}$	20	22		W
		4 $\Omega$ , $PVDD = 14.4\text{ V}$ , THD+N = 10%, $TC = 75^\circ\text{C}$	25	27		
		2 $\Omega$ , $PVDD = 14.4\text{ V}$ , THD+N = 1%, $TC = 75^\circ\text{C}$	38	40		
		2 $\Omega$ , $PVDD = 14.4\text{ V}$ , THD+N = 10%, $TC = 75^\circ\text{C}$	42	45		
		4 $\Omega$ , $PVDD = 25\text{ V}$ , THD+N = 1%, $TC = 75^\circ\text{C}$	50	55		
		4 $\Omega$ , $PVDD = 25\text{ V}$ , THD+N = 10%, $TC = 75^\circ\text{C}$	70	75		
$EFF_P$	Power efficiency	1 channel operating at 25-W output power, 4 $\Omega$ load, $PVDD = 14.4\text{ V}$ , $TC = 25^\circ\text{C}$ , including inductor losses		86%		
<b>AUDIO PERFORMANCE</b>						
$V_n$	Output noise voltage	Zero input, A-weighting, gain level 1, $PVDD = 14.4\text{ V}$		42		$\mu\text{V}$
		Zero input, A-weighting, gain level 2, $PVDD = 14.4\text{ V}$		55		
		Zero input, A-weighting, gain level 3, $PVDD = 18\text{ V}$		67		
		Zero input, A-weighting, gain level 4, $PVDD = 25\text{ V}$		85		
GAIN	Peak Output Voltage/dBFS	gain level 1, Register 0x01, bit 1-0 = 00		7.5		V/FS
		gain level 2, Register 0x01, bit 1-0 = 01		15		
		gain level 3, Register 0x01, bit 1-0 = 10		21		
		gain level 4, Register 0x01, bit 1-0 = 11		29		
PSRR	Power-supply rejection ratio	$PVDD = 14.4\text{ Vdc} + 1\text{ V}_{RMS}$ , $f = 1\text{ kHz}$		75		dB
THD+N	Total harmonic distortion + noise			0.02%		
<b>LINE OUTPUT PERFORMANCE</b>						
$V_{n\_LINEOUT}$	LINE output noise voltage	Zero input, A-weighting, channel set to LINE MODE		42		$\mu\text{V}$
$V_{O\_LINEOUT}$	LINE output voltage	0dB input, channel set to LINE MODE		5.5		VRMS
THD+N	Line output total harmonic distortion + noise	$V_O = 2\text{ V}_{RMS}$ , channel set to LINE MODE		0.01%		
<b>DIGITAL INPUT PINS</b>						
$V_{IH}$	Input logic level high		70			%VDD
$V_{IL}$	Input logic level low			30		%VDD
$I_{IH}$	Input logic current, high	$V_I = VDD$			15	$\mu\text{A}$
$I_{IL}$	Input logic current, low	$V_I = 0$			-15	$\mu\text{A}$
<b>PWM OUTPUT STAGE</b>						
$R_{DS(on)}$	FET drain-to-source resistance	Not including bond wire and package resistance		90		m $\Omega$
<b>OVERVOLTAGE (OV) PROTECTION</b>						
$V_{PVDD\_OV}$	PVDD overvoltage shutdown		27.0	27.8	28.8	V

## Electrical Characteristics (continued)

Test conditions (unless otherwise noted):  $T_C = 25^\circ\text{C}$ ,  $PVDD = VBAT = 14.4\text{ V}$ ,  $VDD = 3.3\text{ V}$ ,  $R_L = 4\ \Omega$ ,  $P_{out} = 1\text{ W/ch}$ ,  $f_{IN} = 1\text{ kHz}$ ,  $f_{SW} = 2.11\text{ MHz}$ , AES17 Filter, default I2C settings

PARAMETER		TEST CONDITIONS	MIN	TYP	MAX	UNIT
$V_{PVDD\_OV\_HYS}$	PVDD overvoltage shutdown hysteresis			0.8		V
$V_{VBAT\_OV}$	VBAT overvoltage shutdown		20	21.5	23	V
$V_{VBAT\_OV\_HYS}$	VBAT overvoltage shutdown hysteresis			0.6		V
<b>UNDERVOLTAGE (UV) PROTECTION</b>						
$VBAT_{UV}$	VBAT undervoltage shutdown			4	4.5	V
$VBAT_{UV\_HYS}$	VBAT undervoltage shutdown hysteresis			0.2		V
$PVDD_{UV}$	PVDD undervoltage shutdown			4	4.5	V
$PVDD_{UV\_HYS}$	PVDD undervoltage shutdown hysteresis			0.2		V
<b>BYPASS VOLTAGES</b>						
$V_{GVDD}$	Gate drive bypass pin voltage			7		V
$V_{AVDD}$	Analog bypass pin voltage			6		V
$V_{VCOM}$	Common bypass pin voltage			2.5		V
$V_{VREG}$	Regulator bypass pin voltage			5.5		V
<b>POWER-ON RESET (POR)</b>						
$V_{POR}$	VDD voltage for POR			2.1	2.7	V
$V_{POR\_HYS}$	VDD POR recovery hysteresis voltage			0.5		V
<b>OVERTEMPERATURE (OT) PROTECTION</b>						
$OTW_{(i)}$	Channel overtemperature warning			150		$^\circ\text{C}$
$OTSD_{(i)}$	Channel overtemperature shutdown			175		$^\circ\text{C}$
OTW	Global junction overtemperature warning			130		$^\circ\text{C}$
OTSD	Global junction overtemperature shutdown			160		$^\circ\text{C}$
$OT_{HYS}$	Overtemperature hysteresis			15		$^\circ\text{C}$
<b>LOAD OVERCURRENT PROTECTION</b>						
$I_{LIM}$	Overcurrent cycle-by-cycle limit	OC Level 1	4.0	4.8		A
		OC Level 2	6.0	6.5		A
$I_{SD}$	Overcurrent shutdown	OC Level 1, Any short to supply, ground, or other channels		7		A
		OC Level 2, Any short to supply, ground, or other channels		9		A
<b>MUTE MODE</b>						
$G_{MUTE}$	Output attenuation			100		dB
<b>CLICK AND POP</b>						
$V_{CP}$	Output click and pop voltage	ITU-R 2k filter, High-Z/MUTE to Play, Play to Mute/High-Z		7		mV
<b>DC OFFSET</b>						
$V_{OFFSET}$	Output offset voltage			2	5	mV
<b>DC DETECT</b>						
$DC_{FAULT}$	Output DC fault protection			2	2.5	V
<b>DIGITAL OUTPUT PINS</b>						
$V_{OH}$	Output voltage for logic level high	$I = \pm 2\text{ mA}$	90			%VDD
$V_{OL}$	Output voltage for logic level low	$I = \pm 2\text{ mA}$			10	%VDD
$t_{DELAY\_CLIPDET}$	Signal delay when output clipping detected			20		$\mu\text{s}$

## Electrical Characteristics (continued)

Test conditions (unless otherwise noted):  $T_C = 25^\circ\text{C}$ ,  $PVDD = VBAT = 14.4\text{ V}$ ,  $VDD = 3.3\text{ V}$ ,  $R_L = 4\ \Omega$ ,  $P_{out} = 1\text{ W/ch}$ ,  $f_{IN} = 1\text{ kHz}$ ,  $f_{SW} = 2.11\text{ MHz}$ , AES17 Filter, default I2C settings

PARAMETER		TEST CONDITIONS	MIN	TYP	MAX	UNIT
<b>LOAD DIAGNOSTICS</b>						
S2P	Resistance to detect a short from OUT pin(s) to PVDD				500	$\Omega$
S2G	Resistance to detect a short from OUT pin(s) to ground				200	$\Omega$
SL	Shorted load detection tolerance				$\pm 0.5$	$\Omega$
OL	Open load		40	70		$\Omega$
$T_{DC\_DIAG}$	DC diagnostic time			100		ms
LO	Line output diagnostic detection				6	k $\Omega$
$T_{LINE\_DIAG}$	Line output diagnostic time	Not including the preceeding DC_DIAG time		40		ms
$AC_{IMP}$	AC impedance accuracy	Gain linearity, $f = 19\text{ kHz}$ , $R_L = 2\ \Omega$ to $16\ \Omega$			25%	
$AC_{IMP}$	AC impedance accuracy	Offset			$\pm 0.5$	$\Omega$
$T_{AC\_DIAG}$	AC diagnostic time			170		ms
<b>I<sup>2</sup>C_ADDR PINS</b>						
$t_{I2C\_ADDR}$	Time delay needed for I <sup>2</sup> C address set-up			300		$\mu\text{s}$

**Electrical Characteristics (continued)**

Test conditions (unless otherwise noted):  $T_C = 25^\circ\text{C}$ ,  $PVDD = VBAT = 14.4\text{ V}$ ,  $VDD = 3.3\text{ V}$ ,  $R_L = 4\ \Omega$ ,  $P_{out} = 1\text{ W/ch}$ ,  $f_{IN} = 1\text{ kHz}$ ,  $f_{SW} = 2.11\text{ MHz}$ , AES17 Filter, default I2C settings

PARAMETER		TEST CONDITIONS	MIN	TYP	MAX	UNIT
<b>I<sup>2</sup>C CONTROL PORT</b>						
$t_{BUS}$	Bus free time between a STOP and START condition		1.3			$\mu\text{s}$
$t_{h1}$	Hold time, SCL to SDA		0			ns
$t_{h2}$	Hold time, start condition to SCL		0.6			$\mu\text{s}$
$t_{START}$	I <sup>2</sup> C startup time after VDD power on reset				12	ms
$t_{RISE}$	Rise time, SCL and SDA				300	ns
$t_{FALL}$	Fall time, SCL and SDA				300	ns
$t_{SU1}$	Setup, SDA to SCL		100			ns
$t_{SU2}$	Setup, SCL to start condition		0.6			$\mu\text{s}$
$t_{SU3}$	Setup, SCL to stop condition		0.6			$\mu\text{s}$
$t_{W(H)}$	Required pulse duration SCL <i>High</i>		0.6			$\mu\text{s}$
$t_{W(L)}$	Required pulse duration SCL <i>Low</i>		1.3			$\mu\text{s}$
<b>SERIAL AUDIO PORT</b>						
$D_{MCLK}, D_{SCLK}$	Allowable input clock duty cycle		45%	50%	55%	
$f_{MCLK}$	Supported MCLK frequencies	128, 256, or 512	128		512	xFS
$f_{MCLK\_Max}$	Maximum frequency				25	MHz
$t_{SCY}$	SCLK pulse cycle time		40			ns
$t_{SCL}$	SCLK pulse-with LOW		16			ns
$t_{SCH}$	SCLK pulse-with HIGH		16			ns
$t_{RISE/FALL}$	Rise and fall time			<5		ns
$t_{SF}$	SCLK rising edge to FSYNC edge		8			ns
$t_{FS}$	FSYNC rising edge to SCLK edge		8			ns
$t_{DS}$	DATA set-up time		8			ns
$t_{DH}$	DATA hold time		8			ns
$C_i$	Input capacitance, pins MCLK, SCLK, FSYNC, SDIN1				10	pf
$T_{LA}$	Latency from input to output measured in FSYNC sample count	FSYNC = 44.1 kHz or 48 kHz			30	
		FSYNC = 96 kHz			12	

### 8.6 Typical Characteristics

$T_A = 25\text{ }^\circ\text{C}$ ,  $V_{VDD} = 3.3\text{ V}$ ,  $V_{BAT} = PVDD = 14.4\text{ V}$ ,  $R_L = 4\ \Omega$ ,  $f_{IN} = 1\text{ kHz}$ ,  $f_s = 48\text{ kHz}$ ,  $f_{SW} = 2.1\text{ MHz}$ , AES17 filter, default I<sup>2</sup>C settings, see 图 66 (unless otherwise noted)

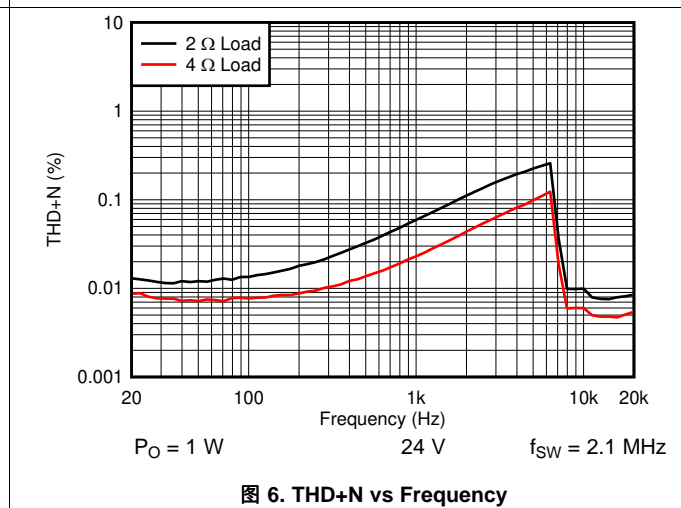
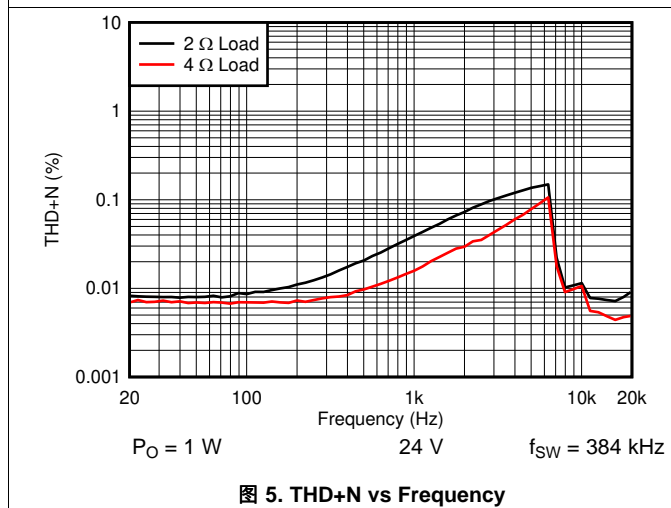
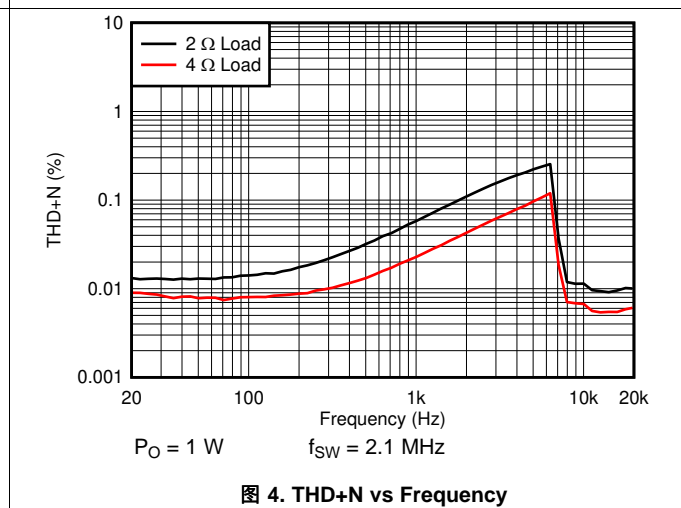
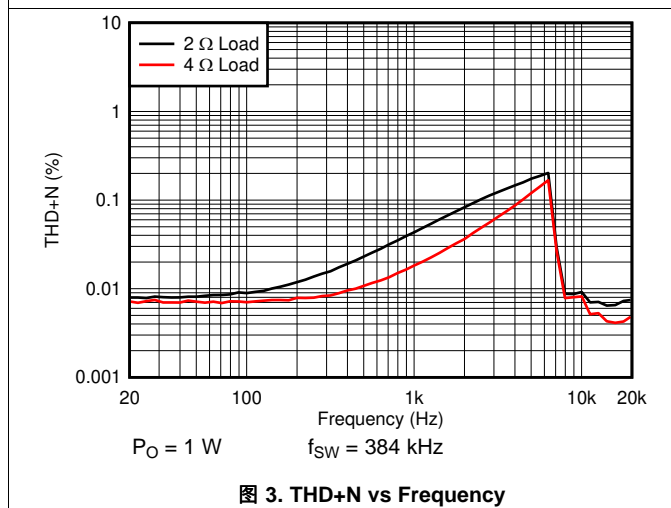
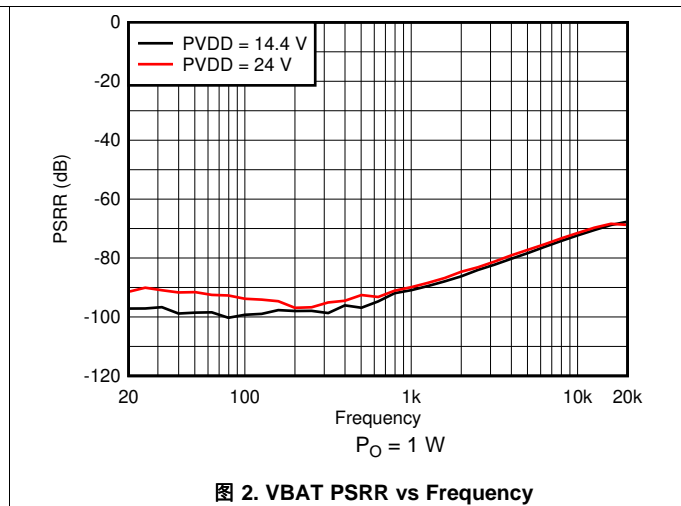
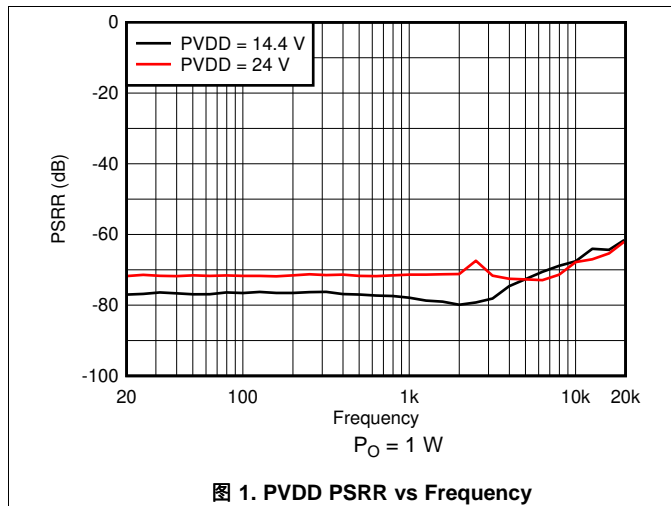

Typical Characteristics (接下页)

$T_A = 25\text{ }^\circ\text{C}$ ,  $V_{VDD} = 3.3\text{ V}$ ,  $V_{BAT} = PVDD = 14.4\text{ V}$ ,  $R_L = 4\text{ }\Omega$ ,  $f_{IN} = 1\text{ kHz}$ ,  $f_s = 48\text{ kHz}$ ,  $f_{SW} = 2.1\text{ MHz}$ , AES17 filter, default I<sup>2</sup>C settings, see 图 66 (unless otherwise noted)

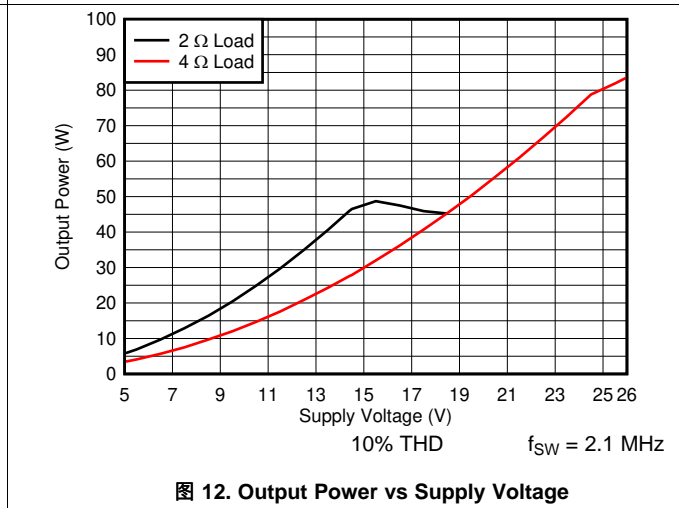
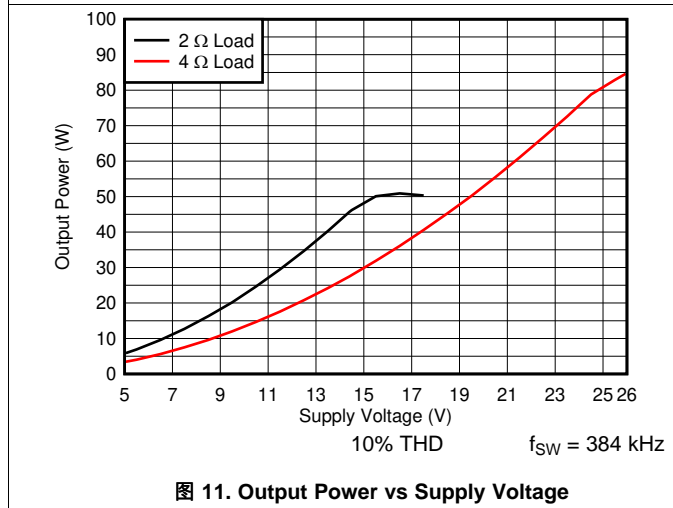
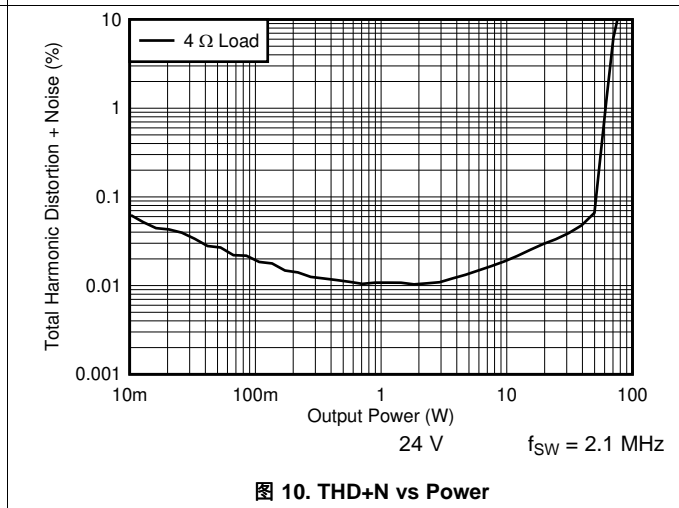
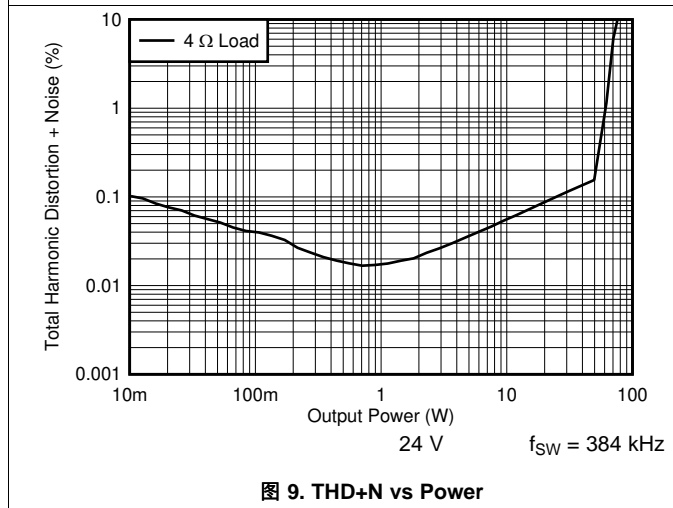
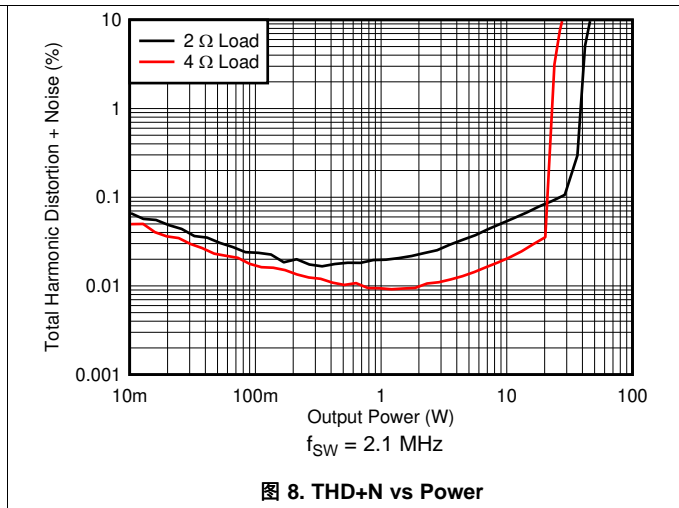
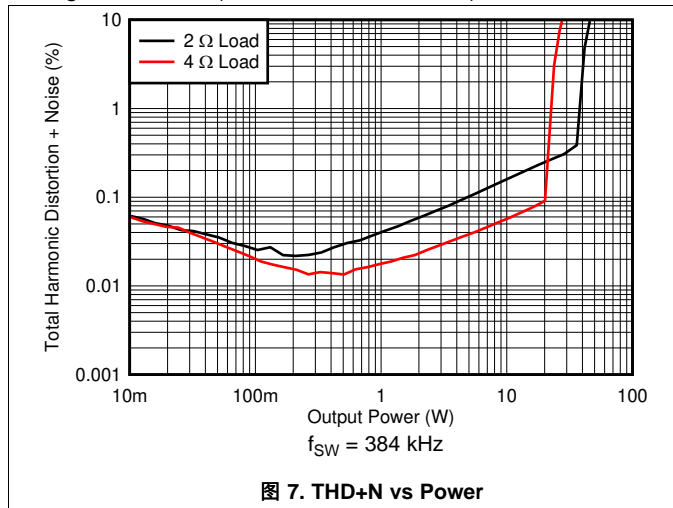

Typical Characteristics (接下页)

$T_A = 25\text{ }^\circ\text{C}$ ,  $V_{DD} = 3.3\text{ V}$ ,  $V_{BAT} = PV_{DD} = 14.4\text{ V}$ ,  $R_L = 4\ \Omega$ ,  $f_{IN} = 1\text{ kHz}$ ,  $f_s = 48\text{ kHz}$ ,  $f_{SW} = 2.1\text{ MHz}$ , AES17 filter, default I<sup>2</sup>C settings, see 图 66 (unless otherwise noted)

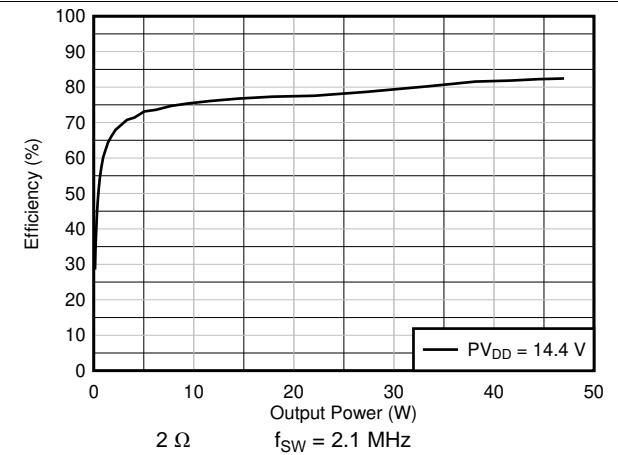
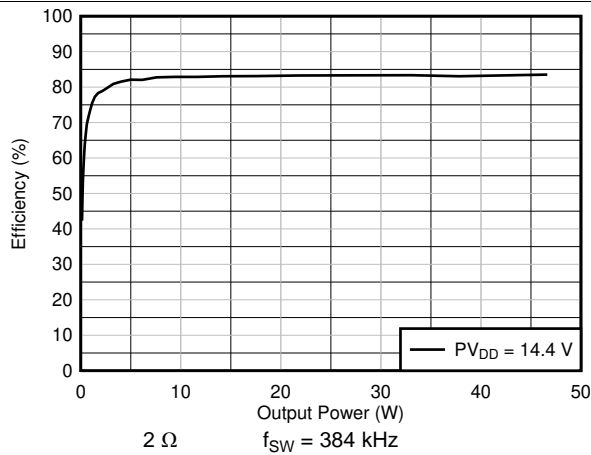
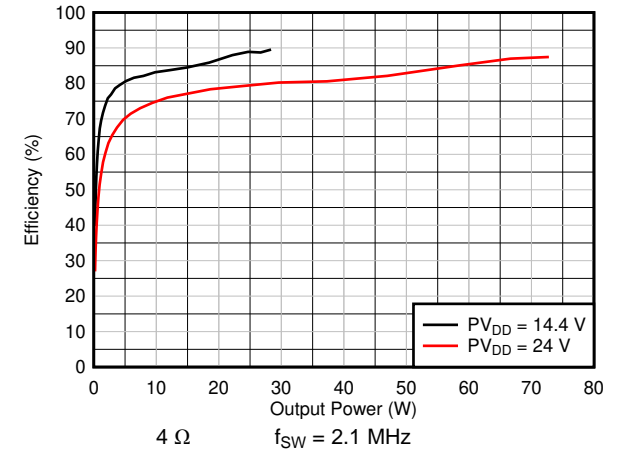
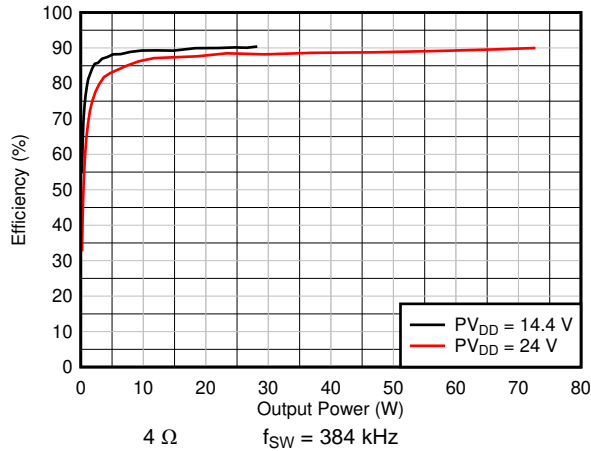
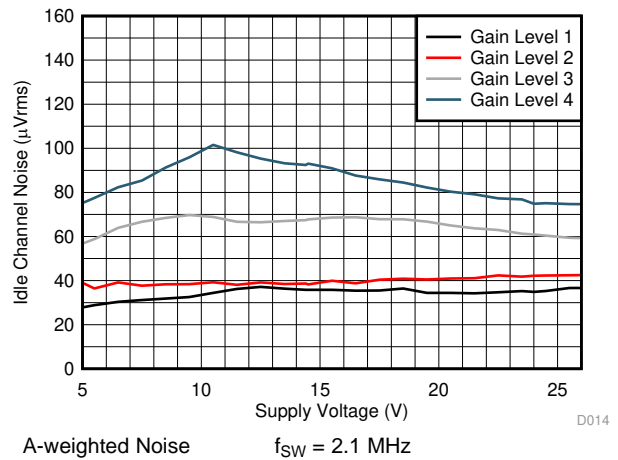
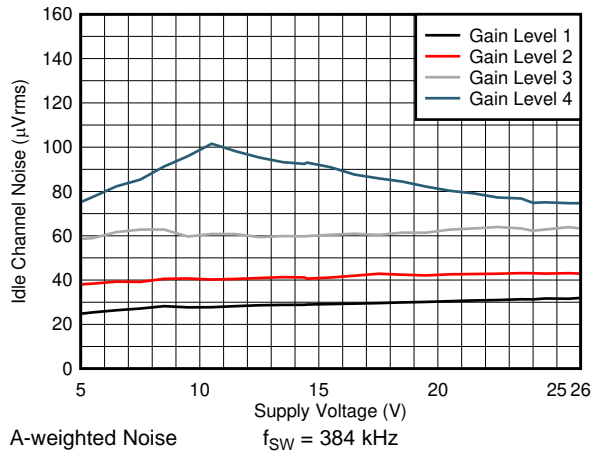

Typical Characteristics (接下页)

$T_A = 25\text{ }^\circ\text{C}$ ,  $V_{VDD} = 3.3\text{ V}$ ,  $V_{BAT} = PVDD = 14.4\text{ V}$ ,  $R_L = 4\ \Omega$ ,  $f_{IN} = 1\text{ kHz}$ ,  $f_s = 48\text{ kHz}$ ,  $f_{SW} = 2.1\text{ MHz}$ , AES17 filter, default  $I^2C$  settings, see 图 66 (unless otherwise noted)



图 19. PVDD Idle Current vs Voltage



图 20. VBAT Idle Current vs Voltage

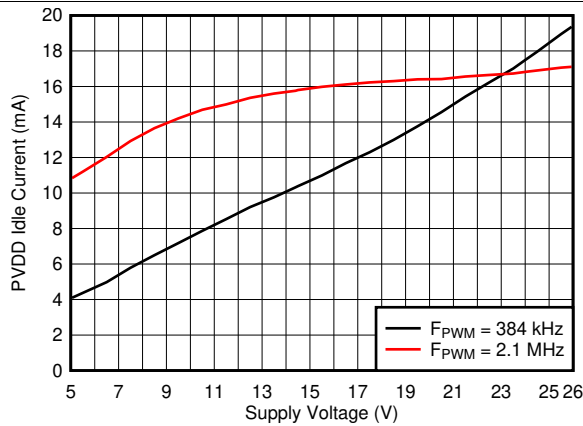

图 21. PVDD + VBAT Standby Current vs Voltage

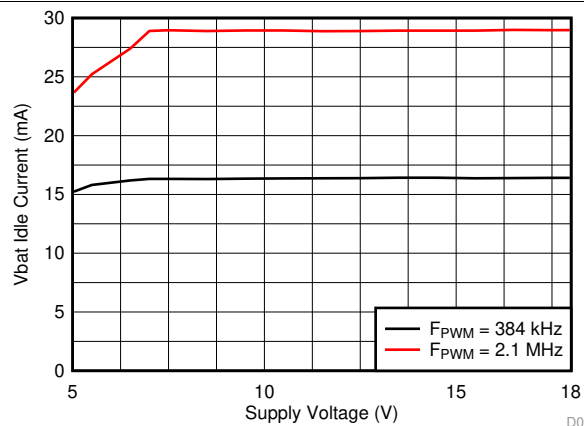

图 22. Power Dissipation vs Output Power

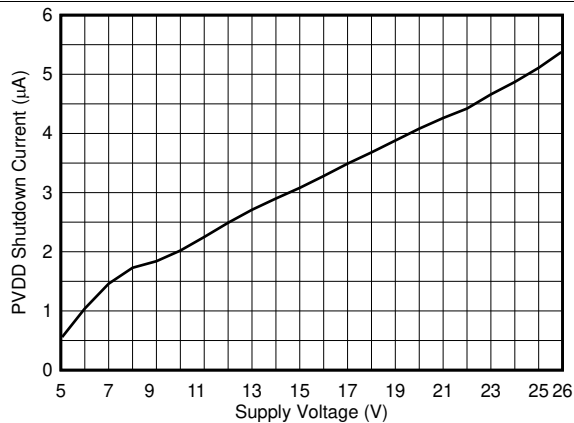

图 23. Power Dissipation vs Output Power

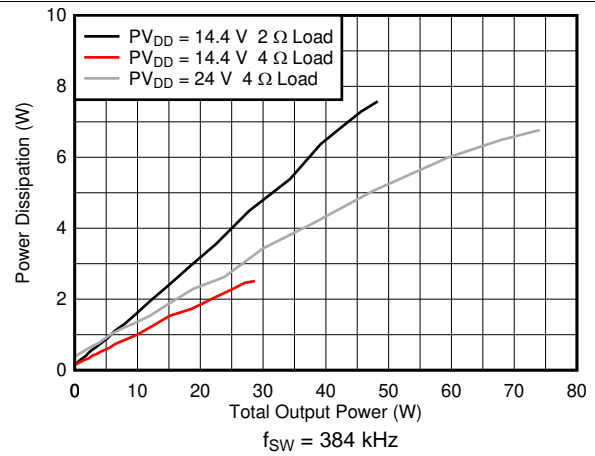

## 9 Parameter Measurement Information

The parameters for the TAS6421-Q1 device were measured using the circuit in [图 66](#).

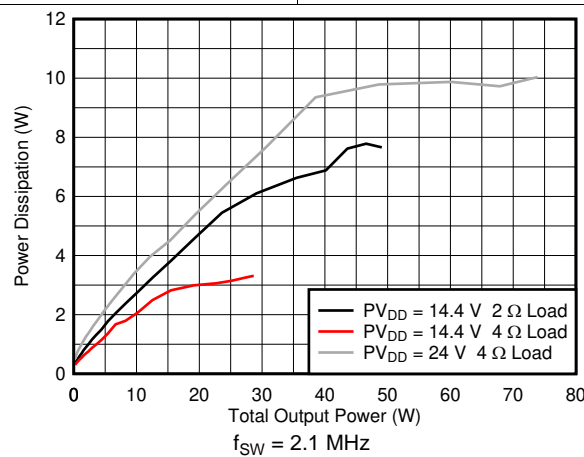
For measurements with 2.1 MHz switching frequency the 3.3  $\mu\text{H}$  inductor from the TAS6421-Q1 EVM is used.

## 10 Detailed description

### 10.1 Overview

The TAS6421-Q1 device is a single-channel digital-input Class-D audio amplifier specifically tailored for use in the automotive industry. The device is designed for vehicle battery operation or boosted voltage systems. This efficient Class-D technology allows for reduced power consumption, reduced PCB area and reduced heat. The device realizes an audio sound-system design with smaller size and lower weight than traditional Class-AB solutions.

The core design blocks are as follows:

- Serial audio port
- Clock management
- High-pass filter and volume control
- Pulse width modulator (PWM) with output stage feedback
- Gate drive
- Power FETs
- Diagnostics
- Protection
- Power supply
- I<sup>2</sup>C serial communication bus

### 10.2 Functional Block Diagram

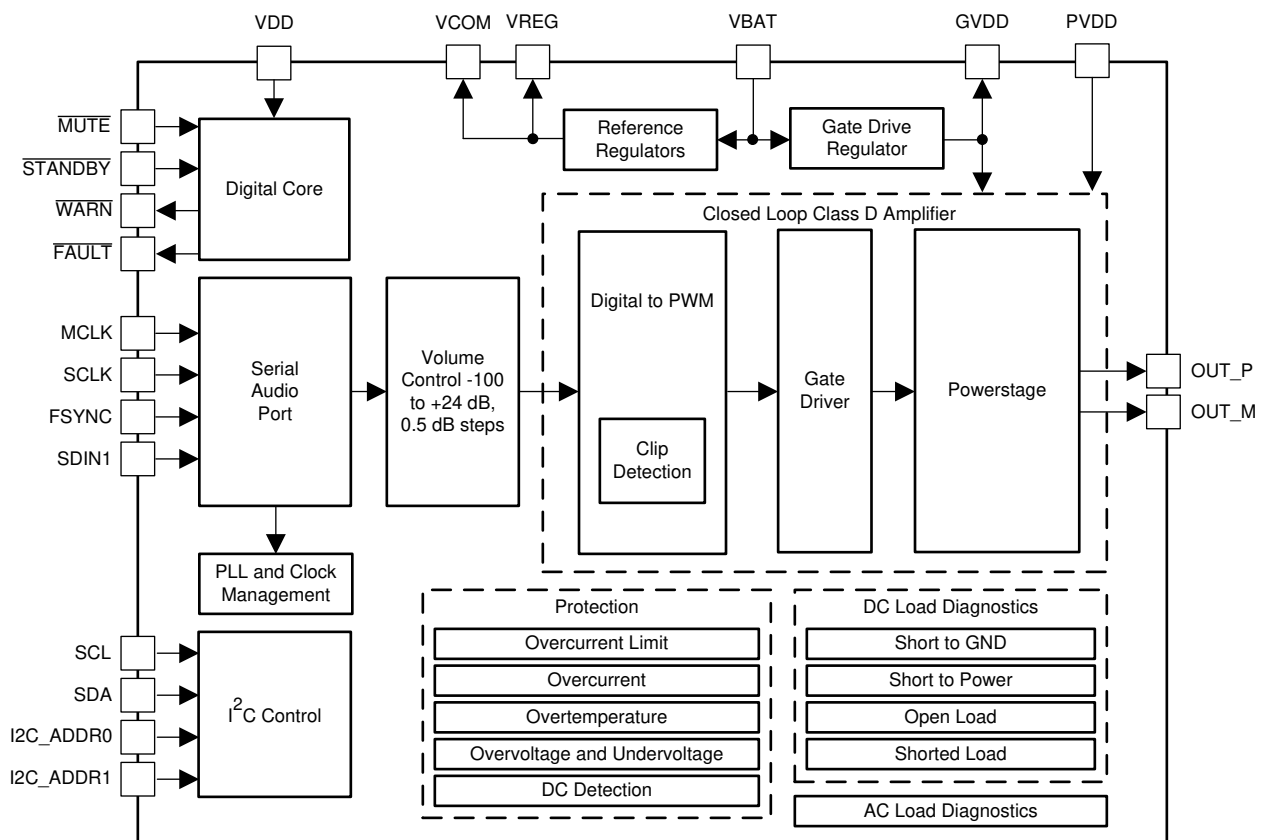

## 10.3 Feature Description

### 10.3.1 Serial Audio Port

The serial audio port (SAP) receives audio in either I<sup>2</sup>S, left justified, right justified, or TDM formats.

Settings for the serial audio port are programmed in the [SAP Control \(Serial Audio-Port Control\) Register \(address = 0x03\) \[default = 0x04\]](#) and [Miscellaneous Control 3 Register \(address = 0x21\) \[default = 0x00\]](#).

图 24 shows the digital audio data connections for I<sup>2</sup>S and TDM8 mode for a five channel system using TAS6424 four-channel Class-D amplifier and a TAS6421 single-channel Class-D amplifier.



图 24. Digital-Audio Data Connection

#### 10.3.1.1 I<sup>2</sup>S Mode

I<sup>2</sup>S timing uses the FSYNC pin to define when the data being transmitted is for the left channel and when the data is for the right channel. The FSYNC pin is low for the left channel and high for the right channel. The bit clock, SCLK, runs at  $32 \times f_s$  or  $64 \times f_s$  and is used to clock in the data. A delay of one bit clock occurs from the time the FSYNC signal changes state to the first bit of data on the data lines. The data is presented in 2s-complement form (MSB-first). The data is valid on the rising edge of the bit clock and is used to clock in the data.

The SAP Control Register Bits 3-5 allows to select if I<sup>2</sup>S Channel 1 or Channel 2 is amplified.

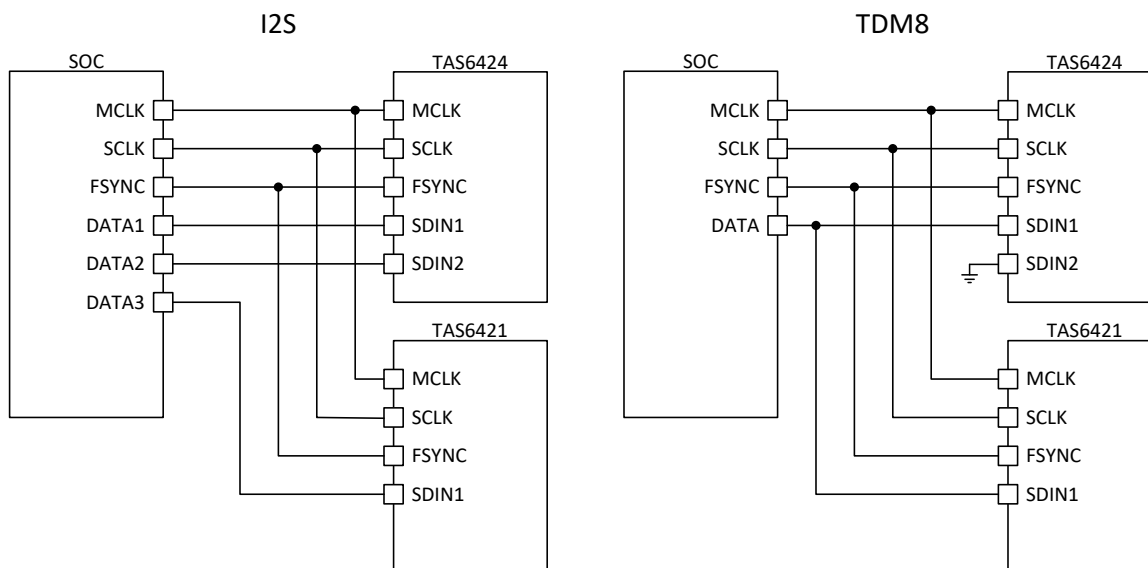
#### 10.3.1.2 Left-Justified Timing

Left-justified (LJ) timing also uses the FSYNC pin to define when the data being transmitted is for the left channel and when the data is for the right channel. The FSYNC pin is high for the left channel and low for the right channel. A bit clock running at  $32 \times f_s$  or  $64 \times f_s$  is used to clock in the data. The first bit of data appears on the data lines at the same time FSYNC toggles. The data is written MSB-first and is valid on the rising edge of the bit clock. Digital words can be 16-bits or 24-bits wide and pad any unused trailing data-bit positions in the left-right (L/R) frame with zeros.

#### 10.3.1.3 Right-Justified Timing

Right-justified (RJ) timing also uses the FSYNC pin to define when the data being transmitted is for the left channel and when the data is for the right channel. The FSYNC pin is high for the left channel and low for the right channel. A bit clock running at  $32 \times f_s$  or  $64 \times f_s$  is used to clock in the data. The first bit of data appears on the data 8-bit clock periods (for 24-bit data) after the FSYNC pin toggles. In RJ mode the LSB of data is always clocked by the last bit clock before the FSYNC pin transitions. The data is written MSB-first and is valid on the rising edge of bit clock. The device pads the unused leading data-bit positions in the L/R frame with zeros.

## Feature Description (接下页)

### 10.3.1.4 TDM Mode

TDM mode supports 4 or 8 channels of audio data. The TDM mode is automatically selected when the TDM clocks are present. The device can be configured through I<sup>2</sup>C to select which TDM channel slot is amplified. The TDM mode supports 16-bit, 24-bit, and 32-bit input data lengths.

In TDM mode, SCLK must be  $128 \times f_s$  or  $256 \times f_s$ , depending on the TDM slot size. In TDM mode SCLK and MCLK can be connected together. If SCLK and MCLK are connected together or the frequency of SCLK and MCLK is equal, FSYNC should be minimum 2 MCLK pulses long.

In TDM mode, the SDIN1 pin (pin 15) is used for digital audio data. [表 1](#) lists register settings for the TDM channel selection.

**表 1. Channel Selection**

REGISTER SETTING			AMPLIFIED CHANNEL
0x03 BIT 5	0x03 BIT 4	0x03 BIT 3	
0	0	0	Slot 1 in TDM8/4 or Left Channel in I <sup>2</sup> S mode
0	0	1	Slot 2 in TDM8/4 or Right Channel in I <sup>2</sup> S mode
0	1	0	Slot 3 in TDM8/4
0	1	1	Slot 4 in TDM8/4
1	0	0	Slot 5 in TDM8
1	0	1	Slot 6 in TDM8
1	1	0	Slot 7 in TDM8
1	1	1	Slot 8 in TDM8

### 10.3.1.5 Supported Clock Rates

The device supports MCLK rates of  $128 \times f_s$ ,  $256 \times f_s$ , or  $512 \times f_s$ .

The device supports SCLK rates of  $32 \times f_s$  or  $64 \times f_s$  in I<sup>2</sup>S, LJ or RJ modes or  $128 \times f_s$ , or  $256 \times f_s$  in TDM mode.

The device supports FSYNC rates of 44.1 kHz, 48 kHz, or 96 kHz.

The maximum clock frequency is 25 MHz. Therefore, for a 96 kHz FSYNC rate, the maximum MCLK rate is  $256 \times f_s$ .

Duty cycle of 50% is required for 128x FSYNC, for 256x and 512x 50% duty cycle is not required.

### 10.3.1.6 Audio-Clock Error Handling

When any kind of clock error, MCLK-FSYNC or SCLK-FSYNC ratio, or clock halt is detected, the device puts all channels into the Hi-Z state. When all audio clocks are within the expected range, the device automatically returns to the state it was in. See the [Electrical Characteristics](#) table for timing requirements.



图 25. Serial Audio Timing



图 26. Left-Justified Audio Data Format

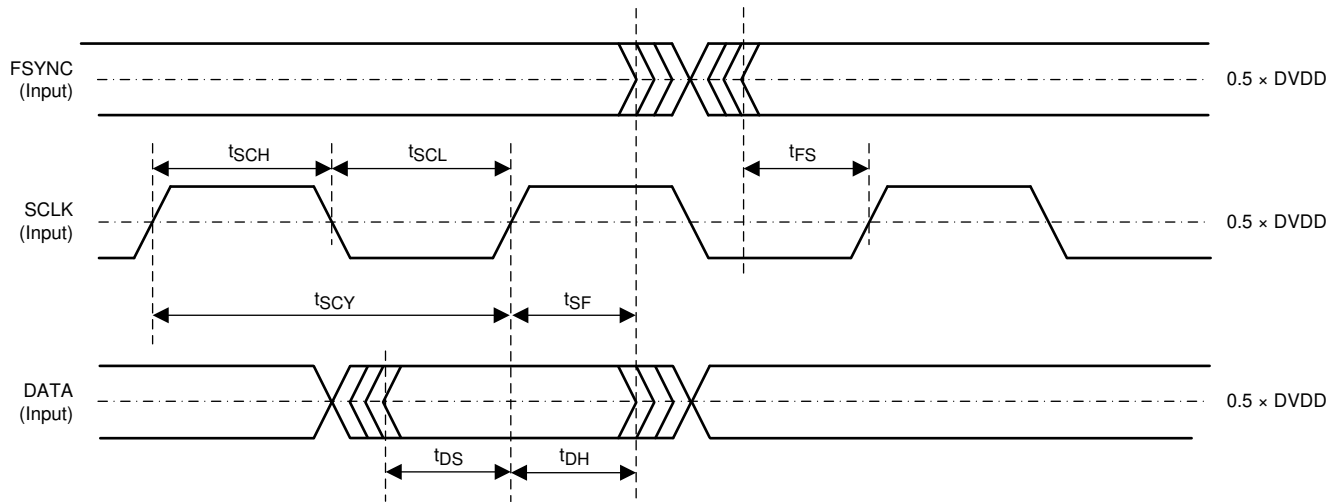

图 27. I²S Audio Data Format

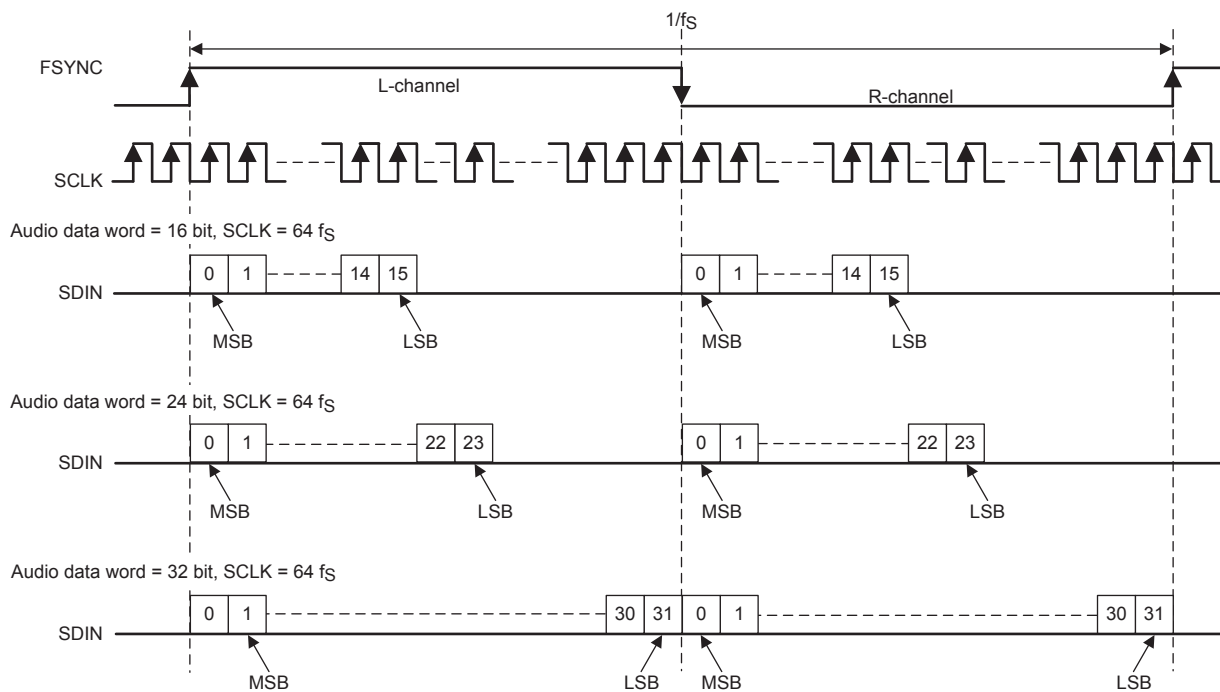

Audio Data Format: TDM8 mode

图 28. TDM8 Audio Data Format

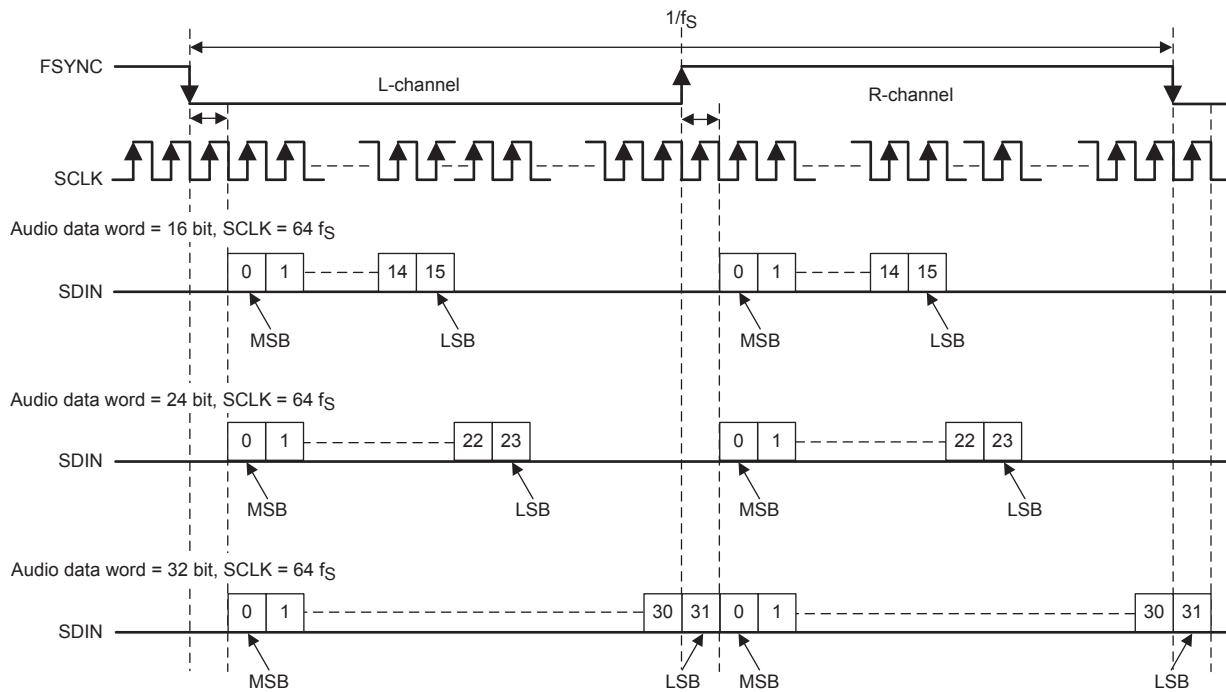
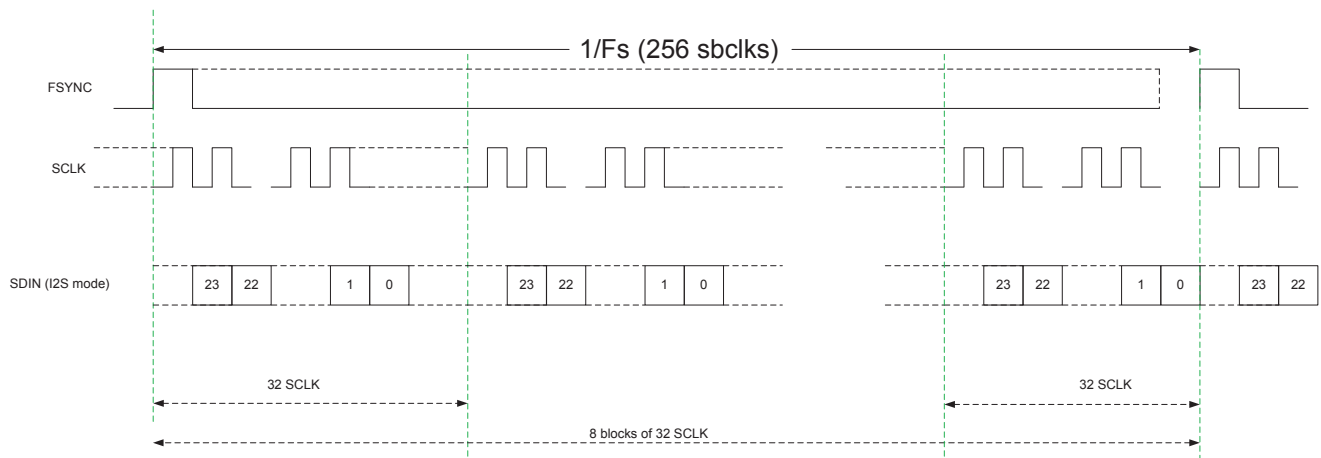
### 10.3.2 DC Blocking

Direct-current (DC) content in the audio signal can damage speakers. The data path has a high-pass filter to remove any DC from the input signal. The corner frequency is selectable from 4 Hz, 8 Hz, 15 Hz, 30 Hz and several more options up to 463 Hz with bits 0 through 2 in register 0x26. The default value of -3 dB is approximately 4 Hz for 44.1 kHz or 48 kHz and approximately 8 Hz for 96 kHz sampling rates.

### 10.3.3 Volume Control and Gain

The output channel has a digital-volume control with a range from –100 dB to +24 dB with 0.5-dB steps. The volume control is set through I<sup>2</sup>C. The gain-ramp rate is programmable through I<sup>2</sup>C to take one step every 1, 2, 4, or 8 FSYNC cycles.

The peak output-voltage swing is also configurable in the gain control register through I<sup>2</sup>C. The four full-scale voltage settings are 7.5 V, 15 V, 21 V, and 29 V. TI recommends selecting the lowest possible for the expected PVDD operation to optimize output noise and dynamic range performance.

### 10.3.4 High-Frequency Pulse-Width Modulator (PWM)

The PWM converts the PCM input data into a switched signal of varying duty cycle. The PWM modulator is an advanced design with high bandwidth, low noise, low distortion, and excellent stability. The output switching rate is synchronous to the serial audio-clock input and is programmed through I<sup>2</sup>C to be between 8× and 48× the input-sample rate. The option to switch at high frequency allows the use of smaller and lower cost external filtering components. 表 2 lists the switch frequency options for bits 4 through 6 in the [Miscellaneous Control 2 register \(address 0x02\)](#).

**表 2. Output Switch Frequency Option**

INPUT SAMPLE RATE	BIT 6:4 SETTINGS					
	000	001	010 to 100	101	110	111
44.1 kHz	352.8 kHz	441 kHz	RESERVED	1.68 MHz	1.94 MHz	2.12 MHz
48 kHz	384 kHz	480 kHz	RESERVED	1.82 MHz	2.11 MHz	Not supported
96 kHz	384 kHz	480 kHz	RESERVED	1.82 MHz	2.11 MHz	Not supported

### 10.3.5 Gate Drive

The gate driver accepts the low-voltage PWM signal and level shifts it to drive a high-current, full-bridge, power-FET stage. The device uses proprietary techniques to optimize EMI and audio performance.

The gate-driver power-supply voltage, GVDD, is internally generated and a decoupling capacitor is connected at pin 9.

The full H-bridge output stages use only NMOS transistors. Therefore, bootstrap capacitors are required for the proper operation of the high side NMOS transistors. A 1-μF ceramic capacitor of quality X7R or better, rated for at least 16 V, must be connected from each output to the corresponding bootstrap input. The bootstrap capacitors connected between the BST pins and corresponding output function as a floating power supply for the high-side N-channel power MOSFET gate drive circuitry. During each high-side switching cycle, the bootstrap capacitors hold the gate-to-source voltage high keeping the high-side MOSFETs turned on.

### 10.3.6 Power FETs

The BTL output channel comprises four N-channel 90-mΩ FETs for high efficiency and maximum power transfer to the load. These FETs are designed to handle the fast switching frequency and large voltage transients during load dump.

### 10.3.7 Load Diagnostics

The device incorporates both DC-load and AC-load diagnostics, which are used to determine the status of the load. The DC diagnostics are turned on by default, but if a fast startup without diagnostics is required, the DC diagnostics can be bypassed through I<sup>2</sup>C. The DC diagnostics run when the output channel is directed to leave the Hi-Z state and enter the MUTE or PLAY state. The DC diagnostics can also be enabled manually. DC Diagnostics can be started from any operating condition, but if the channel is in PLAY state, then the time to complete the diagnostic is longer because the device must ramp down the audio signal of that channel before transitioning to the Hi-Z state. The DC diagnostics are available as soon as the device supplies are within the recommended operating range. The DC diagnostics do not rely on the audio input clocks to be available to function. DC Diagnostic results are reported through I<sup>2</sup>C registers.

### 10.3.7.1 DC Load Diagnostics

The DC load diagnostics are used to verify the load is connected. The DC diagnostics consists of four tests: short-to-power (S2P), short-to-ground (S2G), open-load (OL), and shorted-load (SL). The S2P and S2G tests trigger if the impedance to GND or a power rail is below that specified in the [Specifications](#) section. The diagnostic detects a short to vehicle battery, even when the supply is boosted. The SL test has an I<sup>2</sup>C-configurable threshold depending on the expected load to be connected. The OL test reports if the select channel has a load impedance greater than the limits in the [Specifications](#) section.



图 29. DC Load Diagnostic Reporting Thresholds

### 10.3.7.2 Line Output Diagnostics

The device also includes an optional test to detect a line-output load. A line-output load is a high-impedance load that is above the open-load (OL) threshold such that the DC-load diagnostics report an OL condition. After an OL condition is detected, if the line output detection bit is also set, the channel checks if a line-output load is present as well. This test is not pop free, so if an external amplifier is connected it should be muted.

### 10.3.7.3 AC Load Diagnostics

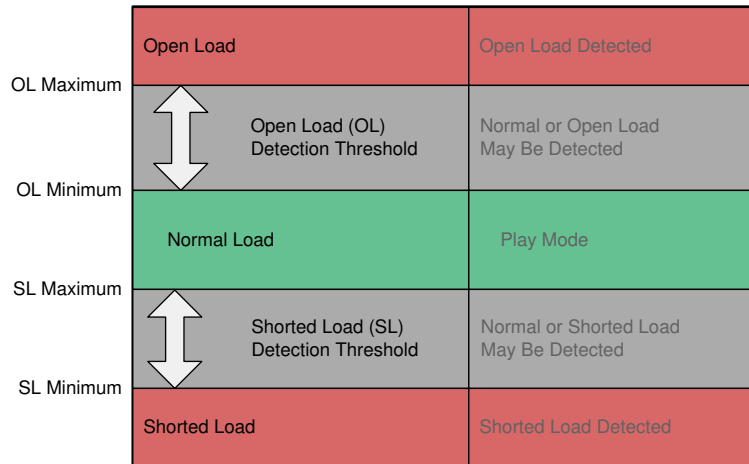
The AC load diagnostic is used to determine the proper connection of a capacitively-coupled speaker or tweeter when used with a passive crossover. The AC load diagnostic is controlled through I<sup>2</sup>C. The AC diagnostics requires an external input signal and reports the approximate load impedance and phase. The selected signal frequency should create current flow through the desired speaker for proper detection. The AC load-diagnostic test procedure is as follows.

#### 10.3.7.3.1 Impedance Magnitude Measurement

For load-impedance detection, use the following test procedure:

1. Set the output channel into the Hi-Z state.
2. Set the AC\_DIAGS\_LOOPBACK bit (bit 7 in register 0x16) to 0.
3. Apply a full-scale input signal from the DSP for the tested channel with the desired frequency (recommended 10 kHz to 20 kHz).

**注**

The device ramps the signal up and down automatically to prevent pops and clicks.

4. Set the device into the AC diagnostic mode (set bit 3 in register 0x15 to 1).
5. Read back the AC impedance (register 0x17).

When the test is complete, the channel reporting register indicates the status change from the AC diagnostic mode to the Hi-Z state. The detected impedance is stored in the appropriate I<sup>2</sup>C register.



The hexadecimal register value must be converted to decimal and used to calculate the impedance magnitude using 公式 1:

$$\text{Channelx Impedance} = \frac{\text{Impedance\_CHx} \times 2.371\text{mV}}{(\text{Gain})(I \text{ mA})} \quad (\text{Ohms}) \quad (1)$$

### 10.3.7.3.2 Impedance Phase Reference Measurement

The first stage to determine the AC phase is to utilize the built-in loopback mode to determine the reference value for the phase measurement. This reference nullifies any phase offset in the device and measure only the phase of the load.

For loopback delay detection, use the following test procedure:

1. Set the AC\_DIAGS\_LOOPBACK bit (bit 7 in register 0x16) to 1 to enable AC loopback mode.
2. Apply a 0-dBFS 19 kHz signal and enable AC load diagnostics (set bit 3 in register 0x15 to 1).
3. Read back the 16bit hexadecimal, AC\_LDG\_PHASE1 value. Register 0x1B holds the MSB and register 0x1C holds the LSB.
4. Set bit 3 in register 0x15 to 0.

When the test is complete, the channel reporting register indicates the status change from the AC diagnostic mode to the Hi-Z state. The detected impedance is stored in the appropriate I<sup>2</sup>C register.

### 10.3.7.3.3 Impedance Phase Measurement

After performing the phase reference measurements, measure the phase of the speaker load. This is performed in the same manner as the reference measurements, except the loopback is disabled in register 0x16, bit 7.

For loopback delay detection, use the following test procedure:

1. Set the AC\_DIAGS\_LOOPBACK bit (bit 7 in register 0x16) to 0 to disable AC loopback mode.
2. Apply a 0-dBFS 19 kHz signal and enable AC load diagnostics by setting bit 3 in register 0x15 to 1.
3. Read back the 16-bit hexadecimal, AC\_LDG\_PHASE1 value. Register 0x1B holds the MSB and register 0x1C holds the LSB.
4. Read back the hexadecimal stimulus value, STI. Register 0x1D holds the MSB and register 0x1E holds the LSB.
5. Set bit 3 in register 0x15 to 0.

When the test is complete, the channel reporting register indicates the status change from the AC diagnostic mode to the Hi-Z state. The detected impedance is stored in the appropriate I<sup>2</sup>C register.

The AC phase in degrees is calculated using 公式 2:

$$\text{Phase\_CHx} = 360 \left( \frac{\text{Phase\_CHx(LBK)} - \text{Phase\_CHx(LDM)}}{\text{STI\_CHx(LDM)}} \right) \quad (2)$$

Where:

- Phase\_CHx(LBK) is the reference phase measurement. LBK stands for loopback mode
- Phase\_CHx(LDM) is the phase measure of the load. LDM stands for load mode
- STI\_CHx(LDM) is the stimulus value

**表 3. AC Impedance Code to Magnitude**

SETTING	GAIN AT 19 kHz	I(A)	MEASUREMENT RANGE (Ω)	MAPPING FROM CODE TO MAGNITUDE (Ω/Code)
Gain = 4, I = 10 mA (recommended)	4.28	0.01	12	0.05832
Gain = 4, I = 19 mA	4.28	0.019	6	0.0307
Gain = 1, I = 10 mA (recommended)	1	0.01	48	0.2496
Gain = 1, I = 19 mA	1	0.019	24	0.1314

### 10.3.8 Protection and Monitoring

#### 10.3.8.1 Overcurrent Limit ( $I_{LIMIT}$ )

The overcurrent limit terminates each PWM pulse to limit the output current flow when the current limit ( $I_{LIMIT}$ ) is exceeded. Power is limited, but operation continues without disruption and prevents undesired shutdown for transient music events.  $I_{LIMIT}$  is not reported as fault condition to registers or the  $\overline{FAULT}$  pin but as warning condition to the  $\overline{WARN}$  pin and [ILIMIT Status Register \(address = 0x25\) \[default = 0x00\]](#). The two programmable levels can be set by bit 4 in the [Miscellaneous Control 1 register \(address 0x01\)](#).

#### 10.3.8.2 Overcurrent Shutdown ( $I_{SD}$ )

If the output load current reaches  $I_{SD}$ , such as an output short to GND, then a peak current limit occurs, which shuts down the channel. The time to shutdown the channel varies depending on the severity of the short condition. The channel is placed into the Hi-Z state, the fault is reported to the register, and the  $\overline{FAULT}$  pin is asserted. The device remains in this state until the CLEAR FAULT bit is set in Miscellaneous Control 3 Register, 0x21 bit 7. After clearing this bit and if the diagnostics are enabled, the device automatically starts diagnostics on the channel and, if no load failure is found, the device restarts. If a load fault is found the device continues to rerun the diagnostics once per second. Because this hiccup mode uses the diagnostics, no high current is created. If the diagnostics are disabled, the device sets the state for the channel to Hi-Z and requires the MCU to take the appropriate action, setting the CLEAR FAULT bit after the fault was removed, in order to return to Play state. The two programmable levels can be set by bit 4 in the [Miscellaneous Control 1 register \(address 0x01\)](#).

#### 10.3.8.3 DC Detect

This circuit checks the DC offset continuously during normal operation at the output of the amplifier. If the DC offset exceeds the threshold, the channel is placed in the Hi-Z state, the fault is reported to the I<sup>2</sup>C register, and the  $\overline{FAULT}$  pin is asserted. A register bit can be used to mask reporting to the  $\overline{FAULT}$  pin if required.

#### 10.3.8.4 Clip Detect

The Clip Detect is reported on the  $\overline{WARN}$  pin if 100% duty-cycle PWM is reached for a minimum number of PWM cycles set by the [Clip Window Register \(address = 0x23\)](#). The default is 20 PWM cycles. The Clip Detect is latched and can be cleared by I<sup>2</sup>C. Masking the clip reporting to the pin is possible through I<sup>2</sup>C. If desired, the Clip Detect can be configured to be non-latching through I<sup>2</sup>C. In non-latching mode, Clip Detect is reported when the PWM duty cycle reaches 100%, and deasserted once the PWM duty cycle falls below 100%.

#### 10.3.8.5 Global Overtemperature Warning (OTW), Overtemperature Shutdown (OTSD)

Four overtemperature warning levels are available in the device (see the [Register Maps](#) section for thresholds). When the junction temperature exceeds the warning level, the  $\overline{WARN}$  pin is asserted, unless the mask bit has been set to disable reporting. The device functions until the OTSD value is reached, at which point the channels are placed in the Hi-Z state and the  $\overline{FAULT}$  pin is asserted. By default, the device remains shut down after the temperature drops to normal levels. This configuration can be changed in bit 3 of the [Miscellaneous Control 3 Register \(address = 0x21\) \[default = 0x00\]](#) to auto-recovery: When the junction temperature returns to normal levels, the device automatically recovers and places the channel into the state indicated by the state control register. Note that even in auto-recovery configuration the  $\overline{FAULT}$  pin remains asserted until the CLEAR FAULT bit (bit 7) is set in register 0x21.

#### 10.3.8.6 Channel Overtemperature Warning [OTW(i)] and Shutdown [OTSD(i)]

In addition to the global OTW, the output channel also has an individual overtemperature warning and shutdown. If the channel exceeds the OTW(i) threshold, the warning register bit is set as the  $\overline{WARN}$  pin is asserted, unless the mask bit has been set to disable reporting. If the channel temperature exceeds the OTSD(i) threshold then the channel goes to the Hi-Z state and either remains there or auto-recovers to the state indicated by the state control register when the temperature drops below the OTW(i) threshold, depending on the setting of bit 3 of the [Miscellaneous Control 3 Register \(address = 0x21\) \[default = 0x00\]](#).

### 10.3.8.7 Undervoltage (UV) and Power-On-Reset (POR)

The undervoltage (UV) protection detects low voltages on the PVDD and VBAT pins. In the event of an UV condition, the FAULT pin is asserted, and the I<sup>2</sup>C register is updated. A power-on reset (POR) on the VDD pin causes the I<sup>2</sup>C to go to the high-impedance (Hi-Z) state, and all registers are reset to default values. At power-on or after a POR event, the POR warning bit and WARN pin are asserted.

### 10.3.8.8 Overvoltage (OV) and Load Dump

The overvoltage (OV) protection detects high voltages on the PVDD pin. If the PVDD pin reaches the OV threshold, the FAULT pin is asserted and the I<sup>2</sup>C register is updated. The device can withstand 40 V load-dump voltage spikes.

## 10.3.9 Power Supply

The device has three power supply inputs, VDD, PVDD, and VBAT, which are described as follows:

- VDD** This pin is a 3.3V supply pin that provides power to the low voltage circuitry.
- VBAT** This pin is a higher voltage supply that can be connected to the vehicle battery or the regulated voltage rail in a boosted system within the recommended limits. For best performance, this rail should be 10 V or higher. See the [Recommended Operating Conditions](#) table for the maximum supply voltage. This supply rail is used for higher voltage analog circuits but not the output FETs.
- PVDD** This pin is a high-voltage supply that can either be connected to the vehicle battery or to another voltage rail in a boosted system. The PVDD pin supplies the power to the output FETs and can be within the recommended operating limits, even if that is below the VBAT supply, to allow for dynamic voltage systems.

Several on-chip regulators are included for generating the voltages necessary for the internal circuitry. The external pins are provided only for bypass capacitors to filter the supply and should not be used to power other circuits.

The device can withstand fortuitous open ground and power conditions within the absolute maximum ratings for the device. Fortuitous open ground usually occurs when a speaker wire is shorted to ground, allowing for a second ground path through the body diode in the output FETs.

### 10.3.9.1 Vehicle-Battery Power-Supply Sequence

The device can accept any sequence of the VBAT, PVDD and VDD supply.

#### 10.3.9.1.1 Power-Up Sequence

In a typical system, the VBAT and PVDD supplies are both connected to the vehicle battery and power up at the same time. The VDD supply should be applied after the VBAT and PVDD supplies are within the recommended operating range.

#### 10.3.9.1.2 Power-Down Sequence

To power-down the device, first set the  $\overline{\text{STANDBY}}$  pin low for at least 15ms before removing PVDD, VBAT or VDD. After 15ms, the power supplies can be removed.

### 10.3.9.2 Boosted Power-Supply Sequence

In this case, the VBAT and PVDD inputs are not connected to the same supply.

When powering up, apply the VBAT supply first, the VDD supply second, and the PVDD supply last.

When powering down, first set the  $\overline{\text{STANDBY}}$  pin low for at least 15ms before removing PVDD, VBAT or VDD. After 15 ms, the power supplies can be removed.

## 10.3.10 Hardware Control Pins

The device has four pins for control and device status:  $\overline{\text{FAULT}}$ ,  $\overline{\text{MUTE}}$ ,  $\overline{\text{WARN}}$ , and  $\overline{\text{STANDBY}}$ .

### 10.3.10.1 $\overline{\text{FAULT}}$

The  $\overline{\text{FAULT}}$  pin reports faults and is active low under any of the following conditions:

- Channel faults (overcurrent or DC detection)
- Overtemperature shutdown
- Overvoltage or undervoltage conditions on the VBAT or PVDD pins
- Clock errors

For all listed faults, the  $\overline{\text{FAULT}}$  pin remains asserted after the fault condition is rectified. Deassert the  $\overline{\text{FAULT}}$  pin by writing the CLEAR FAULT bit (bit 7) in register 0x21. The only exception is the fault report caused by Overtemperature shutdown, for which the  $\overline{\text{FAULT}}$  pin deasserts automatically when the junction temperature returns to normal levels and the device automatically recovers.

The register reports for all fault reports remain asserted until they are cleared by writing the CLEAR FAULT bit (bit 7) in register 0x21.

Register bits are available to mask fault categories from reporting to the  $\overline{\text{FAULT}}$  pin. These bits only mask the setting of the pin and do not affect the register reporting or protection of the device. By default all faults are reported to the pin. See the [Register Maps](#) section for a description of the mask settings.

This pin is an open-drain output with an internal 100 k $\Omega$  pull-up resistor to VDD.

### 10.3.10.2 $\overline{\text{WARN}}$

This active-low output pin reports audio clipping, overtemperature warnings, overcurrent limit warnings and POR events.

Clipping is reported if any channel is at the maximum modulation for 20 consecutive PWM clocks (default value) which results in a 10- $\mu$ s delay to report the onset of clipping. Changing the number of required consecutive PWM clocks in the [Clip Window Register \(address = 0x23\)](#) impacts the report delay time. The Clip Detect warning bit is sticky in latching mode and can be cleared by the CLEAR FAULT bit (bit 7) in register 0x21.

An overtemperature warning (OTW) is reported if the general temperature or the channel temperature warnings are set. The warning temperature can be set through bits 5 and 6 in register 0x01.

Register bits are available to mask either clipping, OTW or I<sub>LIMIT</sub> reporting to the pin. These bits only mask the setting of the pin and do not affect the register reporting. By default clipping, I<sub>LIMIT</sub> and OTW are reported.

The  $\overline{\text{WARN}}$  pin is latched and can be cleared by writing the CLEAR FAULT bit (bit 7) in register 0x21.

This pin is an open-drain output with an internal 100 k $\Omega$  pull-up resistor to VDD.

### 10.3.10.3 $\overline{\text{MUTE}}$

This active-low input pin is used for hardware control of the mute and unmute function.

This pin has a 100 k $\Omega$  internal pull-down resistor.

### 10.3.10.4 $\overline{\text{STANDBY}}$

When this active-low input pin is asserted, the device goes into shutdown and current draw is limited. This pin can be used to shut down the device rapidly. The outputs are ramped down in less than 5 ms if the device is not already in the Hi-Z state.

This pin has a 100 k $\Omega$  internal pull-down resistor.

## 10.4 Device Functional Modes

### 10.4.1 Operating Modes and Faults

The operating modes and faults are listed in the following tables.

Global Faults affect the entire device while the effect and management of Channel Faults is limited to the Output Stage. Although the system effects of a Global Fault and a Channel Fault can be identical in a 1-channel device such as TAS6421-Q1, this split and naming convention was selected to remain compatible with the multi-channel TAS642x-Q1 family devices.

**表 4. Operating Modes**

STATE NAME	OUTPUT FETS	OSCILLATOR	I <sup>2</sup> C
STANDBY	Hi-Z	Stopped	Active
Hi-Z	Hi-Z	Active	Active
MUTE	Switching at 50%	Active	Active
PLAY	Switching with audio	Active	Active

**表 5. Global Faults and Actions**

FAULT/ EVENT	FAULT/EVENT CATEGORY	MONITORING MODES	REPORTING METHOD	ACTION RESULT
POR	Voltage fault	All	I <sup>2</sup> C + $\overline{\text{WARN}}$ pin	Standby
VBAT UV		Hi-Z, mute, normal	I <sup>2</sup> C + $\overline{\text{FAULT}}$ pin	Hi-Z
PVDD UV				
VBAT or PVDD OV				
OTW	Thermal warning	Hi-Z, mute, normal	I <sup>2</sup> C + $\overline{\text{WARN}}$ pin	None
OTSD	Thermal shutdown	Hi-Z, mute, normal	I <sup>2</sup> C + $\overline{\text{FAULT}}$ pin	Hi-Z

**表 6. Channel Faults and Actions**

FAULT/ EVENT	FAULT/EVENT CATEGORY	MONITORING MODES	REPORTING METHOD	ACTION TYPE
Clipping	Warning	Mute and play	I <sup>2</sup> C + $\overline{\text{WARN}}$ or $\overline{\text{FAULT}}$ pin	None
Overcurrent limiting	Protection		I <sup>2</sup> C + $\overline{\text{WARN}}$ pin	Current limit
Overcurrent fault	Output channel fault		I <sup>2</sup> C + $\overline{\text{FAULT}}$ pin	Hi-Z
DC detect				

## 10.5 Programming

### 10.5.1 I<sup>2</sup>C Serial Communication Bus

The device communicates with the system processor through the I<sup>2</sup>C serial communication bus as an I<sup>2</sup>C slave-only device. The processor can poll the device through I<sup>2</sup>C to determine the operating status, configure settings, or run diagnostics. For a complete list and description of all I<sup>2</sup>C controls, see the [Register Maps](#) section.

The device includes two I<sup>2</sup>C address pins, so up to four devices can be used together in a system with no additional bus switching hardware. The I<sup>2</sup>C ADDR<sub>x</sub> pins set the slave address of the device as listed in [表 7](#).

表 7. I<sup>2</sup>C Addresses

DESCRIPTION	I <sup>2</sup> C ADDR1	I <sup>2</sup> C ADDR0	I <sup>2</sup> C Write	I <sup>2</sup> C Read
Device 0	0	0	0xD4	0xD5
Device 1	0	1	0xD6	0xD7
Device 2	1	0	0xD8	0xD9
Device 3	1	1	0xDA	0xDB

### 10.5.2 I<sup>2</sup>C Bus Protocol

The device has a bidirectional serial-control interface that is compatible with the Inter IC (I<sup>2</sup>C) bus protocol and supports 100 kbps and 400 kbps data transfer rates for random and sequential write and read operations. The TAS6421-Q1 device is a slave-only device that does not support a multimaster bus environment or wait-state insertion. The control interface is used to program the registers of the device and to read device status.

The I<sup>2</sup>C bus uses two signals, SDA (data) and SCL (clock), to communicate between integrated circuits in a system. Data is transferred on the bus serially, one bit at a time. The address and data are transferred in byte (8-bit) format with the most-significant bit (MSB) transferred first. In addition, each byte transferred on the bus is acknowledged by the receiving device with an acknowledge bit. Each transfer operation begins with the master device driving a start condition on the bus and ends with the master device driving a stop condition on the bus. The bus uses transitions on the data terminal (SDA) while the clock is HIGH to indicate a start and stop conditions. A HIGH-to-LOW transition on SDA indicates a start, and a LOW-to-HIGH transition indicates a stop. Normal data bit transitions must occur within the low time of the clock period. The master generates the 7-bit slave address and the read/write (R/W) bit to open communication with another device and then wait for an acknowledge condition. The device holds SDA LOW during the acknowledge-clock period to indicate an acknowledgment. When this occurs, the master transmits the next byte of the sequence. Each device is addressed by a unique 7-bit slave address plus a R/W bit (1 byte). All compatible devices share the same signals via a bidirectional bus using a wired-AND connection. An external pull-up resistor must be used for the SDA and SCL signals to set the HIGH level for the bus. The number of bytes that can be transmitted between start and stop conditions is unlimited. When the last word transfers, the master generates a stop condition to release the bus.



图 30. Typical I<sup>2</sup>C Sequence



图 31. SCL and SDA Timing

Use the I<sup>2</sup>C ADDR<sub>x</sub> pins to program the device slave address. Read and write data can be transmitted using single-byte or multiple-byte data transfers.

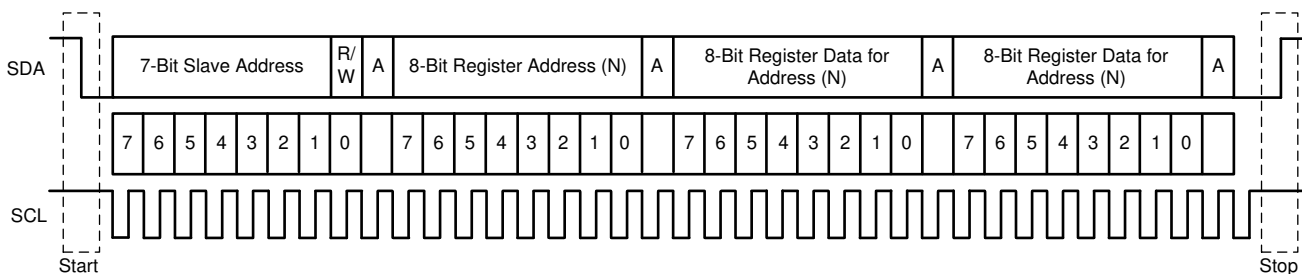
### 10.5.3 Random Write

As shown in 图 32, a single-byte data-write transfer begins with the master device transmitting a start condition followed by the I<sup>2</sup>C device address and the R/W bit. The R/W bit determines the direction of the data transfer. For a write data transfer, the R/W bit is a 0. After receiving the correct I<sup>2</sup>C device address and the R/W bit, the device responds with an acknowledge bit. Next, the master transmits the address byte or bytes corresponding to the internal memory address being accessed. After receiving the address byte, the device again responds with an acknowledge bit. Next, the master device transmits the data byte to be written to the memory address being accessed. After receiving the data byte, the device again responds with an acknowledge bit. Finally, the master device transmits a stop condition to complete the single-byte data-write transfer.

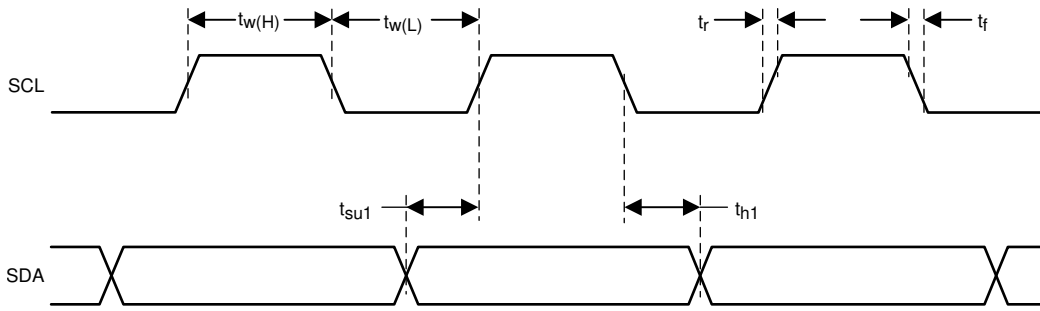

图 32. Random Write Transfer

### 10.5.4 Sequential Write

A sequential data-write transfer is identical to a single-byte data-write transfer except that multiple data bytes are transmitted by the master to the device as shown in 图 33. After receiving each data byte, the device responds with an acknowledge bit and the I<sup>2</sup>C subaddress is automatically incremented by one.

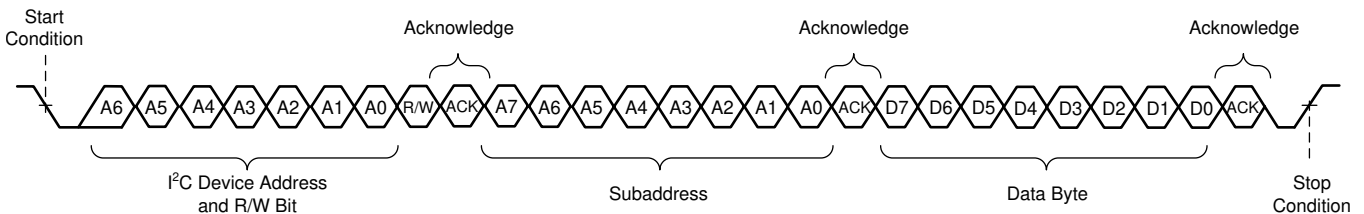

图 33. Sequential Write Transfer

### 10.5.5 Random Read

As shown in 图 34, a single-byte data-read transfer begins with the master device transmitting a start condition followed by the I<sup>2</sup>C device address and the R/W bit. For the data-read transfer, both a write followed by a read occur. Initially, a write occurs to transfer the address byte or bytes of the internal memory address to be read. As a result, the R/W bit is a 0. After receiving the address and the R/W bit, the device responds with an acknowledge bit. In addition, after sending the internal memory address byte or bytes, the master device

transmits another start condition followed by the address and the R/W bit again. This time the R/W bit is a 1, indicating a read transfer. After receiving the address and the R/W bit, the device again responds with an acknowledge bit. Next, the device transmits the data byte from the memory address being read. After receiving the data byte, the master device transmits a not-acknowledge followed by a stop condition to complete the single-byte data-read transfer.

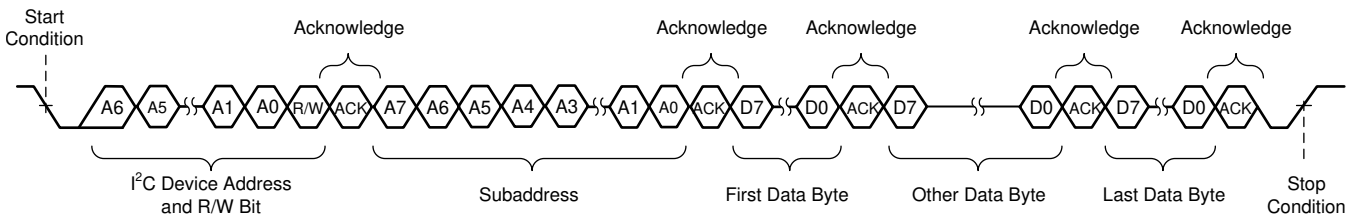
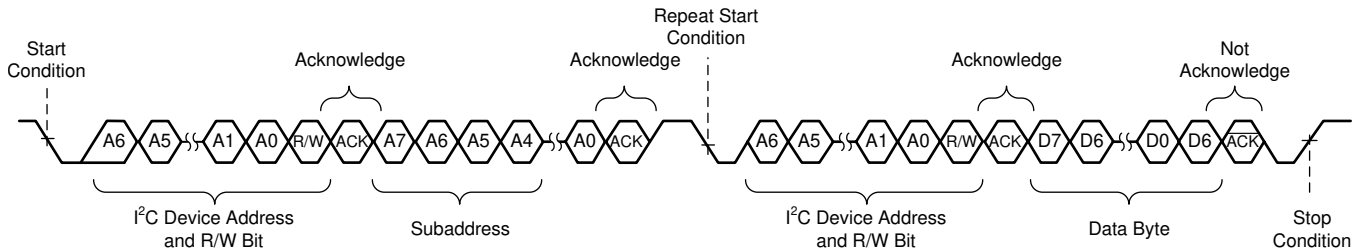

**图 34. Random Read Transfer**

### 10.5.6 Sequential Read

A sequential data-read transfer is identical to a single-byte data-read transfer except that multiple data bytes are transmitted by the device to the master device as shown in [图 35](#). Except for the last data byte, the master device responds with an acknowledge bit after receiving each data byte and automatically increments the I<sup>2</sup>C subaddress by one. After receiving the last data byte, the master device transmits a not-acknowledge bit followed by a stop condition to complete the transfer.

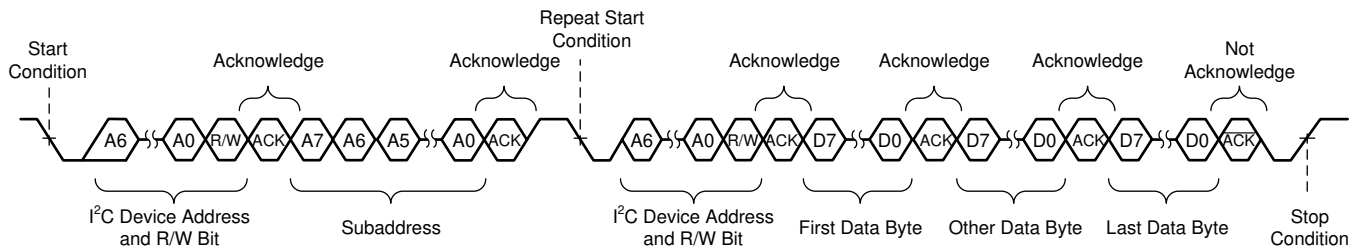

**图 35. Sequential Read Transfer**



## 10.6 Register Maps

**表 8. I<sup>2</sup>C Address Register Definitions**

Address	Type	Register Description	Section
0x00	R/W	Mode Control	<a href="#">Go</a>
0x01	R/W	Miscellaneous Control 1	<a href="#">Go</a>
0x02	R/W	Miscellaneous Control 2	<a href="#">Go</a>
0x03	R/W	SAP Control (Serial Audio-Port Control)	<a href="#">Go</a>
0x04	R/W	Channel State Control	<a href="#">Go</a>
0x05	R/W	Channel 1 Volume Control	<a href="#">Go</a>
0x06	R	RESERVED	
0x07	R	RESERVED	
0x08	R	RESERVED	
0x09	R/W	DC Diagnostic Control 1	<a href="#">Go</a>
0x0A	R/W	DC Diagnostic Control 2	<a href="#">Go</a>
0x0B	R	RESERVED	
0x0C	R	DC Load Diagnostic Report 1	<a href="#">Go</a>
0x0D	R	RESERVED	
0x0E	R	DC Load Diagnostic Report 3 - Line Output	<a href="#">Go</a>
0x0F	R	Channel State Reporting	<a href="#">Go</a>
0x10	R	Channel Faults (Overcurrent, DC Detection)	<a href="#">Go</a>
0x11	R	Global Faults 1	<a href="#">Go</a>
0x12	R	Global Faults 2	<a href="#">Go</a>
0x13	R	Warnings	<a href="#">Go</a>
0x14	R/W	Pin Control	<a href="#">Go</a>
0x15	R/W	AC Load Diagnostic Control 1	<a href="#">Go</a>
0x16	R/W	AC Load Diagnostic Control 2	<a href="#">Go</a>
0x17	R	AC Load Diagnostic Report Channel 1	<a href="#">Go</a>
0x18	R	RESERVED	
0x19	R	RESERVED	
0x1A	R	RESERVED	
0x1B	R	AC Load Diagnostic Phase Report High	<a href="#">Go</a>
0x1C	R	AC Load Diagnostic Phase Report Low	<a href="#">Go</a>
0x1D	R	AC Load Diagnostic STI Report High	<a href="#">Go</a>
0x1E	R	AC Load Diagnostic STI Report Low	<a href="#">Go</a>
0x1F	R	RESERVED	
0x20	R	RESERVED	
0x21	R/W	Miscellaneous Control 3	<a href="#">Go</a>
0x22	R/W	Clip Control	<a href="#">Go</a>
0x23	R/W	Clip Window	<a href="#">Go</a>
0x24	R	Clip Warning	<a href="#">Go</a>
0x25	R	ILIMIT Status	<a href="#">Go</a>
0x26	R/W	Miscellaneous Control 4	<a href="#">Go</a>
0x27	R	RESERVED	
0x28	R	RESERVED	

### 10.6.1 Mode Control Register (address = 0x00) [default = 0x00]

The Mode Control register is shown in 图 36 and described in 表 9.

图 36. Mode Control Register

7	6	5	4	3	2	1	0
RESET	RESERVED			CH1 LO MODE	RESERVED		
R/W-0				R/W-0			

表 9. Mode Control Field Descriptions

Bit	Field	Type	Reset	Description
7	RESET	R/W	0	<b>0: Normal operation</b> 1: Resets the device. Self-clearing, reads back 0.
6-4	RESERVED	R/W	000	RESERVED
3	CH1 LO MODE	R/W	0	<b>0: Channel 1 is in normal/speaker mode</b> 1: Channel 1 is in line output mode
2-0	RESERVED	R/W	000	RESERVED

### 10.6.2 Miscellaneous Control 1 Register (address = 0x01) [default = 0x32]

The Miscellaneous Control 1 register is shown in 图 37 and described in 表 10.

图 37. Miscellaneous Control 1 Register

7	6	5	4	3	2	1	0
HPF BYPASS	OTW CONTROL		OC CONTROL	VOLUME RATE		GAIN	
R/W-0	R/W-01		R/W-1	R/W-00		R/W-10	

表 10. Misc Control 1 Field Descriptions

Bit	Field	Type	Reset	Description
7	HPF BYPASS	R/W	0	<b>0: High pass filter enabled</b> 1: High pass filter disabled
6–5	OTW CONTROL	R/W	01	00: Global overtemperature warning set to 140°C <b>01: Global overtemperature warning set to 130C</b> 10: Global overtemperature warning set to 120°C 11: Global overtemperature warning set to 110°C
4	OC CONTROL	R/W	1	0: Overcurrent is level 1 <b>1: Overcurrent is level 2</b>
3–2	VOLUME RATE	R/W	00	<b>00: Volume update rate is 1 step / FSYNC</b> 01: Volume update rate is 1 step / 2 FSYNCs 10: Volume update rate is 1 step / 4 FSYNCs 11: Volume update rate is 1 step / 8 FSYNCs
1–0	GAIN	R/W	10	00: Gain level 1 = 7.5 V peak output voltage 01: Gain Level 2 = 15 V peak output voltage <b>10: Gain Level 3 = 21 V peak output voltage</b> 11: Gain Level 4 = 29 V peak output voltage

### 10.6.3 Miscellaneous Control 2 Register (address = 0x02) [default = 0x62]

The Miscellaneous Control 2 register is shown in 图 38 and described in 表 11.

**图 38. Miscellaneous Control 2 Register**

7	6	5	4	3	2	1	0
RESERVED	PWM FREQUENCY			RESERVED	SDM_OSR	RESERVED	
R/W-110				R/W-0			

**表 11. Misc Control 2 Field Descriptions**

Bit	Field	Type	Reset	Description
7	RESERVED	R/W	0	RESERVED
6–4	PWM FREQUENCY	R/W	110	000: $8 \times f_S$ (352.8 kHz / 384 kHz) 001: $10 \times f_S$ (441 kHz / 480 kHz) 010: RESERVED 011: RESERVED 100: RESERVED 101: $38 \times f_S$ (1.68 MHz / 1.82 MHz) <b>110: <math>44 \times f_S</math> (1.94 MHz / 2.11 MHz)</b> 111: $48 \times f_S$ (2.12 MHz / not supported)
3	RESERVED	R/W	0	RESERVED
2	SDM_OSR	R/W	0	<b>0: 64x Oversampling rate</b> 1: 128x Oversampling rate
1–0	RESERVED	R/W	10	RESERVED

#### 10.6.4 SAP Control (Serial Audio-Port Control) Register (address = 0x03) [default = 0x04]

The SAP Control (serial audio-port control) register is shown in 图 39 and described in 表 12.

**图 39. SAP Control Register**

7	6	5	4	3	2	1	0
INPUT SAMPLING RATE		TDM SLOT SELECT			INPUT FORMAT		
R/W-00		R/W-000			R/W-100		

**表 12. SAP Control Field Descriptions**

Bit	Field	Type	Reset	Description
7–6	INPUT SAMPLING RATE	R/W	00	<b>00: 44.1 kHz</b> 01: 48 kHz 10: 96 kHz 11: RESERVED
5–3	TDM SLOT SELECT	R/W	000	<b>000: Select slot 1 in TDM8/4 or channel 1 in I<sup>2</sup>S mode</b> 001: Select slot 2 in TDM8/4 or channel 2 in I <sup>2</sup> S mode 010: Select slot 3 in TDM8/4 011: Select slot 4 in TDM8/4 100: Select slot 5 in TDM8 101: Select slot 6 in TDM8 110: Select slot 7 in TDM8 111: Select slot 8 in TDM8
2–0	INPUT FORMAT	R/W	100	000: 24-bit right justified 001: 20-bit right justified 010: 18-bit right justified 011: 16-bit right justified <b>100: I<sup>2</sup>S (16-bit or 24-bit)</b> 101: Left justified (16-bit or 24-bit) 110: DSP mode (16-bit or 24-bit) 111: RESERVED

**10.6.5 Channel State Control Register (address = 0x04) [default = 0x55]**

The Channel State Control register is shown in [图 40](#) and described in [表 13](#).

**图 40. Channel State Control Register**

7	6	5	4	3	2	1	0
CH1 STATE CONTROL			RESERVED				
R/W-01							

**表 13. Channel State Control Field Descriptions**

Bit	Field	Type	Reset	Description
7–6	CH1 STATE CONTROL	R/W	01	00: PLAY <b>01: Hi-Z</b> 10: MUTE 11: DC load diagnostics
5–0	RESERVED	R/W	010101	RESERVED

### 10.6.6 Channel 1 Volume Control Register (address = 0x05) [default = 0xCF]

The Channel 1 Volume Control registers is shown in 图 41 and described in 表 14.

图 41. Channel 1 Volume Control Register

7	6	5	4	3	2	1	0
CH 1 VOLUME							
R/W-11001111							

表 14. Ch 1 Volume Control Field Descriptions

Bit	Field	Type	Reset	Description
7–0	CH 1 VOLUME	R/W	11001111	8-Bit Volume Control for the output channel, 0.5 dB/step: 0xFF: 24 dB <b>0xCF: 0 dB</b> 0x07: –100 dB < 0x07: MUTE

### 10.6.7 DC Load Diagnostic Control 1 Register (address = 0x09) [default = 0x00]

The DC Diagnostic Control 1 register is shown in 图 42 and described in 表 15.

图 42. DC Load Diagnostic Control 1 Register

7	6	5	4	3	2	1	0
DC LDG ABORT	2x_RAMP	2x_SETTLE	RESERVED			LDG LO ENABLE	LDG BYPASS
R/W-0	R/W-0	R/W-0				R/W-0	R/W-0

表 15. DC Load Diagnostics Control 1 Field Descriptions

Bit	Field	Type	Reset	Description
7	DC LDG ABORT	R/W	0	<b>0: Default state, clear after abort</b> 1: Aborts the load diagnostics in progress
6	2x_RAMP	R/W	0	<b>0: Normal ramp time</b> 1: Double ramp time
5	2x_SETTLE	R/W	0	<b>0: Normal Settle time</b> 1: Double settling time
4–2	RESERVED	R/W	000	RESERVED
1	LDG LO ENABLE	R/W	0	<b>0: Line output diagnostics are disabled</b> 1: Line output diagnostics are enabled
0	LDG BYPASS	R/W	0	<b>0: Automatic diagnostics when leaving Hi-Z and after channel fault</b> 1: Diagnostics are not run automatically

### 10.6.8 DC Load Diagnostic Control 2 Register (address = 0x0A) [default = 0x11]

The DC Diagnostic Control 2 register is shown in 图 43 and described in 表 16.

图 43. DC Load Diagnostic Control 2 Register

7	6	5	4	3	2	1	0
CH1 DC LDG SL				RESERVED			
R/W-0001							

**表 16. DC Load Diagnostics Control 2 Field Descriptions**

Bit	Field	Type	Reset	Description
7–4	CH1 DC LDG SL	R/W	0001	DC load diagnostics shorted-load threshold 0000: 0.5 Ω <b>0001: 1 Ω</b> 0010: 1.5 Ω ... 1001: 5 Ω
3–0	RESERVED	R/W	0001	RESERVED

**10.6.9 DC Load Diagnostic Report 1 Register (address = 0x0C) [default = 0x00]**

 DC Load Diagnostic Report 1 register is shown in [图 44](#) and described in [表 17](#).

**图 44. DC Load Diagnostic Report 1 Register**

7	6	5	4	3	2	1	0
CH1 S2G	CH1 S2P	CH1 OL	CH1 SL	RESERVED			
R-0	R-0	R-0	R-0				

**表 17. DC Load Diagnostics Report 1 Field Descriptions**

Bit	Field	Type	Reset	Description
7	CH1 S2G	R	0	<b>0: No short-to-GND detected</b> 1: Short-To-GND Detected
6	CH1 S2P	R	0	<b>0: No short-to-power detected</b> 1: Short-to-power detected
5	CH1 OL	R	0	<b>0: No open load detected</b> 1: Open load detected
4	CH1 SL	R	0	<b>0: No shorted load detected</b> 1: Shorted load detected
3–0	RESERVED	R	0000	RESERVED

### 10.6.10 DC Load Diagnostics Report 3 Line Output Register (address = 0x0E) [default = 0x00]

The DC Load Diagnostic Report, Line Output, register is shown in 图 45 and described in 表 18.

图 45. DC Load Diagnostics Report 3 Line Output Register

7	6	5	4	3	2	1	0
RESERVED				CH1 LO LDG	RESERVED		
R-0							

表 18. DC Load Diagnostics Report 3 Line Output Field Descriptions

Bit	Field	Type	Reset	Description
7–4	RESERVED	R	0000	RESERVED
3	CH1 LO LDG	R	0	<b>0: No line output detected on channel 1</b> 1: Line output detected on channel 1
2–0	RESERVED	R	000	RESERVED

### 10.6.11 Channel State Reporting Register (address = 0x0F) [default = 0x40]

The Channel State Reporting register is shown in 图 46 and described in 表 19.

图 46. Channel State-Reporting Register

7	6	5	4	3	2	1	0
CH1 STATE REPORT		RESERVED					
R-01							

表 19. State-Reporting Field Descriptions

Bit	Field	Type	Reset	Description
7–6	CH1 STATE REPORT	R	01	<b>00: PLAY</b> <b>01: Hi-Z</b> 10: MUTE 11: DC load diagnostics
5–0	RESERVED	R	000000	RESERVED

### 10.6.12 Channel Faults (Overcurrent, DC Detection) Register (address = 0x10) [default = 0x00]

The Channel Faults (overcurrent, DC detection) register is shown in 图 47 and described in 表 20.

图 47. Channel Faults Register

7	6	5	4	3	2	1	0
CH1 OC	RESERVED			CH1 DC	RESERVED		
R-0				R-0			

表 20. Channel Faults Field Descriptions

Bit	Field	Type	Reset	Description
7	CH1 OC	R	0	<b>0: No overcurrent fault detected</b> 1: Overcurrent fault detected
6–4	RESERVED	R	000	RESERVED
3	CH1 DC	R	0	<b>0: No DC fault detected</b> 1: DC fault detected
2–0	RESERVED	R	000	RESERVED

**10.6.13 Global Faults 1 Register (address = 0x11) [default = 0x00]**

The Global Faults 1 register is shown in 图 48 and described in 表 21.

**图 48. Global Faults 1 Register**

7	6	5	4	3	2	1	0
RESERVED			INVALID CLOCK	PVDD OV	VBAT OV	PVDD UV	VBAT UV
			R-0	R-0	R-0	R-0	R-0

**表 21. Global Faults 1 Field Descriptions**

Bit	Field	Type	Reset	Description
7–5	RESERVED	R	000	RESERVED
4	INVALID CLOCK	R	0	<b>0: No clock fault detected</b> 1: Clock fault detected
3	PVDD OV	R	0	<b>0: No PVDD overvoltage fault detected</b> 1: PVDD overvoltage fault detected
2	VBAT OV	R	0	<b>0: No VBAT overvoltage fault detected</b> 1: VBAT overvoltage fault detected
1	PVDD UV	R	0	<b>0: No PVDD undervoltage fault detected</b> 1: PVDD undervoltage fault detected
0	VBAT UV	R	0	<b>0: No VBAT undervoltage fault detected</b> 1: VBAT undervoltage fault detected

**10.6.14 Global Faults 2 Register (address = 0x12) [default = 0x00]**

The Global Faults 2 register is shown in 图 49 and described in 表 22.

**图 49. Global Faults 2 Register**

7	6	5	4	3	2	1	0
RESERVED			OTSD	CH1 OTSD	RESERVED		
			R-0	R-0			

**表 22. Global Faults 2 Field Descriptions**

Bit	Field	Type	Reset	Description
7–5	RESERVED	R	000	RESERVED
4	OTSD	R	0	<b>0: No global overtemperature shutdown</b> 1: Global overtemperature shutdown
3	CH1 OTSD	R	0	<b>0: No overtemperature shutdown on Ch1</b> 1: Overtemperature shutdown on Ch1
2–0	RESERVED	R	000	RESERVED

**10.6.15 Warnings Register (address = 0x13) [default = 0x20]**

The Warnings register is shown in 图 50 and described in 表 23.

**图 50. Warnings Register**

7	6	5	4	3	2	1	0
RESERVED		VDD POR	OTW	OTW CH1	RESERVED		
		R-1	R-0	R-0			



**表 23. Warnings Field Descriptions**

Bit	Field	Type	Reset	Description
7–6	RESERVED	R	00	RESERVED
5	VDD POR	R	1	0: No VDD POR has occurred 1: <b>VDD POR occurred</b>
4	OTW	R	0	0: <b>No global overtemperature warning</b> 1: Global overtemperature warning
3	OTW CH1	R	0	0: <b>No overtemperature warning on channel 1</b> 1: Overtemperature warning on channel 1
2–0	RESERVED	R	000	RESERVED

**10.6.16 Pin Control Register (address = 0x14) [default = 0x00]**

The Pin Control register is shown in 图 51 and described in 表 24.

**图 51. Pin Control Register**

7	6	5	4	3	2	1	0
MASK OC	MASK OTSD	MASK UV	MASK OV	MASK DC	RESERVED	MASK CLIP	MASK OTW
R/W-0	R/W-0	R/W-0	R/W-0	R/W-0		R/W-0	R/W-0

**表 24. Pin Control Field Descriptions**

Bit	Field	Type	Reset	Description
7	MASK OC	R/W	0	0: <b>Report overcurrent faults on the <math>\overline{\text{FAULT}}</math> pin</b> 1: Do not report overcurrent faults on the $\overline{\text{FAULT}}$ Pin
6	MASK OTSD	R/W	0	0: <b>Report overtemperature faults on the <math>\overline{\text{FAULT}}</math> pin</b> 1: Do not report overtemperature faults on the $\overline{\text{FAULT}}$ pin
5	MASK UV	R/W	0	0: <b>Report undervoltage faults on the <math>\overline{\text{FAULT}}</math> pin</b> 1: Do not report undervoltage faults on the $\overline{\text{FAULT}}$ pin
4	MASK OV	R/W	0	0: <b>Report overvoltage faults on the <math>\overline{\text{FAULT}}</math> pin</b> 1: Do not report overvoltage faults on the $\overline{\text{FAULT}}$ pin
3	MASK DC	R/W	0	0: <b>Report DC faults on the <math>\overline{\text{FAULT}}</math> pin</b> 1: Do not report DC faults on the $\overline{\text{FAULT}}$ pin
2	RESERVED	R/W	0	RESERVED
1	MASK CLIP	R/W	0	0: <b>Report clipping on the configured pin (<math>\overline{\text{WARN}}</math> or <math>\overline{\text{FAULT}}</math>)</b> 1: Do not report clipping on the configured pin ( $\overline{\text{WARN}}$ or $\overline{\text{FAULT}}$ )
0	MASK OTW	R/W	0	0: <b>Report overtemperature warnings on the <math>\overline{\text{WARN}}</math> pin</b> 1: Do not report overtemperature warnings on the $\overline{\text{WARN}}$ pin

**10.6.17 AC Load Diagnostic Control 1 Register (address = 0x15) [default = 0x00]**

The AC Load Diagnostic Control 1 register is shown in 图 52 and described in 表 25.

**图 52. AC Load Diagnostic Control 1 Register**

7	6	5	4	3	2	1	0
CH1 GAIN	RESERVED			CH1 ENABLE	RESERVED		
R/W-0				R/W-0			

**表 25. AC Load Diagnostic Control 1 Field Descriptions**

Bit	Field	Type	Reset	Description
7	CH1: GAIN	R/W	0	<b>0: Gain 1</b> 1: Gain 4
6–4	RESERVED	R/W	000	RESERVED
3	CH1 ENABLE	R/W	0	<b>0: AC diagnostics disabled</b> 1: Enable AC diagnostics
2–0	RESERVED	R/W	000	RESERVED

**10.6.18 AC Load Diagnostic Control 2 Register (address = 0x16) [default = 0x00]**

The AC Load Diagnostic Control 2 register is shown in 图 53 and described in 表 26.

**图 53. AC Load Diagnostic Control 2 Register**

7	6	5	4	3	2	1	0
AC_DIAGS_LO OPBACK	RESERVED		AC TIMING	AC CURRENT		RESERVED	
R/W-0			R/W-0	R/W-0	R/W-0		

**表 26. AC Load Diagnostic Control 2 Field Descriptions**

Bit	Field	Type	Reset	Description
7	AC_DIAGS_LOOPBACK	R/W	0	<b>0: Disable AC Diag loopback</b> 1: Enable AC Diag loopback
6-5	RESERVED	R/W	00	RESERVED
4	AC TIMING	R/W	0	<b>0: 32 Cycles</b> 1: 64 Cycles
3-2	AC CURRENT	R/W	00	<b>00: 10mA</b> 01: 19 mA 10: RESERVED 11: RESERVED
1-0	RESERVED	R/W	00	RESERVED

**10.6.19 AC Load Diagnostic Impedance Report Ch1 Register (address = 0x17) [default = 0x00]**

The AC Load Diagnostic Report Ch1 registers is shown in 图 54 and described in 表 27.

**图 54. AC Load Diagnostic Impedance Report Ch1 Register**

7	6	5	4	3	2	1	0
CH1 IMPEDANCE							
R-00000000							

**表 27. Ch1 AC LDG Impedance Report Field Descriptions**

Bit	Field	Type	Reset	Description
7–0	CH1 IMPEDANCE	R	00000000	8-bit AC-load diagnostic report for each channel with a step size of 0.2496 $\Omega$ /bit (control by register 0x15 and register 0x16) <b>0x00000000: 0 <math>\Omega</math></b> 0x00000001: 0.2496 $\Omega$ ... 0x11111111: 63.65 $\Omega$

### 10.6.20 AC Load Diagnostic Phase Report High Register (address = 0x1B) [default = 0x00]

The AC Load Diagnostic Phase High value registers is shown in 图 55 and described in 表 28.

图 55. AC Load Diagnostic (LDG) Phase High Report Register

7	6	5	4	3	2	1	0
AC Phase High							
R-00000000							

表 28. AC LDG Phase High Report Field Descriptions

Bit	Field	Type	Reset	Description
7–0	AC Phase High	R	00000000	Bit 15:8

### 10.6.21 AC Load Diagnostic Phase Report Low Register (address = 0x1C) [default = 0x00]

The AC Load Diagnostic Phase Low value registers is shown in 图 56 and described in 表 29.

图 56. AC Load Diagnostic (LDG) Phase Low Report Register

7	6	5	4	3	2	1	0
AC Phase Low							
R-00000000							

表 29. AC LDG Phase Low Report Field Descriptions

Bit	Field	Type	Reset	Description
7–0	AC Phase Low	R	00000000	Bit 7:0

### 10.6.22 AC Load Diagnostic STI Report High Register (address = 0x1D) [default = 0x00]

The AC Load Diagnostic STI High value registers is shown in 图 57 and described in 表 30.

图 57. AC Load Diagnostic (LDG) STI High Report Register

7	6	5	4	3	2	1	0
AC STI High							
R-00000000							

表 30. AC LDG STI High Report Field Descriptions

Bit	Field	Type	Reset	Description
7–0	AC STI High	R	00000000	Bit 15:8

**10.6.23 AC Load Diagnostic STI Report Low Register (address = 0x1E) [default = 0x00]**

The AC Load Diagnostic STI Low value registers is shown in [图 58](#) and described in [表 31](#).

**图 58. AC Load Diagnostic (LDG) STI Low Report Register**

7	6	5	4	3	2	1	0
AC STI Low							
R-00000000							

**表 31. Ch1 AC LDG STI Low Report Field Descriptions**

Bit	Field	Type	Reset	Description
7–0	AC STI Low	R	00000000	Bit 7:0

**10.6.24 Miscellaneous Control 3 Register (address = 0x21) [default = 0x00]**

The Miscellaneous Control 3 register is shown in [图 59](#) and described in [表 32](#).

**图 59. Miscellaneous Control 3 Register**

7	6	5	4	3	2	1	0
CLEAR FAULT	TDM SLOT SIZE	MASK ILIMIT WARNING	RESERVED	OTSD AUTO RECOVERY	RESERVED		
R/W-0	R/W-0	R/W-0		R/W-0			

**表 32. Misc Control 3 Field Descriptions**

Bit	Field	Type	Reset	Description
7	CLEAR FAULT	R/W	0	<b>0: Normal operation</b> 1: Clear fault
6	TDM SLOT SIZE	R/W	0	<b>0: TDM slot size is 24-bit or 32-bit</b> 1: TDM slot size is 16-bit
5	MASK ILIMIT WARNING	R/W	0	<b>0: Report ILIMIT on the <math>\overline{\text{WARN}}</math> pin</b> 1: Do not report ILIMIT on the $\overline{\text{WARN}}$ pin
4	RESERVED	R/W	0	RESERVED
3	OTSD AUTO RECOVERY	R/W	0	<b>0: OTSD is latched</b> 1: OTSD is auto-recovery
2–0	RESERVED	R/W	000	RESERVED

**10.6.25 Clip Control Register (address = 0x22) [default = 0x01]**

The Clip Detect register is shown in [图 60](#) and described in [表 33](#). To ensure the Clip Detect Warning is operating according to the expectation, the related bit values in the [Clip Window Register \(address = 0x23\) \[default = 0x14\]](#) and [Clip Warning Register](#) must be set accordingly.

**图 60. Clip Control Register**

7	6	5	4	3	2	1	0
RESERVED					CLIP_PIN	CLIP_LATCH	CLIPDET_EN
					R/W-0	R/W-0	R/W-1

**表 33. Clip Control Field Descriptions**

Bit	Field	Type	Reset	Description
7–3	RESERVED	R/W	00000	RESERVED
2	CLIP_PIN	R/W	0	<b>0: CH1 Clip Detect reports to <math>\overline{\text{WARN}}</math> pin</b> 1: CH1 Clip Detect reports to $\overline{\text{FAULT}}$ pin

**表 33. Clip Control Field Descriptions (接下页)**

Bit	Field	Type	Reset	Description
1	CLIP_LATCH	R/W	0	<b>0:</b> Pin latching <b>1:</b> Pin non-latching
0	CLIPDET_EN	R/W	1	<b>0:</b> Clip detect disable <b>1:</b> <b>Clip Detect Enable</b>

### 10.6.26 Clip Window Register (address = 0x23) [default = 0x14]

The Clip Window register is shown in [图 61](#) and described in [表 34](#). The register value represents the minimum number of 100% duty-cycle PWM cycles in hexadecimal notation before Clip Detect is reported. A register value of 0 is not permitted. If Clip Detect is set to non-latching, the register value has no function.

**图 61. Clip Window Register**

7	6	5	4	3	2	1	0
CLIP_WINDOW_SEL[7:1]							
R/W-00010100							

**表 34. Clip Window Field Descriptions**

Bit	Field	Type	Reset	Description
7–0	CLIP_WINDOW_SEL[7:1]	R/W	00010100	<b>00010100:</b> 20 100% duty-cycle PWM cycles before Clip Detect is triggered

### 10.6.27 Clip Warning Register (address = 0x24) [default = 0x00]

The Clip Window register is shown in [图 62](#) and described in [表 35](#).

**图 62. Clip Warning Register**

7	6	5	4	3	2	1	0
RESERVED							CH1_CLIP
R-0							

**表 35. Clip Warning Field Descriptions**

Bit	Field	Type	Reset	Description
7–1	RESERVED	R	0000000	RESERVED
0	CH1_CLIP	R	0	<b>0:</b> No Clip Detect <b>1:</b> Clip Detect

### 10.6.28 ILIMIT Status Register (address = 0x25) [default = 0x00]

The ILIMIT Status register is shown in [图 63](#) and described in [表 36](#).

**图 63. ILIMIT Status Register**

7	6	5	4	3	2	1	0
RESERVED							CH1_ILIMIT_W ARN
R-0							

**表 36. ILIMIT Status Field Descriptions**

Bit	Field	Type	Reset	Description
7–1	RESERVED	R	0000000	RESERVED
0	CH1_ILIMIT_WARN	R	0	<b>0:</b> No ILIMIT <b>1:</b> ILIMIT Warning

**10.6.29 Miscellaneous Control 4 Register (address = 0x26) [default = 0x40]**

The Miscellaneous Control 4 register is shown in and described in 表 37.

**图 64. Miscellaneous Control 4 Register**

7	6	5	4	3	2	1	0
RESERVED				BCLK_INV	HPF_CORNER[2:0]		
				R/W-0	R/W-000		

**表 37. Misc Control 4 Field Descriptions**

Bit	Field	Type	Reset	Description
7–4	RESERVED	R/W	0100	RESERVED
3	BCLK_INV	R/W	0	<b>0: All other MCLK/BCLK frequency / phase use cases</b> 1: Inverted MCLK/BCLK phase relationship when MCLK/BCLK run at the same frequency
2–0	HPF_CORNER[2:0]	R/W	000	<b>000: 3.7 Hz</b> 001: 7.4 Hz 010: 15 Hz 011: 30 Hz 100: 59 Hz 101: 118 Hz 110: 235 Hz 111: 463 Hz

## 11 Application and Implementation

### 注

Information in the following applications sections is not part of the TI component specification, and TI does not warrant its accuracy or completeness. TI's customers are responsible for determining suitability of components for their purposes. Customers should validate and test their design implementation to confirm system functionality.

### 11.1 Application Information

The TAS6421-Q1 is a mono-channel class-D digital-input audio-amplifier design for use in automotive head units and external amplifier modules. The TAS6421-Q1 incorporates the necessary functionality to perform in demanding OEM applications.

#### 11.1.1 AM-Radio Band Avoidance

AM-radio frequency interference can be avoided by setting the switching frequency of the device above the AM band. The switching frequency options available are  $38 \times f_s$ ,  $44 \times f_s$ , and  $48 \times f_s$ . If the switch frequency cannot be set above the AM band, then use the two options of  $8 \times f_s$  and  $10 \times f_s$ . These options should be changed to avoid AM active channels.

#### 11.1.2 Demodulation Filter Design

The amplifier outputs are driven by high-current LDMOS transistors in an H-bridge configuration. These transistors are either fully off or fully on. The result is a square-wave output signal with a duty cycle that is proportional to the amplitude of the audio signal. An LC demodulation filter is used to recover the audio signal. The filter attenuates the high-frequency components of the output signals that are out of the audio band. The design of the demodulation filter significantly affects the audio performance of the power amplifier. Therefore, to meet the system THD+N requirements, the selection of the inductors used in the output filter should be carefully considered.

#### 11.1.3 Line Driver Applications

In many automotive audio applications, the same head unit must drive either a speaker (with several ohms of impedance) or an external amplifier input (with several kilohms of impedance). The design is capable of supporting both applications and has special line-drive gain and diagnostics. Coupled with the high switching frequency, the device is well suited for this type of application. Set the output channel in line driver mode through I<sup>2</sup>C register 0x00, the externally connected amplifier must have a differential impedance from 600 Ω to 4.7 kΩ for the DC line diagnostic to detect the connected external amplifier. 图 65 shows the recommended external amplifier input configuration.



图 65. External Amplifier Input Configuration for Line Driver

## 11.2 Typical Applications

### 11.2.1 BTL Application

图 66 shows the schematic of a typical mono-channel solution in a typical use case.

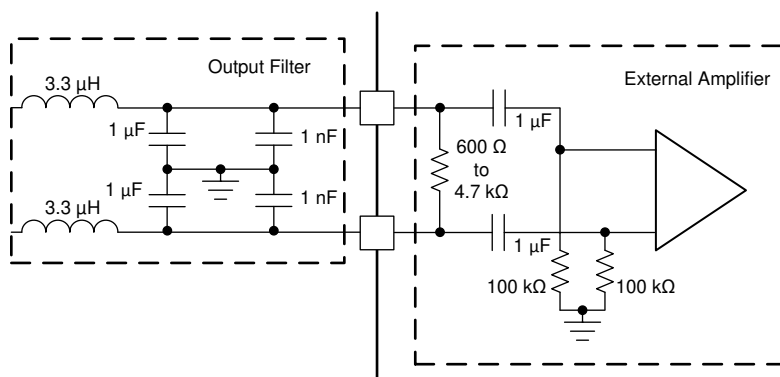

图 66. TAS6421-Q1 Typical Mono-Channel BTL Application Schematic



## Typical Applications (接下页)

### 11.2.1.1 Design Requirements

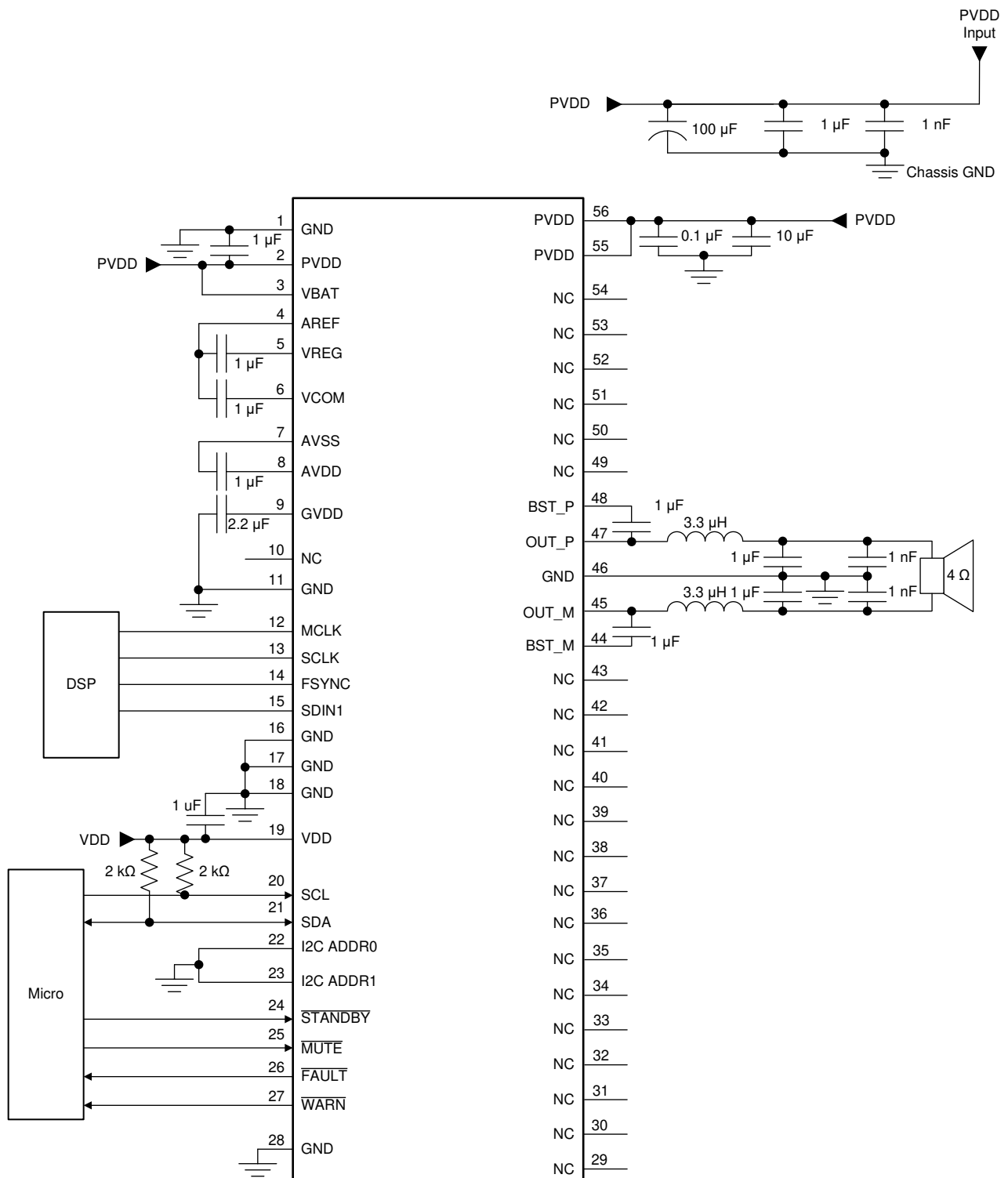
Use the following requirements for this design:

- This example is focused on the smallest solution size for 1× 25 W output power into 4 Ω with a battery supply of 14.4 V.
- The switching frequency is set above the AM-band with 44 times the input sample rate of 48 kHz which results in a frequency of 2.11 MHz.
- The selection of a 2.11 MHz switching frequency enables the use of a small output inductor value of 3.3 μH which leads to a very small solution size.

#### 11.2.1.1.1 Communication

All communications to the TAS6421-Q1 are through the I<sup>2</sup>C protocol. A system controller can communicate with the device through the SDA pins and SCL pins. The TAS6421-Q1 is an I<sup>2</sup>C slave device and requires a master. The device cannot generate an I<sup>2</sup>C clock or initiate a transaction. The maximum clock speed accepted by the device is 400 kHz. If multiple TAS6421-Q1 devices are on the same I<sup>2</sup>C bus, the I<sup>2</sup>C address must be different for each device. Up to four TAS6421-Q1 devices can be on the same I<sup>2</sup>C bus.

The I<sup>2</sup>C bus is shared internally.

---

**注**

Complete any internal operations, such as load diagnostics, before reading the registers for the results.

---

### 11.2.1.2 Detailed Design Procedure

#### 11.2.1.2.1 Hardware Design

Use the following procedure for the hardware design:

- Determine the input format. The input format can be either I<sup>2</sup>S or TDM mode. The mode determines the correct pin connections and the I<sup>2</sup>C register settings.
- Determine the power output that is required into the load. The power requirement determines the required power-supply voltage and current. The output reconstruction-filter components that are required are also driven by the output power.
- With the requirements, adjust the typical application schematic in [图 66](#) for the input connections.

#### 11.2.1.2.2 Digital Input and the Serial Audio Port

The TAS6421-Q1 device supports four different digital input formats which are: I<sup>2</sup>S, Right Justified, Left Justified, and TDM mode. Depending on the format, the device can support 16, 18, 20, 24, and 32 bit data. The supported frequencies are 96 kHz, 48 kHz, and 44.1 kHz. Please see [SAP Control \(Serial Audio-Port Control\) Register \(address = 0x03\) \[default = 0x04\]](#) for the complete matrix to set up the serial audio port.

---

**注**

Bits 3, 4, and 5 in this register are ignored in all input formats except for TDM. Setting up all the control registers to the system requirements should be done before the device is placed in Mute mode or Play mode. After the registers are setup, use bit 7 in register 0x21 to clear any faults. Then read the fault registers to make sure no faults are present. When no faults are present, use register 0x04 to place the device properly into play mode.

---

#### 11.2.1.2.3 Bootstrap Capacitors

The bootstrap capacitors provide the gate-drive voltage of the upper N-channel FET. These capacitors must be sized appropriately for the system specification. A special condition can occur where the bootstrap may sag if the capacitor is not sized accordingly. The special condition is just below clipping where the PWM is slightly less than 100% duty cycle with sustained low-frequency signals. Changing the bootstrap capacitor value to 2.2 μF for driving subwoofers that require frequencies below 30 Hz may be necessary.

## Typical Applications (接下页)

### 11.2.1.2.4 Output Reconstruction Filter

The output FETs drive the amplifier outputs in an H-Bridge configuration. These transistors are either fully off or fully on. The result is a square-wave output signal with a duty cycle that is proportional to the amplitude of the audio signal. The amplifier outputs require a reconstruction filter that comprises a series inductor and a capacitor to ground on each output, generally called an LC filter. The LC filter attenuates the PWM frequency and reduces electromagnetic emissions, allowing the reconstructed audio signal to pass to the speakers. Refer to the [Class-D LC Filter Design Application Report](#) for a detailed description of proper component description and design of the LC filter based upon the specified load and frequency response. The recommended low-pass cutoff frequency of the LC filter is dependent on the selected switching frequency. The low-pass cutoff frequency can be as high as 100 kHz for a PWM frequency of 2.1 MHz. At a PWM frequency of 384 kHz the low-pass cutoff frequency should be less than 40 kHz. Certain specifications must be understood for a proper inductor. The inductance value is given at zero current, but the TAS6421-Q1 device has current. Use the inductance versus current curve for the inductor to make sure the inductance does not drop below 1  $\mu$ H (for  $f_{SW} = 2.1$  MHz) at the maximum current provided by the system design. The DCR of the inductor directly affects the output power of the system design. The lower the DCR, the more power is provided to the speakers. The typical inductor DCR for a 4  $\Omega$  system is 40 to 50 m $\Omega$  and for a 2  $\Omega$  system is 20 to 25 m $\Omega$ . Further guidance is provided in the [Inductor Selection Guide for 2.1 MHz Class-D Amplifiers](#).

### 11.2.2 Application Curves

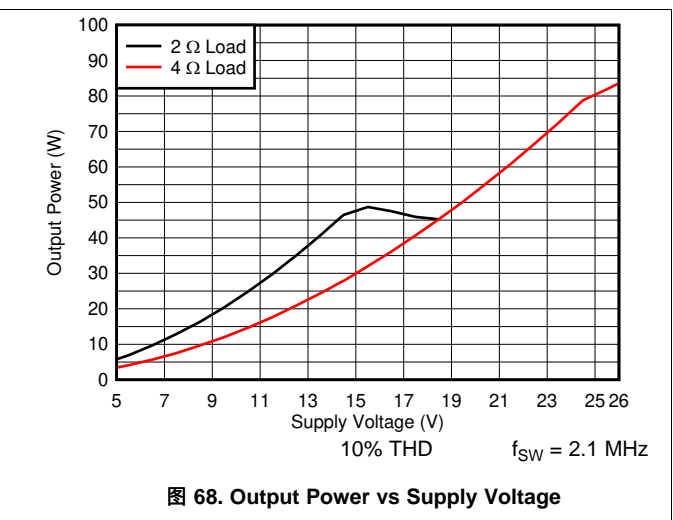
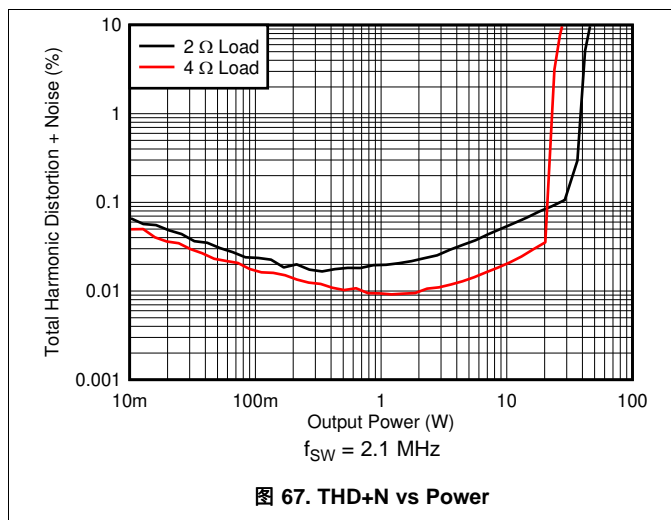

## 12 Power Supply Recommendations

The TAS6421-Q1 requires three power supplies. The PVDD supply is the high-current supply in the recommended supply range. The VBAT supply is a lower current supply that must be in the recommended supply range. The PVDD and VBAT pins can be connected to the same supply if the recommended supply range for VBAT is maintained. The VDD supply is the 3.3 Vdc logic supply and must be maintained in the tolerance as shown in the [Recommended Operating Conditions](#) table.

For best device performance and to avoid unexpected device behavior follow the recommendations in the [Vehicle-Battery Power-Supply Sequence](#) section.

## 13 Layout

### 13.1 Layout Guidelines

The pinout of the TAS6421-Q1 was selected to provide flowthrough layout with all high-power connections on the right side, and all low-power signals and supply decoupling on the left side.

 [69](#) shows the area for the components in the application example (see the [Typical Applications](#) section).

The TAS6421-Q1 EVM uses a four-layer PCB. The copper thickness was selected as 70  $\mu\text{m}$  to optimize power loss.

The small value of the output filter provides a small size and, in this case, the low height of the inductor enables double-sided mounting.

The EVM PCB shown in  [69](#) is the basis for the layout guidelines.

#### 13.1.1 Electrical Connection of Thermal pad and Heat Sink

For the DKQ package, the heat sink connected to the thermal pad of the device should be connected to GND. The thermal pad must not be connected to any other electrical node.

#### 13.1.2 EMI Considerations

Automotive-level EMI performance depends on both careful integrated circuit design and good system-level design. Controlling sources of electromagnetic interference (EMI) was a major consideration in all aspects of the design. The design has minimal parasitic inductances because of the short leads on the package which reduces the EMI that results from current passing from the die to the system PCB. Each channel also operates at a different phase. The design also incorporates circuitry that optimizes output transitions that cause EMI.

For optimizing the EMI a solid ground layer plane is recommended, for a PCB design that fulfills the CISPR25 level 5 requirements, see the TAS6421-Q1 EVM layout.

#### 13.1.3 General Guidelines

The EVM layout is optimized for low noise and EMC performance.

The TAS6421-Q1 has an exposed thermal pad that is up, away from the PCB. The layout must consider an external heat sink.

Refer to  [69](#) for the following guidelines:

- A ground plane, *A*, on the same side as the device pins helps reduce EMI by providing a very-low loop impedance for the high-frequency switching current.
- The decoupling capacitors on PVDD, *B*, are very close to the device with the ground return close to the ground pins.
- The ground connections for the capacitors in the LC filter, *C*, have a direct path back to the device and also the ground return for each channel is the shared. This direct path allows for improved common mode EMI rejection.
- The traces from the output pins to the inductors, *D*, should have the shortest trace possible to allow for the smallest loop of large switching currents.
- Heat-sink mounting screws, *E*, should be close to the device to keep the loop short from the package to ground.

## Layout Guidelines (接下页)

- Many vias,  $F$ , stitching together the ground planes can create a shield to isolate the amplifier and power supply.

## 13.2 Layout Example



图 69. Mono Channel EVM Layout

## 13.3 Thermal Considerations

The thermally enhanced PowerPAD package has an exposed pad up for connection to a heat sink. The output power of any amplifier is determined by the thermal performance of the amplifier as well as limitations placed on it by the system, such as the ambient operating temperature. The heat sink absorbs heat from the TAS6421-Q1 and transfers it to the air. With proper thermal management this process can reach equilibrium and heat can be continually transferred from the device. Heat sinks can be smaller than that of classic linear amplifier design because of the excellent efficiency of class-D amplifiers. This device is intended for use with a heat sink, therefore,  $R_{\theta JC}$  is used as the thermal resistance from junction to the exposed metal package. This resistance dominates the thermal management, so other thermal transfers are not considered. The thermal resistance of  $R_{\theta JA}$  (junction to ambient) is required to determine the full thermal solution. The thermal resistance is comprised of the following components:

- $R_{\theta JC}$  of the TAS6421-Q1
- Thermal resistance of the thermal interface material
- Thermal resistance of the heat sink

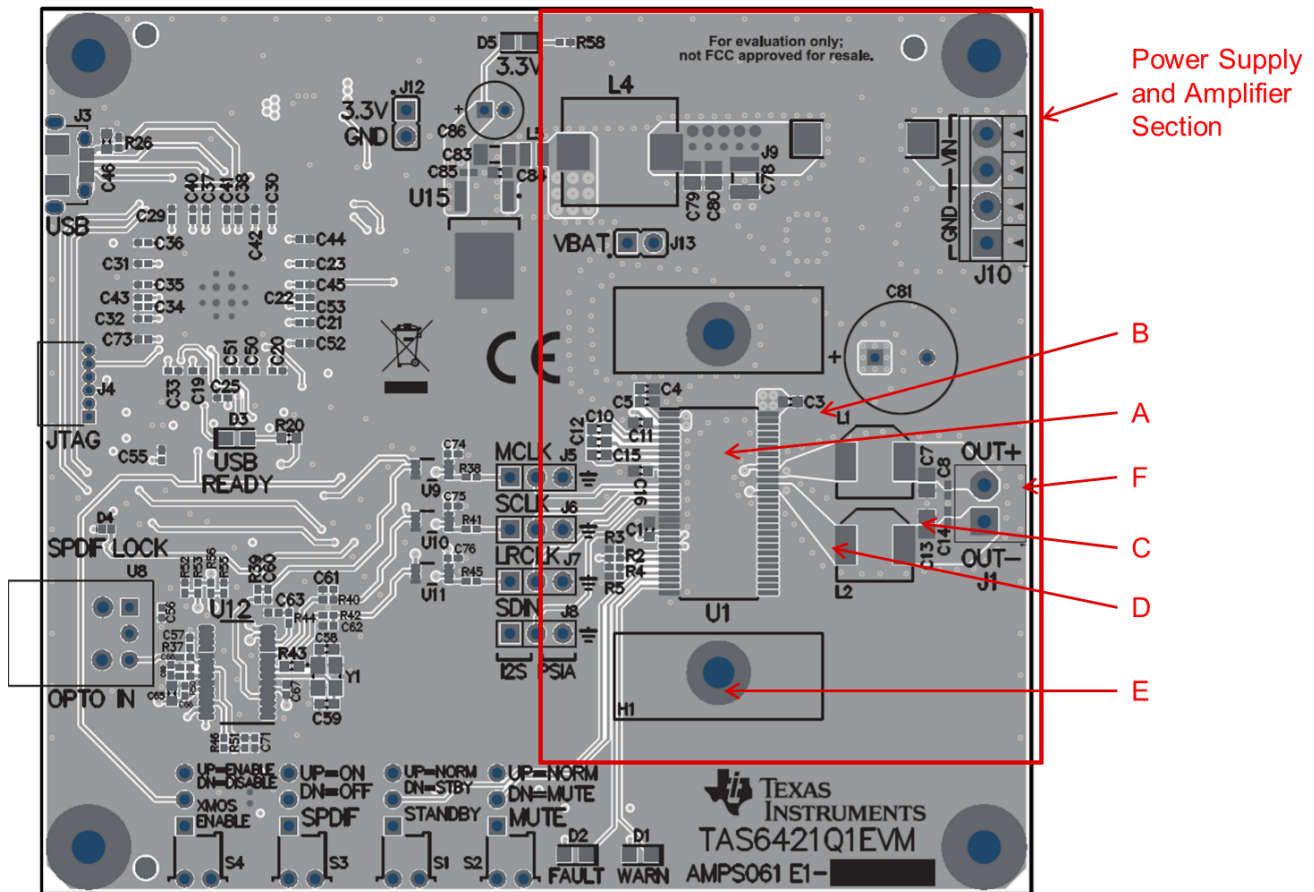
## Thermal Considerations (接下页)

The thermal resistance of the thermal interface material can be determined from the manufacturer's value for the area thermal resistance (expressed in °Cmm<sup>2</sup>/W) and the area of the exposed metal package. For example, a typical, white, thermal grease with a 0.0254 mm (0.001 inch) thick layer is approximately 4.52°C mm<sup>2</sup>/W. The TAS6421-Q1 in the DKQ package has an exposed area of 47.6 mm<sup>2</sup>. By dividing the area thermal resistance by the exposed metal area determines the thermal resistance for the thermal grease. The thermal resistance of the thermal grease is 0.094°C/W

表 38 lists the modeling parameters for one device on a heat sink. The junction temperature is assumed to be 115°C while delivering an average power of 10 watts per channel into a 4 Ω load. The thermal-grease example previously described is used for the thermal interface material. Use 公式 3 to design the thermal system.

$$R_{\theta JA} = R_{\theta JC} + \text{thermal interface resistance} + \text{heat sink resistance} \quad (3)$$

**表 38. Thermal Modeling**

Description	Value
Ambient Temperature	25°C
Average Power to load	10W
Power dissipation	2W
Junction Temperature	115°C
ΔT inside package	1.8°C (0.9°C/W × 2W)
ΔT through thermal interface material	0.188°C (0.094°C/W × 2W)
Required heat sink thermal resistance	44.0°C/W ([115°C – 25°C – 1.8°C – 0.188°C] / 2W)
System thermal resistance to ambient R <sub>θJA</sub>	45.1°C/W

## 14 器件和文档支持

### 14.1 文档支持

#### 14.1.1 相关文档

请参阅如下相关文档：

- [PurePath™ Console 3](#) 图形开发套件
- [《TAS6421-Q1 EVM 用户指南》](#)（文献编号：SLOU415）

### 14.2 接收文档更新通知

要接收文档更新通知，请导航至 [ti.com](http://ti.com) 上的器件产品文件夹。单击右上角的通知我进行注册，即可每周接收产品信息更改摘要。有关更改的详细信息，请查看任何已修订文档中包含的修订历史记录。

### 14.3 社区资源

下列链接提供到 TI 社区资源的连接。链接的内容由各个分销商“按照原样”提供。这些内容并不构成 TI 技术规范，并且不一定反映 TI 的观点；请参阅 TI 的 [《使用条款》](#)。

**TI E2E™ 中文在线社区** [TI 的工程师对工程师 \(E2E\) 社区](#)。此社区的创建目的在于促进工程师之间的协作。在 [e2echina.ti.com](http://e2echina.ti.com) 中，您可以咨询问题、分享知识、拓展思路并与同行工程师一道帮助解决问题。

**E2E 音频放大器论坛** [TI 的音频放大器工程师对工程师 \(E2E\) 社区](#) 此社区的创建目的在于促进工程师之间的协作。用户可进行实时问答。

### 14.4 商标

Burr-Brown, PurePath, E2E are trademarks of Texas Instruments.

### 14.5 静电放电警告



这些装置包含有限的内置 ESD 保护。存储或装卸时，应将导线一起截短或将装置放置于导电泡棉中，以防止 MOS 门极遭受静电损伤。

### 14.6 Glossary

[SLYZ022](#) — *TI Glossary*.

This glossary lists and explains terms, acronyms, and definitions.

## 重要声明和免责声明

TI 均以“原样”提供技术性 & 可靠性数据（包括数据表）、设计资源（包括参考设计）、应用或其他设计建议、网络工具、安全信息和其他资源，不保证其中不含任何瑕疵，且不做任何明示或暗示的担保，包括但不限于对适销性、适合某特定用途或不侵犯任何第三方知识产权的暗示担保。

所述资源可供专业开发人员应用 TI 产品进行设计使用。您将对以下行为独自承担全部责任：(1) 针对您的应用选择合适的 TI 产品；(2) 设计、验证并测试您的应用；(3) 确保您的应用满足相应标准以及任何其他安全、安保或其他要求。所述资源如有变更，恕不另行通知。TI 对您使用所述资源的授权仅限于开发资源所涉及 TI 产品的相关应用。除此之外不得复制或展示所述资源，也不提供其它 TI 或任何第三方的知识产权授权许可。如因使用所述资源而产生任何索赔、赔偿、成本、损失及债务等，TI 对此概不负责，并且您须赔偿由此对 TI 及其代表造成的损害。

TI 所提供产品均受 TI 的销售条款 (<http://www.ti.com.cn/zh-cn/legal/termsofsale.html>) 以及 [ti.com.cn](http://ti.com.cn) 上或随附 TI 产品提供的其他可适用条款的约束。TI 提供所述资源并不扩展或以其他方式更改 TI 针对 TI 产品所发布的可适用的担保范围或担保免责声明。

邮寄地址：上海市浦东新区世纪大道 1568 号中建大厦 32 楼，邮政编码：200122  
Copyright © 2020 德州仪器半导体技术（上海）有限公司

## PACKAGING INFORMATION

Orderable Device	Status (1)	Package Type	Package Drawing	Pins	Package Qty	Eco Plan (2)	Lead finish/ Ball material (6)	MSL Peak Temp (3)	Op Temp (°C)	Device Marking (4/5)	Samples
TAS6421QDKQRQ1	ACTIVE	HSSOP	DKQ	56	1000	RoHS & Green	NIPDAU	Level-3-260C-168 HR	-40 to 125	TAS6421	Samples

(1) The marketing status values are defined as follows:

**ACTIVE:** Product device recommended for new designs.

**LIFEBUY:** TI has announced that the device will be discontinued, and a lifetime-buy period is in effect.

**NRND:** Not recommended for new designs. Device is in production to support existing customers, but TI does not recommend using this part in a new design.

**PREVIEW:** Device has been announced but is not in production. Samples may or may not be available.

**OBSOLETE:** TI has discontinued the production of the device.

(2) **RoHS:** TI defines "RoHS" to mean semiconductor products that are compliant with the current EU RoHS requirements for all 10 RoHS substances, including the requirement that RoHS substance do not exceed 0.1% by weight in homogeneous materials. Where designed to be soldered at high temperatures, "RoHS" products are suitable for use in specified lead-free processes. TI may reference these types of products as "Pb-Free".

**RoHS Exempt:** TI defines "RoHS Exempt" to mean products that contain lead but are compliant with EU RoHS pursuant to a specific EU RoHS exemption.

**Green:** TI defines "Green" to mean the content of Chlorine (Cl) and Bromine (Br) based flame retardants meet JS709B low halogen requirements of <=1000ppm threshold. Antimony trioxide based flame retardants must also meet the <=1000ppm threshold requirement.

(3) MSL, Peak Temp. - The Moisture Sensitivity Level rating according to the JEDEC industry standard classifications, and peak solder temperature.

(4) There may be additional marking, which relates to the logo, the lot trace code information, or the environmental category on the device.

(5) Multiple Device Markings will be inside parentheses. Only one Device Marking contained in parentheses and separated by a "-" will appear on a device. If a line is indented then it is a continuation of the previous line and the two combined represent the entire Device Marking for that device.

(6) Lead finish/Ball material - Orderable Devices may have multiple material finish options. Finish options are separated by a vertical ruled line. Lead finish/Ball material values may wrap to two lines if the finish value exceeds the maximum column width.

**Important Information and Disclaimer:** The information provided on this page represents TI's knowledge and belief as of the date that it is provided. TI bases its knowledge and belief on information provided by third parties, and makes no representation or warranty as to the accuracy of such information. Efforts are underway to better integrate information from third parties. TI has taken and continues to take reasonable steps to provide representative and accurate information but may not have conducted destructive testing or chemical analysis on incoming materials and chemicals. TI and TI suppliers consider certain information to be proprietary, and thus CAS numbers and other limited information may not be available for release.

In no event shall TI's liability arising out of such information exceed the total purchase price of the TI part(s) at issue in this document sold by TI to Customer on an annual basis.



## TAPE AND REEL INFORMATION



### QUADRANT ASSIGNMENTS FOR PIN 1 ORIENTATION IN TAPE



\*All dimensions are nominal

Device	Package Type	Package Drawing	Pins	SPQ	Reel Diameter (mm)	Reel Width W1 (mm)	A0 (mm)	B0 (mm)	K0 (mm)	P1 (mm)	W (mm)	Pin1 Quadrant
TAS6421QDKQRQ1	HSSOP	DKQ	56	1000	330.0	32.4	11.35	18.67	3.1	16.0	32.0	Q1

**TAPE AND REEL BOX DIMENSIONS**



\*All dimensions are nominal

Device	Package Type	Package Drawing	Pins	SPQ	Length (mm)	Width (mm)	Height (mm)
TAS6421QDKQRQ1	HSSOP	DKQ	56	1000	367.0	367.0	55.0

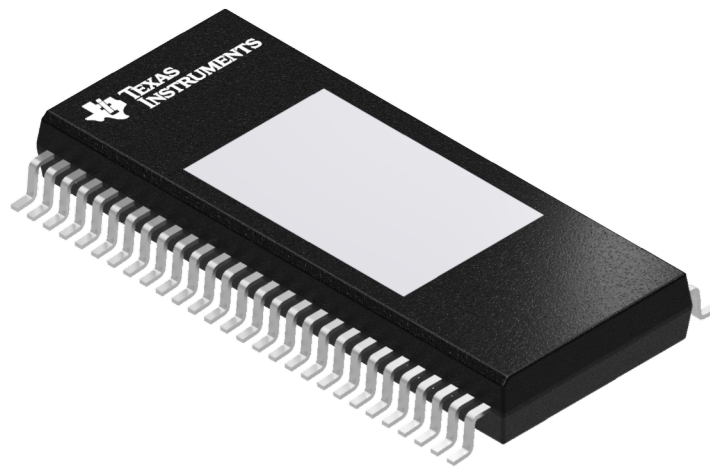

Images above are just a representation of the package family, actual package may vary.  
Refer to the product data sheet for package details.

DKQ0056A

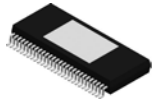

**PACKAGE OUTLINE**  
**PowerPAD™ HSSOP - 2.475 mm max height**

PLASTIC SMALL OUTLINE

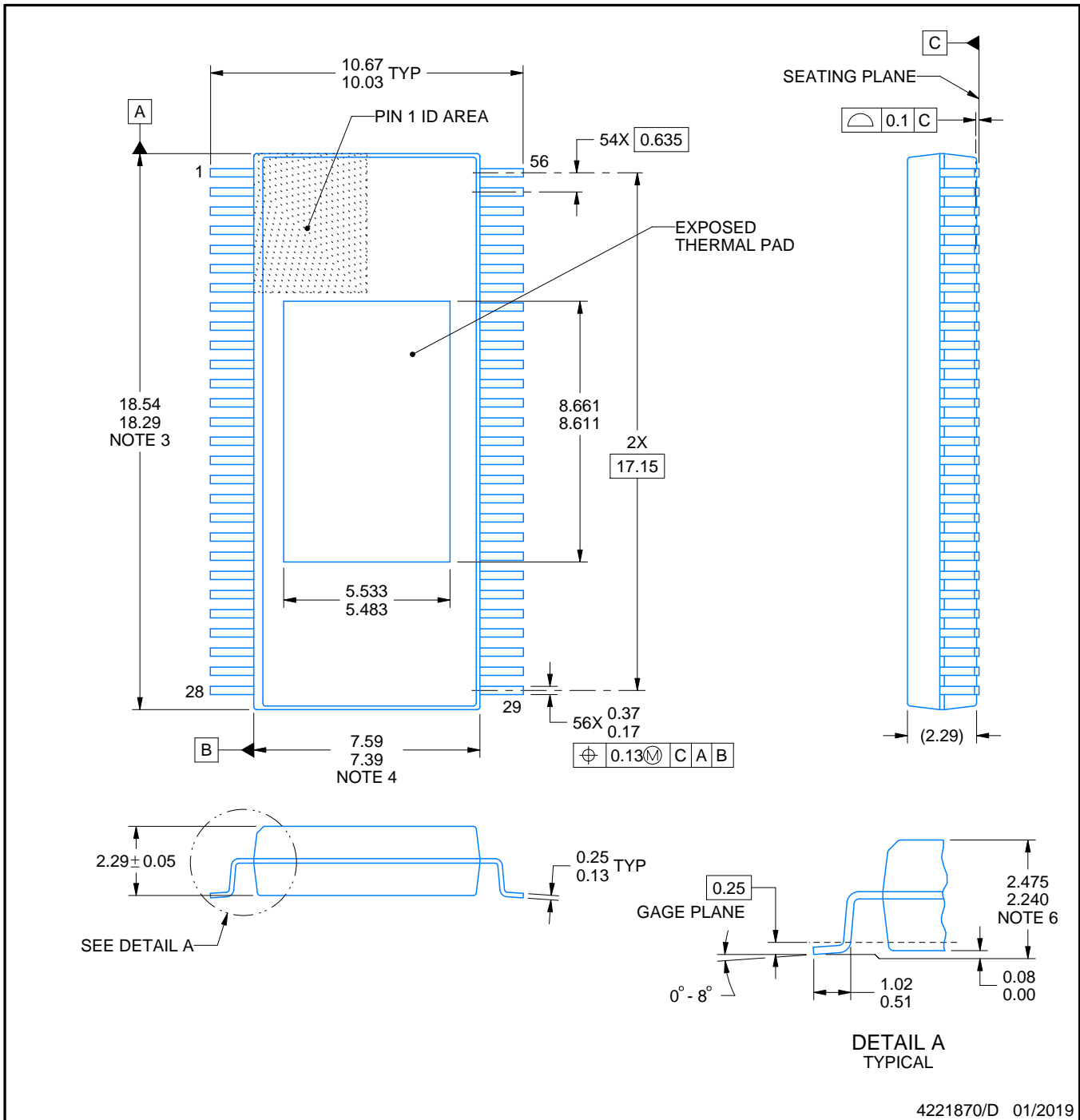

4221870/D 01/2019

NOTES:

PowerPAD is a trademark of Texas Instruments.

1. All linear dimensions are in millimeters. Any dimensions in parenthesis are for reference only. Dimensioning and tolerancing per ASME Y14.5M.
2. This drawing is subject to change without notice.
3. This dimension does not include mold flash, protrusions, or gate burrs. Mold flash, protrusions, or gate burrs shall not exceed 0.15 mm per side.
4. This dimension does not include interlead flash. Interlead flash shall not exceed 0.25 mm per side.
5. The exposed thermal pad is designed to be attached to an external heatsink.
6. For clamped heatsink design, refer to overall package height above the seating plane as 2.325 +/- 0.075 and molded body thickness dimension.

# EXAMPLE BOARD LAYOUT

DKQ0056A

PowerPAD™ HSSOP - 2.475 mm max height

PLASTIC SMALL OUTLINE

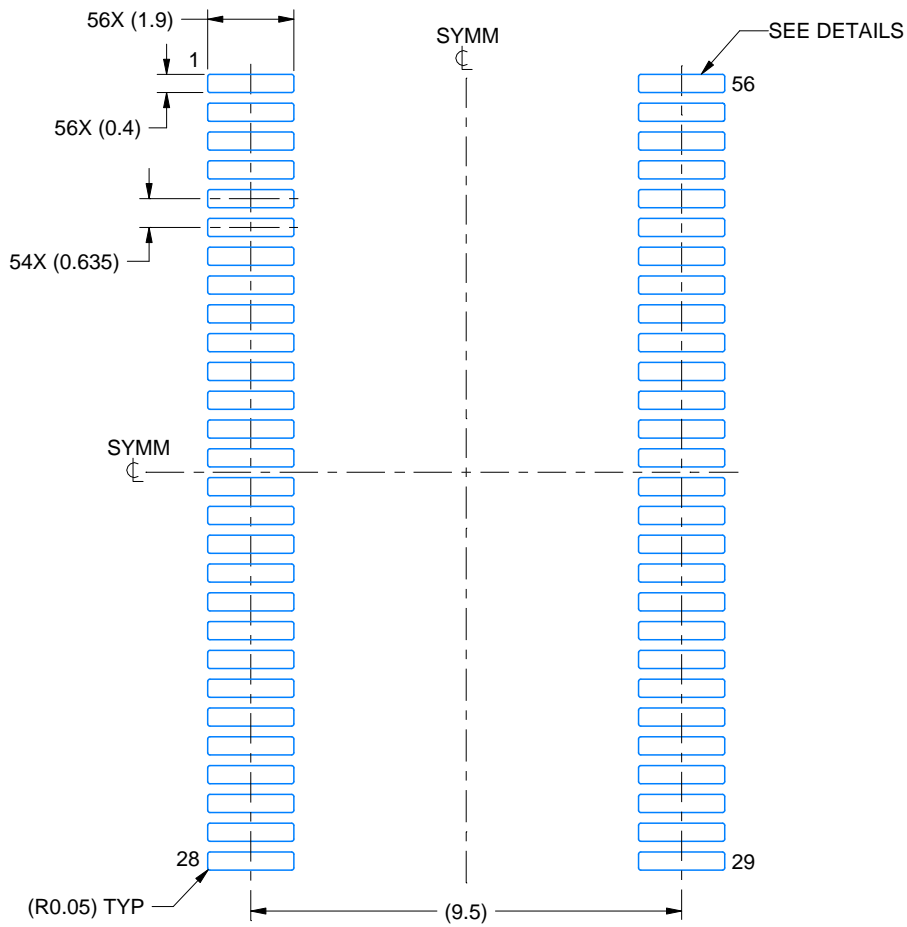

LAND PATTERN EXAMPLE  
EXPOSED METAL SHOWN  
SCALE:6X

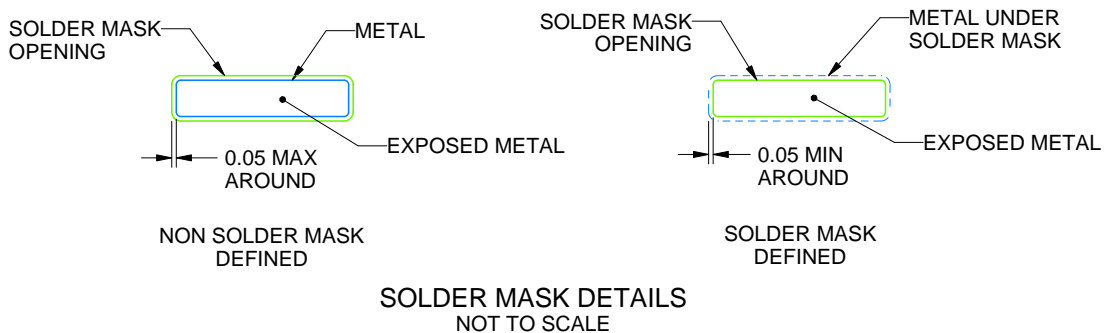

SOLDER MASK DETAILS  
NOT TO SCALE

4221870/D 01/2019

NOTES: (continued)

- 7. Publication IPC-7351 may have alternate designs.
- 8. Solder mask tolerances between and around signal pads can vary based on board fabrication site.
- 9. Size of metal pad may vary due to creepage requirement.

# EXAMPLE STENCIL DESIGN

DKQ0056A

PowerPAD™ HSSOP - 2.475 mm max height

PLASTIC SMALL OUTLINE

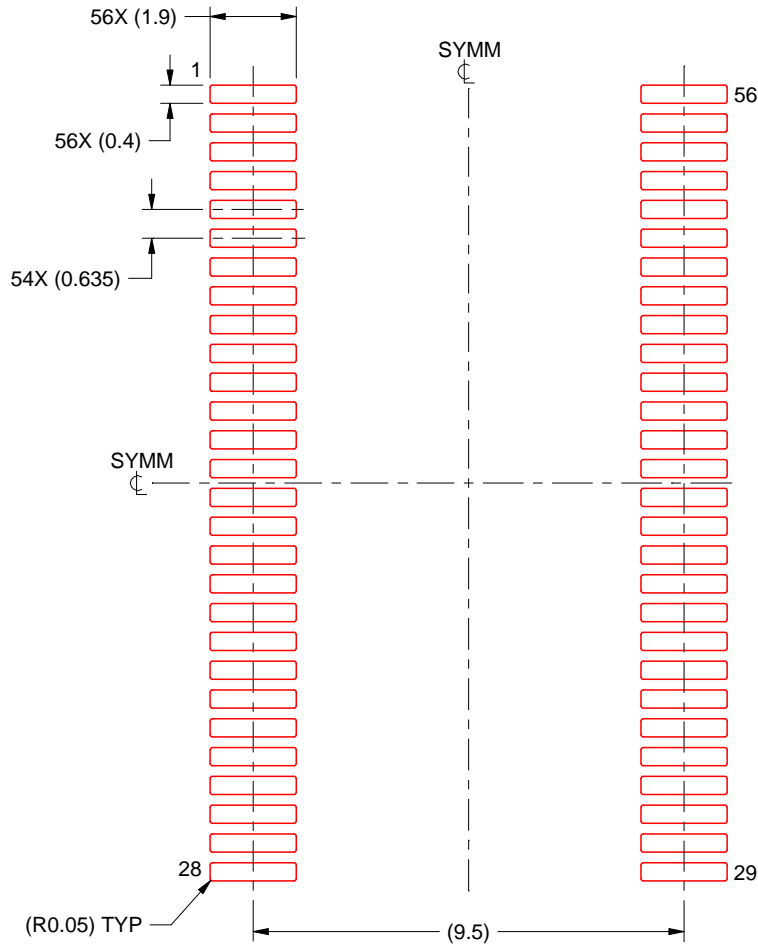

SOLDER PASTE EXAMPLE  
BASED ON 0.125 MM THICK STENCIL  
SCALE:6X

4221870/D 01/2019

NOTES: (continued)

10. Laser cutting apertures with trapezoidal walls and rounded corners may offer better paste release. IPC-7525 may have alternate design recommendations.
11. Board assembly site may have different recommendations for stencil design.

## 重要声明和免责声明

TI 均以“原样”提供技术性及其可靠性数据（包括数据表）、设计资源（包括参考设计）、应用或其他设计建议、网络工具、安全信息和其他资源，不保证其中不含任何瑕疵，且不做任何明示或暗示的担保，包括但不限于对适销性、适合某特定用途或不侵犯任何第三方知识产权的暗示担保。

所述资源可供专业开发人员应用TI 产品进行设计使用。您将对以下行为独自承担全部责任：(1) 针对您的应用选择合适的TI 产品；(2) 设计、验证并测试您的应用；(3) 确保您的应用满足相应标准以及任何其他安全、安保或其他要求。所述资源如有变更，恕不另行通知。TI 对您使用所述资源的授权仅限于开发资源所涉及TI 产品的相关应用。除此之外不得复制或展示所述资源，也不提供其它TI 或任何第三方的知识产权授权许可。如因使用所述资源而产生任何索赔、赔偿、成本、损失及债务等，TI 对此概不负责，并且您须赔偿由此对TI 及其代表造成的损害。

TI 所提供产品均受TI 的销售条款 (<http://www.ti.com.cn/zh-cn/legal/termsofsale.html>) 以及ti.com.cn 上或随附TI 产品提供的其他可适用条款的约束。TI 提供所述资源并不扩展或以其他方式更改TI 针对TI 产品所发布的可适用的担保范围或担保免责声明。

邮寄地址：上海市浦东新区世纪大道 1568 号中建大厦 32 楼，邮政编码：200122

Copyright © 2020 德州仪器半导体技术（上海）有限公司