

具有轻负载效率的 LV14360 60V、3A 降压转换器

1 特性

- 4.3V 至 60V 输入范围
- 3A 持续输出电流
- 300 μ A 工作静态电流
- 155m Ω 高侧 MOSFET
- 电流模式控制
- 可调节开关频率范围：200kHz 至 2 MHz
- 与外部时钟频率同步
- 内置补偿功能，便于使用
- 支持高占空比运行
- 精密使能输入
- 1 μ A 关断电流
- 过热保护、过压保护和短路保护
- 带 PowerPAD™ 的 8 引脚 HSOIC 封装

2 应用

- 工业电源
- 通信设备和数据通信模块
- 通用宽 V_{IN} 稳压

3 描述

LV14360 是一款具有集成型高侧 MOSFET 的 60V、3A 降压稳压器。该器件具有 4.3V 至 60V 的宽输入范围，适用于从工业到汽车各类应用中非稳压电源的电源调节。该稳压器在睡眠模式下的静态电流为 300 μ A，非常适合电池供电型系统。它在关断模式下具有 1 μ A 的超低电流，可进一步延长电池使用寿命。该稳压器的可调开关频率范围较宽，这使得效率或外部元件尺寸能够得到优化。内部环路补偿意味着用户不用承担设计环路补偿组件的枯燥工作。并且还能够在最大限度减少器件的外部元件数。精密使能输入简化了稳压器控制和系统电源排序。此外，该器件还内置多种保护特性：逐周期电流限制保护、应对功耗过大的热感测和热关断保护、以及输出过压保护。

LV14360 采用带有外露焊盘的 8 引脚 4.89mm \times 3.9mm HSOIC 封装，用于实现低热阻。

器件信息

器件型号	封装 ⁽¹⁾	封装尺寸 (标称值)
LV14360	HSOIC	4.89mm \times 3.9mm

(1) 如需了解所有可用封装，请参阅数据表末尾的可订购产品附录。

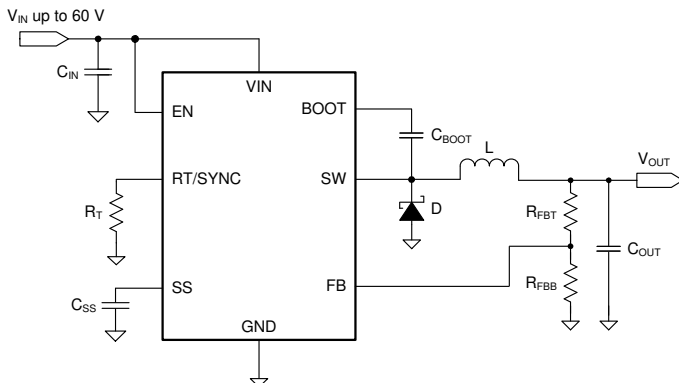

软启动 (SS) 选项的简化版原理图

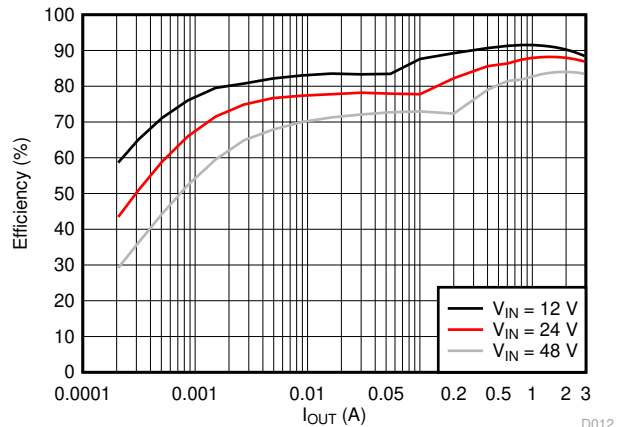

效率与输出电流间的关系 $V_{OUT} = 5V$ ，
 $f_{sw} = 500kHz$



Table of Contents

1 特性	1	8.3 Feature Description.....	10
2 应用	1	8.4 Device Functional Modes.....	16
3 描述	1	9 Application and Implementation	18
4 Revision History	2	9.1 Application Information.....	18
5 Device Comparison Table	2	9.2 Typical Application.....	18
6 Pin Configuration and Functions	3	10 Power Supply Recommendations	24
Pin Functions.....	3	11 Layout	24
7 Specifications	4	11.1 Layout Guidelines.....	24
7.1 Absolute Maximum Ratings.....	4	11.2 Layout Example.....	25
7.2 ESD Ratings.....	4	12 Device and Documentation Support	26
7.3 Recommended Operating Conditions.....	4	12.1 接收文档更新通知.....	26
7.4 Thermal Information.....	5	12.2 支持资源.....	26
7.5 Electrical Characteristics.....	5	12.3 Trademarks.....	26
7.6 Switching Characteristics.....	6	12.4 术语表.....	26
7.7 Typical Characteristics.....	7	12.5 静电放电警告.....	26
8 Detailed Description	9	13 Mechanical, Packaging, and Orderable Information	26
8.1 Overview.....	9		
8.2 Functional Block Diagram.....	10		

4 Revision History

注：以前版本的页码可能与当前版本的页码不同

Changes from Revision * (August 2017) to Revision A (September 2020)	Page
• 首次公开发布.....	1
• 更新了整个文档中的表格、图和交叉参考的编号格式.....	1

5 Device Comparison Table

PART NUMBER	FEATURE
LV14360P	Power Good
LV14360S	Soft start

6 Pin Configuration and Functions



图 6-1. DDA Package 8-Pin HSOIC Top View

Pin Functions

PIN		TYPE (1)	DESCRIPTION
NO.	NAME		
1	BOOT	P	Bootstrap capacitor connection for high-side MOSFET driver. Connect a high quality 0.1- μ F capacitor from BOOT to SW.
2	VIN	P	Connect to power supply and bypass capacitors C_{IN} . Path from VIN pin to high frequency bypass C_{IN} and GND must be as short as possible.
3	EN	A	Enable pin with internal pullup current source. Pull below 1.2 V to disable. Float or connect to VIN to enable. Adjust the input undervoltage lockout with two resistors (see # 8.3.6).
4	RT/SYNC	A	Resistor timing or external clock input. An internal amplifier holds this pin at a fixed voltage when using an external resistor to ground to set the switching frequency. If the pin is pulled above the PLL upper threshold, a mode change occurs and the pin becomes a synchronization input. The internal amplifier is disabled and the pin is a high impedance clock input to the internal PLL. If clocking edges stop, the internal amplifier is re-enabled, and the operating mode returns to frequency programming by resistor.
5	FB	A	Feedback input pin, connect to the feedback divider to set V_{OUT} . Do not short this pin to ground during operation.
6	SS or PGOOD	A	SS pin for soft-start version, connect to a capacitor to set soft-start time. The PGOOD pin for power-good version, open-drain output for power-good flag, use a 10-k Ω to 100-k Ω pullup resistor to logic rail or other DC voltage no higher than 7 V.
7	GND	G	System ground pin
8	SW	P	Switching output of the regulator. Internally connected to high-side power MOSFET. Connect to power inductor.
9	Thermal Pad	G	Major heat dissipation path of the die. Must be connected to ground plane on PCB.

(1) A = Analog, P = Power, G = Ground

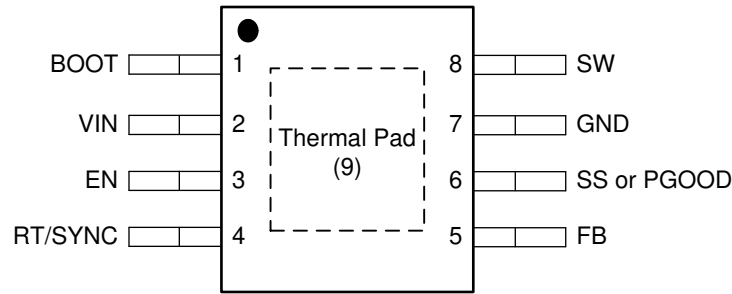
7 Specifications

7.1 Absolute Maximum Ratings

Over the recommended operating junction temperature range of -40°C to $+125^{\circ}\text{C}$ (unless otherwise noted)⁽¹⁾

		MIN	MAX	UNIT
Input voltages	VIN, EN to GND	-0.3	65	V
	BOOT to GND	-0.3	71	
	SS to GND	-0.3	5	
	FB to GND	-0.3	7	
	RT/SYNC to GND	-0.3	3.6	
	PGOOD to GND	-0.3	7	
Output voltages	BOOT to SW		6.5	V
	SW to GND	-3	65	
Junction temperature, T_J		-40	150	$^{\circ}\text{C}$
Storage temperature, T_{stg}		-65	150	$^{\circ}\text{C}$

- (1) Stresses beyond those listed under *Absolute Maximum Ratings* may cause permanent damage to the device. These are stress ratings only, which do not imply functional operation of the device at these or any other conditions beyond those indicated under *Recommended Operating Conditions*. Exposure to absolute-maximum-rated conditions for extended periods may affect device reliability.

7.2 ESD Ratings

		VALUE	UNIT
$V_{(ESD)}$	Electrostatic discharge	Human-body model (HBM) ⁽¹⁾	± 2000
		Charged-device model (CDM) ⁽²⁾	± 500

- (1) JEDEC document JEP155 states that 500-V HBM allows safe manufacturing with a standard ESD control process.
(2) JEDEC document JEP157 states that 250-V CDM allows safe manufacturing with a standard ESD control process.

7.3 Recommended Operating Conditions

Over the recommended operating junction temperature range of -40°C to $+125^{\circ}\text{C}$ (unless otherwise noted)⁽¹⁾

		MIN	MAX	UNIT
Buck regulator	VIN	4.3	60	V
	VOUT	0.8	50	
	BOOT		66	
	SW	-1	60	
	FB	0	5	
Control	EN	0	60	V
	RT/SYNC	0	3.3	
	SS	0	3	
	PGOOD to GND	0	5	
Frequency	Switching frequency range at RT mode	200	2000	kHz
	Switching frequency range at SYNC mode	250	2000	
Temperature	Operating junction temperature, T_J	-40	125	$^{\circ}\text{C}$

- (1) Operating Ratings indicate conditions for which the device is intended to be functional, but do not ensure specific performance limits. For ensured specifications, see [#7.5](#).

7.4 Thermal Information

THERMAL METRIC (1) (2)		LV14360	UNIT
		DDA (HSOIC)	
		8 PINS	
$R_{\theta JA}$	Junction-to-ambient thermal resistance	42.5	°C/W
ψ_{JT}	Junction-to-top characterization parameter	9.9	°C/W
ψ_{JB}	Junction-to-board characterization parameter	25.4	°C/W
$R_{\theta JC(top)}$	Junction-to-case (top) thermal resistance	56.1	°C/W
$R_{\theta JC(bot)}$	Junction-to-case (bottom) thermal resistance	3.8	°C/W
$R_{\theta JB}$	Junction-to-board thermal resistance	25.5	°C/W

- (1) For more information about traditional and new thermal metrics, see the [Semiconductor and IC Package Thermal Metrics](#) application report.
- (2) Power rating at a specific ambient temperature T_A should be determined with a maximum junction temperature (T_J) of 125°C (see [7.3](#)).

7.5 Electrical Characteristics

Limits apply over the recommended operating junction temperature (T_J) range of -40°C to +125°C, unless otherwise stated. Minimum and maximum limits are specified through test, design or statistical correlation. Typical values represent the most likely parametric norm at $T_J = 25^\circ\text{C}$, and are provided for reference purposes only. Unless otherwise specified, the following conditions apply: $V_{IN} = 4.3\text{ V}$ to 60 V

PARAMETER		TEST CONDITIONS	MIN	TYP	MAX	UNIT
POWER SUPPLY (VIN PIN)						
V_{IN}	Operation input voltage		4.3		60	V
$UVLO$	Under voltage lockout thresholds	Rising threshold	3.8	4	4.2	V
		Hysteresis		285		mV
I_{SHDN}	Shutdown supply current	$V_{EN} = 0\text{ V}$, $T_A = 25^\circ\text{C}$, $4.3\text{ V} \leq V_{IN} \leq 60\text{ V}$		1	3	μA
I_Q	Operating quiescent current (non-switching)	$V_{FB} = 1\text{ V}$, $T_A = 25^\circ\text{C}$		300		μA
ENABLE (EN PIN)						
V_{EN_TH}	EN Threshold Voltage		1.05	1.20	1.38	V
I_{EN_PIN}	EN PIN current	Enable threshold 50 mV		-4.6		μA
		Enable threshold -50 mV		-1		μA
I_{EN_HYS}	EN hysteresis current			-3.6		μA
SOFT START						
I_{SS}	SS pin current	For external soft-start version only, $T_A = 25^\circ\text{C}$		-3		μA
t_{SS}	Internal soft-start time	For power-good version only, 10% to 90% of FB voltage		4		ms
POWER GOOD (PGOOD PIN)						
V_{PG_UV}	Power-good flag under voltage tripping threshold	POWER GOOD (% of FB voltage)		94%		
		POWER BAD (% of FB voltage)		92%		
V_{PG_OV}	Power-good flag over voltage tripping threshold	POWER BAD (% of FB voltage)		109%		
		POWER GOOD (% of FB voltage)		107%		
V_{PG_HYS}	Power-good flag recovery hysteresis	% of FB voltage		2%		
I_{PG}	PGOOD leakage current at high level output	$V_{PULLUP} = 5\text{ V}$		10	200	nA
V_{PG_LOW}	PGOOD low level output voltage	$I_{PULLUP} = 1\text{ mA}$		0.1		V
$V_{IN_PG_MIN}$	Minimum V_{IN} for valid PGOOD output	$V_{PULLUP} < 5\text{ V}$ at $I_{PULLUP} = 100\ \mu\text{A}$		1.6	1.95	V

Limits apply over the recommended operating junction temperature (T_J) range of -40°C to $+125^{\circ}\text{C}$, unless otherwise stated. Minimum and maximum limits are specified through test, design or statistical correlation. Typical values represent the most likely parametric norm at $T_J = 25^{\circ}\text{C}$, and are provided for reference purposes only. Unless otherwise specified, the following conditions apply: $V_{IN} = 4.3\text{ V}$ to 60 V

PARAMETER		TEST CONDITIONS	MIN	TYP	MAX	UNIT
VOLTAGE REFERENCE (FB PIN)						
V_{FB}	Feedback voltage	$T_J = 25^{\circ}\text{C}$	0.746	0.75	0.754	V
		$T_J = -40^{\circ}\text{C}$ to 125°C	0.735	0.75	0.765	V
HIGH-SIDE MOSFET						
R_{DS_ON}	On-resistance	$V_{IN} = 12\text{ V}$, BOOT to SW = 5.8 V		155	320	$\text{m}\Omega$
HIGH-SIDE MOSFET CURRENT LIMIT						
I_{LIMIT}	Current limit	$V_{IN} = 12\text{ V}$, $T_A = 25^{\circ}\text{C}$, Open Loop	3.8	4.75	5.7	A
THERMAL PERFORMANCE						
T_{SHDN}	Thermal shutdown threshold			170		$^{\circ}\text{C}$
T_{HYS}	Hysteresis			12		

7.6 Switching Characteristics

Over the recommended operating junction temperature range of -40°C to 125°C (unless otherwise noted)

PARAMETER		TEST CONDITIONS	MIN	TYP	MAX	UNIT
f_{SW}	Switching frequency	$R_T = 11.5\text{ k}\Omega$		1912		kHz
	Switching frequency range at SYNC mode		250		2000	
V_{SYNC_HI}	SYNC clock high level threshold		1.7			V
V_{SYNC_LO}	SYNC clock low level threshold				0.5	
T_{SYNC_MIN}	Minimum SYNC input pulse width	Measured at 500 kHz, $V_{SYNC_HI} > 3\text{ V}$, $V_{SYNC_LO} < 0.3\text{ V}$		30		ns
T_{LOCK_IN}	PLL lock in time	Measured at 500 kHz		100		μs
T_{ON_MIN}	Minimum controllable on time	$V_{IN} = 12\text{ V}$, BOOT to SW = 5.8 V , $I_{Load} = 1\text{ A}$		100		ns
D_{MAX}	Maximum duty cycle	$f_{SW} = 200\text{ kHz}$		90%		

7.7 Typical Characteristics

Unless otherwise specified the following conditions apply: $V_{IN} = 24\text{ V}$, $f_{SW} = 500\text{ KHz}$, $L = 8.2\ \mu\text{H}$, $C_{OUT} = 2 \times 47\ \mu\text{F}$, $T_A = 25^\circ\text{C}$.

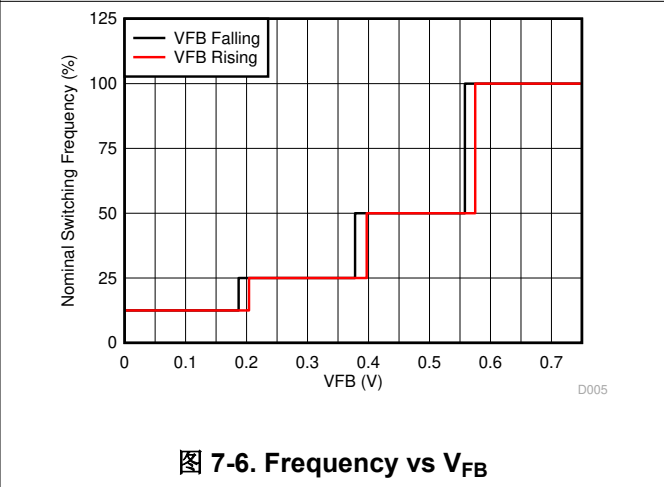
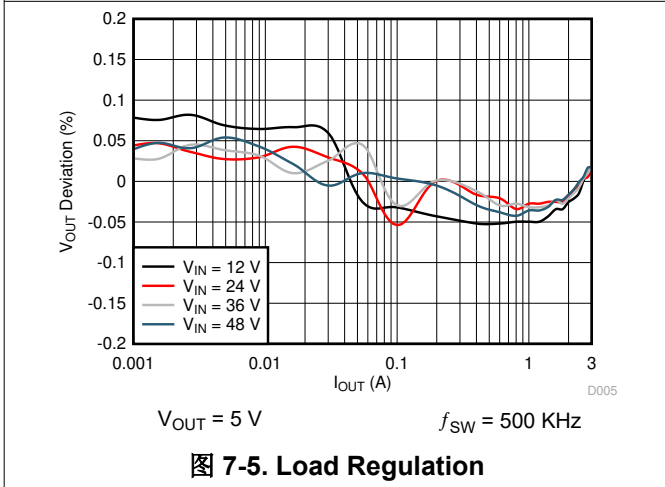
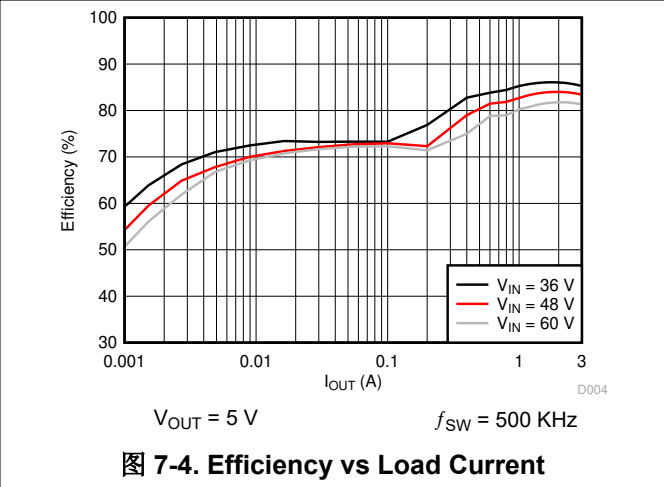
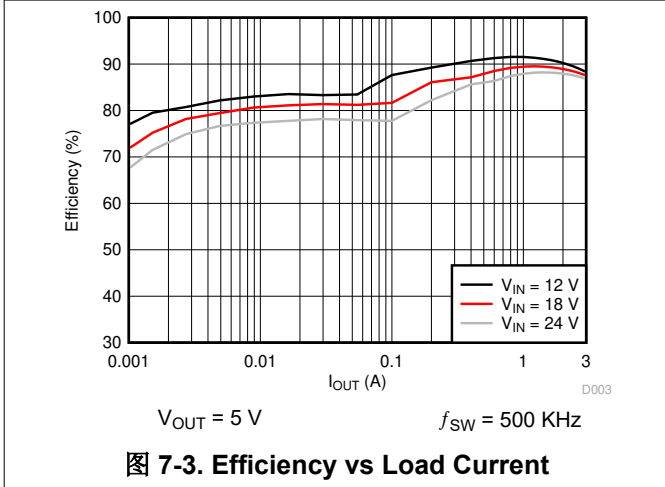
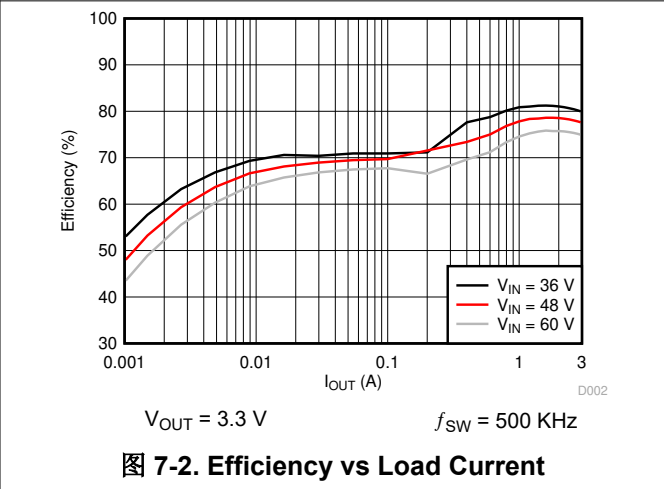
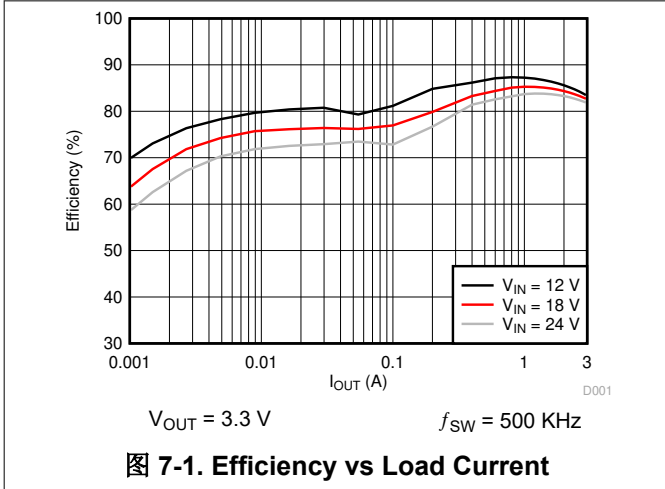



图 7-7. Dropout Curve



图 7-8. Voltage Reference vs Junction Temperature

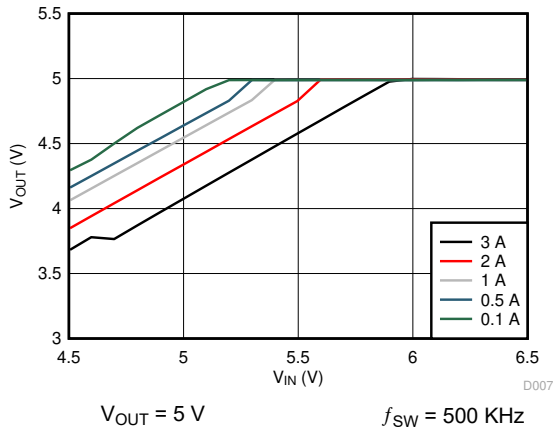

图 7-9. High-Side Current Limit vs Junction Temperature

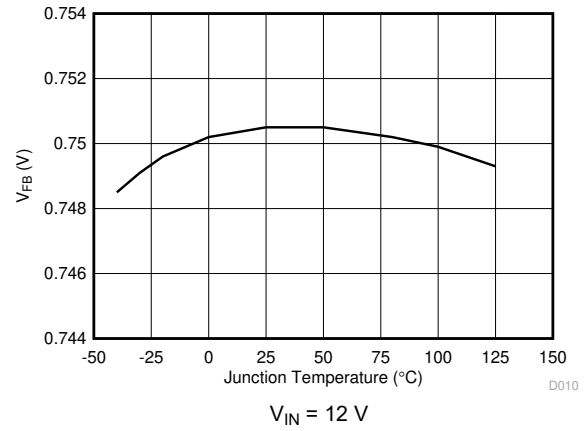

图 7-10. UVLO Threshold

8 Detailed Description

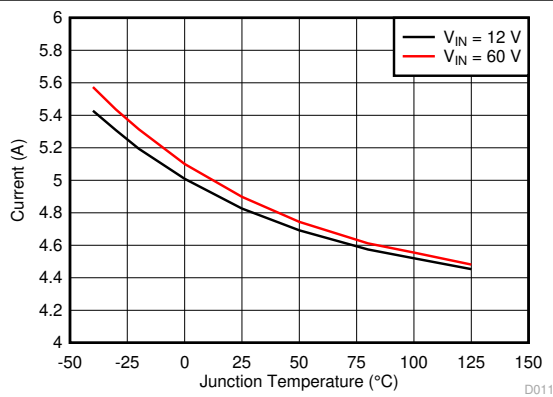
8.1 Overview

The LV14360 regulator is an easy-to-use step-down DC-DC converter that operates from a 4.3-V to 60-V supply voltage. The device integrates a 155-m Ω (typical) high-side MOSFET and is capable of delivering up to 3-A DC load current with exceptional efficiency and thermal performance in a very small solution size. The operating current is typically 300 μ A under no load condition (not switching). When the device is disabled, the supply current is typically 1 μ A. An extended family is available in 1-A and 2-A load options in pin-to-pin compatible packages.

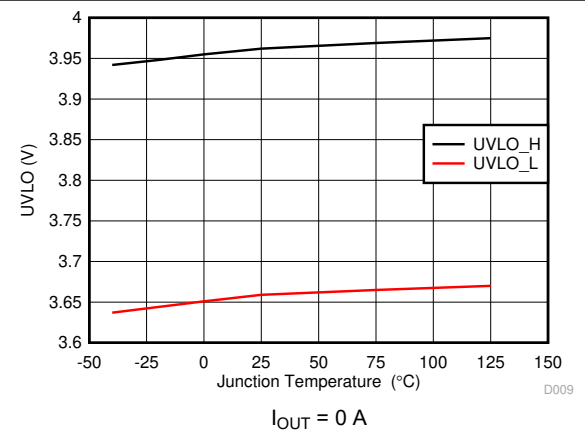
The LV14360 implements constant frequency peak current mode control with sleep mode at light load to achieve high efficiency. The device is internally compensated, which reduces design time, and requires fewer external components. The switching frequency is programmable from 200 kHz to 2 MHz by an external resistor R_T . The LV14360 is also capable of synchronization to an external clock within the 250-kHz to 2 MHz frequency range, which allows the device to be optimized to fit small board space at higher frequency, or high efficient power conversion at lower frequency.

Other features are included for more comprehensive system requirements, including precision enable, adjustable soft-start time, and approximate 90% duty cycle by BOOT capacitor recharge circuit. These features provide a flexible and easy-to-use platform for a wide range of applications. Protection features include over temperature shutdown, V_{OUT} overvoltage protection (OVP), V_{IN} undervoltage lockout (UVLO), cycle-by-cycle current limit, and short-circuit protection with frequency foldback.

8.2 Functional Block Diagram

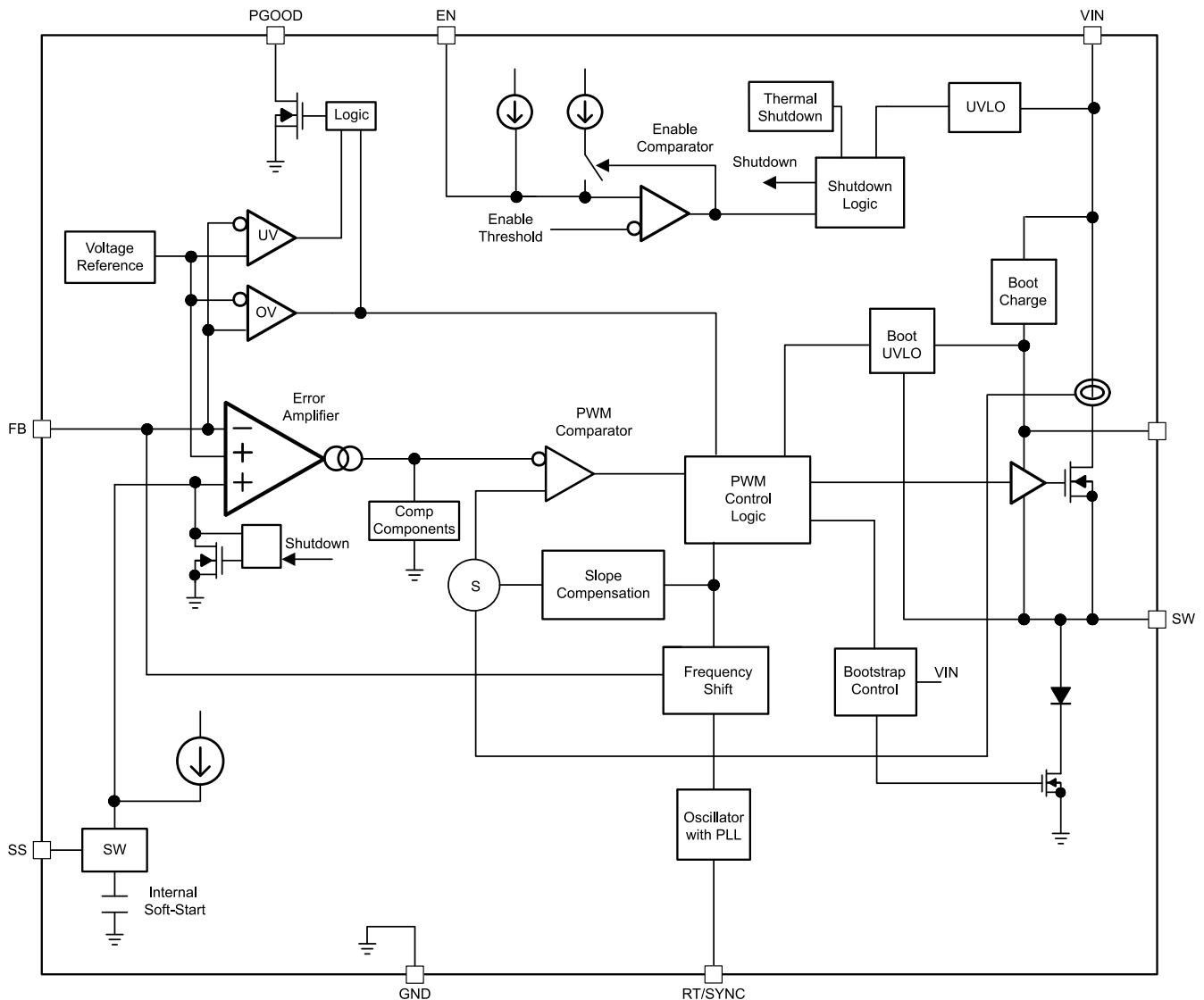

8.3 Feature Description

8.3.1 Fixed Frequency Peak Current Mode Control

The following operating description of the LV14360 refers to [§ 8.2](#) and to the waveforms in [图 8-1](#). The LV14360 output voltage is regulated by turning on the high-side N-MOSFET with controlled ON time. During high-side switch ON time, the SW pin voltage swings up to approximately V_{IN} , and the inductor current i_L increases with linear slope $(V_{IN} - V_{OUT}) / L$. When the high-side switch is off, inductor current discharges through a freewheel diode with a slope of $-V_{OUT} / L$. The control parameter of buck converter is defined as Duty Cycle $D = t_{ON} / T_{SW}$, where t_{ON} is the high-side switch ON-time and T_{SW} is the switching period. The regulator control loop maintains a constant output voltage by adjusting the duty cycle D . In an ideal Buck converter, where losses are ignored, D is proportional to the output voltage and inversely proportional to the input voltage: $D = V_{OUT} / V_{IN}$.



图 8-1. SW Node and Inductor Current Waveforms in Continuous Conduction Mode (CCM)

The LV14360 employs fixed frequency peak current mode control. A voltage feedback loop is used to get accurate DC voltage regulation by adjusting the peak current command based on voltage offset. The peak inductor current is sensed from the high-side switch and compared to the peak current to control the ON time of the high-side switch. The voltage feedback loop is internally compensated, which allows for fewer external components, makes it easy to design, and provides stable operation with almost any combination of output capacitors. The regulator operates with fixed switching frequency at normal load condition. At very light load, the LV14360 operates in sleep mode to maintain high efficiency and switching frequency will decrease with reduced load current.

8.3.2 Slope Compensation

The LV14360 adds a compensating ramp to the MOSFET switch current sense signal. This slope compensation prevents subharmonic oscillations at duty cycles greater than 50%. The peak current limit of the high-side switch is not affected by the slope compensation and remains constant over the full duty cycle range.

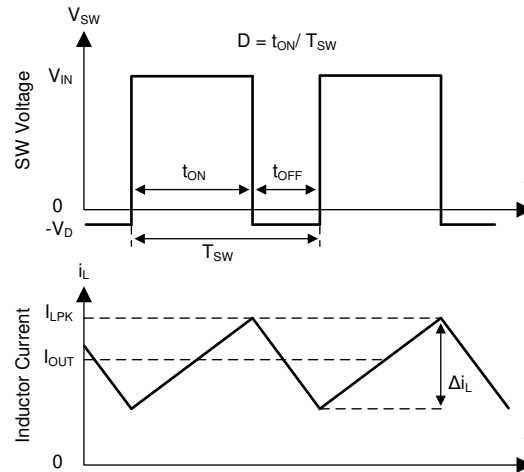
8.3.3 Sleep Mode

The LV14360 operates in sleep mode at light load currents to improve efficiency by reducing switching and gate-drive losses. If the output voltage is within regulation and the peak switch current at the end of any switching cycle is below the current threshold of 300 mA, the device enters sleep mode. The sleep-mode current threshold is the peak switch current level corresponding to a nominal internal COMP voltage of 400 mV.

When in sleep mode, the internal COMP voltage is clamped at 400 mV and the high-side MOSFET is inhibited, and the device draws only 300 μ A (typical) input quiescent current. Since the device is not switching, the output voltage begins to decay. The voltage control loop responds to the falling output voltage by increasing the internal COMP voltage. The high-side MOSFET is enabled and switching resumes when the error amplifier lifts internal COMP voltage above 400 mV. The output voltage recovers to the regulated value, and internal COMP voltage eventually falls below the sleep-mode threshold at which time the device again enters sleep mode.

8.3.4 Low Dropout Operation and Bootstrap Voltage (BOOT)

The LV14360 provides an integrated bootstrap voltage regulator. A small capacitor between the BOOT and SW pins provides the gate drive voltage for the high-side MOSFET. The BOOT capacitor is refreshed when the high-side MOSFET is off and the external low-side diode conducts. The recommended value of the BOOT capacitor is 0.1 μ F. TI recommends a ceramic capacitor with an X7R or X5R grade dielectric with a voltage rating of 16 V or greater for stable performance over temperature and voltage.

When operating with a low voltage difference from input to output, the high-side MOSFET of the LV14360 operates at approximate 90% duty cycle. When the high-side MOSFET is continuously on for five or six switching cycles (five or six switching cycles for frequency lower than 1 MHz, and 10 or 11 switching cycles for frequency higher than 1 MHz) and the voltage from BOOT to SW drops below 3.2 V, the high-side MOSFET is turned off and an integrated low-side MOSFET pulls SW low to recharge the BOOT capacitor.

Since the gate drive current sourced from the BOOT capacitor is small, the high-side MOSFET can remain on for many switching cycles before the MOSFET is turned off to refresh the capacitor. Thus the effective duty cycle of the switching regulator can be high, approaching 90%. The effective duty cycle of the converter during dropout is mainly influenced by the voltage drops across the power MOSFET, the inductor resistance, the low-side diode voltage, and the printed circuit board resistance.

8.3.5 Adjustable Output Voltage

The internal voltage reference produces a precise 0.75 V (typical) voltage reference over the operating temperature range. The output voltage is set by a resistor divider from output voltage to the FB pin. It is recommended to use 1% tolerance or better and temperature coefficient of 100 ppm or less divider resistors. Select the low side resistor R_{FBB} for the desired divider current and use [方程式 1](#) to calculate high-side R_{FBT} . Larger value divider resistors are good for efficiency at light load. However, if the values are too high, the regulator will be more susceptible to noise and voltage errors from the FB input current may become noticeable. R_{FBB} in the range from 10 k Ω to 100 k Ω is recommended for most applications.



图 8-2. Output Voltage Setting

$$R_{FBT} = \frac{V_{OUT} - 0.75}{0.75} \times R_{FBB} \quad (1)$$

8.3.6 Enable and Adjustable Undervoltage Lockout

The LV14360 is enabled when the VIN pin voltage rises above 4 V (typical) and the EN pin voltage exceeds the enable threshold of 1.2 V (typical). The LV14360 is disabled when the VIN pin voltage falls below 3.715 V (typical) or when the EN pin voltage is below 1.2 V. The EN pin has an internal pullup current source (typically $I_{EN} = 1 \mu\text{A}$) that enables operation of the LV14360 when the EN pin is floating.

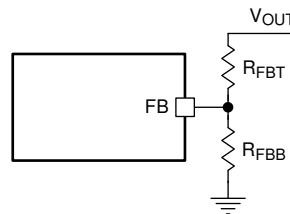
Many applications will benefit from the employment of an enable divider R_{ENT} and R_{ENB} in [图 8-3](#) to establish a precision system UVLO level for the stage. System UVLO can be used for supplies operating from utility power as well as battery power. It can be used for sequencing, ensuring reliable operation, or supply protection, such as a battery. An external logic signal can also be used to drive EN input for system sequencing and protection.

When EN terminal voltage exceeds 1.2 V, an additional hysteresis current (typically $I_{HYS} = 3.6 \mu\text{A}$) is sourced out of EN terminal. When the EN terminal is pulled below 1.2 V, I_{HYS} current is removed. This additional current facilitates adjustable input voltage UVLO hysteresis. Use [方程式 2](#) and [方程式 3](#) to calculate R_{ENT} and R_{ENB} for desired UVLO hysteresis voltage.



图 8-3. System UVLO By Enable Dividers

$$R_{ENT} = \frac{V_{START} - V_{STOP}}{I_{HYS}} \quad (2)$$

$$R_{ENB} = \frac{V_{EN}}{\frac{V_{START} - V_{EN}}{R_{ENT}} + I_{EN}} \quad (3)$$

where

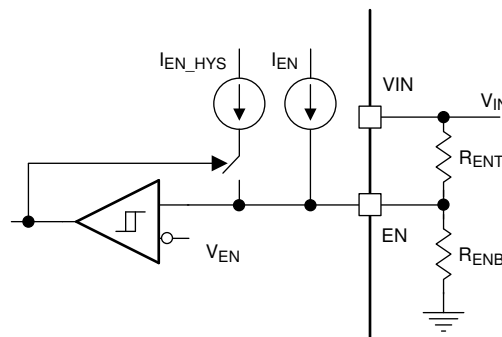
- V_{START} is the desired voltage threshold to enable LV14360
- V_{STOP} is the desired voltage threshold to disable device
- $I_{EN} = 1 \mu A$
- $I_{HYS} = 3.6 \mu A$, typically

8.3.7 External Soft Start

The LV14360S has an external soft-start pin for programmable output ramp up time. The soft-start feature is used to prevent inrush current impacting the LV14360 and its load when power is first applied. The soft-start time can be programmed by connecting an external capacitor C_{SS} from SS pin to GND. An internal current source (typically $I_{SS} = 3 \mu A$) charges C_{SS} and generates a ramp from 0 V to V_{REF} . The soft-start time can be calculated by [方程式 4](#):

$$t_{SS}(ms) = \frac{C_{SS}(nF) \times V_{REF}(V)}{I_{SS}(\mu A)} \quad (4)$$

The internal soft start resets while device is disabled or in thermal shutdown.

8.3.8 Switching Frequency and Synchronization (RT/SYNC)

The switching frequency of the LV14360 can be programmed by the resistor R_T from the RT/SYNC pin and GND pin. The RT/SYNC pin cannot be left floating or shorted to ground. To determine the timing resistance for a given switching frequency, use [方程式 5](#) or the curve in [图 8-4](#). [表 8-1](#) gives typical R_T values for a given f_{SW} .

$$R_T(k\Omega) = 42904 \times f_{SW}(kHz)^{-1.088} \quad (5)$$



图 8-4. RT vs Frequency Curve

表 8-1. Typical Frequency Setting RT Resistance

f_{SW} (kHz)	R_T (kΩ)
200	133
350	73.2

表 8-1. Typical Frequency Setting RT Resistance (continued)

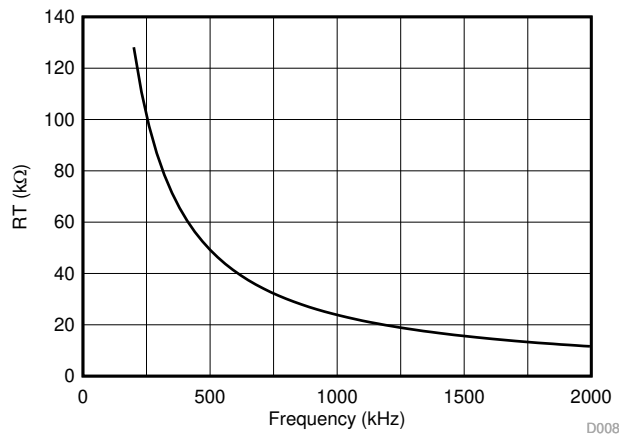
f_{sw} (kHz)	R_T (k Ω)
500	49.9
750	32.4
1000	23.2
1500	15.0
1912	11.5
2000	11

The LV14360 switching action can also be synchronized to an external clock from 250 kHz to 2 MHz. Connect a square wave to the RT/SYNC pin through either circuit network shown in 图 8-5. Internal oscillator is synchronized by the falling edge of external clock. The recommendations for the external clock include: high level no lower than 1.7 V, low level no higher than 0.5 V, and have a pulse width greater than 30 ns. When using a low impedance signal source, the frequency setting resistor R_T is connected in parallel with an AC coupling capacitor C_{COUP} to a termination resistor R_{TERM} (for example, 50 Ω). The two resistors in series provide the default frequency setting resistance when the signal source is turned off. A 10-pF ceramic capacitor can be used for C_{COUP} . 图 8-6, 图 8-7, and 图 8-8 show the device synchronized to an external system clock.



图 8-5. Synchronizing to an External Clock



图 8-6. Synchronizing in CCM

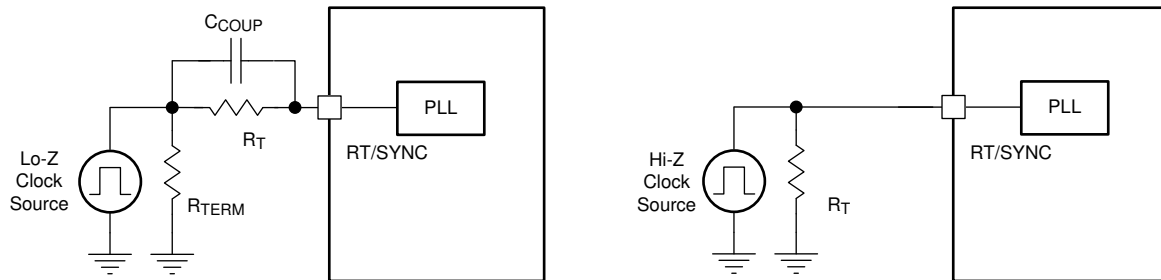

图 8-7. Synchronizing in DCM

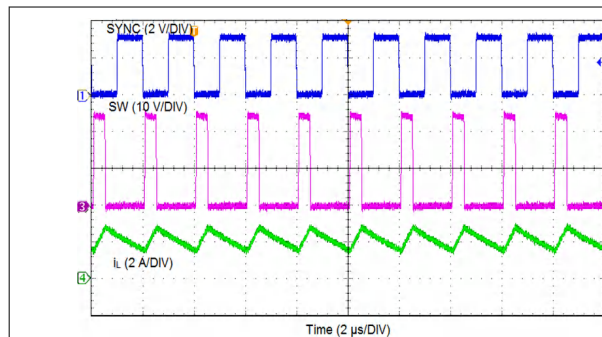

图 8-8. Synchronizing in Sleep Mode

方程式 6 计算了由最小可控导通时间和输入到输出阶跃下降比设定的最大开关频率限制。将开关频率设置高于此值将导致调节器跳过开关脉冲以实现最大输入电压所需的低占空比。

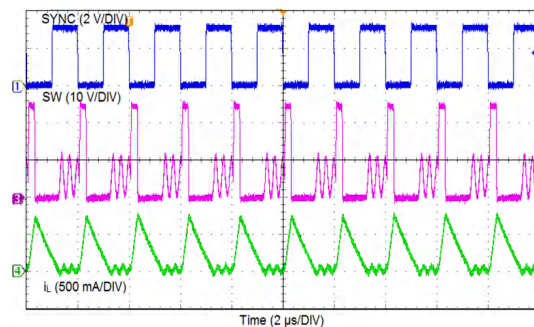
$$f_{SW(max)} = \frac{1}{t_{ON}} \times \left(\frac{I_{OUT} \times R_{IND} + V_{OUT} + V_D}{V_{IN_MAX} - I_{OUT} \times R_{DS_ON} + V_D} \right) \quad (6)$$

where

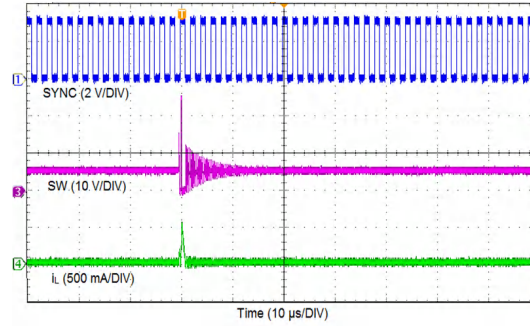
- I_{OUT} = Output current
- R_{IND} = Inductor series resistance
- V_{IN_MAX} = Maximum input voltage
- V_{OUT} = Output voltage
- V_D = Diode voltage drop
- R_{DS_ON} = High-side MOSFET switch on resistance
- t_{ON} = Minimum on-time

8.3.9 Power Good (PGOOD)

The LV14360P has a built-in power-good flag shown on the PGOOD pin to indicate whether the output voltage is within its regulation level. The PGOOD signal can be used for start-up sequencing of multiple rails or fault protection. The PGOOD pin is an open-drain output that requires a pullup resistor to an appropriate DC voltage. Voltage seen by the PGOOD pin must never exceed 7 V. A resistor divider pair can be used to divide the voltage down from a higher potential. A typical range of pullup resistor value is 10 kΩ to 100 kΩ.

Refer to 图 8-9. When the FB voltage is within the power-good band, +7% above and -6% below the internal reference V_{REF} typically, the PGOOD switch is turned off, and the PGOOD voltage is pulled up to the voltage level defined by the pullup resistor or divider. When the FB voltage is outside of the tolerance band, +9% above or -8% below V_{REF} typically, the PGOOD switch is turned on, and the PGOOD pin voltage is pulled low to indicate power bad.



图 8-9. Power-Good Flag

8.3.10 Overcurrent and Short-Circuit Protection

The LV14360 is protected from overcurrent condition by cycle-by-cycle current limiting on the peak current of the high-side MOSFET. High-side MOSFET overcurrent protection is implemented by the nature of the peak current mode control. The high-side switch current is compared to the output of the error amplifier (EA) minus slope compensation every switching cycle. See § 8.2 for more details. The peak current of the high-side switch is limited by a clamped maximum peak current threshold which is constant. Thus, the peak current limit of the high-side switch is not affected by the slope compensation and remains constant over the full duty cycle range.

The LV14360 also implements a frequency foldback to protect the converter in severe overcurrent or short conditions. The oscillator frequency is divided by two, four, and eight as the FB pin voltage decrease to 75%, 50%, 25% of V_{REF} . The frequency foldback increases the off-time by increasing the period of the switching cycle, so that it provides more time for the inductor current to ramp down and leads to a lower average inductor current. Lower frequency also means lower switching loss. Frequency foldback reduces power dissipation and prevents overheating and potential damage to the device.

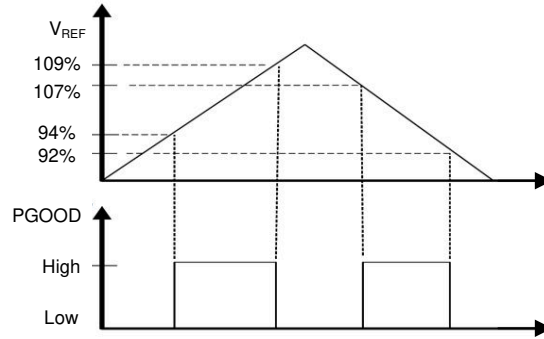
8.3.11 Overvoltage Protection

The LV14360 employs an output overvoltage protection (OVP) circuit to minimize voltage overshoot when recovering from output fault conditions or strong unload transients in designs with low output capacitance. The OVP feature minimizes output overshoot by turning off the high-side switch immediately when FB voltage reaches to the rising OVP threshold, which is nominally 109% of the internal voltage reference V_{REF} . When the FB voltage drops below the falling OVP threshold which is nominally 107% of V_{REF} , the high-side MOSFET resumes normal operation.

8.3.12 Thermal Shutdown

The LV14360 provides an internal thermal shutdown to protect the device when the junction temperature exceeds 170°C (typical). The high-side MOSFET stops switching when thermal shutdown activates. Once the die temperature falls below 158°C (typical), the device reinitiates the power-up sequence controlled by the internal soft-start circuitry.

8.4 Device Functional Modes

8.4.1 Shutdown Mode

The EN pin provides electrical ON and OFF control for the LV14360. When V_{EN} is below 1 V, the device is in shutdown mode. The switching regulator is turned off and the quiescent current drops to 1 μ A, typically. The LV14360 also employs UVLO protection. If V_{IN} voltage is below the UVLO level, the regulator is turned off.

8.4.2 Active Mode

The LV14360 is in active mode when V_{EN} is above the precision enable threshold and V_{IN} is above its UVLO level. The simplest way to enable the LV14360 is to connect the EN pin to VIN pin. This allows self start-up when the input voltage is in the operation range: 4.3 V to 60 V. See § 8.3.6 for details on setting these operating levels.

In active mode, depending on the load current, the LV14360 is in one of three modes:

1. Continuous conduction mode (CCM) with fixed switching frequency when load current is above half of the peak-to-peak inductor current ripple
2. Discontinuous conduction mode (DCM) with fixed switching frequency when load current is lower than half of the peak-to-peak inductor current ripple in CCM operation
3. Sleep-mode when internal COMP voltage drop to 400 mV at very light load

8.4.3 CCM Mode

CCM operation is employed in the LV14360 when the load current is higher than half of the peak-to-peak inductor current. In CCM operation, the frequency of operation is fixed, output voltage ripple will be at a minimum in this mode and the maximum output current of 3 A can be supplied by the LV14360.

8.4.4 Light Load Operation

When the load current is lower than half of the peak-to-peak inductor current in CCM, the LV14360 operates in DCM. At even lighter current loads, sleep mode is activated to maintain high efficiency operation by reducing switching and gate-drive losses.

9 Application and Implementation

备注

以下应用部分的信息不属于 TI 组件规范，TI 不担保其准确性和完整性。客户应负责确定 TI 组件是否适用于其应用。客户应验证并测试其设计，以确保系统功能。

9.1 Application Information

The LV14360 is a step-down DC-to-DC regulator. It is typically used to convert a higher DC voltage to a lower DC voltage with a maximum output current of 3 A. The following design procedure can be used to select components for the LV14360. This section presents a simplified discussion of the design process.

9.2 Typical Application

The LV14360 only requires a few external components to convert from wide voltage range supply to a fixed output voltage. A schematic of 5-V / 3-A application circuit is shown in 图 9-1. The external components have to fulfill the needs of the application, but also the stability criteria of the device control loop.



图 9-1. Application Circuit, 5-V Output

9.2.1 Design Requirements

This example details the design of a high frequency switching regulator using ceramic output capacitors. A few parameters must be known in order to start the design process. These parameters are typically determined at the system level:

表 9-1. Design Parameters

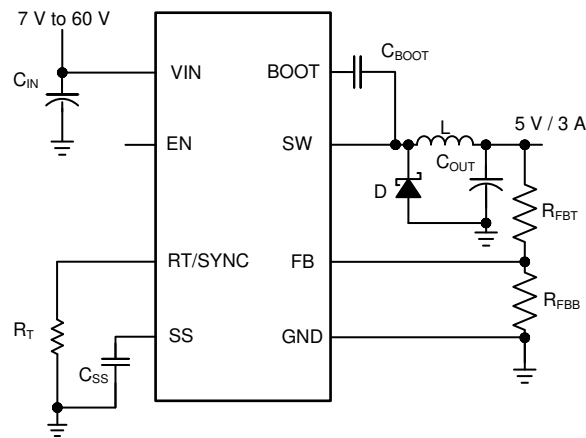
DESIGN PARAMETER	EXAMPLE VALUE
Input voltage, V_{IN}	7 V to 60 V, typical 24 V
Output voltage, V_{OUT}	5 V
Maximum output current I_{O_MAX}	3 A
Transient response 0.3 A to 3 A	5%
Output voltage ripple	50 mV
Input voltage ripple	400 mV
Switching frequency f_{SW}	500 KHz

9.2.2 Detailed Design Procedure

9.2.2.1 Output Voltage Set-Point

The output voltage of LV14360 is externally adjustable using a resistor divider network. The divider network is comprised of top feedback resistor R_{FBT} and bottom feedback resistor R_{FBB} . 方程式 7 is used to determine the output voltage:

$$R_{FBT} = \frac{V_{OUT} - 0.75}{0.75} \times R_{FBB} \quad (7)$$

Choose the value of R_{FBT} to be 100 k Ω . With the desired output voltage set to 5 V and the $V_{FB} = 0.75$ V, the R_{FBB} value can then be calculated using 方程式 7. The formula yields to a value 17.65 k Ω . Choose the closest available value of 17.8 k Ω for R_{FBB} .

9.2.2.2 Switching Frequency

For desired frequency, use 方程式 8 to calculate the required value for R_T .

$$R_T(\text{k}\Omega) = 42904 \times f_{SW}(\text{kHz})^{-1.088} \quad (8)$$

For 500 KHz, the calculated R_T is 49.66 k Ω , and standard value 49.9 k Ω can be used to set the switching frequency at 500 KHz.

9.2.2.3 Output Inductor Selection

The most critical parameters for the inductor are the inductance, saturation current, and the RMS current. The inductance is based on the desired peak-to-peak ripple current Δi_L . Since the ripple current increases with the input voltage, the maximum input voltage is always used to calculate the minimum inductance L_{MIN} . Use 方程式 9 to calculate the minimum value of the output inductor. K_{IND} is a coefficient that represents the amount of inductor ripple current relative to the maximum output current. A reasonable value of K_{IND} should be 20% to 40%. During an instantaneous short or overcurrent operation event, the RMS and peak inductor current can be high. The inductor current rating should be higher than current limit.

$$\Delta i_L = \frac{V_{OUT} \times (V_{IN_MAX} - V_{OUT})}{V_{IN_MAX} \times L \times f_{SW}} \quad (9)$$

$$L_{MIN} = \frac{V_{IN_MAX} - V_{OUT}}{I_{OUT} \times K_{IND}} \times \frac{V_{OUT}}{V_{IN_MAX} \times f_{SW}} \quad (10)$$

In general, it is preferable to choose lower inductance in switching power supplies, because it usually corresponds to faster transient response, smaller DCR, and reduced size for more compact designs. But too low of an inductance can generate too large of an inductor current ripple such that overcurrent protection at the full load can be falsely triggered. It also generates more conduction loss since the RMS current is slightly higher. Larger inductor current ripple also implies larger output voltage ripple with same output capacitors. With peak current mode control, it is not recommended to have too small of an inductor current ripple. A larger peak current ripple improves the comparator signal-to-noise ratio.

For this design example, choose $K_{IND} = 0.4$. The minimum inductor value is calculated to be 7.64 μH , and a nearest standard value is chosen: 8.2 μH . A standard 8.2- μH ferrite inductor with a capability of 3-A RMS current and 6-A saturation current can be used.

9.2.2.4 Output Capacitor Selection

Choose the output capacitor or capacitors, C_{OUT} , with care since it directly affects the steady state output voltage ripple, loop stability, and the voltage overshoot and undershoot during load current transients.

The output ripple is essentially composed of two parts. One is caused by the inductor current ripple going through the equivalent series resistance (ESR) of the output capacitors:

$$\Delta V_{\text{OUT_ESR}} = \Delta i_L \times \text{ESR} = K_{\text{IND}} \times I_{\text{OUT}} \times \text{ESR} \quad (11)$$

The other is caused by the inductor current ripple charging and discharging the output capacitors:

$$\Delta V_{\text{OUT_C}} = \frac{\Delta i_L}{8 \times f_{\text{SW}} \times C_{\text{OUT}}} = \frac{K_{\text{IND}} \times I_{\text{OUT}}}{8 \times f_{\text{SW}} \times C_{\text{OUT}}} \quad (12)$$

The two components in the voltage ripple are not in-phase, so the actual peak-to-peak ripple is smaller than the sum of two peaks.

Output capacitance is usually limited by transient performance specifications if the system requires tight voltage regulation with presence of large current steps and fast slew rate. When a fast large load increase happens, output capacitors provide the required charge before the inductor current can slew up to the appropriate level. The control loop of the regulator usually needs three or more clock cycles to respond to the output voltage droop. The output capacitance must be large enough to supply the current difference for three clock cycles to maintain the output voltage within the specified range. 方程式 13 shows the minimum output capacitance needed for specified output undershoot. When a sudden large load decrease happens, the output capacitors absorb energy stored in the inductor. The catch diode cannot sink current so the energy stored in the inductor results in an output voltage overshoot. 方程式 14 calculates the minimum capacitance required to keep the voltage overshoot within a specified range.

$$C_{\text{OUT}} > \frac{3 \times (I_{\text{OH}} - I_{\text{OL}})}{f_{\text{SW}} \times V_{\text{US}}} \quad (13)$$

$$C_{\text{OUT}} > \frac{I_{\text{OH}}^2 - I_{\text{OL}}^2}{(V_{\text{OUT}} + V_{\text{OS}})^2 - V_{\text{OUT}}^2} \times L \quad (14)$$

where

- K_{IND} = Ripple ratio of the inductor ripple current ($\Delta i_L / I_{\text{OUT}}$)
- I_{OL} = Low level output current during load transient
- I_{OH} = High level output current during load transient
- V_{US} = Target output voltage undershoot
- V_{OS} = Target output voltage overshoot

For this design example, the target output ripple is 50 mV. Presuppose $\Delta V_{\text{OUT_ESR}} = \Delta V_{\text{OUT_C}} = 50$ mV, and choose $K_{\text{IND}} = 0.4$. 方程式 11 yields ESR no larger than 41.7 m Ω and 方程式 12 yields C_{OUT} no smaller than 6 μ F. For the target overshoot and undershoot range of this design, $V_{\text{US}} = V_{\text{OS}} = 5\% \times V_{\text{OUT}} = 250$ mV. C_{OUT} can be calculated to be no smaller than 64.8 μ F and 6.4 μ F by 方程式 13 and 方程式 14, respectively. In summary, the most stringent criteria for the output capacitor is 100 μ F. For this design example, two 47- μ F, 16-V, X7R ceramic capacitors with 5-m Ω ESR are used in parallel.

9.2.2.5 Schottky Diode Selection

The breakdown voltage rating of the diode is preferred to be 25% higher than the maximum input voltage. The current rating for the diode should be equal to the maximum output current for best reliability in most applications. In cases where the input voltage is much greater than the output voltage, the average diode current is lower. In this case, it is possible to use a diode with a lower average current rating, approximately $(1 - D) \times I_{\text{OUT}}$, however, the peak current rating should be higher than the maximum load current. A 3-A rated diode is a good starting point.

9.2.2.6 Input Capacitor Selection

The LV14360 device requires high frequency input decoupling capacitor or capacitors and a bulk input capacitor, depending on the application. The typical recommended value for the high frequency decoupling capacitor is 4.7 μ F to 10 μ F. A high-quality ceramic capacitor type X5R or X7R with sufficient voltage rating is recommended. To compensate the derating of ceramic capacitors, a voltage rating of twice the maximum input voltage is recommended. Additionally, some bulk capacitance can be required, especially if the LV14360 circuit is not located within approximately 5 cm from the input voltage source. This capacitor is used to provide damping to the voltage spike due to the lead inductance of the cable or the trace. For this design, two 2.2- μ F, X7R ceramic capacitors rated for 100 V are used. Use a 0.1- μ F capacitor for high-frequency filtering and place it as close as possible to the device pins.

9.2.2.7 Bootstrap Capacitor Selection

Every LV14360 design requires a bootstrap capacitor (C_{BOOT}). The recommended capacitor is 0.1 μ F and rated 16 V or higher. The bootstrap capacitor is located between the SW pin and the BOOT pin. The bootstrap capacitor must be a high-quality ceramic type with an X7R or X5R grade dielectric for temperature stability.

9.2.3 Application Curves

Unless otherwise specified the following conditions apply: $V_{IN} = 24\text{ V}$, $f_{SW} = 500\text{ KHz}$, $L = 8.2\ \mu\text{H}$, $C_{OUT} = 2 \times 47\ \mu\text{F}$, $T_A = 25^\circ\text{C}$.

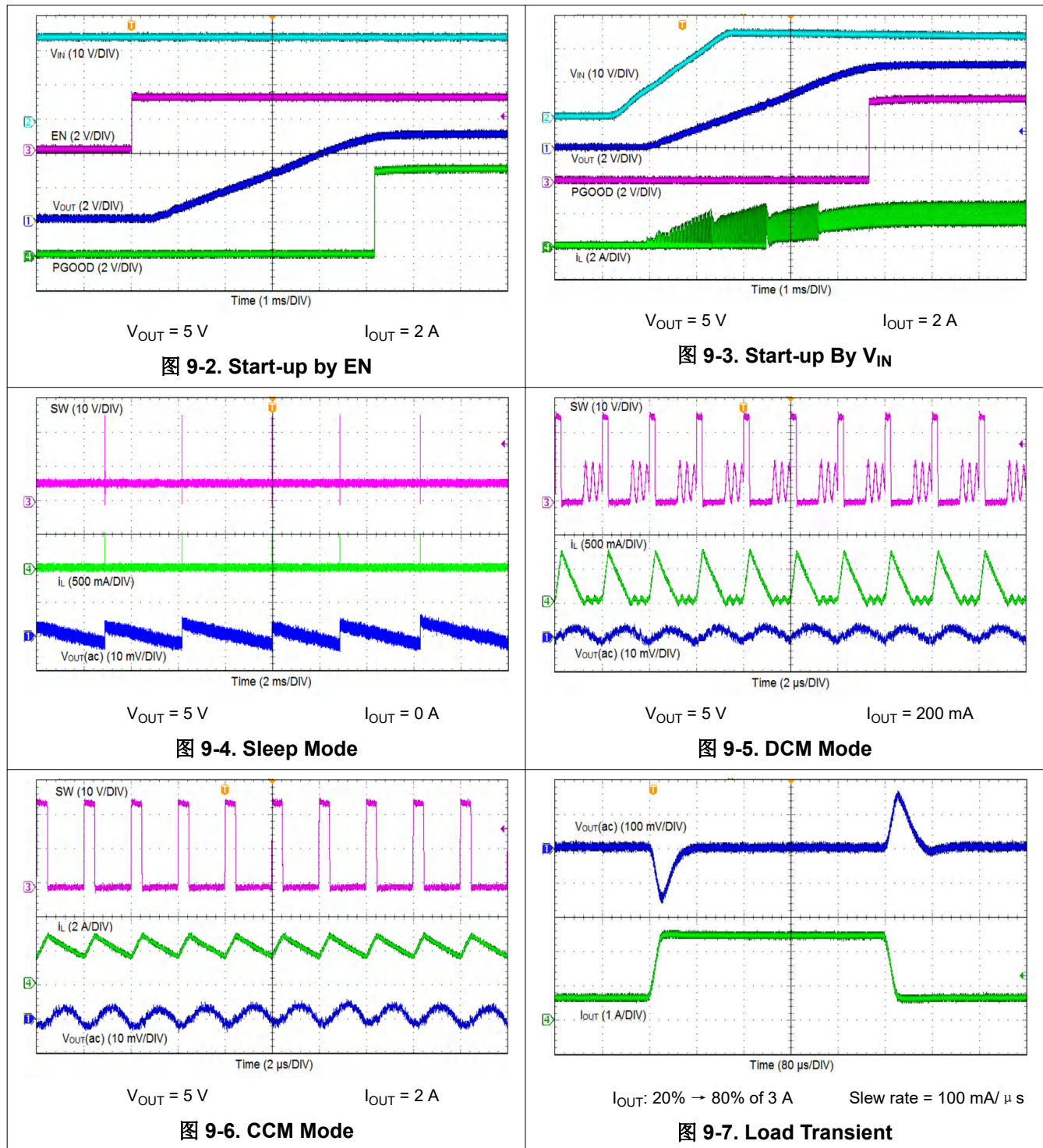

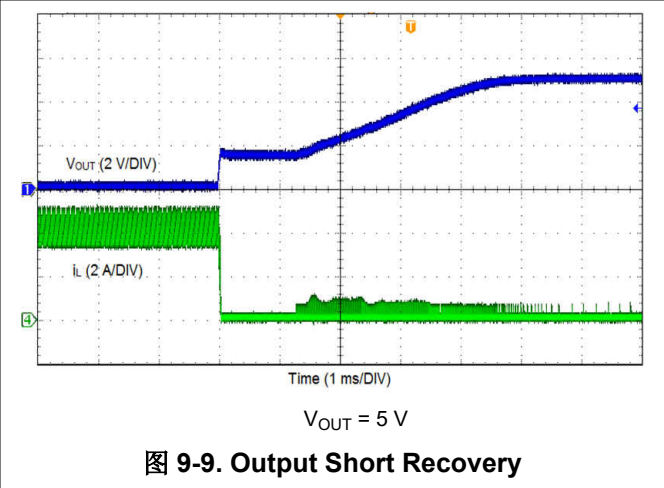
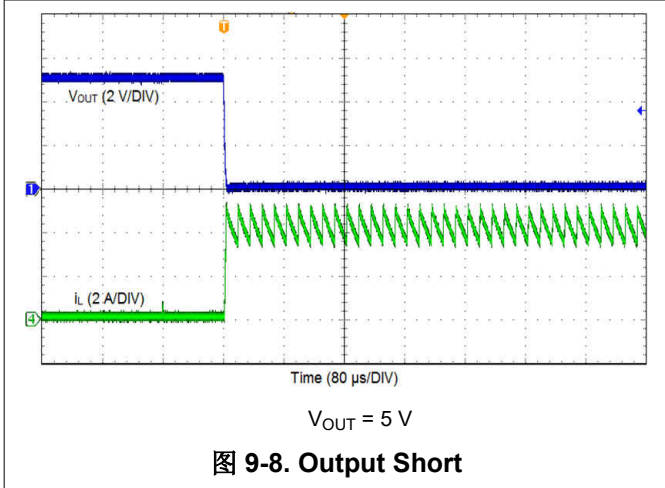

10 Power Supply Recommendations

The LV14360 is designed to operate from an input voltage supply range between 4.3 V and 60 V. This input supply should be able to withstand the maximum input current and maintain a stable voltage. The resistance of the input supply rail must be low enough that an input current transient does not cause a high enough drop at the LV14360 supply voltage that can cause a false UVLO fault triggering and system reset. If the input supply is located more than a few inches from the LV14360, additional bulk capacitance may be required in addition to the ceramic input capacitors. The amount of bulk capacitance is not critical, but a 47- μ F or 100- μ F electrolytic capacitor is a typical choice.

11 Layout

11.1 Layout Guidelines

Layout is a critical portion of good power supply design. The following guidelines will help users design a PCB with the best power conversion performance, thermal performance, and minimized generation of unwanted EMI.

1. The feedback network, resistor R_{FBT} and R_{FBB} , should be kept close to the FB pin. V_{OUT} sense path away from noisy nodes and preferably through a layer on the other side of a shielding layer.
2. The input bypass capacitor C_{IN} must be placed as close as possible to the VIN pin and ground. Grounding for both the input and output capacitors should consist of localized top side planes that connect to the GND pin and PAD.
3. The inductor L should be placed close to the SW pin to reduce magnetic and electrostatic noise.
4. Place the output capacitor, C_{OUT} close to the junction of L and the diode D. Keep the L, D, and C_{OUT} trace as short as possible to reduce conducted and radiated noise and increase overall efficiency.
5. The ground connection for the diode, C_{IN} , and C_{OUT} should be as small as possible and tied to the system ground plane in only one spot (preferably at the C_{OUT} ground point) to minimize conducted noise in the system ground plane.
6. For more detail on switching power supply layout considerations see [AN-1149 Layout Guidelines for Switching Power Supplies](#).

11.2 Layout Example



图 11-1. Layout

12 Device and Documentation Support

12.1 接收文档更新通知

要接收文档更新通知，请导航至 ti.com 上的器件产品文件夹。点击 [订阅更新](#) 进行注册，即可每周接收产品信息更改摘要。有关更改的详细信息，请查看任何已修订文档中包含的修订历史记录。

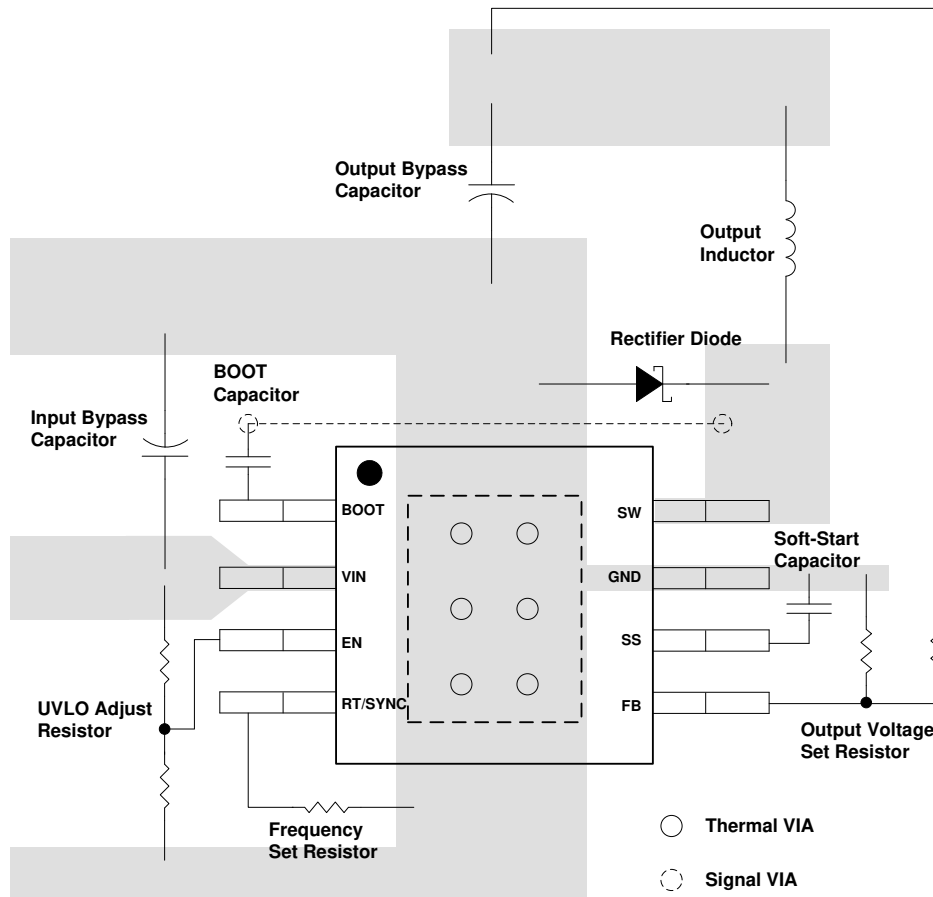
12.2 支持资源

TI E2E™ 支持论坛 是工程师的重要参考资料，可直接从专家获得快速、经过验证的解答和设计帮助。搜索现有解答或提出自己的问题可获得所需的快速设计帮助。

链接的内容由各个贡献者“按原样”提供。这些内容并不构成 TI 技术规范，并且不一定反映 TI 的观点；请参阅 TI 的《[使用条款](#)》。

12.3 Trademarks

PowerPAD™ is a trademark of TI.

TI E2E™ is a trademark of Texas Instruments.

所有商标均为其各自所有者的财产。

12.4 术语表

TI 术语表 本术语表列出并解释了术语、首字母缩略词和定义。

12.5 静电放电警告



静电放电 (ESD) 会损坏这个集成电路。德州仪器 (TI) 建议通过适当的预防措施处理所有集成电路。如果不遵守正确的处理和安装程序，可能会损坏集成电路。

ESD 的损坏小至导致微小的性能降级，大至整个器件故障。精密的集成电路可能更容易受到损坏，这是因为非常细微的参数更改都可能会导致器件与其发布的规格不相符。

13 Mechanical, Packaging, and Orderable Information

The following pages include mechanical, packaging, and orderable information. This information is the most current data available for the designated devices. This data is subject to change without notice and revision of this document. For browser-based versions of this data sheet, refer to the left-hand navigation.

PACKAGING INFORMATION

Orderable Device	Status (1)	Package Type	Package Drawing	Pins	Package Qty	Eco Plan (2)	Lead finish/ Ball material (6)	MSL Peak Temp (3)	Op Temp (°C)	Device Marking (4/5)	Samples
LV14360PDDAR	ACTIVE	SO PowerPAD	DDA	8	2500	RoHS & Green	NIPDAUAG	Level-2-260C-1 YEAR	-40 to 150	14360P	Samples
LV14360SDDAR	ACTIVE	SO PowerPAD	DDA	8	2500	RoHS & Green	NIPDAUAG	Level-2-260C-1 YEAR	-40 to 150	14360S	Samples

(1) The marketing status values are defined as follows:

ACTIVE: Product device recommended for new designs.

LIFEBUY: TI has announced that the device will be discontinued, and a lifetime-buy period is in effect.

NRND: Not recommended for new designs. Device is in production to support existing customers, but TI does not recommend using this part in a new design.

PREVIEW: Device has been announced but is not in production. Samples may or may not be available.

OBsolete: TI has discontinued the production of the device.

(2) **RoHS:** TI defines "RoHS" to mean semiconductor products that are compliant with the current EU RoHS requirements for all 10 RoHS substances, including the requirement that RoHS substance do not exceed 0.1% by weight in homogeneous materials. Where designed to be soldered at high temperatures, "RoHS" products are suitable for use in specified lead-free processes. TI may reference these types of products as "Pb-Free".

RoHS Exempt: TI defines "RoHS Exempt" to mean products that contain lead but are compliant with EU RoHS pursuant to a specific EU RoHS exemption.

Green: TI defines "Green" to mean the content of Chlorine (Cl) and Bromine (Br) based flame retardants meet JS709B low halogen requirements of <=1000ppm threshold. Antimony trioxide based flame retardants must also meet the <=1000ppm threshold requirement.

(3) MSL, Peak Temp. - The Moisture Sensitivity Level rating according to the JEDEC industry standard classifications, and peak solder temperature.

(4) There may be additional marking, which relates to the logo, the lot trace code information, or the environmental category on the device.

(5) Multiple Device Markings will be inside parentheses. Only one Device Marking contained in parentheses and separated by a "~" will appear on a device. If a line is indented then it is a continuation of the previous line and the two combined represent the entire Device Marking for that device.

(6) Lead finish/Ball material - Orderable Devices may have multiple material finish options. Finish options are separated by a vertical ruled line. Lead finish/Ball material values may wrap to two lines if the finish value exceeds the maximum column width.

Important Information and Disclaimer:The information provided on this page represents TI's knowledge and belief as of the date that it is provided. TI bases its knowledge and belief on information provided by third parties, and makes no representation or warranty as to the accuracy of such information. Efforts are underway to better integrate information from third parties. TI has taken and continues to take reasonable steps to provide representative and accurate information but may not have conducted destructive testing or chemical analysis on incoming materials and chemicals. TI and TI suppliers consider certain information to be proprietary, and thus CAS numbers and other limited information may not be available for release.

In no event shall TI's liability arising out of such information exceed the total purchase price of the TI part(s) at issue in this document sold by TI to Customer on an annual basis.

TAPE AND REEL INFORMATION



QUADRANT ASSIGNMENTS FOR PIN 1 ORIENTATION IN TAPE



*All dimensions are nominal

Device	Package Type	Package Drawing	Pins	SPQ	Reel Diameter (mm)	Reel Width W1 (mm)	A0 (mm)	B0 (mm)	K0 (mm)	P1 (mm)	W (mm)	Pin1 Quadrant
LV14360PDDAR	SO Power PAD	DDA	8	2500	330.0	12.8	6.4	5.2	2.1	8.0	12.0	Q1
LV14360SDDAR	SO Power PAD	DDA	8	2500	330.0	12.8	6.4	5.2	2.1	8.0	12.0	Q1

TAPE AND REEL BOX DIMENSIONS

*All dimensions are nominal

Device	Package Type	Package Drawing	Pins	SPQ	Length (mm)	Width (mm)	Height (mm)
LV14360PDDAR	SO PowerPAD	DDA	8	2500	366.0	364.0	50.0
LV14360SDDAR	SO PowerPAD	DDA	8	2500	366.0	364.0	50.0

DDA (R-PDSO-G8)

PowerPAD™ PLASTIC SMALL-OUTLINE



4202561/F 12/11

- NOTES:
- All linear dimensions are in millimeters. Dimensioning and tolerancing per ASME Y14.5-1994.
 - This drawing is subject to change without notice.
 - Body dimensions do not include mold flash or protrusion not to exceed 0,15.
 - This package is designed to be soldered to a thermal pad on the board. Refer to Technical Brief, PowerPad Thermally Enhanced Package, Texas Instruments Literature No. SLMA002 for information regarding recommended board layout. This document is available at www.ti.com <<http://www.ti.com>>.
 - See the additional figure in the Product Data Sheet for details regarding the exposed thermal pad features and dimensions.
 - This package complies to JEDEC MS-012 variation BA

PowerPAD is a trademark of Texas Instruments.

DDA (R-PDSO-G8)

PowerPAD™ PLASTIC SMALL OUTLINE

THERMAL INFORMATION

This PowerPAD™ package incorporates an exposed thermal pad that is designed to be attached to a printed circuit board (PCB). The thermal pad must be soldered directly to the PCB. After soldering, the PCB can be used as a heatsink. In addition, through the use of thermal vias, the thermal pad can be attached directly to the appropriate copper plane shown in the electrical schematic for the device, or alternatively, can be attached to a special heatsink structure designed into the PCB. This design optimizes the heat transfer from the integrated circuit (IC).

For additional information on the PowerPAD package and how to take advantage of its heat dissipating abilities, refer to Technical Brief, PowerPAD Thermally Enhanced Package, Texas Instruments Literature No. SLMA002 and Application Brief, PowerPAD Made Easy, Texas Instruments Literature No. SLMA004. Both documents are available at www.ti.com.

The exposed thermal pad dimensions for this package are shown in the following illustration.



Exposed Thermal Pad Dimensions

4206322-6/L 05/12

NOTE: A. All linear dimensions are in millimeters

PowerPAD is a trademark of Texas Instruments



- NOTES:
- A. All linear dimensions are in millimeters.
 - B. This drawing is subject to change without notice.
 - C. Publication IPC-7351 is recommended for alternate designs.
 - D. This package is designed to be soldered to a thermal pad on the board. Refer to Technical Brief, PowerPad Thermally Enhanced Package, Texas Instruments Literature No. SLMA002, SLMA004, and also the Product Data Sheets for specific thermal information, via requirements, and recommended board layout. These documents are available at www.ti.com <<http://www.ti.com>>. Publication IPC-7351 is recommended for alternate designs.
 - E. Laser cutting apertures with trapezoidal walls and also rounding corners will offer better paste release. Customers should contact their board assembly site for stencil design recommendations. Example stencil design based on a 50% volumetric metal load solder paste. Refer to IPC-7525 for other stencil recommendations.
 - F. Customers should contact their board fabrication site for solder mask tolerances between and around signal pads.

PowerPAD is a trademark of Texas Instruments.

重要声明和免责声明

TI“按原样”提供技术和可靠性数据（包括数据表）、设计资源（包括参考设计）、应用或其他设计建议、网络工具、安全信息和其他资源，不保证没有瑕疵且不做任何明示或暗示的担保，包括但不限于对适销性、某特定用途方面的适用性或不侵犯任何第三方知识产权的暗示担保。

这些资源可供使用 TI 产品进行设计的熟练开发人员使用。您将自行承担以下全部责任：(1) 针对您的应用选择合适的 TI 产品，(2) 设计、验证并测试您的应用，(3) 确保您的应用满足相应标准以及任何其他功能安全、信息安全、监管或其他要求。

这些资源如有变更，恕不另行通知。TI 授权您仅可将这些资源用于研发本资源所述的 TI 产品的应用。严禁对这些资源进行其他复制或展示。您无权使用任何其他 TI 知识产权或任何第三方知识产权。您应全额赔偿因在这些资源的使用中对 TI 及其代表造成的任何索赔、损害、成本、损失和债务，TI 对此概不负责。

TI 提供的产品受 [TI 的销售条款](#) 或 [ti.com](#) 上其他适用条款/TI 产品随附的其他适用条款的约束。TI 提供这些资源并不会扩展或以其他方式更改 TI 针对 TI 产品发布的适用的担保或担保免责声明。

TI 反对并拒绝您可能提出的任何其他或不同的条款。

邮寄地址：Texas Instruments, Post Office Box 655303, Dallas, Texas 75265

Copyright © 2022，德州仪器 (TI) 公司