

SNx5LBC179A 低功耗差分线路驱动器和接收器对

1 特性

- 高速低功耗 LinBiCMOS™ 电路专为高达 30Mbps 的信号传输速率⁽¹⁾ 而设计
- 总线引脚 ESD 保护超过 12kV HBM
- 超低禁用电源电流要求：700 μ A (最大值)
- -7V 至 12V 的共模电压范围
- 低电源电流：15 mA (最大值)
- 与 ANSI 标准 TIA/EIA-485-A 和 ISO8482 兼容：1987(E)
- 正负输出电流限制
- TIA/EIA-485-A 定义规定的驱动器热关断保护¹

2 说明

SN65LBC179A 和 SN75LBC179A 差分驱动器和接收器对是单片集成电路，设计用于通过具有传输线特性的长电缆进行双向数据通信。它们是符合 ANSI 标准 TIA/EIA-485-A 和 ISO 8482:1987(E) 的平衡或差分电压模式器件。与前代产品相比，A 版本可提供更高的开关性能，而不会显著降低功耗。

SN65LBC179A 和 SN75LBC179A 整合了差分线路驱动器和差分输入线路接收器，并采用 5V 单电源供电。驱动器差分输出和接收器差分输入连接到单独的端子以实现全双工工作，并且用于在断电 ($V_{CC} = 0$) 时为总线提供最小负载。这些器件具有较宽的正负共模电压范围，因此适用于点对点或多点数据总线应用。这些器件还提供正负电流限制和热关断功能，避免出现线路故障状况。

SN65LBC179A 可在 -40°C 至 85°C 的工业温度范围内运行。SN75LBC179A 可在 0°C 至 70°C 的工业温度范围内运行。

封装信息

器件型号	封装 ⁽¹⁾	封装尺寸 (标称值)
SN65LBC179ASN75LBC179A	D (SOIC)	4.9 mm x 3.91 mm
	P (PDIP)	9.81mm x 6.35mm

(1) 如需了解所有可用封装，请参阅数据表末尾的可订购产品附录。



图 2-1. 逻辑图 (正逻辑)

¹ (1)信号传输速率将转换时间限制在位长度的 30%，在没有此要求的情况下可以实现更高的信号传输速率，如此器件的典型特性所示。

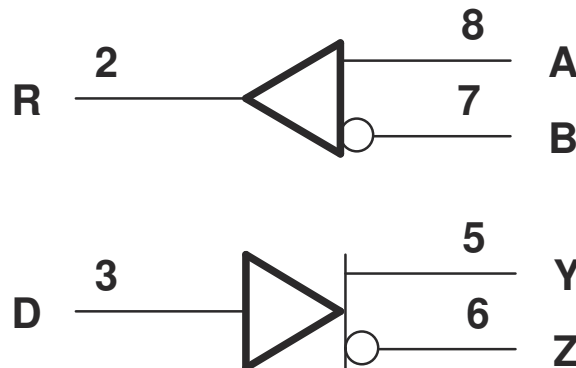

Table of Contents

1 特性	1	5.9 Typical Characteristics.....	7
2 说明	1	6 Parameter Measurement Information	10
3 Revision History	2	7 Detailed Description	12
4 Pin Configuration and Functions	3	7.1 Device Functional Modes.....	12
5 Specifications	4	8 Device and Documentation Support	13
5.1 Absolute Maximum Ratings.....	4	8.1 接收文档更新通知.....	13
5.2 Dissipation Ratings.....	4	8.2 支持资源.....	13
5.3 Recommended Operating Conditions.....	4	8.3 商标.....	13
5.4 Thermal Information.....	5	8.4 静电放电警告.....	13
5.5 Driver Electrical Characteristics.....	5	8.5 术语表.....	13
5.6 Driver Switching Characteristics.....	6	9 Mechanical, Packaging, and Orderable Information..	13
5.7 Receiver Electrical Characteristics.....	6		
5.8 Receiver Switching Characteristics.....	6		

3 Revision History

注：以前版本的页码可能与当前版本的页码不同

Changes from Revision D (September 2011) to Revision E (January 2023)	Page
• 将文档更改为了最新 TI 格式.....	1
• Added the <i>Thermal Information</i> table.....	5
• Changed the <i>Typical Characteristics</i> graphs.....	7

Changes from Revision C (June 2001) to Revision D (September 2011)	Page
• Added Receiver output current to the Abs Max Table	4
• Changed ESD - All terminals, Class 3, A From: 4 kV To: 3 kV.....	4
• Changed the D Output and R Output schematics.....	12

4 Pin Configuration and Functions

SN65LBC179AD (Marked as BL179A)
 SN65LBC179AP (Marked as 65LBC179A)
 SN75LBC179AD (Marked as LB179A)
 SN75LBC179AP (Marked as 75LBC179A)
 (TOP VIEW)



表 4-1. Pin Functions

NO	Name	Type	Description
1	V _{CC}	Supply	4.75V to 5.25V Supply
2	R	O	Receive data output
3	D	I	Driver data input
4	GND	GND	Device ground
5	Y	O	Digital bus output, Y (Complementary to Z)
6	Z	O	Digital bus output, Z (Complementary to Y)
7	B	I	Bus input, B (complementary to A)
8	A	I	Bus input, A (complementary to B)

5 Specifications

5.1 Absolute Maximum Ratings

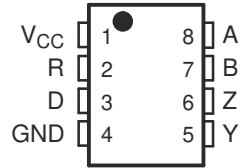
over operating free-air temperature range (unless otherwise noted)⁽¹⁾

		UNIT
V _{CC}	Supply voltage range ⁽²⁾	- 0.3 V to 6 V
Voltage range	A, B, Y, or Z ⁽²⁾	- 10 V to 15 V
	D or R ⁽²⁾	- 0.3 V to V _{CC} + 0.5 V
I _O	Receiver output current	±20 mA
Electrostatic discharge	Bus terminals and GND, Class 3, A ⁽³⁾	12 kV
	Bus terminals and GND, Class 3, B ⁽³⁾	400 V
	All terminals, Class 3, A	3 kV
	All terminals, Class 3, B	400 V
Continuous total power dissipation ⁽⁴⁾		Internally limited
Total power dissipation		See Dissipation Rating Table

- (1) Stresses beyond those listed under *absolute maximum ratings* may cause permanent damage to the device. These are stress ratings only, and functional operation of the device at these or any other conditions beyond those indicated under *recommended operating conditions* is not implied. Exposure to absolute-maximum-rated conditions for extended periods may affect device reliability.
- (2) All voltage values, except differential I/O bus voltages, are with respect to GND.
- (3) Tested in accordance with MIL-STD-883C, Method 3015.7
- (4) The maximum operating junction temperature is internally limited. Uses the dissipation rating table to operate below this temperature.

5.2 Dissipation Ratings

PACKAGE	T _A ≤ 25°C POWER RATING	DERATING FACTOR ⁽¹⁾ ABOVE T _A = 25°C	T _A = 70°C POWER RATING	T _A = 85°C POWER RATING
D	725 mW	5.8 mW/°C	464 mW	377 mW
P	1100 mW	8.08 mW/°C	640 mW	520 mW

- (1) This is the inverse of the junction-to-ambient thermal resistance when board-mounted and with no air flow.

5.3 Recommended Operating Conditions

		MIN	NOM	MAX	UNIT
V _{CC}	Supply voltage	4.75	5	5.25	V
V _{IH}	High-level input voltage	D	2	V _{CC}	V
V _{IL}	Low-level input voltage	D	0	0.8	V
V _{ID}	Differential input voltage ⁽¹⁾	- 12 ⁽²⁾		12	V
V _O	Voltage at any bus terminal (separately or common-mode)	A, B, Y, or Z	- 7	12	V
V _I					
V _{IC}					
I _{OH}	High-level output current	Y or Z	- 60		mA
		R	- 8		
I _{OL}	Low-level output current	Y or Z		60	mA
		R		8	
T _A	Operating free-air temperature	SN65LBC179A	- 40	85	°C
		SN75LBC179A	0	70	

- (1) Differential input/output bus voltage is measured at the noninverting terminal with respect to the inverting terminal.
- (2) The algebraic convention, in which the least positive (most negative) limit is designated as minimum, is used in this data sheet.

5.4 Thermal Information

THERMAL METRIC ⁽¹⁾		P (PDIP)	D (SOIC) SN65 Device	D (SOIC) SN75 Device	UNIT
		8-Pins	8-Pins	8-Pins	
$R_{\theta JA}$	Junction-to-ambient thermal resistance	65.7	116.7	110	°C/W
$R_{\theta JC(top)}$	Junction-to-case thermal resistance	54.7	56.3	44.1	°C/W
$R_{\theta JB}$	Junction-to-board thermal resistance	42.1	63.4	53.5	°C/W
ψ_{JT}	Junction-to-top characterization parameter	23	8.8	4.8	°C/W
ψ_{JB}	Junction-to-board characterization parameter	41.7	62.2	52.7	°C/W
$R_{\theta JC(bot)}$	Junction-to-case (bottom) thermal resistance	N/A	N/A	N/A	°C/W

(1) For more information about traditional and new thermal metrics, see the [Semiconductor and IC package thermal metrics](#) application report.

5.5 Driver Electrical Characteristics

over recommended operating conditions (unless otherwise noted)

PARAMETER		TEST CONDITIONS		MIN	TYP ⁽¹⁾	MAX	UNIT
V_{IK}	Input clamp voltage	$I_I = -18 \text{ mA}$		-1.5	-0.8		V
$ V_{OD} $	Differential output voltage	$R_L = 54 \Omega$, See 图 6-1	SN65LBC179A	1	1.5	3	V
			SN75LBC179A	1.1	1.5	3	
		$R_L = 60 \Omega$, $-7 < V_{(tot)} < 12$, See 图 6-2	SN65LBC179A	1	1.5	3	V
			SN75LBC179A	1.1	1.5	3	
$\Delta V_{OD} $	Change in magnitude of differential output voltage ⁽²⁾	See 图 6-1 and 图 6-2		-0.2		0.2	V
$V_{OC(SS)}$	Steady-state common-mode output voltage	See 图 6-1		1.8	2.4	2.8	V
$\Delta V_{OC(SS)}$	Change in steady-state common-mode output voltage ⁽²⁾			-0.1		0.1	V
I_O	Output current with power off	$V_{CC} = 0$,	$V_O = -7 \text{ V to } 12 \text{ V}$	-10	± 1	10	μA
I_{IH}	High-level input current	$V_I = 2 \text{ V}$		-100			μA
I_{IL}	Low-level input current	$V_I = 0.8 \text{ V}$		-100			μA
I_{OS}	Short-circuit output current	$-7 \text{ V} \leq V_O \leq 12 \text{ V}$		-250	± 70	250	mA
I_{CC}	Supply current	No load, $V_I = 0$ or V_{CC}			8.5	15	mA

(1) All typical values are at $V_{CC} = 5 \text{ V}$, $T_A = 25^\circ\text{C}$.

(2) $\Delta |V_{OD}|$ and $\Delta |V_{OC}|$ are the changes in the steady-state magnitude of V_{OD} and V_{OC} , respectively, that occur when the input is changed from a high level to a low level.

5.6 Driver Switching Characteristics

over recommended operating conditions (unless otherwise noted)

PARAMETER	TEST CONDITIONS	MIN	TYP	MAX	UNIT
t_{PLH} Propagation delay time, low-to-high-level output	$R_L = 54 \Omega$, $C_L = 50$ pF, See 图 6-3	2	6	12	ns
t_{PHL} Propagation delay time, high-to-low-level output		2	6	12	ns
$t_{sk(p)}$ Pulse skew ($ t_{PHL} - t_{PLH} $)			0.3	1	ns
t_r Differential output signal rise time		4	7.5	11	ns
t_f Differential output signal fall time		4	7.5	11	ns

5.7 Receiver Electrical Characteristics

over recommended operating conditions (unless otherwise noted)

PARAMETER	TEST CONDITIONS	MIN	TYP	MAX	UNIT
V_{IT+} Positive-going input threshold voltage	$I_O = -8$ mA			0.2	V
V_{IT-} Negative-going input threshold voltage	$I_O = 8$ mA	-0.2			
V_{hys} Hysteresis voltage ($V_{IT+} - V_{IT-}$)			50		mV
V_{OH} High-level output voltage	$V_{ID} = 200$ mV, $I_{OH} = -8$ mA, See 图 6-1	4	4.9		V
V_{OL} Low-level output voltage	$V_{ID} = -200$ mV, $I_{OL} = 8$ mA, See 图 6-1		0.1	0.8	V
I_I Bus input current	$V_{IH} = 12$ V, $V_{CC} = 5$ V		0.4	1	mA
	$V_{IH} = 12$ V, $V_{CC} = 0$		0.5	1	
	$V_{IH} = -7$ V, $V_{CC} = 5$ V	-0.8	-0.4		
	$V_{IH} = -7$ V, $V_{CC} = 0$	-0.8	-0.3		

5.8 Receiver Switching Characteristics

over recommended operating conditions (unless otherwise noted)

PARAMETER	TEST CONDITIONS	MIN	TYP	MAX	UNIT
t_{PLH} Propagation delay time, low-to-high-level output	$V_{ID} = -1.5$ V to 1.5 V, See 图 6-4	7	13	20	ns
t_{PHL} Propagation delay time, high-to-low-level output		7	13	20	ns
$t_{sk(p)}$ Pulse skew ($ t_{PLH} - t_{PHL} $)			0.5	1.5	ns
t_r Rise time, output			2.1	3.3	ns
t_f Fall time, output		See 图 6-4		2.1	3.3

5.9 Typical Characteristics



图 5-1. Typical Waveform of Non-Return-To-Zero (NRZ), Pseudorandom Binary Sequence (PRBS) Data at 100 Mbps Through 15m, of CAT 5 Unshielded Twisted Pair (UTP) Cable

TIA/EIA-485-A defines a maximum signaling rate as that in which the transition time of the voltage transition of a logic-state change remains less than or equal to 30% of the bit length. Transition times of greater length perform quite well even though they do not meet the standard by definition.



图 5-2. Average Supply Current vs Frequency

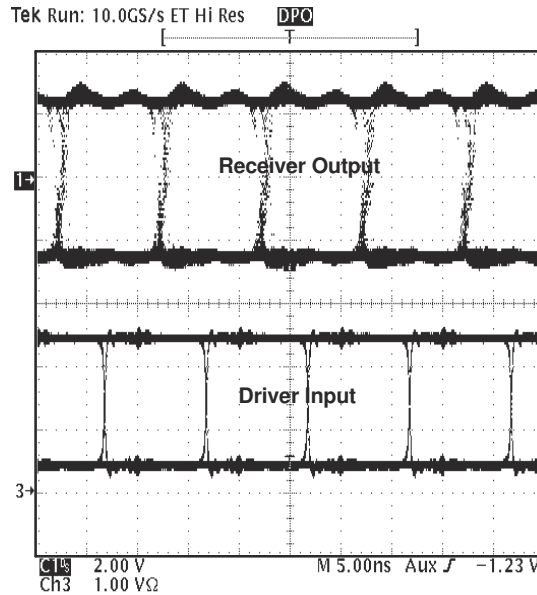

图 5-3. Logic Input Current vs Input Voltage

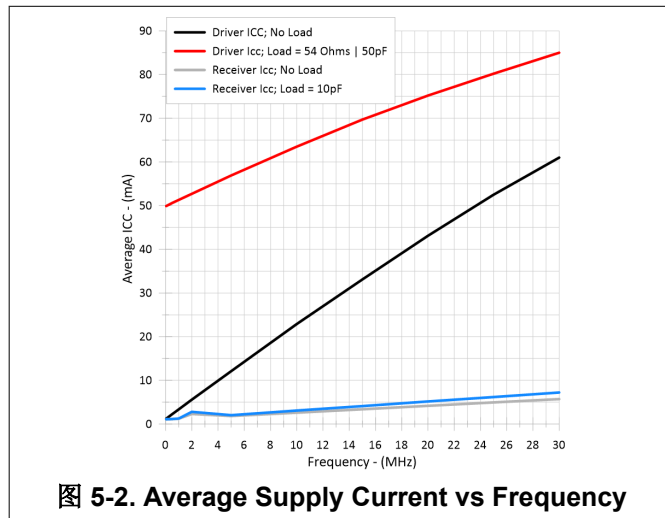

图 5-4. Input Current vs Input Voltage

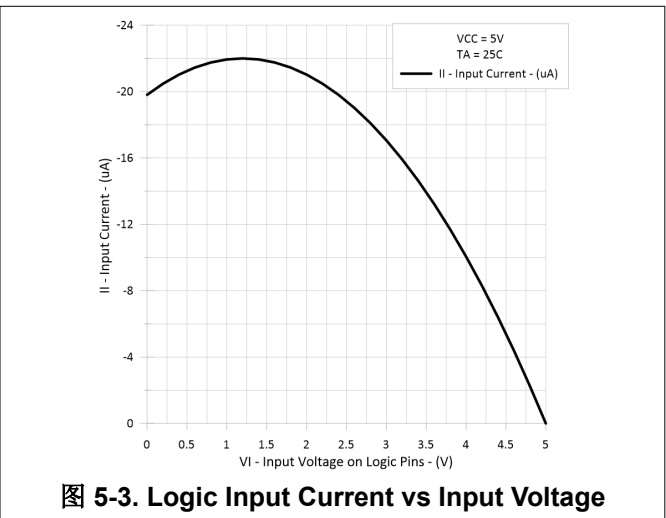

图 5-5. Low-Level Output Voltage vs Low-Level Output Current

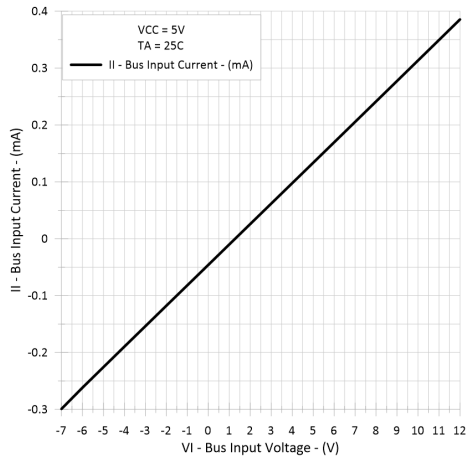

图 5-6. Driver High-Level Output Voltage vs HIGH-Level Output Current

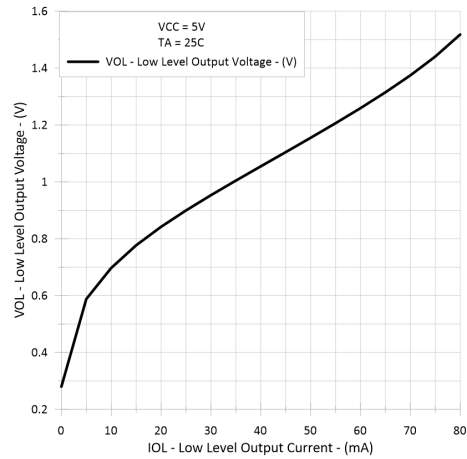

图 5-7. Driver Differential Output Voltage vs Average Case Temperature

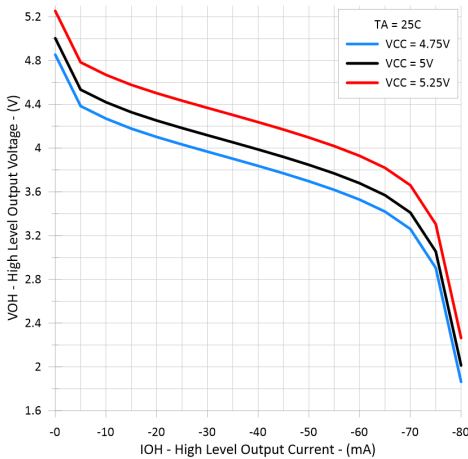

图 5-8. Receiver Propagation Time vs Case Temperature

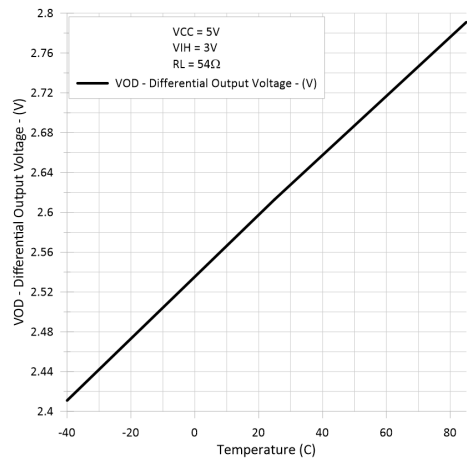

图 5-9. Driver Propagation Delay Time vs Case Temperature

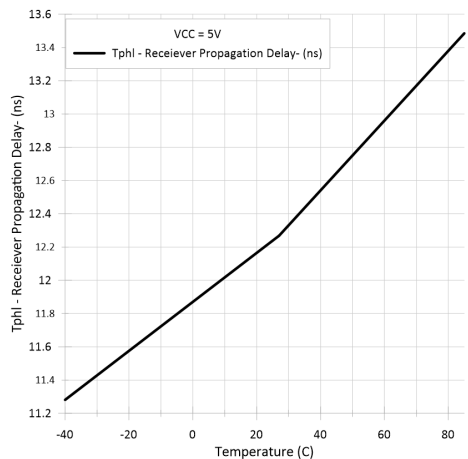

图 5-10. Driver Output Current vs Supply Voltage

6 Parameter Measurement Information

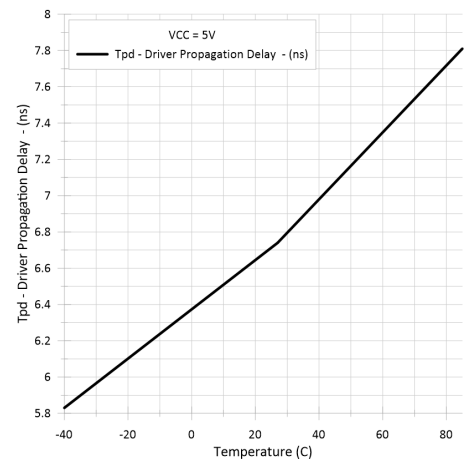

图 6-1. Driver V_{OD} and V_{OC}

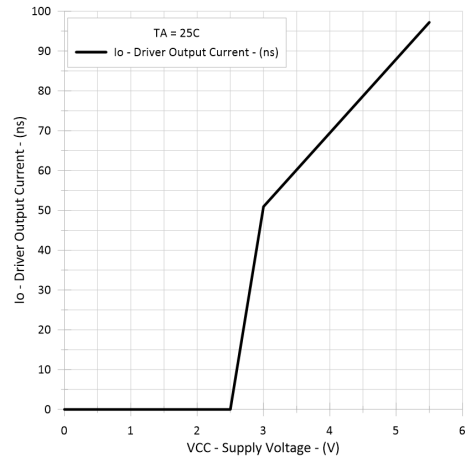

图 6-2. Driver V_{OD} With Common-Mode Loading

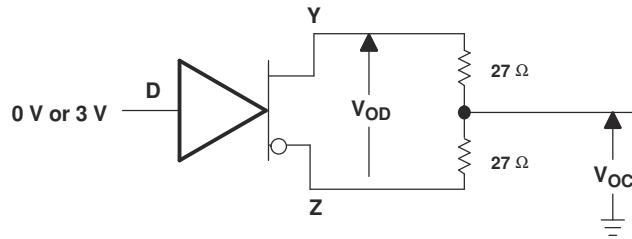

- A. The input pulse is supplied by a generator having the following characteristics: $PRR \leq 1 \text{ MHz}$, 50% duty cycle, $t_r \leq 6 \text{ ns}$, $t_f \leq 6 \text{ ns}$, $Z_O = 50 \Omega$.
- B. C_L includes probe and jig capacitance.

图 6-3. Driver Test Circuits and Voltage Waveforms

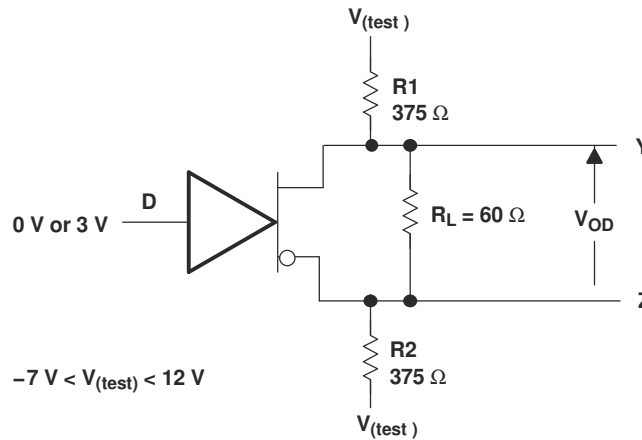
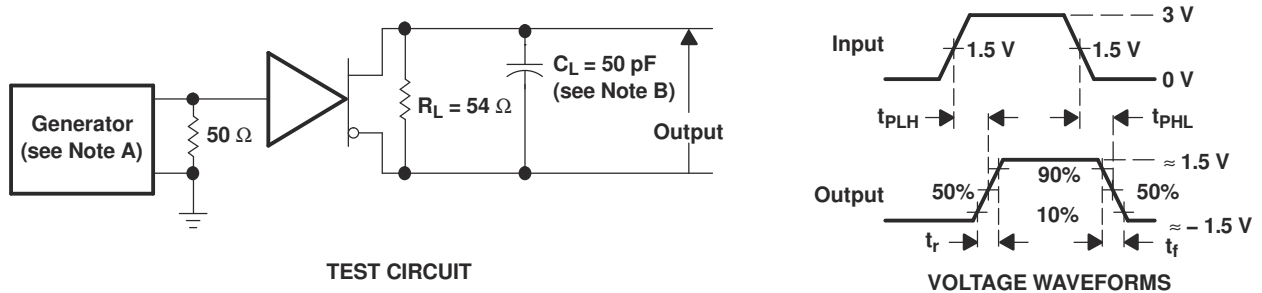
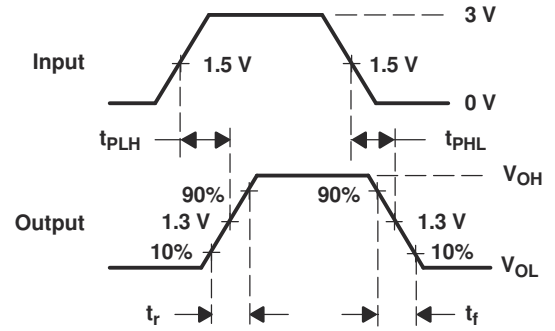
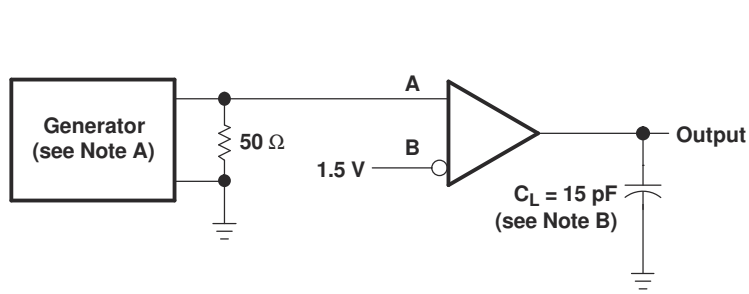

TEST CIRCUIT

VOLTAGE WAVEFORMS

- A. The input pulse is supplied by a generator having the following characteristics: PRR ≤ 1 MHz, 50% duty cycle, t_r ≤ 6 ns, t_f ≤ 6 ns, Z_O = 50 Ω.
- B. C_L includes probe and jig capacitance.

图 6-4. Receiver Test Circuit and Voltage Waveforms

7 Detailed Description

7.1 Device Functional Modes

7.1.1 FUNCTION TABLE

DRIVER			RECEIVER	
INPUT D	OUTPUTS ⁽¹⁾		DIFFERENTIAL INPUTS A - B	OUTPUT R
	Y	Z		
H	H	L	$V_{ID} \geq 0.2 \text{ V}$	H
L	L	H	$-0.2 \text{ V} < V_{ID} < 0.2 \text{ V}$?
OPEN	H	L	$V_{ID} \leq -0.2 \text{ V}$	L
			Open circuit	H

(1) H = high level, L = low level, ? = indeterminate

7.1.2 Schematics

Schematics of Inputs and Output

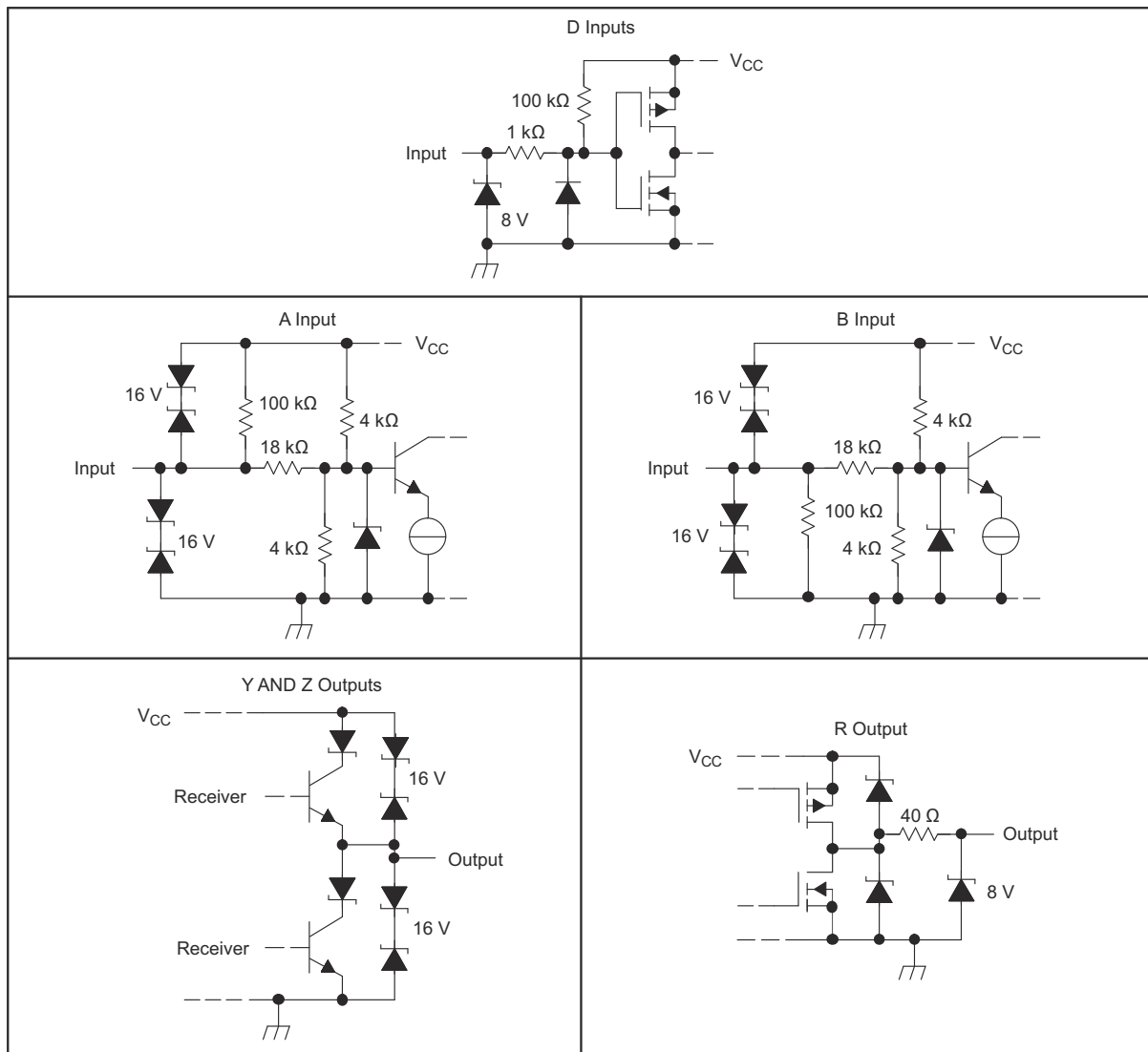

8 Device and Documentation Support

8.1 接收文档更新通知

要接收文档更新通知，请导航至 ti.com 上的器件产品文件夹。点击 [订阅更新](#) 进行注册，即可每周接收产品信息更改摘要。有关更改的详细信息，请查看任何已修订文档中包含的修订历史记录。

8.2 支持资源

[TI E2E™ 支持论坛](#) 是工程师的重要参考资料，可直接从专家获得快速、经过验证的解答和设计帮助。搜索现有解答或提出自己的问题可获得所需的快速设计帮助。

链接的内容由各个贡献者“按原样”提供。这些内容并不构成 TI 技术规范，并且不一定反映 TI 的观点；请参阅 TI 的《[使用条款](#)》。

8.3 商标

LinBiCMOS™ and TI E2E™ are trademarks of Texas Instruments.

所有商标均为其各自所有者的财产。

8.4 静电放电警告



静电放电 (ESD) 会损坏这个集成电路。德州仪器 (TI) 建议通过适当的预防措施处理所有集成电路。如果不遵守正确的处理和安装程序，可能会损坏集成电路。

ESD 的损坏小至导致微小的性能降级，大至整个器件故障。精密的集成电路可能更容易受到损坏，这是因为非常细微的参数更改都可能会导致器件与其发布的规格不相符。

8.5 术语表

[TI 术语表](#) 本术语表列出并解释了术语、首字母缩略词和定义。

9 Mechanical, Packaging, and Orderable Information

The following pages include mechanical, packaging, and orderable information. This information is the most current data available for the designated devices. This data is subject to change without notice and revision of this document. For browser-based versions of this data sheet, refer to the left-hand navigation.

PACKAGING INFORMATION

Orderable Device	Status (1)	Package Type	Package Drawing	Pins	Package Qty	Eco Plan (2)	Lead finish/ Ball material (6)	MSL Peak Temp (3)	Op Temp (°C)	Device Marking (4/5)	Samples
SN65LBC179AD	LIFEBUY	SOIC	D	8	75	RoHS & Green	NIPDAU	Level-1-260C-UNLIM	-40 to 85	BL179A	
SN65LBC179ADG4	LIFEBUY	SOIC	D	8	75	RoHS & Green	NIPDAU	Level-1-260C-UNLIM	-40 to 85	BL179A	
SN65LBC179ADR	ACTIVE	SOIC	D	8	2500	RoHS & Green	NIPDAU	Level-1-260C-UNLIM	-40 to 85	BL179A	Samples
SN65LBC179ADRG4	ACTIVE	SOIC	D	8	2500	RoHS & Green	NIPDAU	Level-1-260C-UNLIM	-40 to 85	BL179A	Samples
SN65LBC179AP	ACTIVE	PDIP	P	8	50	RoHS & Green	NIPDAU	N / A for Pkg Type	-40 to 85	65LBC179A	Samples
SN75LBC179AD	LIFEBUY	SOIC	D	8	75	RoHS & Green	NIPDAU	Level-1-260C-UNLIM	0 to 70	LB179A	
SN75LBC179ADG4	LIFEBUY	SOIC	D	8	75	RoHS & Green	NIPDAU	Level-1-260C-UNLIM	0 to 70	LB179A	
SN75LBC179ADR	LIFEBUY	SOIC	D	8	2500	RoHS & Green	NIPDAU	Level-1-260C-UNLIM	0 to 70	LB179A	
SN75LBC179AP	ACTIVE	PDIP	P	8	50	RoHS & Green	NIPDAU	N / A for Pkg Type	0 to 70	75LBC179A	Samples

(1) The marketing status values are defined as follows:

ACTIVE: Product device recommended for new designs.

LIFEBUY: TI has announced that the device will be discontinued, and a lifetime-buy period is in effect.

NRND: Not recommended for new designs. Device is in production to support existing customers, but TI does not recommend using this part in a new design.

PREVIEW: Device has been announced but is not in production. Samples may or may not be available.

OBSOLETE: TI has discontinued the production of the device.

(2) **RoHS:** TI defines "RoHS" to mean semiconductor products that are compliant with the current EU RoHS requirements for all 10 RoHS substances, including the requirement that RoHS substance do not exceed 0.1% by weight in homogeneous materials. Where designed to be soldered at high temperatures, "RoHS" products are suitable for use in specified lead-free processes. TI may reference these types of products as "Pb-Free".

RoHS Exempt: TI defines "RoHS Exempt" to mean products that contain lead but are compliant with EU RoHS pursuant to a specific EU RoHS exemption.

Green: TI defines "Green" to mean the content of Chlorine (Cl) and Bromine (Br) based flame retardants meet JS709B low halogen requirements of <=1000ppm threshold. Antimony trioxide based flame retardants must also meet the <=1000ppm threshold requirement.

(3) MSL, Peak Temp. - The Moisture Sensitivity Level rating according to the JEDEC industry standard classifications, and peak solder temperature.

(4) There may be additional marking, which relates to the logo, the lot trace code information, or the environmental category on the device.

(5) Multiple Device Markings will be inside parentheses. Only one Device Marking contained in parentheses and separated by a "-" will appear on a device. If a line is indented then it is a continuation of the previous line and the two combined represent the entire Device Marking for that device.

⁽⁶⁾ Lead finish/Ball material - Orderable Devices may have multiple material finish options. Finish options are separated by a vertical ruled line. Lead finish/Ball material values may wrap to two lines if the finish value exceeds the maximum column width.

Important Information and Disclaimer:The information provided on this page represents TI's knowledge and belief as of the date that it is provided. TI bases its knowledge and belief on information provided by third parties, and makes no representation or warranty as to the accuracy of such information. Efforts are underway to better integrate information from third parties. TI has taken and continues to take reasonable steps to provide representative and accurate information but may not have conducted destructive testing or chemical analysis on incoming materials and chemicals. TI and TI suppliers consider certain information to be proprietary, and thus CAS numbers and other limited information may not be available for release.

In no event shall TI's liability arising out of such information exceed the total purchase price of the TI part(s) at issue in this document sold by TI to Customer on an annual basis.

TAPE AND REEL INFORMATION

QUADRANT ASSIGNMENTS FOR PIN 1 ORIENTATION IN TAPE

*All dimensions are nominal

Device	Package Type	Package Drawing	Pins	SPQ	Reel Diameter (mm)	Reel Width W1 (mm)	A0 (mm)	B0 (mm)	K0 (mm)	P1 (mm)	W (mm)	Pin1 Quadrant
SN65LBC179ADR	SOIC	D	8	2500	330.0	12.4	6.4	5.2	2.1	8.0	12.0	Q1
SN75LBC179ADR	SOIC	D	8	2500	330.0	12.4	6.4	5.2	2.1	8.0	12.0	Q1

TAPE AND REEL BOX DIMENSIONS

*All dimensions are nominal

Device	Package Type	Package Drawing	Pins	SPQ	Length (mm)	Width (mm)	Height (mm)
SN65LBC179ADR	SOIC	D	8	2500	340.5	336.1	25.0
SN75LBC179ADR	SOIC	D	8	2500	340.5	336.1	25.0

TUBE

*All dimensions are nominal

Device	Package Name	Package Type	Pins	SPQ	L (mm)	W (mm)	T (μm)	B (mm)
SN65LBC179AD	D	SOIC	8	75	507	8	3940	4.32
SN65LBC179ADG4	D	SOIC	8	75	507	8	3940	4.32
SN65LBC179AP	P	PDIP	8	50	506	13.97	11230	4.32
SN75LBC179AD	D	SOIC	8	75	507	8	3940	4.32
SN75LBC179ADG4	D	SOIC	8	75	507	8	3940	4.32
SN75LBC179AP	P	PDIP	8	50	506	13.97	11230	4.32



D0008A

PACKAGE OUTLINE

SOIC - 1.75 mm max height

SMALL OUTLINE INTEGRATED CIRCUIT



4214825/C 02/2019

NOTES:

- Linear dimensions are in inches [millimeters]. Dimensions in parenthesis are for reference only. Controlling dimensions are in inches. Dimensioning and tolerancing per ASME Y14.5M.
- This drawing is subject to change without notice.
- This dimension does not include mold flash, protrusions, or gate burrs. Mold flash, protrusions, or gate burrs shall not exceed .006 [0.15] per side.
- This dimension does not include interlead flash.
- Reference JEDEC registration MS-012, variation AA.

EXAMPLE BOARD LAYOUT

D0008A

SOIC - 1.75 mm max height

SMALL OUTLINE INTEGRATED CIRCUIT



LAND PATTERN EXAMPLE
EXPOSED METAL SHOWN
SCALE:8X



SOLDER MASK DETAILS

4214825/C 02/2019

NOTES: (continued)

6. Publication IPC-7351 may have alternate designs.

7. Solder mask tolerances between and around signal pads can vary based on board fabrication site.

EXAMPLE STENCIL DESIGN

D0008A

SOIC - 1.75 mm max height

SMALL OUTLINE INTEGRATED CIRCUIT



SOLDER PASTE EXAMPLE
BASED ON .005 INCH [0.125 MM] THICK STENCIL
SCALE:8X

4214825/C 02/2019

NOTES: (continued)

8. Laser cutting apertures with trapezoidal walls and rounded corners may offer better paste release. IPC-7525 may have alternate design recommendations.
9. Board assembly site may have different recommendations for stencil design.

P (R-PDIP-T8)

PLASTIC DUAL-IN-LINE PACKAGE



- NOTES:
- A. All linear dimensions are in inches (millimeters).
 - B. This drawing is subject to change without notice.
 - C. Falls within JEDEC MS-001 variation BA.

重要声明和免责声明

TI“按原样”提供技术和可靠性数据（包括数据表）、设计资源（包括参考设计）、应用或其他设计建议、网络工具、安全信息和其他资源，不保证没有瑕疵且不做任何明示或暗示的担保，包括但不限于对适销性、某特定用途方面的适用性或不侵犯任何第三方知识产权的暗示担保。

这些资源可供使用 TI 产品进行设计的熟练开发人员使用。您将自行承担以下全部责任：(1) 针对您的应用选择合适的 TI 产品，(2) 设计、验证并测试您的应用，(3) 确保您的应用满足相应标准以及任何其他功能安全、信息安全、监管或其他要求。

这些资源如有变更，恕不另行通知。TI 授权您仅可将这些资源用于研发本资源所述的 TI 产品的应用。严禁对这些资源进行其他复制或展示。您无权使用任何其他 TI 知识产权或任何第三方知识产权。您应全额赔偿因在这些资源的使用中对 TI 及其代表造成的任何索赔、损害、成本、损失和债务，TI 对此概不负责。

TI 提供的产品受 [TI 的销售条款](#) 或 [ti.com](#) 上其他适用条款/TI 产品随附的其他适用条款的约束。TI 提供这些资源并不会扩展或以其他方式更改 TI 针对 TI 产品发布的适用的担保或担保免责声明。

TI 反对并拒绝您可能提出的任何其他或不同的条款。

邮寄地址：Texas Instruments, Post Office Box 655303, Dallas, Texas 75265

Copyright © 2023，德州仪器 (TI) 公司