

DRV5033-Q1 汽车类 数字全极开关霍尔效应传感器

1 特性

- 数字全极开关霍尔传感器
- 符合汽车类应用的 AEC-Q100 标准
 - 1 级: $T_A = -40$ 至 125°C (Q, 请参见图 23)
 - 0 级: $T_A = -40$ 至 150°C (E, 请参见图 23)
- 出色的温度稳定性
 - 在温度范围内 $B_{OP} \pm 10\%$
- 多种灵敏度选项 (B_{OP}/B_{RP}):
 - $\pm 3.5/\pm 2\text{mT}$ (FA, 请参见图 23)
 - $\pm 6.9/\pm 3.5\text{mT}$ (AJ, 请参见图 23)
- 检测南北磁场
- 支持宽电压范围
 - 2.7V 至 38V
 - 无需外部稳压器
- 开漏输出 (30mA 灌电流)
- 35 μs 快速上电时间
- 小型封装尺寸
 - 表面贴装 3 引脚小外形尺寸晶体管 (SOT)-23 (DBZ)
 - 2.92mm x 2.37mm
 - 插入式 3 引脚 TO-92 (LPG)
 - 4.00mm x 3.15mm
- 保护特性
 - 反向电源保护 (高达 -22V)
 - 支持高达 40V 抛负载
 - 输出短路保护
 - 输出电流限制
 - 电池输出短路保护

2 应用

- 对接检测
- 门开关检测
- 接近感测
- 阀定位
- 脉冲计数

3 说明

DRV5033-Q1 器件是一款斩波稳定霍尔效应传感器，能够在整个温度范围内提供具有出色灵敏度稳定性和集成保护特性的磁场感测功能。

DRV5033-Q1 对磁场两极方向的响应相同。当应用的磁通量密度超过 B_{OP} 阈值时，DRV5033-Q1 开漏输出变为低电平。输出将保持低电平，直到磁通量密度降至 B_{RP} 以下之后变为高阻抗。输出灌电流能力为 30mA。反向极性保护高达 -22V 的宽工作电压范围 (2.7 至 38V) 使得此器件广泛适用于各种汽车信号。

该器件提供针对反向电源情况、负载突降以及输出短路或过流故障的内部保护功能。

器件信息⁽¹⁾

器件型号	封装	封装尺寸 (标称值)
DRV5033-Q1	SOT-23 (3)	2.92mm x 1.30mm
	TO-92 (3)	4.00mm x 3.15mm

(1) 要了解所有可用封装，请见数据表末尾的可订购产品附录。

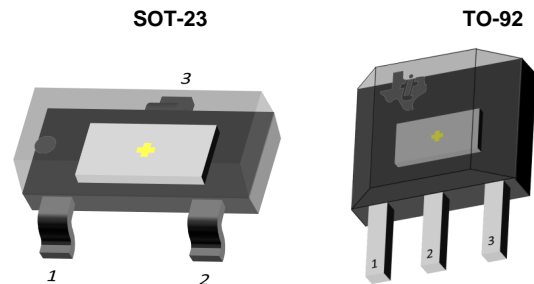
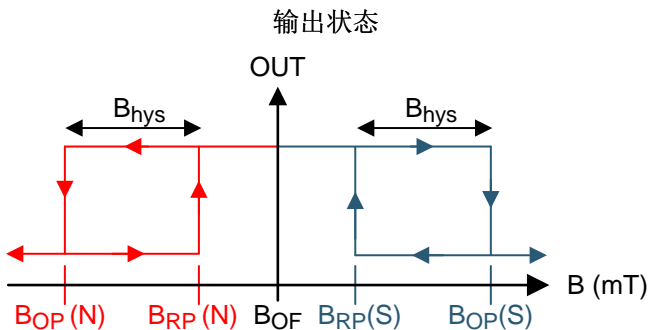

目录

1 特性	1	7.1 Overview	8
2 应用	1	7.2 Functional Block Diagram	8
3 说明	1	7.3 Feature Description	9
4 修订历史记录	2	7.4 Device Functional Modes	14
5 Pin Configuration and Functions	3	8 Application and Implementation	15
6 Specifications	4	8.1 Application Information	15
6.1 Absolute Maximum Ratings	4	8.2 Typical Applications	15
6.2 ESD Ratings	4	9 Power Supply Recommendations	17
6.3 Recommended Operating Conditions	4	10 器件和文档支持	18
6.4 Thermal Information	4	10.1 器件支持	18
6.5 Electrical Characteristics	5	10.2 社区资源	19
6.6 Switching Characteristics	5	10.3 商标	19
6.7 Magnetic Characteristics	5	10.4 静电放电警告	19
6.8 Typical Characteristics	6	10.5 Glossary	19
7 Detailed Description	8	11 机械、封装和可订购信息	19

4 修订历史记录

注：之前版本的页码可能与当前版本有所不同。

Changes from Revision D (May 2016) to Revision E Page

- Made changes to the Power-on time in the [Electrical Characteristics](#) table 5

Changes from Revision C (February 2016) to Revision D Page

- Revised preliminary limits for the FA version 5

Changes from Revision B (December 2015) to Revision C Page

- 已添加 FA 器件选项 1
- Added the typical bandwidth value to the [Magnetic Characteristics](#) table 5

Changes from Revision A (May 2015) to Revision B Page

- 已更正 SOT-23 封装体尺寸并将 SIP 封装名称更正为 TO-92 1
- Added B_{MAX} to [Absolute Maximum Ratings](#) 4
- Removed table notes regarding testing for the operating junction temperature in [Absolute Maximum Ratings](#) 4
- 已更新封装卷带选项 M 和空白 18
- 已添加 [社区资源](#) 19

Changes from Original (December 2014) to Revision A Page

- 已将器件状态更新为量产数据 1

5 Pin Configuration and Functions

For additional configuration information, see [器件标记](#) and [机械、封装和可订购信息](#).

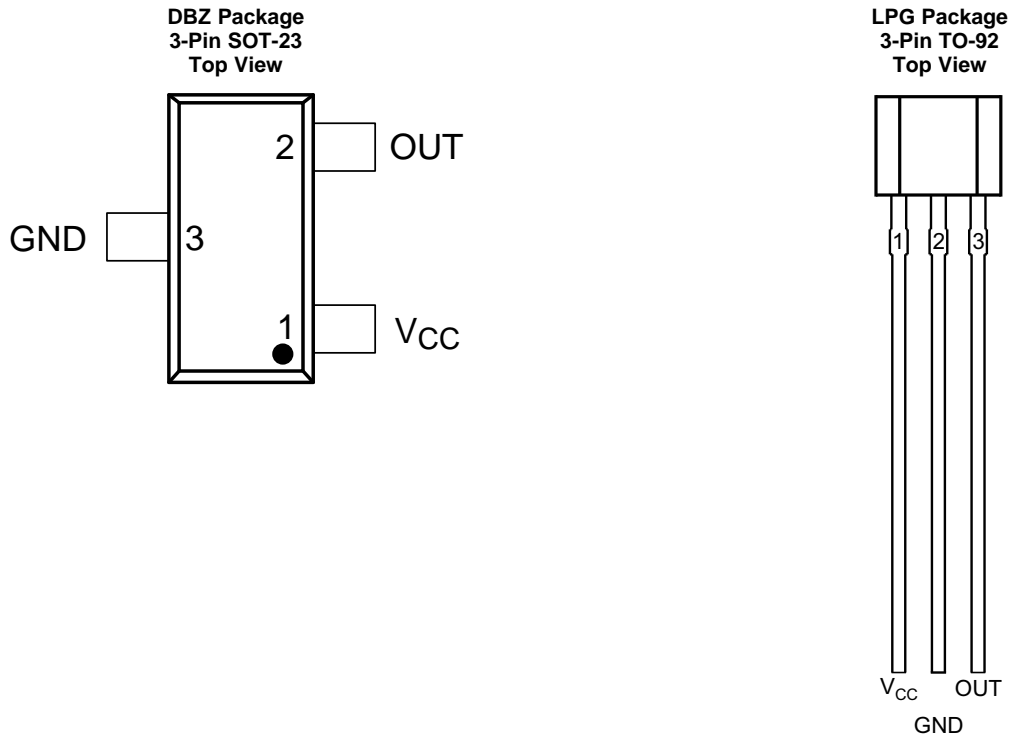

Pin Functions

PIN			TYPE	DESCRIPTION
NAME	DBZ	LPG		
GND	3	2	GND	Ground pin
OUT	2	3	Output	Hall sensor open-drain output. The open drain requires a resistor pullup.
V _{CC}	1	1	PWR	2.7 to 38 V power supply. Bypass this pin to the GND pin with a 0.01-μF (minimum) ceramic capacitor rated for V _{CC} .

6 Specifications

6.1 Absolute Maximum Ratings

 over operating free-air temperature range (unless otherwise noted) ⁽¹⁾

		MIN	MAX	UNIT
Power supply voltage	V _{CC}	-22 ⁽²⁾	40	V
	Voltage ramp rate (V _{CC}), V _{CC} < 5 V	Unlimited		V/μs
	Voltage ramp rate (V _{CC}), V _{CC} > 5 V	0	2	
Output pin voltage		-0.5	40	V
Output pin reverse current during reverse supply condition		0	100	mA
Magnetic flux density, B _{MAX}		Unlimited		
Operating junction temperature, T _J	Q, see 图 23	-40	150	°C
	E, see 图 23	-40	17	
Storage temperature, T _{stg}		-65	150	°C

- (1) Stresses beyond those listed under *Absolute Maximum Ratings* may cause permanent damage to the device. These are stress ratings only, which do not imply functional operation of the device at these or any other conditions beyond those indicated under *Recommended Operating Conditions*. Exposure to absolute-maximum-rated conditions for extended periods may affect device reliability.
- (2) Ensured by design. Only tested to -20 V.

6.2 ESD Ratings

		VALUE	UNIT
V _(ESD) Electrostatic discharge	Human-body model (HBM), per AEC Q100-002 ⁽¹⁾	±2500	V
	Charged-device model (CDM), per AEC Q100-011	±500	

- (1) AEC Q100-002 indicates that HBM stressing shall be in accordance with the ANSI/ESDA/JEDEC JS-001 specification.

6.3 Recommended Operating Conditions

over operating free-air temperature range (unless otherwise noted)

		MIN	MAX	UNIT	
V _{CC}	Power supply voltage	2.7	38	V	
V _O	Output pin voltage (OUT)	0	38	V	
I _{SINK}	Output pin current sink (OUT) ⁽¹⁾	0	30	mA	
T _A	Operating ambient temperature	Q, see 图 23	-40	125	°C
		E, see 图 23	-40	150	

- (1) Power dissipation and thermal limits must be observed

6.4 Thermal Information

THERMAL METRIC ⁽¹⁾		DRV5033-Q1		UNIT
		DBZ (SOT-23)	LPG (TO-92)	
		3 PINS	3 PINS	
R _{θJA}	Junction-to-ambient thermal resistance	333.2	180	°C/W
R _{θJC(top)}	Junction-to-case (top) thermal resistance	99.9	98.6	°C/W
R _{θJB}	Junction-to-board thermal resistance	66.9	154.9	°C/W
ψ _{JT}	Junction-to-top characterization parameter	4.9	40	°C/W
ψ _{JB}	Junction-to-board characterization parameter	65.2	154.9	°C/W

- (1) For more information about traditional and new thermal metrics, see the *Semiconductor and IC Package Thermal Metrics* application report, [SPRA953](#).

6.5 Electrical Characteristics

over operating free-air temperature range (unless otherwise noted)

PARAMETER		TEST CONDITIONS	MIN	TYP	MAX	UNIT
POWER SUPPLIES (V_{CC})						
V _{CC}	V _{CC} operating voltage		2.7		38	V
I _{CC}	Operating supply current	V _{CC} = 2.7 to 38 V, T _A = 25°C		2.7		mA
		V _{CC} = 2.7 to 38 V, T _A = T _{A, MAX} ⁽¹⁾		3	3.6	
t _{on}	Power-on time	AJ version		35	50	μs
		FA version		35	70	
OPEN DRAIN OUTPUT (OUT)						
r _{DS(on)}	FET on-resistance	V _{CC} = 3.3 V, I _O = 10 mA, T _A = 25°C		22		Ω
		V _{CC} = 3.3 V, I _O = 10 mA, T _A = 125°C		36	50	
I _{lkg(off)}	Off-state leakage current	Output Hi-Z			1	μA
PROTECTION CIRCUITS						
V _{CCR}	Reverse supply voltage		-22			V
I _{OCP}	Overcurrent protection level	OUT shorted V _{CC}	15	30	45	mA

(1) T_{A, MAX} is 125°C for Q Grade 1 devices and 150°C for E Grade 0 devices (see [Figure 23](#))

6.6 Switching Characteristics

over operating free-air temperature range (unless otherwise noted)

PARAMETER		TEST CONDITIONS	MIN	TYP	MAX	UNIT
OPEN DRAIN OUTPUT (OUT)						
t _d	Output delay time	B = B _{RP} – 10 mT to B _{OP} + 10 mT in 1 μs		13	25	μs
t _r	Output rise time (10% to 90%)	R1 = 1 kΩ, C _O = 50 pF, V _{CC} = 3.3 V		200		ns
t _f	Output fall time (90% to 10%)	R1 = 1 kΩ, C _O = 50 pF, V _{CC} = 3.3 V		31		ns

6.7 Magnetic Characteristics

over operating free-air temperature range (unless otherwise noted)

PARAMETER		TEST CONDITIONS	MIN	TYP	MAX	UNIT ⁽¹⁾
f _{BW}	Bandwidth ⁽²⁾		20	30		kHz
DRV5033FA: ±3.5 / ±2 mT						
B _{OP}	Operate point; see Figure 12		±1.8	±3.5	±6.8	mT
B _{RP}	Release point; see Figure 12		±0.5	±2	±4.2	mT
B _{hys}	Hysteresis; B _{hys} = (B _{OP} – B _{RP}) ⁽³⁾			±1.5		mT
B _O	Magnetic offset; B _O = (B _{OP} + B _{RP}) / 2			±2.8		mT
DRV5033AJ: ±6.9 / ±3.5 mT						
B _{OP}	Operate point; see Figure 12		±3	±6.9	±12	mT
B _{RP}	Release point; see Figure 12		±1	±3.5	±5	mT
B _{hys}	Hysteresis; B _{hys} = (B _{OP} – B _{RP}) ⁽³⁾			3.4		mT
B _O	Magnetic offset; B _O = (B _{OP} + B _{RP}) / 2			5.2		mT

(1) 1 mT = 10 Gauss

(2) Bandwidth describes the fastest changing magnetic field that can be detected and translated to the output.

(3) |B_{OP}| is always greater than |B_{RP}|.

6.8 Typical Characteristics

$T_A > 125^\circ\text{C}$ data is valid for Grade 0 devices only (E, see [Figure 23](#))

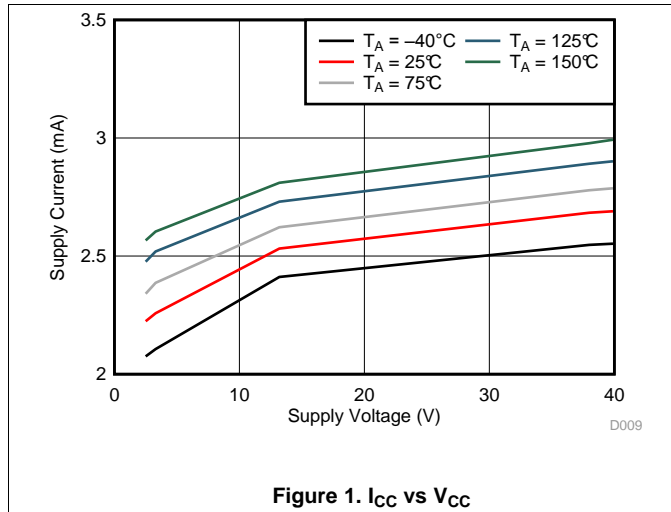

Figure 1. I_{CC} vs V_{CC}

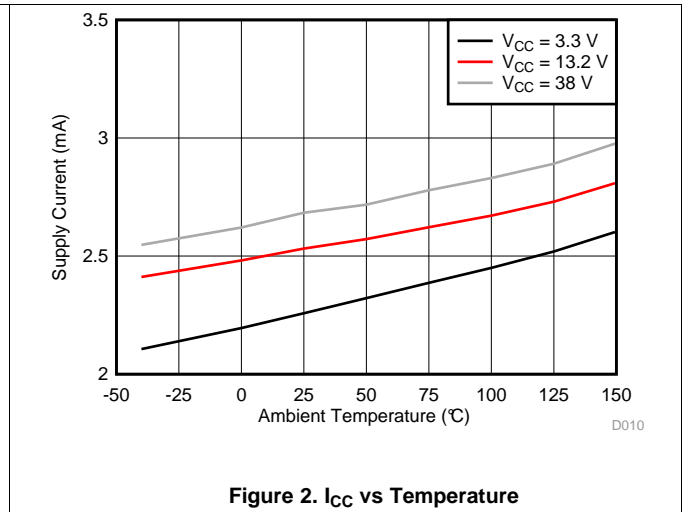

Figure 2. I_{CC} vs Temperature

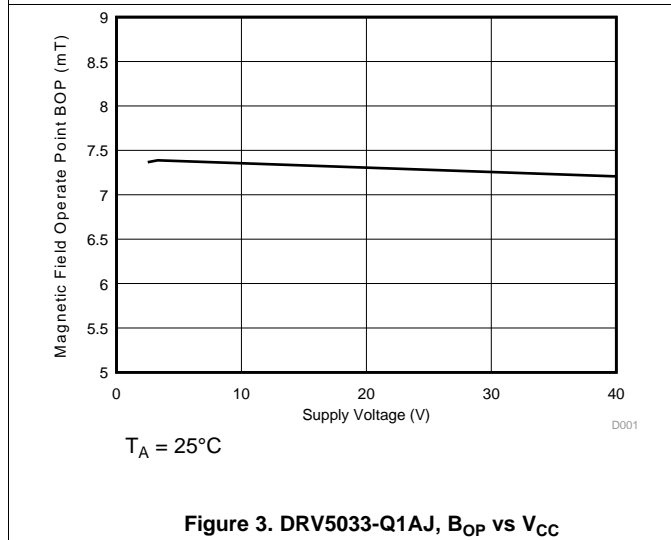

Figure 3. DRV5033-Q1AJ, B_{OP} vs V_{CC}

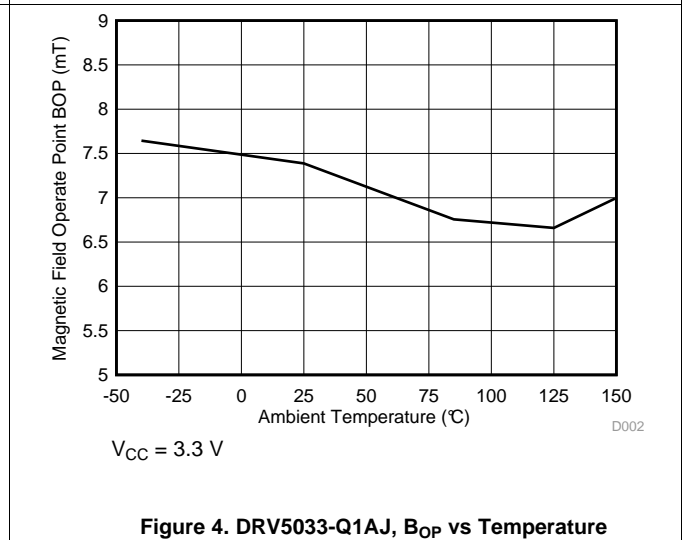

Figure 4. DRV5033-Q1AJ, B_{OP} vs Temperature

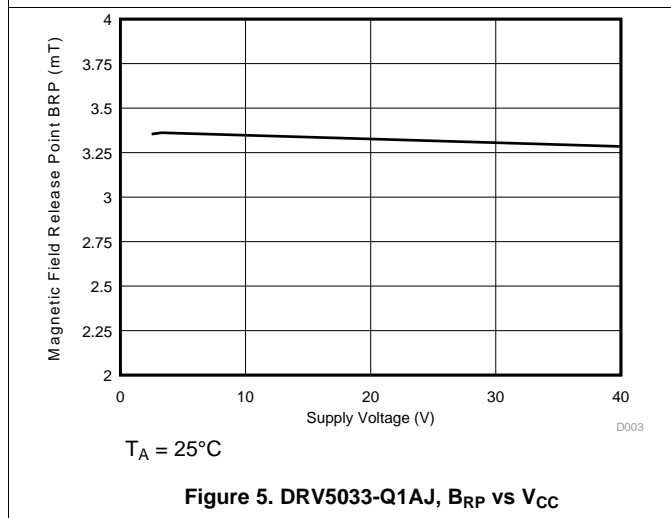

Figure 5. DRV5033-Q1AJ, B_{RP} vs V_{CC}

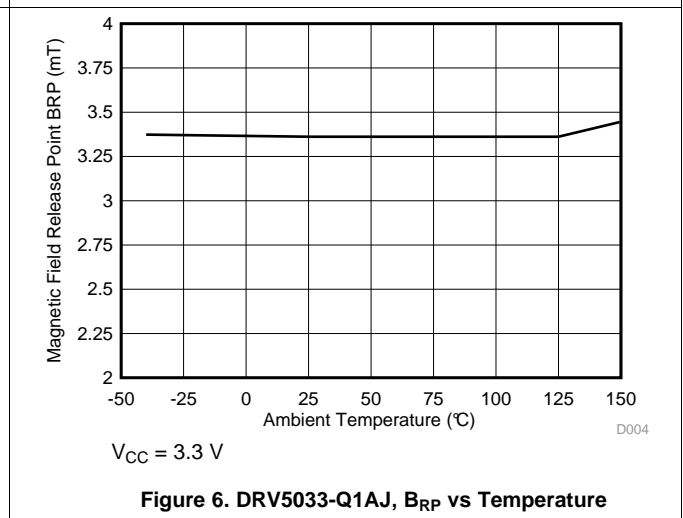
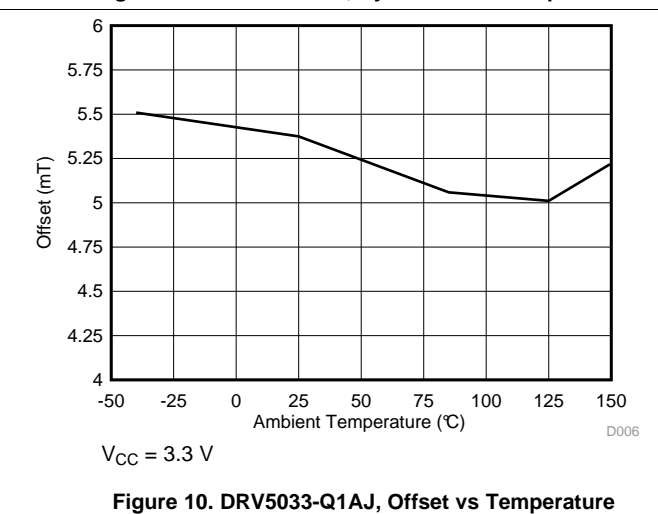
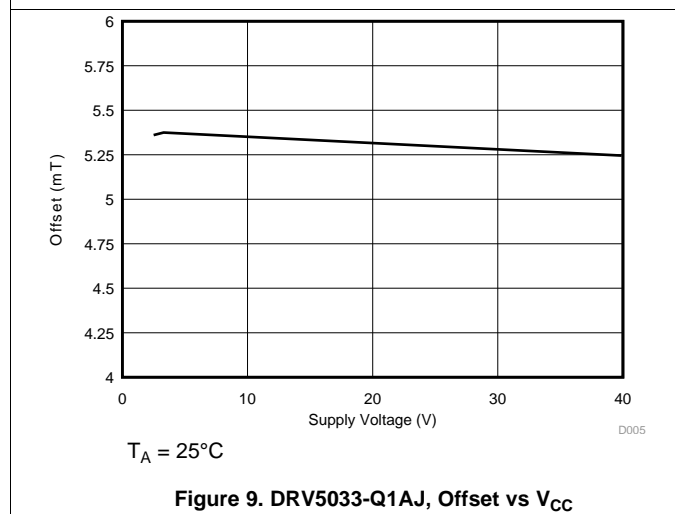
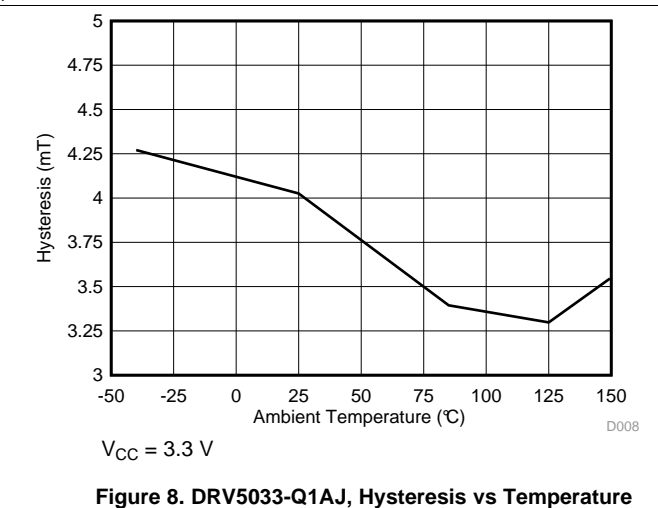
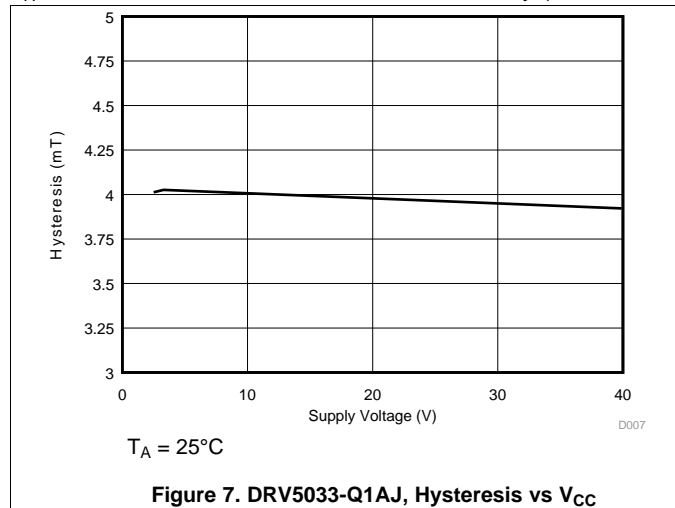

Figure 6. DRV5033-Q1AJ, B_{RP} vs Temperature

Typical Characteristics (continued)

$T_A > 125^\circ\text{C}$ data is valid for Grade 0 devices only (E, see [Figure 23](#))



7 Detailed Description

7.1 Overview

The DRV5033-Q1 device is a chopper-stabilized hall sensor with a digital omnipolar switch output for magnetic sensing applications. The DRV5033-Q1 device can be powered with a supply voltage between 2.7 and 38 V, and will survive -22 V reverse battery conditions continuously. Note that the DRV5033-Q1 device will not be operating when about -22 to 2.4 V is applied to V_{CC} (with respect to GND). In addition, the device can withstand voltages up to 40 V for transient durations.

The field polarity is defined as follows: a **south pole** near the marked side of the package is a **positive magnetic field**. A **north pole** near the marked side of the package is a **negative magnetic field**.

The omnipolar configuration allows the hall sensor to respond to either a south or north pole. A strong magnetic field of either polarity will cause the output to pull low (operate point, B_{OP}), and a weaker magnetic field will cause the output to release (release point, B_{RP}). Hysteresis is included in between the operate and release points, so magnetic field noise will not trip the output accidentally.

An external pullup resistor is required on the OUT pin. The OUT pin can be pulled up to V_{CC} , or to a different voltage supply. This allows for easier interfacing with controller circuits.

7.2 Functional Block Diagram

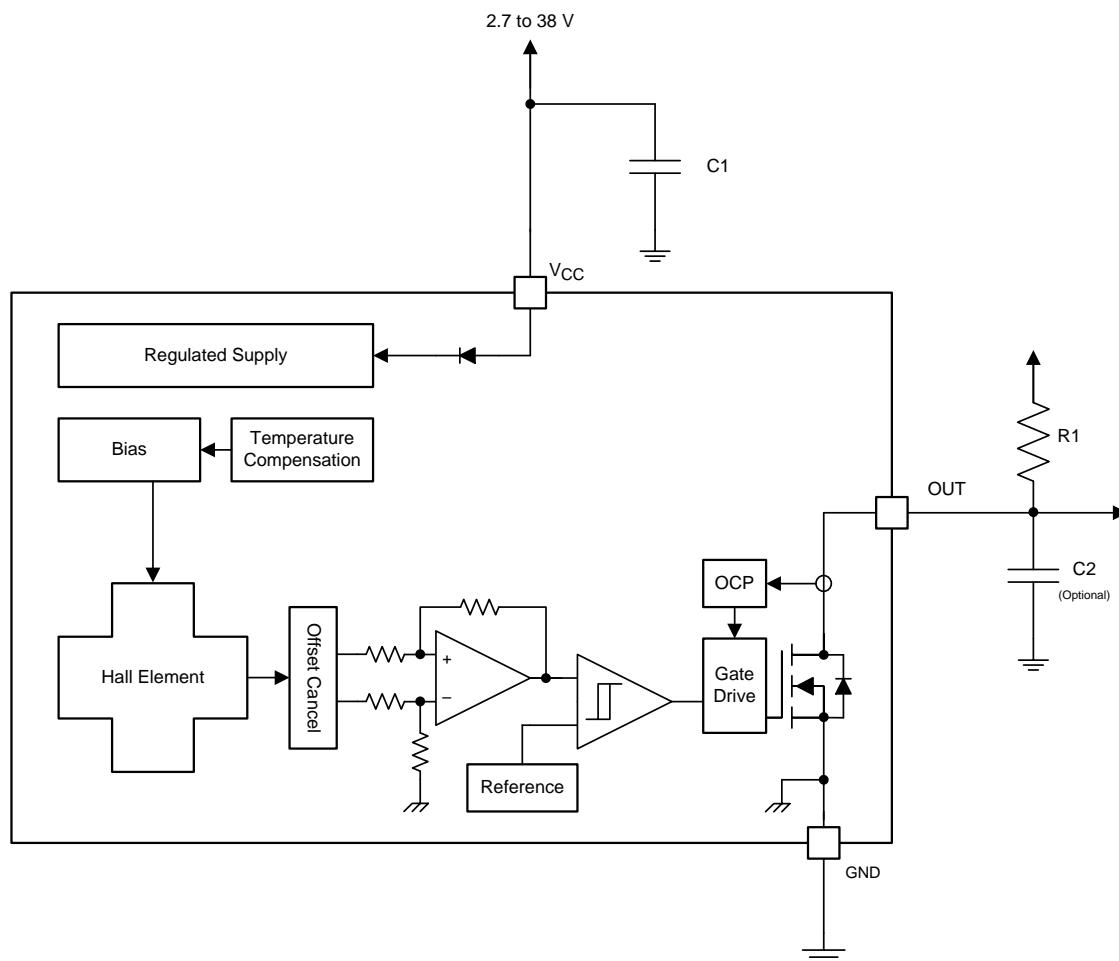

7.3 Feature Description

7.3.1 Field Direction Definition

A positive magnetic field is defined as a south pole near the marked side of the package as shown in Figure 11.

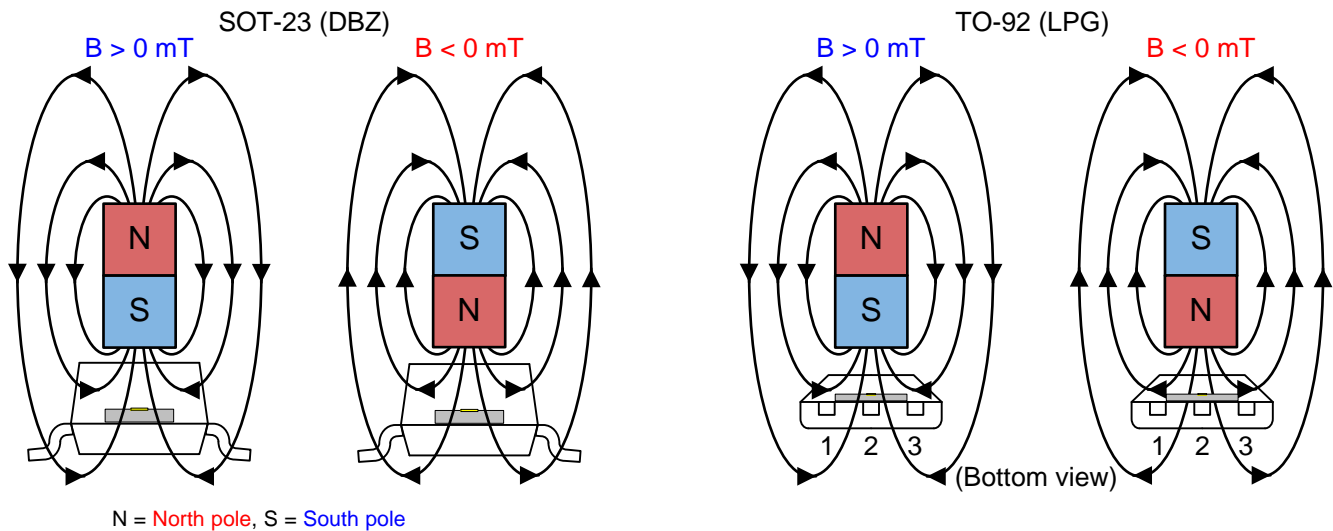

Figure 11. Field Direction Definition

7.3.2 Device Output

If the device is powered on with a magnetic field strength between B_{RP} and B_{OP} , then the device output is indeterminate and can either be Hi-Z or Low. If the field strength is greater than B_{OP} , then the output is pulled low. If the field strength is less than B_{RP} , then the output is released.

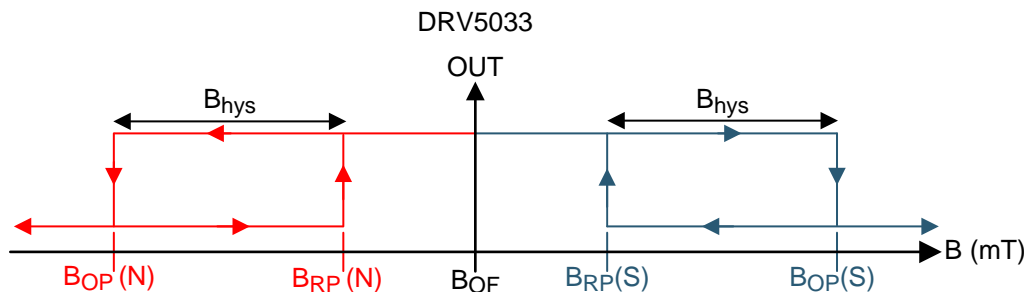
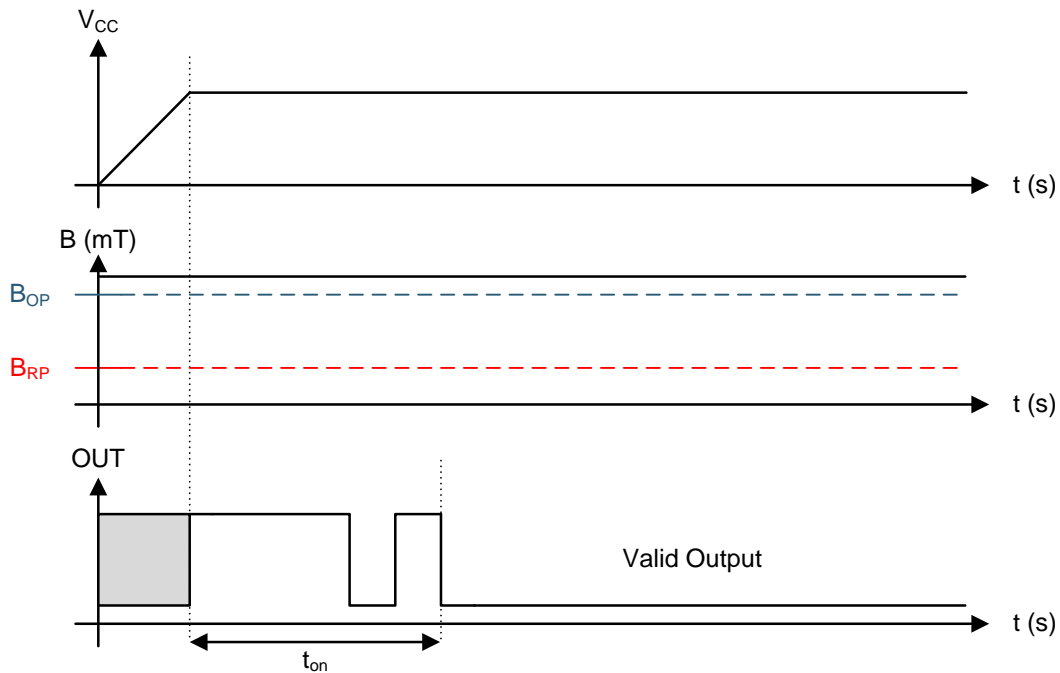
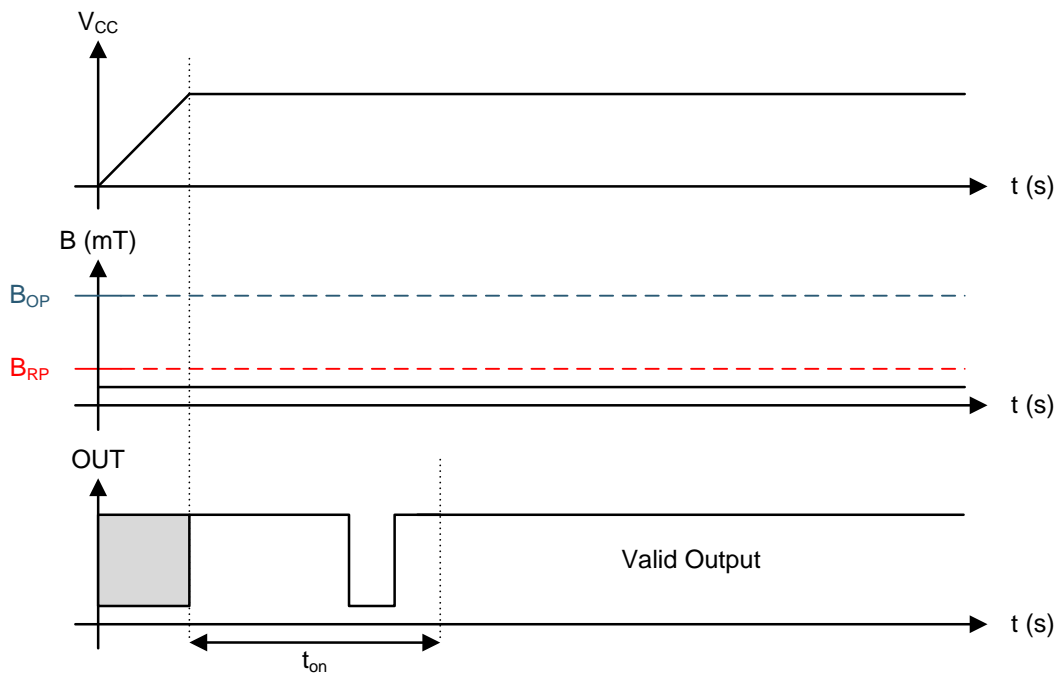

Figure 12. DRV5033-Q1— $B_{OP} > 0$

Feature Description (continued)
7.3.3 Power-On Time

After applying V_{CC} to the DRV5033-Q1 device, t_{on} must elapse before the OUT pin is valid. During the power-up sequence, the output is Hi-Z. A pulse as shown in Figure 13 and Figure 14 occurs at the end of t_{on} . This pulse can allow the host processor to determine when the DRV5033-Q1 output is valid after startup. In Case 1 (Figure 13) and Case 2 (Figure 14), the output is defined assuming a constant magnetic field $B > B_{OP}$ and $B < B_{RP}$.

Figure 13. Case 1: Power On When $B > B_{OP}$

Figure 14. Case 2: Power On When $B < B_{RP}$

Feature Description (continued)

If the device is powered on with the magnetic field strength $B_{RP} < B < B_{OP}$, then the device output is indeterminate and can either be Hi-Z or pulled low. During the power-up sequence, the output is held Hi-Z until t_{on} has elapsed. At the end of t_{on} , a pulse is given on the OUT pin to indicate that t_{on} has elapsed. After t_{on} , if the magnetic field changes such that $B_{OP} < B$, the output is released. Case 3 (Figure 15) and Case 4 (Figure 16) show examples of this behavior.

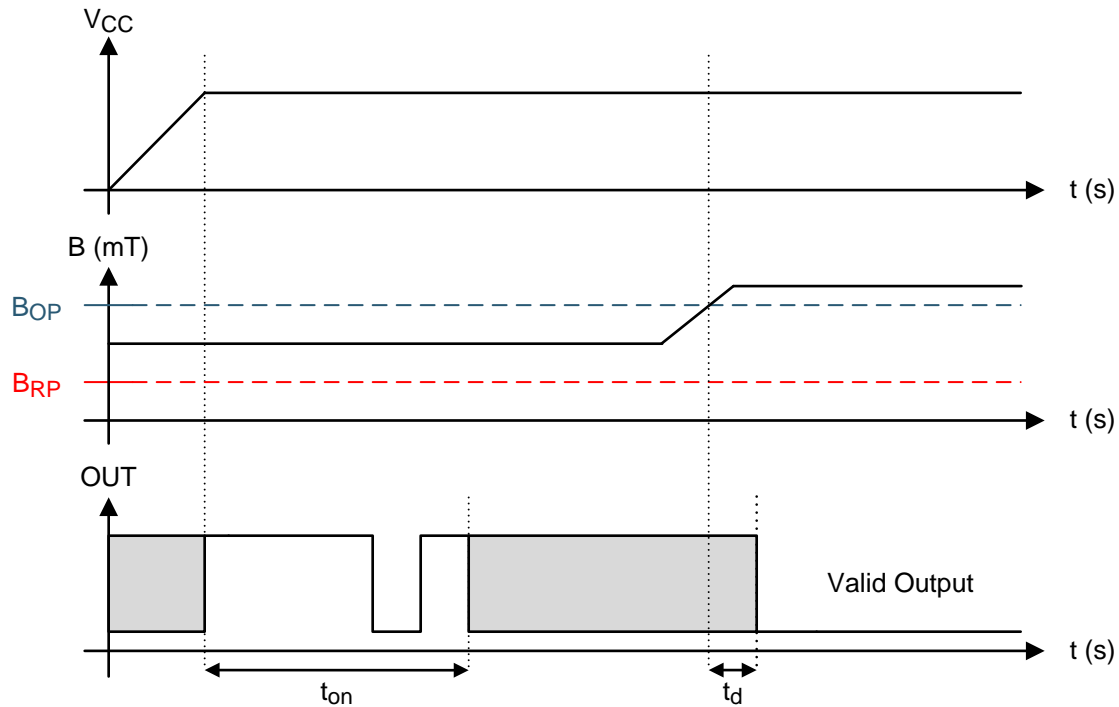

Figure 15. Case 3: Power On When $B_{RP} < B < B_{OP}$, Followed by $B > B_{OP}$

Feature Description (continued)

Figure 16. Case 4: Power On When $B_{RP} < B < B_{OP}$, Followed by $B < B_{RP}$

7.3.4 Output Stage

The DRV5033-Q1 output stage uses an open-drain NMOS, and it is rated to sink up to 30 mA of current. For proper operation, calculate the value of the pullup resistor R1 using [Equation 1](#).

$$\frac{V_{ref \max}}{30 \text{ mA}} \leq R1 \leq \frac{V_{ref \min}}{100 \mu\text{A}} \quad (1)$$

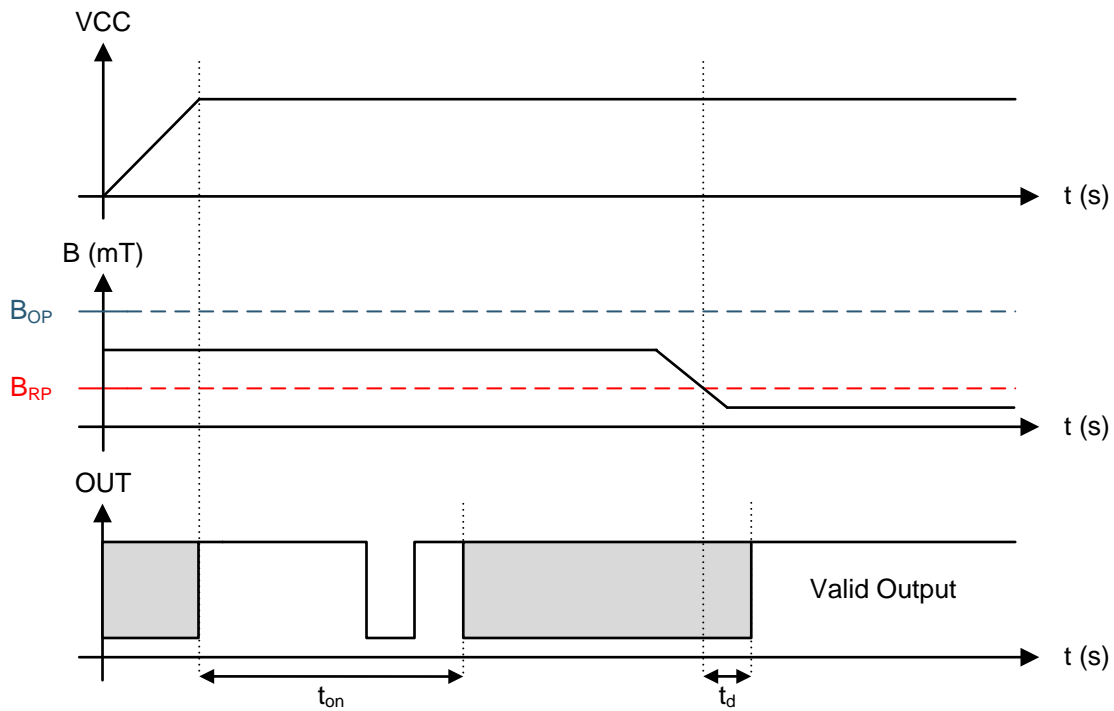
The size of R1 is a tradeoff between the OUT rise time and the current when OUT is pulled low. A lower current is generally better, however faster transitions and bandwidth require a smaller resistor for faster switching.

In addition, ensure that the value of $R1 > 500 \Omega$ to ensure the output driver can pull the OUT pin close to GND.

NOTE

V_{ref} is not restricted to V_{CC} . The allowable voltage range of this pin is specified in the [Absolute Maximum Ratings](#).

Feature Description (continued)

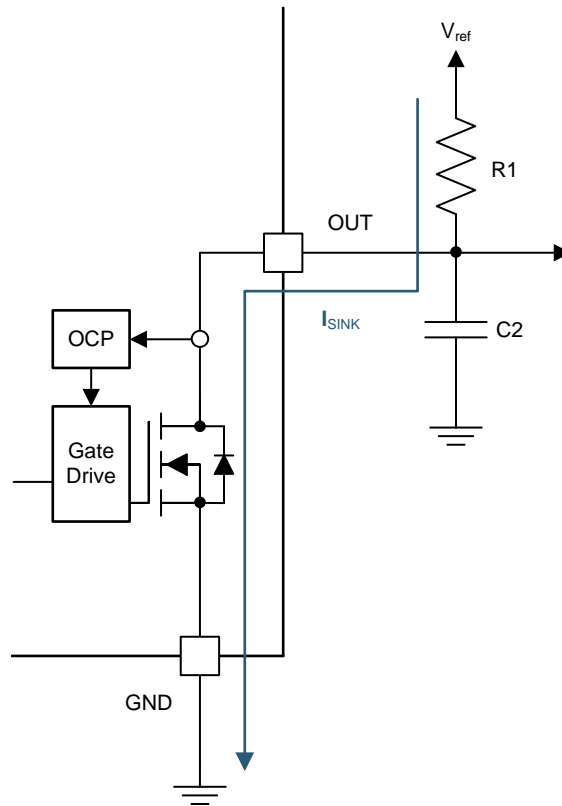

Figure 17.

Select a value for C2 based on the system bandwidth specifications as shown in [Equation 2](#).

$$2 \times f_{BW} \text{ (Hz)} < \frac{1}{2\pi \times R1 \times C2} \tag{2}$$

Most applications do not require this C2 filtering capacitor.

Feature Description (continued)

7.3.5 Protection Circuits

The DRV5033-Q1 device is fully protected against overcurrent and reverse-supply conditions.

7.3.5.1 Overcurrent Protection (OCP)

An analog current-limit circuit limits the current through the FET. The driver current is clamped to I_{OCP} . During this clamping, the $r_{DS(on)}$ of the output FET is increased from the nominal value.

7.3.5.2 Load Dump Protection

The DRV5033-Q1 device operates at DC V_{CC} conditions up to 38 V nominally, and can additionally withstand $V_{CC} = 40$ V. No current-limiting series resistor is required for this protection.

7.3.5.3 Reverse Supply Protection

The DRV5033-Q1 device is protected in the event that the V_{CC} pin and the GND pin are reversed (up to -22 V).

NOTE

In a reverse supply condition, the OUT pin reverse-current must not exceed the ratings specified in the [Absolute Maximum Ratings](#).

Table 1.

FAULT	CONDITION	DEVICE	DESCRIPTION	RECOVERY
FET overload (OCP)	$I_{SINK} \geq I_{OCP}$	Operating	Output current is clamped to I_{OCP}	$I_O < I_{OCP}$
Load dump	$38\text{ V} < V_{CC} < 40\text{ V}$	Operating	Device will operate for a transient duration	$V_{CC} \leq 38\text{ V}$
Reverse supply	$-22\text{ V} < V_{CC} < 0\text{ V}$	Disabled	Device will survive this condition	$V_{CC} \geq 2.7\text{ V}$

7.4 Device Functional Modes

The DRV5033-Q1 device is active only when V_{CC} is between 2.7 and 38 V.

When a reverse supply condition exists, the device is inactive.

8 Application and Implementation

NOTE

Information in the following applications sections is not part of the TI component specification, and TI does not warrant its accuracy or completeness. TI's customers are responsible for determining suitability of components for their purposes. Customers should validate and test their design implementation to confirm system functionality.

8.1 Application Information

The DRV5033-Q1 device is used in magnetic-field sensing applications.

8.2 Typical Applications

8.2.1 Standard Circuit

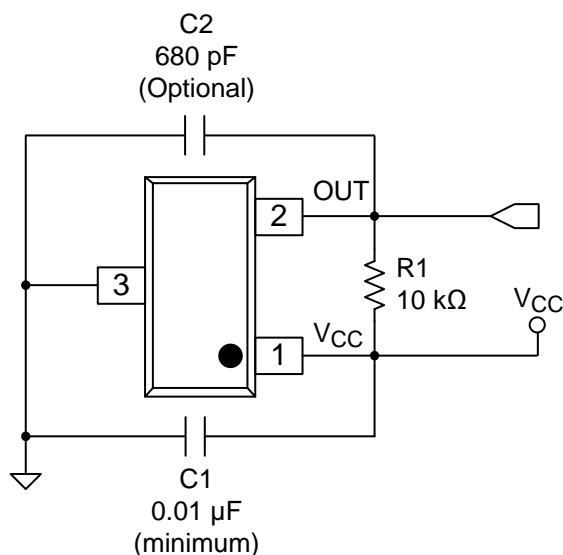

Figure 18. Typical Application Circuit

8.2.1.1 Design Requirements

For this design example, use the parameters listed in Table 2 as the input parameters.

Table 2. Design Parameters

DESIGN PARAMETER	REFERENCE	EXAMPLE VALUE
Supply voltage	V_{CC}	3.2 to 3.4 V
System bandwidth	f_{BW}	10 kHz

8.2.1.2 Detailed Design Procedure

Table 3. External Components

COMPONENT	PIN 1	PIN 2	RECOMMENDED
C1	V_{CC}	GND	A 0.01- μ F (minimum) ceramic capacitor rated for V_{CC}
C2	OUT	GND	Optional: Place a ceramic capacitor to GND
R1	OUT	REF ⁽¹⁾	Requires a resistor pullup

(1) REF is not a pin on the DRV5033-Q1 device, but a REF supply-voltage pullup is required for the OUT pin; the OUT pin may be pulled up to V_{CC} .

8.2.1.2.1 Configuration Example

In a 3.3-V system, $3.2\text{ V} \leq V_{\text{ref}} \leq 3.4\text{ V}$. Use Equation 3 to calculate the allowable range for R1.

$$\frac{V_{\text{ref max}}}{30\text{ mA}} \leq R1 \leq \frac{V_{\text{ref min}}}{100\text{ }\mu\text{A}} \tag{3}$$

For this design example, use Equation 4 to calculate the allowable range of R1.

$$\frac{3.4\text{ V}}{30\text{ mA}} \leq R1 \leq \frac{3.2\text{ V}}{100\text{ }\mu\text{A}} \tag{4}$$

Therefore:

$$113\text{ }\Omega \leq R1 \leq 32\text{ k}\Omega \tag{5}$$

After finding the allowable range of R1 (Equation 5), select a value between 500 Ω and 32 k Ω for R1.

Assuming a system bandwidth of 10 kHz, use Equation 6 to calculate the value of C2.

$$2 \times f_{\text{BW}}\text{ (Hz)} < \frac{1}{2\pi \times R1 \times C2} \tag{6}$$

For this design example, use Equation 7 to calculate the value of C2.

$$2 \times 10\text{ kHz} < \frac{1}{2\pi \times R1 \times C2} \tag{7}$$

An R1 value of 10 k Ω and a C2 value less than 820 pF satisfy the requirement for a 10-kHz system bandwidth.

A selection of R1 = 10 k Ω and C2 = 680 pF would cause a low-pass filter with a corner frequency of 23.4 kHz.

8.2.1.3 Application Curves

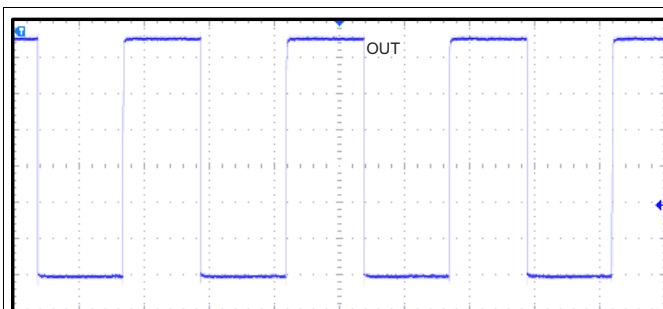

Figure 19. 10-kHz Switching Magnetic Field

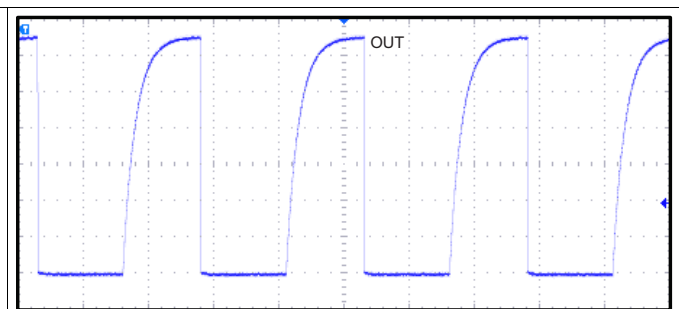

Figure 20. 10-kHz Switching Magnetic Field

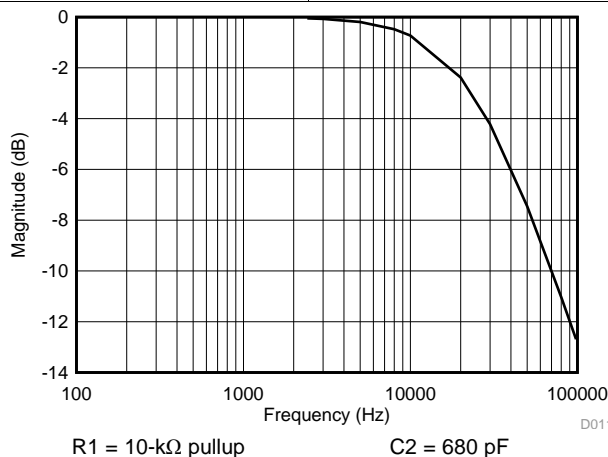

Figure 21. Low-Pass Filtering

8.2.2 Alternative Two-Wire Application

For systems that require minimal wire count, the device output can be connected to V_{CC} through a resistor, and the total supplied current can be sensed near the controller.

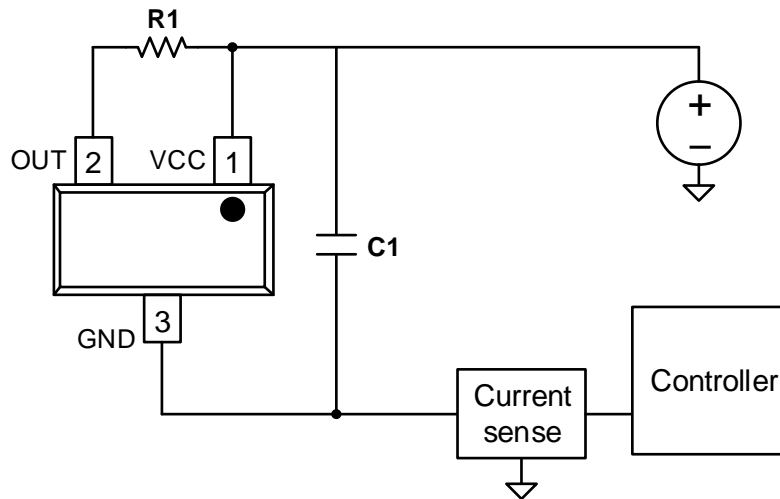

Figure 22. 2-Wire Application

Current can be sensed using a shunt resistor or other circuitry.

8.2.2.1 Design Requirements

Table 4 lists the related design parameters.

Table 4. Design Parameters

DESIGN PARAMETER	REFERENCE	EXAMPLE VALUE
Supply voltage	V_{CC}	12 V
OUT resistor	R1	1 k Ω
Bypass capacitor	C1	0.1 μ F
Current when $B < B_{RP}$	$I_{RELEASE}$	About 3 mA
Current when $B > B_{OP}$	$I_{OPERATE}$	About 15 mA

8.2.2.2 Detailed Design Procedure

When the open-drain output of the device is high-impedance, current through the path equals the I_{CC} of the device (approximately 3 mA).

When the output pulls low, a parallel current path is added, equal to $V_{CC} / (R1 + r_{DS(on)})$. Using 12 V and 1 k Ω , the parallel current is approximately 12 mA, making the total current approximately 15 mA.

The local bypass capacitor C1 should be at least 0.1 μ F, and a larger value if there is high inductance in the power line interconnect.

9 Power Supply Recommendations

The DRV5033-Q1 device is designed to operate from an input voltage supply (V_M) range between 2.7 and 38 V. A 0.01- μ F (minimum) ceramic capacitor rated for V_{CC} must be placed as close to the DRV5033-Q1 device as possible.

10 器件和文档支持

10.1 器件支持

10.1.1 器件命名规则

图 23 显示了读取 DRV5033-Q1 器件完整器件名称的图例。



图 23. 器件命名规则

10.1.2 器件标记



图 24. SOT-23 (DBZ) 封装

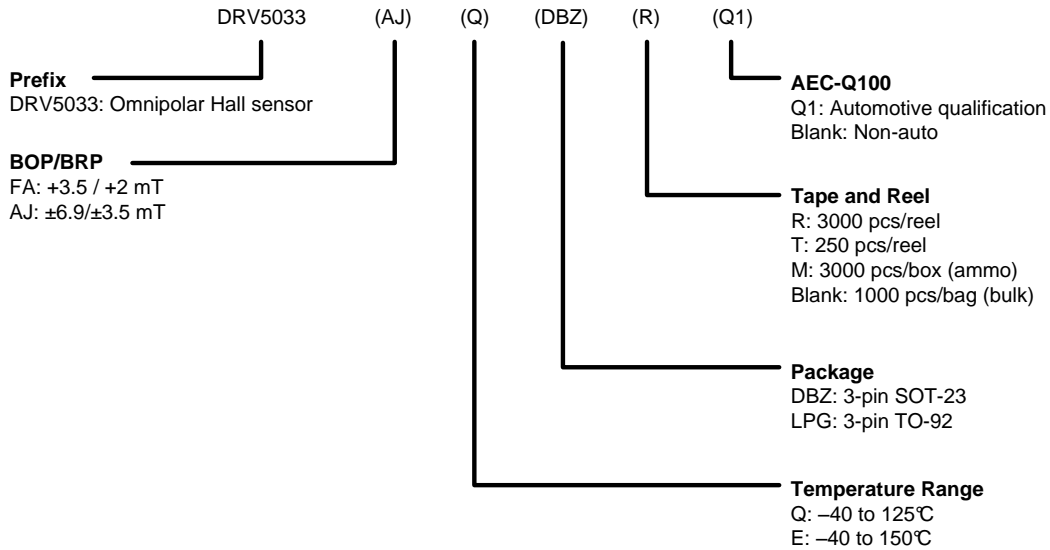

图 25. TO-92 (LPG) 封装

✚ 表示霍尔效应传感器（未按比例显示）。霍尔元件置于封装中央位置，容差为 ±100µm。在 DBZ 封装中，霍尔元件与封装底部的距离为 0.7mm ± 50µm；在 LPG 封装中，霍尔元件与封装底部的距离为 0.987mm ± 50µm。

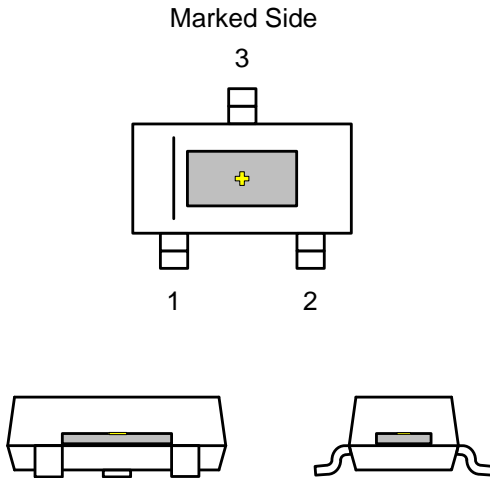
10.2 社区资源

The following links connect to TI community resources. Linked contents are provided "AS IS" by the respective contributors. They do not constitute TI specifications and do not necessarily reflect TI's views; see TI's [Terms of Use](#).

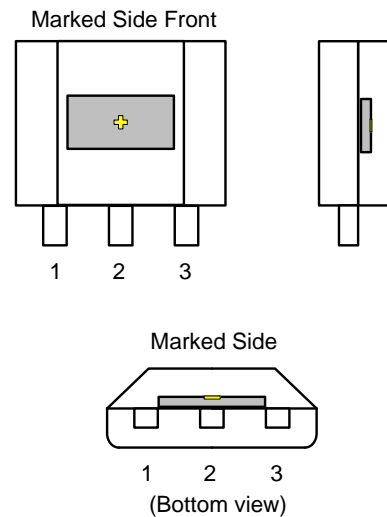
TI E2E™ Online Community *TI's Engineer-to-Engineer (E2E) Community*. Created to foster collaboration among engineers. At e2e.ti.com, you can ask questions, share knowledge, explore ideas and help solve problems with fellow engineers.

Design Support *TI's Design Support* Quickly find helpful E2E forums along with design support tools and contact information for technical support.

10.3 商标

E2E is a trademark of Texas Instruments.
All other trademarks are the property of their respective owners.

10.4 静电放电警告



这些装置包含有限的内置 ESD 保护。存储或装卸时，应将导线一起截短或将装置放置于导电泡棉中，以防止 MOS 门极遭受静电损伤。

10.5 Glossary

[SLYZ022](#) — *TI Glossary*.

This glossary lists and explains terms, acronyms, and definitions.

11 机械、封装和可订购信息

以下页中包括机械、封装和可订购信息。这些信息是针对指定器件可提供的最新数据。这些数据会在无通知且不对本文档进行修订的情况下发生改变。欲获得该数据表的浏览器版本，请查阅左侧的导航栏。

重要声明

德州仪器(TI)及其下属子公司有权根据 JESD46 最新标准,对所提供的产品和服务进行更正、修改、增强、改进或其它更改,并有权根据 JESD48 最新标准中止提供任何产品和服务。客户在下订单前应获取最新的相关信息,并验证这些信息是否完整且是最新的。所有产品的销售都遵循在订单确认时所提供的TI 销售条款与条件。

TI 保证其所销售的组件的性能符合产品销售时 TI 半导体产品销售条件与条款的适用规范。仅在 TI 保证的范围内,且 TI 认为有必要时才会使用测试或其它质量控制技术。除非适用法律做出了硬性规定,否则没有必要对每种组件的所有参数进行测试。

TI 对应用帮助或客户产品设计不承担任何义务。客户应对其使用 TI 组件的产品和应用自行负责。为尽量减小与客户产品和应用相关的风险,客户应提供充分的设计与操作安全措施。

TI 不对任何 TI 专利权、版权、屏蔽作品权或其它与使用了 TI 组件或服务的组合设备、机器或流程相关的 TI 知识产权中授予的直接或隐含权限作出任何保证或解释。TI 所发布的与第三方产品或服务有关的信息,不能构成从 TI 获得使用这些产品或服务的许可、授权、或认可。使用此类信息可能需要获得第三方的专利权或其它知识产权方面的许可,或是 TI 的专利权或其它知识产权方面的许可。

对于 TI 的产品手册或数据表中 TI 信息的重要部分,仅在没有对内容进行任何篡改且带有相关授权、条件、限制和声明的情况下才允许进行复制。TI 对此类篡改过的文件不承担任何责任或义务。复制第三方的信息可能需要服从额外的限制条件。

在转售 TI 组件或服务时,如果对该组件或服务参数的陈述与 TI 标明的参数相比存在差异或虚假成分,则会失去相关 TI 组件或服务的所有明示或暗示授权,且这是不正当的、欺诈性商业行为。TI 对任何此类虚假陈述均不承担任何责任或义务。

客户认可并同意,尽管任何应用相关信息或支持仍可能由 TI 提供,但他们将独立负责满足与其产品及其在应用中使用的 TI 产品相关的所有法律、法规和安全相关要求。客户声明并同意,他们具备制定与实施安全措施所需的全部专业技术和知识,可预见故障的危险后果、监测故障及其后果、降低有可能造成人身伤害的故障的发生机率并采取适当的补救措施。客户将全额赔偿因在此类安全关键应用中使用任何 TI 组件而对 TI 及其代理造成的任何损失。

在某些场合中,为了推进安全相关应用有可能对 TI 组件进行特别的促销。TI 的目标是利用此类组件帮助客户设计和创立其特有的可满足适用的功能安全性标准和要求的终端产品解决方案。尽管如此,此类组件仍然服从这些条款。

TI 组件未获得用于 FDA Class III (或类似的生命攸关医疗设备)的授权许可,除非各方授权官员已经达成了专门管控此类使用的特别协议。

只有那些 TI 特别注明属于军用等级或“增强型塑料”的 TI 组件才是设计或专门用于军事/航空应用或环境的。购买者认可并同意,对并非指定面向军事或航空航天用途的 TI 组件进行军事或航空航天方面的应用,其风险由客户单独承担,并且由客户独立负责满足与此类使用相关的所有法律和法规要求。

TI 已明确指定符合 ISO/TS16949 要求的产品,这些产品主要用于汽车。在任何情况下,因使用非指定产品而无法达到 ISO/TS16949 要求, TI 不承担任何责任。

	产品		应用
数字音频	www.ti.com.cn/audio	通信与电信	www.ti.com.cn/telecom
放大器和线性器件	www.ti.com.cn/amplifiers	计算机及周边	www.ti.com.cn/computer
数据转换器	www.ti.com.cn/dataconverters	消费电子	www.ti.com.cn/consumer-apps
DLP® 产品	www.dlp.com	能源	www.ti.com.cn/energy
DSP - 数字信号处理器	www.ti.com.cn/dsp	工业应用	www.ti.com.cn/industrial
时钟和计时器	www.ti.com.cn/clockandtimers	医疗电子	www.ti.com.cn/medical
接口	www.ti.com.cn/interface	安防应用	www.ti.com.cn/security
逻辑	www.ti.com.cn/logic	汽车电子	www.ti.com.cn/automotive
电源管理	www.ti.com.cn/power	视频和影像	www.ti.com.cn/video
微控制器 (MCU)	www.ti.com.cn/microcontrollers		
RFID 系统	www.ti.com.cn/rfidsys		
OMAP应用处理器	www.ti.com.cn/omap		
无线连通性	www.ti.com.cn/wirelessconnectivity	德州仪器在线技术支持社区	www.deyisupport.com

邮寄地址: 上海市浦东新区世纪大道1568号, 中建大厦32楼邮政编码: 200122
Copyright © 2016, 德州仪器半导体技术(上海)有限公司

PACKAGING INFORMATION

Orderable Device	Status (1)	Package Type	Package Drawing	Pins	Package Qty	Eco Plan (2)	Lead finish/ Ball material (6)	MSL Peak Temp (3)	Op Temp (°C)	Device Marking (4/5)	Samples
DRV5033AJEDBZRQ1	ACTIVE	SOT-23	DBZ	3	3000	RoHS & Green	NIPDAUAG	Level-1-260C-UNLIM	-40 to 150	+QJAJ	Samples
DRV5033AJEDBZTQ1	ACTIVE	SOT-23	DBZ	3	250	RoHS & Green	NIPDAUAG	Level-1-260C-UNLIM	-40 to 150	+QJAJ	Samples
DRV5033AJELPGMQ1	ACTIVE	TO-92	LPG	3	3000	RoHS & Green	SN	N / A for Pkg Type	-40 to 150	+QJAJ	Samples
DRV5033AJELPGQ1	ACTIVE	TO-92	LPG	3	1000	RoHS & Green	SN	N / A for Pkg Type	-40 to 150	+QJAJ	Samples
DRV5033AJQDBZRQ1	ACTIVE	SOT-23	DBZ	3	3000	RoHS & Green	NIPDAUAG	Level-1-260C-UNLIM	-40 to 125	+QKAJ	Samples
DRV5033AJQDBZTQ1	ACTIVE	SOT-23	DBZ	3	250	RoHS & Green	NIPDAUAG	Level-1-260C-UNLIM	-40 to 125	+QKAJ	Samples
DRV5033AJQLPGMQ1	ACTIVE	TO-92	LPG	3	3000	RoHS & Green	SN	N / A for Pkg Type	-40 to 125	+QKAJ	Samples
DRV5033AJQLPGQ1	ACTIVE	TO-92	LPG	3	1000	RoHS & Green	SN	N / A for Pkg Type	-40 to 125	+QKAJ	Samples
DRV5033FAEDBZRQ1	ACTIVE	SOT-23	DBZ	3	3000	RoHS & Green	SN	Level-1-260C-UNLIM	-40 to 150	+QJFA	Samples

(1) The marketing status values are defined as follows:

ACTIVE: Product device recommended for new designs.

LIFEBUY: TI has announced that the device will be discontinued, and a lifetime-buy period is in effect.

NRND: Not recommended for new designs. Device is in production to support existing customers, but TI does not recommend using this part in a new design.

PREVIEW: Device has been announced but is not in production. Samples may or may not be available.

OBSOLETE: TI has discontinued the production of the device.

(2) **RoHS:** TI defines "RoHS" to mean semiconductor products that are compliant with the current EU RoHS requirements for all 10 RoHS substances, including the requirement that RoHS substance do not exceed 0.1% by weight in homogeneous materials. Where designed to be soldered at high temperatures, "RoHS" products are suitable for use in specified lead-free processes. TI may reference these types of products as "Pb-Free".

RoHS Exempt: TI defines "RoHS Exempt" to mean products that contain lead but are compliant with EU RoHS pursuant to a specific EU RoHS exemption.

Green: TI defines "Green" to mean the content of Chlorine (Cl) and Bromine (Br) based flame retardants meet JS709B low halogen requirements of <=1000ppm threshold. Antimony trioxide based flame retardants must also meet the <=1000ppm threshold requirement.

(3) MSL, Peak Temp. - The Moisture Sensitivity Level rating according to the JEDEC industry standard classifications, and peak solder temperature.

(4) There may be additional marking, which relates to the logo, the lot trace code information, or the environmental category on the device.

⁽⁵⁾ Multiple Device Markings will be inside parentheses. Only one Device Marking contained in parentheses and separated by a "-" will appear on a device. If a line is indented then it is a continuation of the previous line and the two combined represent the entire Device Marking for that device.

⁽⁶⁾ Lead finish/Ball material - Orderable Devices may have multiple material finish options. Finish options are separated by a vertical ruled line. Lead finish/Ball material values may wrap to two lines if the finish value exceeds the maximum column width.

Important Information and Disclaimer:The information provided on this page represents TI's knowledge and belief as of the date that it is provided. TI bases its knowledge and belief on information provided by third parties, and makes no representation or warranty as to the accuracy of such information. Efforts are underway to better integrate information from third parties. TI has taken and continues to take reasonable steps to provide representative and accurate information but may not have conducted destructive testing or chemical analysis on incoming materials and chemicals. TI and TI suppliers consider certain information to be proprietary, and thus CAS numbers and other limited information may not be available for release.

In no event shall TI's liability arising out of such information exceed the total purchase price of the TI part(s) at issue in this document sold by TI to Customer on an annual basis.

TAPE AND REEL INFORMATION



QUADRANT ASSIGNMENTS FOR PIN 1 ORIENTATION IN TAPE



*All dimensions are nominal

Device	Package Type	Package Drawing	Pins	SPQ	Reel Diameter (mm)	Reel Width W1 (mm)	A0 (mm)	B0 (mm)	K0 (mm)	P1 (mm)	W (mm)	Pin1 Quadrant
DRV5033AJEDBZRQ1	SOT-23	DBZ	3	3000	180.0	8.4	3.15	2.77	1.22	4.0	8.0	Q3
DRV5033AJEDBZTQ1	SOT-23	DBZ	3	250	180.0	8.4	3.15	2.77	1.22	4.0	8.0	Q3
DRV5033AJQDBZRQ1	SOT-23	DBZ	3	3000	180.0	8.4	3.15	2.77	1.22	4.0	8.0	Q3
DRV5033AJQDBZTQ1	SOT-23	DBZ	3	250	180.0	8.4	3.15	2.77	1.22	4.0	8.0	Q3
DRV5033FAEDBZRQ1	SOT-23	DBZ	3	3000	180.0	8.4	3.15	2.77	1.22	4.0	8.0	Q3

TAPE AND REEL BOX DIMENSIONS

*All dimensions are nominal

Device	Package Type	Package Drawing	Pins	SPQ	Length (mm)	Width (mm)	Height (mm)
DRV5033AJEDBZRQ1	SOT-23	DBZ	3	3000	202.0	201.0	28.0
DRV5033AJEDBZTQ1	SOT-23	DBZ	3	250	202.0	201.0	28.0
DRV5033AJQDBZRQ1	SOT-23	DBZ	3	3000	202.0	201.0	28.0
DRV5033AJQDBZTQ1	SOT-23	DBZ	3	250	202.0	201.0	28.0
DRV5033FAEDBZRQ1	SOT-23	DBZ	3	3000	202.0	201.0	28.0

GENERIC PACKAGE VIEW

DBZ 3

SOT-23 - 1.12 mm max height

SMALL OUTLINE TRANSISTOR



Images above are just a representation of the package family, actual package may vary.
Refer to the product data sheet for package details.

4203227/C

EXAMPLE BOARD LAYOUT

DBZ0003A

SOT-23 - 1.12 mm max height

SMALL OUTLINE TRANSISTOR



LAND PATTERN EXAMPLE
SCALE:15X

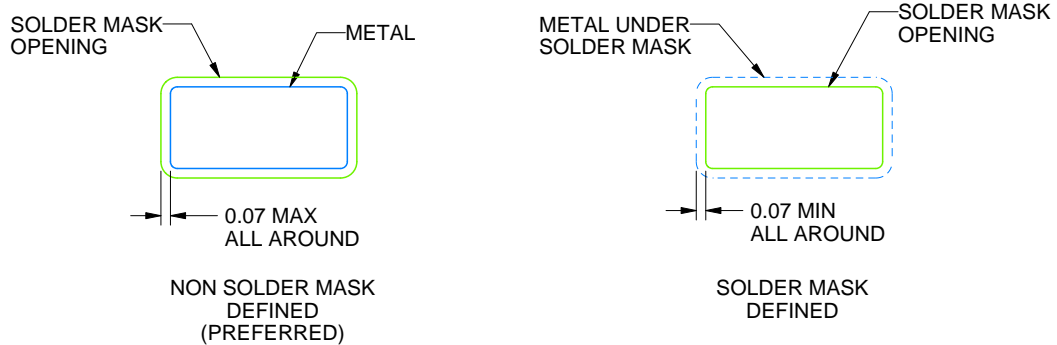

SOLDER MASK DETAILS

4214838/C 04/2017

NOTES: (continued)

4. Publication IPC-7351 may have alternate designs.
5. Solder mask tolerances between and around signal pads can vary based on board fabrication site.

EXAMPLE STENCIL DESIGN

DBZ0003A

SOT-23 - 1.12 mm max height

SMALL OUTLINE TRANSISTOR

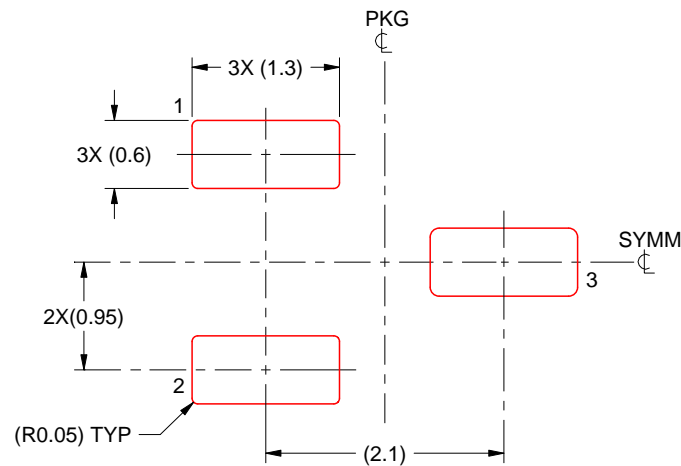

SOLDER PASTE EXAMPLE
BASED ON 0.125 THICK STENCIL
SCALE:15X

4214838/C 04/2017

NOTES: (continued)

6. Laser cutting apertures with trapezoidal walls and rounded corners may offer better paste release. IPC-7525 may have alternate design recommendations.
7. Board assembly site may have different recommendations for stencil design.

LPG0003A



PACKAGE OUTLINE

TO-92 - 5.05 mm max height

TRANSISTOR OUTLINE

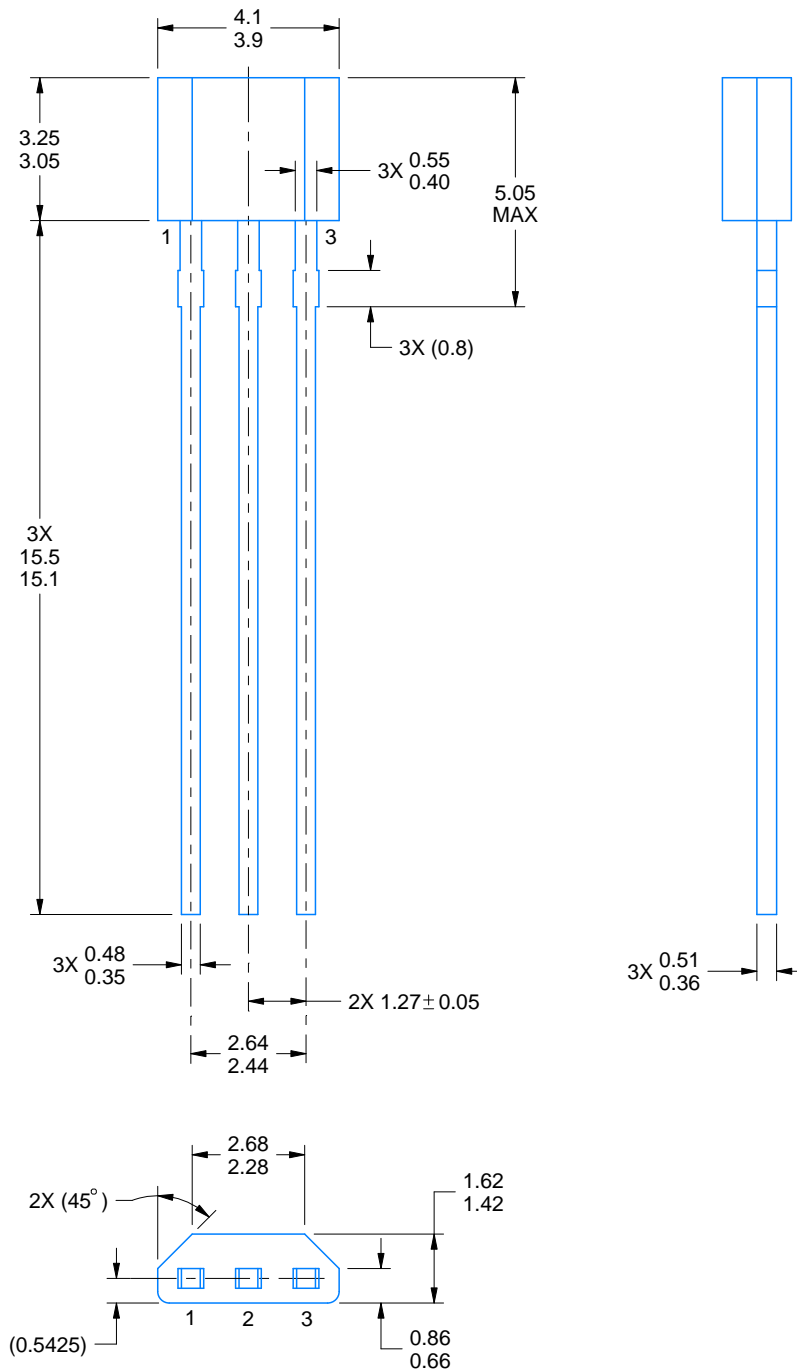

4221343/C 01/2018

NOTES:

1. All linear dimensions are in millimeters. Any dimensions in parenthesis are for reference only. Dimensioning and tolerancing per ASME Y14.5M.
2. This drawing is subject to change without notice.

EXAMPLE BOARD LAYOUT

LPG0003A

TO-92 - 5.05 mm max height

TRANSISTOR OUTLINE



LAND PATTERN EXAMPLE
NON-SOLDER MASK DEFINED
SCALE:20X

4221343/C 01/2018

TAPE SPECIFICATIONS

LPG0003A

TO-92 - 5.05 mm max height

TRANSISTOR OUTLINE



重要声明和免责声明

TI 均以“原样”提供技术性及其可靠性数据（包括数据表）、设计资源（包括参考设计）、应用或其他设计建议、网络工具、安全信息和其他资源，不保证其中不含任何瑕疵，且不做任何明示或暗示的担保，包括但不限于对适销性、适合某特定用途或不侵犯任何第三方知识产权的暗示担保。

所述资源可供专业开发人员应用TI 产品进行设计使用。您将对以下行为独自承担全部责任：(1) 针对您的应用选择合适的TI 产品；(2) 设计、验证并测试您的应用；(3) 确保您的应用满足相应标准以及任何其他安全、安保或其他要求。所述资源如有变更，恕不另行通知。TI 对您使用所述资源的授权仅限于开发资源所涉及TI 产品的相关应用。除此之外不得复制或展示所述资源，也不提供其它TI 或任何第三方的知识产权授权许可。如因使用所述资源而产生任何索赔、赔偿、成本、损失及债务等，TI 对此概不负责，并且您须赔偿由此对TI 及其代表造成的损害。

TI 所提供产品均受TI 的销售条款 (<http://www.ti.com.cn/zh-cn/legal/termsofsale.html>) 以及ti.com.cn上或随附TI产品提供的其他可适用条款的约束。TI提供所述资源并不扩展或以其他方式更改TI 针对TI 产品所发布的可适用的担保范围或担保免责声明。

邮寄地址：上海市浦东新区世纪大道 1568 号中建大厦 32 楼，邮政编码：200122

Copyright © 2020 德州仪器半导体技术（上海）有限公司