



ORIENT

Photo coupler

Product Data Sheet

Part Number: ORPC-817SC

Customer: _____

Date: _____

SHENZHEN ORIENT COMPONENTS CO., LTD

Block A 3rd Floor No.4 Building, Tian'an Cyber Park, Huangge Rd, LongGang Dist, Shenzhen, GD

TEL: 0755-29681816

FAX: 0755-29681200

www.orient-opto.com

1. Features

- (1) Current transfer ratio (CTR : MIN. 200% at $I_F = 5\text{mA}$, $V_{CE} = 5\text{V}$)
- (2) High input-output isolation voltage ($V_{iso} = 5,000\text{Vrms}$)
- (3) Response time (t_r : TYP. $4\mu\text{s}$ at $V_{CE} = 10\text{V}$, $I_C = 2\text{mA}$, $R_L = 100\Omega$)
- (4) In compliance with RoHS, REACH standards
- (5) ESD pass HBM 8000V/MM 2000V
- (6) MSL Class I
- (7) Safety approval
 - UL approved (No.E323844) VDE approved (No.40029733)
 - CQC approved (No.CQC09001029446)
 - CE approved (No.AC/0431008)
 - State Grid approved (No.SGCM013420170152)



2. Description

- (1) ORPC-817SC photo coupler consist of one piece of GaAs emitter and one piece of NPN transistor.
- (2) They are packaged in a 4-pin DIP package and available in wide-lead spacing and SMD option.

3. Applications

- (1) Switching power supply
- (2) Ammeter
- (3) Computer
- (4) Instrumental application, measurement machine
- (5) Imbursement equipments, duplicating machine, automat
- (6) Family-use electric equipments, such as fans
- (7) Signal transforming systems

4. Absolute Maximum Ratings at $T_a=25^\circ\text{C}$

Parameter		Symbol	Rated Value	Unit
Input	Forward Current	I_F	60	mA
	Peak forward current (100 μs pulse, 100Hz frequency)	I_{FP}	1	A
	Reverse Voltage	V_R	6	V
	Consume Power	P	70	mW
Output	Collector and emitter Voltage	V_{CEO}	80	V
	Emitter and collector Voltage	V_{ECO}	7	
	Collector Current	I_C	50	mA
	Consume Power	P_C	150	mW
Total Consume Power		P_{tot}	200	mW
*1 Insulation Voltage		V_{iso}	5,000	Vrms
Max Insulation Voltage (Insulating oil test)		V_{IOTM}	10,000	V
Rated Impulse Insulation Voltage		V_{IORM}	630	V
Working Temperature		T_{opr}	-55 to + 110	°C
Deposit Temperature		T_{stg}	-55 to + 125	
*2 Soldering Temperature		T_{sol}	260	

*1.AC For 1 Minute, R.H. = 40 ~ 60%

Isolation voltage shall be measured using the following method.

- (1) Short between anode and cathode on the primary side and between collector and emitter on the secondary side.
- (2) The isolation voltage tester with zero-cross circuit shall be used.
- (3) The waveform of applied voltage shall be a sine wave.

*2. Soldering time is 10 seconds

5. Electro-Optical Characteristics (Ta=25°C unless specified otherwise)

Parameter		Symbol	Min	Typ.*	Max	Unit	Condition
Input	Forward Voltage	V_F	1.0	---	1.3	V	$I_F=10\text{mA}$
	Reverse Current	I_R	---	---	5	μA	$V_R=5\text{V}$
	Collector capacitance	C_t	---	30	250	pF	$V=0, f=1\text{KHz}$
Output	Collector to emitter Current	I_{CEO}	---	---	50	nA	$V_{CE}=24\text{V}, I_F=0\text{mA}$
	Collector and Emitter attenuation Voltage	BV_{CEO}	80	---	---	V	$I_C=0.1\text{mA}$ $I_F=0\text{mA}$
	Emitter and Collector attenuation Voltage	BV_{ECO}	7	---	---	V	$I_E=0.1\text{mA}$ $I_F=0\text{mA}$
Transforming Characteristics	*1 Current conversion ratio	CTR	200	---	600	%	$I_F=5\text{mA}$ $V_{CE}=5\text{V}$
	Collector Current	I_C	10	---	30	mA	
	Collector and Emitter Saturation Voltage	$V_{CE(sat)}$	---	0.1	0.2	V	$I_F=20\text{mA}$ $I_C=1\text{mA}$
	Insulation Impedance	R_{iso}	1×10^{12}	---	---	Ω	DC500V 40~60%R.H.
	Floating Capacitance	C_f	---	0.6	1.0	pF	$V=0, f=1\text{MHz}$
	Cut-off Frequency	f_c	---	80	---	kHz	$V_{CE}=5\text{V},$ $I_C=2\text{mA}$ $R_L=100\Omega, -3\text{dB}$
	Rise Time	t_r	---	4	12	μs	$V_{CC}=10\text{V}$ $I_C=2\text{mA}$ $R_L=100\Omega$
	Descend Time	t_f	---	3	12	μs	

*1 Current Conversion Ratio = $I_C / I_F \times 100\%$, CTR Tolerance: $\pm 3\%$.

6. Rank Table of Current Transfer Ratio

Grade Sign	Test Condition	Min (%)	Max (%)
C	$I_F=5mA, V_{CE}=5V, T_a=25^{\circ}C$	200	400
C3	$I_F=5mA, V_{CE}=5V, T_a=25^{\circ}C$	300	450
D	$I_F=5mA, V_{CE}=5V, T_a=25^{\circ}C$	300	600
D1	$I_F=5mA, V_{CE}=5V, T_a=25^{\circ}C$	300	500
	$I_F=1mA, V_{CE}=5V, T_a=25^{\circ}C$	180	300
D2	$I_F=5mA, V_{CE}=5V, T_a=25^{\circ}C$	400	600
	$I_F=1mA, V_{CE}=5V, T_a=25^{\circ}C$	230	350

7. Order Information

Part Number

ORPC-817SC-TS-V-W-Y-Z

Note

817SC = Part Number.

T = CTR Rank (C, C3, D, D1, D2 or none)

S = SOP Lead form.

V = Tape and reel option (TP,TP1 or none).

W = Lead frame option (F: Iron, C:copper)

Y = 'V' code for VDE safety (This options is not necessary).

Z = 'G' code for Halogen free (This options is not necessary).

* VDE Code can be selected.

* Halogen Free can be selected

Option	Description	Packing quantity
None	Standard SOP-4	100 units per tube
S(TP)	Surface mount lead form (low profile) + TP1 tape & reel option	2000 units per reel
S(TP1)	Surface mount lead form (low profile) + TP tape & reel option	2000 units per reel

8.Naming Rule

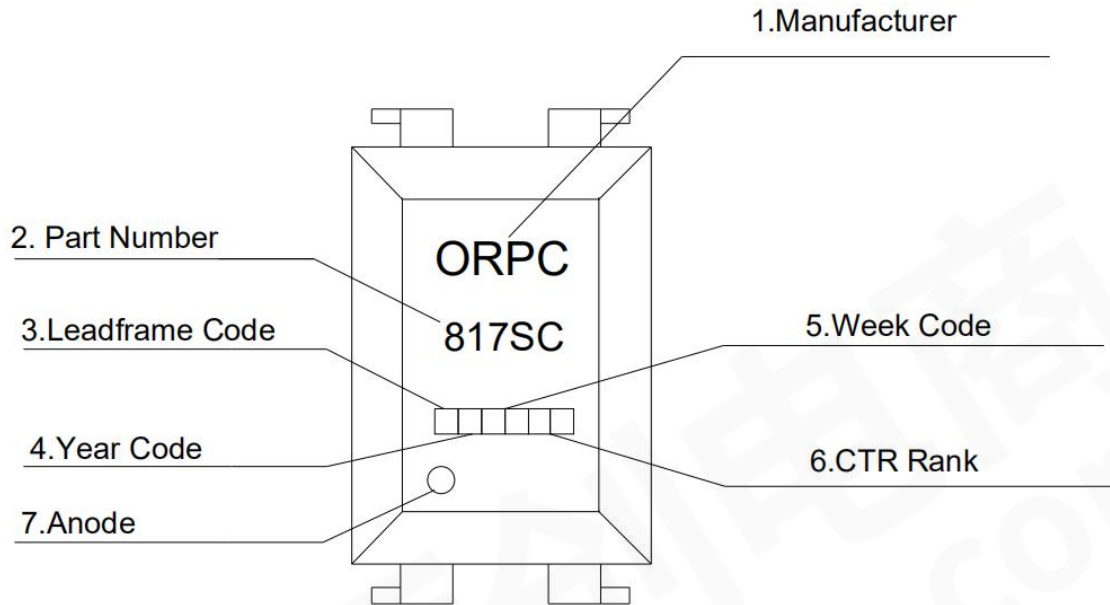

1. Manufacturer : ORIENT.
2. Part Number : 817SC.
3. Lead frame Code : 'F' means Iron, 'C' means Copper.
4. Year Code : '0' means '2020' and so on.
5. Week Code : 01 means the first week, 02 means the second week and so on.
6. Rank Code : CTR Rank
7. Anode.

* Halogen Free Mark can be selected.

* VDE Mark can be selected.

9. Package Dimension (Unit: mm)

ORPC-817SC

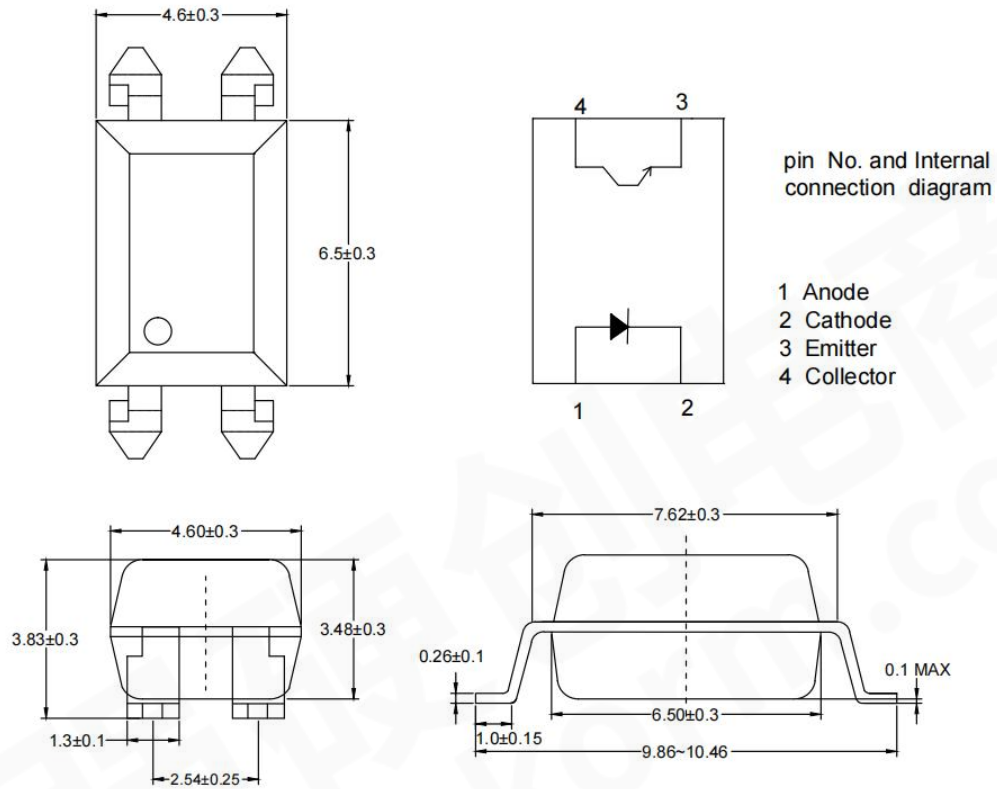

10. Recommended Foot Print Patterns (Mount Pad)(Unit: mm)

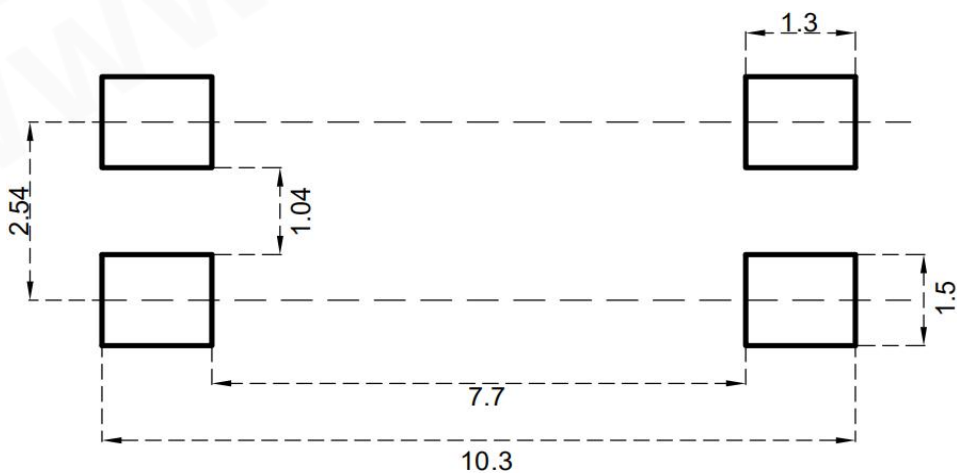

11. Taping Dimensions

(1) ORPC-817SC-TP

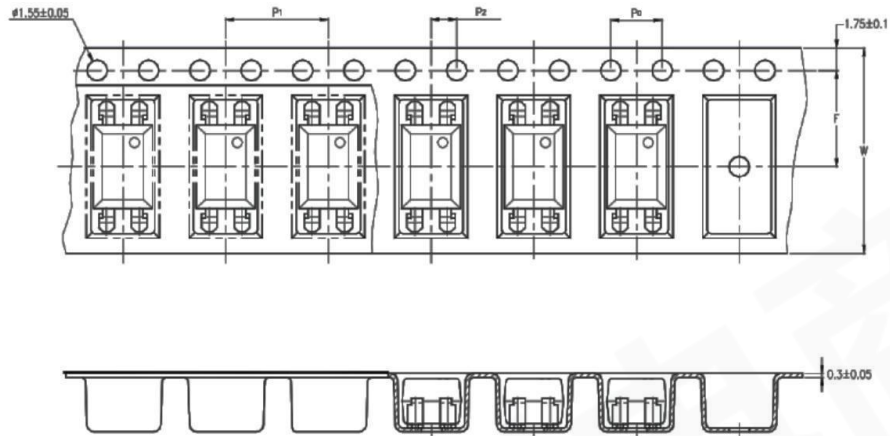

(2) ORPC-817SC-TP1

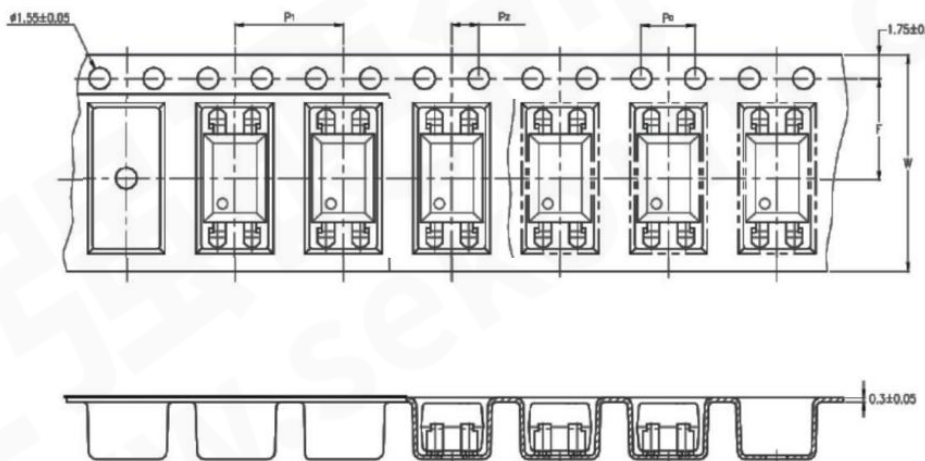

Description	Symbol	Dimension in mm (inch)
Tape wide	W	16±0.3 (.63)
Pitch of sprocket holes	P_0	4±0.1 (.15)
Distance of compartment	F	7.5±0.1 (.295)
	P_2	2±0.1 (.0079)
Distance of compartment to compartment	P_1	8±0.1 (.472)

Package Type	TP1/TP
Quantities(pcs)	2000

12. Package Dimension

(1) package dimension









DIP Type

Packing Information	
Packing type	Tube
Qty per Tube	100pcs
Small box (Inner) Dimension	525*128*60mm
Large box (Outer) Dimension	545*290*335mm
The Amount per Inner Box	5,000pcs
The Amount per Outer Box	50,000pcs

SOP Type

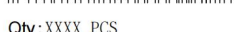
Packing Information	
Packing type	Reel type
Tape Width	16mm
Qty per Reel	2,000pcs
Small box (inner) Dimension	345*345*58.5mm
Large box (Outer) Dimension	620x360x360mm
Max qty per small box	4,000pcs
Max qty per large box	40,000pcs

(2)Packing Label Sample

 <p>Material Code : 120PCXXXXXX  P/N : OR-XXXXXX  Lot No. : XXXXXX-XXXX-TX-X  D/C : XXXX  Qty : XXXX PCS </p>	  	<div style="border: 1px solid black; width: 100px; height: 100px; display: flex; align-items: center; justify-content: center;"> 内箱码 </div> <div style="border: 1px solid black; width: 100px; height: 100px; display: flex; align-items: center; justify-content: center;"> 外箱码 </div>
<p>“XXXXXXXXXXXXXXXXXX” (一体机序列码) Made in China</p>		

Note:

1. Material Code :Product ID.
2. P/N :Contents with "Order Information" in the specification.
3. Lot No. :Product data.
4. D/C :Product weeks.
5. Quantity :Packaging quantity.

13. Reliability Test

NO.	ITEMS	Reliability Testing				
		QTY. (Pcs)	Condition	Process	Device	Standard
1	RSH 耐焊接热	22	260±5℃	10s/3 次	锡炉	JESD22-A106
2	HTSL 高温存储	77	125℃	168 hrs	高温烤箱 测试仪	JESD22-A103
				500 hrs		
				1000 hrs		
3	LTSL 低温存储	77	-55℃	168 hrs	低温箱 测试仪	JESD22-A119
				500 hrs		
				1000 hrs		
4	TC 温度循环	77	H:125℃ 15min ∫ 5min L:-55℃ 15min	300 cycle	冷热冲击机	JESD22-A104
5	TS 温度冲击	77	H:100℃ 5min ∫ 15s L:-40℃ 5min	300 cycle	冷热冲击机	JESD22-A106
6	HTOL 高温操作	77	110℃ IF=10mA Vce=5V	168 hrs	高温烤箱 测试仪、老 化电路板	JESD22-A108
				500 hrs		
				1000 hrs		
7	ESD-HBM 人体模式	22	≥8KV 1Cycle	1次	ESD静电测 试仪	JESD22-A114
8	SD 可焊性	22	Pb-free 245±5℃	5S/1次	锡炉	JESD22-B102
9	HTRB 高温反向偏压	77	HTRB @125℃ Vce=80v	168 hrs	高温烤箱 , 测试仪	JESD22-A103
				500 hrs		
				1000 hrs		
10	H3TRB 温湿度反向偏 压, 寿命试验	77	H3TRB 85℃,85%RH Vce=80v	168 hrs	恒温恒湿 机, 测试仪	JESD22-A101
				500 hrs		
				1000 hrs		
11	Autoclave 压力锅	77	Ta=121 ℃,100%RH,2atm	96hrs	压力锅	JESD22-A102

14. Temperature Profile Of Soldering

(1).IR Reflow soldering (JEDEC-STD-020C compliant)

One time soldering reflow is recommended within the condition of temperature and time profile shown below. Do not solder more than three times.

Profile item	Conditions
Preheat	
- Temperature Min (T Smin)	150°C
- Temperature Max (T Smax)	200°C
- Time (min to max) (ts)	90±30 sec
Soldering zone	
- Temperature (TL)	217°C
- Time (t L)	60 sec
Peak Temperature	260°C
Peak Temperature time	20 sec
Ramp-up rate	3°C / sec max.
Ramp-down rate from peak temperature	3~6°C / sec
Reflow times	≤3

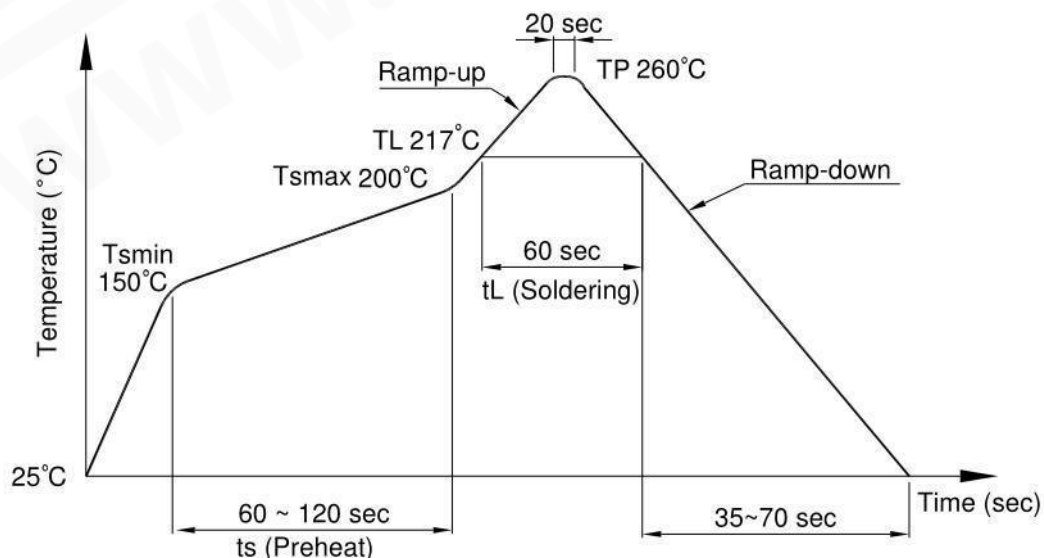

(2).Wave soldering (JEDEC22A111 compliant)

One time soldering is recommended within the condition of temperature.

Temperature	260+0/-5°C
Time	10 sec
Preheat temperature	25 to 140°C
Preheat time	30 to 80 sec

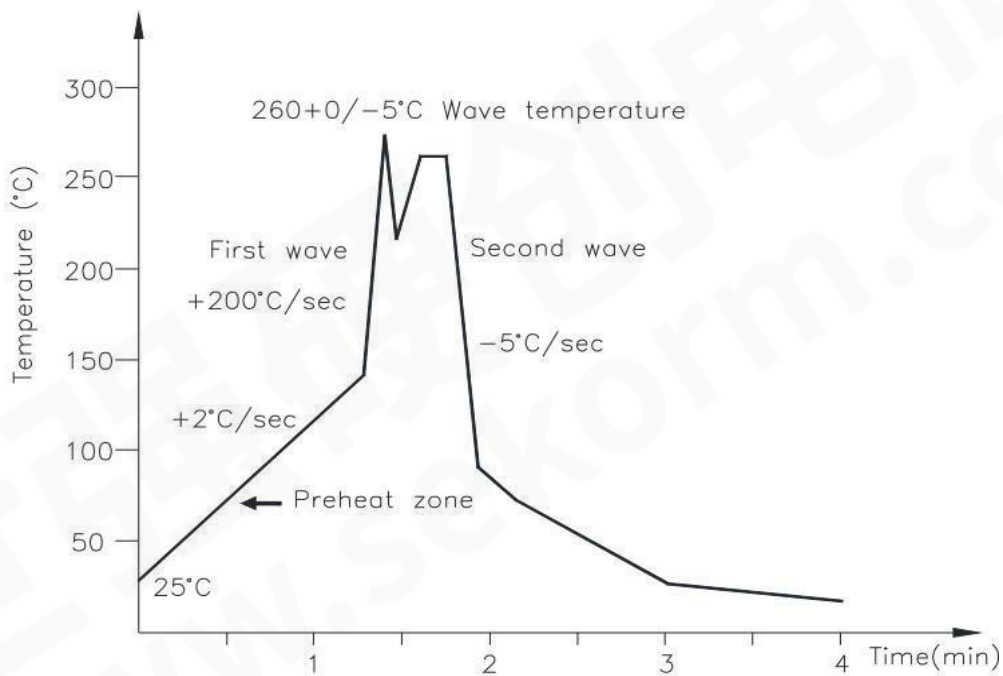

(3).Hand soldering by soldering iron

Allow single lead soldering in every single process. One time soldering is recommended.

Temperature	380+0/-5°C
Time	3 sec max

1. Characteristics Curves

Fig.1 Forward current vs Ambient temperature

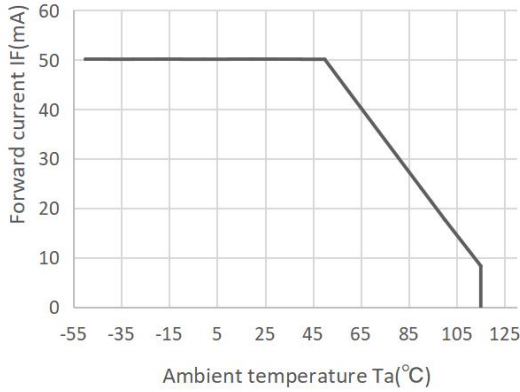

Fig.2 Collector Power Dissipation vs. Ambient temperature

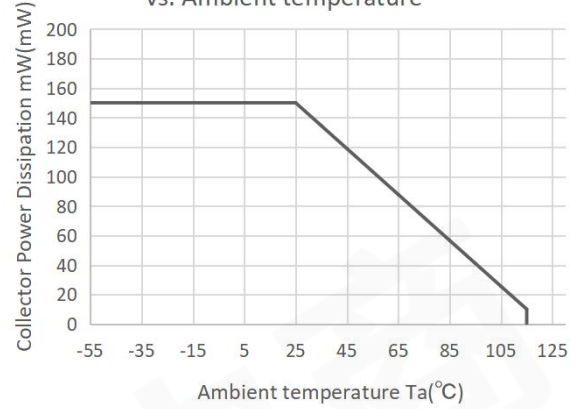

Fig.3 Collector-emitter Saturation Voltage vs. Forward Current

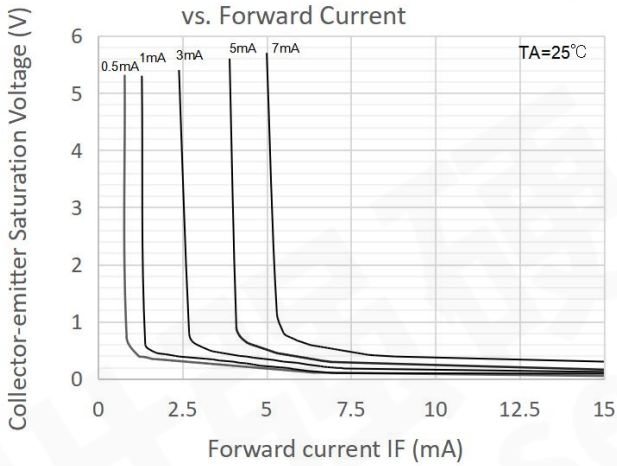

Fig.4 Forward Current vs. Forward Voltage

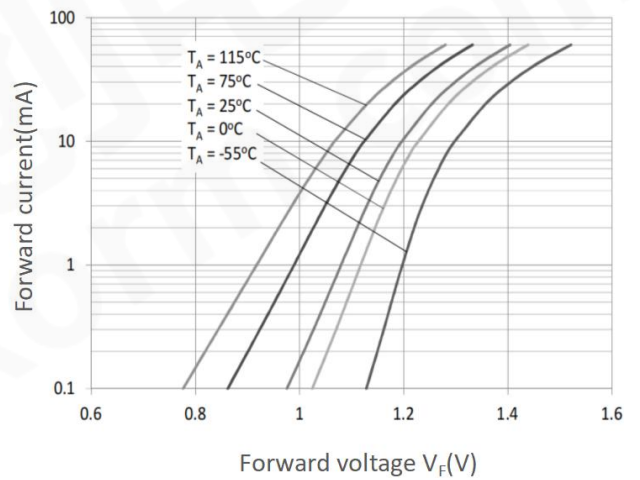

Fig.5 Forward Current vs. Current Transfer Ratio

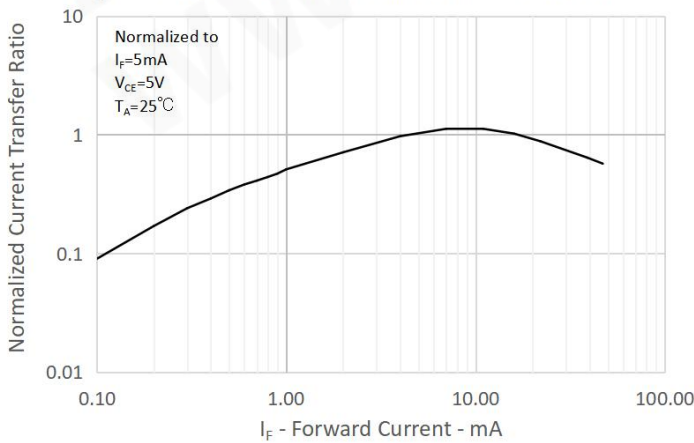

Fig.6 Collector Current vs. Collector-emitter Voltage

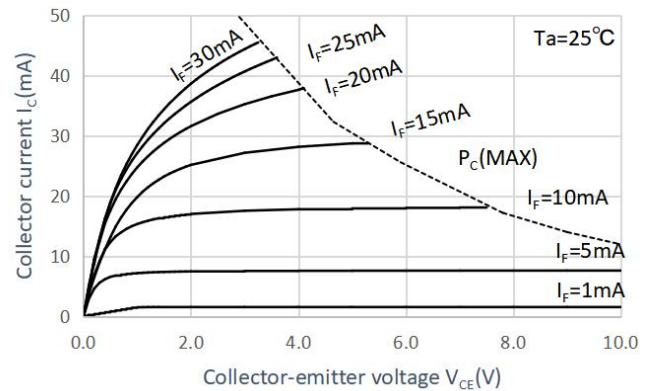

Fig.7 Relative Current Transfer Ratio vs. Ambient Temperature

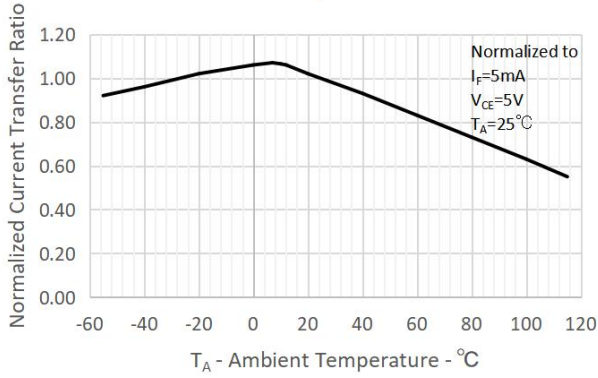

Fig.8 Collector-emitter Saturation Voltage vs. Ambient Temperature

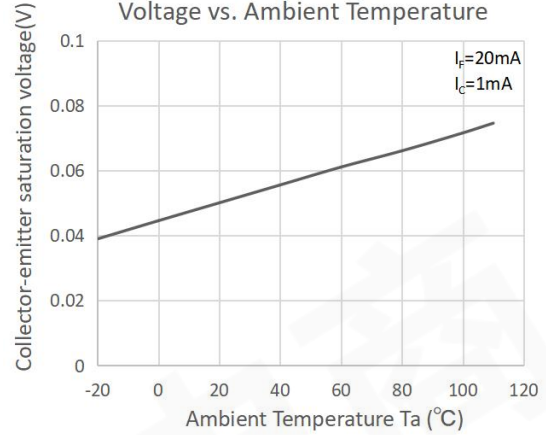

Fig.9 Collector Dark Current vs. Ambient Temperature

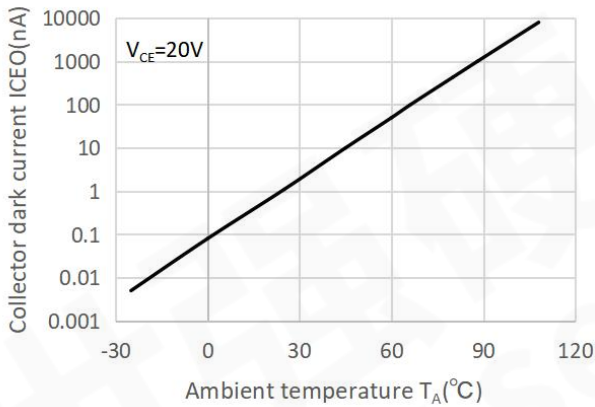

Fig.10 Response Time vs. Load Resistance

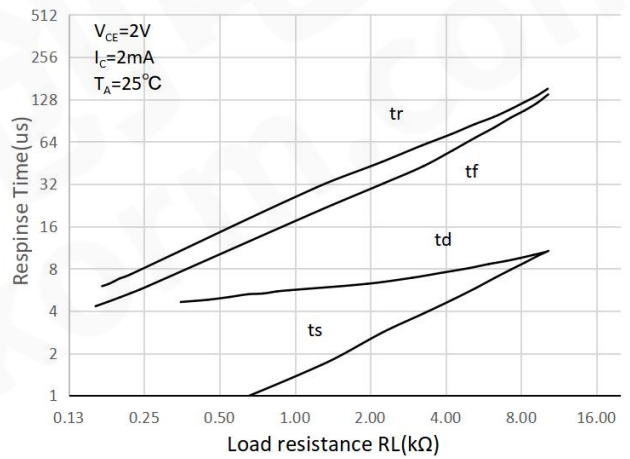
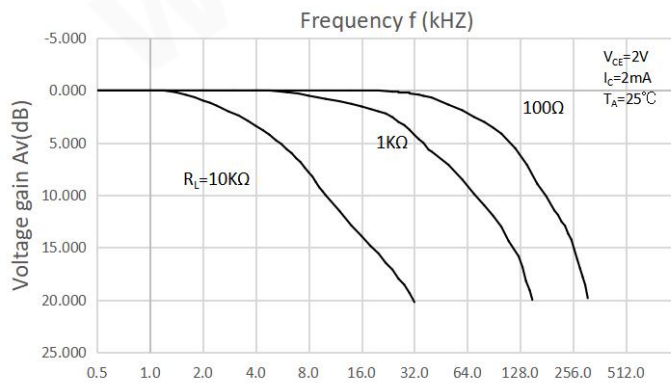
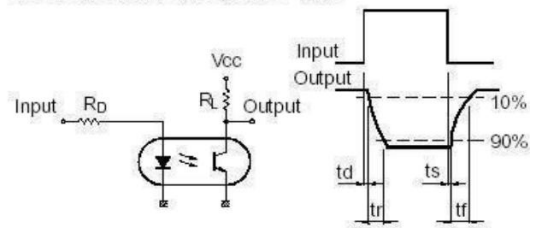

Fig.11 Frequency Response



Test Circuit for Response Time



Test Circuit for Frequency Response

