

| 序号 | 品名 | 材质 |
|----|------------------|------------------|
| ① | 1.50-K型立式WTB胶芯带扣 | PAGT UL94V-0 米白色 |
| ② | 1.50-K型立式WTB端子 | 黄铜/表面镀锡 |
| ③ | 1.50-K型立式WTB吸盖 | LCP E473i 本色/黑色 |

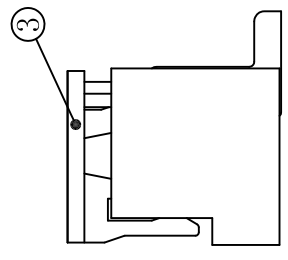

WITH COVER

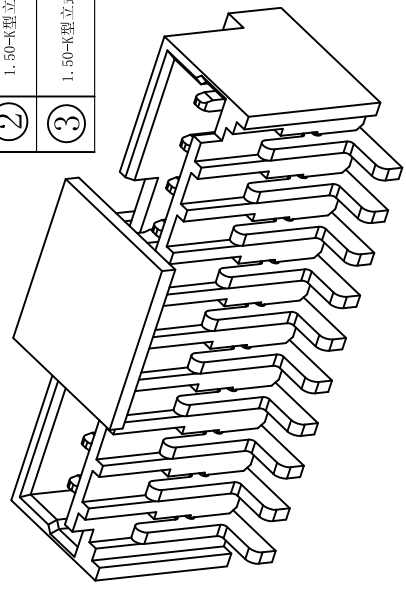
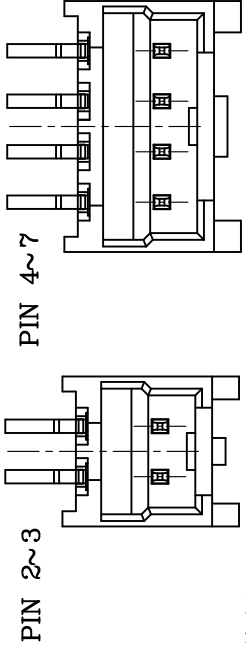
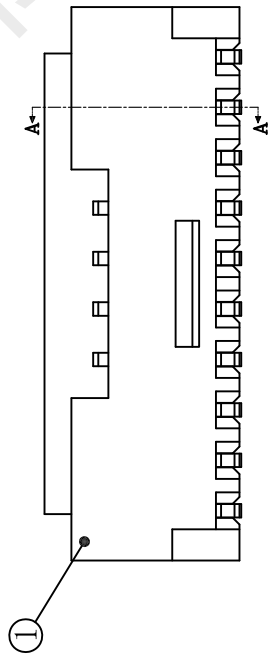
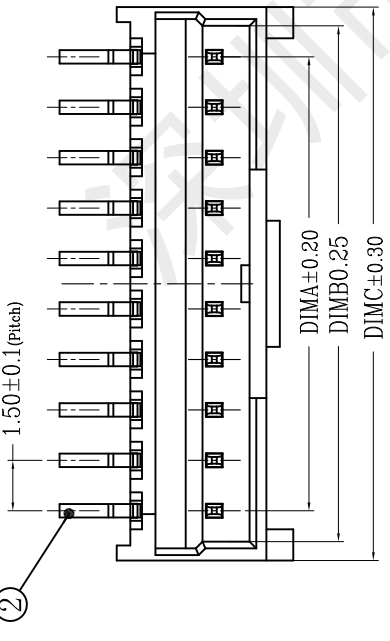
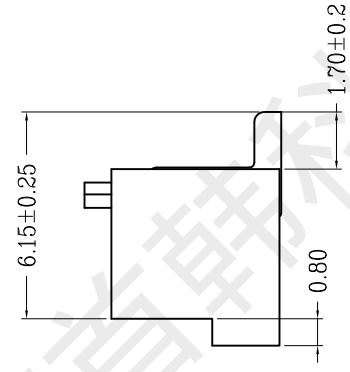

适用线路板

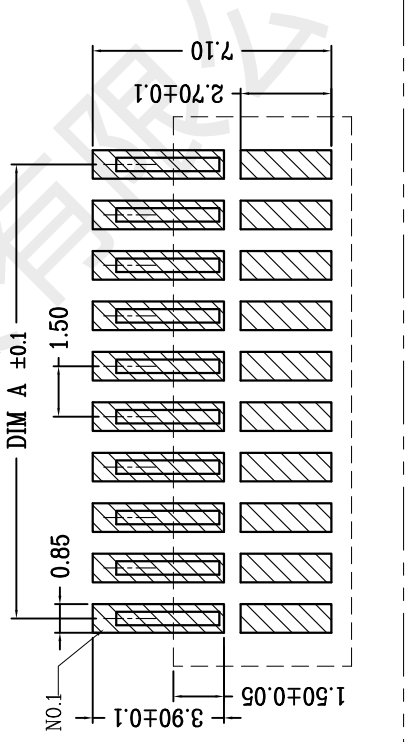

| CKT | DIM A | DIM B | DIM C |
|-----|-------|-------|-------|
| 2 | 1.50 | 3.35 | 4.46 |
| 3 | 3.00 | 4.85 | 5.96 |
| 4 | 4.50 | 6.35 | 7.46 |
| 5 | 6.00 | 7.85 | 8.96 |
| 6 | 7.50 | 9.35 | 10.46 |
| 7 | 9.00 | 10.85 | 11.96 |
| 8 | 10.50 | 12.35 | 13.46 |
| 9 | 12.00 | 13.85 | 14.96 |
| 10 | 13.50 | 15.35 | 16.46 |
| 11 | 15.00 | 16.85 | 17.96 |
| 12 | 16.50 | 18.35 | 19.46 |
| 13 | 18.00 | 19.85 | 20.96 |
| 14 | 19.50 | 21.35 | 22.46 |
| 15 | 21.00 | 22.85 | 23.96 |

技术指标:

1. 塑件表面应光洁、无毛边、无明显收缩、缺陷、裂纹等现象。
2. 温度范围: $-25^{\circ}\text{C} \sim 85^{\circ}\text{C}$ 。
3. 额定电压: 350V AC, DC。
4. 接触电阻: $\leq 0.02\Omega$ 。
5. 绝缘电阻: $\geq 1000\text{M}\Omega$ 。
6. 额定电流: 3A AC, DC。

首韩 SHOUHAN 深圳市首韩科技有限公司

制图 (DR) 李春风
审核 (CHKD) 钟华华
批准 (APPD) 罗李金

品名 (TITLE) 针座
料号 (DWG.NO) 1.5mm-4P LITDK
张数 (SHEET) 1 OF 1
比例 (SCALE) 1:1
单位 (UNITS) mm

一般公差 (TOLERANCE)
X ±0.10
Y ±0.20
Z ±0.30
ANGLES ±1°



深圳市首韩科技有限公司

SHENZHEN SHOUHAN TECHNOLOGY CO., LTD

Tel: 0755-27597601 Fax: 0755-27597491

承 认 书

SPECIFICATION FOR APPROVAL

客 户 Customer:

产品名称 Project:

针座

规格型号 Part No:

1.5mm-4P LTKD

贵公司承认印 Approval signatures

| 料 号/Part No. | 签 章/Signatures |
|--------------|----------------|
| | |

日期 Date:

| | | |
|-------------|-----|--|
| 拟制/Drawn | 李春风 |  |
| 审核/Check | 钟华华 | |
| 批准/Approved | 罗孝金 | |

1、SCOPE: (适用范围)

1.1 This specification covers production and inspection of Connector.

本规范内容适用于本公司普通系列型条形连接器（针座）产品的生产与检验。

2、USE CONDITION: (使用条件)

2.1 Ambient temperature Range:-25℃~+85℃

环境温度：-25℃~+85℃

2.2 Applicable PC board thickness:1.2~1.6mm

适用 PC 板厚度：1.2~1.6 mm

3、Appearance and Dimension: (外观及尺寸)

3.1 Appearance:Product surface without defect、dirt、crack、and mechanical damang, Contact without rust,plating not oxided and not peeled.

产品表面不应有对制品有害的缺陷、污垢、裂痕及机械损伤；接触件无锈蚀、镀层氧化、脱落等现象。

3.2 Dimension:According to drawings

外形尺寸：依照附图

3.3 Exchangable:Exchangable with same specification products.

互换性：相同规格应能互换

4、Material:

材 料 （以图纸为准）

| P/N 零件名称 | Type 类 型 | Material 材 料 | Finish 表面处理 | Expiain 说 明 |
|-------------------------------|--------------------|----------------------------------|--|--------------------|
| Terminal 端子 | Contact 插 簧 | Phosphor bronze 锡青磷铜 厚 0.15mm | Tin Plating:3~4 μ m 镀锡：3~4 μ m | RoHS Comp liant |
| Housing 孔 座 | Plastic 塑 壳 | Nylon66 UL94V-0 | Color:White 颜色：白色 | |
| OpeningWafer 开口针座 | Contact 插 针 | Phosphor bronze 锡青磷铜 厚 0.30mm | Tin Plating:3~4 μ m 镀锡：3~4 μ m | |
| | Plastic 塑 壳 | Nylon46 UL94V-0 | Color: Beige 颜色：米色 | |
| Lips Wafer 闭口针座 | Contact 插 针 | Phosphor bronze 锡青磷铜 厚 0.30mm | Gold Plating:3~4 μ " m 镀金：3~4 μ " m | |
| | Plastic 塑 壳 | PBT UL94V-0 | Color: White 颜色：白色 | |
| Tiepian Wafer 卧贴针座 立贴针座 | Contact 插 针 | Phosphor bronze 锡青磷铜 厚 0.30mm | Tin Plating:3~4 μ m 镀锡：3~4 μ m | |
| | Solder tabs 焊护耳 | Phosphor bronze 锡青磷铜 厚 0.25mm | Tin Plating:3~4 μ m 镀锡：3~4 μ m | |
| | Plastic 塑 壳 | Nylon46 UL94V-0 | Color: Beige 颜色：米色 | |

5、Electrical Performance:

电气性能

| NO. 序号 | Item 项目 | Requirement 技术要求 |
|--------|-------------------------------|--------------------------------|
| 5.1 | Voltage Rated 额定电压 | 350V AC DC |
| 5.2 | Current Rated 额定电流 | 3A AC DC |
| 5.3 | Contact Resistance 接触电阻 | $\leq 20 \text{ m}\Omega$ |
| 5.4 | Insulation Resistance 绝缘电阻 | $\geq 1000 \text{ M}\Omega$ |
| 5.5 | Dielectric Strength 耐压 | $\geq 800 \text{ V AC/minute}$ |

6、Mechanical Performance:

机械性能

| NO. 序号 | Item 项目 | Requirement 技术要求 |
|--------|--|------------------------------|
| 6.1 | Male contact Retention force PIN 针固定力 | $\geq 10 \text{ N}$ per pin |
| 6.2 | Female contact Retention force 端子固定力 | $\geq 10 \text{ N}$ per pin |
| 6.3 | Plug-in force 插入力 | $\leq 3 \text{ N}$ per pin |
| 6.4 | Plug-out force 拔出力 | $\geq 0.5 \text{ N}$ per pin |

7、Endurance Characteristics:

环境性能

| NO. 序号 | Item 项目 | Requirement 技术要求 |
|--------|--------------------------------------|---|
| 7.1 | Soldering rest 可焊性 | Time: $2.5 \pm 0.5 \text{ S}$ 时间: $2.5 \pm 0.5 \text{ S}$ Temperature: $260 \pm 5^\circ \text{C}$ 温度: $260 \pm 5^\circ \text{C}$ Area of Soldering: $\geq 95\%$ 焊锡面积: $\geq 95\%$ |
| 7.2 | Resistance to soldering Heat 耐焊接热 | Time: $5 \pm 1 \text{ S}$ 时间: $5 \pm 1 \text{ S}$ Temperature: $260 \pm 5^\circ \text{C}$ 温度: $260 \pm 5^\circ \text{C}$ Appearance: NO Damage 外观: 无损坏 |

| | | |
|-----|--|---|
| 7.3 | Heat test 耐热性 | Time:96h 时间: 96 小时 Temperature:+85±3℃ 温度: +85±3℃ Appearance:NO Damage 外观: 无损坏 Contact resistance: ≤20 mΩ 接触电阻: ≤20 mΩ |
| 7.4 | Cold test 耐冷性 | Time:48h 时间: 48 小时 Temperature:-25±3℃ 温度: -25±3℃ Appearance:NO Damage 外观: 无损坏 Contact resistance:≤20 mΩ 接触电阻: ≤20 mΩ |
| 7.5 | Temperature Cycling 温度循环 | Low temperature:-25±3℃ 低温: -25±3℃ High temperature:-85±3℃ 高温: -85±3℃ For 5 cycles.test after keeping in Normal Condition for 30 min. 5 次循环后, 放置在正常环境中 30 分钟, 在进行测试 Appearance: NO Damage 外观: 无损坏 Contact resistance: ≤20 mΩ 接触电阻: ≤20mΩ |
| 7.6 | Invariab lenes humidity 恒定湿热 | Temperature:60±2℃ 温度: 60±2℃ Relative humidity:90%-96% RH 相对湿度: 90%-96% RH Tim:96h 时间: 96 小时 Appearance:NO Damage 外观: 无损坏 Contact resistance: ≤20 mΩ 接触电阻: ≤20 mΩ Insulation Resistance: ≥100MΩ 绝缘电阻: ≥100 MΩ |
| 7.7 | Salt Spray 盐雾试验 | Salt concentration: 5±1% 浓度: 5±1% Temperature:35±2℃ 温度: 35±2℃ Tim:16±2h 时间: 16±2 小时 After salt is removed by running wafer and A drop is removed ,it is measured. 把试验样品从试验箱顶悬挂下来, 采用浓度 (5±1) %的氯化钠溶液, 连续雾化 16 小时, 试验后用流动的蒸馏水 轻轻洗去表面沉积物, 在常温常驻湿条件下恢复 1-2 小时, 外观无损伤 Appearance:NO Damage 外观: 无损坏 Contact resistance: ≤20 mΩ 接触电阻: ≤20 mΩ |