

KNSCHA[®]

全球 高端 电 容 器 制 造 商

东莞市科尼盛电子有限公司

DONGGUAN KNSCHA ELECTRONICS CO., LTD.

规格承认书

Specification for approval

客户名称:

(Customer Name)

产品名称:

(Product Name)

客户料号:

(Customer part number)

科尼盛料号:

(KNSCHA number)

型号规格:

(Specifications)

引线型固态电解电容

Aluminum solid electrolytic capacitor

118EC232

118EC232

E/C 100UF/50V 8*12mm PV

E/C 100UF/50V 8*12mm PV

制 造
(Manufacture)

Approval

拟 制
(Fiction)

审 核
(Chief)

核 准
(Approval)

刘淑芬

刘军军

徐贵南



客 户
(Customer)

Approval

检 验
(Inspect)

审 核
(Chief)

核 准
(Approval)

东莞市科尼盛电子有限公司

DONG GUAN KNSCHA ELECTRONICS CO.,LTD.

No. 8th floor, A3 building, R&D center (Phase I),

Songshan Lake Intelligent Valley, Liaobu Town, Dongguan City.

TEL:0769-83698067 81035570 FAX: 0769-83861559

Email: sales@knscha.com Website: http://www.knscha.com



一、概述 SCOPE

本产品规格书适用于KNSCHA固态铝电解电容产品。

The product specification is adapted to Polymer Aluminum Electrolytic Capacitors of KNSCHA ELECTRONICS CO., LTD

二、外形图及尺寸表 Case size table

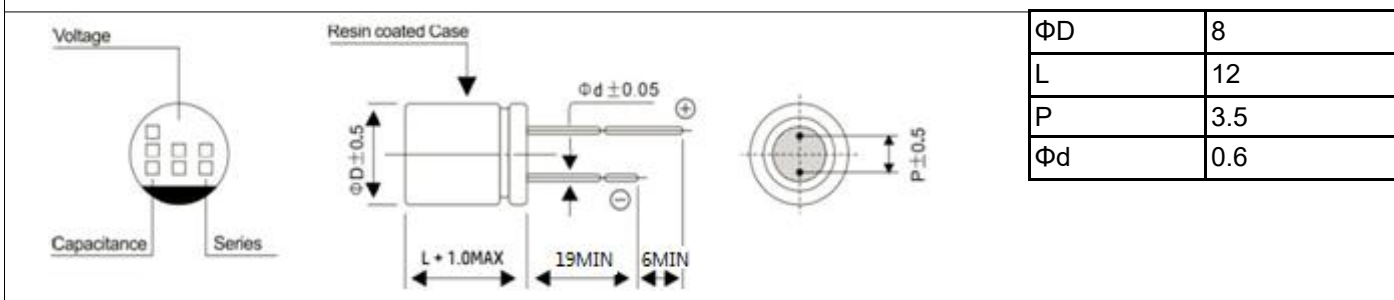

三、技术性能 Specifications

1	系列号(SERIES)	PV	
2	额定电压 (rated voltage)	50	
3	工作温度范围 Operating temperature range	工作温度范围是指电容器在额定电压下能持续工作所允许外部环境的温度范围 operating temperature range is the range of ambient temperature at which the capacitor can be operated continuously at rated voltage SPEC:-55~+105℃	
4	电容容量 capacitance	测量等效电路图	
		测量温度20℃	measuring temperature
		测量频率120HZ	measuring frequency
		测量电压 0.5Vrms	measuring voltage
		标称电容容量允许偏差:±20% MAX	Nominal Capacitance Tolerance:±20% MAX
5	损耗角正切值的测量应要和测量电容容量一样的条件下进行 Measurement should be made under the same conditions as those given for the measurement of capacitance		
	SPEC:		
	损耗正切值 (tan δ)	$U_R (V)$	50
		tanδ	0.12
6	漏电流 leakage current	将额定电压加在电容和1000± 100Ω的保护电阻上。在充电2分钟后，按下列等式计算漏电流。 the rated voltage shall be applied across the capacitor and its protective resistor which shall be 1000±100Ω.The leakage current shall be then measured after an electrifications period of (A)min. The leakage current shall be calculated by the following equation. 在加上额定电压一定时间后，应满足下列要求：1 ≤0.2CV or 200μA Which is greater (取较大者) (20℃、2分钟) SPEC: The following specifications shall be satisfied when the rated voltage is applied for the required time.	
7	等效串联阻抗 Equivalent Series Resistance (ESR)	测量等效电路图	
		测量温度20℃	measuring temperature
		测量频率100KHZ	measuring frequency
		测量电压0.5Vrms	measuring voltage
8	允许最大纹波电流 Maximum permissible ripple current	在规定的某一频率下的最大交流电流，在该电流下电容器连续工作。即使在测过耐久性后，此要求仍要满足。在此，DC电压加上最大纹波电压小于等于额定电压。 The maximum sinusoidal alternating current of a frequency specified below, at which the capacitor can be operated continuously. This requirement shall be satisfied even after the measurement electrical endurance Where(DC voltage +peak ripple voltage)≤rated voltage	

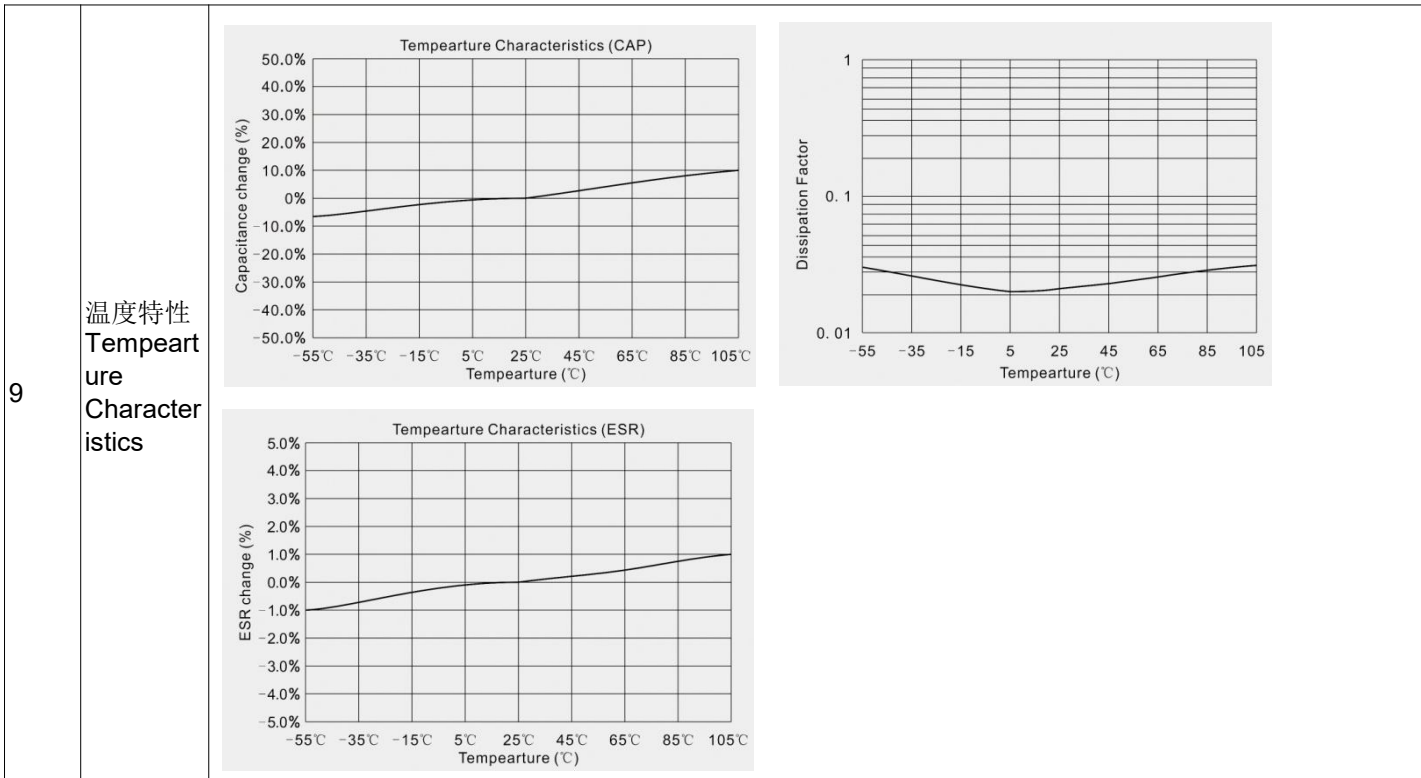

四、测试方法及要求 Tests

1 浪涌测试

在规定温度下循环测试1000次，每次充电 30 ± 5 秒，在放电大约5分30秒。在标准温度条件下存放使其稳定，然后再测试。
 The capacitor shall be subjected to 1000 cycles at a temperature specified below, each consisting of a charge period of 30 ± 5 sec, followed by a discharge period of approx. 5min30sec. And the capacitor shall be stored under standard conditions thermal to obtain stability, after which measurements shall be made. measurement circuit(测试电路图)

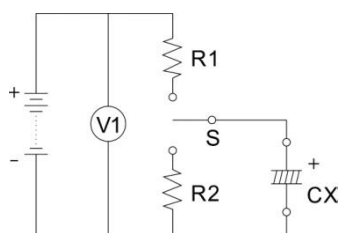

VZ: 浪涌电压 Surge voltage	V1: 直流电压 DC voltage
R1: 保护电阻 (1KΩ) Protective resistor	R2: 放电电阻 Discharge resistor
CX: 测试电容 Test capacitor	S: 开关 Switch

SPEC:	1) 电容量变化 Change in capacitance: $\pm 10\%$ 初时值以内 Within $\pm 10\%$ of the initial value
	2) 损耗正切值 tangent of the loss angle: 小于等于初时值 The initial specified value
	3) ESR (equivalent series resistance): 小于等于初时值 The initial specified value or less
	4) 漏电流 leakage current: 小于等于初时值 The initial specified value or less
电压设定:	RATED VOLTAGE (V_{DC}) 50V
	SURGE VOLTAGE (V_{DC}) 57.5V

2 端子强度	1) 拉力(tensile)	d(mm)	[N]	Duration time
		0.6	10	10 \pm 2sec(秒)
	2) 抗弯强度 (Bending)			
	端子应该在每一个方向上折弯一次，总共两次 The terminal shall be subjected to 1 bend in each direction to give a total 2 bends.			
	d(mm)	[N]		
	0.6	5.0 (0.51KG)		
	端子没有破损或松动 SPEC: No breaking and loosening of terminal			

3	可焊性 Solderability	焊料(Solder) : H60A. H60S or(或)H63A
		焊接温度(Solder temperature) : 245±2℃
		浸入时间(Immersion time) : 3±0.5sec(秒)
		浸入深度(Immersion depth) : 离本体 1.5~2mm
		熔化: 松香在酒精的浓度是25% Flux: 25% by weight of rosin in ethanol
		从含浸处到顶部, 至少有3/4部分覆盖有新焊料
		SPEC:1)3/4 of the circumference of the surface up to the immersed shall be covered with
		new solder.
4	耐焊接热 Resistance to soldering heat	焊料: (Solder) : H60A.H60S or (或) H63A
		焊接温度(Solder temperature) : 350±10℃ (or350±10℃)
		浸入时间(Immersion time) : 10±1sec(秒) (or 或 3.5±0.5sec)
		绝热遮罩板的厚度 (Thickness of heat shunt:1.6mm) : 1.6mm
		SPEC: 1)电容量变化Change in capacitance: ±10%初时值以内Within±10%of the initial value
		2)损耗正切角tangent of the loss angle:小于等于初始规定值The initial specified value or less
		3)ESR (equivalent series resistance) : 小于等于初时值The initial specified value or less
4)漏电流leakage current: 小于等于初时值The initial specified value or less		
5	表示耐溶剂性	标示应清晰可见 试剂: 乙丙醇, 浸入时间30±0.5sec
6	高温高湿 Dampheat, steady state	电容器在温度60±2℃, 相对湿度90%到95%条件下存放240±8个小时, 然后在标准条件下放1到2小时后进行测量。the capacitor shall be stored at a temperature of 60±2℃ and relative humidity of 90 to 95% for 240±8hours. And then the capacitor shall be subjected to standard atmospheric conditions for 1 to 2hours, after which measurements shall be made.
		SPEC: 1)电容量变化Change in capacitance: ±20%初时值以内Within±20%of the initial value
		2)损耗正切角tangent of the loss angle:150%初始值规定以内within ±150%of the initial value
		3)ESR (equivalent series resistance) : 150%初始值规定以内within ±150%of the initial value
		4)漏电流leakage current: 小于等于初时值The initial specified value or less
7	高温储存 Shelf life	在+105温度下不外加电压储存, 电容器存放1000小时。然后在标准条件下放1到2小时进行测量, 并且在测漏电流前, 必须满足以上条件。The capacitor shall be stored at +105℃ temperature specified below for 1000 hours. During which time no voltage shall be applied. And then the capacitor shall be subjected to standard atmospheric conditions for 1 to2hours, after which measurements shall be made, Prior to the measurement of leakage current, following conditioning may be made.
		SPEC: 1):电容量变化Change in capacitance: ±20%初时值以内Within±20%of the initial value
		2)损耗正切角tangent of the loss angle:不大於規範值的150% 150% or less of initial specified value
		3)ESR (equivalent series resistance) : 不大於規範值的150% 150% or less of initial specified value
		4)漏电流leakage current: 小于等于初时值The initial specified value or less

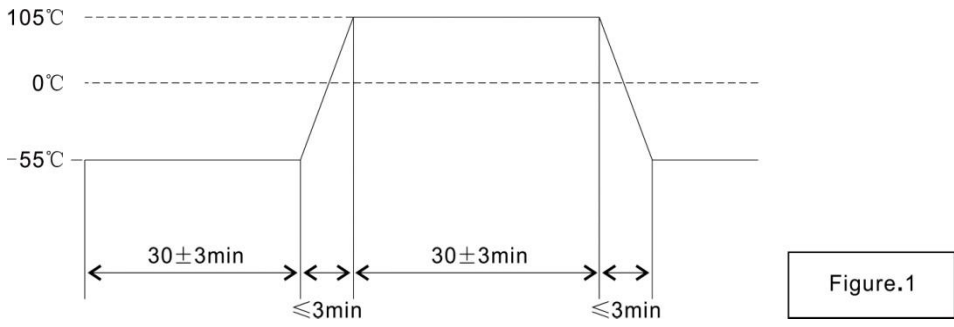
8	耐久性 load life	<p>在+105℃下，电容器施加带纹波电流的额定电压3000小时。在标准条件下放1到2小时后进行测量。The rated voltage with specified ripple current shall be applied continuously to the capacitor at maximum operating temperature +105℃ for 3000 hours. And then the capacitor shall be subjected to standard atmospheric conditions for 1to 2hours, after which measurement shall be made.</p> <p>SPEC: 1) 电容量变化Change in capacitance: ±20%初时值以内Within±20%of the initial value 2) 损耗正切角tangent of the loss angle: 150%初始值规定以内within ± 150%of the initial value 3) ESR (equivalent series resistance) : 150%初始值规定以内within ± 150%of the initial value 4) 漏电流leakage current: 小于等于初时值The initial specified value or less.</p>
9	温度循环测试 Rapid temperature change	<p>电容器要在图1的温度循环要求下保持5个循环，然后在标准条件下放1-2个小时后进行测量。The characteristics of a capacitor kept under the temperature cycle indicated in Figure1 for 5 cycles . And then the capacitor shall be subjected to standard atmospheric conditions for 1to 2hours, after which measurement shall be made</p>  <p>SPEC: 1) 电容量变化Change in capacitance: ±10%初时值以内Within±10%of the initial value 2) 损耗正切角tangent of the loss angle: 小于等于初时值The initial specified value or less 3) ESR (equivalent series resistance) : 小于等于初时值The initial specified value or less 4) 漏电流leakage current: 小于等于初时值The initial specified value or less.</p>
10	低温测试 Low temperature test	<p>电容器要在温度-55℃条件下存放72±2个小时。然后在标准条件下放1到2个小时进行测试。the shall be stored at a temperature of -55℃ for 72±2hours. And then the capacitor shall be subjected to standard atmospheric conditions for 1 to 2hours, after which measurements shall be made</p> <p>SPEC: 1) 电容量变化Change in capacitance: ±10%初时值以内Within±10%of the initial value 2) 损耗正切角tangent of the loss angle: 小于等于初时值The initial specified value or less 3) ESR (equivalent series resistance) : 小于等于初时值The initial specified value or less 4) 漏电流leakage current: 小于等于初时值The initial specified value or less.</p>
11	充放电测试 Charging and discharging test	<p>在25±5℃的环境下，施加额定工作电压、1000Ω电阻，充电1S，放电1S，循环500000次。The capacitor shall be subjected to 500000 cycles application of rated voltage、1000 Ω resistance at maximum operating temperature 25±5℃. each consisting of a charge period of 1sec, followed by a discharge period of approx. 1sec</p> <p>SPEC: 1) 电容量变化Change in capacitance: ±10%初时值以内Within±10%of the initial value 2) 损耗正切角tangent of the loss angle: 不大於規範值的150% 150% or less of initial specified value 3) ESR (equivalent series resistance) : 不大於規範值的150% 150% or less of initial specified value 4) 漏电流leakage current: 小于等于初时值The initial specified value or less.</p>

五：结构图

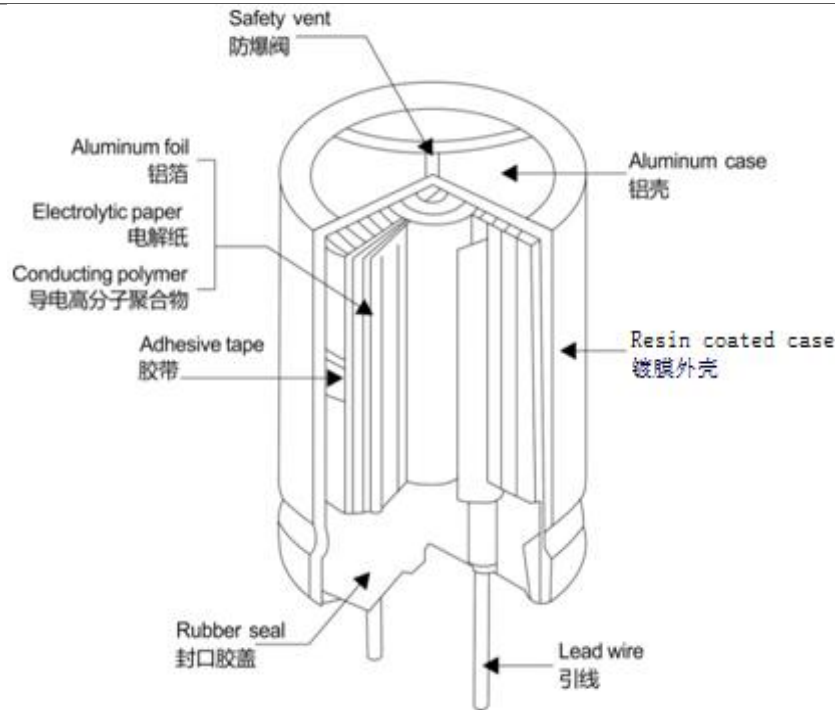

六：标志 Marking

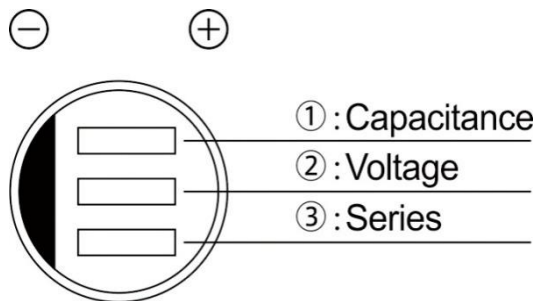

1,	代表容量 Rate Capacitance
2,	代表电压 Rate Voltage
3,	代表系列号 Series

七：包装 Packing

包装标签标示 Packing Label Marked

(下面项目应该体现在标签上 The following items shall be marked on the label)

(外箱 outer carton)

系列、额定容值、额定电压	Series、Rate Capacitance、Rate Voltage
尺寸	Size
数量	Quantity
物料编码	P/N
批号	LOT Number

■ In-box&outer carton 内盒和外箱

Small Box Size 内箱尺寸			Carton Box Size 外箱尺寸		
L(mm)	H(mm)	W(mm)	L(mm)	H(mm)	W(mm)
310	140	200	420	220	295

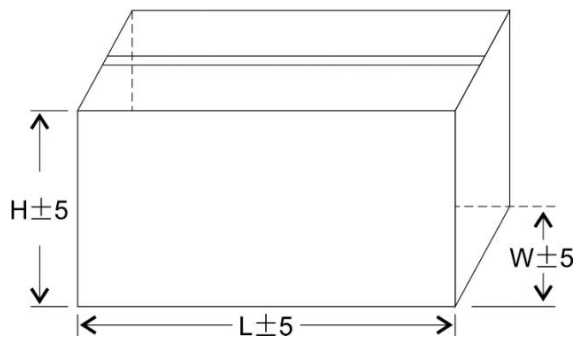

◆Minimum package quantity.

◆最小包装数量。

P.N	Bag (pcs)	In-box (pcs)	Carton (pcs)
	500	4000	16000

	<p>为了使你获得电解电容的最佳性能和延长电解电容的使用寿命，在使用电解电容前，请务必阅读本注意事项。</p> <p>Upon using Aluminum Electrolytic Capacitors, please proper handing and observing to following important points will insure optimum capacitor performance and long life.</p>
1	<p>直流电解电容是有极性的。 DC electrolytic capacitors are polarized.</p> <p>确定极性，极性标志在电容器的基体上。以免因极性反可能引起电路短路或电容器损坏，当极性不固定或不确定的，使用无极性电容器。注意直流电容器不能使用于交流。 Make sure of the polarity. The polarity is marked to on the body of the capacitor .Application of the reversed voltage cause a short circuit or damage the capacitor. Use bipolar capacitors when the polarity is not determined or unknown. Note that DC electrolytic capacitors can not be used for AC application.</p>
2	<p>使用电压不要大于额定电压。 Do not apply voltage Higher than rated voltage.</p> <p>使用电压大于额定电压，漏电流会增大，可能损坏电容器。建议工作电压为额定电压的70%-80%，电容器在建议工作电压下使用可以延长电容器的寿命。 If a voltage exceeding the rated voltage is applied, the leakage current will increase, which damage the capacitor. Recommended working voltage is 70 to 80 percent of tatted voltage. Using capacitors at recommended working voltage prolongs capacitor life.</p>
3	<p>不要使用过量纹波电流通过电容器。 Do not allow excessive ripple current through the capacitor.</p> <p>流过电容器的纹波电流超过许可值，将会引起电容器发热，电容量减少，损耗电容器。通过电容器的纹波电流不要大于允许值。 The flow of ripple current over permissible ripple current will cause heat of the capacitor, which may decrease the capacitance and damage the capacitor. Ripple current on the capacitor must be at or bellow allowable level.</p>
4	<p>快速充放电电路中，使用专门设计的电容器。 Use specially designed capacitors for the circuits where charge and discharge are frequency repeated.</p> <p>在经受快速的周期性充放电电路中，电容器可能收到损害，它的寿命因容量下降、温升等原因而缩短，在这种电路中，一定要使用专门设计的电容器。 In the circuit subjected to rapid charge cycles, capacitors may be damaged, its life may be shortened by capacitance decrease, heat rise, ect. Be sure and use special capacitors in these applications.</p>
5	<p>工作温度范围。 Operating temperature range.</p> <p>电容器的特性随工作温度变化而变化，在温度较高的情况下，容量，漏电流增大，损耗减少；在低温情况下，容量和漏电流下降，损耗增大。电容器在较低温度下使用会确保延长寿命。 The characteristics of capacitors change with the operating temperature. The capacitance and leakage current increase and $\text{tg}\delta$ decrease at higher temperatures. The capacitance and leakage current decrease and $\text{tg}\delta$ at increase lower temperature. Usage at lower temperature will ensure longer life.</p>
6	<p>核对工作频率。 Check operating frequency.</p> <p>电解电容器的容量通常是在100HZ或者120HZ下测得的。然而要记住容量随频率的升高而下降， $\tan \delta$ 随频率的升高而增大，并使周围温度升高。 The capacitance of electrolytic capacitors is usually measured at 100Hz or 120Hz. However, remember that capacitance decrease and $\text{tg}\delta$ increase as the applied frequency becomes higher whereas the ambient temperature becomes higher.</p>
7	<p>长时间存放的电容器，在使用前加额定直流电压处理。</p> <p>Apply rated DC voltage treatment to the capacitors which have been stored for a long time.</p> <p>长时间的存放，实际对电容器的容量和 $\tan \delta$ 没有多大的影响，然而往往会使漏电流增大，耐压降低。长时间存放后的电容器处理，首先逐渐施加直流电压至额定电压，然后再使用。 Long periods of storage have virtually no effect on a capacitor's capacitance and $\text{tg}\delta$. Such periods tend however, to increase leakage current and decrease withstand voltage. After removing capacitors from long-duration storage, first apply a gradually increasing DC voltage to rated voltage and then use them.</p>
8	<p>固态电容器的外壳为镀膜外壳，与极性是绝缘的。 The Case of Conductive Polymer Aluminum Solid Electrolytic Capacitor is Resin coated case which is insulated with the terminals.</p>

9	The capacitor's case and cathode terminal connect through the electrolyte. If the case is to be completely insulated, that insulation must be at the capacitor's mounting point.
10	电容器的端子或者引线上不要施加过大的力。
	Do not apply excessive force to the terminals and leads.
	过大的力施加到端子和引线上，可能引起引线的断裂或端子分裂，转而会引起内部链接的破坏
	The excessive strong force applied to the terminals and lead wires may cause leads to break or terminals to separate and, in turn, cause the internal contact to fail.

有害物质目录表

Hazardous substances management table of contents

区分 Type	物质名称 (中文名) Name (chinese)	物质名称 (英文名) Name (English)	有害物质包含与否 (Test result)	
			有 Yes	无 No
Level A- I	铅以及它的化合物	Lead and its compounds		NO
	镉以及它的化合物	Cadmium and its compounds		NO
	水银以及它的化合物	Mercury and its compounds		NO
	六价铬以及它的化合物	Hexavalent chromium and its compounds		NO
	多溴化的联苯	Polybrominated biphenyls		NO
	聚溴二苯醚	Polybrominated diphenylethers		NO
Level A- II	多氯化联苯 (PCB)	Polybrominated biphenyls (PCB)		NO
	多氯化萘 (PCN)	Polybrominated naphthalenes(PCN)		NO
	三磷酸盐	Polybrominated terphenyls(PCT)		NO
	氯化涂石蜡 (SCCP)	Short-chain chlorinated paraffins(SCCP)		NO
	石棉以及它的化合物	Asbestos and its compounds		NO
	臭氧层破坏物质	Ozone Depleting Substances		NO
	偶氮化合物	Azo compounds		NO
	镍以及它的化合物	Specific organic tin compounds		NO
	有机锡类化合物	Nickel and its compounds		NO
	砷以及它的化合物	Specific organic tin compounds		NO
	甲醛	Formaldehydes		NO
	Level B	氯化乙烯树脂	Polyvinyl chloride,(PET)	
磷苯二甲酸盐		Phthalates		NO
铍以及他的化合物		Beryllium and its compounds		NO
锑及其它的化合物		Antimony and its compounds		NO
硒及其它的化合物		Selenium and its compounds		NO
钯及其它的化合物		Palladium and its compounds		NO
铋及其化合物		Bismuth and its compounds		NO
其他氯类难燃试剂		Other chlorinated flame retardants		NO
其他溴类难燃试剂		Other brominated flame retardants		NO
Note:				
	1, 原则上按照公司的管理规定, 但由管理总部提出根据Buyer等交易商的要求制定的另行有害物质管理目录来执行的要求时, 应优先按照管理总部的管理目录来记载。			
	2, 确认合作企业现在是否在使用这类物质, 应记录使用与否。			